



FCC TEST REPORT

REPORT NO.: RF970828A02-2

MODEL NO.: MOC-315BD, RG-0836

RECEIVED: Aug. 28, 2008

TESTED: Aug. 29 ~ Sep. 1, 2008

ISSUED: Oct. 27, 2008

APPLICANT: Chicony Electronics Co., Ltd.

ADDRESS: No. 25, Wu-Gong 6th Rd., Wu Ku Industrial Park,
Taipei Hsien, Taiwan, R.O.C.

ISSUED BY: Advance Data Technology Corporation

LAB LOCATION: No. 47, 14th Ling, Chia Pau Tsuen, Lin Kou Hsiang
244, Taipei Hsien, Taiwan, R.O.C.

This test report consists of 27 pages in total. It may be duplicated completely for legal use with the approval of the applicant. It should not be reproduced except in full, without the written approval of our laboratory. The client should not use it to claim product endorsement by TAF or any government agencies. The test results in the report only apply to the tested sample.





Table of Contents

1.	CERTIFICATION.....	3
2.	SUMMARY OF TEST RESULTS.....	4
2.1	MEASUREMENT UNCERTAINTY	4
3.	GENERAL INFORMATION	5
3.1	GENERAL DESCRIPTION OF EUT.....	5
3.2	DESCRIPTION OF TEST MODES.....	6
3.2.1	CONFIGURATION OF SYSTEM UNDER TEST	6
3.2.2	TEST MODE APPLICABILITY AND TESTED CHANNEL DETAIL:.....	7
3.3	GENERAL DESCRIPTION OF APPLIED STANDARDS	8
3.4	DESCRIPTION OF SUPPORT UNITS.....	8
4.	TEST TYPES AND RESULTS.....	9
4.1	CONDUCTED EMISSION MEASUREMENT	9
4.1.1	LIMITS OF CONDUCTED EMISSION MEASUREMENT.....	9
4.1.2	TEST INSTRUMENTS	9
4.1.3	TEST PROCEDURES.....	10
4.1.4	DEVIATION FROM TEST STANDARD	10
4.1.5	TEST SETUP	10
4.1.6	EUT OPERATING CONDITIONS.....	11
4.1.7	TEST RESULTS.....	12
4.2	RADIATED EMISSION MEASUREMENT	14
4.2.1	LIMITS OF RADIATED EMISSION MEASUREMENT.....	14
4.2.2	TEST INSTRUMENTS	15
4.2.3	TEST PROCEDURES.....	16
4.2.4	DEVIATION FROM TEST STANDARD	16
4.2.5	TEST SETUP	17
4.2.6	EUT OPERATING CONDITIONS.....	17
4.2.7	TEST RESULTS.....	18
4.3	BAND EDGES MEASUREMENT	22
4.3.1	LIMITS OF BAND EDGES MEASUREMENT	22
4.3.2	TEST INSTRUMENTS	22
4.3.3	TEST PROCEDURE	22
4.3.4	DEVIATION FROM TEST STANDARD	22
4.3.5	EUT OPERATING CONDITION	22
4.3.6	TEST RESULTS.....	22
5.	PHOTOGRAPHS OF THE TEST CONFIGURATION.....	25
6.	INFORMATION ON THE TESTING LABORATORIES	26
7.	APPENDIX A – MODIFICATIONS RECORDERS FOR ENGINEERING CHANGES TO THE EUT BY THE LAB	27

2. SUMMARY OF TEST RESULTS

The EUT has been tested according to the following specifications:

APPLIED STANDARD: FCC Part 15, Subpart C (Section 15.249)			
STANDARD SECTION	TEST TYPE AND LIMIT	RESULT	REMARK
15.207	Conducted Emission Test	PASS	Minimum passing margin is -12.57dB at 0.181MHz
15.209 15.249 15.249 (d)	Radiated Emission Test Band Edge Measurement Limit: 50dB less than the peak value of fundamental frequency or meet radiated emission limit in section 12.209	PASS	Minimum passing margin is -7.82dB at 2483.500MHz

2.1 MEASUREMENT UNCERTAINTY

Where relevant, the following measurement uncertainty levels have been estimated for tests performed on the EUT as specified in CISPR 16-4-2:

This uncertainty represents an expanded uncertainty expressed at approximately the 95% confidence level using a coverage factor of k=2.

Measurement	Frequency	Uncertainty
Conducted emissions	9kHz ~ 30MHz	2.44 dB
Radiated emissions	30MHz ~ 1GHz	3.75 dB
	1GHz ~ 40GHz	2.89 dB

3. GENERAL INFORMATION

3.1 GENERAL DESCRIPTION OF EUT

EUT	Dongle
MODEL NO.	MOC-315BD, RG-0836
FCC ID	E8HDCMOC305B
POWER SUPPLY	5Vdc from host equipment
MODULATION TYPE	GFSK
OPERATING FREQUENCY	2402MHz ~ 2479MHz
NUMBER OF CHANNEL	78
ANTENNA TYPE	Strip antenna with -3.17dBi gain
DATA CABLE	N/A
I/O PORTS	N/A
ASSOCIATED DEVICES	N/A

NOTE:

1. The EUT is a Dongle, which is a transceiver.
2. The EUT has following models, which are identical to each other except for their brand name only for marketing differentiation as follows:

Brand Name	Model No.	Description
Samsung	MOC-315BD	marketing differentiation
Chicony	RG-0836	

For the test, model: **MOC-315BD** was selected as the representative model and its data was recorded in this report.

3. The above EUT information was declared by the manufacturer and for more detailed features description, please refer to the manufacturer's specifications or User's Manual.

3.2 DESCRIPTION OF TEST MODES

78 channels are provided to this EUT:

CHANNEL	FREQ. (MHZ)	CHANNEL	FREQ. (MHZ)	CHANNEL	FREQ. (MHZ)	CHANNEL	FREQ. (MHZ)
0	2402	20	2422	40	2442	60	2462
1	2403	21	2423	41	2443	61	2463
2	2404	22	2424	42	2444	62	2464
3	2405	23	2425	43	2445	63	2465
4	2406	24	2426	44	2446	64	2466
5	2407	25	2427	45	2447	65	2467
6	2408	26	2428	46	2448	66	2468
7	2409	27	2429	47	2449	67	2469
8	2410	28	2430	48	2450	68	2470
9	2411	29	2431	49	2451	69	2471
10	2412	30	2432	50	2452	70	2472
11	2413	31	2433	51	2453	71	2473
12	2414	32	2434	52	2454	72	2474
13	2415	33	2435	53	2455	73	2475
14	2416	34	2436	54	2456	74	2476
15	2417	35	2437	55	2457	75	2477
16	2418	36	2438	56	2458	76	2478
17	2419	37	2439	57	2459	77	2479
18	2420	38	2440	58	2460		
19	2421	39	2441	59	2461		

3.2.1 CONFIGURATION OF SYSTEM UNDER TEST

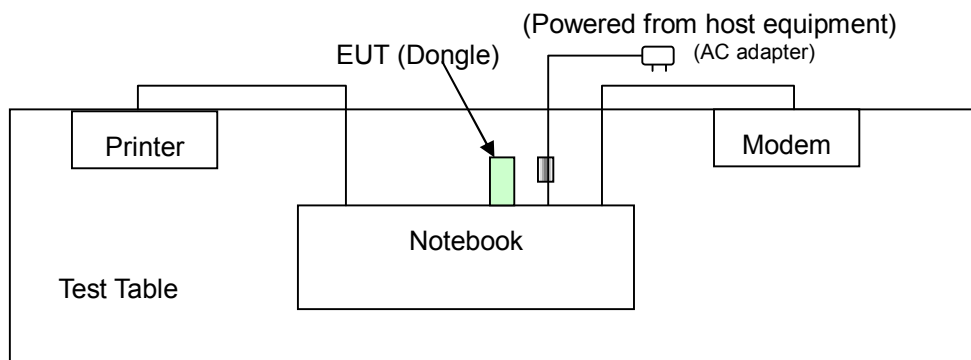

3.2.2 TEST MODE APPLICABILITY AND TESTED CHANNEL DETAIL:

EUT configure mode	Applicable to				Description
	PLC	RE<1G	RE [≥] 1G	BM	
-	√	√	√	√	-

Where PLC: Power Line Conducted Emission RE<1G RE: Radiated Emission below 1GHz
 RE≥1G: Radiated Emission above 1GHz BM: Bandedge Measurement

POWER LINE CONDUCTED EMISSION TEST:

- Following channel(s) was (were) selected for the final test as listed below.

AVAILABLE CHANNEL	TESTED CHANNEL	MODULATION TYPE
0 to 77	77	GFSK

RADIATED EMISSION TEST (BELOW 1 GHz):

- Pre-Scan has been conducted to determine the worst-case mode from all possible combinations between available modulations and antenna ports (if EUT with antenna diversity architecture).
 Following channel(s) was (were) selected for the final test as listed below.

AVAILABLE CHANNEL	TESTED CHANNEL	MODULATION TYPE
0 to 77	77	GFSK

RADIATED EMISSION TEST (ABOVE 1 GHz):

- Pre-Scan has been conducted to determine the worst-case mode from all possible combinations between available modulations and antenna ports (if EUT with antenna diversity architecture).
 Following channel(s) was (were) selected for the final test as listed below.

AVAILABLE CHANNEL	TESTED CHANNEL	MODULATION TYPE
0 to 77	0, 38, 77	GFSK

BANDEDGE MEASUREMENT:

- Pre-Scan has been conducted to determine the worst-case mode from all possible combinations between available modulations and antenna ports (if EUT with antenna diversity architecture).
 Following channel(s) was (were) selected for the final test as listed below.

AVAILABLE CHANNEL	TESTED CHANNEL	MODULATION TYPE
0 to 77	0, 77	GFSK



3.3 GENERAL DESCRIPTION OF APPLIED STANDARDS

The EUT is a RF product. According to the specifications of the manufacturer, it must comply with the requirements of the following standards:

FCC Part 15, Subpart C. (15.249)

ANSI C63.4-2003

All test items have been performed and recorded as per the above standards.

NOTE: The product has been verified to comply with the requirements of FCC Part 15, Subpart B, Class B (DoC). The test report has been issued separately.

3.4 DESCRIPTION OF SUPPORT UNITS

The EUT has been tested as an independent unit together with other necessary accessories or support units. The following support units or accessories were used to form a representative test configuration during the tests.

NO.	PRODUCT	BRAND	MODEL NO.	SERIAL NO.	FCC ID
1	NOTEBOOK COMPUTER	DELL	PP05L	20375526736	FCC DoC Approved
2	PRINTER	EPSON	LQ-300+	DCGY017054	FCC DoC Approved
3	MODEM	ACEEX	1414	980020520	IFAXDM1414

NO.	SIGNAL CABLE DESCRIPTION OF THE ABOVE SUPPORT UNITS
1	N/A
2	1.8m braid shielded wire, terminated with DB25 and Centronics connector via metallic frame, w/o core
3	1.2 m braid shielded wire, terminated with DB25 and DB9 connector via metallic frame, w/o core.

NOTE: All power cords of the above support units are non-shielded (1.8m).



4. TEST TYPES AND RESULTS

4.1 CONDUCTED EMISSION MEASUREMENT

4.1.1 LIMITS OF CONDUCTED EMISSION MEASUREMENT

FREQUENCY OF EMISSION (MHz)	CONDUCTED LIMIT (dB μ V)	
	Quasi-peak	Average
0.15-0.5	66 to 56	56 to 46
0.5-5	56	46
5-30	60	50

NOTE:

1. The lower limit shall apply at the transition frequencies.
2. All emanations from a class A/B digital device or system, including any network of conductors and apparatus connected thereto, shall not exceed the level of field strengths specified above.

4.1.2 TEST INSTRUMENTS

DESCRIPTION & MANUFACTURER	MODEL NO.	SERIAL NO.	CALIBRATED DATE	CALIBRATED UNTIL
ROHDE & SCHWARZ Test Receiver	ESCS 30	838251/021	Dec. 20, 2007	Dec. 19, 2008
ROHDE & SCHWARZ Artificial Mains Network (for EUT)	ESH3-Z5	100218	Nov. 21, 2007	Nov. 20, 2008
LISN With Adapter (for EUT)	AD10	C10Ada-001	Nov. 22, 2007	Nov. 21, 2008
ROHDE & SCHWARZ Artificial Mains Network (for peripherals)	ESH3-Z5	100219	Nov. 09, 2007	Nov. 08, 2008
ROHDE & SCHWARZ Artificial Mains Network (for peripherals)	ESH3-Z5	100220	Oct. 26, 2007	Oct. 25, 2008
Software	ADT_Cond_V7.3.5	NA	NA	NA
Software	ADT_ISN_V7.3.5	NA	NA	NA
RF cable (JYEBAO)	5D-FB	Cable-C10.01	Feb. 27, 2008	Feb. 26, 2009
SUHNER Terminator (For ROHDE & SCHWARZ LISN)	65BNC-5001	E1-010773	Feb. 14, 2008	Feb. 13, 2009

- NOTE:**
1. The calibration interval of the above test instruments is 12 months and the calibrations are traceable to NML/ROC and NIST/USA.
 2. The test was performed in Shielded Room No. 10.
 3. The VCCI Site Registration No. C-1852.

4.1.3 TEST PROCEDURES

- a. The EUT was placed 0.4 meters from the conducting wall of the shielded room with EUT being connected to the power mains through a line impedance stabilization network (LISN). Other support units were connected to the power mains through another LISN. The two LISNs provide 50 ohm/ 50uH of coupling impedance for the measuring instrument.
- b. Both lines of the power mains connected to the EUT were checked for maximum conducted interference.
- c. The frequency range from 150kHz to 30MHz was searched. Emission levels under limit - 20dB was not recorded.

4.1.4 DEVIATION FROM TEST STANDARD

No deviation.

4.1.5 TEST SETUP

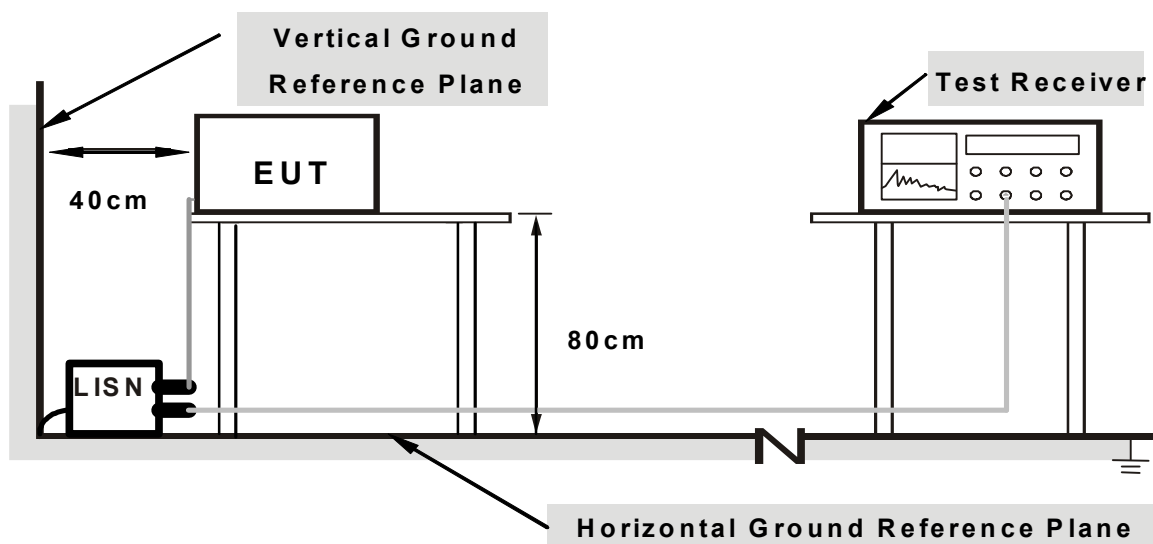

- Note:**
1. Support units were connected to second LISN.
 2. Both of LISNs (AMN) are 80 cm from EUT and at least 80 from other units and other metal planes

For the actual test configuration, please refer to the related item – Photographs of the Test Configuration.

4.1.6 EUT OPERATING CONDITIONS

- a. Connected the EUT to a notebook placed on a testing table.
- b. The notebook ran a test program (provided by manufacturer) to enable EUT under transmission/receiving condition continuously at specific channel frequency.
- c. The notebook sent "H" messages to its screen.
- d. The notebook sent messages to printer and the printer printed them out
- e. The notebook sent messages to modem.
- f. Repeated c ~ f.

4.1.7 TEST RESULTS

CONDUCTED WORST CASE DATA

MODULATION TYPE	GFSK	CHANNEL	77
INPUT POWER (SYSTEM)	120Vac, 60 Hz	6dB BANDWIDTH	9 kHz
ENVIRONMENTAL CONDITIONS	25deg. C, 67%RH, 999hPa	PHASE	Line 1
TESTED BY	Jun Wu		

No	Freq. [MHz]	Corr. Factor (dB)	Reading Value [dB (uV)]		Emission Level [dB (uV)]		Limit [dB (uV)]		Margin (dB)	
			Q.P.	AV.	Q.P.	AV.	Q.P.	AV.	Q.P.	AV.
			1	0.181	0.20	51.66	-	51.86	-	64.43
2	0.240	0.22	43.39	-	43.61	-	62.10	52.10	-18.49	-
3	2.355	0.29	30.75	-	31.04	-	56.00	46.00	-24.96	-
4	3.863	0.35	33.95	-	34.30	-	56.00	46.00	-21.70	-
5	14.348	1.06	34.91	-	35.97	-	60.00	50.00	-24.03	-
6	21.410	1.48	25.63	-	27.11	-	60.00	50.00	-32.89	-

- REMARKS:**
1. Q.P. and AV. are abbreviations of quasi-peak and average individually.
 2. "-": The Quasi-peak reading value also meets average limit and measurement with the average detector is unnecessary.
 3. The emission levels of other frequencies were very low against the limit.
 4. Margin value = Emission level - Limit value
 5. Correction factor = Insertion loss + Cable loss
 6. Emission Level = Correction Factor + Reading Value.

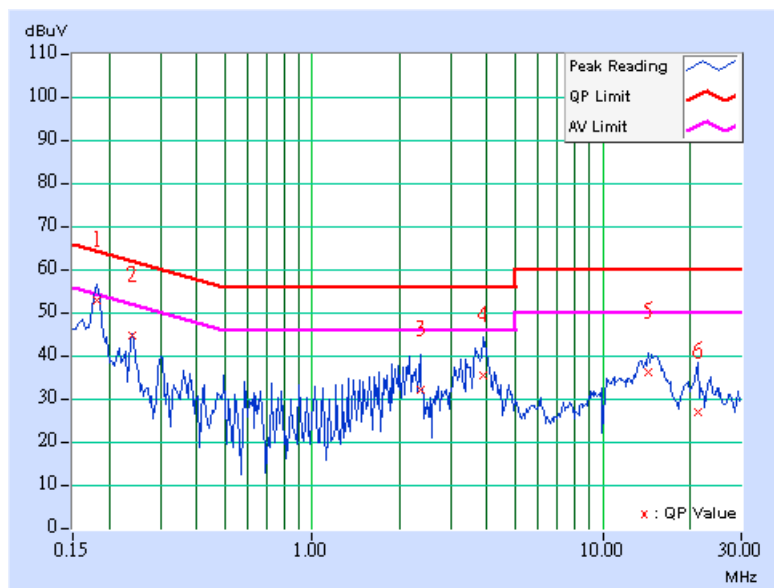

MODULATION TYPE	GFSK	CHANNEL	77
INPUT POWER (SYSTEM)	120Vac, 60 Hz	6dB BANDWIDTH	9 kHz
ENVIRONMENTAL CONDITIONS	25deg. C, 67%RH, 999hPa	PHASE	Line 2
TESTED BY	Jun Wu		

No	Freq. [MHz]	Corr. Factor (dB)	Reading Value		Emission Level		Limit		Margin	
			[dB (uV)]		[dB (uV)]		[dB (uV)]		(dB)	
			Q.P.	AV.	Q.P.	AV.	Q.P.	AV.	Q.P.	AV.
1	0.181	0.20	50.69	-	50.89	-	64.43	54.43	-13.54	-
2	0.300	0.22	39.10	-	39.32	-	60.26	50.26	-20.94	-
3	3.305	0.32	29.37	-	29.69	-	56.00	46.00	-26.31	-
4	3.550	0.32	35.98	-	36.30	-	56.00	46.00	-19.70	-
5	13.785	0.86	33.86	-	34.72	-	60.00	50.00	-25.28	-
6	21.434	1.18	24.21	-	25.39	-	60.00	50.00	-34.61	-

- REMARKS:**
1. Q.P. and AV. are abbreviations of quasi-peak and average individually.
 2. "-": The Quasi-peak reading value also meets average limit and measurement with the average detector is unnecessary.
 3. The emission levels of other frequencies were very low against the limit.
 4. Margin value = Emission level - Limit value
 5. Correction factor = Insertion loss + Cable loss
 6. Emission Level = Correction Factor + Reading Value.

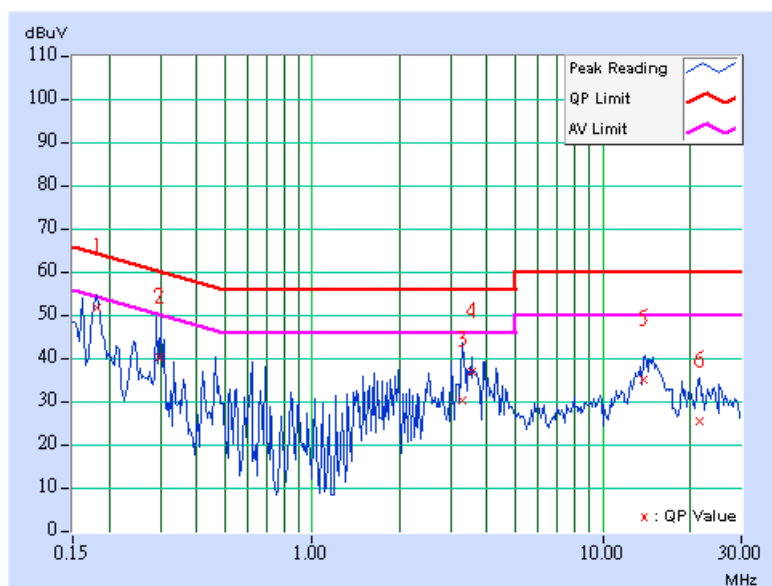



4.2 RADIATED EMISSION MEASUREMENT

4.2.1 LIMITS OF RADIATED EMISSION MEASUREMENT

Emissions radiated outside of the specified bands, shall be according to the general radiated limits in 15.209 as following:

Frequencies (MHz)	Field strength (microvolts/meter)	Measurement distance (meters)
0.009-0.490	2400/F(kHz)	300
0.490-1.705	24000/F(kHz)	30
1.705-30.0	30	30
30-88	100	3
88-216	150	3
216-960	200	3
Above 960	500	3

NOTE:

1. The lower limit shall apply at the transition frequencies.
2. Emission level (dBuV/m) = 20 log Emission level (uV/m).
3. As shown in 15.35(b), for frequencies above 1000MHz, the field strength limits are based on average detector, however, the peak field strength of any emission shall not exceed the maximum permitted average limits, specified above by more than 20dB under any condition of modulation.



4.2.2 TEST INSTRUMENTS

DESCRIPTION & MANUFACTURER	MODEL NO.	SERIAL NO.	CALIBRATED DATE	CALIBRATED UNTIL
HP Preamplifier	8447D	2432A03504	May 09, 2008	May 08, 2009
HP Preamplifier	8449B	3008A01201	Oct. 02, 2007	Oct. 01, 2008
HP Preamplifier	8449B	3008A01292	Aug. 06, 2008	Aug. 05, 2009
ROHDE & SCHWARZ TEST RECEIVER	ESI7	836697/012	Dec. 06, 2007	Dec. 05, 2008
Schwarzbeck Antenna	VULB 9168	137	May 02, 2008	May 01, 2009
Schwarzbeck Antenna	VHBA 9123	480	Apr. 23, 2008	Apr. 22, 2009
EMCO Horn Antenna	3115	6714	Oct. 19, 2007	Oct. 18, 2008
EMCO Horn Antenna	3115	9312-4192	Apr. 21, 2008	Apr. 20, 2009
ADT. Turn Table	TT100	0306	NA	NA
ADT. Tower	AT100	0306	NA	NA
Software	ADT_Radiated_V 7.6.15	NA	NA	NA
SUHNER RF cable	SF104-26.5	CABLE-CH6-17m -01	Nov. 05, 2007	Nov. 04, 2008
ROHDE & SCHWARZ Spectrum Analyzer	FSP 40	100035	Mar. 26, 2008	Mar. 25, 2009

- NOTE:**
1. The calibration interval of the above test instruments is 12 months. And the calibrations are traceable to NML/ROC and NIST/USA.
 2. The horn antenna and HP preamplifier (model: 8449B) are used only for the measurement of emission frequency above 1GHz if tested.
 3. The test was performed in Chamber No. 6.
 4. The Industry Canada Reference No. IC 3789-6.
 5. The FCC Site Registration No. is 447212.

4.2.3 TEST PROCEDURES

- a. The EUT was placed on the top of a rotating table 0.8 meters above the ground at a 3 meter semi- anechoic. The table was rotated 360 degrees to determine the position of the highest radiation.
- b. The EUT was set 3 meters away from the interference-receiving antenna, which was mounted on the top of a variable-height antenna tower.
- c. The antenna is a broadband antenna, and its height is varied from one meter to four meters above the ground to determine the maximum value of the field strength. Both horizontal and vertical polarizations of the antenna are set to make the measurement.
- d. For each suspected emission, the EUT was arranged to its worst case and then the antenna was tuned to heights from 1 meter to 4 meters and the rotatable table was turned from 0 degrees to 360 degrees to find the maximum reading.
- e. The test-receiver system was set to Peak Detect Function and Specified Bandwidth with Maximum Hold Mode.
- f. If the emission level of the EUT in peak mode was lower than the limit specified, then testing could be stopped and the peak values of the EUT would be reported. Otherwise the emissions would be re-tested one by one using peak, quasi-peak method or average method as specified and then reported in data sheet.

NOTE:

1. The resolution bandwidth of test receiver/spectrum analyzer is 120kHz for Quasi-peak detection at frequency below 1GHz.
2. The resolution bandwidth is 1MHz and video bandwidth of test receiver/spectrum analyzer is 3MHz for Peak detection at frequency above 1GHz. The resolution bandwidth of test receiver/spectrum analyzer is 1 MHz for Average detection (AV) at frequency above 1GHz.
3. The resolution bandwidth of test receiver/spectrum analyzer is 1 MHz and the video bandwidth is 10 Hz for Average detection (AV) at frequency above 1GHz.

4.2.4 DEVIATION FROM TEST STANDARD

No deviation

4.2.5 TEST SETUP

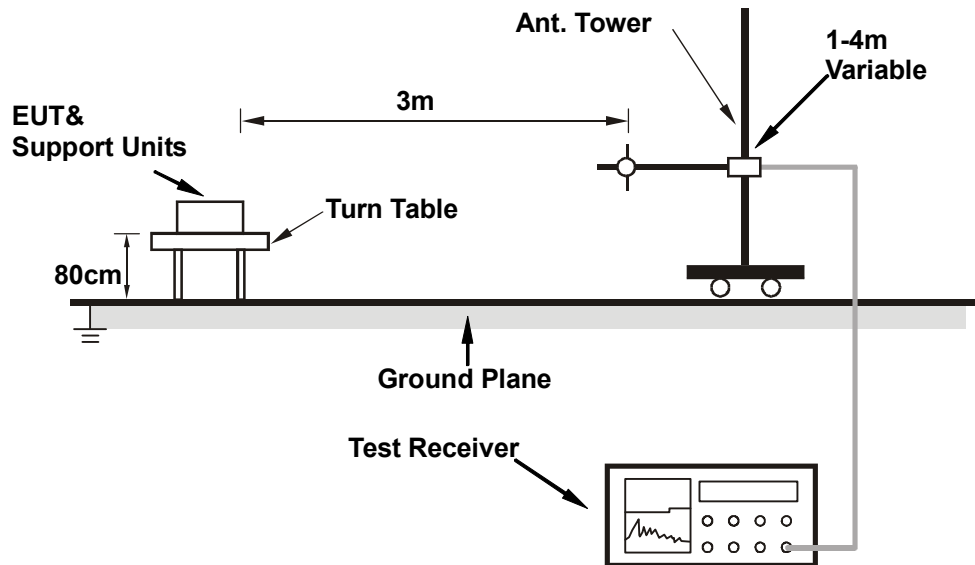

For the actual test configuration, please refer to the related item – Photographs of the Test Configuration.

4.2.6 EUT OPERATING CONDITIONS

Set the EUT under transmission condition continuously at specific channel frequency.



4.2.7 TEST RESULTS

RADIATED WORST CASE DATA: BELOW 1GHz

MODULATION TYPE	GFSK	CHANNEL	77
INPUT POWER (SYSTEM)	120Vac, 60 Hz	FREQUENCY RANGE	Below 1000MHz
ENVIRONMENTAL CONDITIONS	26deg. C, 68%RH, 996Pa	DETECTOR FUNCTION	Quasi-Peak
TESTED BY	Chad Lee		

ANTENNA POLARITY & TEST DISTANCE: HORIZONTAL AT 3 M

No.	Freq. (MHz)	Emission Level (dBuV/m)	Limit (dBuV/m)	Margin (dB)	Antenna Height (m)	Table Angle (Degree)	Raw Value (dBuV)	Correction Factor (dB/m)
1	92.204	32.87 QP	43.50	-10.63	1.55 H	256	22.57	10.30
2	101.924	35.35 QP	43.50	-8.15	2.21 H	295	23.84	11.51
3	249.659	36.04 QP	46.00	-9.96	1.08 H	67	20.85	15.19
4	290.481	36.91 QP	46.00	-9.09	1.00 H	31	21.07	15.84
5	296.313	35.75 QP	46.00	-10.25	1.00 H	73	19.83	15.92
6	735.631	33.89 QP	46.00	-12.11	1.00 H	319	8.49	25.40

ANTENNA POLARITY & TEST DISTANCE: VERTICAL AT 3 M

No.	Freq. (MHz)	Emission Level (dBuV/m)	Limit (dBuV/m)	Margin (dB)	Antenna Height (m)	Table Angle (Degree)	Raw Value (dBuV)	Correction Factor (dB/m)
1	98.036	34.23 QP	43.50	-9.27	1.54 V	337	23.17	11.06
2	160.240	32.26 QP	43.50	-11.24	1.05 V	175	18.07	14.19
3	206.894	32.24 QP	43.50	-11.26	1.22 V	166	20.10	12.14
4	249.659	33.72 QP	46.00	-12.28	1.42 V	190	18.53	15.19
5	292.425	33.43 QP	46.00	-12.57	1.32 V	175	17.56	15.87
6	300.200	33.67 QP	46.00	-12.33	1.74 V	187	17.68	15.99

- REMARKS:**
1. Emission level(dBuV/m)=Raw Value(dBuV) + Correction Factor(dB/m)
 2. Correction Factor(dB/m) = Antenna Factor (dB/m) + Cable Factor (dB)
 - 3The other emission levels were very low against the limit.
 4. Margin value = Emission level – Limit value.



RADIATED WORST CASE DATA: ABOVE 1GHz

MODULATION TYPE	GFSK	CHANNEL	0
INPUT POWER (SYSTEM)	120Vac, 60 Hz	FREQUENCY RANGE	1 ~ 25GHz
ENVIRONMENTAL CONDITIONS	26deg. C, 68%RH, 996Pa	DETECTOR FUNCTION	Peak(PK) Average (AV)
TESTED BY	Chad Lee		

ANTENNA POLARITY & TEST DISTANCE: HORIZONTAL AT 3 M

No.	Freq. (MHz)	Emission Level (dBuV/m)	Limit (dBuV/m)	Margin (dB)	Antenna Height (m)	Table Angle (Degree)	Raw Value (dBuV)	Correction Factor (dB/m)
1	2390.000	57.27 PK	74.00	-16.73	1.34 H	270	22.61	34.66
2	2390.000	45.93 AV	54.00	-8.07	1.34 H	270	11.27	34.66
3	*2402.000	84.57 PK	114.00	-29.43	1.34 H	270	49.88	34.69
4	*2402.000	65.82 AV	94.00	-28.18	1.34 H	270	31.13	34.69
5	4802.000	48.82 PK	74.00	-25.18	1.13 H	32	6.92	41.90
6	4802.000	34.84 AV	54.00	-19.16	1.13 H	32	-7.06	41.90

ANTENNA POLARITY & TEST DISTANCE: VERTICAL AT 3 M

No.	Freq. (MHz)	Emission Level (dBuV/m)	Limit (dBuV/m)	Margin (dB)	Antenna Height (m)	Table Angle (Degree)	Raw Value (dBuV)	Correction Factor (dB/m)
1	2390.000	57.77 PK	74.00	-16.23	1.17 V	299	23.11	34.66
2	2390.000	45.90 AV	54.00	-8.10	1.17 V	299	11.24	34.66
3	*2402.000	83.22 PK	114.00	-30.78	1.17 V	299	48.53	34.69
4	*2402.000	65.30 AV	94.00	-28.70	1.17 V	299	30.61	34.69
5	4804.000	48.45 PK	74.00	-25.55	1.36 V	38	6.54	41.91
6	4804.000	36.46 AV	54.00	-17.54	1.36 V	38	-5.45	41.91

- REMARKS:**
1. Emission level(dBuV/m)=Raw Value(dBuV) + Correction Factor(dB/m)
 2. Correction Factor(dB/m) = Antenna Factor (dB/m) + Cable Factor (dB)
 3. The other emission levels were very low against the limit.
 4. Margin value = Emission level – Limit value.
 5. “ * “ : Fundamental frequency



MODULATION TYPE	GFSK	CHANNEL	38
INPUT POWER (SYSTEM)	120Vac, 60 Hz	FREQUENCY RANGE	1 ~ 25GHz
ENVIRONMENTAL CONDITIONS	26deg. C, 68%RH, 996Pa	DETECTOR FUNCTION	Peak(PK) Average (AV)
TESTED BY	Chad Lee		

ANTENNA POLARITY & TEST DISTANCE: HORIZONTAL AT 3 M

No.	Freq. (MHz)	Emission Level (dBuV/m)	Limit (dBuV/m)	Margin (dB)	Antenna Height (m)	Table Angle (Degree)	Raw Value (dBuV)	Correction Factor (dB/m)
1	*2440.000	87.05 PK	114.00	-26.95	1.00 H	245	52.28	34.77
2	*2440.000	67.14 AV	94.00	-26.86	1.00 H	245	32.37	34.77
3	4880.000	49.72 PK	74.00	-24.28	1.00 H	142	7.60	42.12
4	4880.000	35.84 AV	54.00	-18.16	1.00 H	142	-6.28	42.12

ANTENNA POLARITY & TEST DISTANCE: VERTICAL AT 3 M

No.	Freq. (MHz)	Emission Level (dBuV/m)	Limit (dBuV/m)	Margin (dB)	Antenna Height (m)	Table Angle (Degree)	Raw Value (dBuV)	Correction Factor (dB/m)
1	*2440.000	85.50 PK	114.00	-28.50	1.18 V	306	50.73	34.77
2	*2440.000	66.73 AV	94.00	-27.27	1.18 V	306	31.96	34.77
3	4880.000	49.97 PK	74.00	-24.03	1.06 V	161	7.85	42.12
4	4880.000	37.44 AV	54.00	-16.56	1.06 V	161	-4.68	42.12

- REMARKS:**
1. Emission level(dBuV/m)=Raw Value(dBuV) + Correction Factor(dB/m)
 2. Correction Factor(dB/m) = Antenna Factor (dB/m) + Cable Factor (dB)
 3. The other emission levels were very low against the limit.
 4. Margin value = Emission level – Limit value.
 5. “ * “ : Fundamental frequency



MODULATION TYPE	GFSK	CHANNEL	77
INPUT POWER (SYSTEM)	120Vac, 60 Hz	FREQUENCY RANGE	1 ~ 25GHz
ENVIRONMENTAL CONDITIONS	26deg. C, 68%RH, 996Pa	DETECTOR FUNCTION	Peak(PK) Average (AV)
TESTED BY	Chad Lee		

ANTENNA POLARITY & TEST DISTANCE: HORIZONTAL AT 3 M

No.	Freq. (MHz)	Emission Level (dBuV/m)	Limit (dBuV/m)	Margin (dB)	Antenna Height (m)	Table Angle (Degree)	Raw Value (dBuV)	Correction Factor (dB/m)
1	*2479.000	85.22 PK	114.00	-28.78	1.00 H	245	50.37	34.85
2	*2479.000	66.46 AV	94.00	-27.54	1.00 H	245	31.61	34.85
3	2483.500	62.51 PK	74.00	-11.49	1.00 H	245	27.65	34.86
4	2483.500	45.90 AV	54.00	-8.10	1.00 H	245	11.04	34.86
5	4958.000	49.66 PK	74.00	-24.34	1.06 H	35	7.32	42.34
6	4958.000	36.28 AV	54.00	-17.72	1.06 H	35	-6.06	42.34

ANTENNA POLARITY & TEST DISTANCE: VERTICAL AT 3 M

No.	Freq. (MHz)	Emission Level (dBuV/m)	Limit (dBuV/m)	Margin (dB)	Antenna Height (m)	Table Angle (Degree)	Raw Value (dBuV)	Correction Factor (dB/m)
1	*2479.000	84.14 PK	114.00	-29.86	1.15 V	298	49.29	34.85
2	*2479.000	65.47 AV	94.00	-28.53	1.15 V	298	30.62	34.85
3	2483.500	60.96 PK	74.00	-13.04	1.15 V	298	26.10	34.86
4	2483.500	46.18 AV	54.00	-7.82	1.15 V	298	11.32	34.86
5	4958.000	49.62 PK	74.00	-24.38	1.00 V	13	7.28	42.34
6	4958.000	37.50 AV	54.00	-16.50	1.00 V	13	-4.84	42.34

- REMARKS:**
1. Emission level(dBuV/m)=Raw Value(dBuV) + Correction Factor(dB/m)
 2. Correction Factor(dB/m) = Antenna Factor (dB/m) + Cable Factor (dB)
 3. The other emission levels were very low against the limit.
 4. Margin value = Emission level – Limit value.
 5. “ * “ : Fundamental frequency



4.3 BAND EDGES MEASUREMENT

4.3.1 LIMITS OF BAND EDGES MEASUREMENT

Below -50dB of the highest emission level of operating band (in 100kHz Resolution Bandwidth).

4.3.2 TEST INSTRUMENTS

Description & Manufacturer	Model No.	Serial No.	Calibrated Date	Calibrated Until
SPECTRUM ANALYZER	FSP 40	100035	Mar. 26, 2008	Mar. 25, 2009

NOTE: The calibration interval of the above test instruments is 12 months and the calibrations are traceable to NML/ROC and NIST/USA.

4.3.3 TEST PROCEDURE

The transmitter output was connected to the spectrum analyzer via a low lose cable. Set both RBW and VBW of spectrum analyzer to 100 kHz and 300 kHz with suitable frequency span including 100 MHz bandwidth from band edge. The band edges was measured and recorded.

The spectrum plots are attached on the following pages.

4.3.4 DEVIATION FROM TEST STANDARD

No deviation

4.3.5 EUT OPERATING CONDITION

Same as Item 4.2.6

4.3.6 TEST RESULTS

The spectrum plots are attached on the following 4 images. D1 line indicates the highest level, and D2 line indicates the 50dB offset below D1. It shows compliance with the requirement in part 15.249(d).

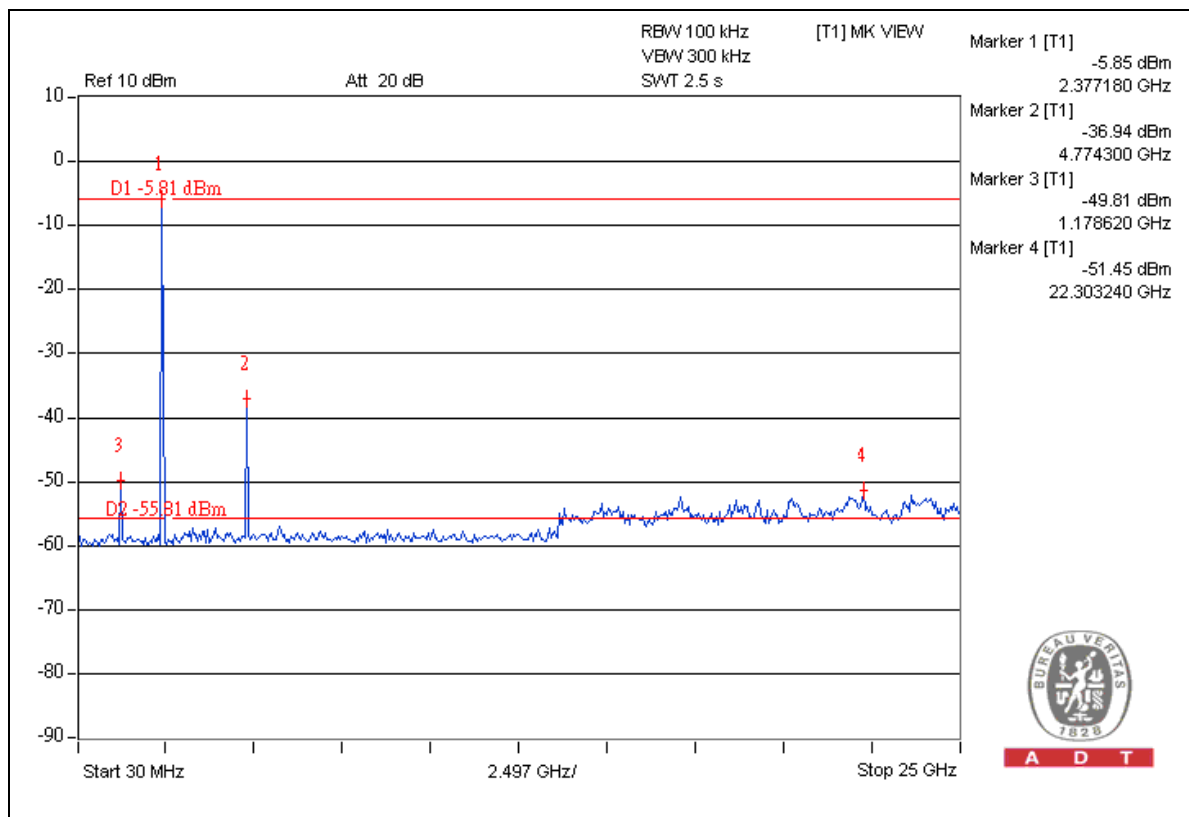
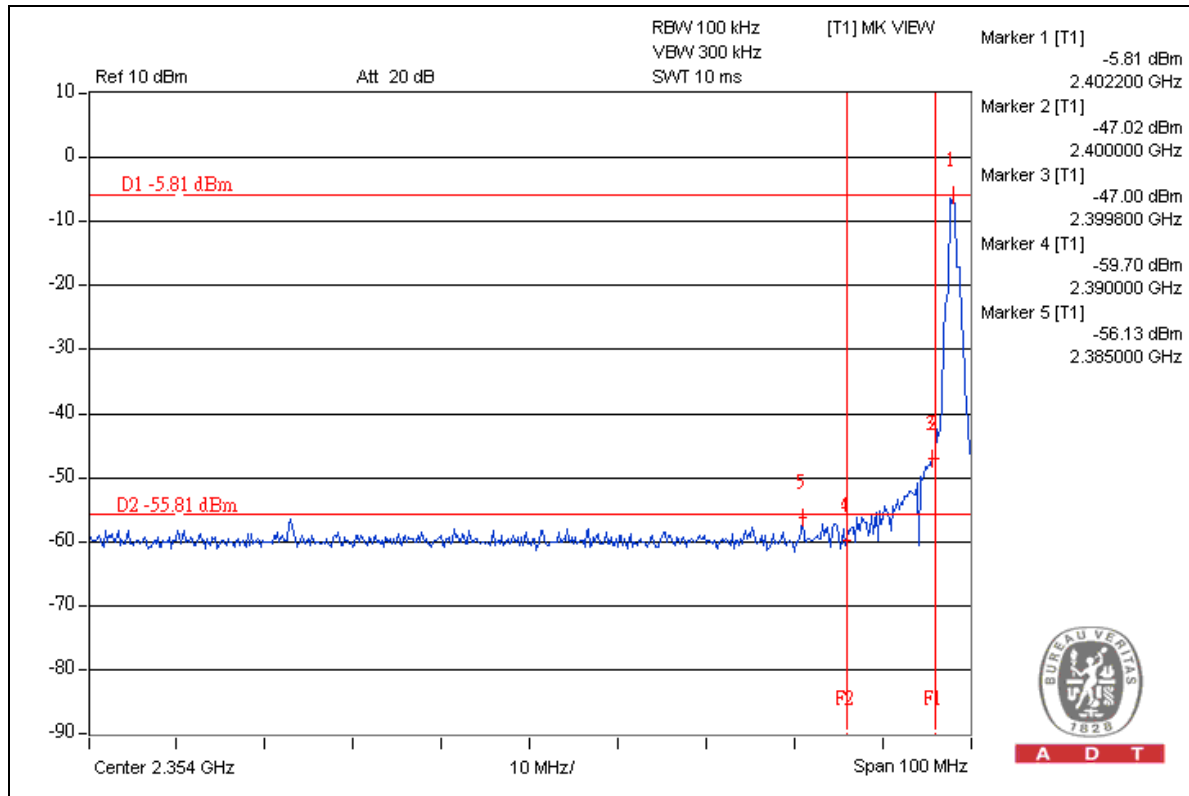

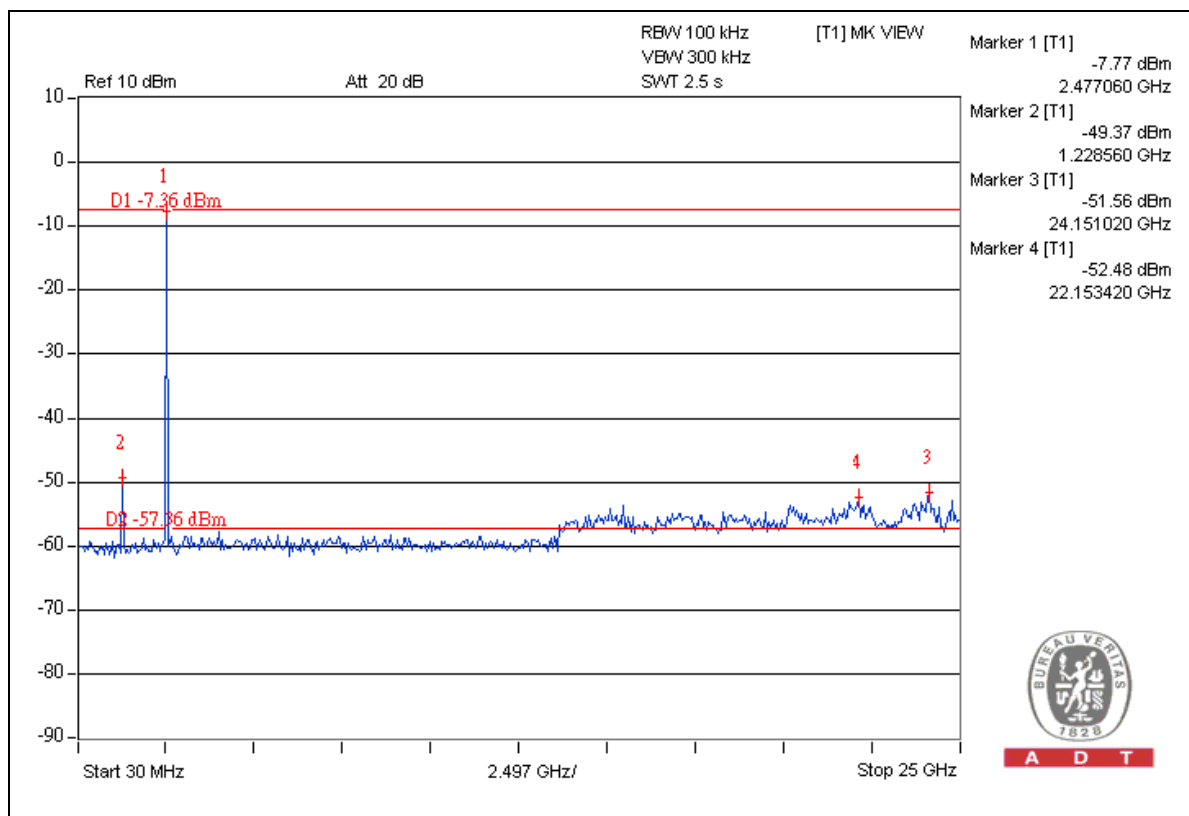
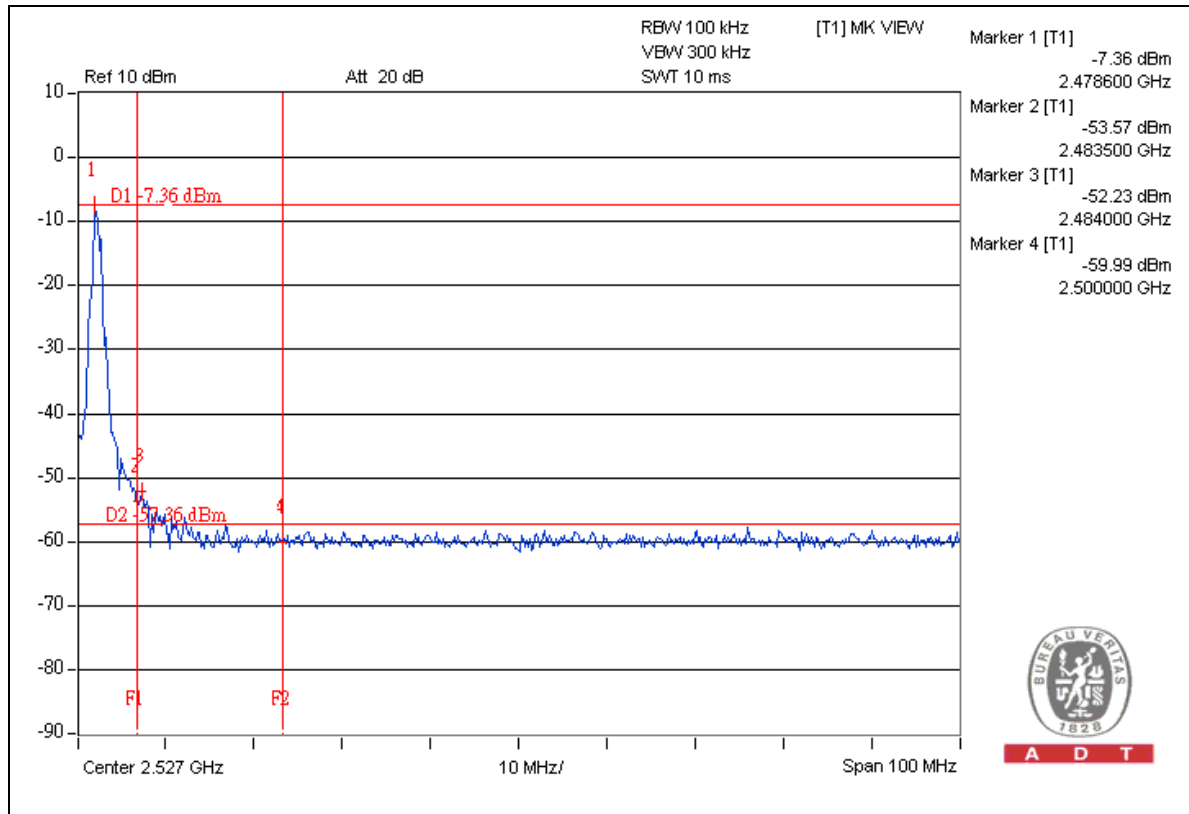



5. PHOTOGRAPHS OF THE TEST CONFIGURATION

Please refer to the attached file (Test Setup Photo).



6. INFORMATION ON THE TESTING LABORATORIES

We, ADT Corp., were founded in 1988 to provide our best service in EMC, Radio, Telecom and Safety consultation. Our laboratories are accredited and approved by the following approval agencies according to ISO/IEC 17025.

USA	FCC, UL
Germany	TUV Rheinland
Japan	VCCI
Norway	NEMKO
Canada	INDUSTRY CANADA, CSA
R.O.C.	TAF, BSMI, NCC
Netherlands	Telefication
Singapore	GOST-ASIA(MOU)
Russia	CERTIS(MOU)

Copies of accreditation certificates of our laboratories obtained from approval agencies can be downloaded from our web site: www.adt.com.tw/index.5/phtml. If you have any comments, please feel free to contact us at the following:

Linko EMC/RF Lab:
Tel: 886-2-26052180
Fax: 886-2-26051924

Hsin Chu EMC/RF Lab:
Tel: 886-3-5935343
Fax: 886-3-5935342

Hwa Ya EMC/RF/Safety Telecom Lab:
Tel: 886-3-3183232
Fax: 886-3-3185050

Web Site: www.adt.com.tw

The address and road map of all our labs can be found in our web site also



7. APPENDIX A – MODIFICATIONS RECORDERS FOR ENGINEERING CHANGES TO THE EUT BY THE LAB

No any modifications are made to the EUT by the lab during the test.

---END---