

Powerwave Technologies, Inc.

ADDENDUM TO TEST REPORT 87766-22

Nexus Dual Band Repeater, RH304022/13B

Tested To The Following Standards:

FCC Part 24 Subpart E

Report No.: 87766-22A

Date of issue: July 29, 2010



TESTING
CERT #803.01, 803.02,
803.05, 803.06

This test report bears the accreditation symbol indicating that the testing performed herein meets the test and reporting requirements of ISO/IEC 17025 under the applicable scope of EMC testing for CKC Laboratories, Inc.

We strive to create long-term, trust based relationships by providing sound, adaptive, customer first testing services. We embrace each of our customers' unique EMC challenges, not as an interruption to set processes, but rather as the reason we are in business.

TABLE OF CONTENTS

Administrative Information	3
Test Report Information	3
Revision History	3
Report Authorization	3
Test Facility Information	4
Site Registration & Accreditation Information	4
Summary of Results	5
Conditions During Testing	5
Equipment Under Test	6
Peripheral Devices	6
FCC Part 24 E.....	7
2.1033(c)(14)/2.1046/24.232(a) - RF Power Output	7
2.1033(c)(14)/2.1049(i) - Occupied Bandwidth	13
2.1033(c)(14)/2.1051/24.238(a) - Spurious Emissions at Antenna Terminal	22
2.1033(c)(14)/2.1053/24.238(a) - Field Strength of Spurious Radiation	25
24.238(a) – Block Edge	32
2-11-01/EAB/RF – Out of Band Rejection	38
Supplemental Information	42
Measurement Uncertainty	42
Emissions Test Details.....	42

ADMINISTRATIVE INFORMATION

Test Report Information

REPORT PREPARED FOR:

Powerwave Technologies, Inc.
1801 E. St. Andrew Place
Santa Ana, CA 92705

Representative: Sean Doan
Customer Reference Number: 137069

DATE OF EQUIPMENT RECEIPT:

DATE(S) OF TESTING:

REPORT PREPARED BY:

Dianne Dudley
CKC Laboratories, Inc.
5046 Sierra Pines Drive
Mariposa, CA 95338

Project Number: 87766
137069

July 13, 2010

July 13 - 15, 2010

Revision History

Original: To perform the testing of the Nexus Dual Band Repeater, RH30422/13B with the requirements for FCC Part 24 Subpart E devices.

Addendum A: To add Customer Declared Multiple Model Statement to include additional model numbers equivalent to the Nexus Dual Band Repeater, RH30422/13B.

Report Authorization

The test data contained in this report documents the observed testing parameters pertaining to and are relevant for only the sample equipment tested in the agreed upon operational mode(s) and configuration(s) as identified herein. Compliance assessment remains the client's responsibility. This report may not be used to claim product endorsement by A2LA or any government agencies. This test report has been authorized for release under quality control from CKC Laboratories, Inc.



Steve Behm
Director of Quality Assurance & Engineering Services
CKC Laboratories, Inc.

Test Facility Information



Our laboratories are configured to effectively test a wide variety of product types. CKC utilizes first class test equipment, anechoic chambers, data acquisition and information services to create accurate, repeatable and affordable test results.

TEST LOCATION(S):
CKC Laboratories, Inc.
110 Olinda Place
Brea, CA 92823

Site Registration & Accreditation Information

Location	Japan	Canada	FCC
Brea A	R-301, C-314 & T-1572	3082D-1	90473

SUMMARY OF RESULTS

Standard / Specification: FCC Part 24 Subpart E

Description	Test Procedure/Method	Results
RF Power Output	FCC 2.1033(c)(14)/2.1046/24.232(a)	Pass
Occupied Bandwidth	FCC 2.1033(c)(14)/2.1049(i)	Pass
Spurious Emissions at Antenna Terminal	FCC 2.1033(c)(14)/2.1051/24.238(a)	Pass
Field Strength of Spurious Radiation	FCC 2.1033(c)(14)/2.1053/24.238(a)	Pass
Block Edge	24.238(a)	Pass
Out of Band Rejection	02-11-04/EAB/RF	Pass

Conditions During Testing

This list is a summary of the conditions noted for or modifications made to the equipment during testing.

Summary of Conditions
None

EQUIPMENT UNDER TEST (EUT)

The following model has been tested by CKC Laboratories: **Nexus Dual Band Repeater, RH304022/13B**

The manufacturer states that the following additional models are identical electrically to the one which was tested, or any differences between them do not affect their EMC characteristics, and therefore they meet the level of testing equivalent to the tested models. **Nexus Dual Band Repeater, Model: RH305022/13B.**

EQUIPMENT UNDER TEST

The EUT is a RF amplifier/repeater. The manufacturer does not provide an antenna for sale with the product.

Nexus Dual Band Repeater

Manuf: Powerwave Technologies, Inc.

Model: RH304022/13B

Serial: NA

PERIPHERAL DEVICES

The EUT was tested with the following peripheral device(s):

Pre Amp

Manuf: Minicircuit

Model: ZHL4240_SAM

Serial: D092397-19

Optical Converter Module

Manuf: Powerwave Technologies, Inc

Model: NA

Serial: NA

Signal Generator

Manuf: Aeroflex

Model: IFR343B3

Serial: 3410051078

Spectrum Analyzer

Manuf: Agilent

Model: 8561EC

Serial: 3946A00167

FCC PART 24 E

This report contains EMC emissions test results under United States Federal Communications Commission (FCC) requirements for licensed devices.

2.1033(c)(14)/2.1046/24.232(a) - RF Power Output

Engineer Name: E. Wong

Test Equipment				
Equipment	Serial	Cal Date	Cal Due	Asset
RF Power meter	GB37170458	01/26/10	01/26/12	02778
Power Sensor	MY41502826	01/26/10	01/26/12	03072
Spectrum Analyzer	US44300438	07/23/08	07/23/10	02672
36" 40GHz cable	NA	10/28/09	10/28/11	03174

Test Setup

The EUT is placed on the wooden table. The RF Output port is connected to a load string. The optical in port is connected to a support Optical converter. The support optical converter receives RF signal, converts the signal to optic and sends it to the EUT. The EUT decodes the optical signal, and generates an RF signal.

The insertion loss of the RF attenuator was measured and entered as a measurement offset of the power meter.

RF output port Service 2
Operating range: 869-894MHz.

The RF power of the EUT was measured at the antenna port. The measurement satisfies the above requirement by demonstrating the measured power is below 100 watts.

Test Data

Modulation: GSM

Frequency	Measured Power (W)
1930.5	20
1960.0	20
1989.5	20

Modulation :WCDMA(3GPP)

Frequency	Measured Power (W)
1933.0	20
1960.0	20
1987.0	20

In Addition, the Peak to Average Ratio was measured with a spectrum analyzer in accordance with FCC guideline. Complementary cumulative distribution function (CCDF) function of the spectrum analyzer was employed, with the measurement bandwidth set at 8 MHz to capture emission within 4 MHz above and below the center frequency.

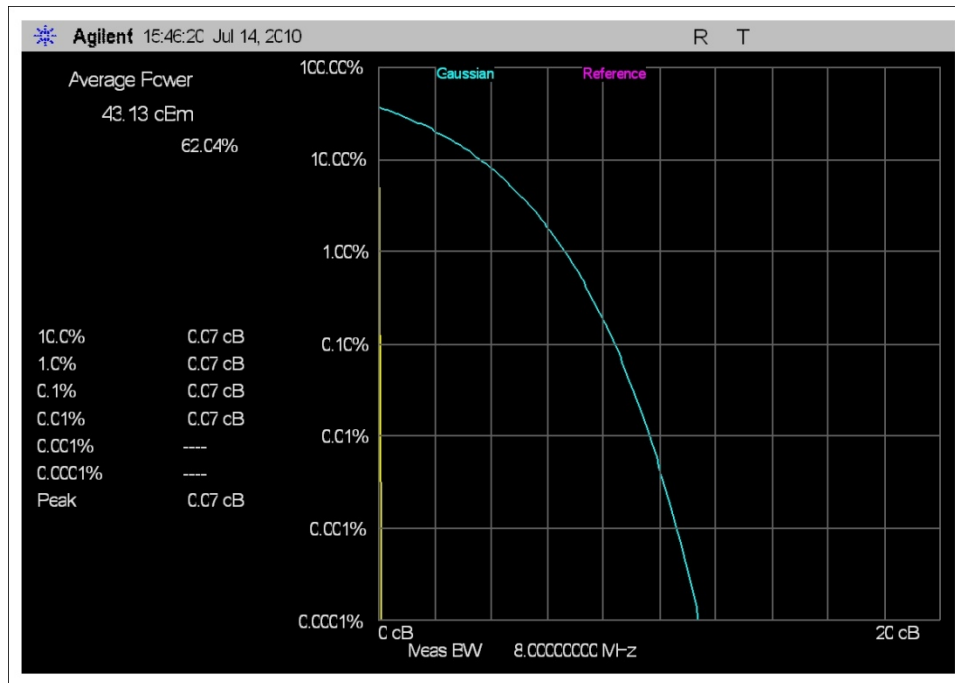

GSM – 1930 MHz

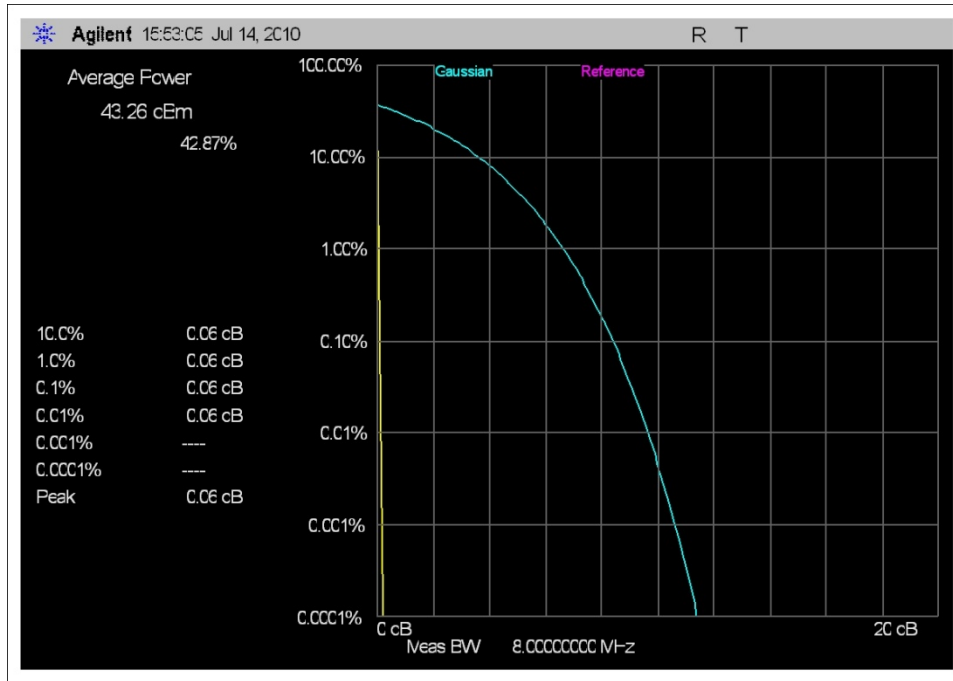

GSM – 1960 MHz

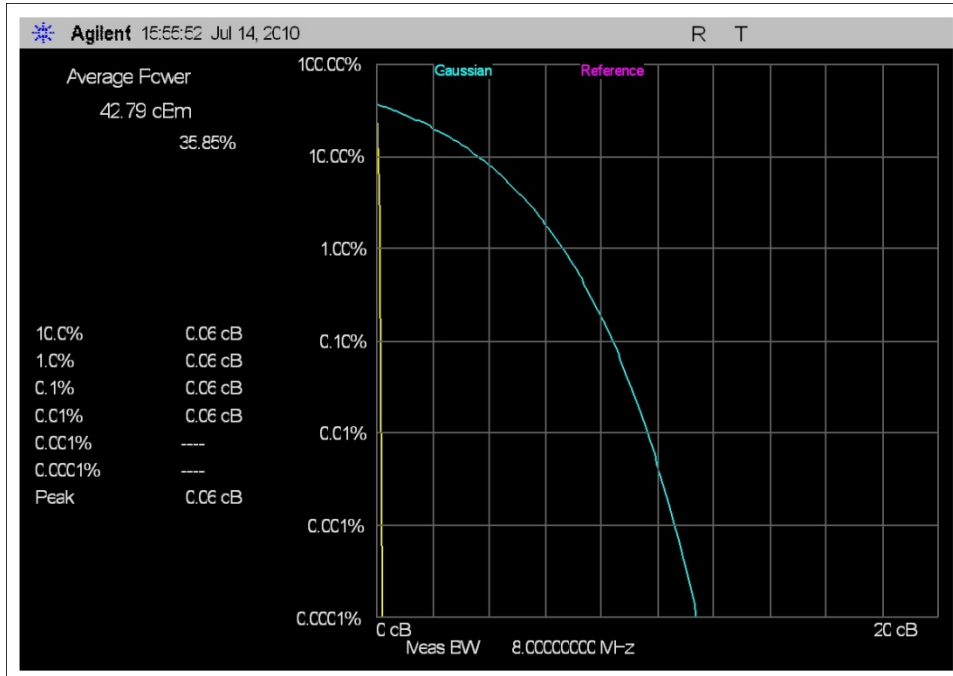

GSM – 1990 MHz

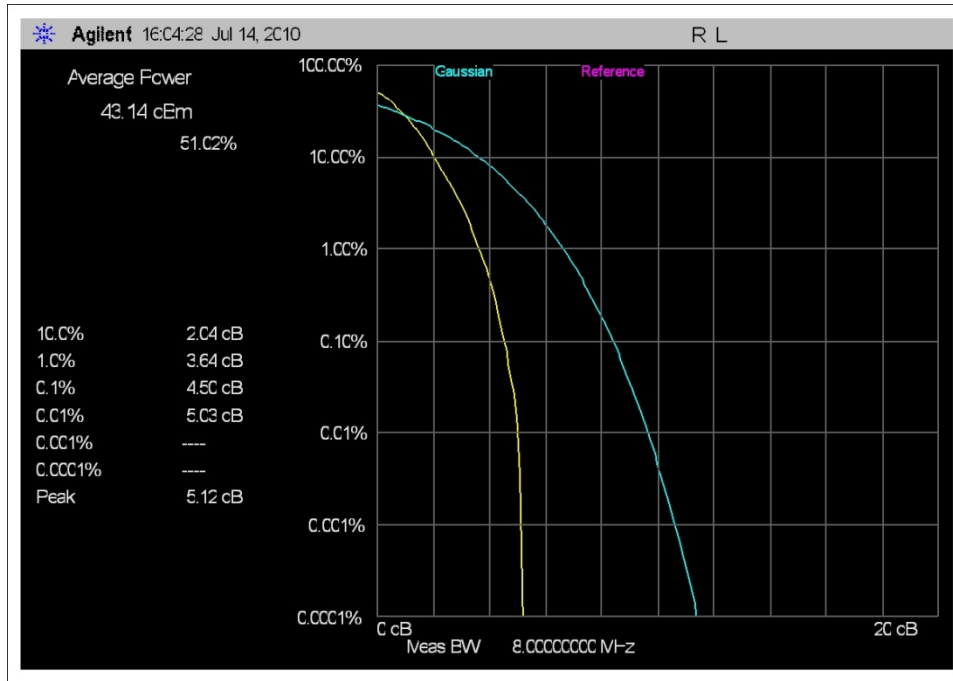

WCDMA – 1933 MHz

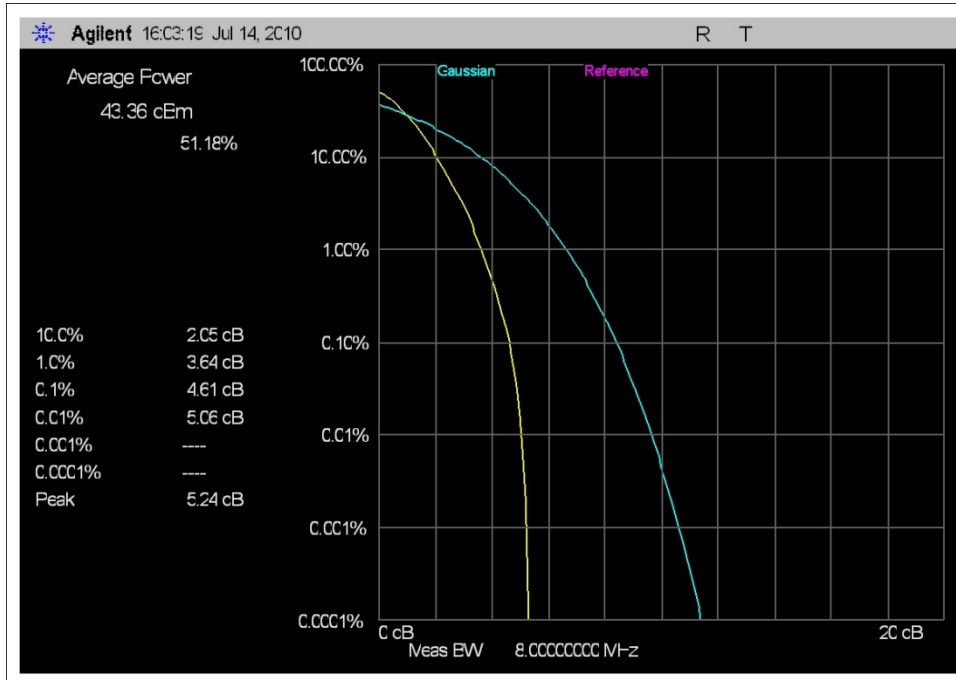

WCDMA – 1960 MHz

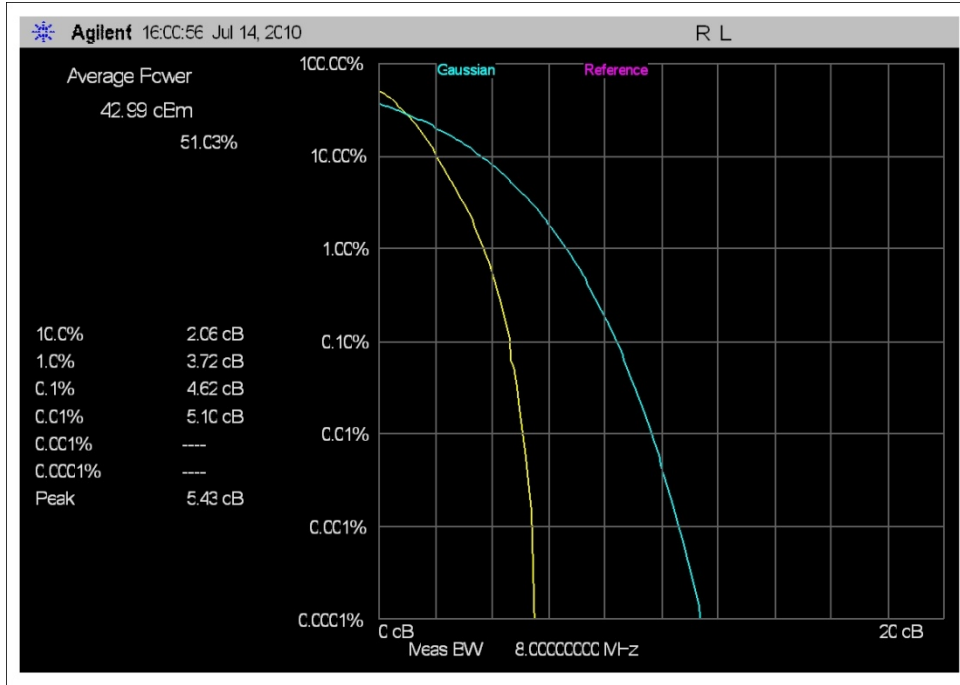

WCDMA – 1990 MHz

Test Setup Photos



2.1033(c)(14)/2.1049(i) - Occupied Bandwidth

Engineer Name: E. Wong

Test Equipment				
Name	Serial	Cal Date	Cal Due	Asset
Spectrum Analyzer	US44300438	07/23/08	07/23/10	02672
36" 40GHz cable	NA	10/28/09	10/28/11	03174

Test Setup

The EUT is placed on the wooden table. The RF Output port is connected to a load string. The optical in port is connected to a support Optical converter. The support optical converter receives RF signal, converts the signal to optic and sends to the EUT. The EUT decodes the optical signal, and generates an RF signal.

Power = 43dBm=20 watt

RF output port Service 1
Operating range: 1930-1990MHz.

Modulation: GSM
Freq = 1930.5MHz, 1960MHz, 1989.5 MHz

Modulation: WCDMA (3GPP)
Freq = 1933MHz, 1960MHz, 1987 MHz

Output waveform is recorded with a spectrum analyzer at the Antenna port of the device. Input waveform is recorded with a spectrum analyzer at the RF out of the support ESG.

Test Data

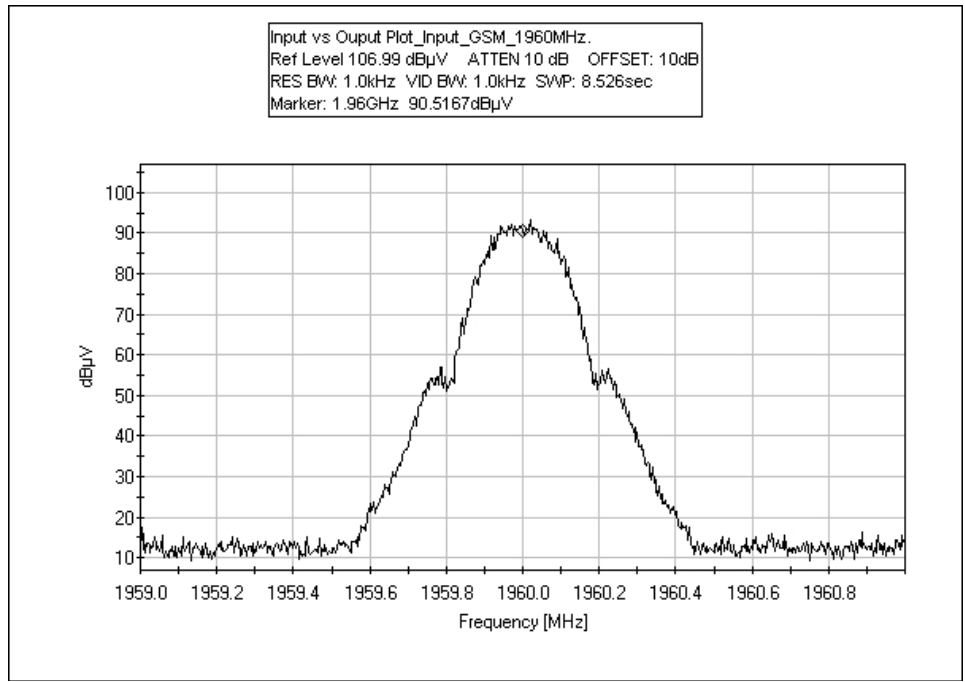
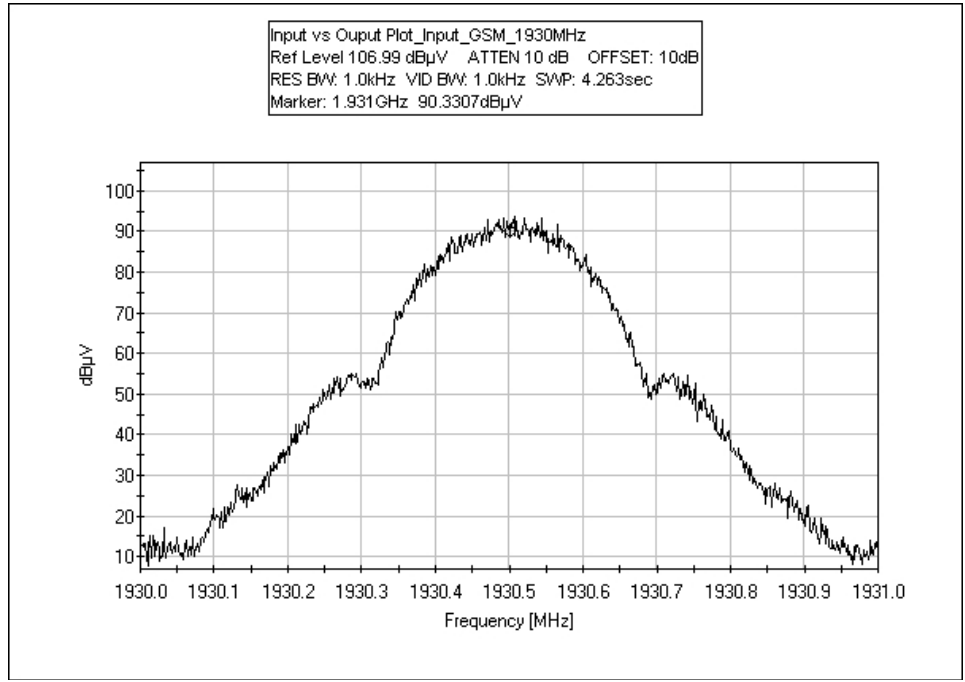

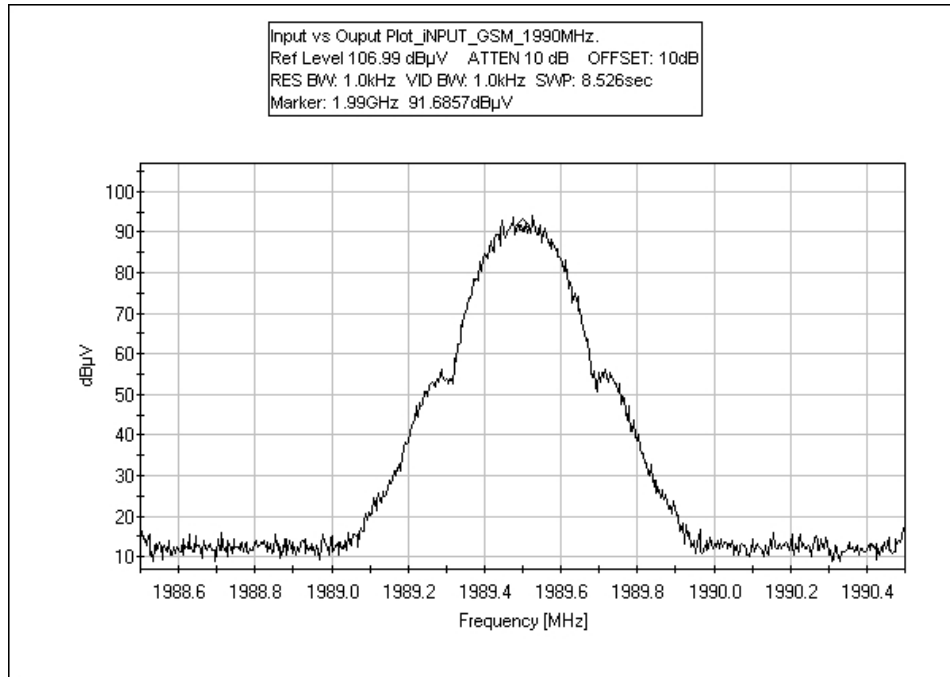

GSM – 1990 MHz Input

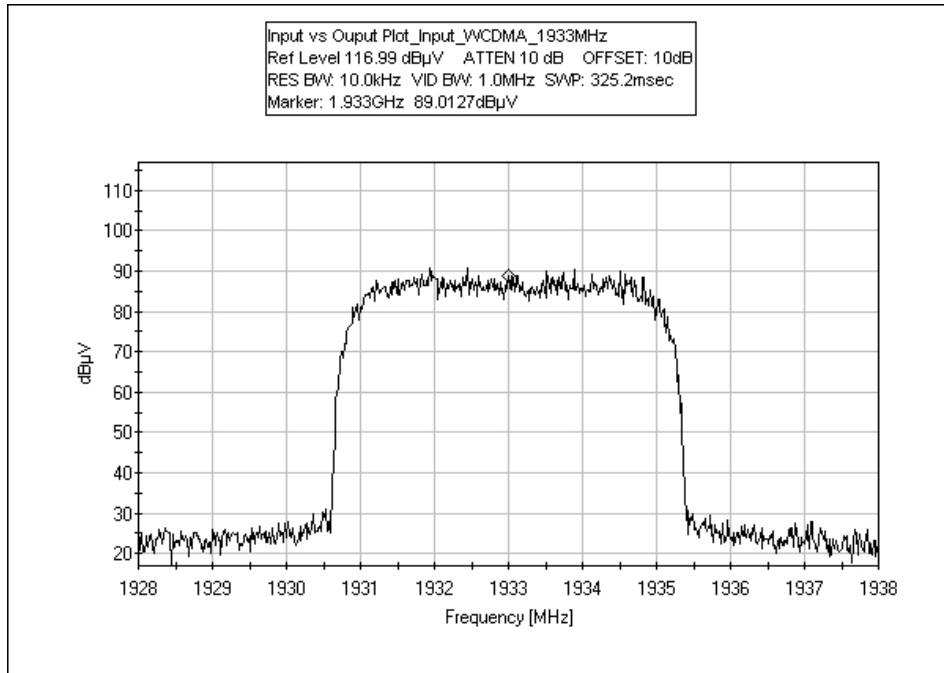

WCDMA – 1933 MHz Input

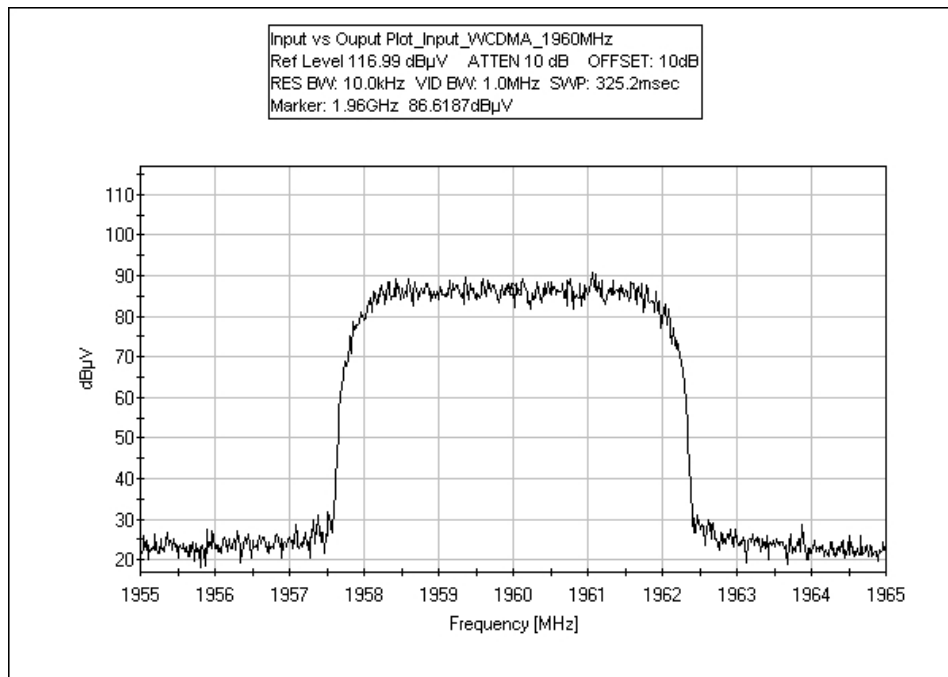

WCDMA – 1960 MHz Input

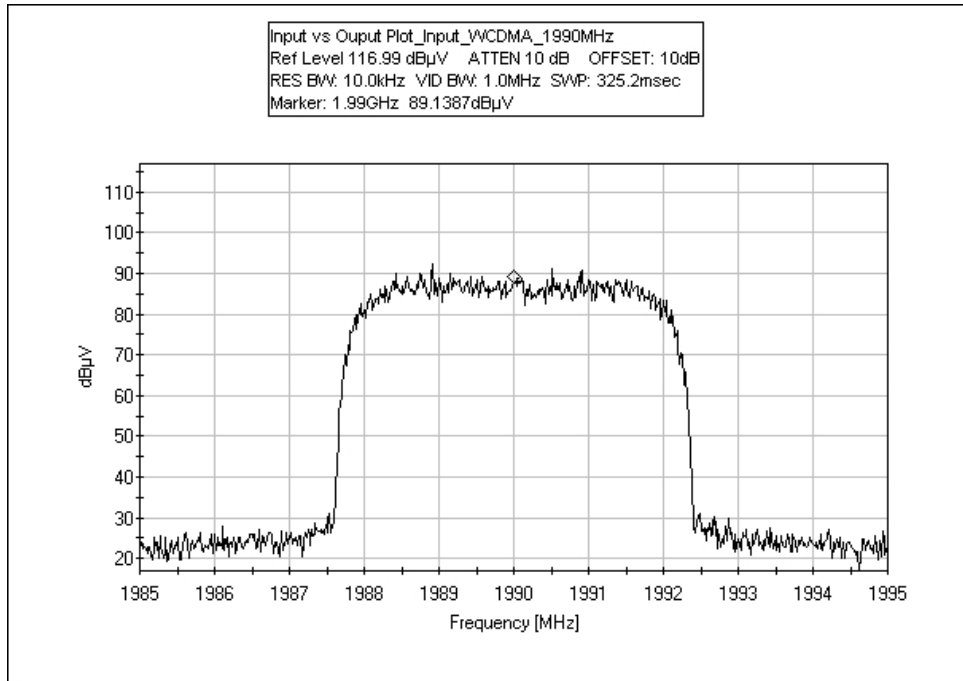

WCDMA – 1990 MHz Input

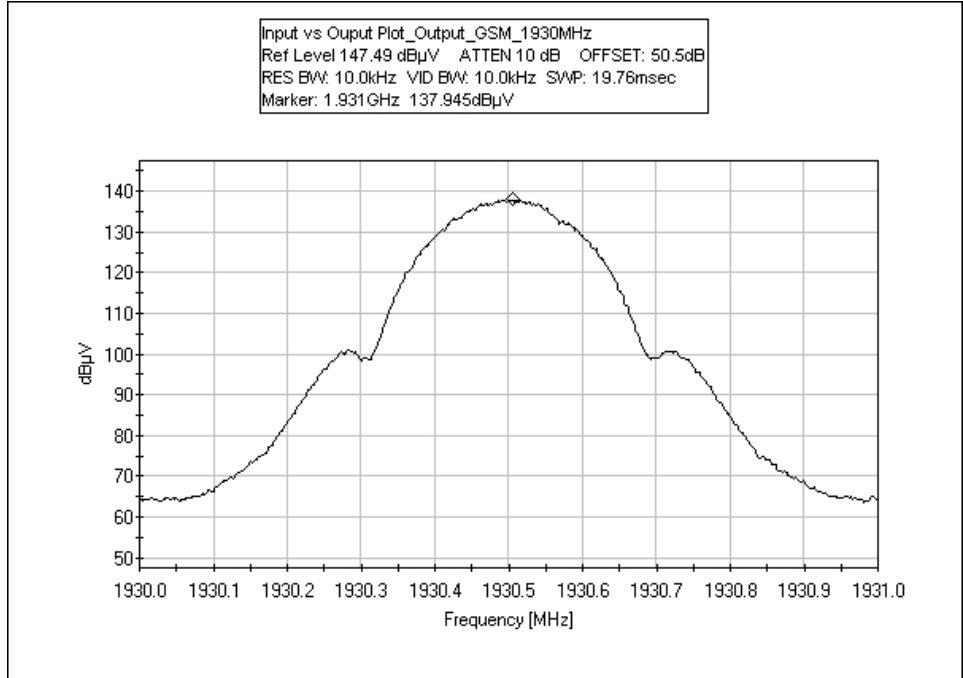

GSM – 1930 MHz Output

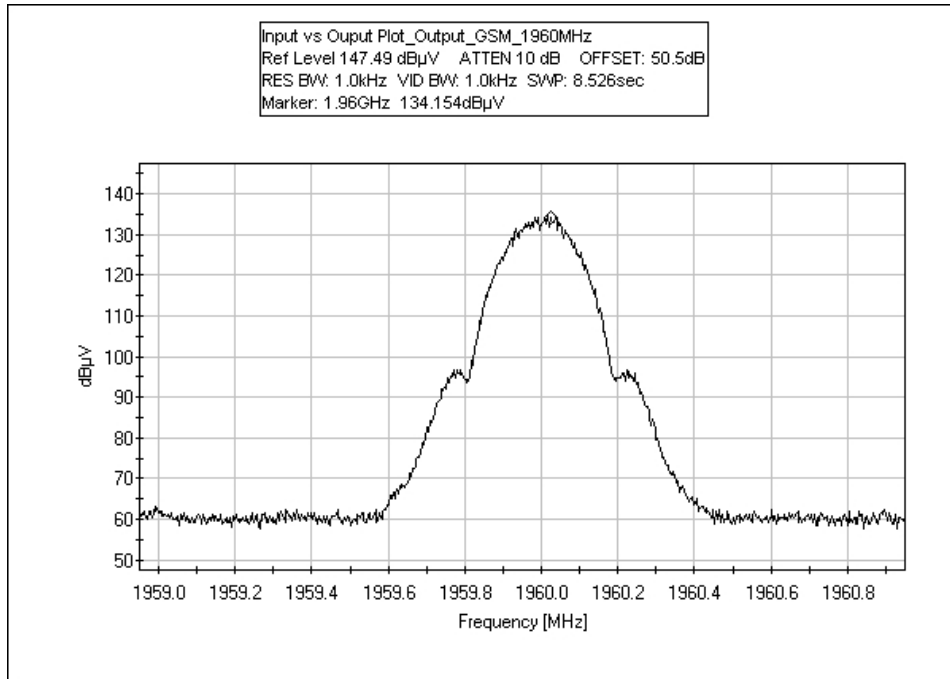

GSM – 1960 MHz Output

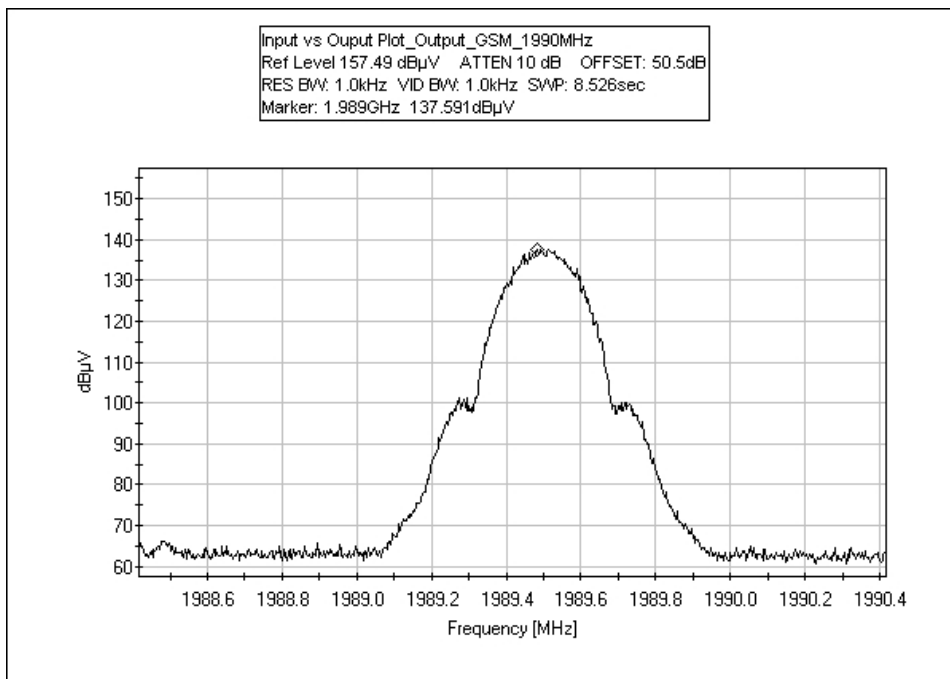

GSM – 1990 MHz Output

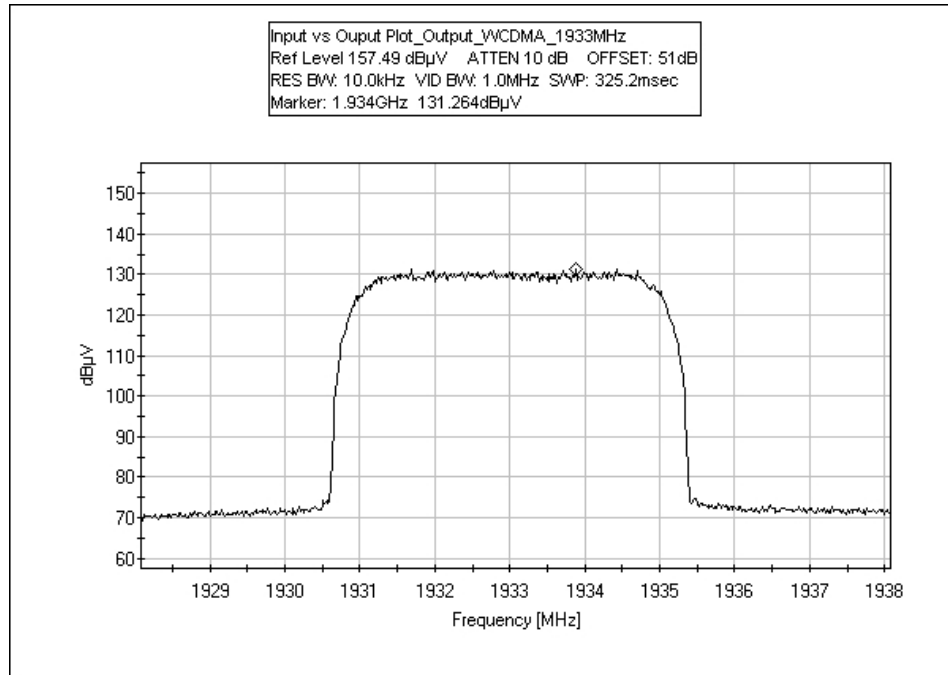

WCDMA – 1933 MHz Output

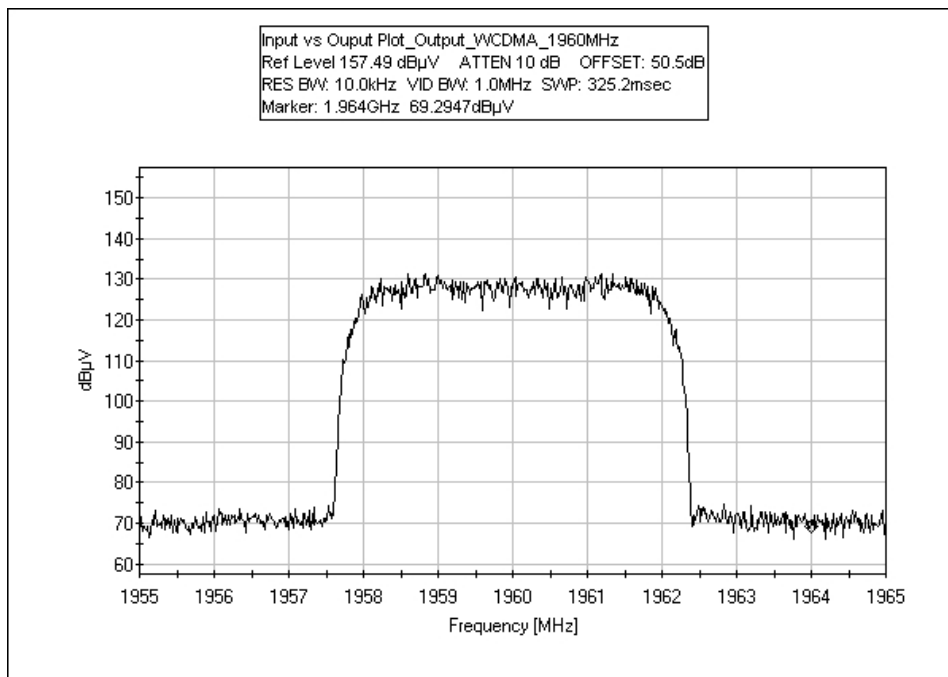

WCDMA – 1960 MHz Output

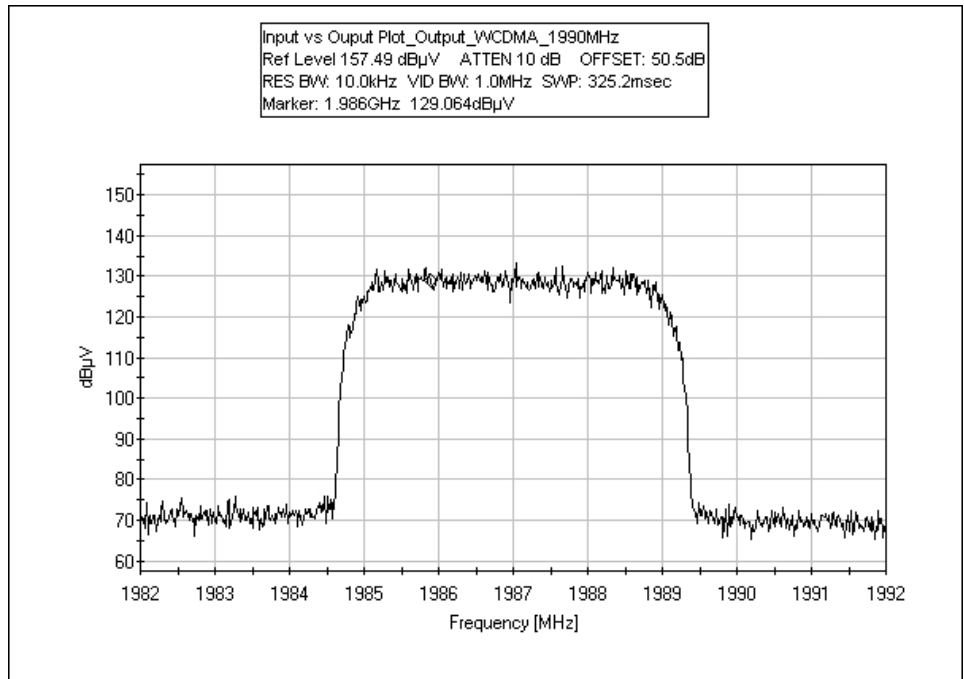

WCDMA – 1990 MHz Output

Test Setup Photos



2.1033(c)(14)/2.1051/24.238(a) - Spurious Emissions at Antenna Terminal

Limit Line for Spurious Conducted Emission

$$\text{Required Attenuation} = 43 + 10 \text{ Log } P \text{ dB}$$

$$\text{Limit line (dBuV)} = V_{\text{dBuV}} - \text{Attenuation}$$

$$\begin{aligned} V_{\text{dBuV}} &= 20 \text{ Log } \frac{V}{1 \times 10^{-6}} \\ &= 20 (\text{Log } V - \text{Log } 1 \times 10^{-6}) \\ &= 20 \text{ Log } V - 20 \text{ Log } 1 \times 10^{-6} \\ &= 20 \text{ Log } V - 20 (-6) \\ &= 20 \text{ Log } V + 120 \end{aligned}$$

$$\begin{aligned} \text{Attenuation} &= 43 + 10 \text{ Log } P \\ &= 43 + 10 \text{ Log } \frac{V^2}{R} \\ &= 43 + 10 (\text{Log } V^2 - \text{Log } R) \\ &= 43 + 10 (2 \text{ Log } V - \text{Log } R) \\ &= 43 + 20 \text{ Log } V - 10 \text{ Log } R \end{aligned}$$

$$\begin{aligned} \text{Limit line} &= V_{\text{dBuV}} - \text{Attenuation} \\ &= 20 \text{ Log } V + 120 - (43 + 20 \text{ Log } V - 10 \text{ Log } R) \\ &= 20 \text{ Log } V + 120 - 43 - 20 \text{ Log } V + 10 \text{ Log } R \\ &= 20 \text{ Log } V + 120 - 43 - 20 \text{ Log } V + 10 \text{ Log } R \\ &= 120 - 43 + 10 \text{ Log } 50 \quad \text{Note : } R = 50 \Omega \\ &= 120 - 43 + 16.897 \\ &= 94 \text{ dBuV at any power level} \end{aligned}$$

Test Data

Test Location: CKC Laboratories, Inc • 110 N. Olinda Place • Brea, CA 92823 • (714) 993-6112

Customer: **Powerwave Technologies**
 Specification: **FCC 24.238 (a) Conducted Spurious Emission**
 Work Order #: **87766** Date: 7/14/2010
 Test Type: **Conducted Emissions** Time: 13:13:52
 Equipment: **Nexus Dual Band Repeater** Sequence#: 2
 Manufacturer: Powerwave Technologies, Inc. Tested By: E. Wong
 Model: RH304022/13B 110V 60Hz
 S/N: NA

Test Equipment:

ID	Asset #	Description	Model	Calibration Date	Cal Due Date
	AN02672	Spectrum Analyzer	E4446A	7/23/2008	7/23/2010
	AN03174	Cable	16301	10/28/2009	10/28/2011
	AN02744	High Pass Filter	11SH10-3000/T10000-O/O	3/5/2010	3/5/2012

Equipment Under Test (* = EUT):

Function	Manufacturer	Model #	S/N
Nexus Dual Band Repeater*	Powerwave Technologies, Inc.	RH304022/13B	NA

Support Devices:

Function	Manufacturer	Model #	S/N
Pre Amp	Minicircuit	ZHL4240 SAM	D092397-19
Optical Converter Module	Powerwave Technologies, Inc	NA	NA
Signal generator	Aeroflex	IFR343B3	3410051078
Spectrum Analyzer	Agilent	8561EC	3946A00167

Test Conditions / Notes:

The EUT is placed on the wooden table. The RF Output port is connected to a load string. The optical in port is connected to a support Optical converter. The support optical converter receives RF signal, converts the signal to optic and sends to the EUT. The EUT decodes the optical signal, and generates an RF signal.
 Power = 43dBm=20 watt
 RF output port Service 1
 Operating range: 1930-1990MHz.
 Modulation: GSM
 Freq = 1930.5MHz , 1960MHz, 1989.5 MHz
 Modulation: WCDMA (3GPP)
 Freq = 1933MHz , 1960MHz, 1987 MHz
 The insertion loss of the RF attenuator was measured and compensated as measurement offset of the spectrum analyzer.
 24°C, 45% relative humidity
 Frequency range of measurement = 9 kHz- 20 GHz.
 Frequency 9 kHz - 150 kHz RBW=200 Hz, VBW=200 Hz; 150 kHz- 30 MHz RBW=9 kHz, VBW=9 kHz; 30 MHz- 1000 MHz RBW=120 kHz, VBW=120 kHz; 1000 MHz-20,000 MHz RBW=1 MHz, VBW=1 MHz.
 Detection was performed with the aid of High Pass Filter at the required resolution bandwidth.
No Emission found.

Test Setup Photos



2.1033(c)(14)/2.1053/24.238(a) - Field Strength of Spurious Radiation

Limit Line for Spurious Conducted Emission

Required Attenuation = 43+10 Log P (dB)

For radiated spurious emission measured at 3 meter test distance,

Required attenuation = 43+10 Log P_{t at 3 meter} dB
 Limit line (dBuV) = E_{dBuV} - Attenuation

E_{dBuV} = Measured field strength at 3 meter in dBuV/m

Power Density (Isotropic)

$$P_D = \frac{P_t}{4\pi r^2}$$

P_D = Power Density in Watts /m²
 P_t = Average Transmit Power
 r = Test distance

Field Intensity E (V/m)

$$E = \sqrt{P_D \times 377}$$

$$E = \frac{\sqrt{P_t \times 377}}{4\pi r^2}$$

$$E = \sqrt{\frac{P_t \times 30}{r^2}}$$

$$P_t = \left(\frac{E^2 \times r^2}{30} \right)$$

10 Log P_t = 10 Log E² (V/m) + 10 Log r² - 10 Log 30

10 Log P_t = 20 Log E (V/m) + 20 Log r - 10 Log 30

At 3 meter, r = 3 m

$$10 \text{ Log } P_t = 20 \text{ Log } E \text{ (V/m)} + 20 \text{ Log } 3 - 10 \text{ Log } 30$$

$$10 \text{ Log } P_t = 20 \text{ Log } E \text{ (V/m)} + 9.54 - 14.77$$

$$10 \text{ Log } P_t = 20 \text{ Log } E \text{ (V/m)} - 5.23$$

$$\text{Since } 20 \text{ Log } E \text{ (V/m)} = 20 \text{ Log } E \text{ (uV/m)} - 120$$

$$10 \text{ Log } P_t = 20 \text{ Log } E \text{ (uV/m)} - 120 - 5.23$$

$$10 \text{ Log } P_t = 20 \text{ Log } E \text{ (uV/m)} - 125.23$$

$$\begin{aligned} \text{Limit line (dBuV) at 3 meter} &= E_{\text{dBuV}} - \text{Attenuation} \\ &= E_{\text{dBuV}} - (43 + 10 \text{ Log } P_{t \text{ at 3 meter}}) \\ &= E_{\text{dBuV}} - 43 - 10 \text{ Log } P_{t \text{ at 3 meter}} \\ &= E_{\text{dBuV}} - 43 - (20 \text{ Log } E \text{ (uV/m)} - 125.23) \\ &= E_{\text{dBuV}} - 43 - 20 \text{ Log } E \text{ (uV/m)} + 125.23 \\ &= E_{\text{dBuV}} - 20 \text{ Log } E \text{ (uV/m)} + 82.23 \end{aligned}$$

$$\text{Since } 20 \text{ Log } E \text{ (uV/m)} = E \text{ in dBuV/m}$$

$$= E_{\text{dBuV}} - E_{\text{dBuV}} + 82.23$$

$$\text{Radiated Emission limit 3 meter} = 82.23 \text{ dBuV at any power level measured in dBuV}$$

Test Data

Test Location: CKC Laboratories, Inc • 110 N. Olinda Place • Brea, CA 92823 • (714) 993-6112

Customer: **Powerwave Technologies**
 Specification: **FCC 24.238 Radiated Spurious Emission**
 Work Order #: **87766** Date: 7/13/2010
 Test Type: **Radiated Scan** Time: 14:53:40
 Equipment: **Nexus Dual Band Repeater** Sequence#: 2
 Manufacturer: Powerwave Technologies, Inc. Tested By: E. Wong
 Model: RH304022/13B
 S/N: NA

Test Equipment:

ID	Asset #	Description	Model	Calibration Date	Cal Due Date
	AN02672	Spectrum Analyzer	E4446A	7/23/2008	7/23/2010
	AN01995	Biconilog Antenna	CBL6111C	3/8/2010	3/8/2012
	AN00309	Preamp	8447D	5/7/2010	5/7/2012
	ANP05050	Cable	RG223/U	4/16/2009	4/16/2011
	ANP05198	Cable	8268	1/5/2009	1/5/2011
T1	AN00786	Preamp	83017A	7/28/2008	7/28/2010
T2	AN00849	Horn Antenna	3115	4/23/2010	4/23/2012
T3	AN02948	Cable	32022-2-2909K-24TC	9/21/2009	9/21/2011
T4	ANP05565	Cable	ANDL-1-PNMN-54	9/4/2008	9/4/2010
T5	AN02744	High Pass Filter	11SH10-3000/T10000-O/O	3/5/2010	3/5/2012
	AN01413	Horn Antenna	84125-80008	11/13/2008	11/13/2010
	AN00314	Loop Antenna	6502	6/30/2010	6/30/2012

Equipment Under Test (* = EUT):

Function	Manufacturer	Model #	S/N
Nexus Dual Band Repeater*	Powerwave Technologies, Inc.	RH304022/13B	NA

Support Devices:

Function	Manufacturer	Model #	S/N
Pre Amp	Minicircuit	ZHL4240 SAM	D092397-19
Optical Converter Module	Powerwave Technologies, Inc	NA	NA
Signal Generator	Aeroflex	IFR343B3	3410051078
Spectrum Analyzer	Agilent	8561EC	3946A00167

Test Conditions / Notes:

The EUT is placed on the wooden table. The RF Output port is connected to a load string. The optical in port is connected to a support Optical converter. The support optical converter receives the RF signal, converts the signal to optic and sends it to the EUT. The EUT decodes the optical signal, and generates an RF signal.
 Power = 43dBm=20 watt
 RF output port Service 1
 Operating range: 1930-1990MHz.
 Modulation: GSM
 Freq = 1930.5MHz , 1960MHz, 1989.5 MHz
 24°C, 45% relative humidity
 Frequency range of measurement = 9 kHz- 20 GHz.
 Frequency 9 kHz - 150 kHz RBW=200 Hz, VBW=200 Hz; 150 kHz- 30 MHz RBW=9 kHz, VBW=9 kHz; 30 MHz- 1000 MHz RBW=120 kHz, VBW=120 kHz; 1000 MHz-20,000 MHz RBW=1 MHz, VBW=1 MHz.

Ext Attn: 0 dB

Measurement Data:

Reading listed by margin.

Test Distance: 3 Meters

#	Freq MHz	Rdng dBμV	T1 T5 dB	T2 dB	T3 dB	T4 dB	Dist Table	Corr dBμV/m	Spec dBμV/m	Margin dB	Polar Ant
1	5879.833M Ave	57.6	-36.5 +0.4	+34.5	+0.7	+6.3	+0.0	63.0	82.3	-19.3	Horiz
^	5879.833M	60.5	-36.5 +0.4	+34.5	+0.7	+6.3	+0.0	65.9	82.3	-16.4	Horiz
3	5791.533M Ave	57.4	-36.5 +0.4	+34.5	+0.7	+6.2	+0.0	62.7	82.3	-19.6	Horiz
^	5791.533M	60.1	-36.5 +0.4	+34.5	+0.7	+6.2	+0.0	65.4	82.3	-16.9	Horiz
5	15679.833 M	37.8	-34.5 +0.7	+41.3	+1.4	+11.8	+0.0	58.5	82.3	-23.8	Horiz
6	5968.433M Ave	52.8	-36.4 +0.5	+34.5	+0.7	+6.3	+0.0	58.4	82.3	-23.9	Horiz
^	5968.433M	56.4	-36.4 +0.5	+34.5	+0.7	+6.3	+0.0	62.0	82.3	-20.3	Horiz
8	7722.067M Ave	49.6	-36.4 +0.2	+36.1	+0.9	+7.0	+0.0	57.4	82.3	-24.9	Horiz
^	7722.067M	54.1	-36.4 +0.2	+36.1	+0.9	+7.0	+0.0	61.9	82.3	-20.4	Horiz
10	15442.830 M	36.3	-34.6 +0.9	+41.4	+1.4	+11.7	+0.0	57.1	82.3	-25.2	Horiz
11	7839.833M	48.3	-36.4 +0.2	+36.5	+0.9	+7.0	+0.0	56.5	82.3	-25.8	Horiz
12	5791.392M	50.3	-36.5 +0.4	+34.5	+0.7	+6.2	+0.0	55.6	82.3	-26.7	Vert
13	5879.925M	49.2	-36.5 +0.4	+34.5	+0.7	+6.3	+0.0	54.6	82.3	-27.7	Vert
14	5968.483M	48.8	-36.4 +0.5	+34.5	+0.7	+6.3	+0.0	54.4	82.3	-27.9	Vert
15	13512.830 M	36.5	-35.2 +0.7	+39.7	+1.3	+10.2	+0.0	53.2	82.3	-29.1	Horiz

16	9799.833M	41.8	-36.6 +0.4	+37.5	+1.0	+8.4	+0.0	52.5	82.3	-29.8	Horiz
17	7722.208M	44.7	-36.4 +0.2	+36.1	+0.9	+7.0	+0.0	52.5	82.3	-29.8	Vert
18	7958.000M	43.2	-36.5 +0.2	+36.8	+0.9	+7.1	+0.0	51.7	82.3	-30.6	Horiz
19	9652.400M	40.4	-36.5 +0.6	+37.7	+1.0	+8.4	+0.0	51.6	82.3	-30.7	Horiz
20	11759.833 M	38.7	-35.9 +0.3	+36.7	+1.1	+9.7	+0.0	50.6	82.3	-31.7	Horiz
21	11582.830 M	38.0	-35.9 +0.5	+36.4	+1.1	+9.6	+0.0	49.7	82.3	-32.6	Horiz
22	3919.850M	48.9	-37.3 +0.4	+31.8	+0.6	+5.0	+0.0	49.4	82.3	-32.9	Horiz
23	9947.500M	38.7	-36.6 +0.5	+37.3	+1.0	+8.5	+0.0	49.4	82.3	-32.9	Horiz
24	7839.850M	40.8	-36.4 +0.2	+36.5	+0.9	+7.0	+0.0	49.0	82.3	-33.3	Vert
25	9799.850M	37.2	-36.6 +0.4	+37.5	+1.0	+8.4	+0.0	47.9	82.3	-34.4	Vert
26	9652.208M	36.5	-36.5 +0.6	+37.7	+1.0	+8.4	+0.0	47.7	82.3	-34.6	Vert
27	3978.967M	46.5	-37.2 +0.3	+32.0	+0.6	+5.0	+0.0	47.2	82.3	-35.1	Horiz
28	9947.517M	35.3	-36.6 +0.5	+37.3	+1.0	+8.5	+0.0	46.0	82.3	-36.3	Vert
29	3919.925M	45.0	-37.3 +0.4	+31.8	+0.6	+5.0	+0.0	45.5	82.3	-36.8	Vert
30	3860.892M	45.0	-37.3 +0.4	+31.7	+0.6	+4.9	+0.0	45.3	82.3	-37.0	Vert
31	3861.000M Ave	43.7	-37.3 +0.4	+31.7	+0.6	+4.9	+0.0	44.0	82.3	-38.3	Horiz
^	3861.000M	50.2	-37.3 +0.4	+31.7	+0.6	+4.9	+0.0	50.5	82.3	-31.8	Horiz
33	3978.800M	42.9	-37.2 +0.3	+32.0	+0.6	+5.0	+0.0	43.6	82.3	-38.7	Vert

CKC Laboratories, Inc Date: 7/13/2010 Time: 14:53:40 Powerwave Technologies WO#: 87766
 FCC 24.238 Radiated Spurious Emission Test Distance: 3 Meters Sequence#: 2 Ext ATTN: 0 dB

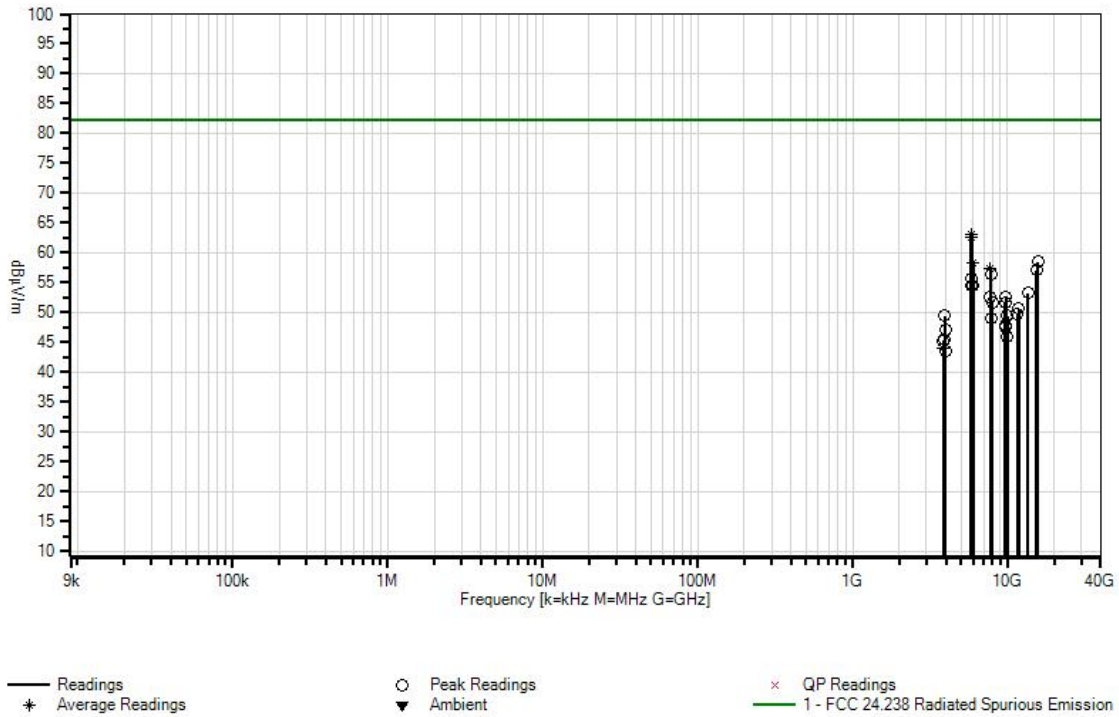

Test Setup Photos



24.238(a) – Block Edge

Engineer Name: E. Wong

Test Equipment				
Name	Serial	Cal Date	Cal Due	Asset
Spectrum Analyzer	US44300438	07/23/08	07/23/10	02672
36" 40GHz cable	NA	10/28/09	10/28/11	03174

Test Setup

The EUT is placed on the wooden table. The RF Output port is connected to a load string. The optical in port is connected to a support Optical converter. The support optical converter receives RF signal, converts the signal to optic and sends to the EUT. The EUT decodes the optical signal, and generates an RF signal.

Block edge plot is recorded with a spectrum analyzer at the Antenna port of the device. The insertion loss of the RF attenuator was measured and compensated as measurement offset of the spectrum analyzer.

RF output port Service 1
 Operating range: 1930-1990MHz.

Modulation: GSM
 Freq = 1930.5MHz, 1960MHz, 1989.5 MHz

Modulation: WCDMA (3GPP)
 Freq = 1933MHz, 1960MHz, 1987 MHz

Notes: 1) Block edge plot of GSM signal was presented using Adjacent channel power function of the spectrum analyzer where emission is measured with narrow resolution bandwidth and the power is integrated and presented in 1 MHz band. 2) Block edge plot of WCSMA (3GPP) signal was measured with 1 MHz resolution bandwidth, then at 100kHz with applicable bandwidth correction applied.

Test Data

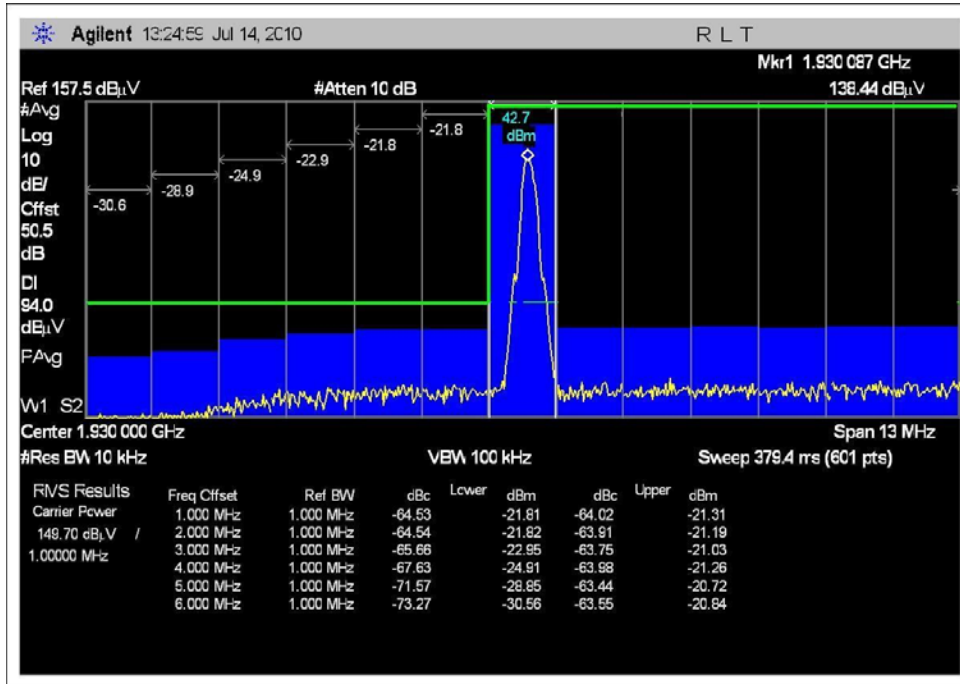

GSM – 1930MHz

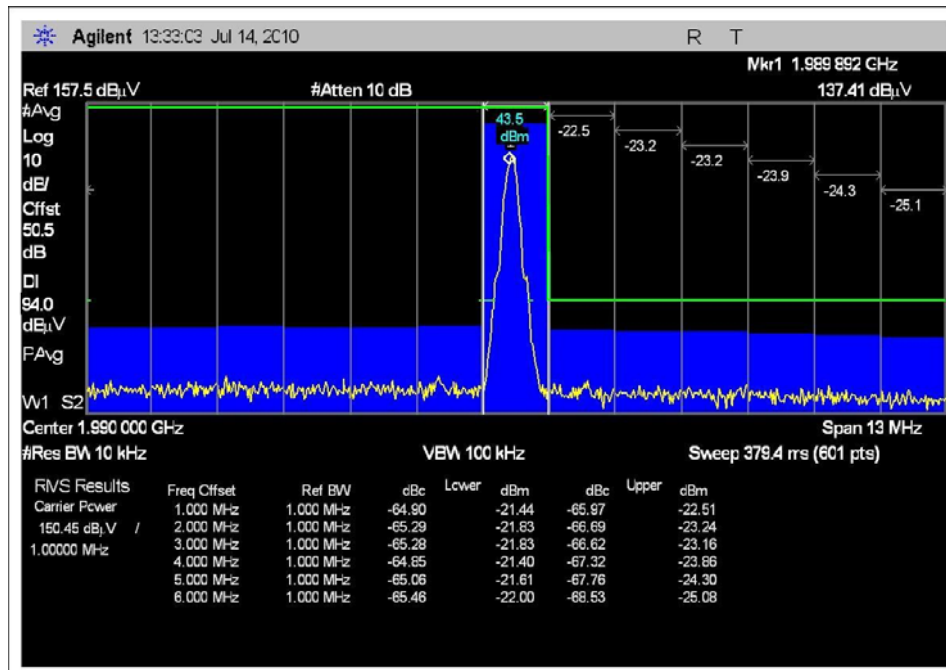

GSM – 1990 MHz

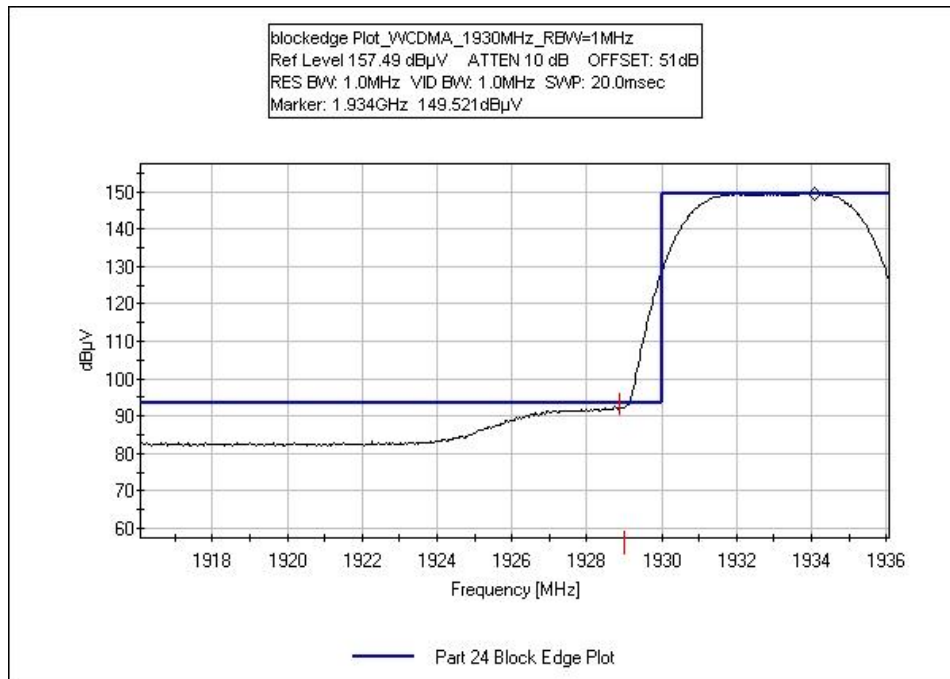

WCDMA – 1930 MHz @ 1MHz

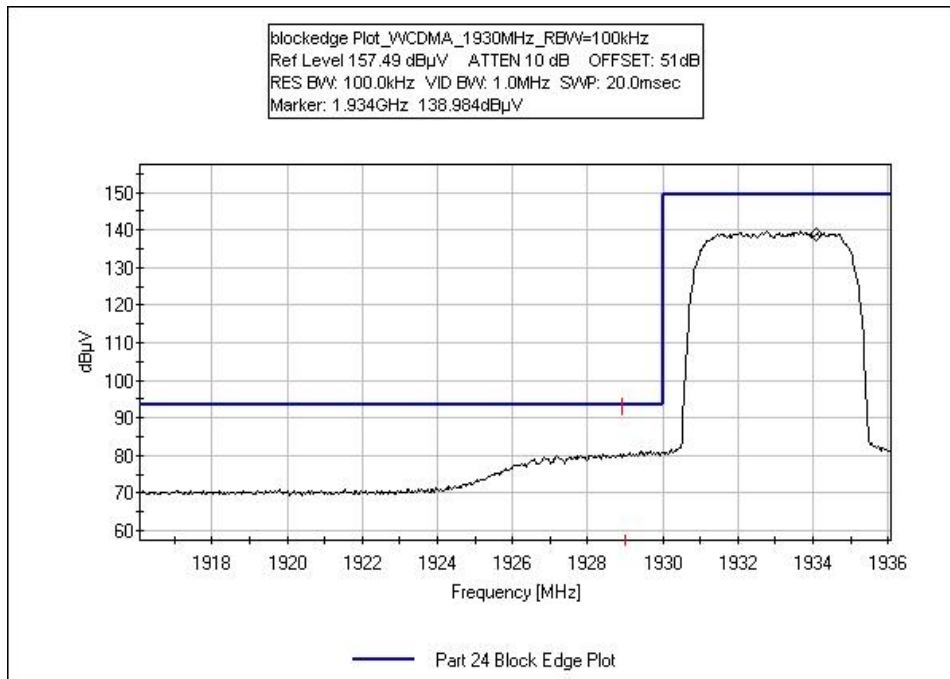

WCDMA – 1930 MHz @ 100 kHz

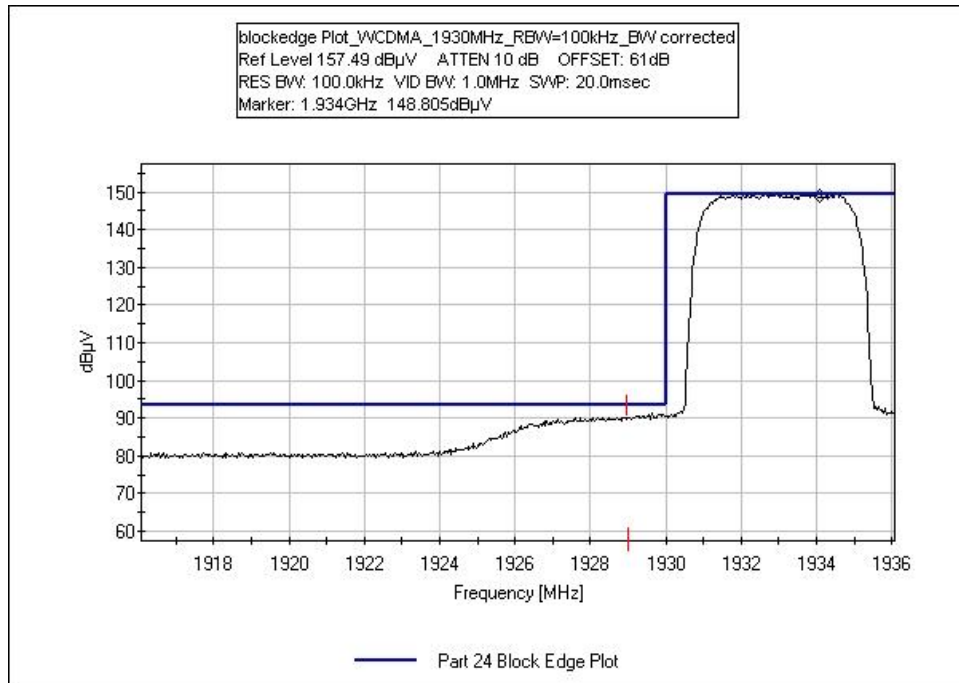

WCDMA – 1930 MHz @ 100 kHz BW Corrected

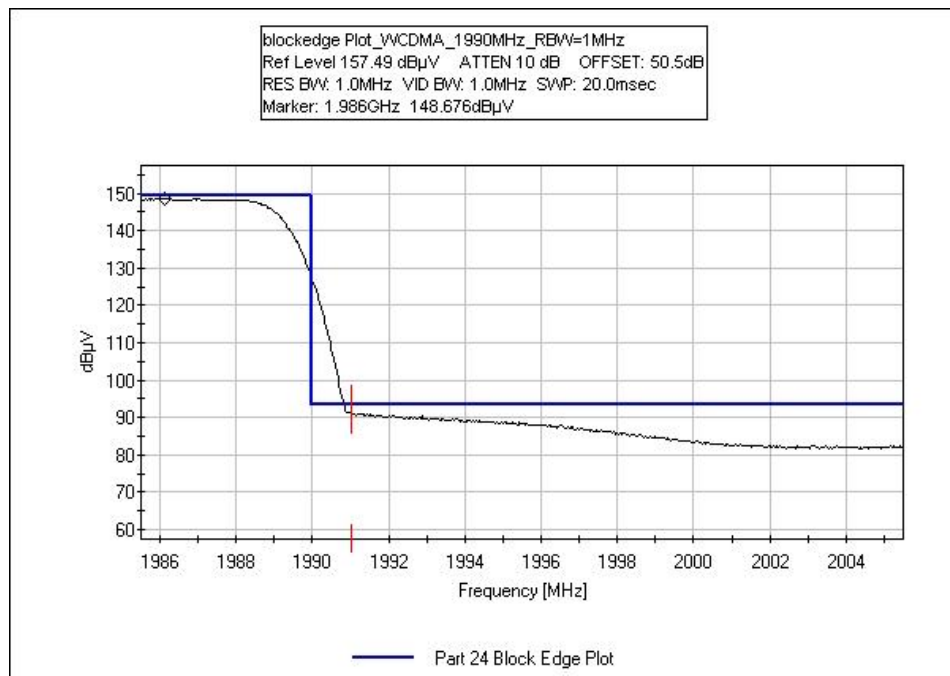

WCDMA – 1990 MHz @ 1MHz

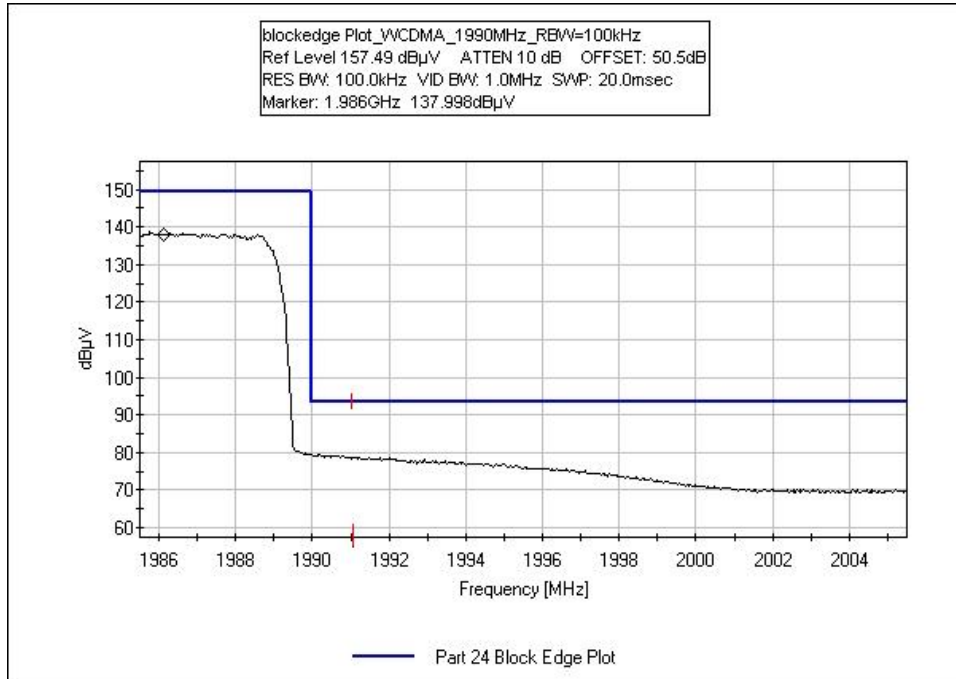

WCDMA – 1990 MHz @ 100 kHz

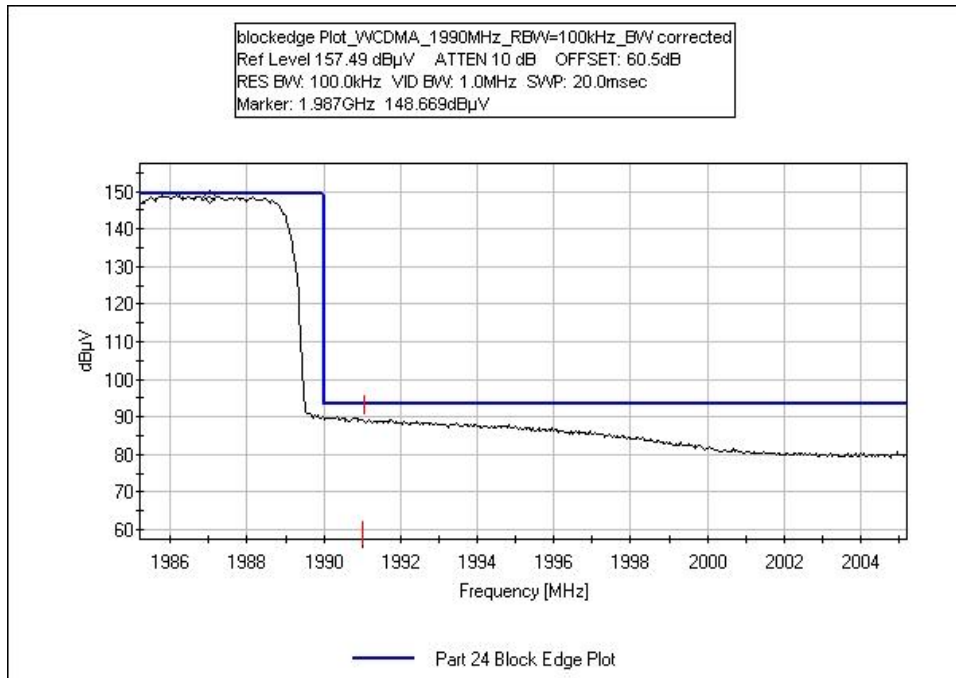

WCDMA – 1990 MHz @ 100 kHz BW Corrected

Test Setup Photos



2-11-01/EAB/RF – Out of Band Rejection

Engineer Name: E. Wong

Test Equipment				
Name	Serial	Cal Date	Cal Due	Asset
Network Analyzer	Us38432770	09/12/08	09/12/10	C00012

Test Setup

The EUT is placed on the wooden table. The RF Output port is connected to a load string. The optical in port is connected to a support Optical converter. The support optical converter receives RF signal, converts the signal to optic and sends to the EUT. The EUT decodes the optical signal, and generates an RF signal.

To measure the System RF gain, the reference was established at the input of the RF amplifier section, by- passing the optical convertor. The Out of band Rejection plot is captured with a Network Analyzer.

Test Data

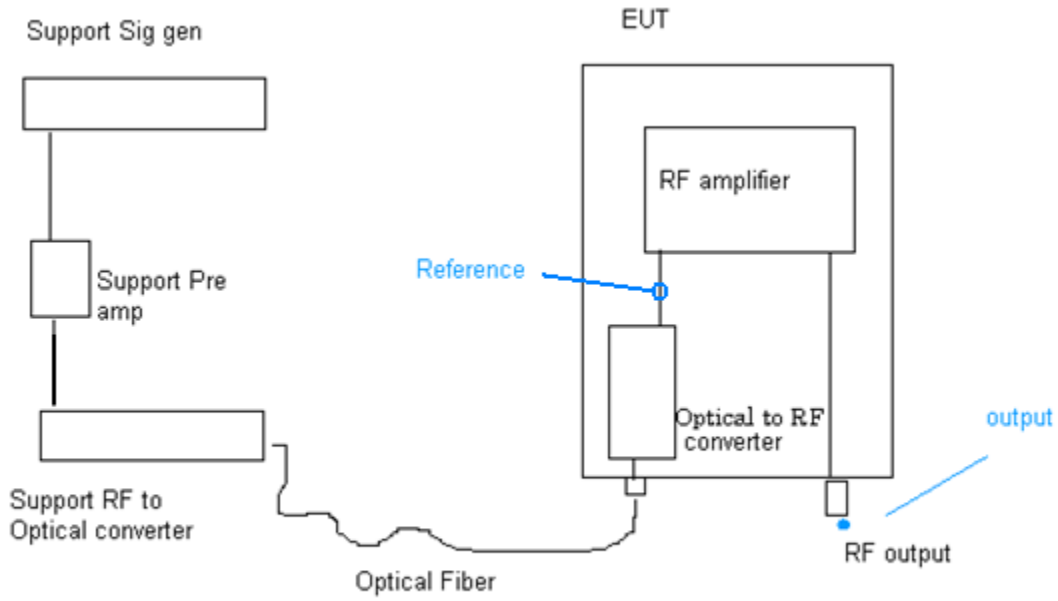

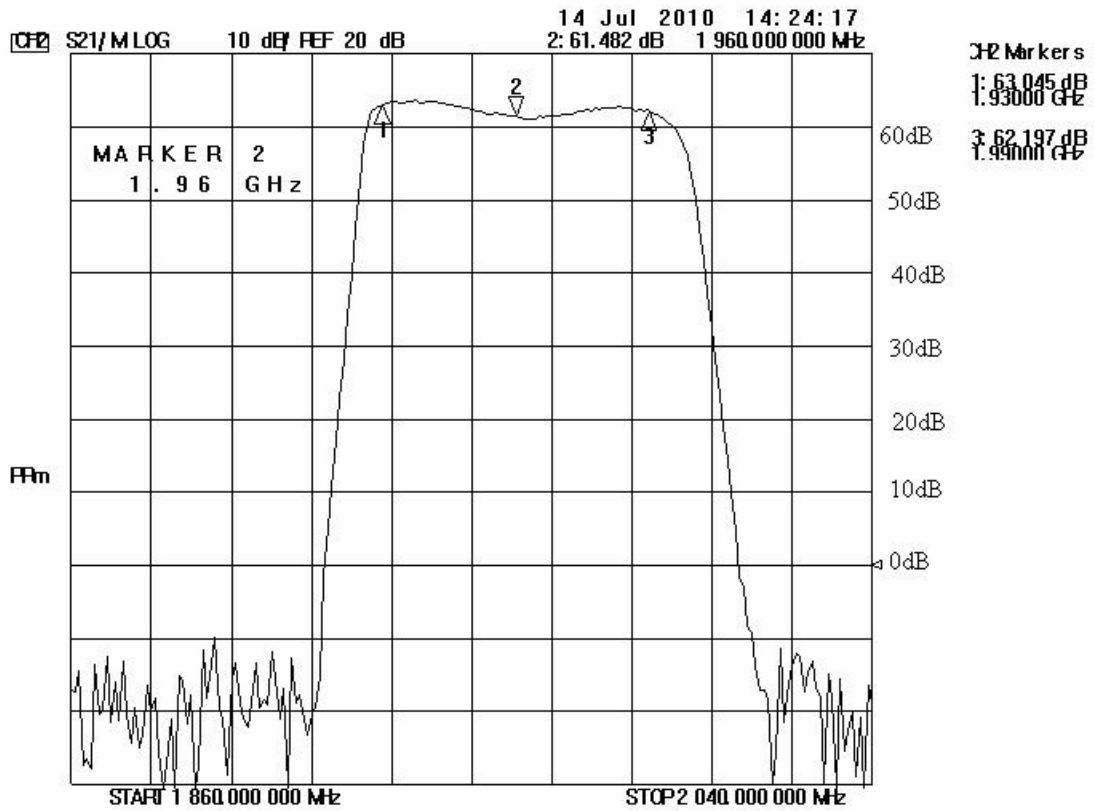

Test Setup Photos



SUPPLEMENTAL INFORMATION

Measurement Uncertainty

Uncertainty Value	Parameter
4.73 dB	Radiated Emissions
3.34 dB	Mains Conducted Emissions
3.30 dB	Disturbance Power

The reported measurement uncertainties are calculated based on the worst case of all laboratory environments from CKC Laboratories, Inc. test sites. Only those parameters which require estimation of measurement uncertainty are reported. The reported worst case measurement uncertainty is less than the maximum values derived in CISPR 16-4-2. Reported uncertainties represent expanded uncertainties expressed at approximately the 95% confidence level using a coverage factor of k=2. Compliance is deemed to occur provided measurements are below the specified limits.

Emissions Test Details

TESTING PARAMETERS

The cables were routed consistent with the typical application by varying the configuration of the test sample. Interface cables were connected to the available ports of the test unit. The effect of varying the position of the cables was investigated to find the configuration that produced maximum emissions. Cables were of the type and length specified in the individual requirements. The length of cable that produced maximum emissions was selected.

The equipment under test (EUT) was set up in a manner that represented its normal use, as shown in the setup photographs. Any special conditions required for the EUT to operate normally are identified in the comments that accompany the emissions tables.

The emissions data was taken with a spectrum analyzer or receiver. Incorporating the applicable correction factors for distance, antenna, cable loss and amplifier gain, the data was reduced as shown in the table below. The corrected data was then compared to the applicable emission limits. Preliminary and final measurements were taken in order to ensure that all emissions from the EUT were found and maximized.

CORRECTION FACTORS

The basic spectrum analyzer reading was converted using correction factors as shown in the highest emissions readings in the tables. For radiated emissions in dBμV/m, the spectrum analyzer reading in dBμV was corrected by using the following formula. This reading was then compared to the applicable specification limit.

SAMPLE CALCULATIONS		
	Meter reading	(dB μ V)
+	Antenna Factor	(dB)
+	Cable Loss	(dB)
-	Distance Correction	(dB)
-	Preamplifier Gain	(dB)
=	Corrected Reading	(dB μ V/m)

TEST INSTRUMENTATION AND ANALYZER SETTINGS

The test instrumentation and equipment listed were used to collect the emissions data. A spectrum analyzer or receiver was used for all measurements. For testing emissions, an appropriate reference level and a vertical scale size of 10 dB per division were used.

SPECTRUM ANALYZER/RECEIVER DETECTOR FUNCTIONS

The notes that accompany the measurements contained in the emissions tables indicate the type of detector function used to obtain the given readings. Unless otherwise noted, all readings were made in the "Peak" mode. Whenever a "Quasi-Peak" or "Average" reading is listed as one of the highest readings, this is indicated as a "QP" or an "Ave" on the appropriate rows of the data sheets. The following paragraphs describe in more detail the detector functions and when they were used to obtain the emissions data.

Peak

In this mode, the spectrum analyzer/receiver readings recorded all emissions at their peak value as the frequency band selected was scanned. By combining this function with another feature of the measuring device called "peak hold," the measuring device had the ability to measure transients or low duty cycle transient emission peak levels. In this mode the measuring device made a slow scan across the frequency band selected and measured the peak emission value found at each frequency across the band.

Quasi-Peak

When the true peak values exceeded or were within 2 dB of the specification limit, quasi-peak measurements were taken using the quasi-peak detector.

Average

For certain frequencies, average measurements may be made using the spectrum analyzer/receiver. To make these measurements, the test engineer reduces the video bandwidth on the measuring device until the modulation of the signal is filtered out. At this point the measuring device is set into the linear mode and the scan time is reduced.