



**FCC CFR47 PART 22 CERTIFICATION  
TEST REPORT**

**FOR**

**869-894MHz SINGLE-CHANNEL GSM/EDGE AMPLIFIER**

**MODEL: SCA9350-30**

**FCC ID: E675JS0057**

**REPORT NUMBER: 01U1077**

**ISSUE DATE: DECEMBER 20, 2001**

*Prepared for*

**POWERWAVE TECHNOLOGIES, INC.  
1801 E. St. ANDREW PLACE  
SANTA ANA, CA 92705 USA**

*Prepared by*

**COMPLIANCE CERTIFICATION SERVICES, INC.  
561 F MONTEREY ROAD  
MORGAN HILL, CA 95037 USA  
TEL: 408-463-0885  
FAX: 408-463-0888**

---

<b>TABLE OF CONTENTS</b>	<b>PAGE</b>
<b>1. FCC CERTIFICATION INFORMATION .....</b>	<b>3</b>
<b>2. TEST FACILITY .....</b>	<b>4</b>
<b>3. ACCREDITATION AND LISTING .....</b>	<b>4</b>
<b>4. MEASUREMENT INSTRUMENTATION.....</b>	<b>4</b>
<b>5. MEASURING INSTRUMENT CALIBRATION.....</b>	<b>4</b>
<b>6. UNITS OF MEASUREMENT .....</b>	<b>5</b>
<b>7. EQUIPMENT MODIFICATIONS.....</b>	<b>5</b>
<b>8. TEST EQUIPMENT LIST.....</b>	<b>6</b>
<b>9. EUT SETUP PHOTOS .....</b>	<b>7</b>
<b>10. EXTERNAL I/O CABLE CONSTRUCTION DESCRIPTION.....</b>	<b>11</b>
<b>11. CONFIGURATION BLOCK DIAGRAM.....</b>	<b>11</b>
<b>12. PART 2: CERTIFICATION TEST REQUIREMENT:.....</b>	<b>12</b>
SECTION 2.1046: RF POWER OUTPUT .....	12
SECTION 2.1047: MODULATION CHARACTERISTICS.....	18
SECTION 2.1049: OCCUPIED BANDWIDTH .....	18
SECTION 2.1051: SPURIOUS EMISSION AT ANTENNA TERMINALS.....	28
SECTION 2.1055: FREQUENCY STABILITY .....	42
RADIATED EMISSIONS .....	42
<b>ATTACHMENTS .....</b>	<b>51</b>
<b>EUT PHOTOGRAPHS .....</b>	<b>52</b>

**1. FCC CERTIFICATION INFORMATION**

The following information is in accordance with FCC Rules, 47CFR Part2, Subpart J, Sections 2.1033 – 2.1055.

- 2.1033(c)(1) Applicant:** POWERWAVE TECHNOLOGIES, INC.  
 1801 E. St. ANDREW PLACE  
 SANTA ANA, CA 92705
- Contact person:** CLINT LAWRENCE
- Telephone number:** (916) 941-3167
- 2.1033(c)(2) FCC ID:** E675JS0057
- 2.1033(c)(4) Types of Emissions:** G7W (EDGE), GXW (GSM)
- 2.1033(c)(5) Frequency Range:** 869 – 894 MHz
- 2.1033(c)(6) Range of Operation Power:** 33 Watts
- 2.1033(c)(7) Maximum Power Rating:** 33 Watts
- 2.1033(c)(8) DC Voltage and DC Current:** -48Vdc @ 2.9 A; typical

**Section 22.913(a); Maximum ERP.** The effective radiated power (ERP) of base transmitters and cellular repeaters must not exceed 500 Watts.

TYPE OF EQUIPMENT:	CELLULAR AMPLIFIER
MEASUREMENT DISTANCE:	3 METER
TECHNICAL LIMIT:	FCC 22.359, 22.917
FCC RULES:	PART 22
EQUIPMENT AUTHORIZATION PROCEDURE	CERTIFICATION
MODIFICATIONS MADE ON EUT	<input type="checkbox"/> YES (REFER TO PAGE 7) <input checked="" type="checkbox"/> NO

The above equipment was tested by Compliance Certification Services for compliance with the requirements set forth in the FCC CFR 47, PART 22. The results of testing in this report apply to the product/system, which was tested only. Other similar equipment will not necessarily produce the same results due to production tolerance and measurement uncertainties.

TESTED BY:



KERWIN CORPUZ  
 ASSOCIATE EMC ENGINEER  
 COMPLIANCE CERTIFICATION SERVICES

REVIEWED and RELEASED BY:



STEVE CHENG  
 EMC ENGINEERING MANAGER  
 COMPLIANCE CERTIFICATION SERVICES

## 2. TEST FACILITY

The open area test sites and conducted measurement facilities used to collect the radiated data are located at 561F Monterey Road, Morgan Hill, California, USA. The sites are constructed in conformance with the requirements of ANSI C63.7, ANSI C63.4 and CISPR Publication 22.

## 3. ACCREDITATION AND LISTING

The test facilities used to perform radiated and conducted emissions tests are accredited by National Voluntary Laboratory Accreditation Program for the specific scope of accreditation under Lab Code:200065-0 to perform Electromagnetic Interference tests according to FCC PART 15 AND CISPR 22 requirements. No part of this report may be used to claim or imply product endorsement by NVLAP or any agency of the US Government. In addition, the test facilities are listed with Federal Communications Commission (reference no: 31040/SIT (1300B3) and 31040/SIT(1300F2))

## 4. MEASUREMENT INSTRUMENTATION

Radiated emissions were measured with one or more of the following types of linearly polarized antennas: tuned dipole, biconical, log periodic, bi-log, ridged waveguide liner horn. EMI receivers were used for line conducted readings, spectrum analyzers with pre-selectors and quasi-peak detectors were used to perform radiated measurements. Receiving equipment (i.e., receiver, analyzer, quasi-peak adapter, pre-selector) and LISNs conform to CISPR specification for "Radio Interference Measuring Apparatus and Measurement Methods," Publication 16.

Calibrated wideband preamplifiers, coaxial cables, and coaxial attenuators are also used for making measurements.

## 5. MEASURING INSTRUMENT CALIBRATION

The measuring equipment, which was utilized in performing the tests documented herein, has been calibrated in accordance with the manufacturer's recommendations for utilizing calibration equipment, which is traceable to recognized national standards.

## 6. UNITS OF MEASUREMENT

Measurements of radiated interference are reported in terms of dB( $\mu$ V/m) at a specified distance. The indicated readings on the spectrum analyzer were converted to dB( $\mu$ V/m) by use of appropriate conversion factors. Measurements of conducted interference are reported in terms of dB( $\mu$ V).

The field strength is calculated by adding the Antenna Factor and Cable Factors, then by subtracting the Amplifier Gain from the measured reading. The basic equation with a sample calculation is as follows:

$$FS = RA + AF + CF - AG$$

Where            FS = Field Strength  
                    RA = Receiver Amplitude  
                    AF = Antenna Factor  
                    CF = Cable Attenuation Factor  
                    AG = Amplifier Gain

Assume a receiver reading of 52.5 dB $\mu$ V is obtained. The Antenna Factor of 7.4dB/m and a Cable Factor of 1.1dB is added. The Amplifier Gain of 29 dB is subtracted, giving a field strength of 32 dB $\mu$ V/m. The 32 dB $\mu$ V/m value was mathematically converted to its corresponding level in uV/m.

$$FS = 52.5 + 7.4 + 1.1 - 29 = 32 \text{ dB}\mu\text{V/m}$$

$$\text{Level in uV/m} = \text{Common Antilogarithm} [(32 \text{ dB}\mu\text{V/m})/20] = 39.8 \mu\text{V/m}$$

## 7. EQUIPMENT MODIFICATIONS

To achieve compliance for FCC PART 22 requirement, the following change(s) were made during compliance testing:

No changes were required in order to achieve compliance to FCC Part 22.

**8. TEST EQUIPMENT LIST**

Device Type	Manufacturer	Model Number	Serial No.	CAL Due Date
Spectrum Analyzer	HP	8566B	2140A01296	5/4/02
RF Preselector	HP	85685A	2817A00756	5/4/02
Pre-Amp	Miteq	NSP2600-44	646456	4/12/02
Bilog Antenna	Chase EMC Ltd.	CBL6112	2049	8/21/02
Horn Antenna	EMCO	3115	2238	6/20/02
Horn Antenna	EMCO	3115	9001-3245	6/20/02
Signal Generator	HP	83732B	US34490599	3/21/02
EMI Receiver	Rhode Schwarz	ESHS20	827129/006	4/2/02
LISN	FISCHER	FCC-LISN- 50/250-25-2	114	8/8/02
LISN	Solar Elec. Co.	8012-50-R-24- BNC	837990	8/8/02
AC Power Source	ACS	AFC-10K-AFC2	J1568	N/A

**8a. SUPPORT EQUIPMENT**

Device Type	Manufacturer	Model Number	Serial No.	CAL Due Date
SIGNAL GENERATOR	HP	E4431B	US39340352	12/20/02
HIGH POWER ATTENUATOR	NARDA	769.30	04983	N/A
POWER SUPPLY	HP	6032A	3510A-10988	10-31-02
POWER METER	HP	438A	3048U03273	3/29/02
POWER SENSOR	HP	8481A	3318A99301	6/14/02
DIRECTIONAL COUPLER	NARDA	4226-20	02404	N/A

## 9. EUT SETUP PHOTOS

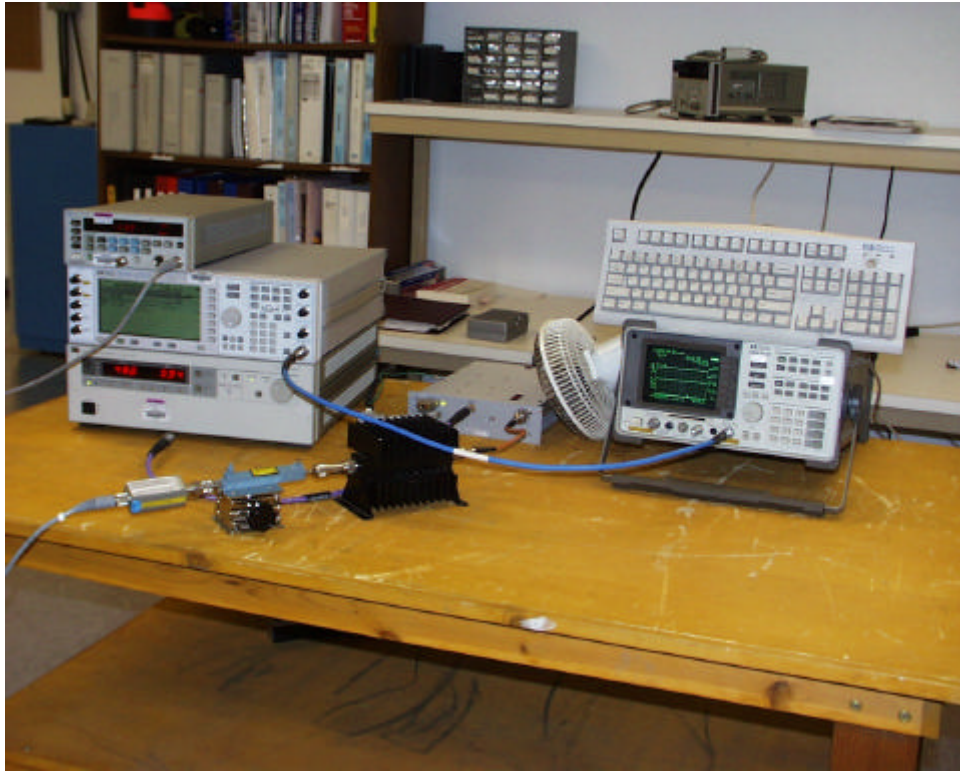

**Occupied Bandwidth Input Setup**

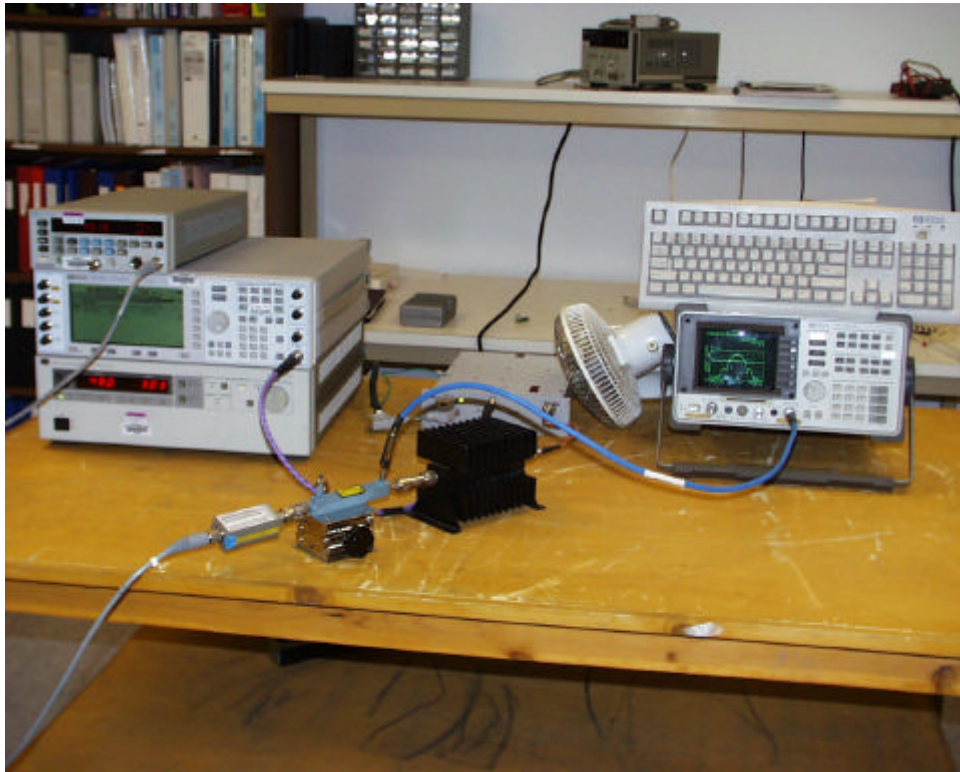

**Occupied Bandwidth Output Setup**



**1 - 9GHz Radiated Emission Setup**





**Substitution Method Setup**

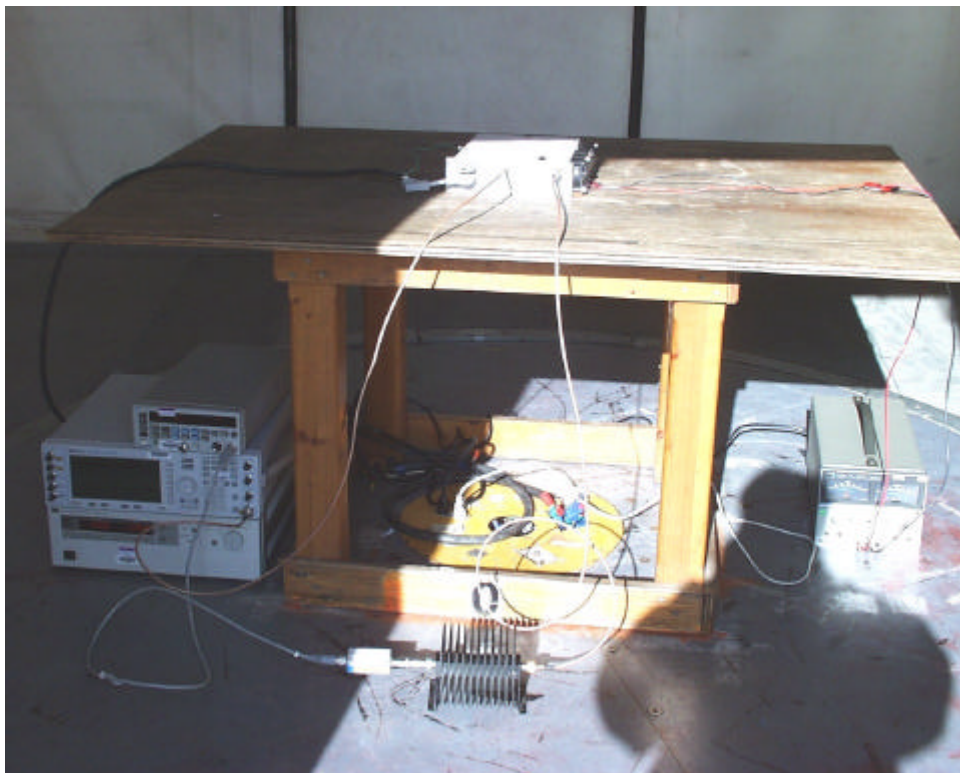

**Part15 front view Radiated Emission Setup**



**Part15 back view Radiated Emission Setup**

**10. EXTERNAL I/O CABLE CONSTRUCTION DESCRIPTION**

CABLE NO: ALL	
<b>I/O Port: INPUTS/OUTPUTS</b>	<b>Number of I/O ports of this type: ALL</b>
<b>Number of Conductors: 2</b>	<b>Connector Type: N TYPE and SMA</b>
<b>Capture Type: SCREW-IN</b>	<b>Type of Cable used: SHIELDED</b>
<b>Cable Connector Type: METAL HOOD</b>	<b>Cable Length: 0.4 ~ 1.5 meter</b>
<b>Bundled During Tests: NO</b>	<b>Data Traffic Generated: YES</b>
<b>Remark: N/A</b>	

**11. CONFIGURATION BLOCK DIAGRAM**

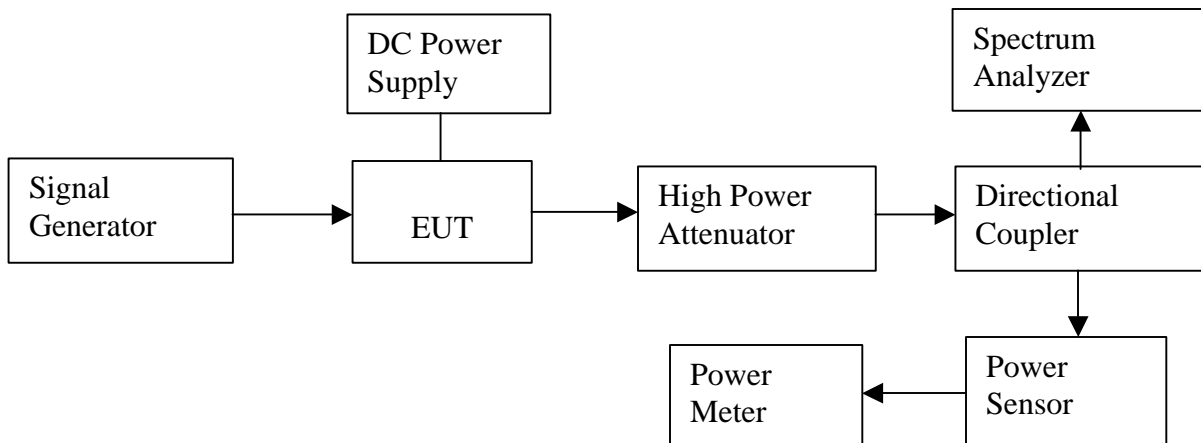

## 12. PART 2: CERTIFICATION TEST REQUIREMENT:

### SECTION 2.1046: RF POWER OUTPUT

#### TEST SETUP:

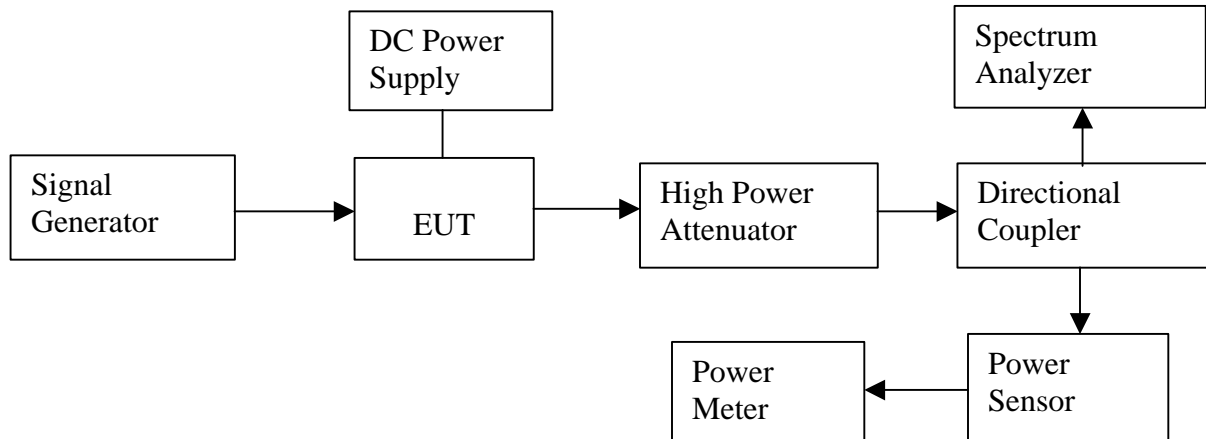

#### Minimum requirement:

##### Section 22.913(a); Maximum ERP.

The effective radiated power (ERP) of base transmitters and cellular repeaters must not exceed 500 Watts. The ERP of mobile transmitters and auxiliary test transmitters must not exceed 7 Watts.

#### Test procedure:

The EUT was setup as shown above. The EUT was setup according to the manufacturer's tune-up procedure to give maximum output power of 33 Watts.

#### Test Result:

The EUT's measured output power was 33 Watts. See below attached plots.

<b>UNIT S/N: PWWT01D35RDC</b>		
<b>Plot#</b>	<b>Description</b>	<b>Frequency (MHz)</b>
1	GSM Power Output @ Low Channel	869.4
2	GSM Power Output @ Mid Channel	881.5
3	GSM Power Output @ High Channel	893.6
4	EDGE Power Output @ Low Channel	869.4
5	EDGE Power Output @ Mid Channel	881.5
6	EDGE Power Output @ High Channel	893.6
<b>UNIT S/N: PWWT01D35RJC</b>		
<b>Plot#</b>	<b>Description</b>	<b>Frequency (MHz)</b>
7	GSM Power Output @ Low Channel	869.4
8	GSM Power Output @ Mid Channel	881.5
9	GSM Power Output @ High Channel	893.6
10	EDGE Power Output @ Low Channel	869.4
11	EDGE Power Output @ Mid Channel	881.5
12	EDGE Power Output @ High Channel	893.6

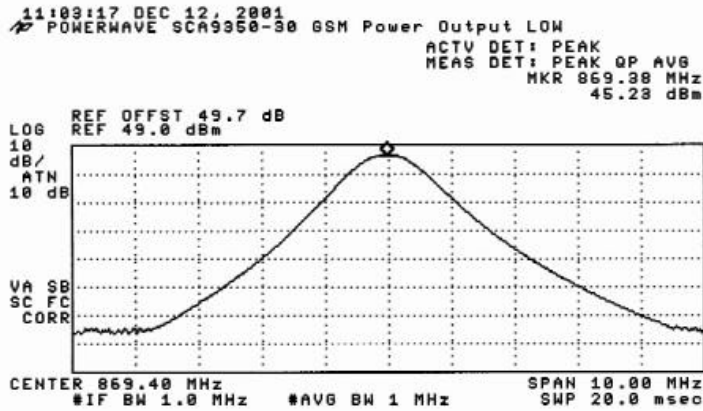

1

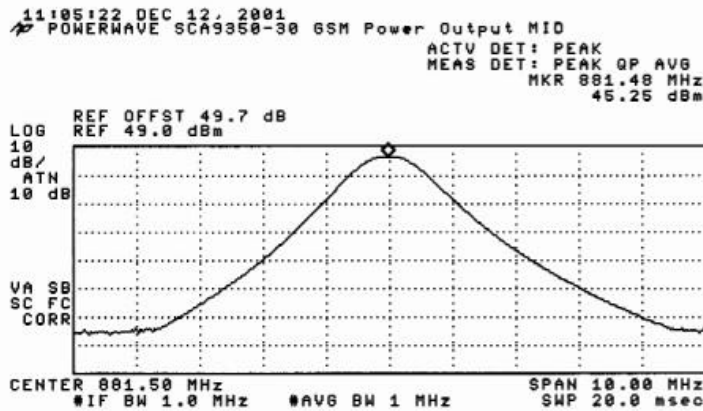

2

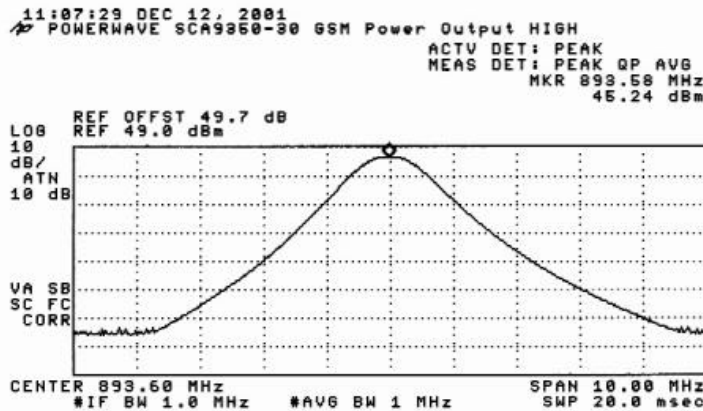

3

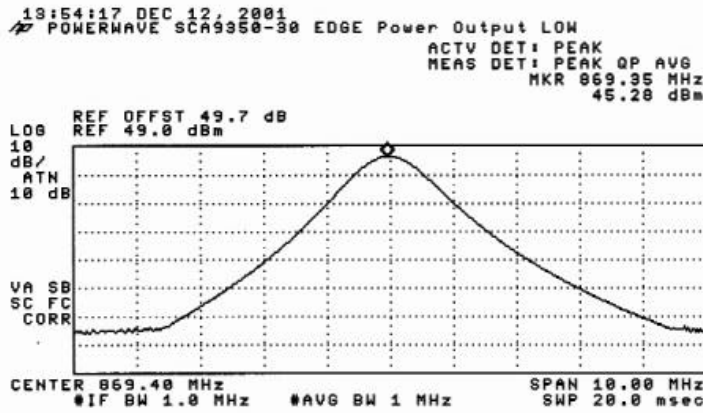

4

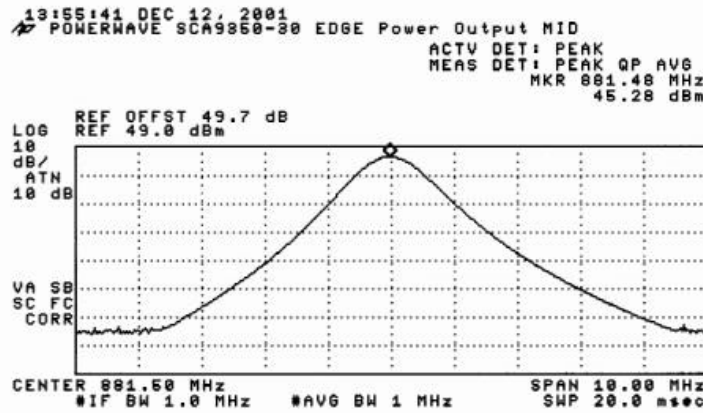

5

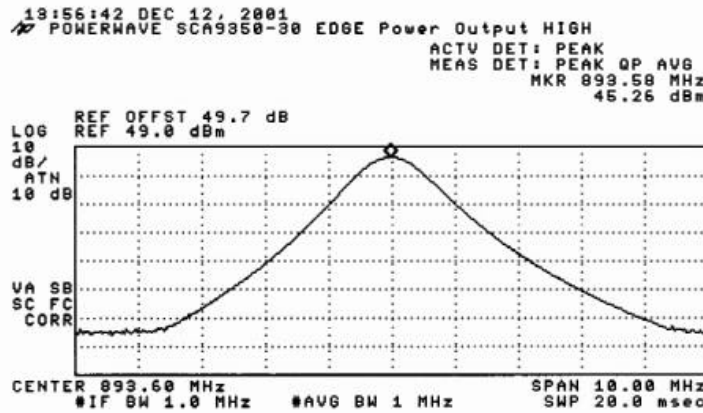

6

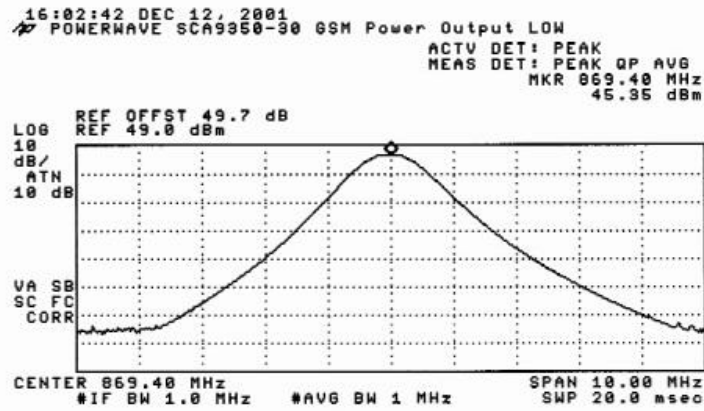

7

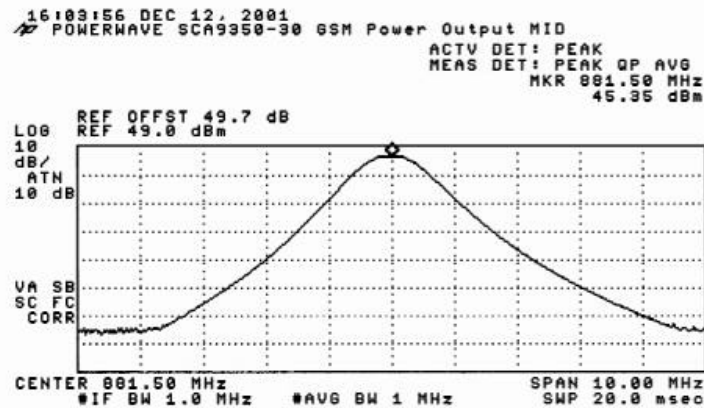

8

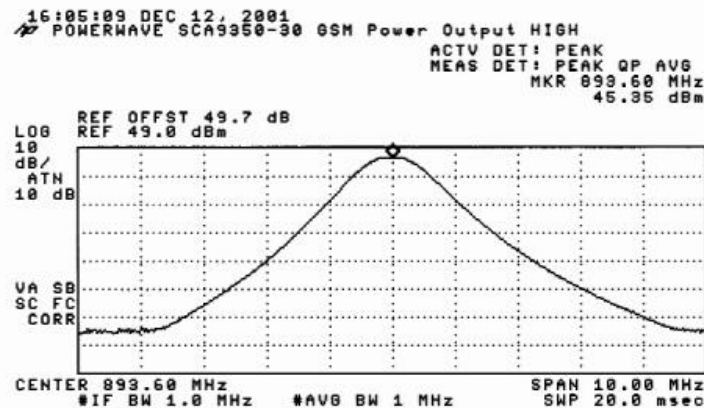

9



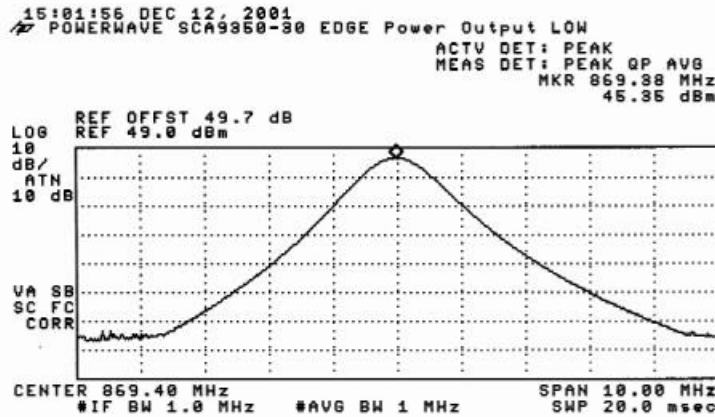

10

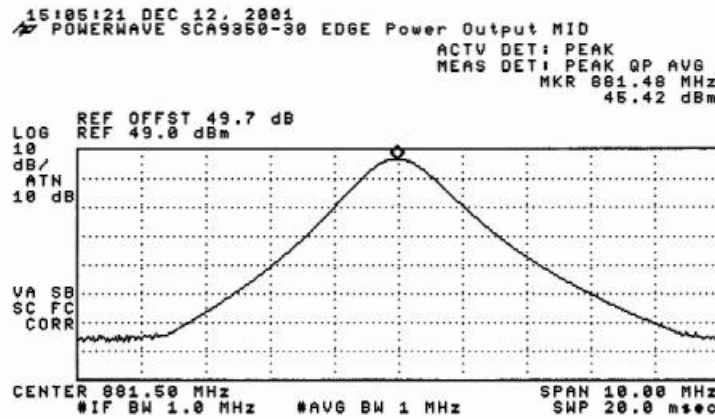

11

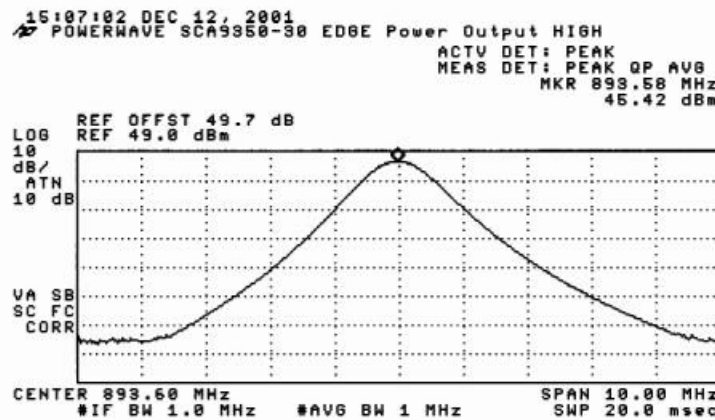

12

**SECTION 2.1047: MODULATION CHARACTERISTICS**

Not applicable. EUT is a power amplifier.

**SECTION 2.1049: OCCUPIED BANDWIDTH**

**TEST SETUP FOR OUTPUT:**

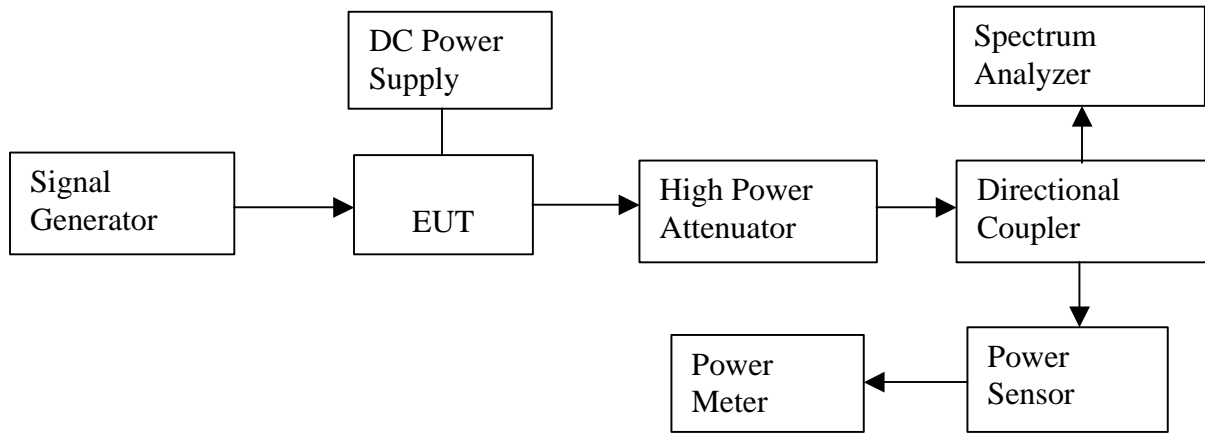

**TEST SETUP FOR INPUT:**

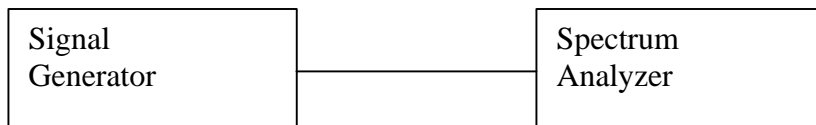

**Minimum Requirement:**

**Section 2.1049(i);**

Transmitters designed for other types of modulation-when modulated by an appropriate signal of sufficient amplitude to be representative of the type of service in which used. A description of the input signal should be supplied.

**Test Procedure:**

The Eut's occupied bandwidth is compared to the input source plot (signal generator) and output plot (power amplifier) to check that the input signal bandwidth is not greater at the output of amplifier.

Use the setup for output shown above. Correct for external attenuation and cable loss. Set the power amplifier to the maximum output gain. Using the marker delta function, measure the 20dB bandwidth of the EUT's emission. Record the spectrum analyzer plot.

Use the setup for input shown above. Correct for external attenuation and cable loss. Using the marker delta function, measure the 20dB bandwidth of the signal generator's emission. Record the spectrum analyzer plot.

**Test Results:**

See plots below:

UNIT S/N: PWWT01D35RDC		
Plot#	Description	Frequency (MHz)
13	GSM 20dB Output Bandwidth @ Low Channel	869.4
14	GSM 20dB Output Bandwidth @ Mid Channel	881.5
15	GSM 20dB Output Bandwidth @ High Channel	893.6
16	GSM 20dB Input Bandwidth @ Low Channel	869.4
17	GSM 20dB Input Bandwidth @ Mid Channel	881.5
18	GSM 20dB Input Bandwidth @ High Channel	893.6
19	EDGE 20dB Output Bandwidth @ Low Channel	869.4
20	EDGE 20dB Output Bandwidth @ Mid Channel	881.5
21	EDGE 20dB Output Bandwidth @ High Channel	893.6
22	EDGE 20dB Input Bandwidth @ Low Channel	869.4
23	EDGE 20dB Input Bandwidth @ Mid Channel	881.5
24	EDGE 20dB Input Bandwidth @ High Channel	893.6
UNIT S/N: PWWT01D35RJC		
Plot#	Description	Frequency (MHz)
25	GSM 20dB Output Bandwidth @ Low Channel	869.4
26	GSM 20dB Output Bandwidth @ Mid Channel	881.5
27	GSM 20dB Output Bandwidth @ High Channel	893.6
28	GSM 20dB Input Bandwidth @ Low Channel	869.4
29	GSM 20dB Input Bandwidth @ Mid Channel	881.5
30	GSM 20dB Input Bandwidth @ High Channel	893.6
31	EDGE 20dB Output Bandwidth @ Low Channel	869.4
32	EDGE 20dB Output Bandwidth @ Mid Channel	881.5
33	EDGE 20dB Output Bandwidth @ High Channel	893.6
34	EDGE 20dB Input Bandwidth @ Low Channel	869.4
35	EDGE 20dB Input Bandwidth @ Mid Channel	881.5
36	EDGE 20dB Input Bandwidth @ High Channel	893.6

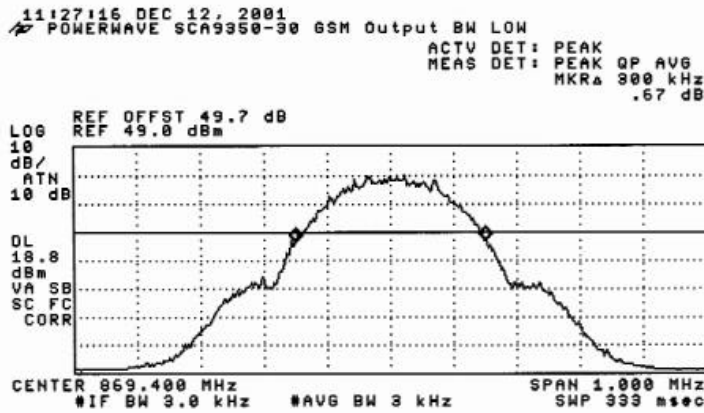

13

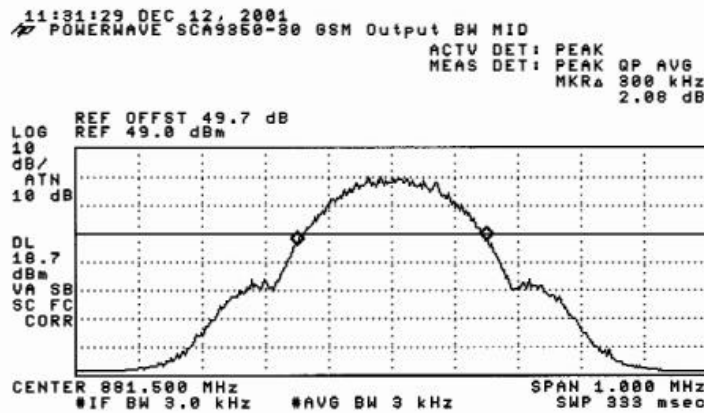

14

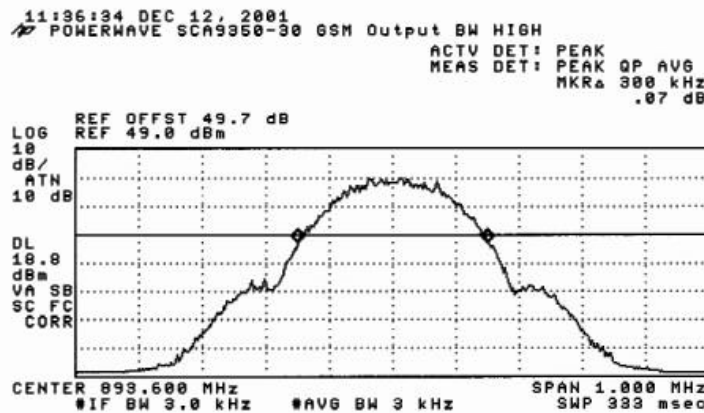

15

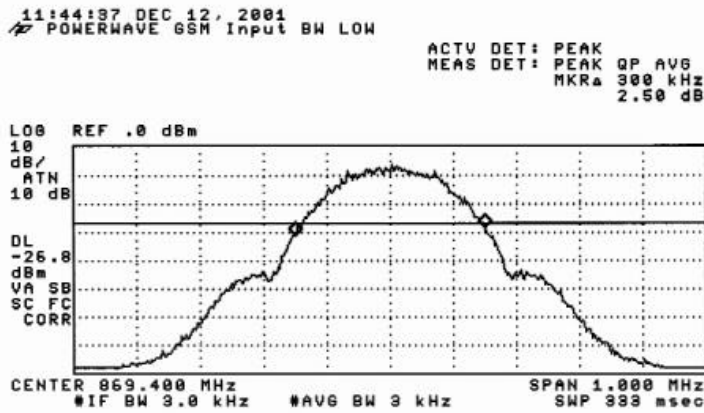

16

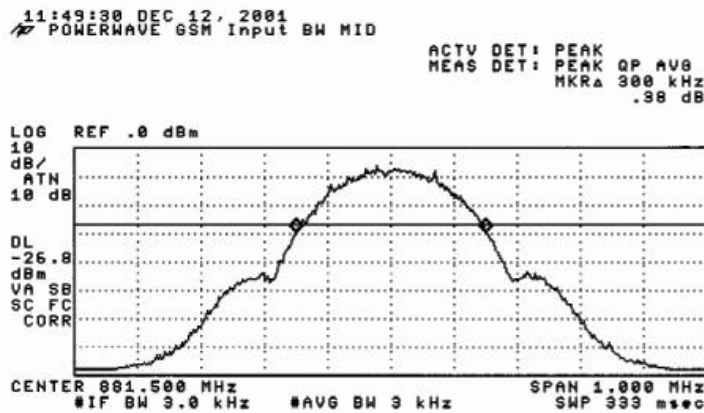

17

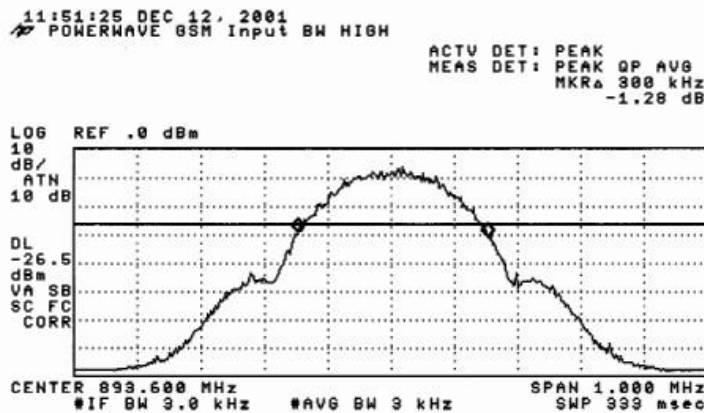

18

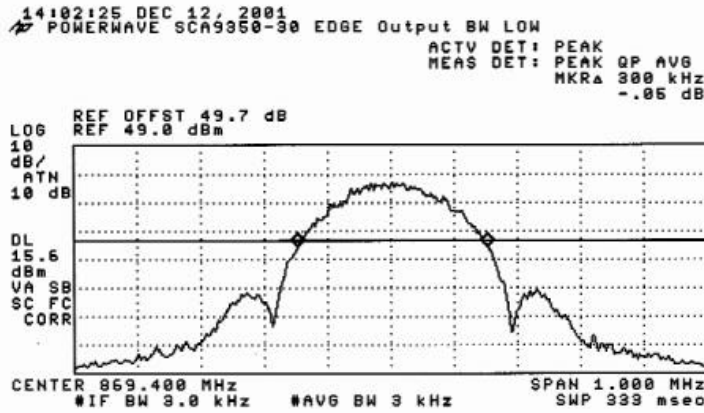

19

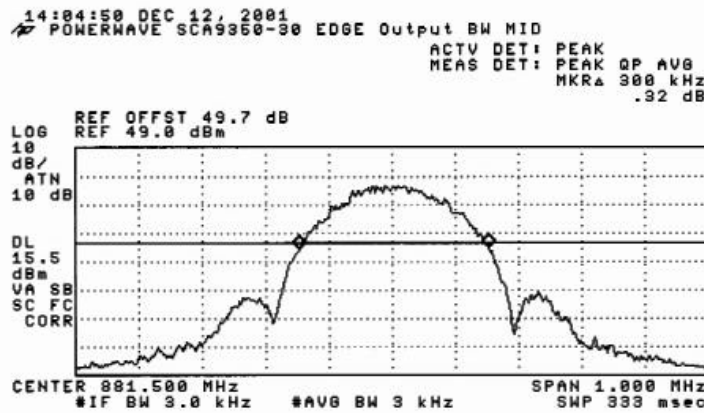

20

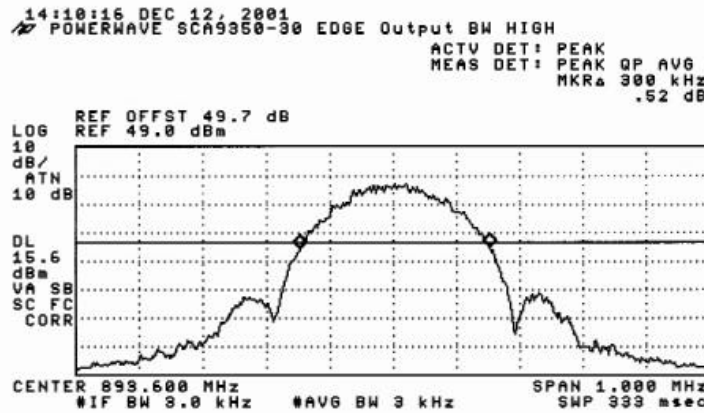

21

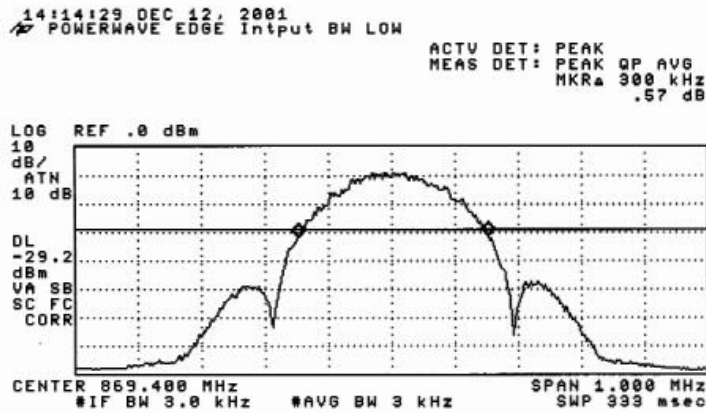

22

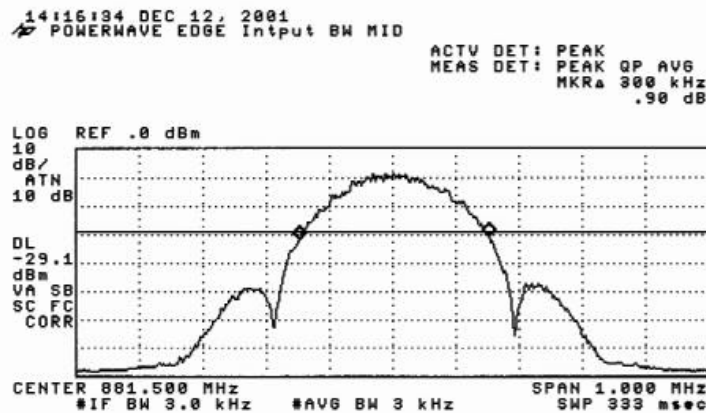

23

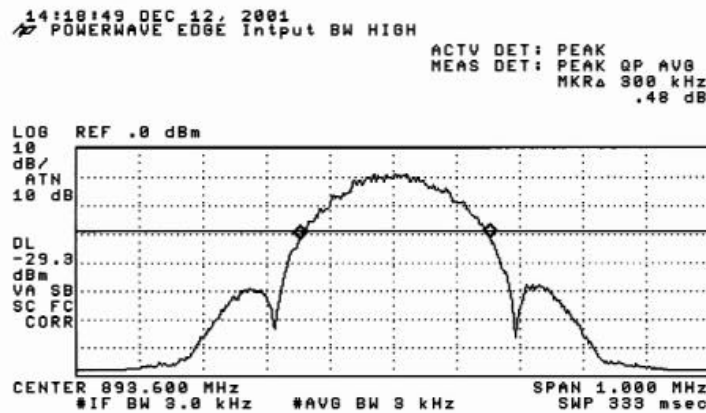

24

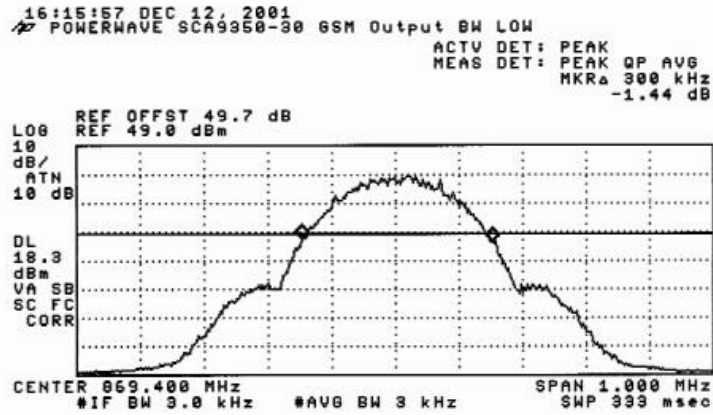

25

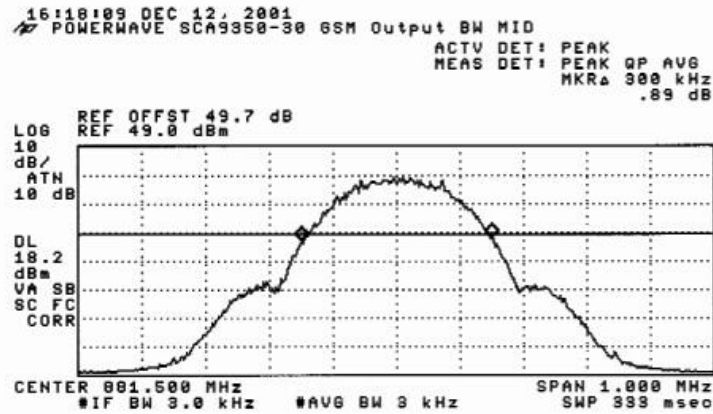

26

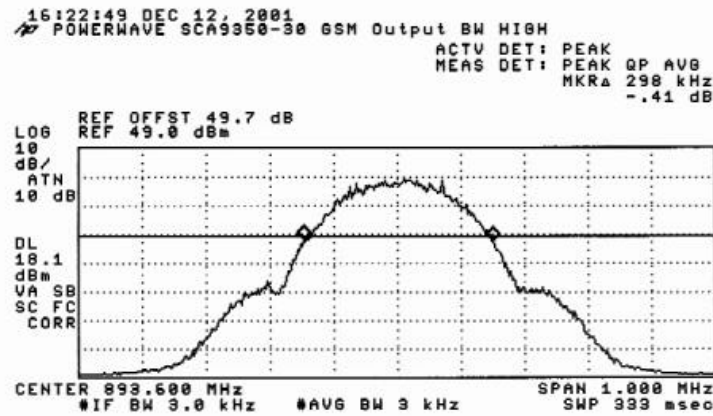

27



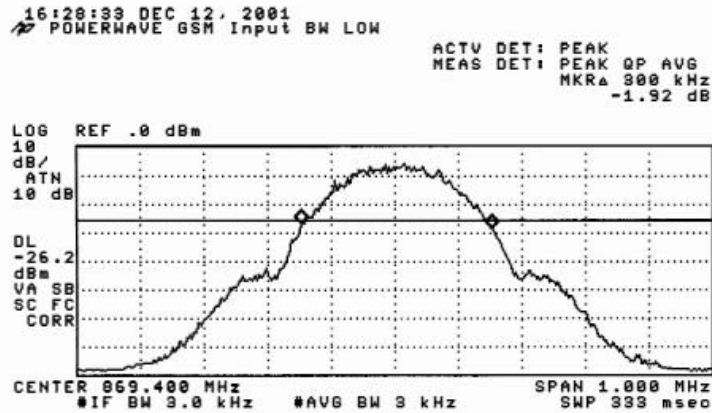

28

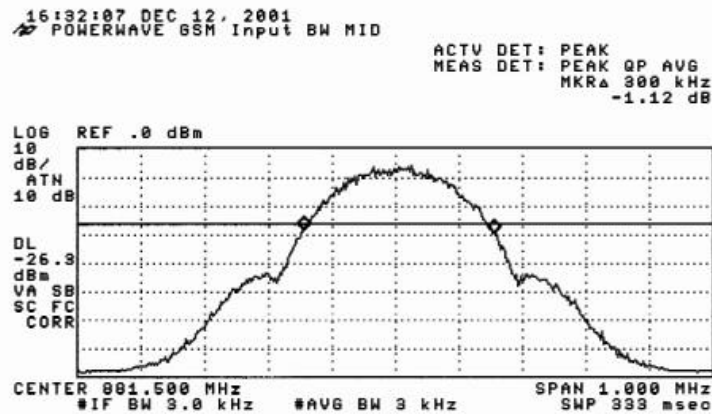

29

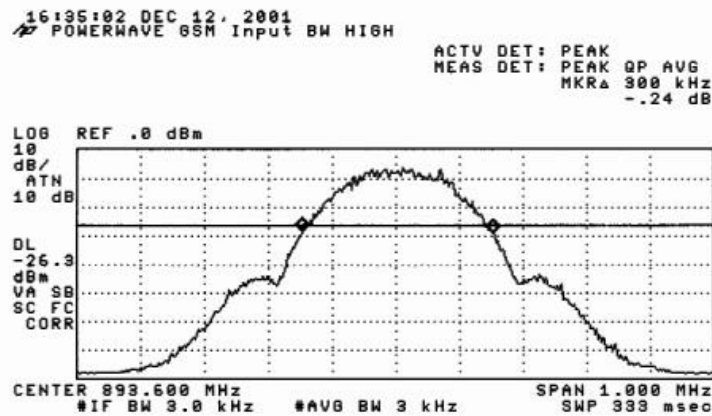

30

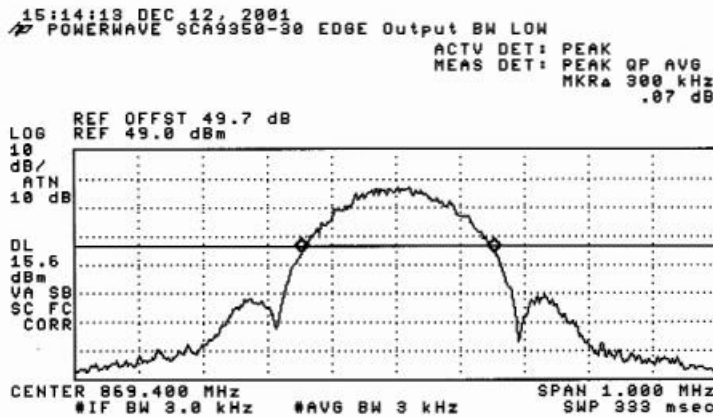

31

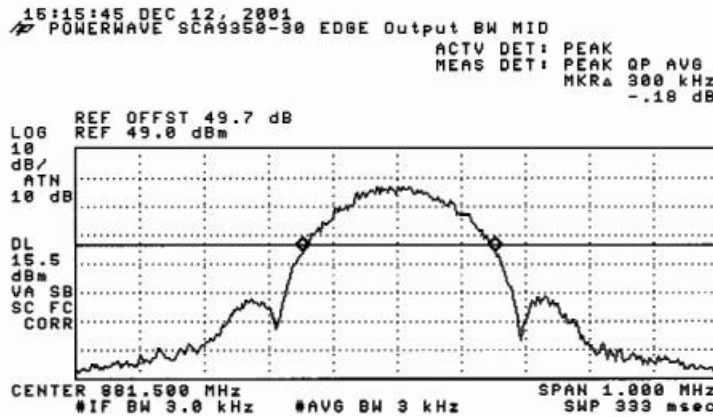

32

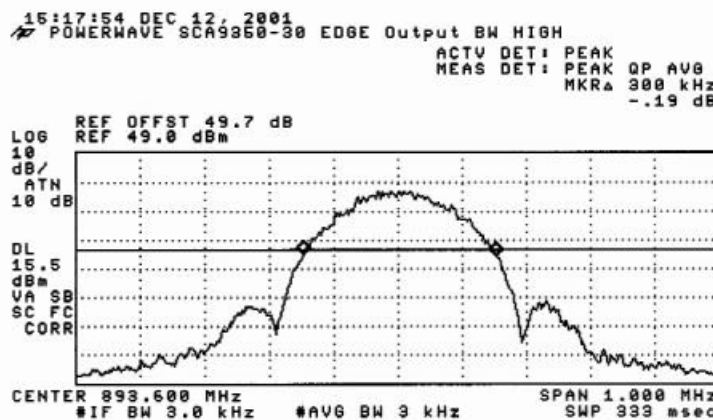

33

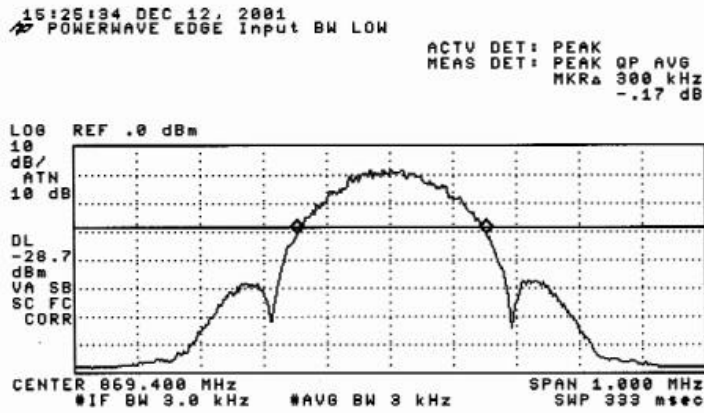

34

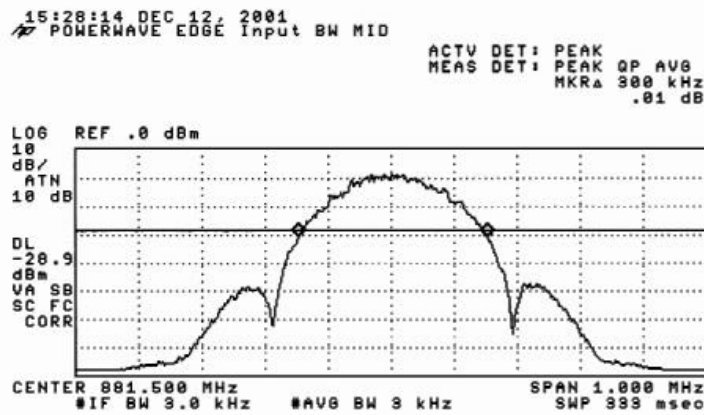

35

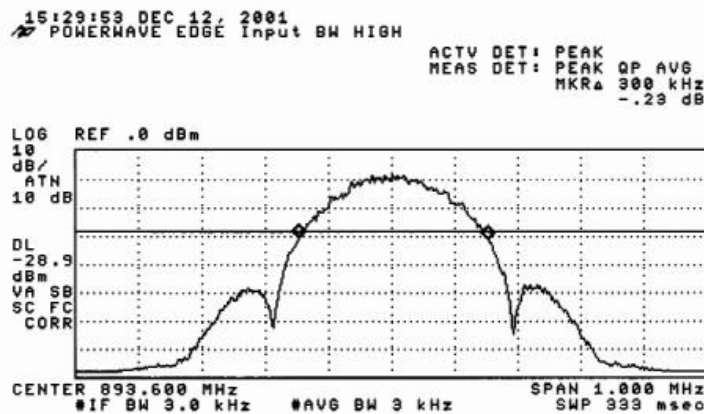

36

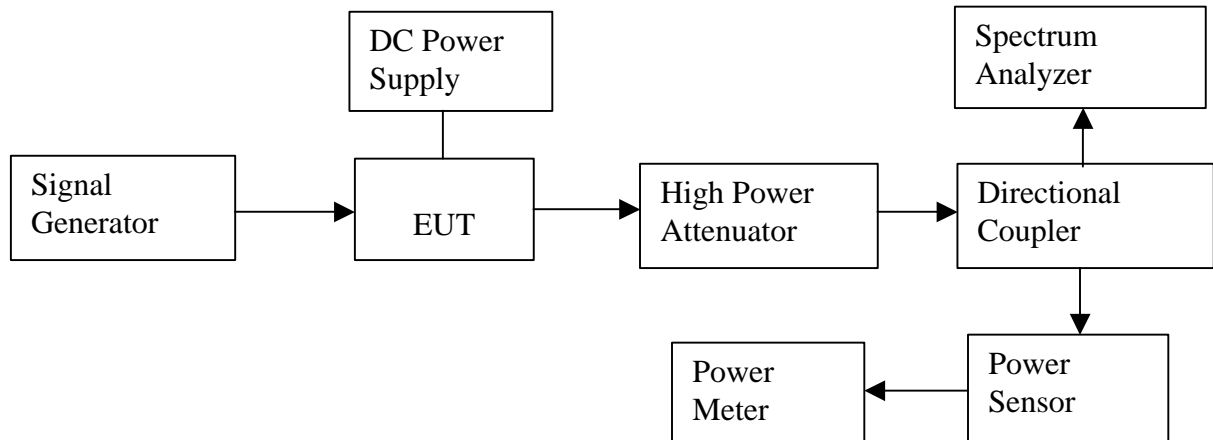
**SECTION 2.1051: SPURIOUS EMISSION AT ANTENNA TERMINALS****TEST SETUP:****Minimum Requirement:****Section 22.917(e):**

For Base stations transmitters the magnitude of each spurious, harmonic, and intermodulation emissions that can be detected when the equipment is operated under conditions specified in the instruction manual and/or alignment procedure, shall not be more than  $43 + 10 \log (P)$  dBc below the mean power output, which is equivalent to  $-13$  dBm.

**Test Procedure:**

Input single modulated signal to the amp to produce 33 watts composite power. Set the RES & VID BW to 30kHz and the DISPLAY LINE to  $-13$ dBm. Scan the EUT from 15MHz to the 10<sup>th</sup> harmonic of carrier and check for spurious, harmonic, and intermodulation emissions.

**Test Result:**

Plots were taken with single input at low, mid, and high of the band. Plots were taken of the out-of-band emissions from 15MHz to the 10<sup>th</sup> harmonic of the carrier frequency.

<b>UNIT S/N: PWWT01D35RDC</b>		
<b>Plot#</b>	<b>Description</b>	<b>Frequency (MHz)</b>
37	GSM Out-of-Band @ Low Channel	15 - 1000
38	GSM Out-of-Band @ Low Channel	1000 - 2900
39	GSM Out-of-Band @ Low Channel	2900 - 9000
40	GSM Out-of-Band @ Mid Channel	15 - 1000
41	GSM Out-of-Band @ Mid Channel	1000 - 2900
42	GSM Out-of-Band @ Mid Channel	2900 - 9000
43	GSM Out-of-Band @ High Channel	15 - 1000
44	GSM Out-of-Band @ High Channel	1000 - 2900
45	GSM Out-of-Band @ High Channel	2900 - 9000
46	EDGE Out-of-Band @ Low Channel	15 - 1000
47	EDGE Out-of-Band @ Low Channel	1000 - 2900
48	EDGE Out-of-Band @ Low Channel	2900 - 9000
49	EDGE Out-of-Band @ Mid Channel	15 - 1000
50	EDGE Out-of-Band @ Mid Channel	1000 - 2900
51	EDGE Out-of-Band @ Mid Channel	2900 - 9000
52	EDGE Out-of-Band @ High Channel	15 - 1000
53	EDGE Out-of-Band @ High Channel	1000 - 2900
54	EDGE Out-of-Band @ High Channel	2900 - 9000
<b>UNIT S/N: PWWT01D35RJC</b>		
<b>Plot#</b>	<b>Description</b>	<b>Frequency (MHz)</b>
55	GSM Out-of-Band @ Low Channel	15 - 1000
56	GSM Out-of-Band @ Low Channel	1000 - 2900
57	GSM Out-of-Band @ Low Channel	2900 - 9000
58	GSM Out-of-Band @ Mid Channel	15 - 1000
59	GSM Out-of-Band @ Mid Channel	1000 - 2900
60	GSM Out-of-Band @ Mid Channel	2900 - 9000
61	GSM Out-of-Band @ High Channel	15 - 1000
62	GSM Out-of-Band @ High Channel	1000 - 2900
63	GSM Out-of-Band @ High Channel	2900 - 9000
64	EDGE Out-of-Band @ Low Channel	15 - 1000
65	EDGE Out-of-Band @ Low Channel	1000 - 2900
66	EDGE Out-of-Band @ Low Channel	2900 - 9000
67	EDGE Out-of-Band @ Mid Channel	15 - 1000
68	EDGE Out-of-Band @ Mid Channel	1000 - 2900
69	EDGE Out-of-Band @ Mid Channel	2900 - 9000
70	EDGE Out-of-Band @ High Channel	15 - 1000
71	EDGE Out-of-Band @ High Channel	1000 - 2900
72	EDGE Out-of-Band @ High Channel	2900 - 9000

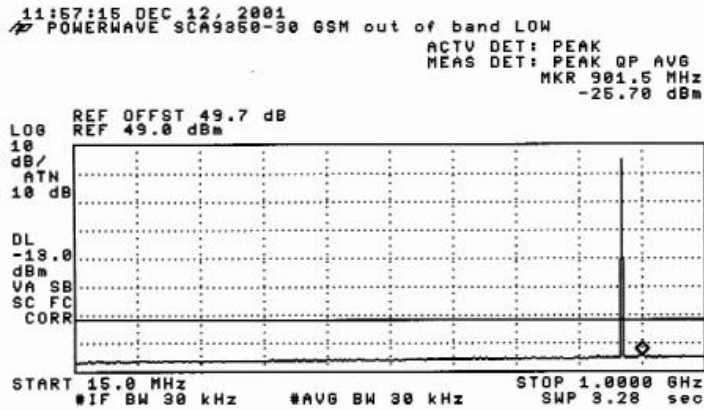

37

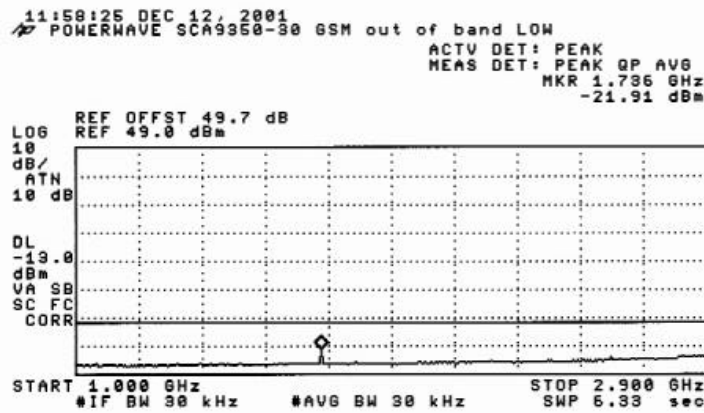

38

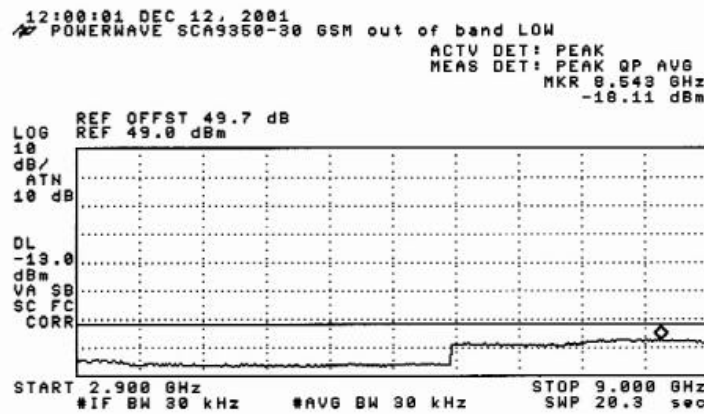

39

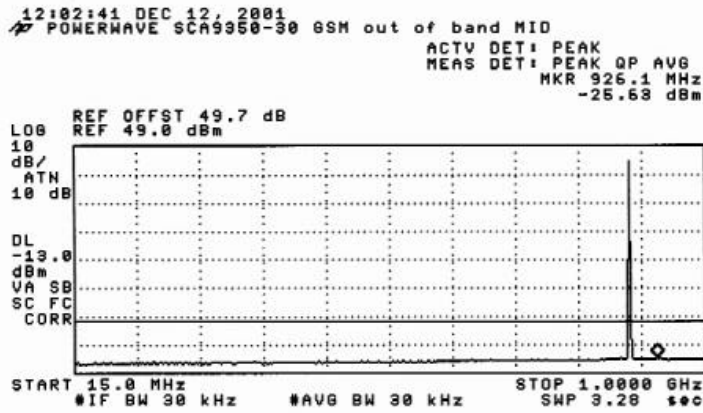

40

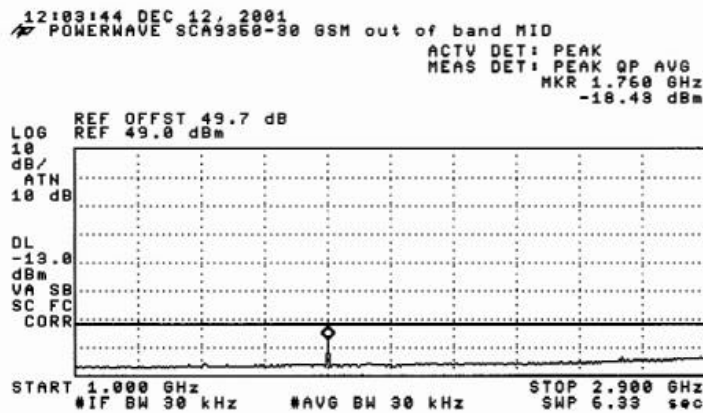

41

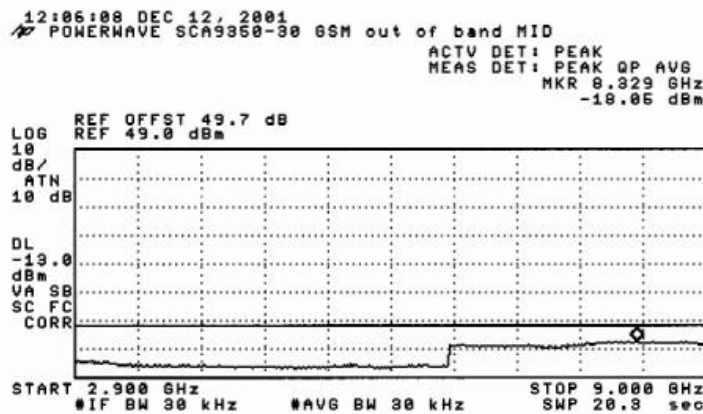

42

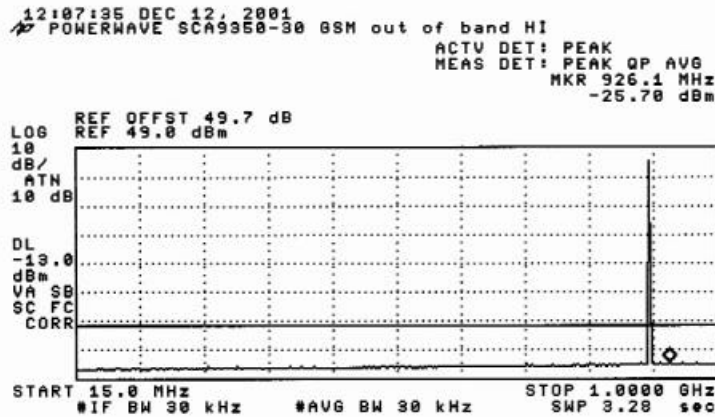

43

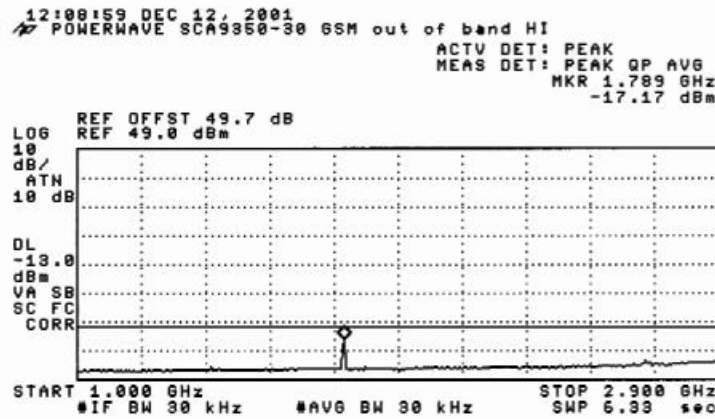

44

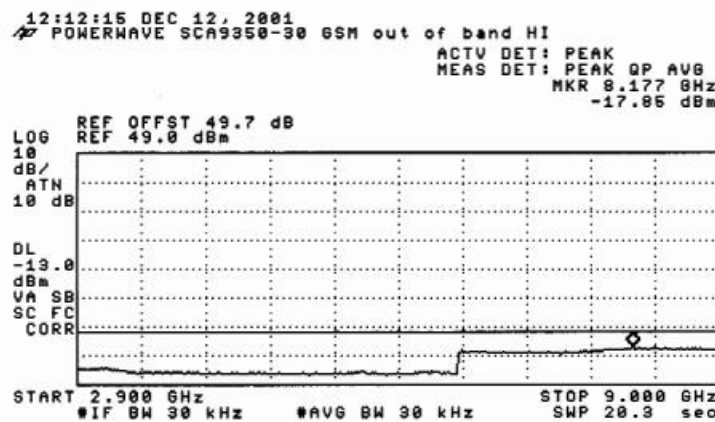

45



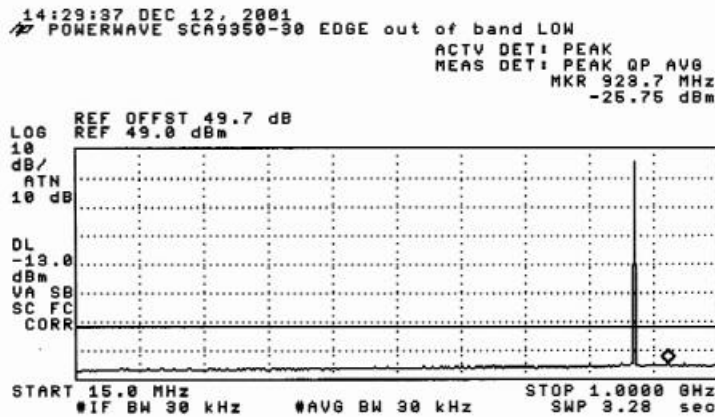

46

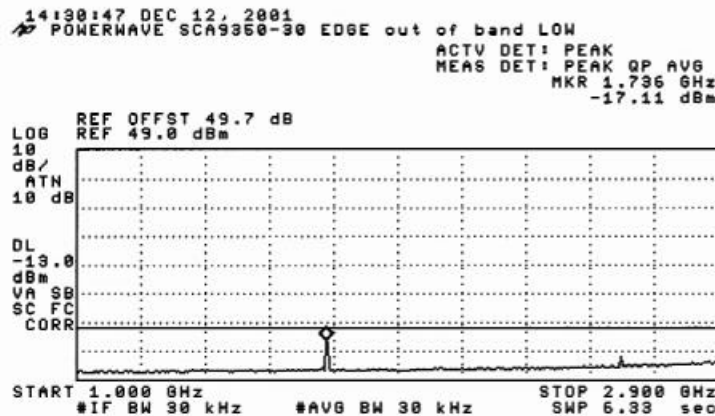

47

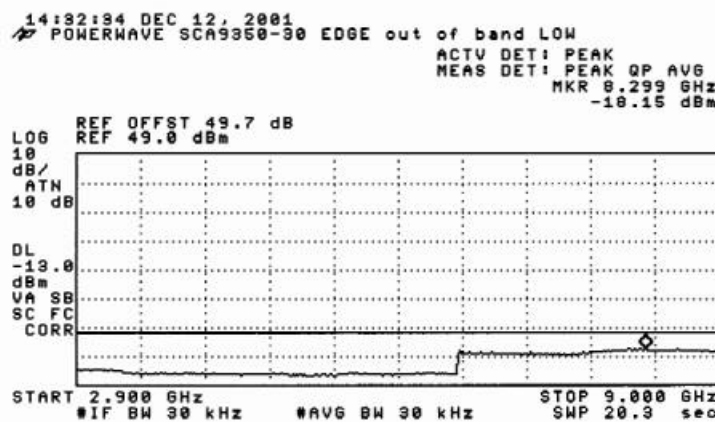

48

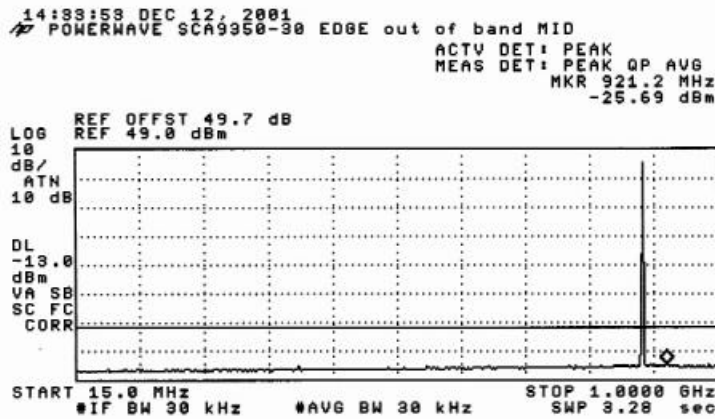

49

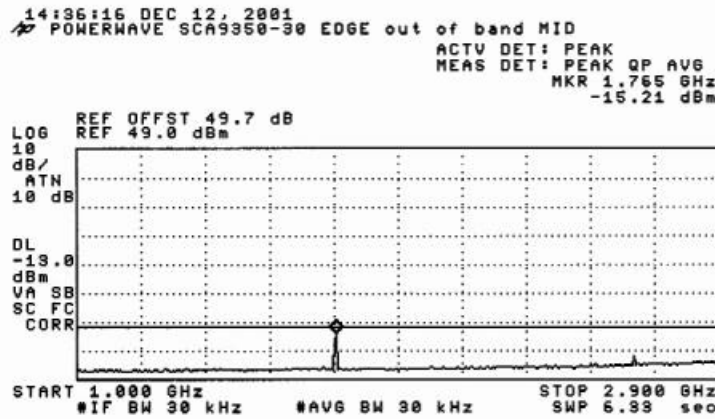

50

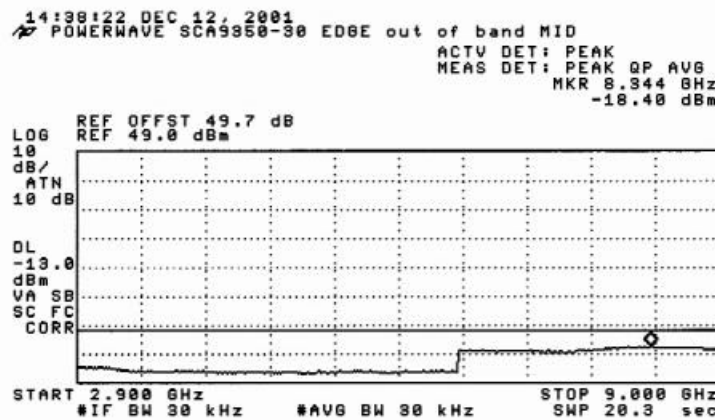

51

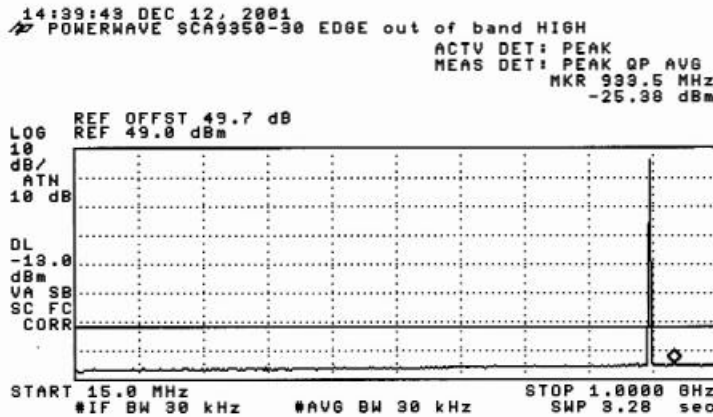

52

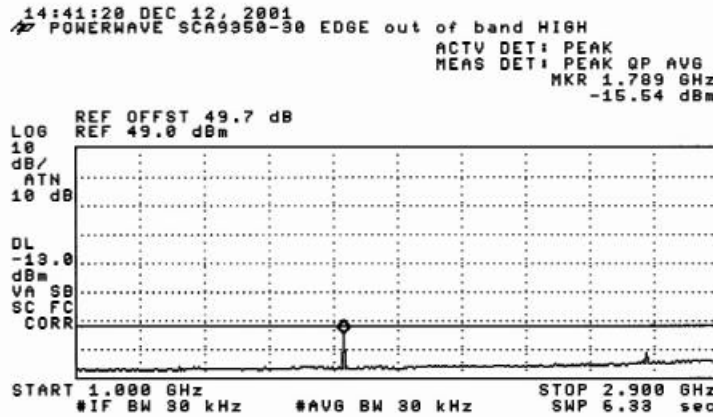

53

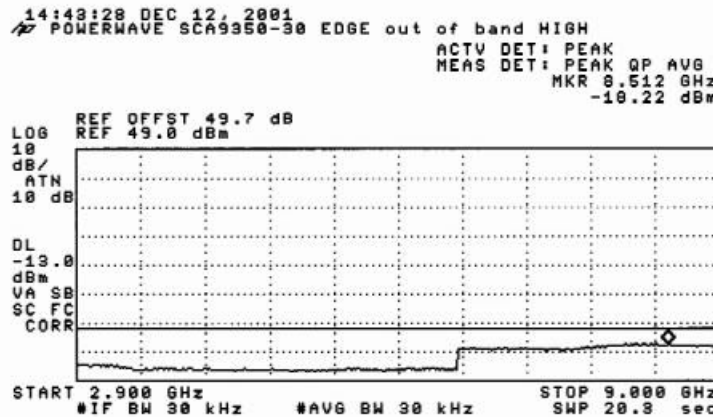

54

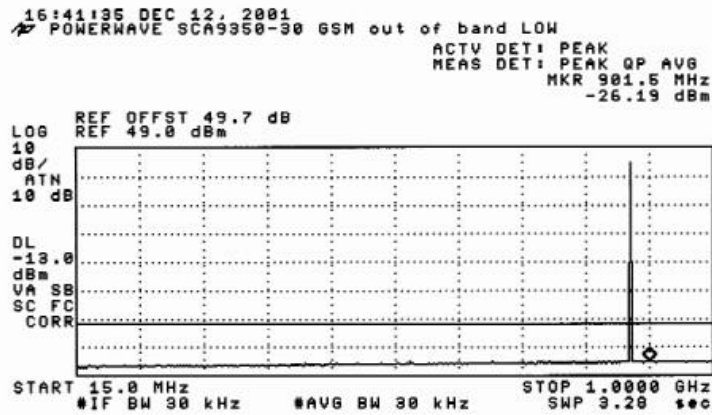

55

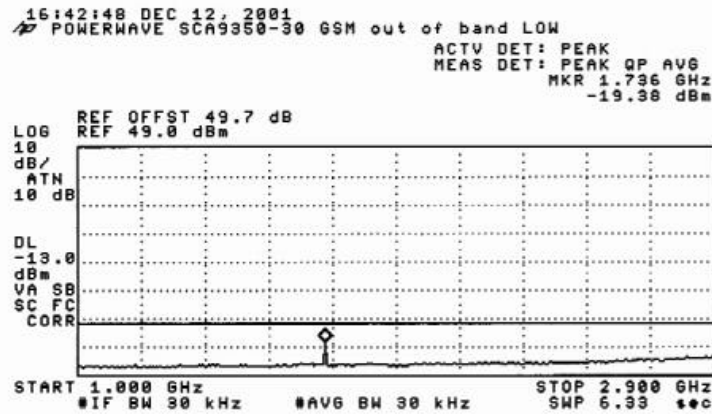

56

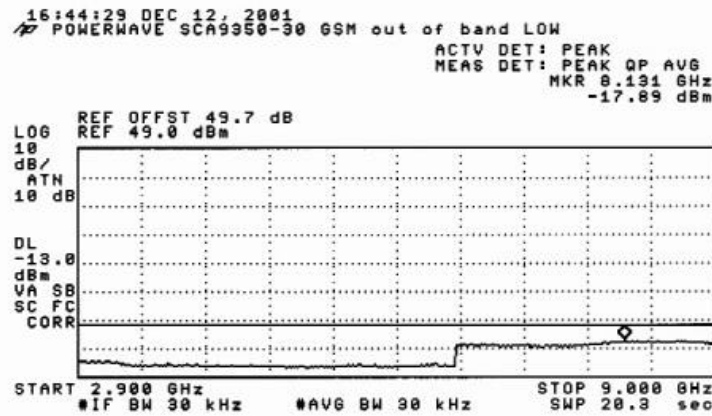

57

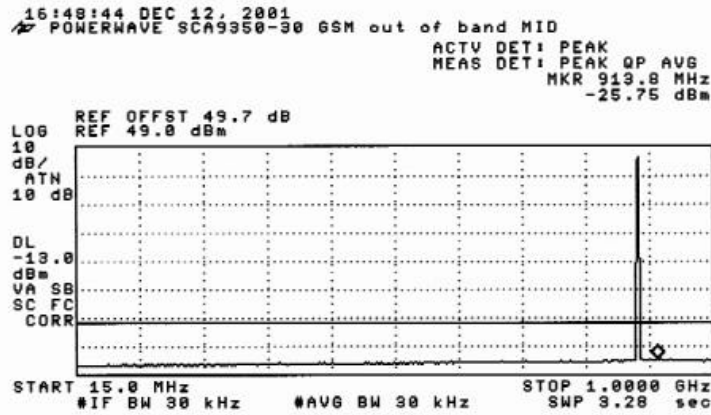

58

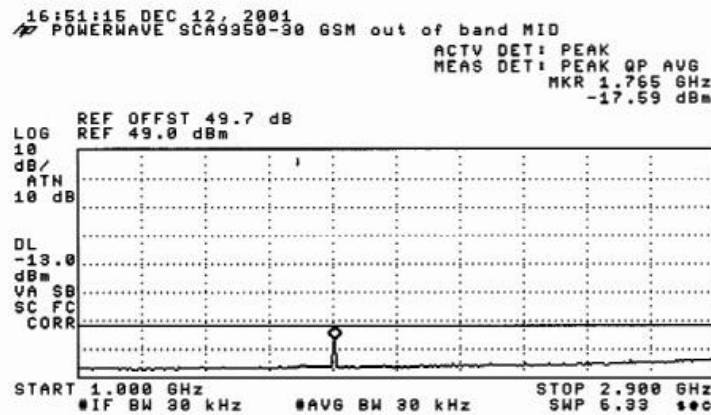

59

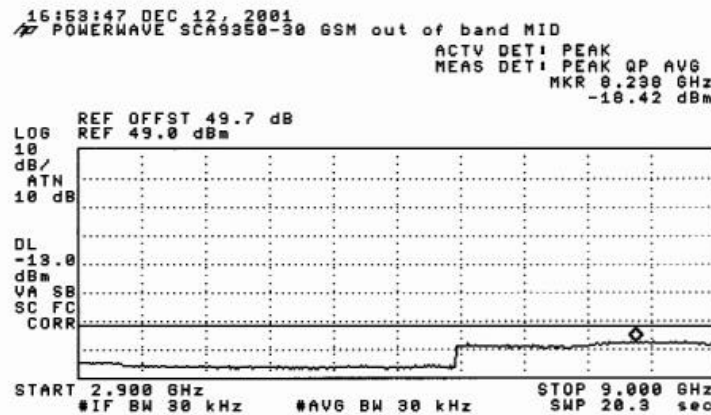

60

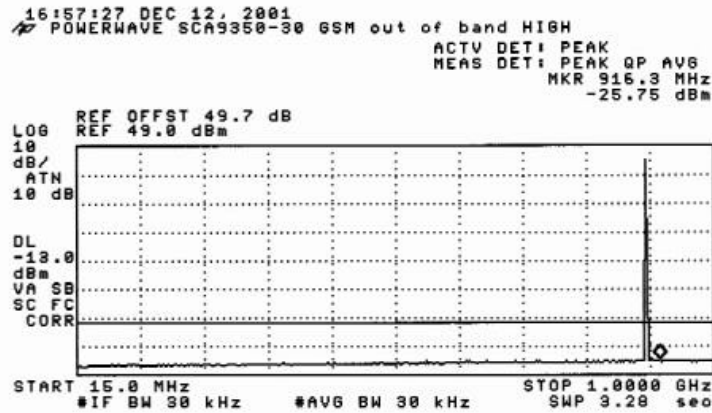

61

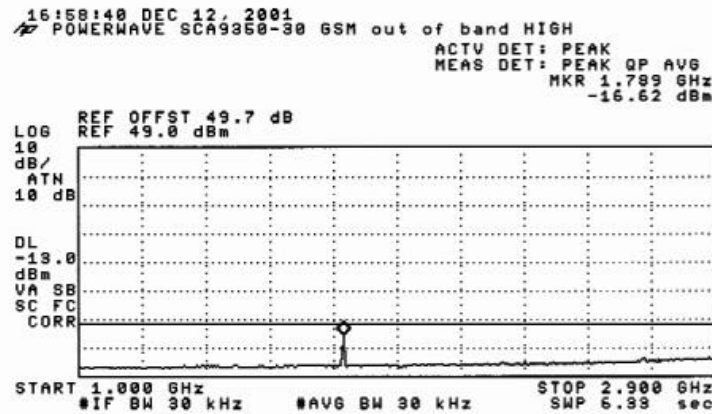

62

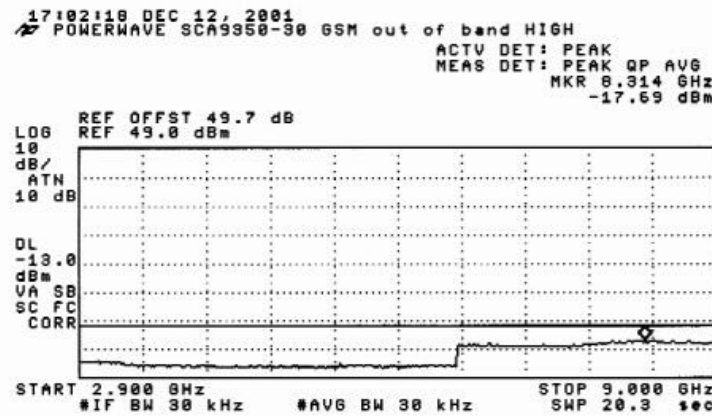

63

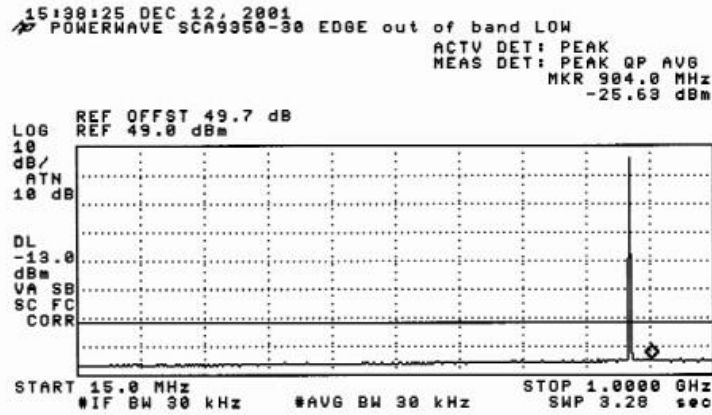

64

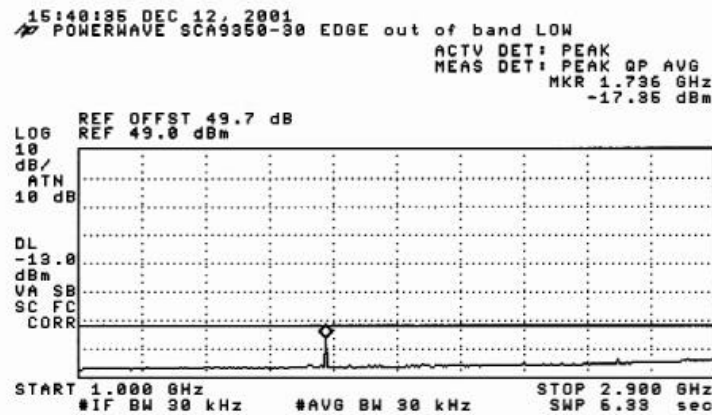

65

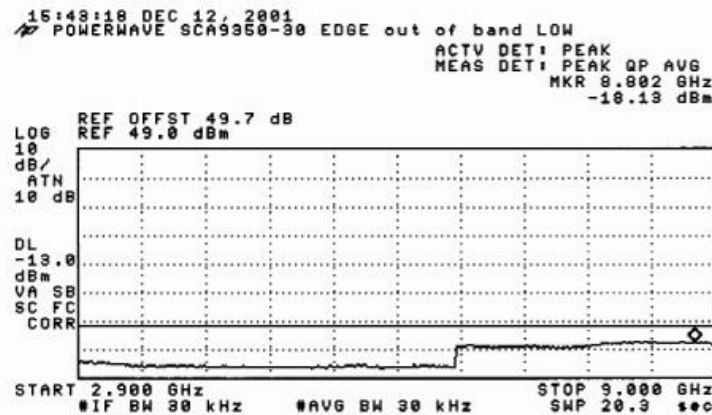

66

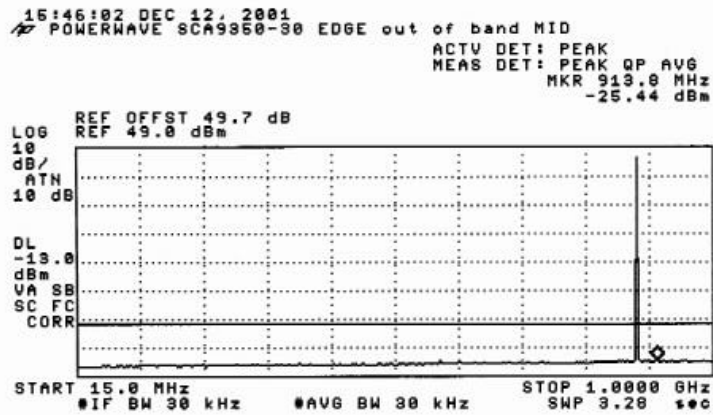

67

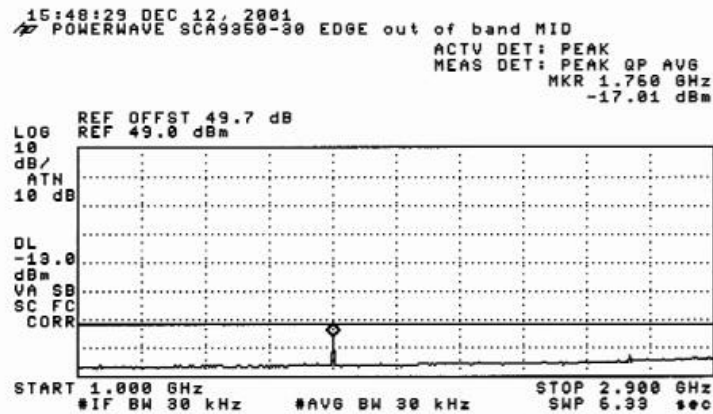

68

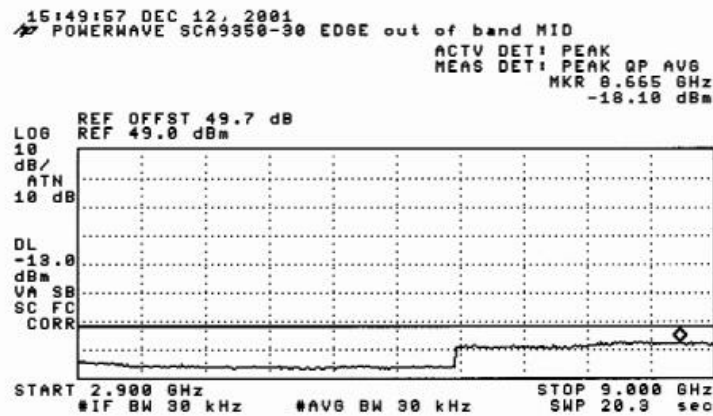

69



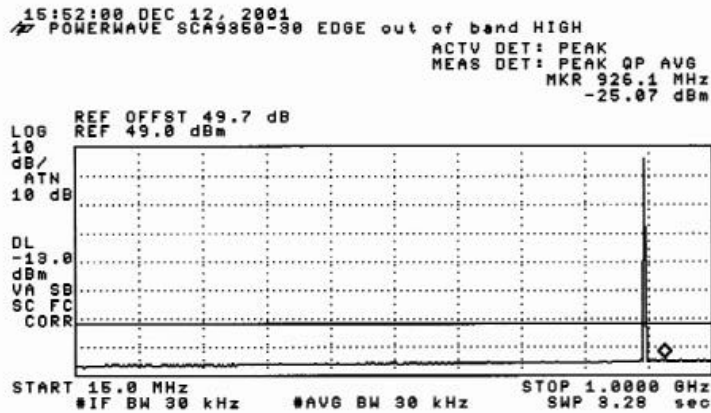

70

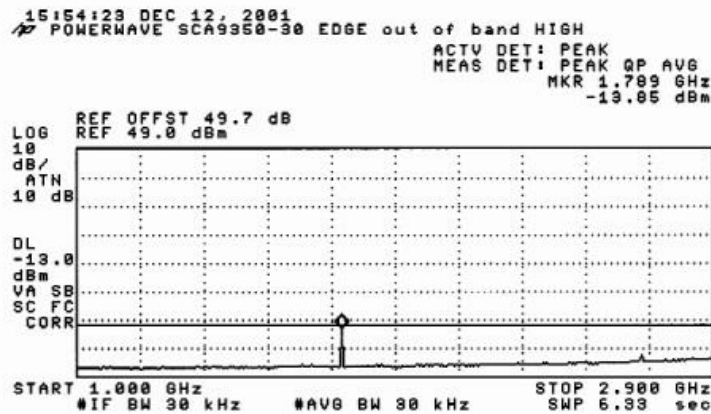

71

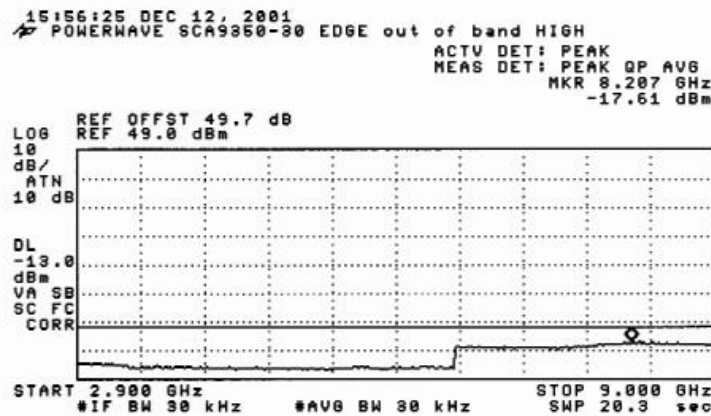

72

**SECTION 2.1055: FREQUENCY STABILITY**

Not Applicable. Eut is a power amplifier.

**RADIATED EMISSIONS**

**Test Set-up:**

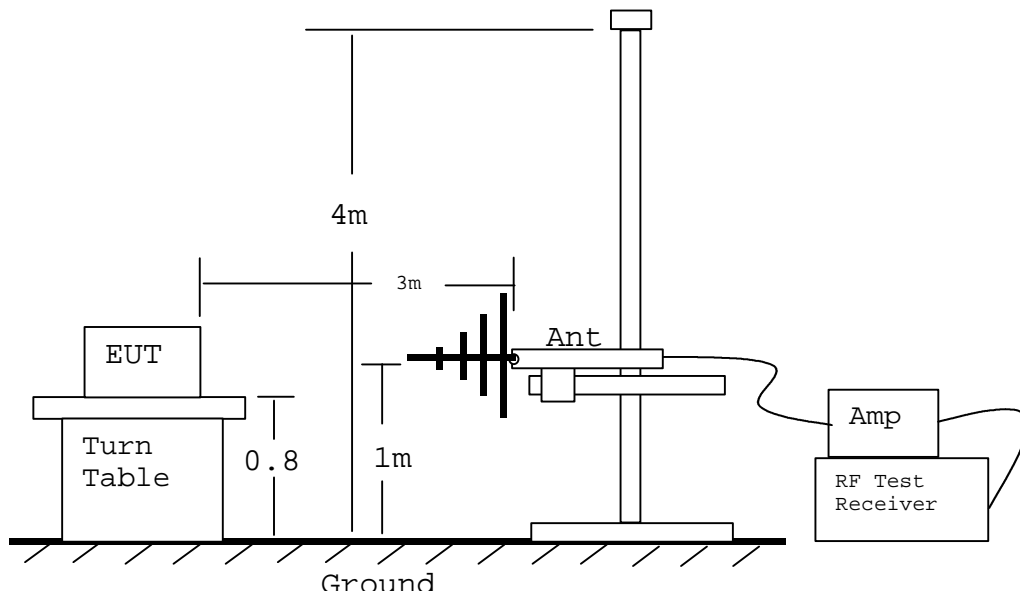

**Radiated Emission Test 30 – 1000 MHz (Bilog)**

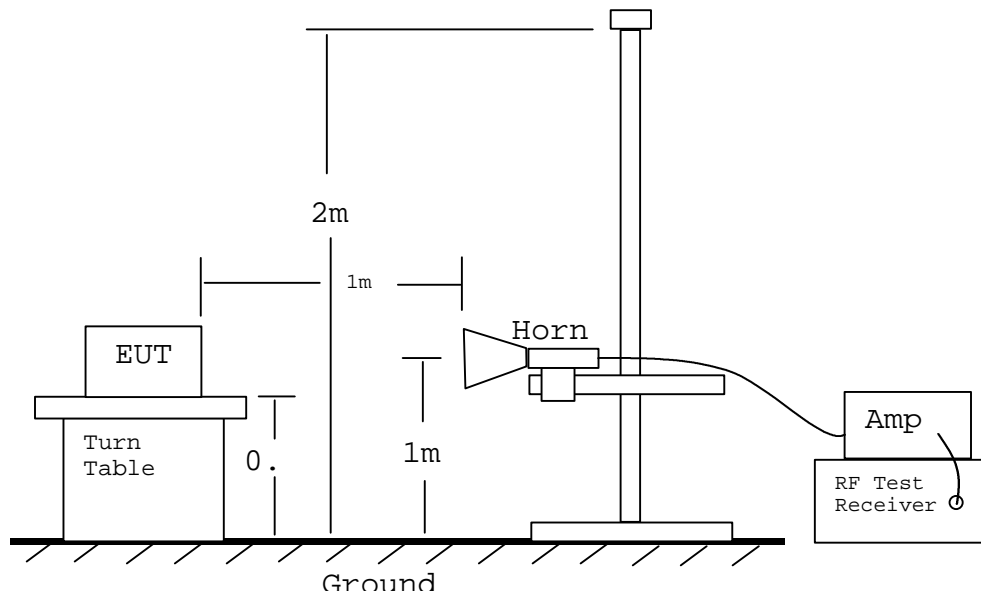

**Radiated Emission Test 1 – 9 GHz (Horn)**

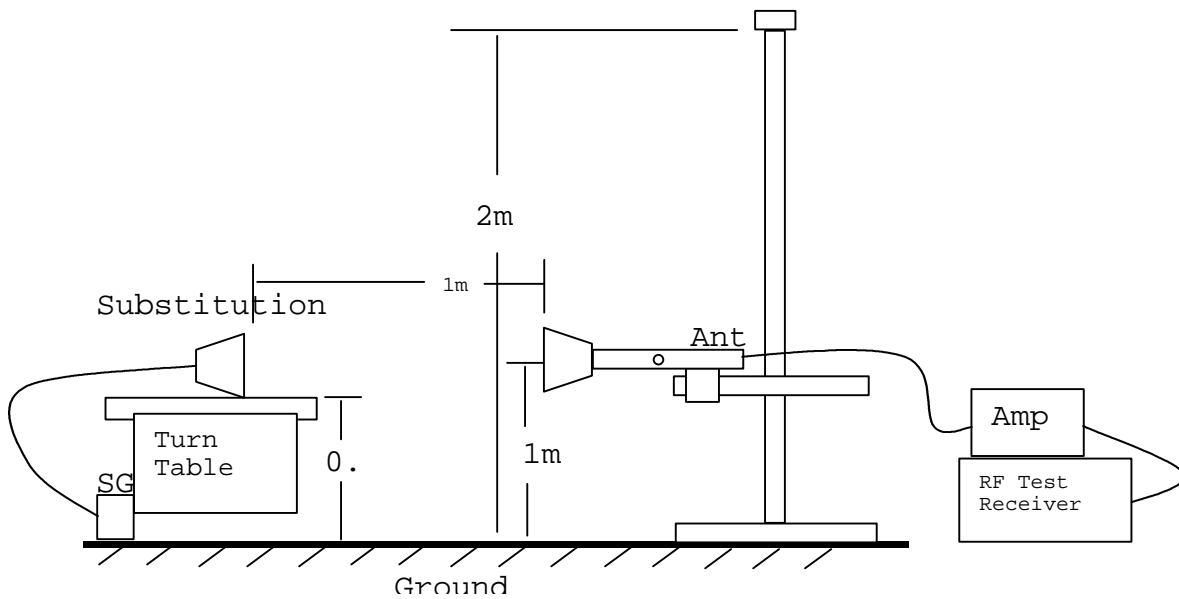

**Substitution Method above 1 GHz**

**RADIATED EMISSION TEST PROCEDURE**

The actual signal generated by the measured equipment may be determined by means of a substitution measurement in which a known signal source replaces the device to be measured.

- A. The substitution antenna will replace the Eut antenna in the same position and in vertical polarization. The frequency of the signal generator shall be set to the frequencies that were measured on the Eut. The test antenna shall be raised and lowered, if necessary, to ensure that the maximum signal is still being received. The signal generator, output level, shall be adjusted until an equal or a known related level to what was measured from the Eut is obtained in the spectrum analyzer.

The radiated power is equal to the power supplied by the signal generator

The formula, to calculate the true reading, is: True reading = dBm + GdBd - CL

dBm = signal generator output level

GdBd = the gain in dBd of the substitution antenna

CL = the cable loss

The calculated True reading is then compared to the limit and should not exceed the limit. This method must be performed for every emission measured from the Eut. This shall also be repeated for horizontal polarization.

**Test Result:**

See radiated emission data attached below.

**Compliance Certification Services**

Radiated Emissions  
22.917(e)

12/13/01  
A-Site (1 meter)  
Kerwin Corpuz

POWERWAVE

869-894 MHz Single-Channel GSM/EDGE Amplifier (M/N: SCA9350-30)

S/N: PWWT01D35RDC

**fo = 869.4 MHz (LOW)**

frequency (MHz)	SA reading (dBuV)	SG reading (dBm)	CL (dB)	Gain (dBi)	Gain (dBd)	ERP (dBm)	Limit (dBm)	Margin (dB)
1738.8V	59	-54	0.85	8.8	6.65	-48.2	-13	-35.2
1738.8H	56	-61	0.85	8.8	6.65	-55.2	-13	-42.2
2608.2V	52.5	-58	1	9	6.85	-52.15	-13	-39.15
2608.2H	52.2	-63	1	9	6.85	-57.15	-13	-44.15
3477.6V	63	-43	1.2	8.1	5.95	-38.25	-13	-25.25
3477.6H	59.9	-51	1.2	8.1	5.95	-46.25	-13	-33.25
4347*	42.6	-80	1.45	10.3	8.15	-73.3	-13	-60.3
5216.4*	42.8	-70	1.57	10	7.85	-63.72	-13	-50.72
6085.8*	44.5	-70	1.75	9.9	7.75	-64	-13	-51
6955.2*	45.8	-70	1.9	10	7.85	-64.05	-13	-51.05
7824.6*	45.5	-70	2	10.2	8.05	-63.95	-13	-50.95
8694*	45.6	-66	2.1	10.3	8.15	-59.95	-13	-46.95

**fo = 881.5 MHz (MID)**

frequency (MHz)	SA reading (dBuV)	SG reading (dBm)	CL (dB)	Gain (dBi)	Gain (dBd)	ERP (dBm)	Limit (dBm)	Margin (dB)
1763V	65.6	-48	0.85	8.8	6.65	-42.2	-13	-29.2
1763H	61.1	-56	0.85	8.8	6.65	-50.2	-13	-37.2
2644.5V	55.2	-55	1	9	6.85	-49.15	-13	-36.15
2644.5H	50.7	-65	1	9	6.85	-59.15	-13	-46.15
3526V	63.8	-42	1.2	8.1	5.95	-37.25	-13	-24.25
3526H	62.8	-48	1.2	8.1	5.95	-43.25	-13	-30.25
4407.5*	42.6	-80	1.45	10.3	8.15	-73.3	-13	-60.3
5289*	42.8	-70	1.57	10	7.85	-63.72	-13	-50.72
6170.5*	44.5	-70	1.75	9.9	7.75	-64	-13	-51
7052*	45.8	-70	1.9	10	7.85	-64.05	-13	-51.05
7933.5*	45.5	-70	2	10.2	8.05	-63.95	-13	-50.95
8815*	45.6	-66	2.1	10.3	8.15	-59.95	-13	-46.95

*fo = 893.6 MHz (HIGH)*

frequency (MHz)	SA reading (dBuV)	SG reading (dBm)	CL (dB)	Gain (dBi)	Gain (dBd)	ERP (dBm)	Limit (dBm)	Margin (dB)
1787.2V	67.7	-46	0.85	8.8	6.65	-40.2	-13	-27.2
1787.2H	61.4	-56	0.85	8.8	6.65	-50.2	-13	-37.2
2680.8V	58.6	-52	1	9	6.85	-46.15	-13	-33.15
2680.8H	56.3	-59	1	9	6.85	-53.15	-13	-40.15
3574.4V	59.8	-46	1.2	8.1	5.95	-41.25	-13	-28.25
3574.4H	59.5	-51	1.2	8.1	5.95	-46.25	-13	-33.25
4468*	42.6	-80	1.45	10.3	8.15	-73.3	-13	-60.3
5361.6*	42.8	-70	1.57	10	7.85	-63.72	-13	-50.72
6255.2*	44.5	-70	1.75	9.9	7.75	-64	-13	-51
7148.8*	45.8	-70	1.9	10	7.85	-64.05	-13	-51.05
8042.4*	45.5	-70	2	10.2	8.05	-63.95	-13	-50.95
8936*	45.6	-66	2.1	10.3	8.15	-59.95	-13	-46.95

**Checked other spurious from 1GHz to 9 GHz and no emissions found.**

**NOTE: \* Measured noise floor (worse case vertical); H=horizontal and V=vertical**

**SA:** Spectrum Analyzer

**SG:** Signal Generator

**CL:** cable loss (5ft), FLEXCO

**Gain (dBd) = TX Antenna - 2.15**

**EPR = SG reading - CL + Gain (dBd)**

**Margin = EPR - Limit**

**Compliance Certification Services**

Radiated Emissions  
22.917(e)

12/13/01  
A-Site (1 meter)  
Kerwin Corpuz

POWERWAVE

869-894 MHz Single-Channel GSM/EDGE Amplifier (M/N: SCA9350-30)

S/N: PWWT01D35RJC

**fo = 869.4 MHz (LOW)**

frequency (MHz)	SA reading (dBuV)	SG reading (dBm)	CL (dB)	Gain (dBi)	Gain (dBd)	ERP (dBm)	Limit (dBm)	Margin (dB)
1738.8V	48.6	-64	0.85	8.8	6.65	-58.2	-13	-45.2
1738.8H	48.4	-67	0.85	8.8	6.65	-61.2	-13	-48.2
2608.2V	48.5	-62	1	9	6.85	-56.15	-13	-43.15
2608.2H	48.6	-67	1	9	6.85	-61.15	-13	-48.15
3477.6V	57.5	-48	1.2	8.1	5.95	-43.25	-13	-30.25
3477.6H	52.9	-58	1.2	8.1	5.95	-53.25	-13	-40.25
4347*	42.6	-80	1.45	10.3	8.15	-73.3	-13	-60.3
5216.4*	42.8	-70	1.57	10	7.85	-63.72	-13	-50.72
6085.8*	44.5	-70	1.75	9.9	7.75	-64	-13	-51
6955.2*	45.8	-70	1.9	10	7.85	-64.05	-13	-51.05
7824.6*	45.5	-70	2	10.2	8.05	-63.95	-13	-50.95
8694*	45.6	-66	2.1	10.3	8.15	-59.95	-13	-46.95

**fo = 881.5 MHz (MID)**

frequency (MHz)	SA reading (dBuV)	SG reading (dBm)	CL (dB)	Gain (dBi)	Gain (dBd)	ERP (dBm)	Limit (dBm)	Margin (dB)
1763V	56.2	-57	0.85	8.8	6.65	-51.2	-13	-38.2
1763H	53.5	-63	0.85	8.8	6.65	-57.2	-13	-44.2
2644.5V	47.1	-62	1	9	6.85	-56.15	-13	-43.15
2644.5H	47.6	-67	1	9	6.85	-61.15	-13	-48.15
3526V	59.5	-47	1.2	8.1	5.95	-42.25	-13	-29.25
3526H	57.3	-53	1.2	8.1	5.95	-48.25	-13	-35.25
4407.5*	42.6	-80	1.45	10.3	8.15	-73.3	-13	-60.3
5289*	42.8	-70	1.57	10	7.85	-63.72	-13	-50.72
6170.5*	44.5	-70	1.75	9.9	7.75	-64	-13	-51
7052*	45.8	-70	1.9	10	7.85	-64.05	-13	-51.05
7933.5*	45.5	-70	2	10.2	8.05	-63.95	-13	-50.95
8815*	45.6	-66	2.1	10.3	8.15	-59.95	-13	-46.95

*fo = 893.6 MHz (HIGH)*

frequency (MHz)	SA reading (dBuV)	SG reading (dBm)	CL (dB)	Gain (dBi)	Gain (dBd)	ERP (dBm)	Limit (dBm)	Margin (dB)
1787.2V	50	-62	0.85	8.8	6.65	-56.2	-13	-43.2
1787.2H	47.5	-68	0.85	8.8	6.65	-62.2	-13	-49.2
2680.8V	49.5	-60	1	9	6.85	-54.15	-13	-41.15
2680.8H	49.5	-65	1	9	6.85	-59.15	-13	-46.15
3574.4V	59.4	-47	1.2	8.1	5.95	-42.25	-13	-29.25
3574.4H	57.9	-53	1.2	8.1	5.95	-48.25	-13	-35.25
4468*	42.6	-80	1.45	10.3	8.15	-73.3	-13	-60.3
5361.6*	42.8	-70	1.57	10	7.85	-63.72	-13	-50.72
6255.2*	44.5	-70	1.75	9.9	7.75	-64	-13	-51
7148.8*	45.8	-70	1.9	10	7.85	-64.05	-13	-51.05
8042.4*	45.5	-70	2	10.2	8.05	-63.95	-13	-50.95
8936*	45.6	-66	2.1	10.3	8.15	-59.95	-13	-46.95

**Checked other spurious from 1GHz to 10 GHz and no emissions found.**

**NOTE: \* Measured noise floor (worse case vertical); H=horizontal and V=vertical**

**SA:** Spectrum Analyzer

**SG:** Signal Generator

**CL:** cable loss (5ft), FLEXCO

**Gain (dBd) = TX Antenna - 2.15**

**EPR = SG reading - CL + Gain (dBd)**

**Margin = EPR - Limit**



## **RADIATED EMISSION PART 15**

### **RADIATED EMISSION TEST PROCEDURE**

The EUT was placed on a wooden table 80 cm above the ground screen and all other support equipment were placed on the flush mounted turntable. Antenna to EUT distance was at 3 meter, measured E-Field with the range of 30M – 1GHz and a distance of 1 meter, measured 1GHz and above frequency. During the test, the table is rotated 360 degrees to maximize emissions and the antenna is positioned from 1 to 4 meters above the ground screen to further maximize emissions. The antenna is polarized in both vertical and horizontal positions.

EUT test configuration is according to Section 8 of ANSI C63.4/1992.

Monitor the frequency range of interest at a fixed antenna height and EUT azimuth. Frequency span should be small enough to easily differentiate between broadcast stations and intermittent ambient. Rotate EUT 360 degrees to maximize emissions received from EUT. If emission increases by more than 1 dB, or if another emission appears that is greater by 1 dB, return to azimuth where maximum occurred and perform additional cable manipulation to further maximize received emission.

Move antenna up and down to further maximize suspected highest amplitude signal. If emission increased by 1 dB or more, or if another emission appears that is greater by 1dB or more, return to antenna height where maximum signal was observed and manipulate cables to produce highest emissions, noting frequency and amplitude.

#### **Test Result:**

See attached file below.



FCC, VCCI, CISPR, CE, AUSTEL, NZ  
UL, CSA, TUV, BSMI, DHHS, NVLAP

561F MONTEREY ROAD, SAN JOSE, CA 95037-9001  
PHONE: (408) 463-0885 FAX: (408) 463-0888

*Project #:* 01U1077-1

*Report #:* 011213A1

*Date & Time:* 12/13/01 10:31 AM

*Test Engr:* KERWIN CORPUZ

*Company:* POWERWAVE TECHNOLOGIES

*EUT Description:* 869-894MHz Single Channel GSM/EDGE Amp(SCA9350-30)

*Test Configuration :* EUT and support equipments

*Type of Test:* FCC15 subpart B

*Mode of Operation:* TX with EDGE

A-Site

B-Site

C-Site

F-Site

6 Worst Data

Descending

Freq.	Reading	AF	Closs	Pre-amp	Level	Limit	Margin	Pol	Az	Height	Mark
(MHz)	(dBuV)	(dB)	(dB)	(dB)	(dBuV/m)	FCC_B	(dB)	(H/V)	(Deg)	(Meter)	(P/Q/A)
160.02	12.90	11.66	1.70	0.00	26.26	43.50	-17.24	3mV	180.00	1.00	P
128.04	15.40	14.13	1.54	0.00	31.07	43.50	-12.43	3mV	180.00	1.00	P
144.04	14.60	13.15	1.60	0.00	29.35	43.50	-14.15	3mV	180.00	1.00	P
166.01	14.70	11.62	1.72	0.00	28.04	43.50	-15.46	3mV	180.00	1.00	P
176.00	15.60	11.67	1.74	0.00	29.01	43.50	-14.49	3mV	180.00	1.00	P
192.00	15.50	11.19	1.84	0.00	28.53	43.50	-14.97	3mV	180.00	1.00	P
297.06	13.00	14.94	2.38	0.00	30.32	46.00	-15.68	3mV	90.00	1.00	P
128.05	11.80	13.43	1.54	0.00	26.78	43.50	-16.72	3mH	135.00	2.80	P

COMPLETED SCAN 30 - 1000MHz, VERTICAL AND HORIZONTAL POLARIZATION with BILOG ANTENNA  
SPOT CHECK WITH GSM and EDGE MODULATION and EDGE WAS THE WORST CASE.

Total data #: 8  
V.2a