

TABLE OF CONTENTS

	Pages
1 GENERAL INFORMATION	<u>3</u>
1.1 Product Description	<u>3</u>
1.2 Related Submittal Grant	<u>7</u>
1.3 Tested System Details	<u>7</u>
1.4 Test Methodology	<u>8</u>
1.5 Test Facility	<u>8</u>
3 SYSTEM TEST CONFIGURATION	<u>9</u>
3.1 Justification	<u>9</u>
3.2 EUT Exercise Software	<u>9</u>
3.3 Special Accessories	<u>9</u>
3.4 Equipment Modifications	<u>9</u>
3.5 Configuration of Tested System	<u>9</u>
4 RADIATED EMISSION DATA	<u>10</u>
Equipment	<u>13</u>
Field Strength Calculation	<u>14</u>
5 CONDUCTED EMISSION DATA	<u>15</u>
Equipment	<u>16</u>
6 Signature page	<u>57</u>

1 GENERAL INFORMATION

1.1 Product Description

EUT Name: Multi-channel Power Amplifier Model: MCA9129-120 S/N:C000001EJH
--

1.0 EUT Documentation

1.1 EUT Description: The MCA9XXX-120 is a linear, feed-forward power amplifier that operates in the 25 MHz frequency band from 869 MHz to 894 MHz. The amplifier can simultaneously transmit multiple frequencies, with better than -65 dBc third order intermodulation distortion (IMD). It is designed for use in an amplifier system that is modular in design, and is ideally suited for use in AMPS/TDMA/CDMA base stations. Each amplifier module has a status connector that allows the host system to monitor the amplifier module performance. The front panel of each amplifier module has unit level status/fault indicators and an RF on/off/reset switch. Primary power for the amplifier is +27 Vdc. Cooling for each plug-in amplifier module is provided by three fans, two mounted on the front and one on the rear of the module. The fans draw outside air through the front of the module and exhaust hot air out through the rear of the module.

1.1.1 Components of EUT

Description	Model Number	Serial Number	FCC ID Number
Multi-channel Power Amplifier	MCA9XXX-120	C000001EJH	E675JS0043

1.2 Operating modes

The MCA9XXX-120 amplifier operates in the 869-894MHz frequency range at an average output power of 120W per module stand-alone. It is capable of amplifying multiple carriers of CDMA, TDMA, or AMPS modulated input signals. The amplifier does not provide any modulation of its own.

1.3 EUT I/O Ports and Cables:

1.3.1 I/O Cables

CONNECTION:	RF In
SHIELD:	Yes
CONNECTORS:	Metal
TERMINATION TYPE:	D-Subminiature
LENGTH:	Not specified
REMOVABLE:	Yes

CONNECTION:	RF Out
SHIELD:	Yes
CONNECTORS:	Metal
TERMINATION TYPE:	D-Subminiature
LENGTH:	Not specified
REMOVABLE:	Yes

CONNECTION:	+/-27 Vdc
SHIELD:	No
CONNECTORS:	Metal
TERMINATION TYPE:	D-Subminiature
LENGTH:	Not specified
REMOVABLE:	Yes

1.3.2 Power Cords

UNIT:	N/A
MANUFACTURER:	
SHIELDED:	
LENGTH:	

1.3.3 Power requirements:

27 VDC 55 Amps

1.4 Oscillator Frequencies

Frequency	EUT Location	Description of use
3.5795 MHz	Loop Ctrl. PCB	Freq. Ref.
8 MHz	Loop Ctrl. and Alarm PCB	Freq. Ref.
10.245 MHz	Loop Ctrl. PCB	Freq. Ref.

1.5 Power Supply

Description	Manufacturer	Model #	Serial #	Switching frequency or linear
N/A Not part of EUT				

1.6 Power Line Filters

Manufacturer	Model #	Qty	LOCATION ON EUT
N/A			

1.7 Critical EMI Components (Capacitors, ferrites, etc.)

Description	Manufacturer	Part # or value	Qty	LOCATION ON EUT
N/A				

1.8 Description of Enclosure: (including Gasketing, Coatings, Bonding, etc.)

Aluminum alloy machined housing with chem-film and paint coatings.

1.9 Interfacing and/or Simulators Peripheral Equipment

DESCRIPTION:	RF Signal Generator (Qty. 2)
MANUFACTURER:	Hewlett Packard
MODEL NUMBER:	E4433B
SERIAL NUMBER:	US38330312, US38440615
FCC ID:	N/A

DESCRIPTION:	DC Power Supply
MANUFACTURER:	Power Ten
MODEL NUMBER:	P62B-30100
SERIAL NUMBER:	1007075
FCC ID:	N/A

DESCRIPTION:	RF Power Meter, Power Sensor
MANUFACTURER:	HP
MODEL NUMBER:	437B, 8481A
SERIAL NUMBER:	3125U21148, US37290513
FCC ID:	N/A

DESCRIPTION:	RF Attenuator / Load
MANUFACTURER:	Lucas Weinschel
MODEL NUMBER:	53-30-34
SERIAL NUMBER:	LN731
FCC ID:	N/A

DESCRIPTION:	RF Attenuator
MANUFACTURER:	Narda
MODEL NUMBER:	766-20
SERIAL NUMBER:	166
FCC ID:	N/A

Report No. 9597-08 (FCC ID: E675JS0035)

1 GENERAL INFORMATION (continued)

1.2 Related Submittal/Grant

None

1.3 Tested System Details

The FCC IDs for all equipment, plus descriptions of all cables used in the tested system are:

None

1.4 Test Methodology

Purpose of Test: To demonstrate compliance with the ANSI C63.4 setup.

- Test Performed:
- X 1. Conducted Emissions, FCC Part 2, Paragraphs 2.1049, and 2.1051 and Part 22, Paragraph 22.917
 - 2. Radiated Emissions EN55022: 1992 Class B limit, 30 - 1,000 MHz, 10 meters
 - X 3. Radiated Emission per FCC Part 2, Paragraph 2.1053, & Part 22, Paragraph 22.917
 - 4. Engineering evaluations
 - 5. Frequency Stability, Part 2, Paragraph 2.995, and Part 87, Paragraph 87.133
 - X 6. RF Output Power, 2.1046

Both Conducted and radiated testing were performed according to the procedures in FCC/ANSI C63.4 and CSA 108.8 - M1983. Radiated testing was performed at an antenna-to-EUT distance of 3 meters (1 - 10 GHz).

1.5 Test Facility

The open area test site and conducted measurement data were tested by:

TÜV PRODUCT SERVICE
10040 Mesa Rim Road
San Diego, CA 92121-2912
Phone: 619 546 3999
Fax: 619 546 0364

The Test Site Data and performance comply with ANSI 63.4 and are registered with the FCC, 7435 Oakland Mills Rd, Columbia Maryland 21046. All Measurement Data is acquired according to the content of FCC Measurement Procedure and ANSI C63.4, unless supplemented with additional requirements as noted in the test report.

2. SYSTEM TEST CONFIGURATION

2.1 Justification

The Multi-channel Power Amplifier, Model MCA9129-120 was initially tested for FCC emission in the following configuration:

See Block Diagram.

2.2 EUT Exercise Software

None

2.3 Special Accessories

None

2.4 Modification

None

2.5 Configuration of Tested System

See Block Diagram.

3 RADIATED EMISSION DATA

The following data lists the significant emission frequencies, measured levels, correction factor (which includes cable and antenna corrections), the corrected reading, and the limit.

See following page(s).

See test setup photos for radiated emissions test setup.





REPORT No: S9597 TESTED BY: J Owen SPEC: FCC Para. 2.1053
 CUSTOMER: Powerwave Technologies TEST DIST: 3
 E U T: Model MCA9129-120 SN: C000001EJH TEST SITE: Roof
 EUT MODE: Normal BICONICAL: N/A
 DATE: 7-Jan-00 LOG: 244
 NOTES: OTHER: 453

Above 1 GHz RBW & VBW = 1 MHz
 Multi-Channel Power Amplifier

v.beta

FREQ (MHz)	VERTICAL (dBuv)		HORIZONTAL (dBuv)		CORRECTION FACTOR (dB/m)	MAX LEVEL (dBuV/m)		SPEC LIMIT (dBuV/m)		MARGIN (dB)		Rotation	EUT	Antenna Height
	pk	av	pk	av		pk	av	pk	av	pk	av			
869	60.6		58.2		26.8	87.4				87.4		357	1	
1738	44.4		44.8		30.1	74.9		84.4		-9.46		350	1.2	
2607	14.5		17.7		35.1	52.8		84.4		-31.6		169	1.2	
3476	16.3		15.1		37.6	53.9		84.4		-30.5		108	1.2	
4345	12.7		13.2		41.5	54.7		84.4		-29.7		166	1.2	
5214	9.9		9.8		42.4	52.3		84.4		-32.1		91	1.2	
6083	12.4		13.1		45.2	58.3		84.4		-26.1		306	1.2	
6952	14.1		13.2		45.4	59.5		84.4		-24.9				
7821	15.8		13.2		47.1	62.9		84.4		-21.5		254	1.2	
8690	13.6		13.2		48.5	62.1		84.4		-22.3				
881.5	62.3		60.8		27.1									
1763	43.4		39.6		30.1	73.5		84.4		-10.9		224	1	
2644.5	16.1		20		35.0	55.0		84.4		-29.4		20	1	
3526	20.3		15.2		39.5	59.8		84.4		-24.6		107	1.2	
4407.5	15		11.8		41.5	56.5		84.4		-27.9		227	1.2	
5289	8.2		10.7		42.4	53.1		84.4		-31.3		126	1.2	
6170.5	12.1		12.4		45.2	57.6		84.4		-26.8				
7052	12.8		12.4		46.1	58.9		84.4		-25.5				
7933.5	17.4		14.3		47.1	64.5		84.4		-19.9		165	1	
8815	18		12.2		48.4	66.4		84.4		-18		263	1.2	
894	61.4		60.1		27.1	88.5				88.5		190	1	
1788	40.8		35.7		30.0	70.8		84.4		-13.6				
2682	17.4		24.3		35.0	59.3		84.4		-25.1		168	1.5	
3576	22.5		18.2		39.5	62.0		84.4		-22.4		229	1	
4470	13.6		13.9		41.6	55.5		84.4		-28.9		167	1.2	
5364	4		4		42.4	46.4		84.4		-38			1	
6258	7		7		45.2	52.2		84.4		-32.2			1	
7152	13		10.5		46.1	59.1		84.4		-25.3		310	1	
8046	13.1		13.1		47.9	61.0		84.4		-23.4				
8940	13.1		13.1		48.4	61.5		84.4		-22.9				

Emissions Test Conditions: RADIATED EMISSIONS, FCC Part 2, Paragraph 2.1053 and Part 22, Paragraph 22.917

The *RADIATED EMISSIONS* measurements were performed at the following test location :

- Test not applicable

■ - Canyon #3, Roof, San Diego

Testing was performed at a test distance of:

- 1 meters

■ - 3 meters

- 10 meters

Test Equipment Used :

Model No.	Prop. No.	Description	Manufacturer	Serial No.	Cal Date
3115	453	Antenna, Double Ridge Guide	EMCO	9412-4363	10/01
3146	244	Antenna, Log Periodic Dipole	EMCO	1063	10/00
8566B	720	Spectrum Analyzer	Hewlett Packard	211500842	03/00
8566B	721	Spectrum Analyzer Display	Hewlett Packard	2112A02185	03/00

Remarks: _____

Field Strength Calculation

If a preamplifier was used during the Radiated Emission Testing, it is required that the amplifier gain must be subtracted from the Spectrum Analyzer (Meter) Reading. In addition, a correction factor for the antenna, cable used and a distance factor, if any, must be applied to the Meter Reading before a true field strength reading can be obtained. In the automatic measurement, these considerations are automatically presented as a part of the print out. In the case of manual measurements and for greater efficiency and convenience, instead of using these correlation factors for each meter reading, the specification limit was modified to reflect these correlation factors at each frequency value so that the meter readings can be compared directly to the modified specification limit. This modified specification limit is referred to as the "Corrected Meter Reading Limit" or simply the CMRL, which is the actual field strength present at the antenna. The quantity can be derived in the following manner:

$$\text{Corrected Meter Reading Limit (CMRL)} = \text{SAR} + \text{AF} + \text{CL} - \text{AG} - \text{DC}$$

Where, SAR = Spectrum Analyzer Reading
AF = Antenna Factor
CL = Cable Loss
AG = Amplifier Gain (if any)
DC = Distance Correction (if any)

Assume the following situation: A meter reading of 29.4 dBuV was obtained from a Class A computing device measured at 83 MHz. Assume an antenna factor of 9.2 dB, a cable loss of 1.4 dB and amplifier gain of 20.0 dB at 83 MHz. The final field strength would be determined as follows:

$$\text{CMRL} = 29.4 \text{ dBuV} + 9.2 \text{ dB} - 1.4 \text{ dB} - 20 \text{ dB/M} - 0.0 \text{ dB}$$

$$\text{CMRL} = 20.0 \text{ dBuV/M}$$

This result is well below the FCC and CSA Class A limit of 29.5 dbuV/m at 83 MHz.

For the manual mode of measurement, a table of corrected meter reading limit was used to permit immediate comparison of the meter reading to determine if the measure emission amplitude exceeded the specification limit at that specific frequency.

4 CONDUCTED EMISSION DATA

POWERWAVE TECHNOLOGIES

Multi-channel Power Amplifier, Model MCA9129-120

See following page(s).

Emissions Test Conditions: CONDUCTED EMISSIONS, FCC Part 2, Paragraphs 2.1046, 2.1047, 2.1049, 2.1051

The *RADIATED EMISSIONS* measurements were performed at the following test location :

- Test not applicable

■ - SR-3, Shielded Room, 12' x 20' x 8', Metal Chamber

Test Equipment Used :

Equipment List, Part 2, Paragraph 2.1049, 2.1051 and Intermodulation

- Signal Generator, Model E4433B, Hewlett Packard, S/N US38330312, 03/00
- Signal Generator, Model E4432B, Hewlett Packard, S/N US38080330312, 09/00
- Spectrum Analyzer/Display, Model HP-8566B, Hewlett Packard, S/N 2618A02913, P/N 744, 08/00
- Power Sensor, Model 8481A, Hewlett Packard, S/N US37290513, 12/00
- Power Meter, Model HP437B, Hewlett Packard, S/N 3125U21148, 10/00
- High Frequency Cable, Micropore, P/N 787, 10/00
- Attenuator, Narda, Model 766-20, 06/01
- 50 W Amp Load, Model 53-30-34, Weinschel, S/N LN 731, NCR
- Attenuator, Narda, Model 766-20 757C-10, 06/01
- 120 Amp Load, Model 53-20-34, Weinschel, S/N LK 446, NCR

Remarks: _____

REPORT NO: 9597

DATE: 06 January 2000

TEST: RF Output Power

CUSTOMER: POWERWAVE TECHNOLOGIES

EUT: MCA9129-120 Multi-Channel Power Amplifier

SPECIFICATION: FCC Part 2, Paragraph 2.1046 and RSS-131, Section 6.3

Frequency (MHz)	Modulation	Output Power (Watts)
f ₁ = 869 f ₂ = 894	Amps Data	120
f ₁ = 869 f ₂ = 894	TDMA	120
f ₁ = 869 f ₂ = 894	CDMA	120
f ₁ = 869 f ₂ = 894	Amps voice	120

NOTE: Measured at antenna port

Test Setup for Occupied Bandwidth, Spurious Emissions and Intermodulation

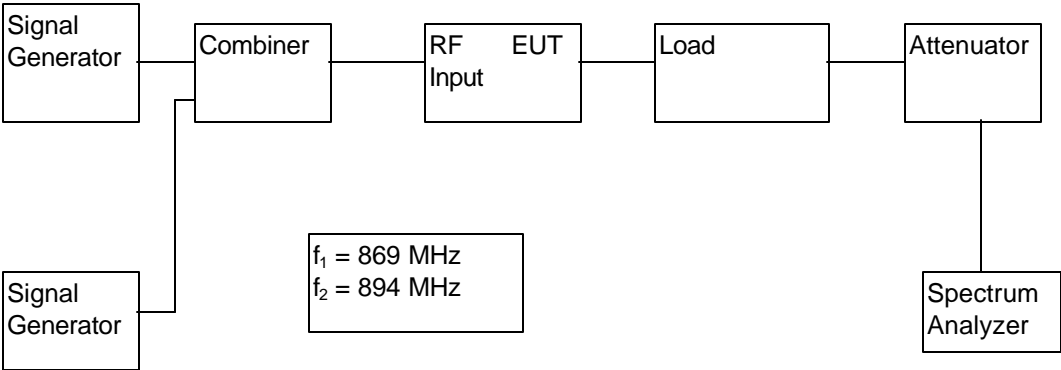

Input Plot Test Setup

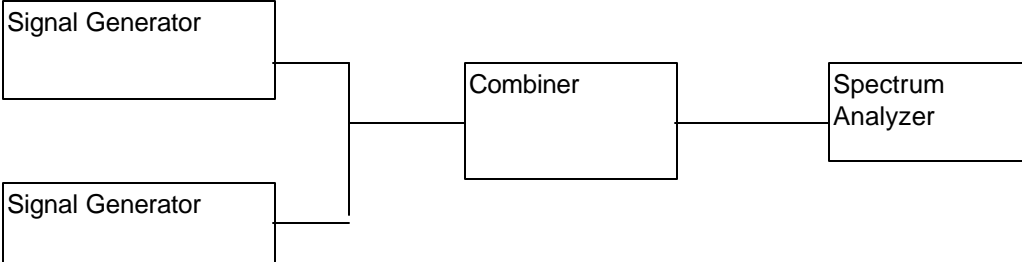

Test Setup for RF Output Power

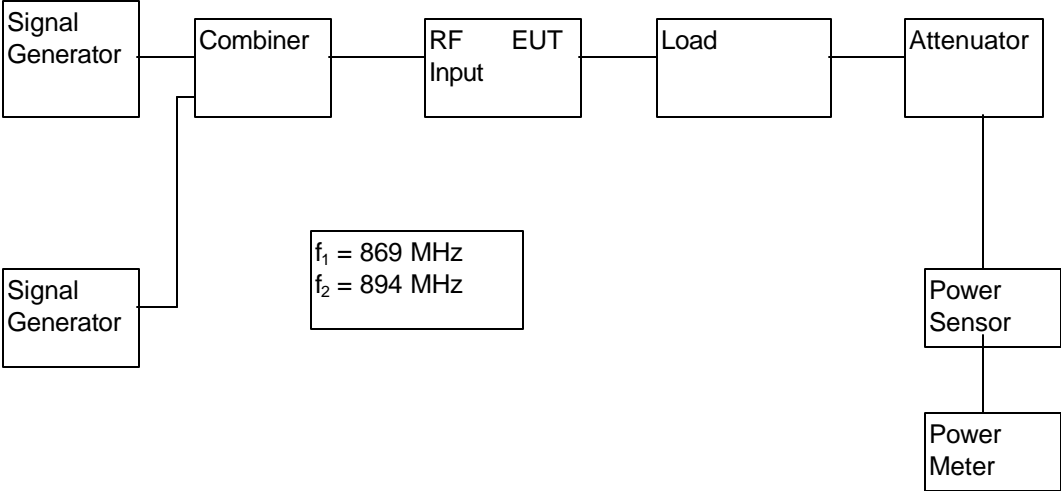

DATE: 01/06/00

CLIENT: POWERWAVE TECHNOLOGIES, INC. EUT: MCA9129-120 Multi-Channel Power Amplifier
 TEST: Occupied Bandwidth SPECIFICATION: FCC Part 2, Paragraph 2.1049 (RSS-131, Section 6.2)

NOTES: 1. $f_1 = 869$ MHz
 2. $f_2 = 894$ MHz
 3. TDMA

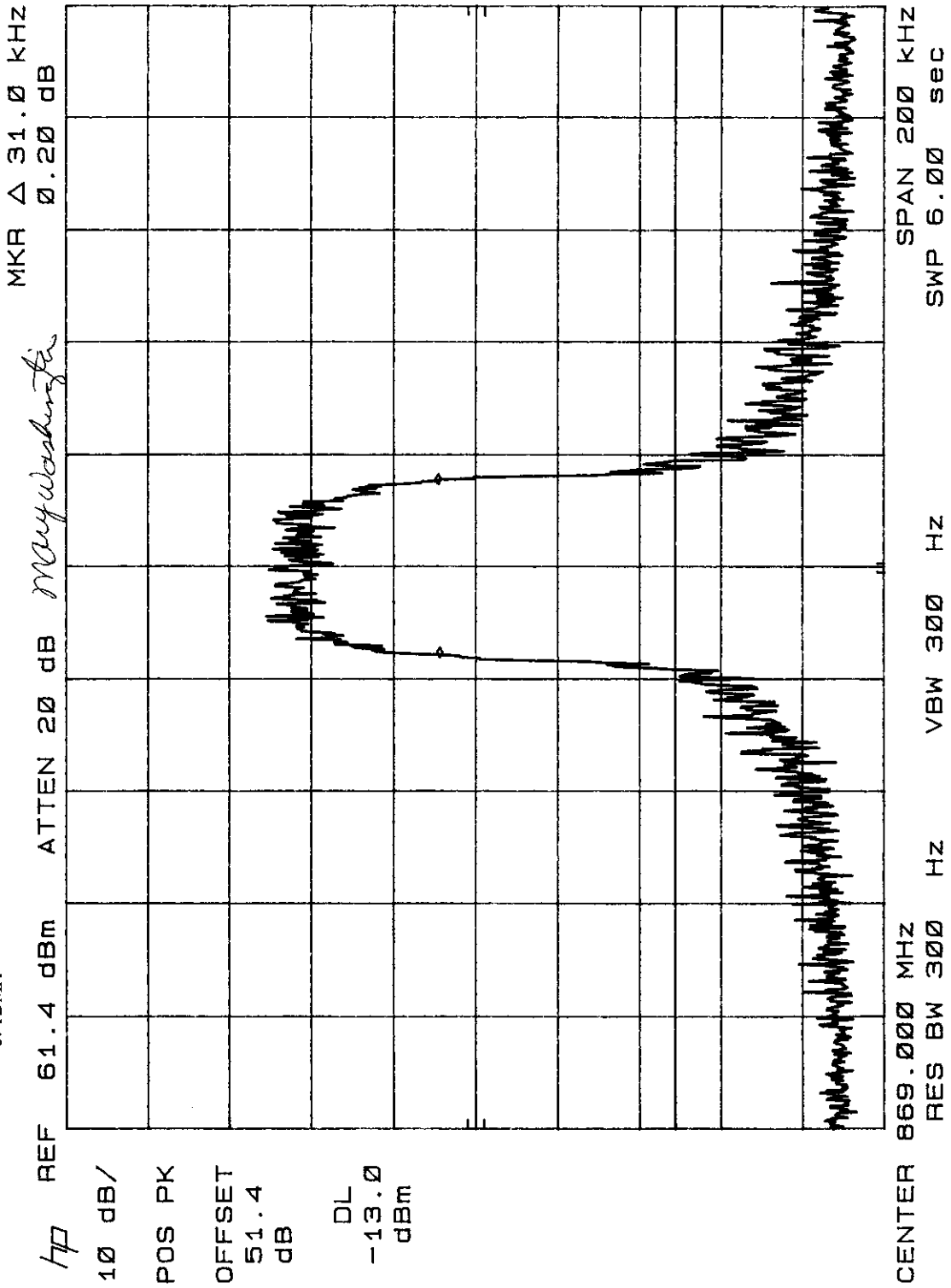

DATE: 01/06/00

CLIENT: POWERWAVE TECHNOLOGIES, INC. EUI: MCA9129-120 Multi-Channel Power Amplifier
TEST: Occupied Bandwidth SPECIFICATION: FCC Part 2, Paragraph 2.1049 (RSS-131, Section 6.2)

NOTES: 1. $f_c = 869$ MHz
2. $f_s = 894$ MHz
3. TDMA

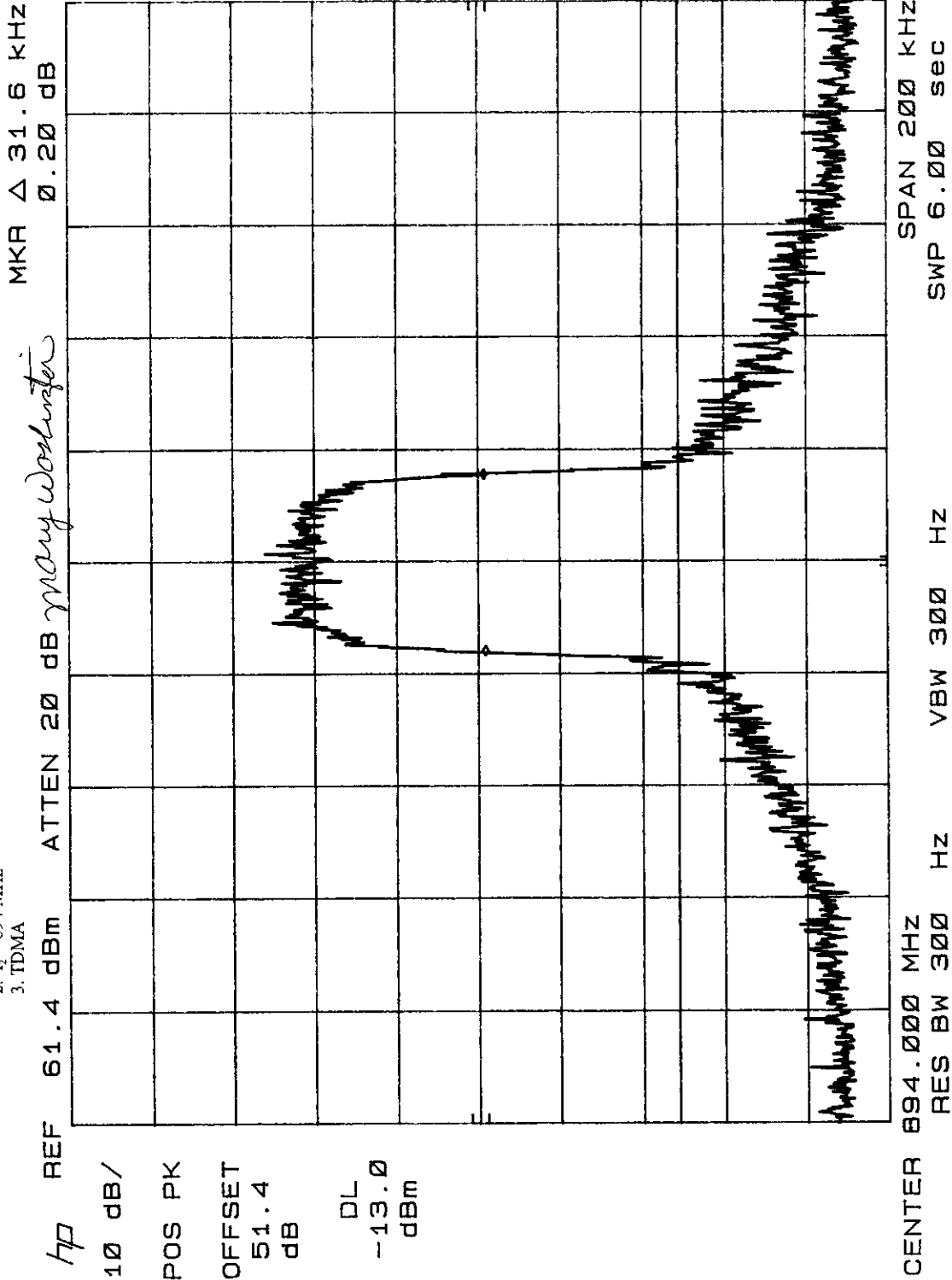

CLIENT: POWERWAVE TECHNOLOGIES, INC. E.U.I.: MCA9129-120 MHz Channel 199A
 TEST: Occupied Bandwidth SPECIFICATION: FCC Part 2, Paragraph 2.1049 (RSS-131, Section 6.2)
 NOTES: 1. $f_c = 869$ MHz
 2. $f_s = 894$ MHz
 3. Amps voice

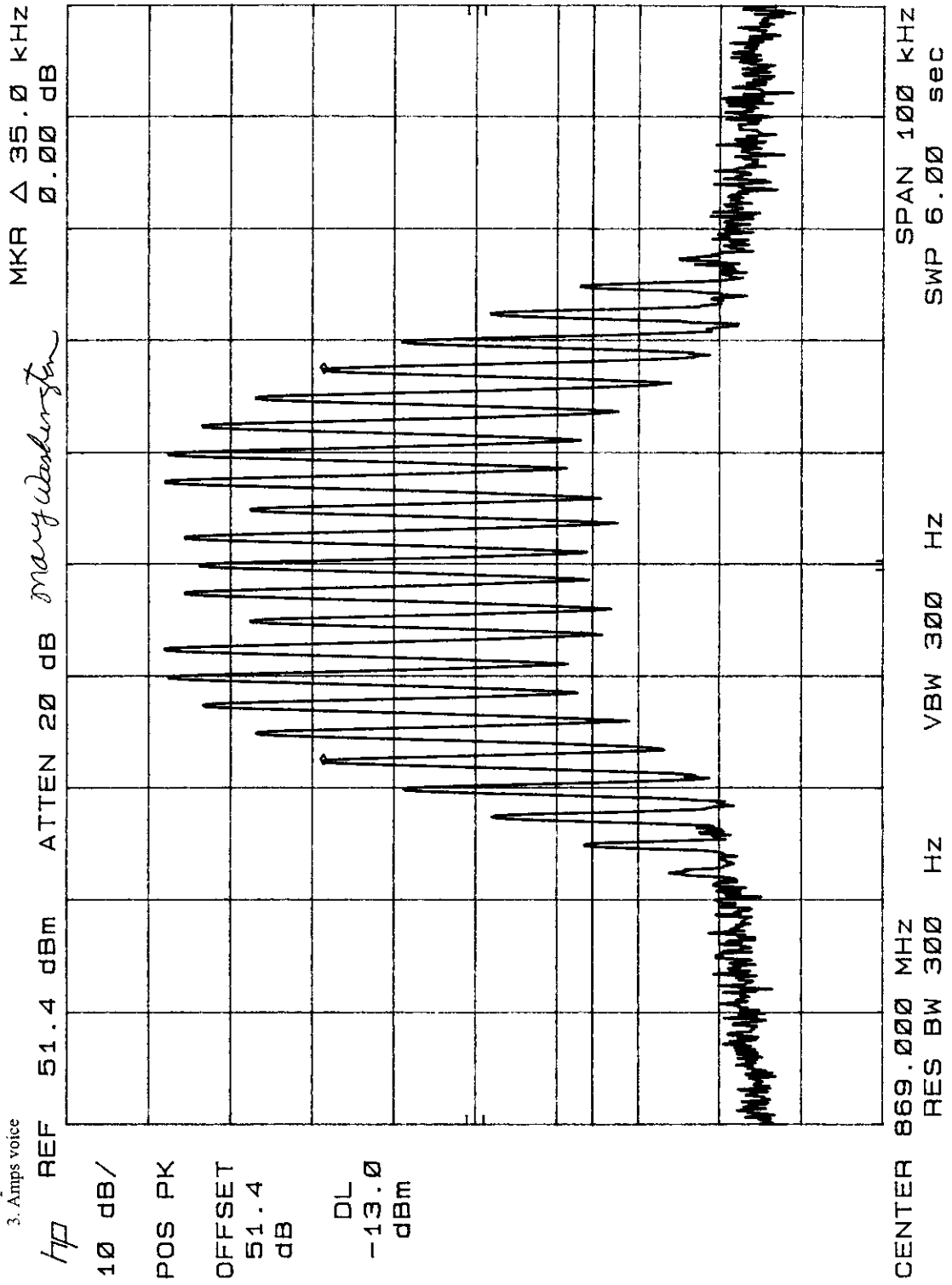

CLIENT: POWERWAVE TECHNOLOGIES, INC. EUT: MCA9129-120 Multi-Channel Power Amplifier DATE: 01/06/00
 TEST: Occupied Bandwidth SPECIFICATION: FCC Part 2, Paragraph 2.1049 (RSS-131, Section 6.2)
 NOTES: 1. $f_1 = 869$ MHz
 2. $f_2 = 894$ MHz
 3. Amps voice

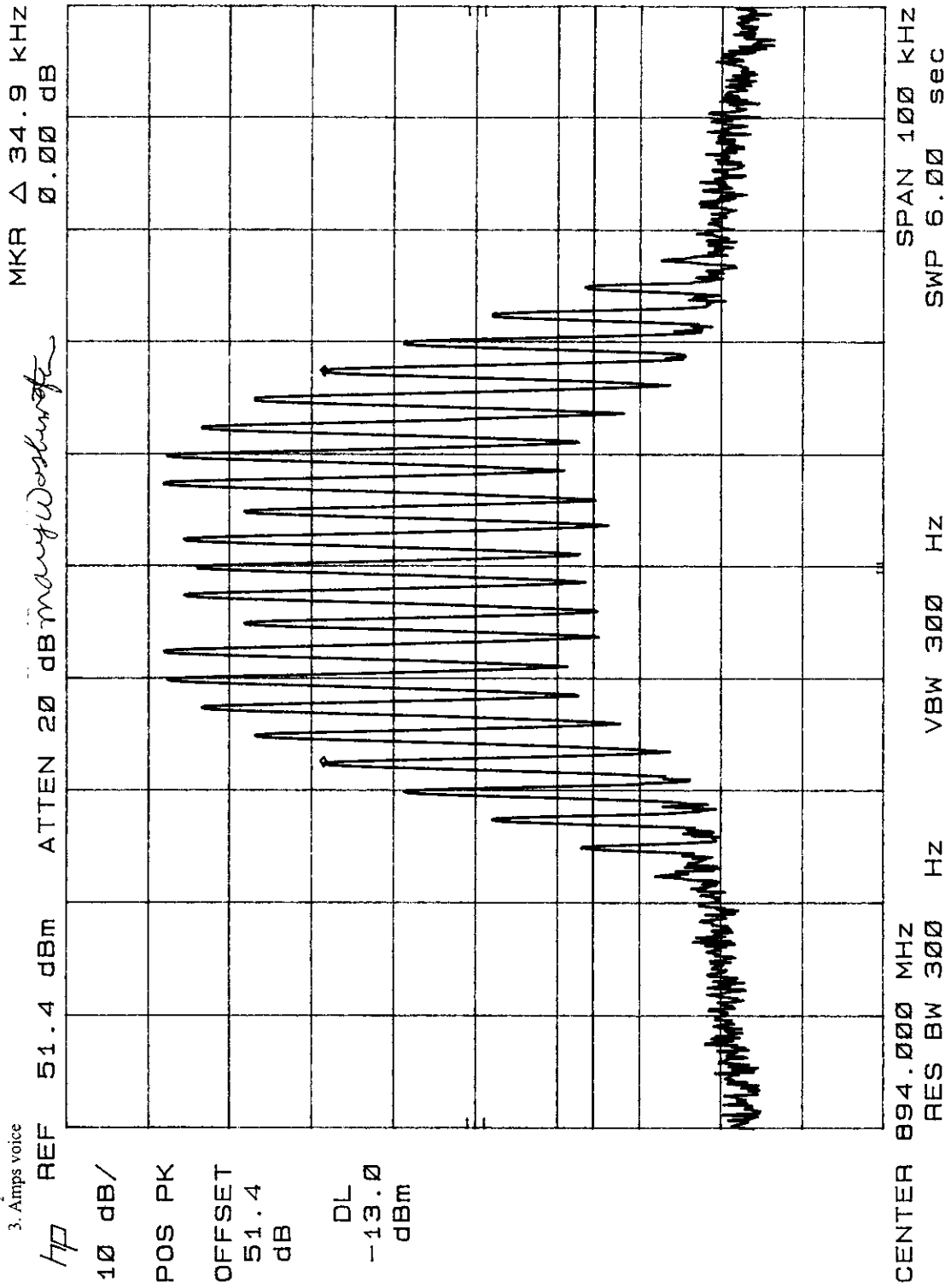

DATE: 01/06/00

CLIENT: POWERWAVE TECHNOLOGIES, INC. EUI: MCA9129-120 Multi-Channel Power Amplifier
 TEST: Occupied Bandwidth SPECIFICATION: FCC Part 2, Paragraph 2.1049 (RSS-131, Section 6.2)

NOTES: 1. $f_1 = 869$ MHz
 2. $f_2 = 894$ MHz
 3. Amps data

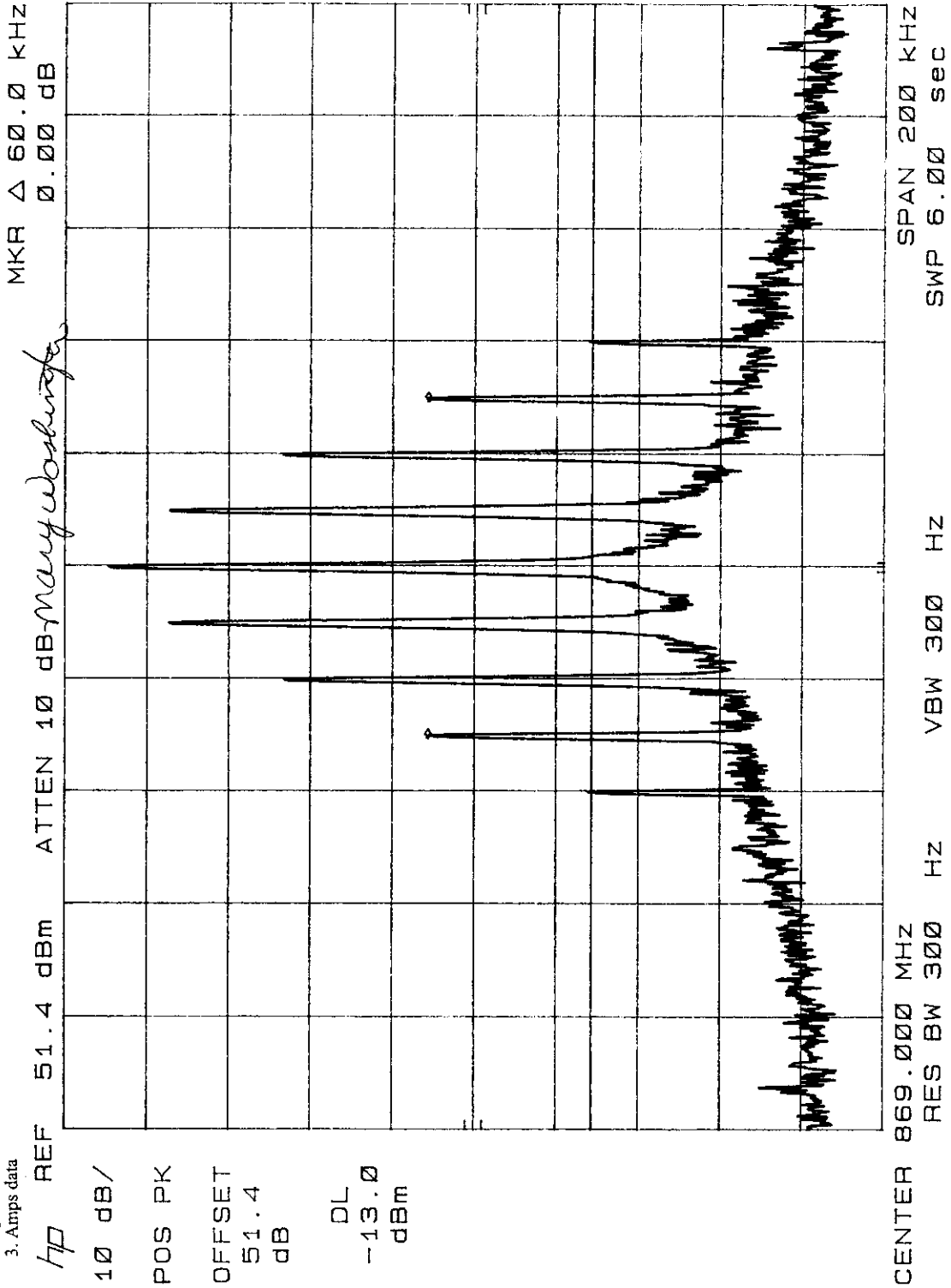

DATE: 01/06/00

CLIENT: POWERWAVE TECHNOLOGIES, INC. EUT: MCA9129-120 Multi-Channel Power Amplifier
 TEST: Occupied Bandwidth SPECIFICATION: FCC Part 2, Paragraph 2.1049 (RSS-131, Section 6.2)

NOTES: 1. $f_1 = 869$ MHz
 2. $f_2 = 894$ MHz
 3. Amps data

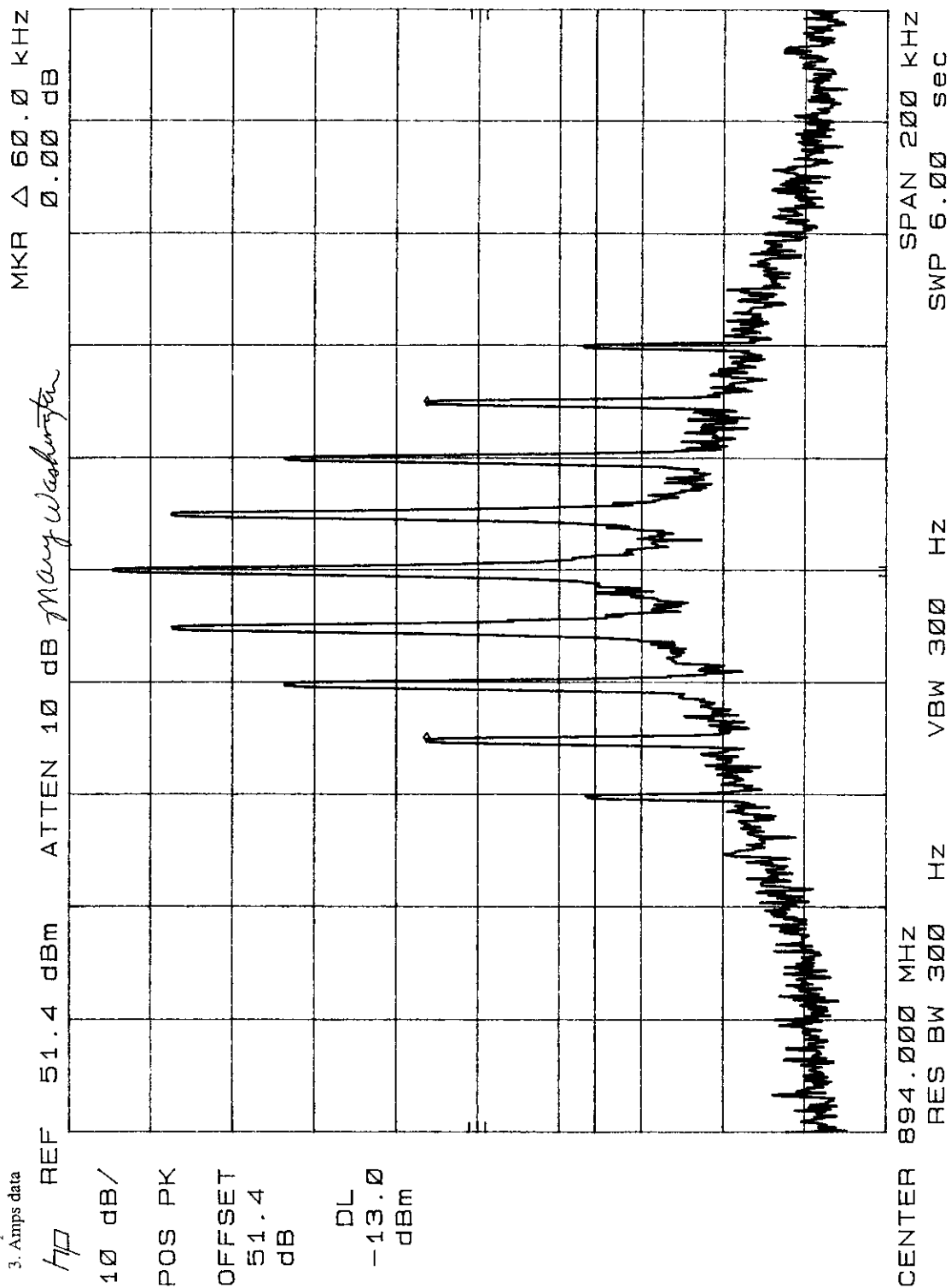

MKR Δ 1.368 MHz
-0.90 dB

many observations

REF 61.4 dBm

hp

10 dB/

POS PK

OFFSET

51.4
dB

DL

-13.0
dBm

ATTEN 20 dB

dBm

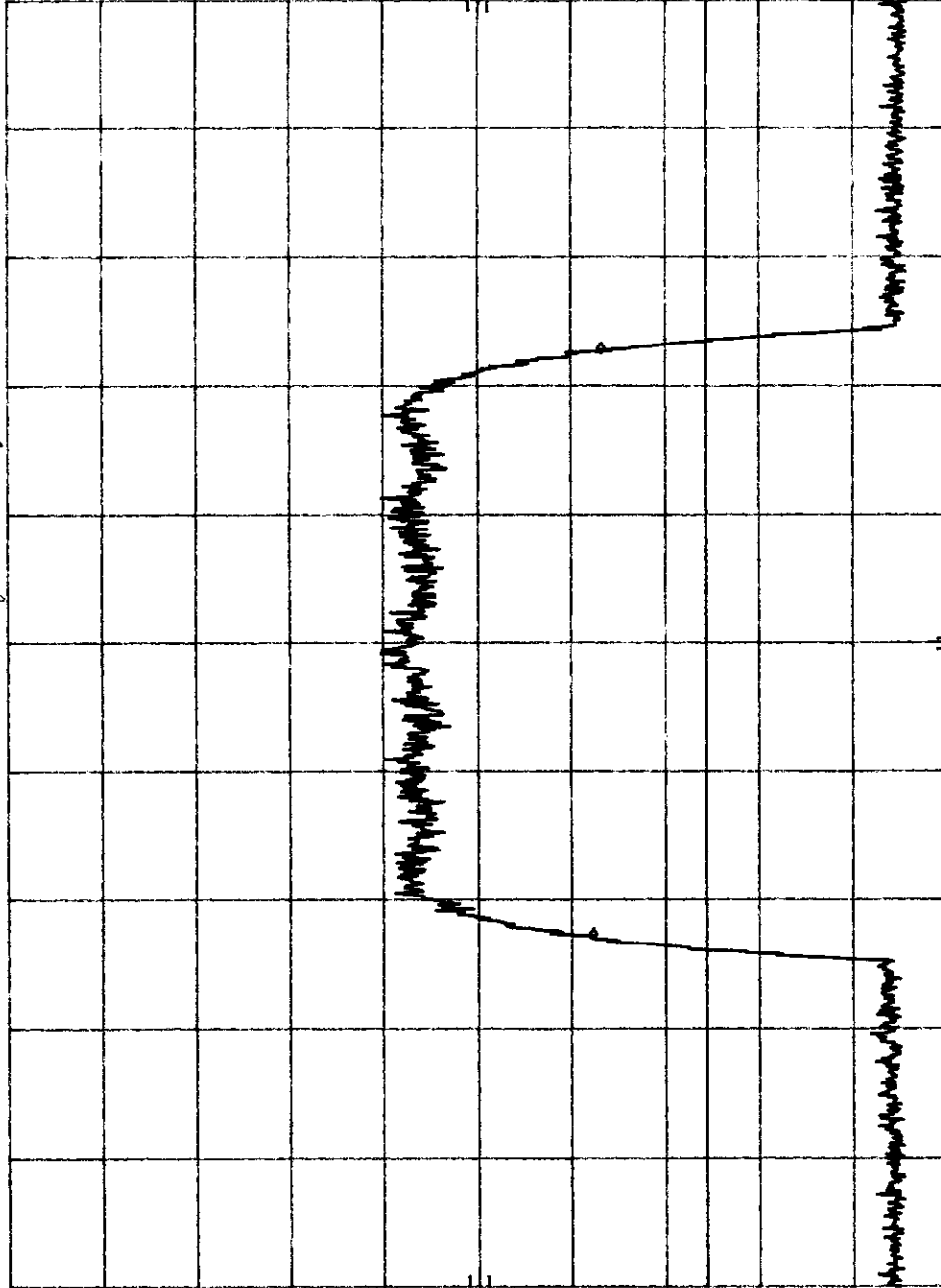

SPAN 3.00 MHz
SWP 90.0 sec

RES BW 300 Hz
VBW 300 Hz

CENTER 894.00 MHz

DATE: 01/06/00

CLIENT: POWERWAVE TECHNOLOGIES, INC. EUT: MCA9129-120 Multi-Channel Power Amplifier
TEST: Occupied Bandwidth SPECIFICATION: FCC Part 2, Paragraph 2.1049 (RSS-131, Section 6.2)

- NOTES: 1. $f_1 = 869$ MHz
- 2. $f_2 = 894$ MHz
- 3. CDMA

DATE: 01/06/00

CLIENT: POWERWAVE TECHNOLOGIES, INC. EUT: MCA9129-120 Multi-Channel Power Amplifier
 TEST: Occupied Bandwidth SPECIFICATION: FCC Part 2, Paragraph 2.1049 (RSS-131, Section 6.2)

NOTES: 1. $f_1 = 869$ MHz
 2. $f_2 = 894$ MHz
 3. CDMA

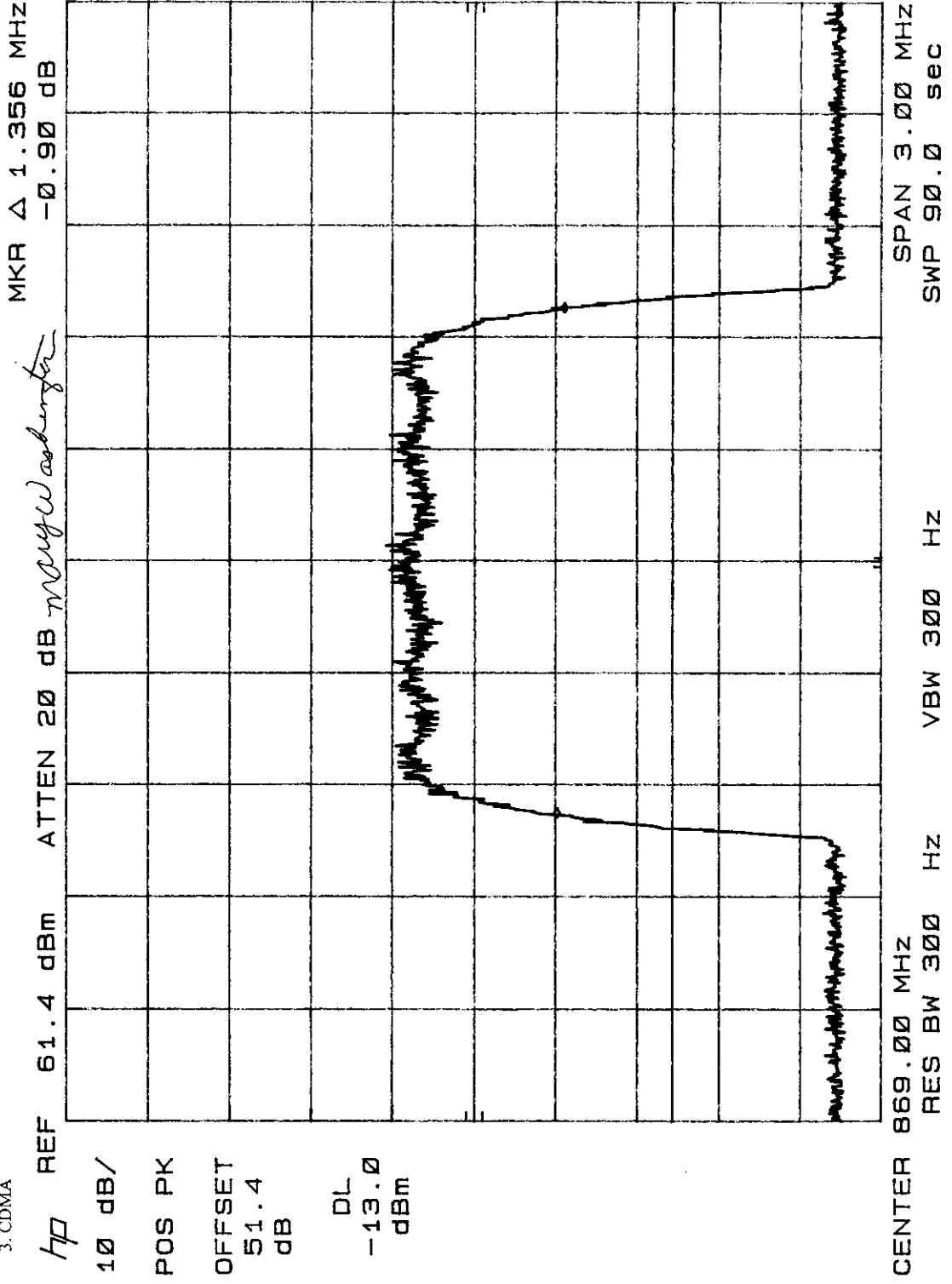

CLIENT: POWERWAVE TECHNOLOGIES, INC. EUI: MCA9129-120 Multi-Channel Power Amplifier DATE: 01/06/00
 TEST: Unwanted Emissions SPECIFICATION: RSS-131, Section 6.6

NOTES: 1. $f_1 = 869$ MHz
 2. $f_2 = 894$ MHz
 3. Amps data

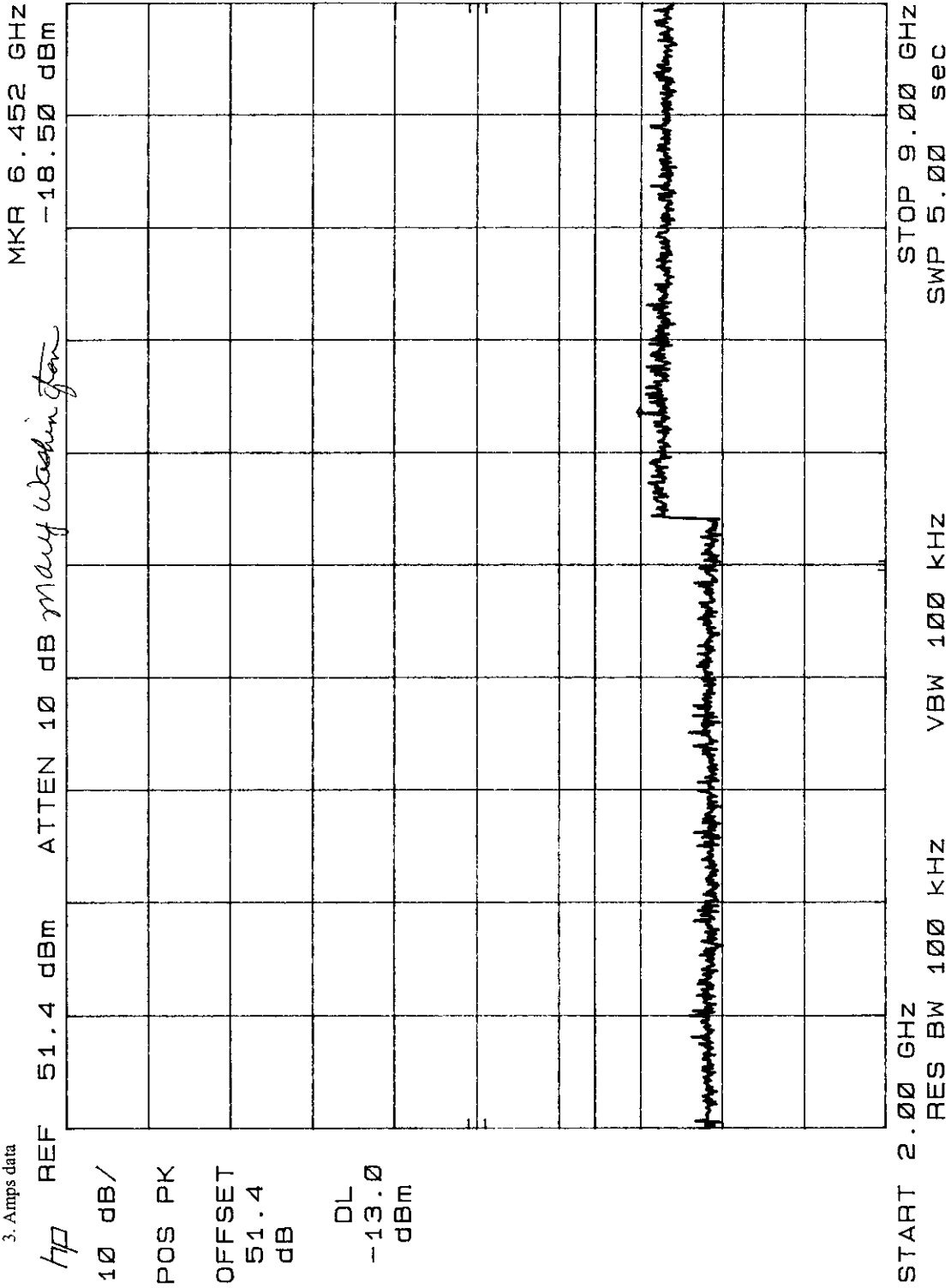

CLIENT: POWERWAVE TECHNOLOGIES, INC. EUT: MCA9129-120 Multi-Channel Power Amplifier DATE: 01/06/00
 TEST: Unwanted Emissions SPECIFICATION: RSS-131, Section 6.6

NOTES: 1. $f_1 = 869$ MHz
 2. $f_2 = 894$ MHz
 3. Amps data

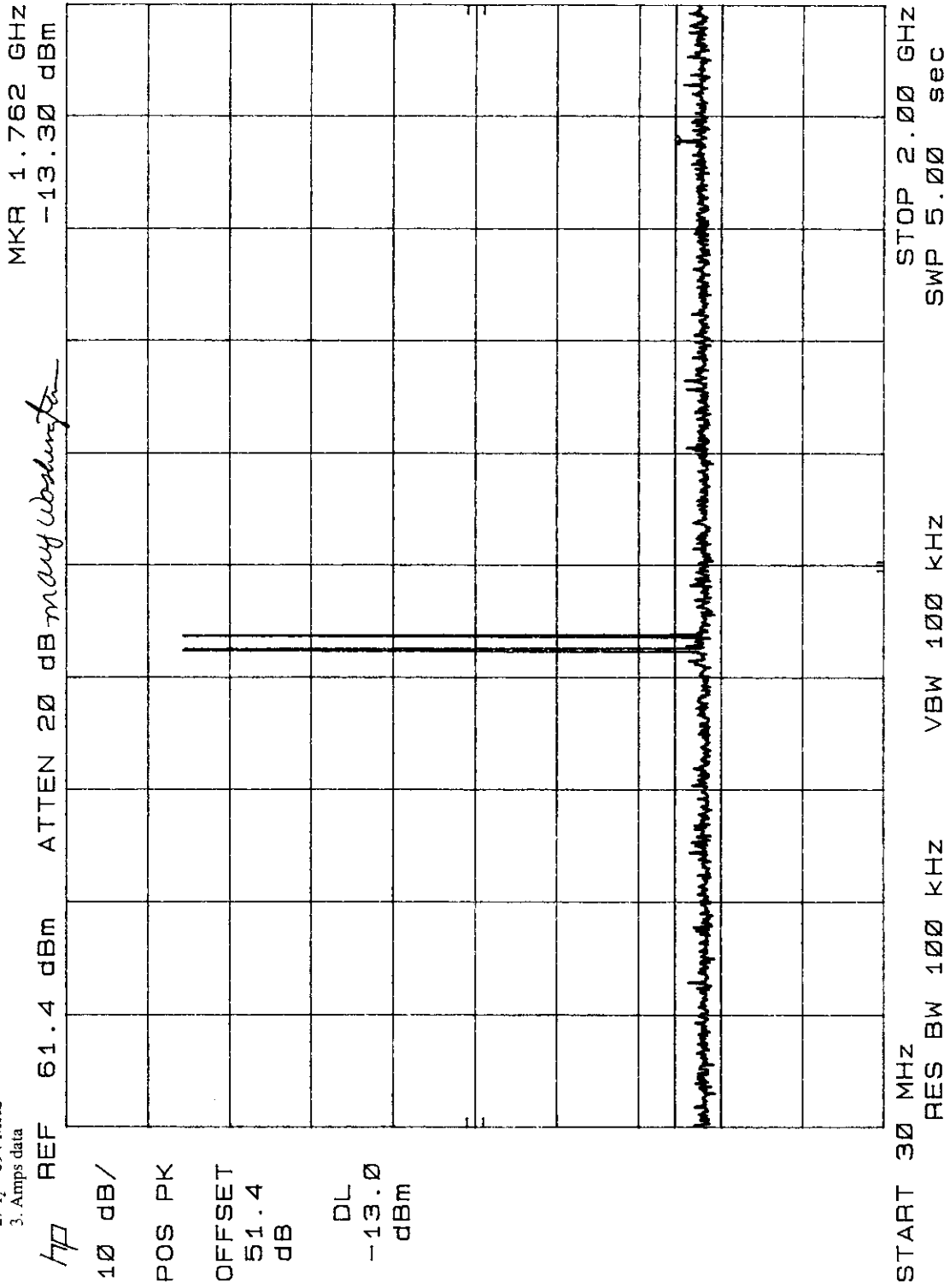

DATE: 01/06/00

CLIENT: POWERWAVE TECHNOLOGIES, INC. EUT: MCA9129-120 Multi-Channel Power Amplifier

TEST: Unwanted Emissions SPECIFICATION: RSS-131, Section 6.6

- NOTES: 1. $f_1 = 869$ MHz
 2. $f_2 = 894$ MHz
 3. CDMA

MKR 6.697 GHz
 -19.10 dBm

hp REF 51.4 dBm ATTEN 10 dB *very wide*

10 dB/
 POS PK
 OFFSET
 51.4
 dB
 DL
 -13.0
 dBm

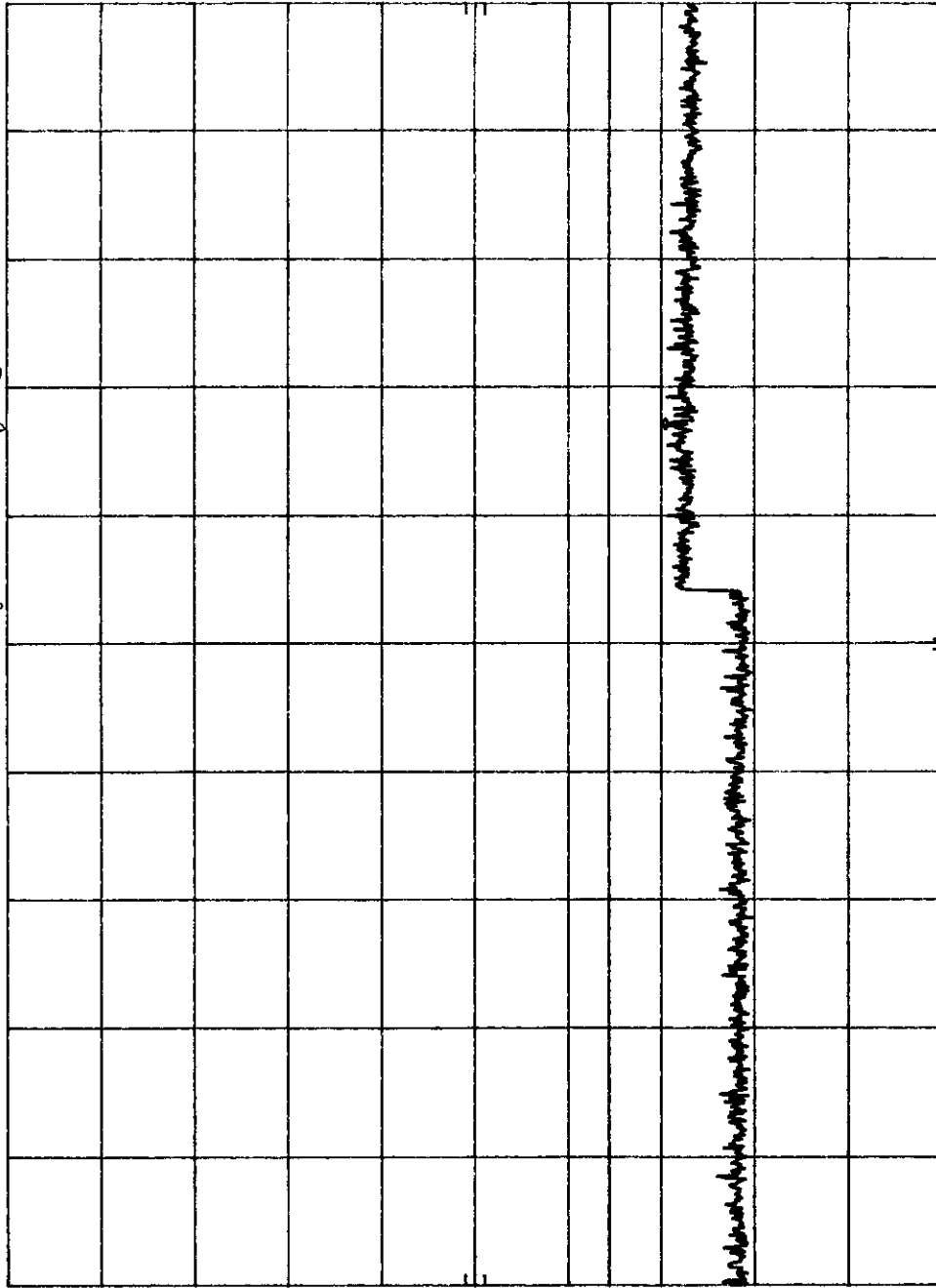

START 2.00 GHz RES BW 100 KHZ VBW 100 KHZ STOP 9.00 GHz
 SWP 5.00 sec

CLIENT: POWERWAVE TECHNOLOGIES, INC. E.U.I. #0007127-120 (MULTI-STANDARD) UWB-L Output

DATE: 01/09/09

TEST: Unwanted Emissions SPECIFICATION: RSS-131, Section 6.6

- NOTES: 1. $f_1 = 869$ MHz
 2. $f_2 = 894$ MHz
 3. CDMA

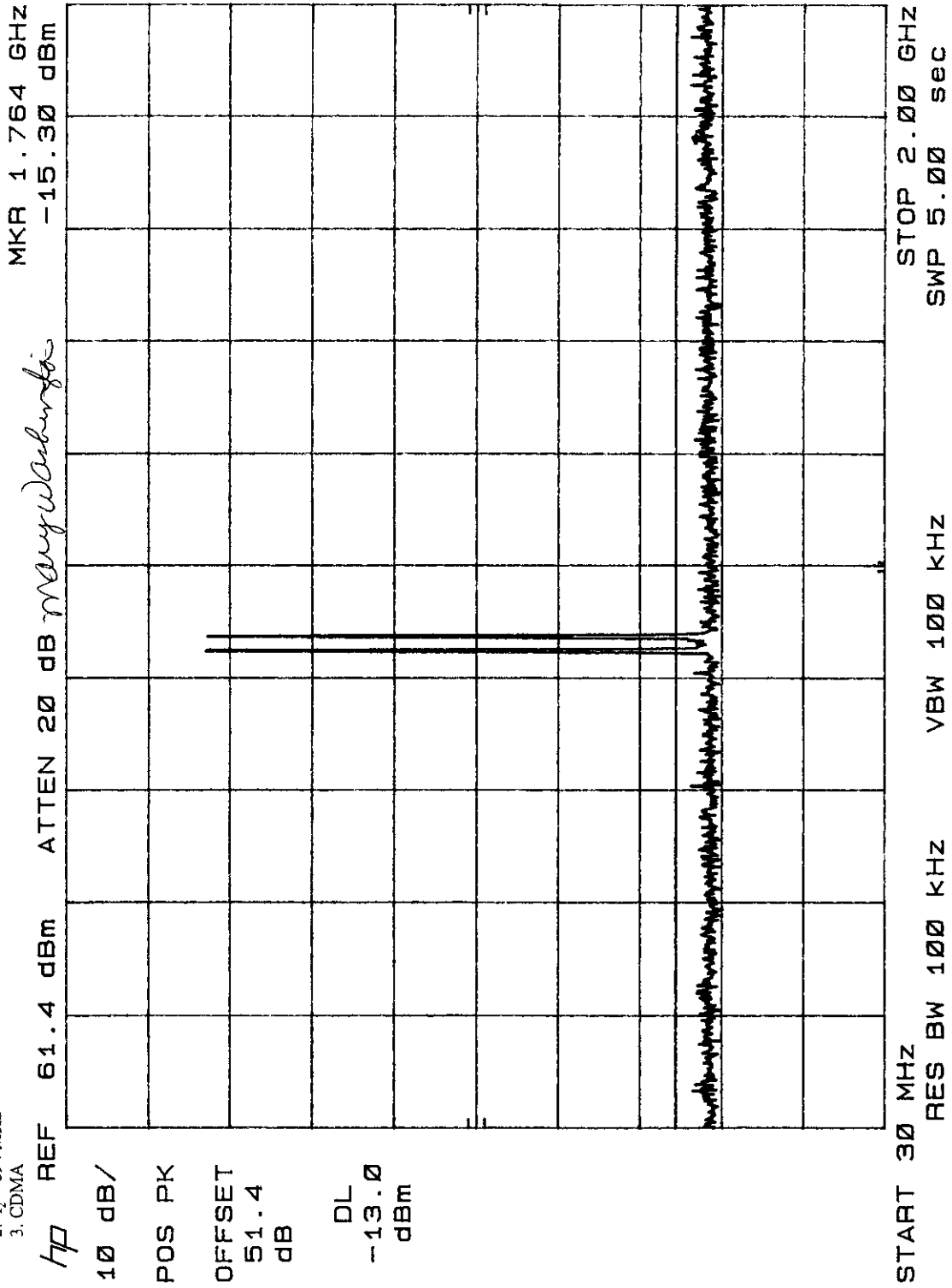

CLIENT: POWERWAVE TECHNOLOGIES, INC. EUT: MCA9129-120 Multi-Channel Power Amplifier DATE: 01/06/00
 TEST: Unwanted Emissions SPECIFICATION: RSS-131, Section 6.6
 NOTES: 1. $f_1 = 869$ MHz
 2. $f_2 = 894$ MHz
 3. TDMA

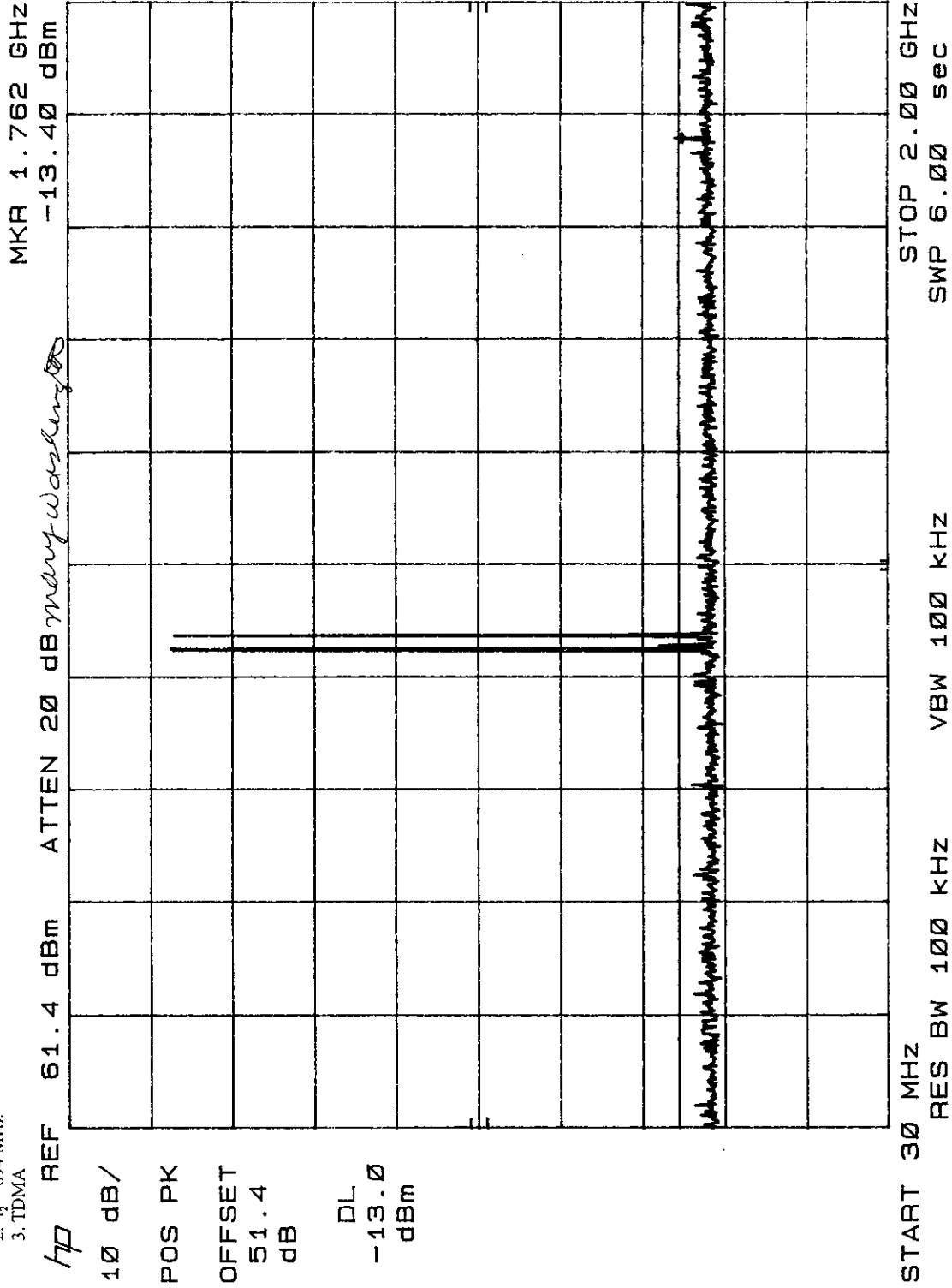

CLIENT: POWERWAVE TECHNOLOGIES, INC. EUT: MCA9129-120 Multi-Channel Power Amplifier DATE: 01/06/00
 TEST: Unwanted Emissions SPECIFICATION: RSS-131, Section 6.6
 NOTES: 1. $f_1 = 869$ MHz
 2. $f_2 = 894$ MHz
 3. TDMA

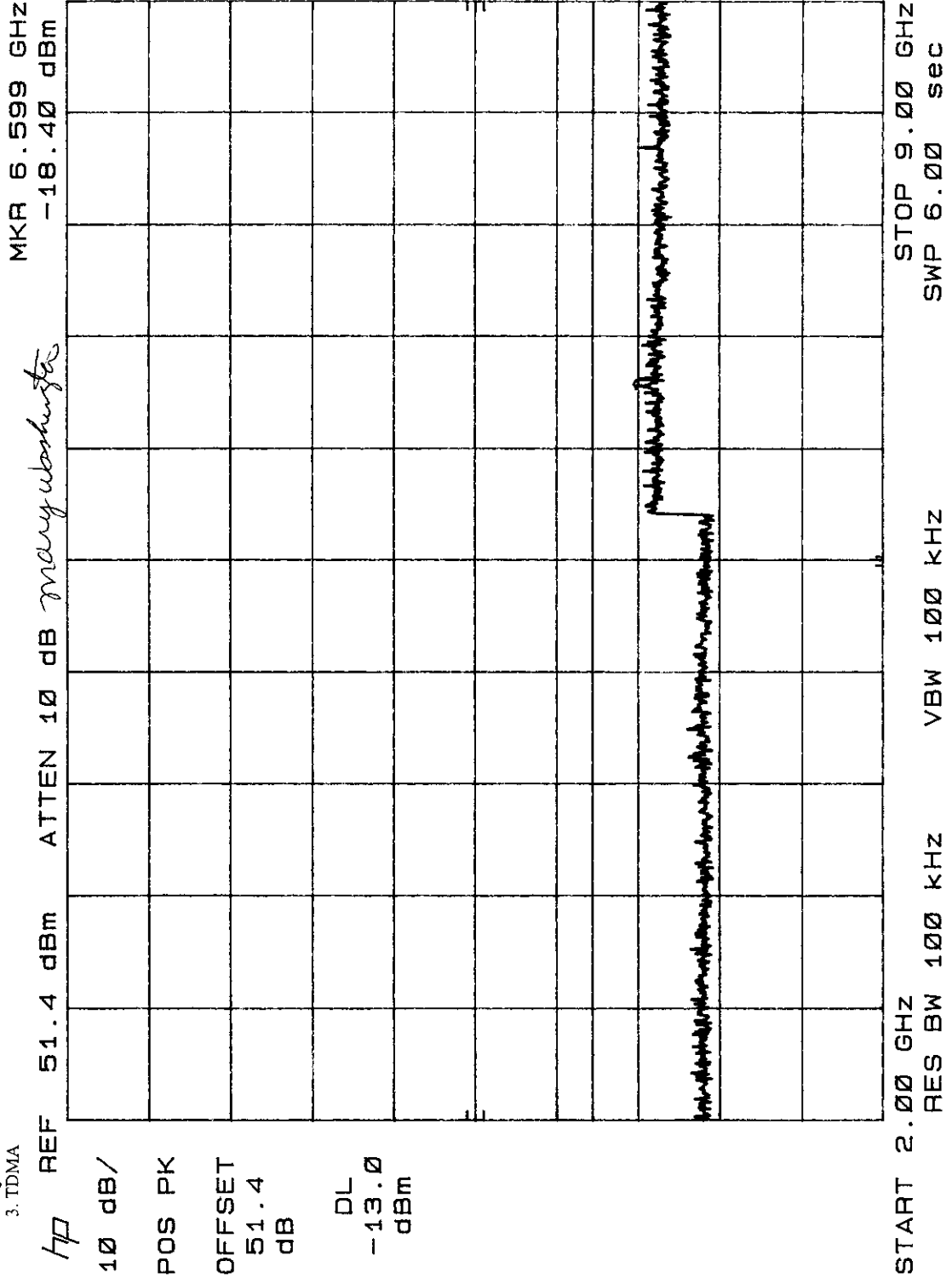

COMMUNICATIONS TECHNOLOGIES, INC. 1011 WOODLARK DRIVE, SUITE 1000, WASHINGTON, DC 20004
 TEST: Unwanted Emissions SPECIFICATION: RSS-131, Section 6.6 DATE: 01/09/00

NOTES: 1. $f_1 = 869$ MHz
 2. $f_2 = 894$ MHz
 3. Amps voice

MKR 6.970 GHz
 -19.00 dBm

hp REF 51.4 dBm ATTN 10 dB *mary washington*

10 dB/

POS PK

OFFSET

51.4 dB

DL
 -13.0 dBm

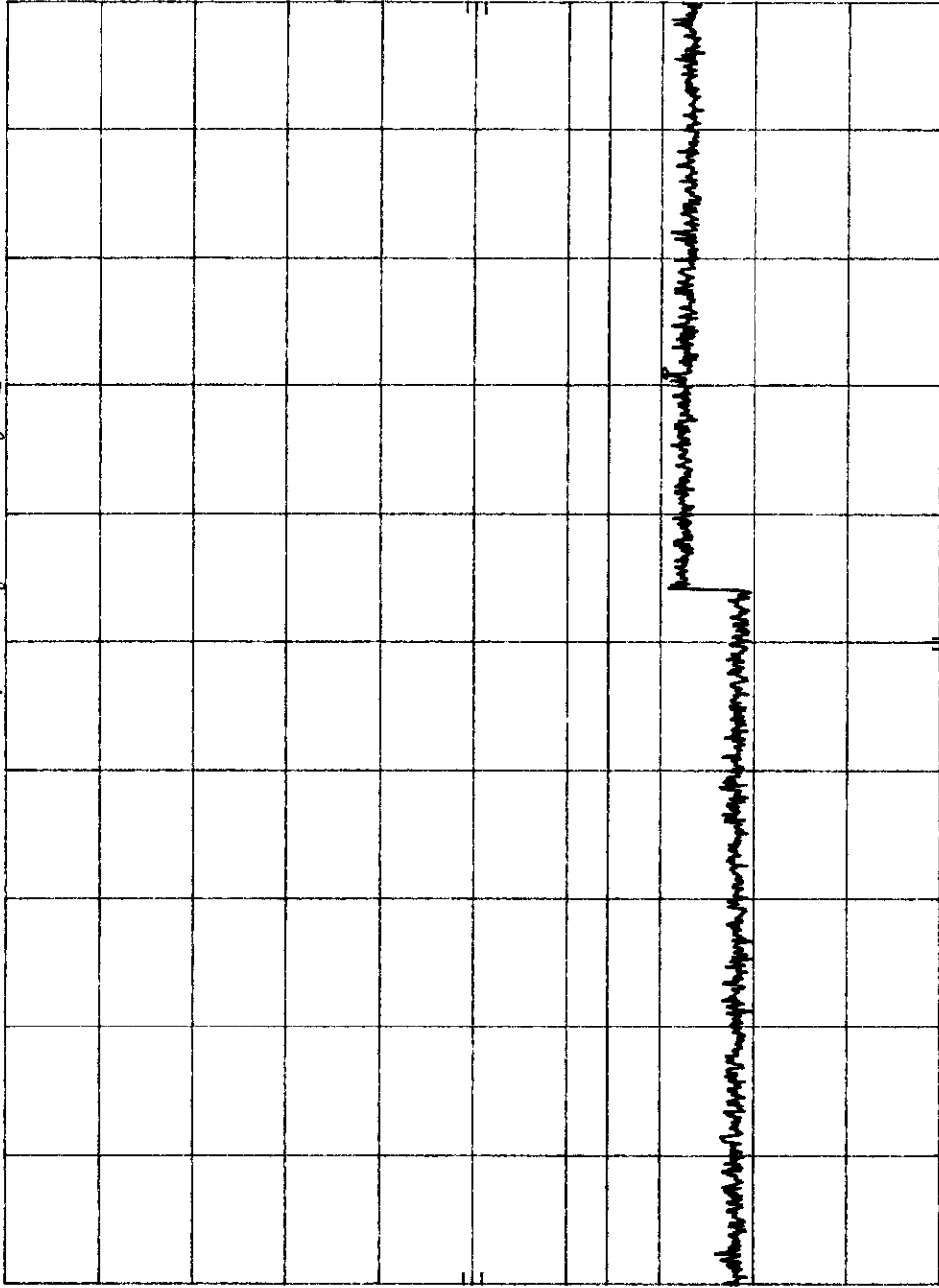

START 2.00 GHz RES BW 100 KHZ VBW 100 KHZ STOP 9.00 GHz
 REF 51.4 dBm ATTN 10 dB SWP 6.00 sec

DATE: 01/09/08

MODEL: 8594A

CELLENT COMMUNICATIONS TECHNOLOGIES, INC. 2011 RICHMOND ST. SE. SUITE 1200 ATLANTA, GA 30316
 TEST: Unwanted Emissions
 SPECIFICATION: RSS-131, Section 6.6

NOTES: 1. $f_1 = 869$ MHz
 2. $f_2 = 894$ MHz
 3. Amps voice

MKR 1.762 GHz
 -13.90 dBm

hp REF 51.4 dBm ATTN 20 dB *many unwanted*

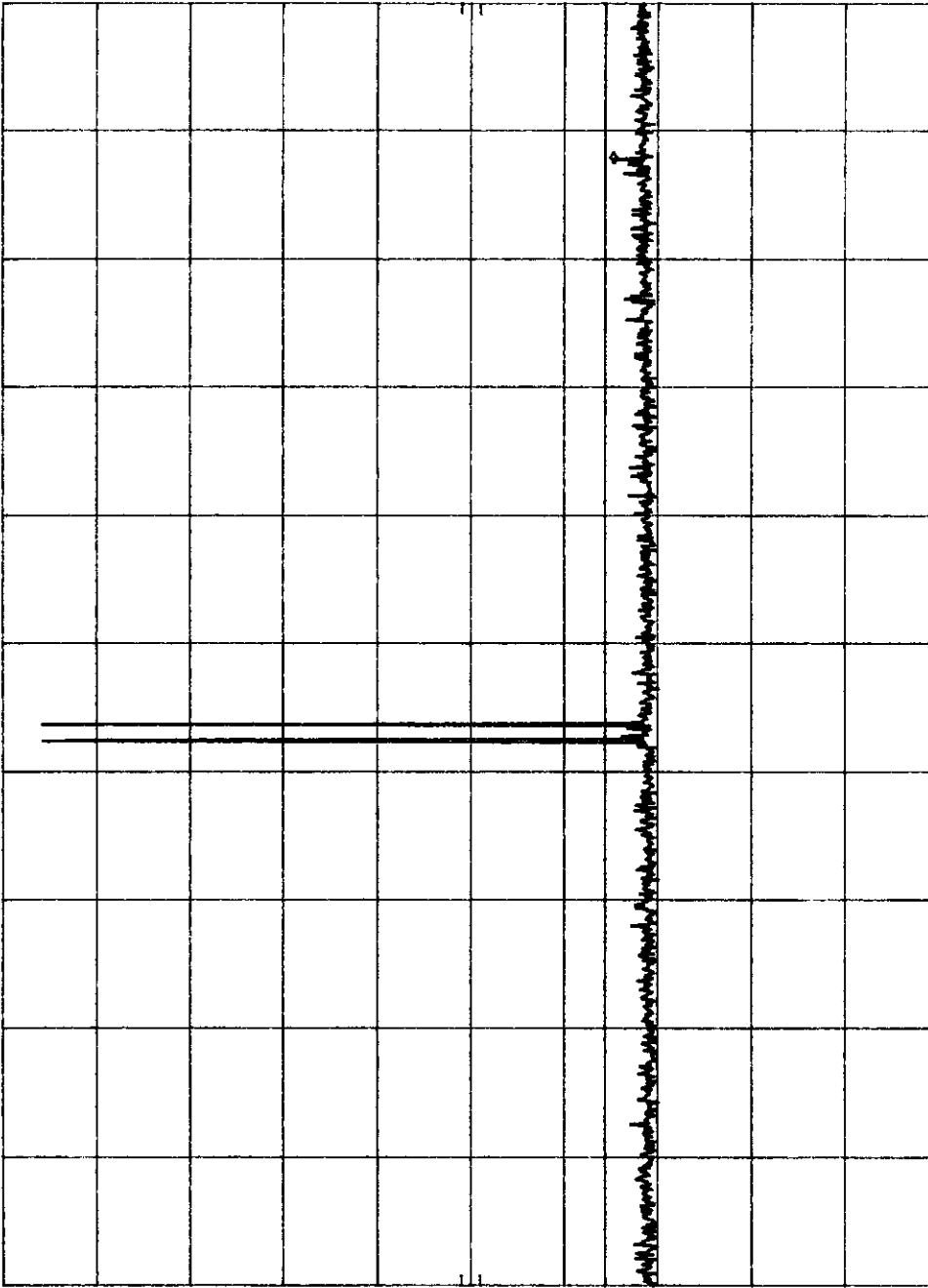

10 dB/

POS PK

OFFSET

51.4
 dB

DL
 -13.0
 dBm

START 30 MHz RES BW 100 KHZ VBW 100 KHZ STOP 2.00 GHz
 SWP 6.00 sec

DATE: 01/06/00

CLIENT: POWERWAVE TECHNOLOGIES, INC. EUT: MCA9129-120 Multi-Channel Power Amplifier

TEST: Intermodulation
 NOTES: 1. $f_1 = 869$ MHz
 2. $f_2 = 894$ MHz
 3. CDMA

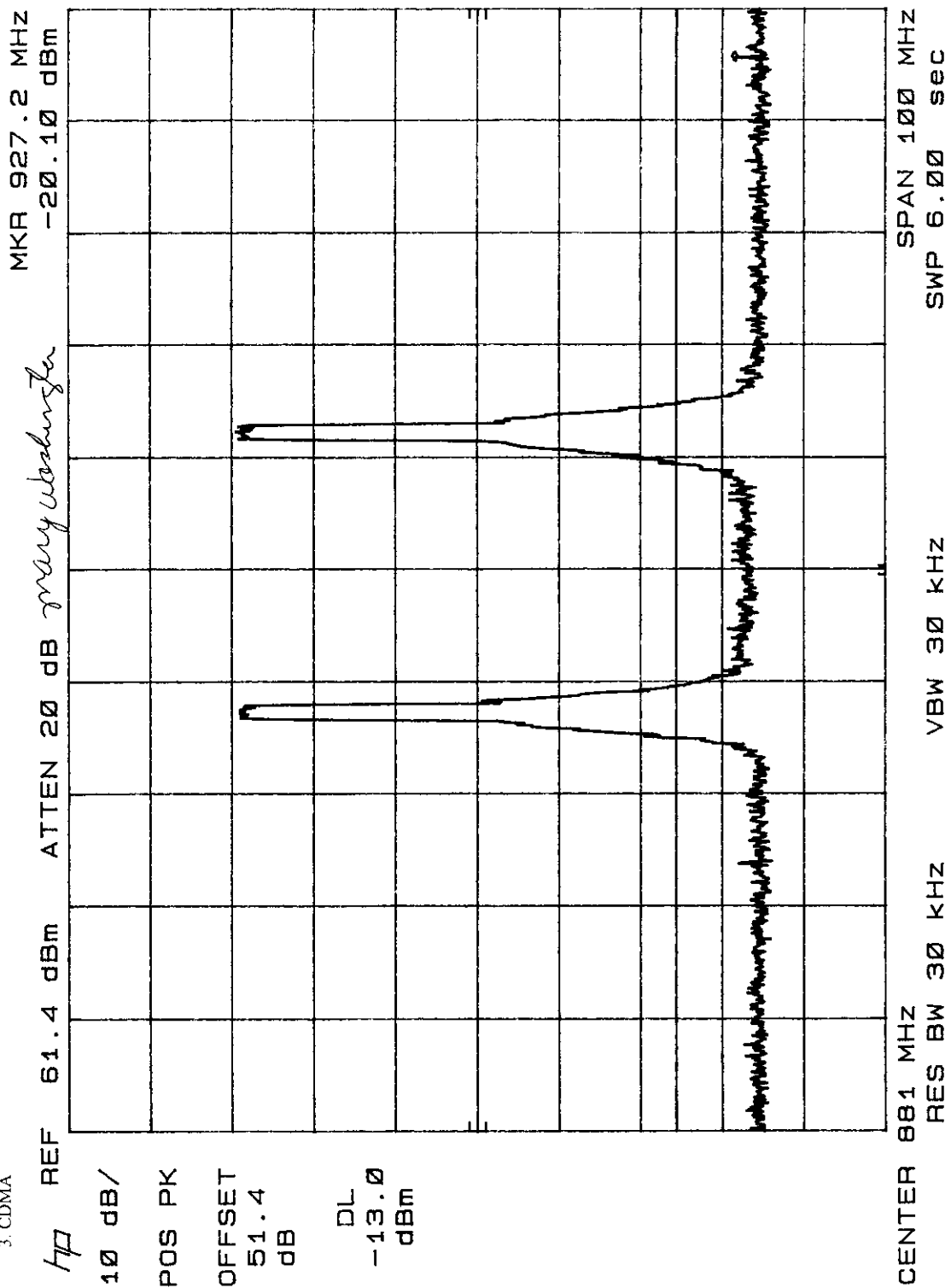

CLIENT: POWERWAVE TECHNOLOGIES, INC. EUT: MCA9129-120 Multi-Channel Power Amplifier DATE: 01/06/00

TEST: Intermodulation
 NOTES: 1. $f_1 = 869$ MHz
 2. $f_2 = 894$ MHz
 3. TDMA

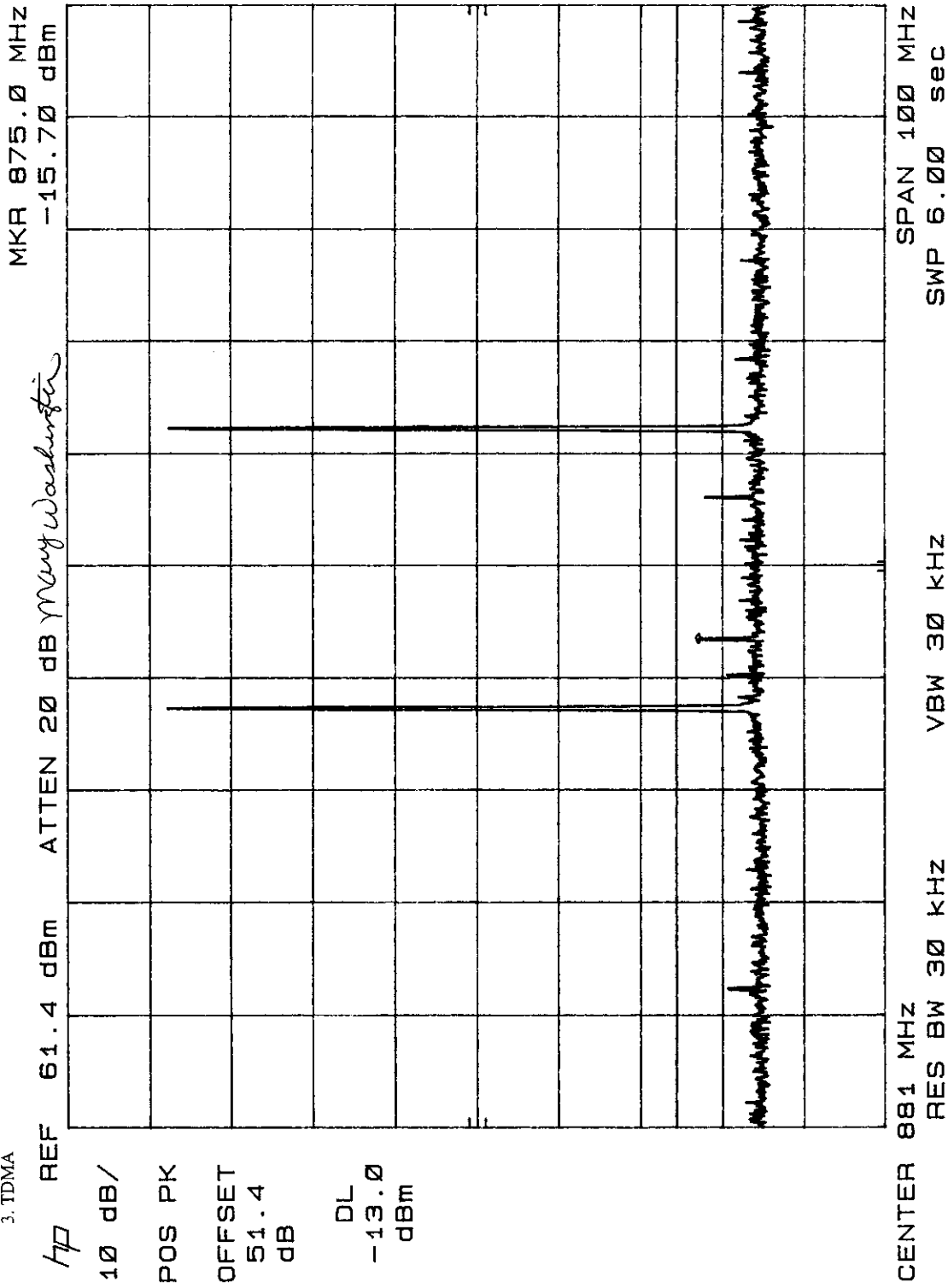

DATE: 01/06/00

CLIENT: POWERWAVE TECHNOLOGIES, INC. EUT: MCA9129-120 Multi-Channel Power Amplifier

TEST: Intermodulation
 NOTES: 1. $f_1 = 869$ MHz
 2. $f_2 = 894$ MHz
 3. Amps voice

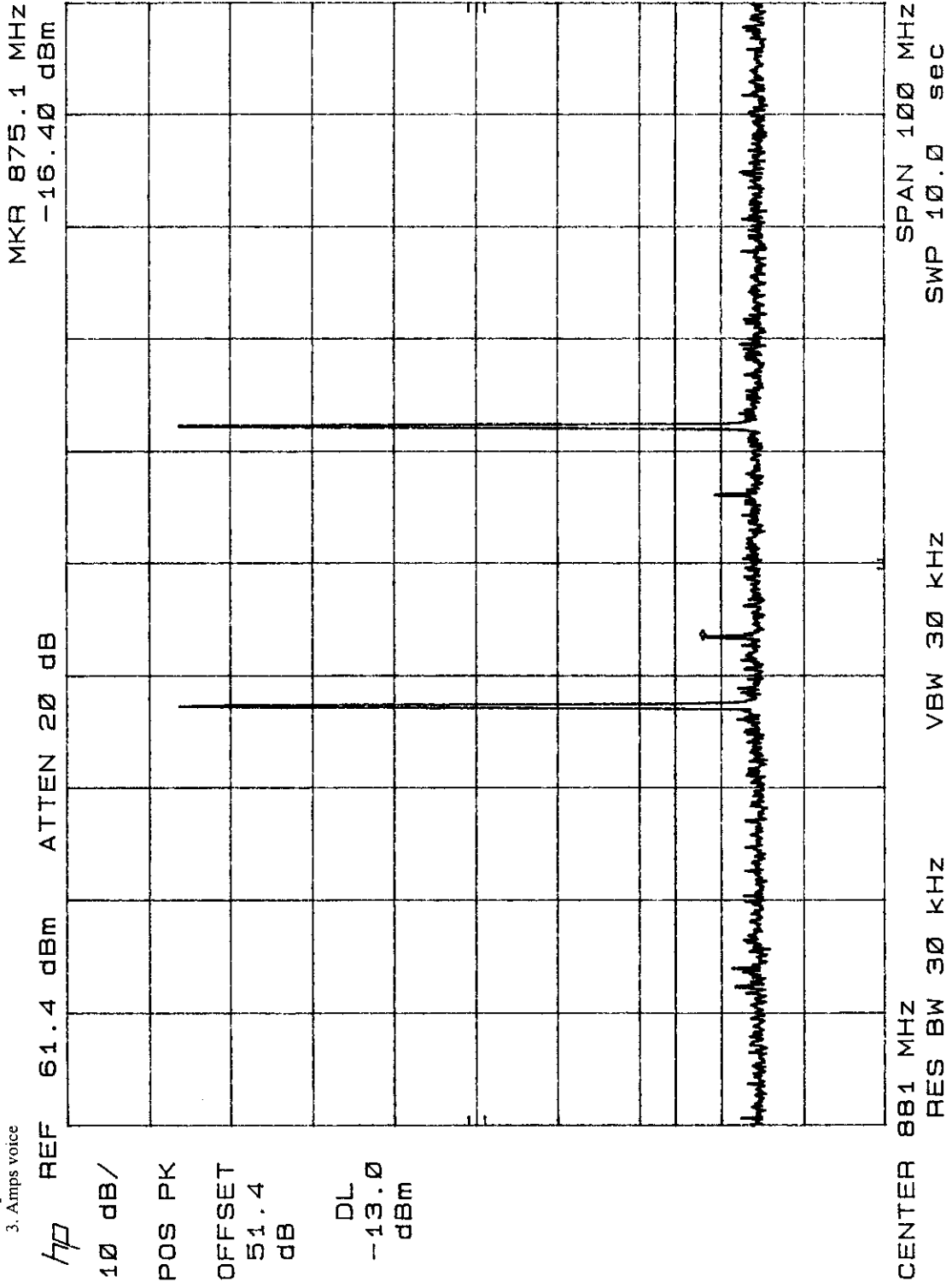

CLIENT: POWERWAVE TECHNOLOGIES, INC. EUT: MCA9129-120 Multi-Channel Power Amplifier DATE: 01/06/00

TEST: Intermodulation
 NOTES: 1. $f_1 = 869$ MHz
 2. $f_2 = 894$ MHz
 3. Amps data

MKR 875.1 MHz
 -16.70 dBm

HP REF 61.4 dBm ATTN 20 dB *max w/abundant*

10 dB/
 POS PK
 OFFSET 51.4 dB
 DL -13.0 dBm

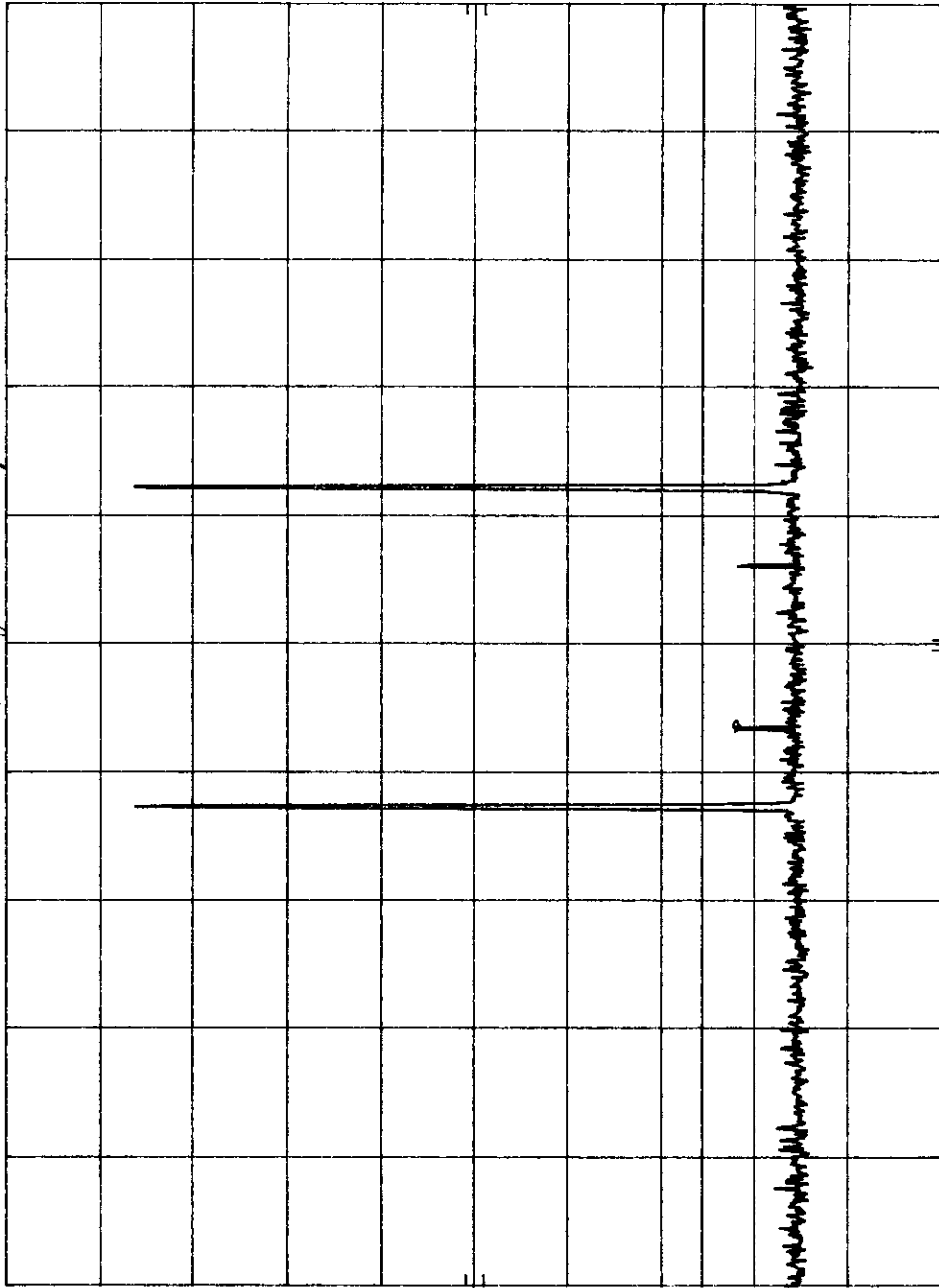

CENTER 881 MHz
 RES BW 30 KHZ
 VBW 30 KHZ
 SPAN 100 MHz
 SWP 5.00 sec

DATE: 01/06/00

CLIENT: POWERWAVE TECHNOLOGIES, INC. EUT: MCA9129-120 Multi-Channel Power Amplifier

TEST: Spurious Emissions at Antenna Terminal SPECIFICATION: FCC Part 2, Paragraph 2.1051

- NOTES: 1. $f_1 = 869$ MHz
 2. $f_2 = 894$ MHz
 3. CDMA

MKR 8.888 GHz
 -24.00 dBm

hp REF 51.4 dBm ATTEN 10 dB *mary Washington*

10 dB/

POS PK

OFFSET

51.4
 dB

DL

-13.0
 dBm

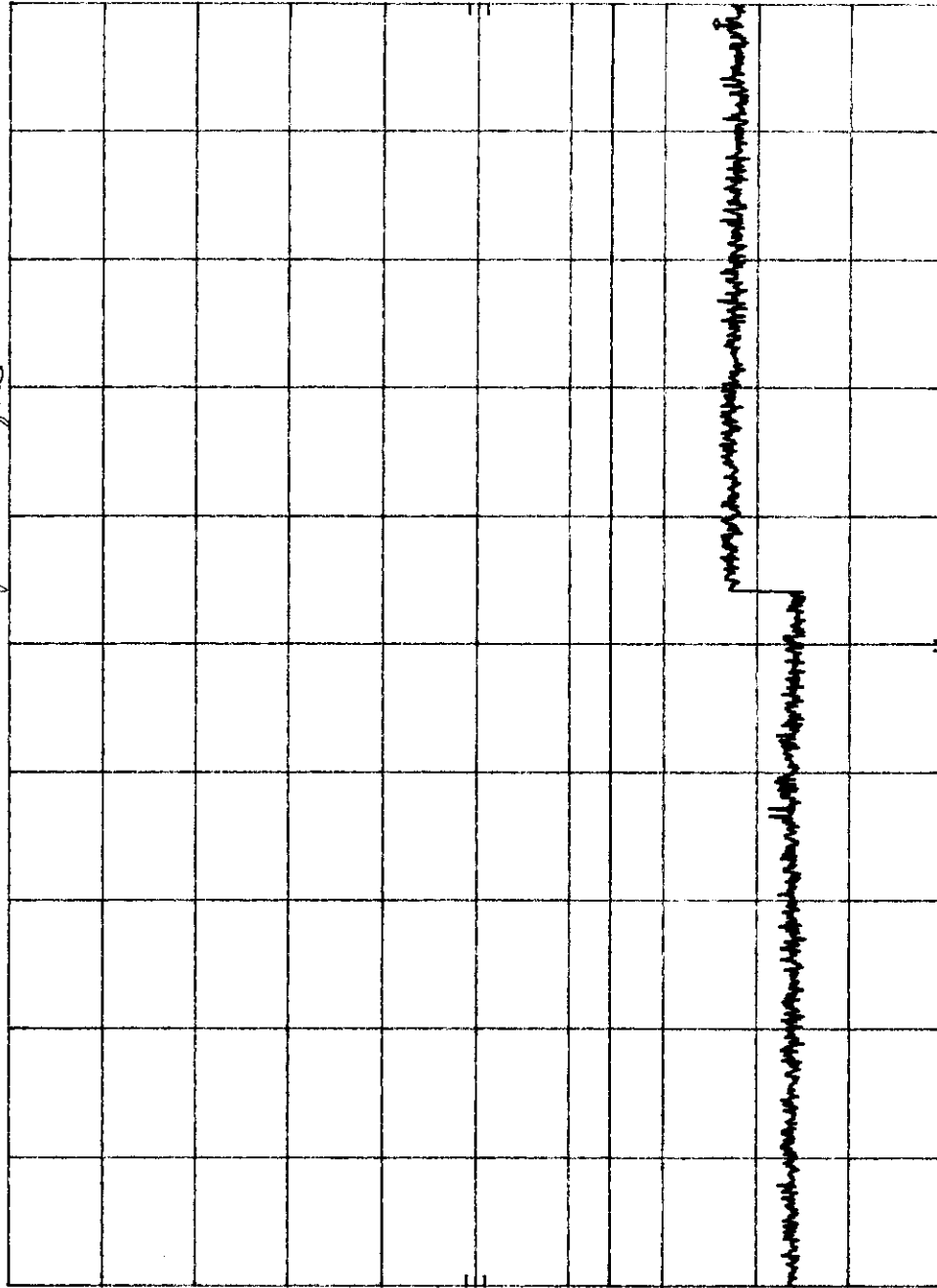

START 2.00 GHz RES BW 30 KHZ VBW 30 KHZ SWP 21.0 sec
 STOP 9.00 GHz

DATE: 01/00/00

CLIENT: POWERWAVE TECHNOLOGIES, INC. EUI: MCA9129-120 Multi-Channel Power Amplifier
 TEST: Spurious Emissions at Antenna Terminal SPECIFICATION: FCC Part 2, Paragraph 2.1051

NOTES: 1. $f_1 = 869$ MHz
 2. $f_2 = 894$ MHz
 3. CDMA

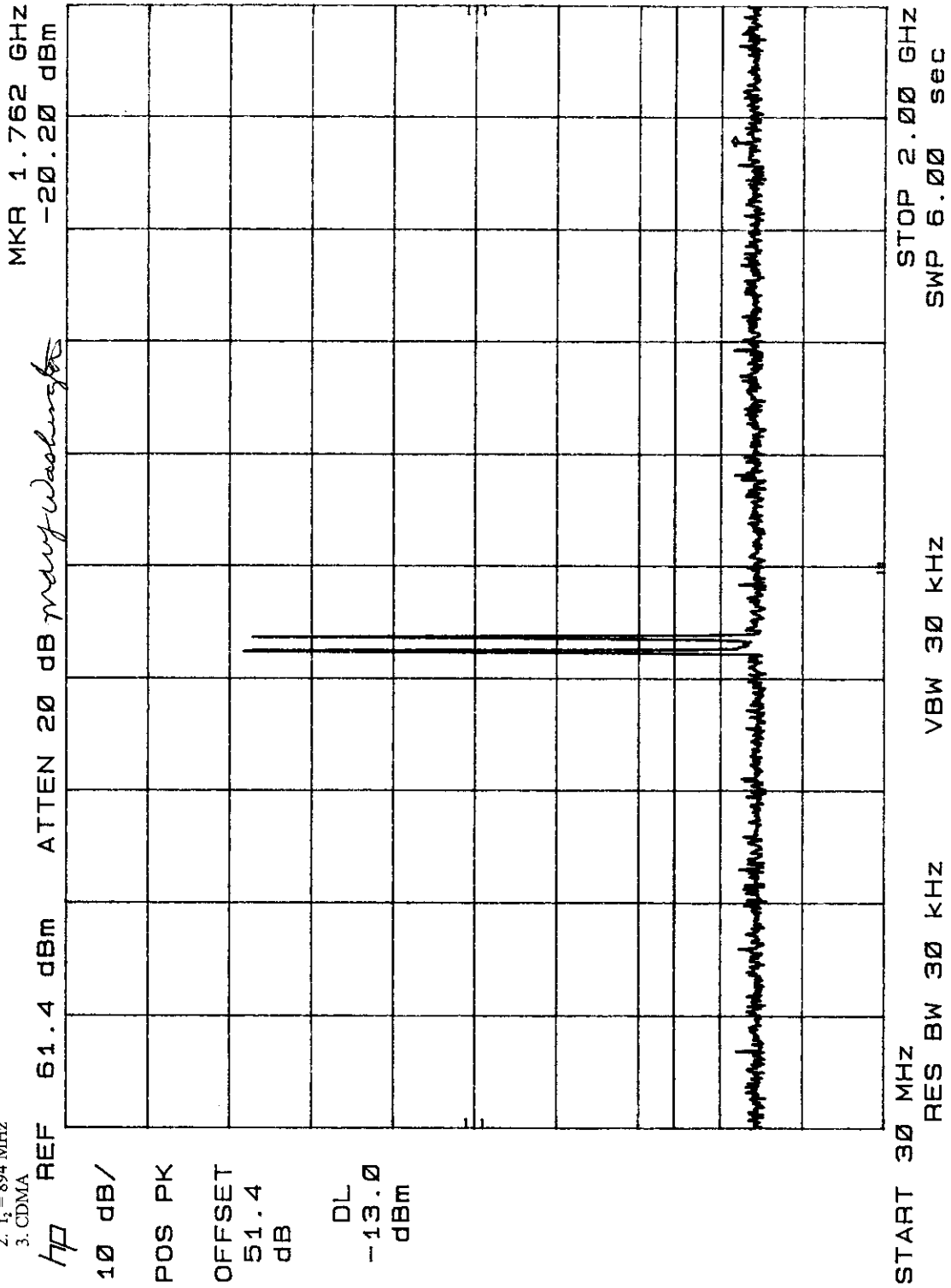

CLIENT: POWERWAVE TECHNOLOGIES, INC. EUI: MCA9129-120 Multi-Channel Power Amplifier DATE: 01/06/00
 TEST: Spurious Emissions at Antenna Terminal SPECIFICATION: FCC Part 2, Paragraph 2.1051
 NOTES: 1. $f_1 = 869$ MHz
 2. $f_2 = 894$ MHz
 3. TDMA

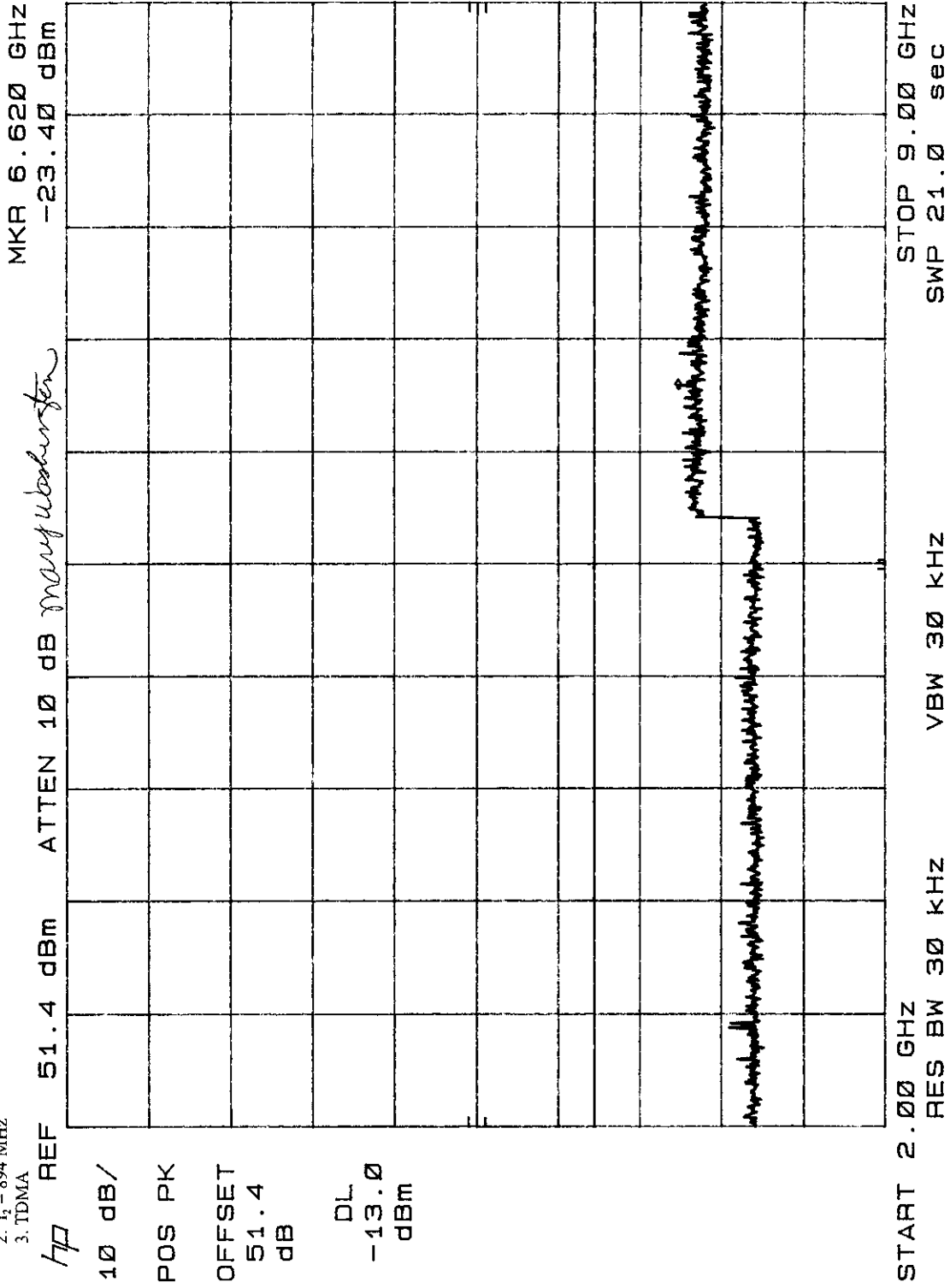

CLIENT: POWERWAVE TECHNOLOGIES, INC. EUT: MCA9129-120 Multi-Channel Power Amplifier DATE: 01/06/00
 TEST: Spurious Emissions at Antenna Terminal SPECIFICATION: FCC Part 2, Paragraph 2.1051

NOTES: 1. $f_1 = 869$ MHz
 2. $f_2 = 894$ MHz
 3. TDMA

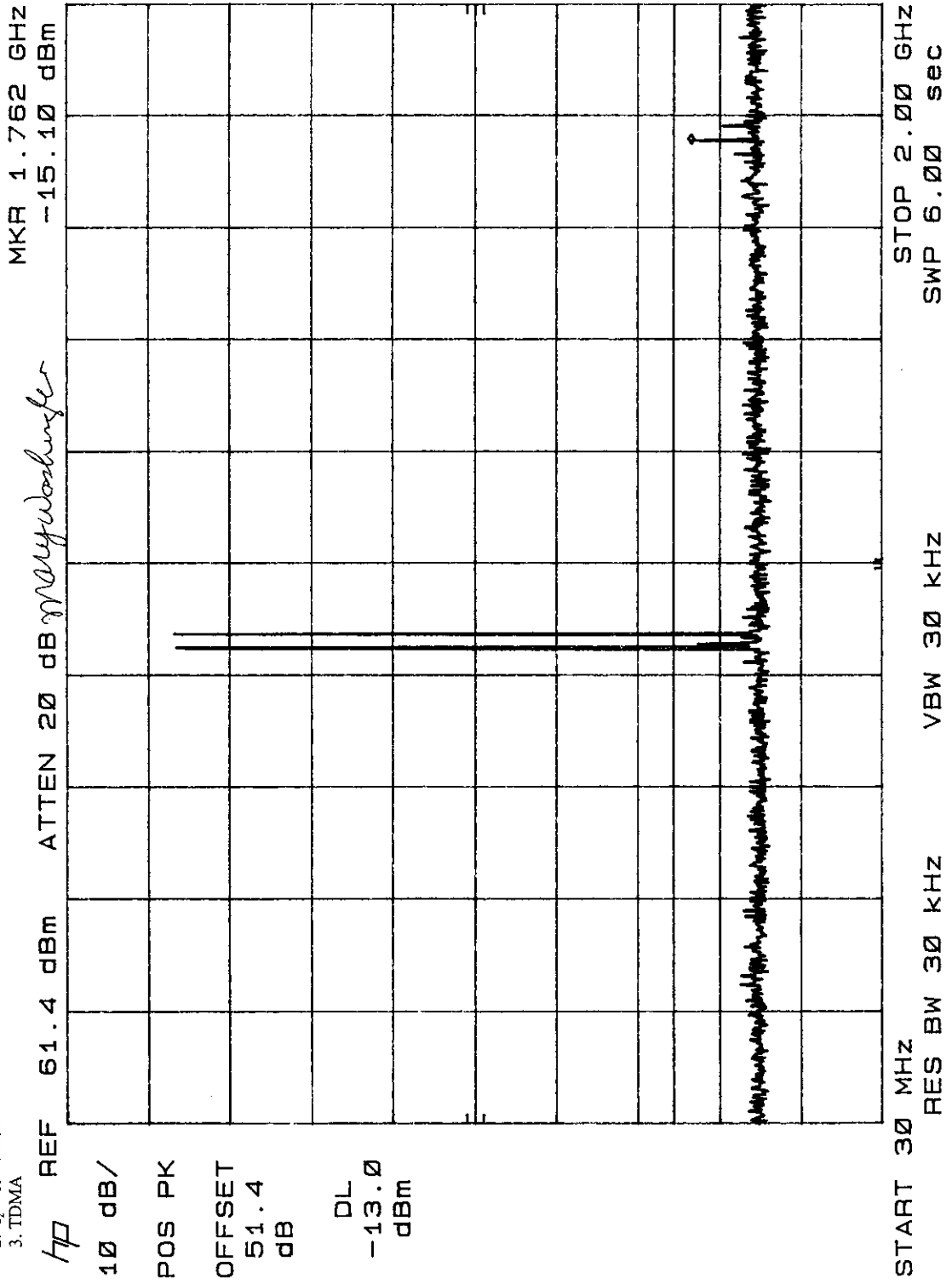

CLIENT: POWERWAVE TECHNOLOGIES, INC. EUT: MCA9129-120 Multi-Channel Power Amplifier DATE: 01/06/00
 TEST: Spurious Emissions at Antenna Terminal SPECIFICATION: FCC Part 2, Paragraph 2.1051

NOTES: 1. $f_1 = 869$ MHz
 2. $f_2 = 894$ MHz
 3. Amps voice

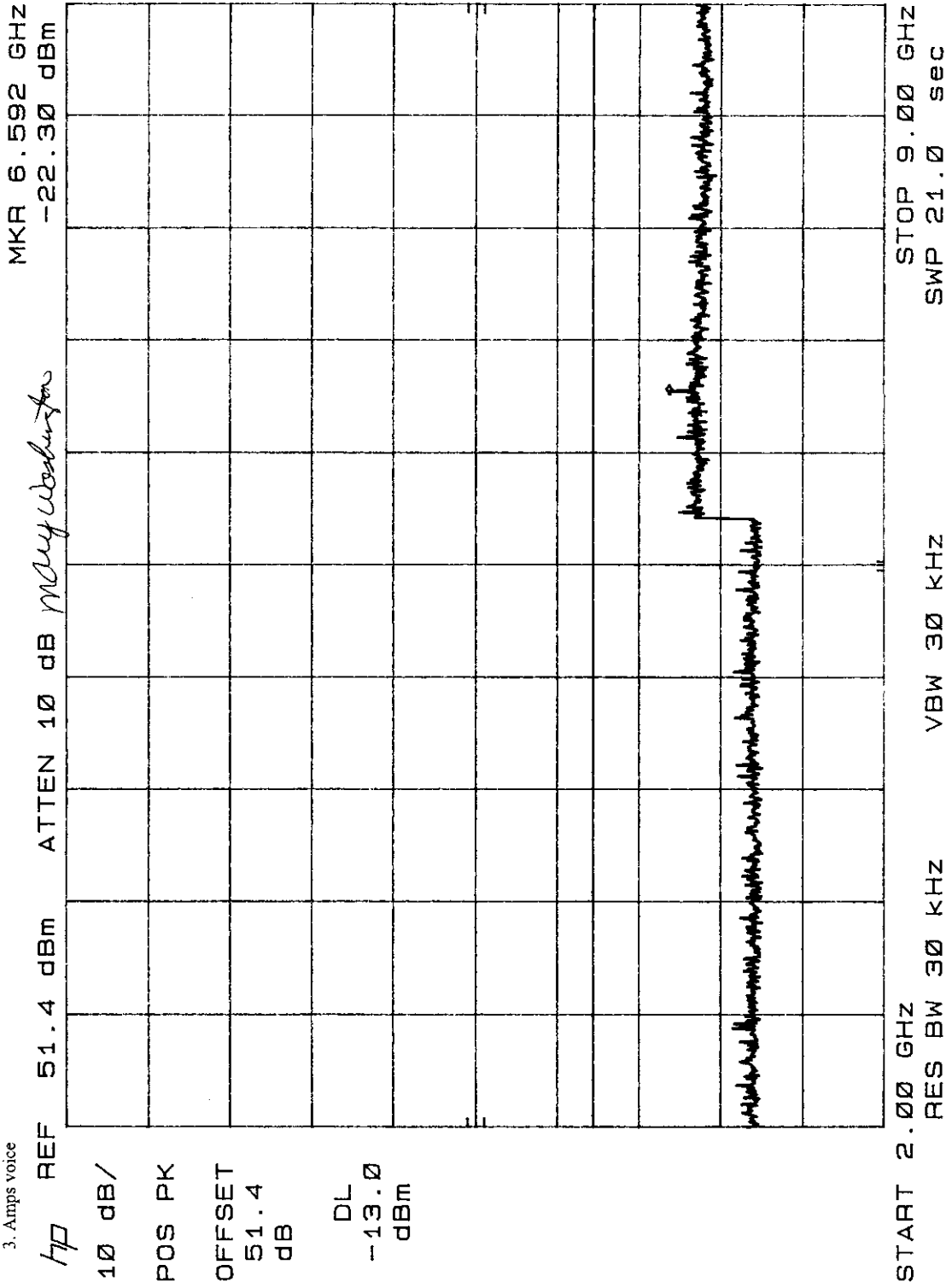

CLIENT: POWERWAVE TECHNOLOGIES, INC. EUT: MCA9129-120 Multi-Channel Power Amplifier DATE: 01/06/00
 TEST: Spurious Emissions at Antenna Terminal SPECIFICATION: FCC Part 2, Paragraph 2.1051
 NOTES: 1. $f_1 = 869$ MHz
 2. $f_2 = 894$ MHz
 3. Amps voice

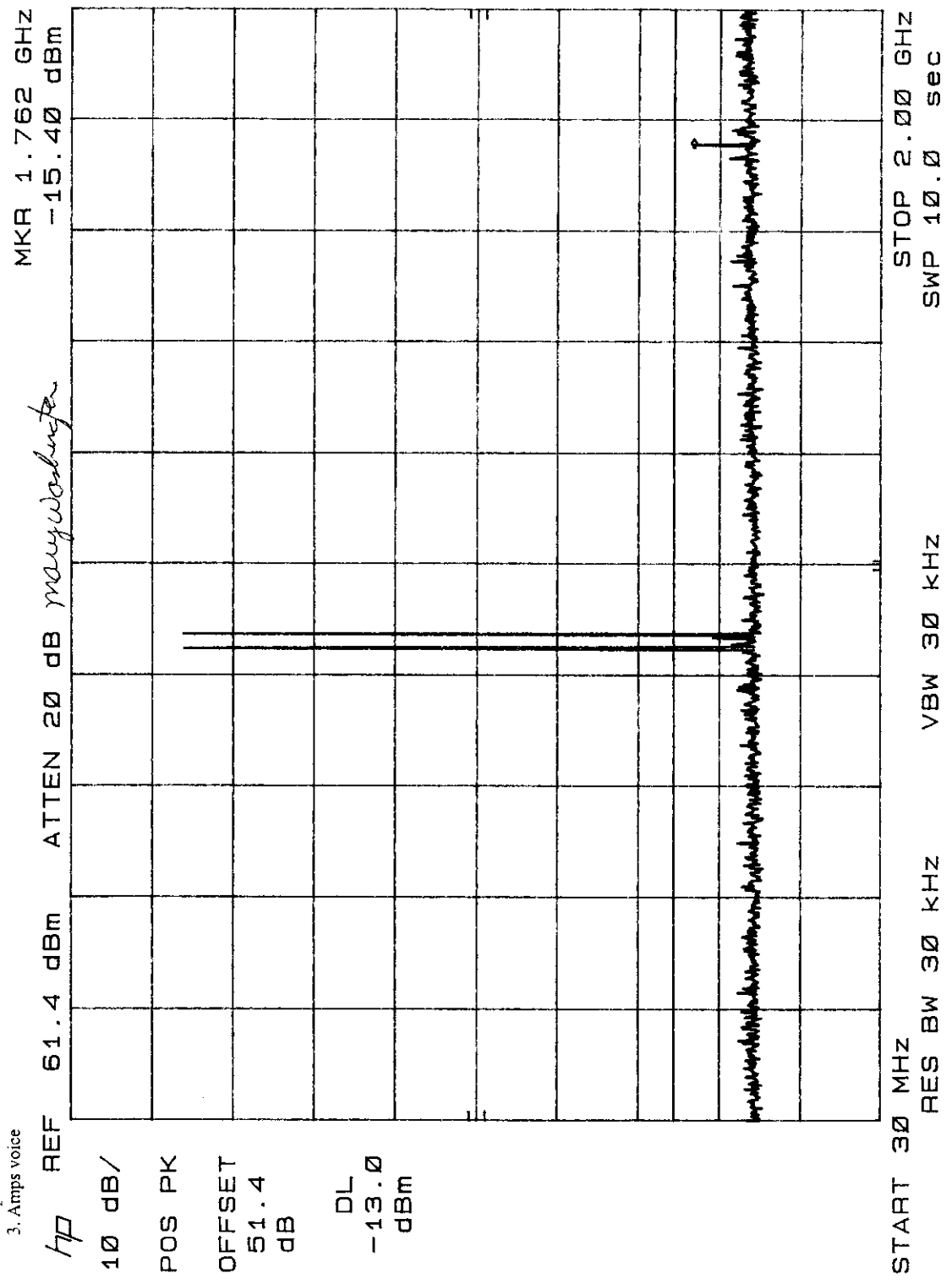

DATE: 01/00/00

CLIENT: POWERWAVE TECHNOLOGIES, INC. ECU: MCA9129-120 Multi-Channel Power Amplifier
 TEST: Spurious Emissions at Antenna Terminal SPECIFICATION: FCC Part 2, Paragraph 2.1051

NOTES: 1. $f_1 = 869$ MHz
 2. $f_2 = 894$ MHz
 3. Amps data

HP REF 51.4 dBm ATTN 10 dB May 2008 MKR 6.585 GHz -24.00 dBm

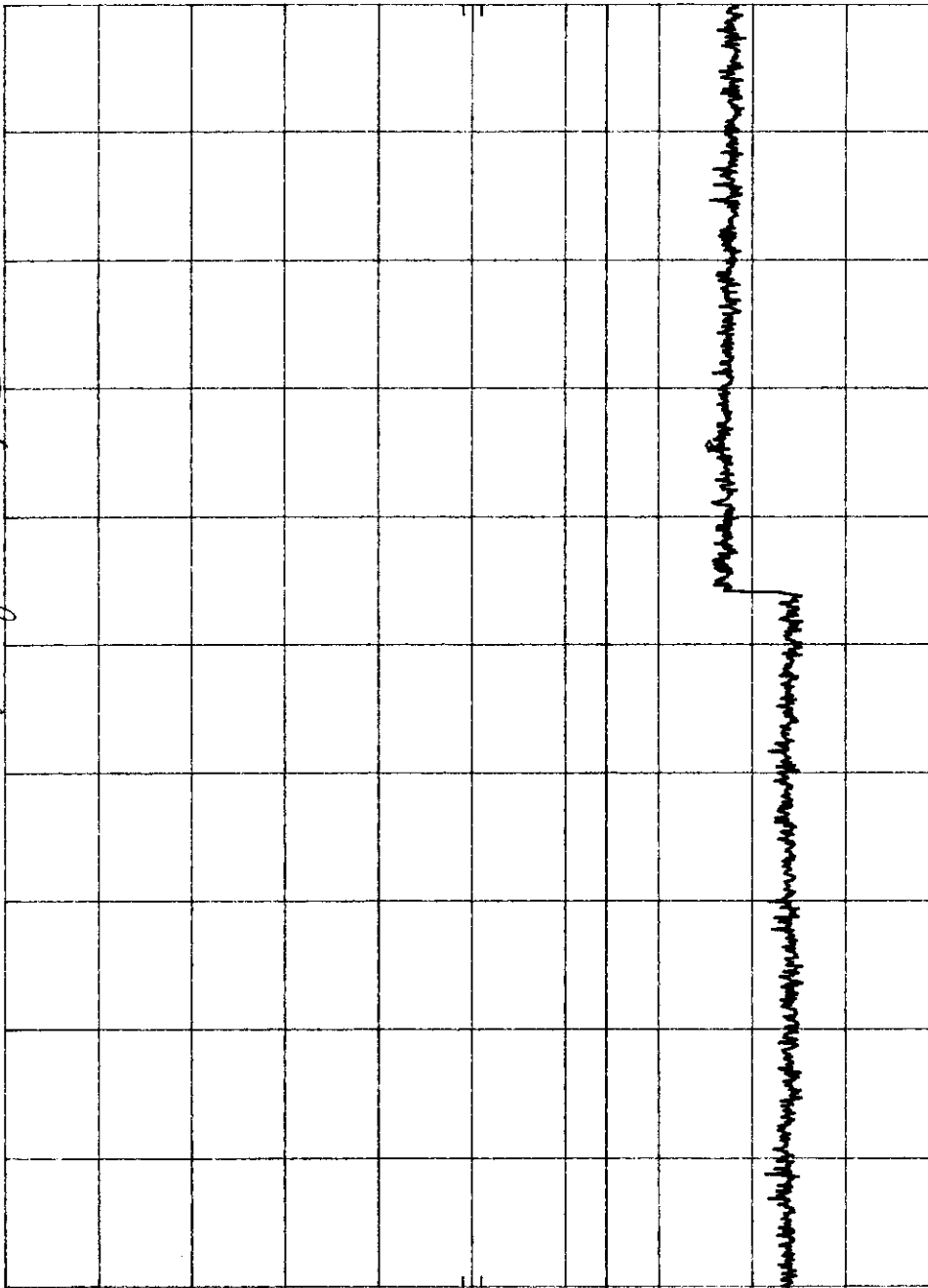

10 dB/

POS PK

OFFSET

51.4 dB

DL
 -13.0 dBm

START 2.00 GHz RES BW 30 KHZ VBW 30 KHZ STOP 9.00 GHz SWP 21.0 sec

CLIENT: POWERWAVE TECHNOLOGIES, INC. EUT: MCA9129-120 Multi-Channel Power Amplifier DATE: 01/06/00
 TEST: Spurious Emissions at Antenna Terminal SPECIFICATION: FCC Part 2, Paragraph 2.1051

NOTES: 1. $f_1 = 869$ MHz
 2. $f_2 = 894$ MHz
 3. Amps data

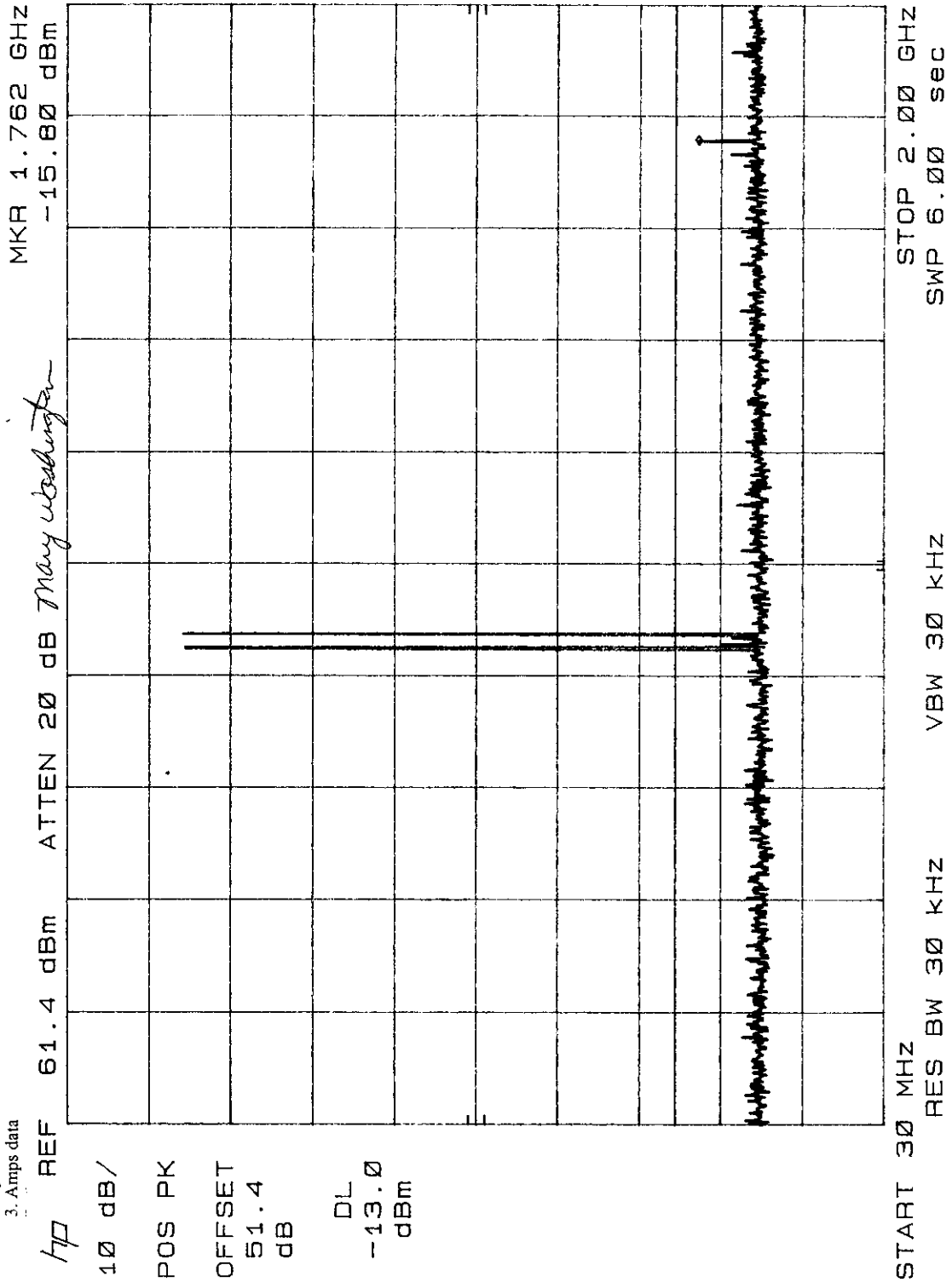

CELLULAR TELEPHONE TECHNOLOGIES, INC. ECU WCAV129-120 WMMU-Channel Power Amplifier

DATE: 01/06/00

TEST: Input Plot

- NOTES: 1. $f_1 = 869$ MHz
- 2. $f_2 = 894$ MHz
- 3. CDMA

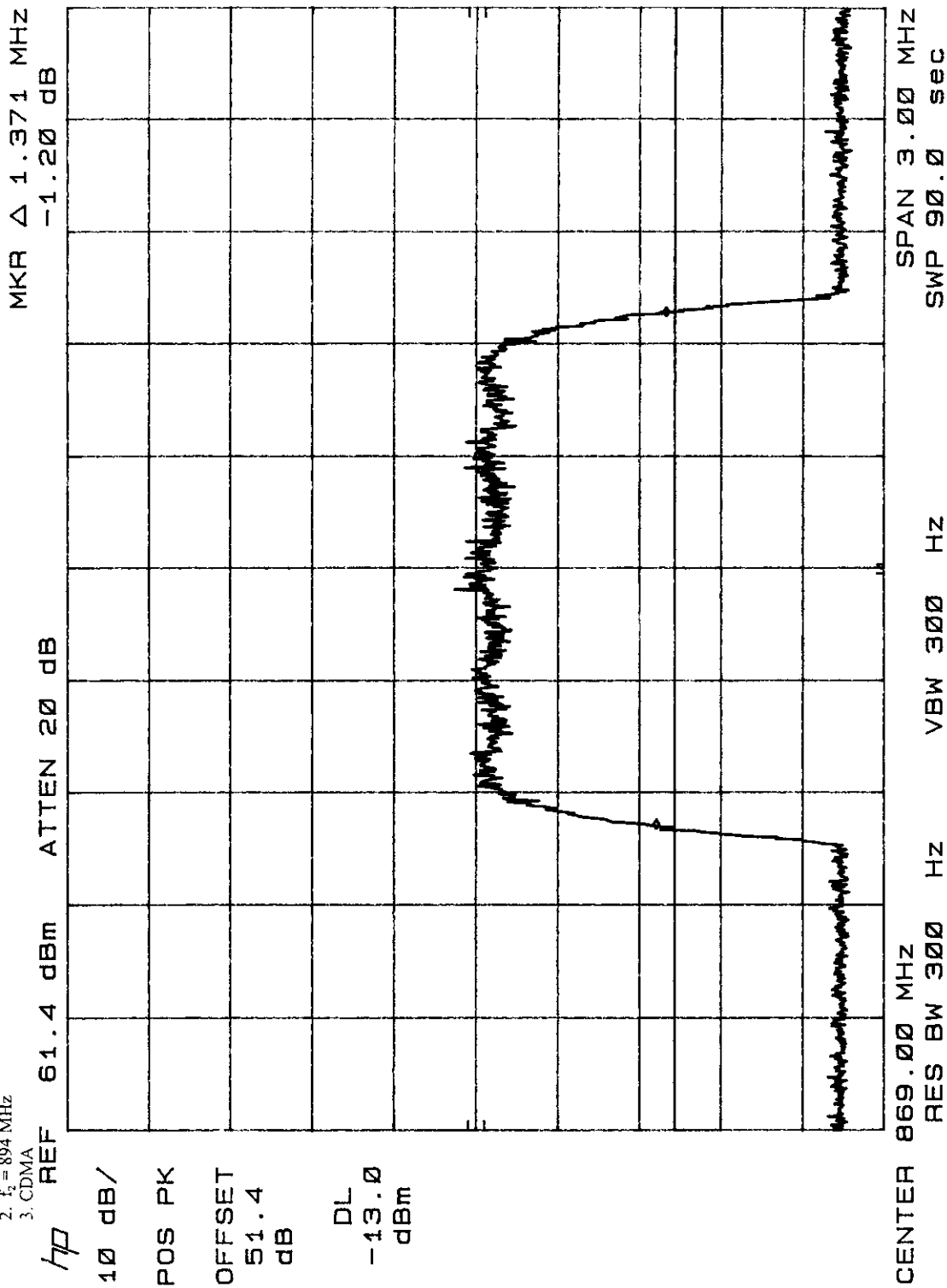

DATE: 01/06/00

CLIENT: POWERWAVE TECHNOLOGIES, INC. EUT: MCA9129-120 Multi-Channel Power Amplifier

TEST: Input Plot

- NOTES: 1. $f_1 = 869$ MHz
- 2. $f_2 = 894$ MHz
- 3. CDMA

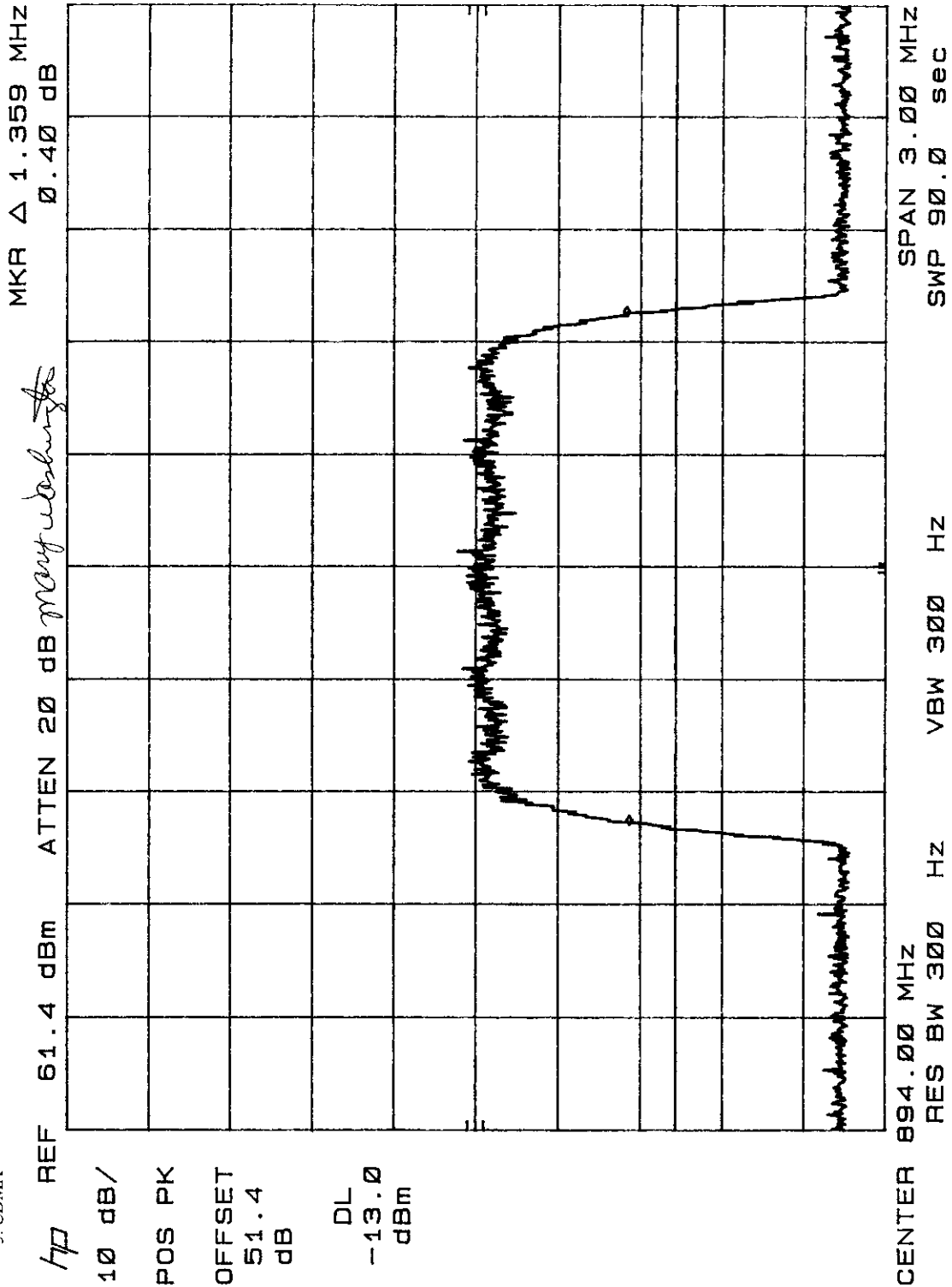

DATE: 01/00/00

CLIENT: POWERWAVE TECHNOLOGIES, INC. EUI: MCA9129-120 Multi-Channel Power Amplifier

TEST: Input Plot
NOTES: 1. $f_1 = 869$ MHz
2. $f_2 = 894$ MHz
3. Amps voice

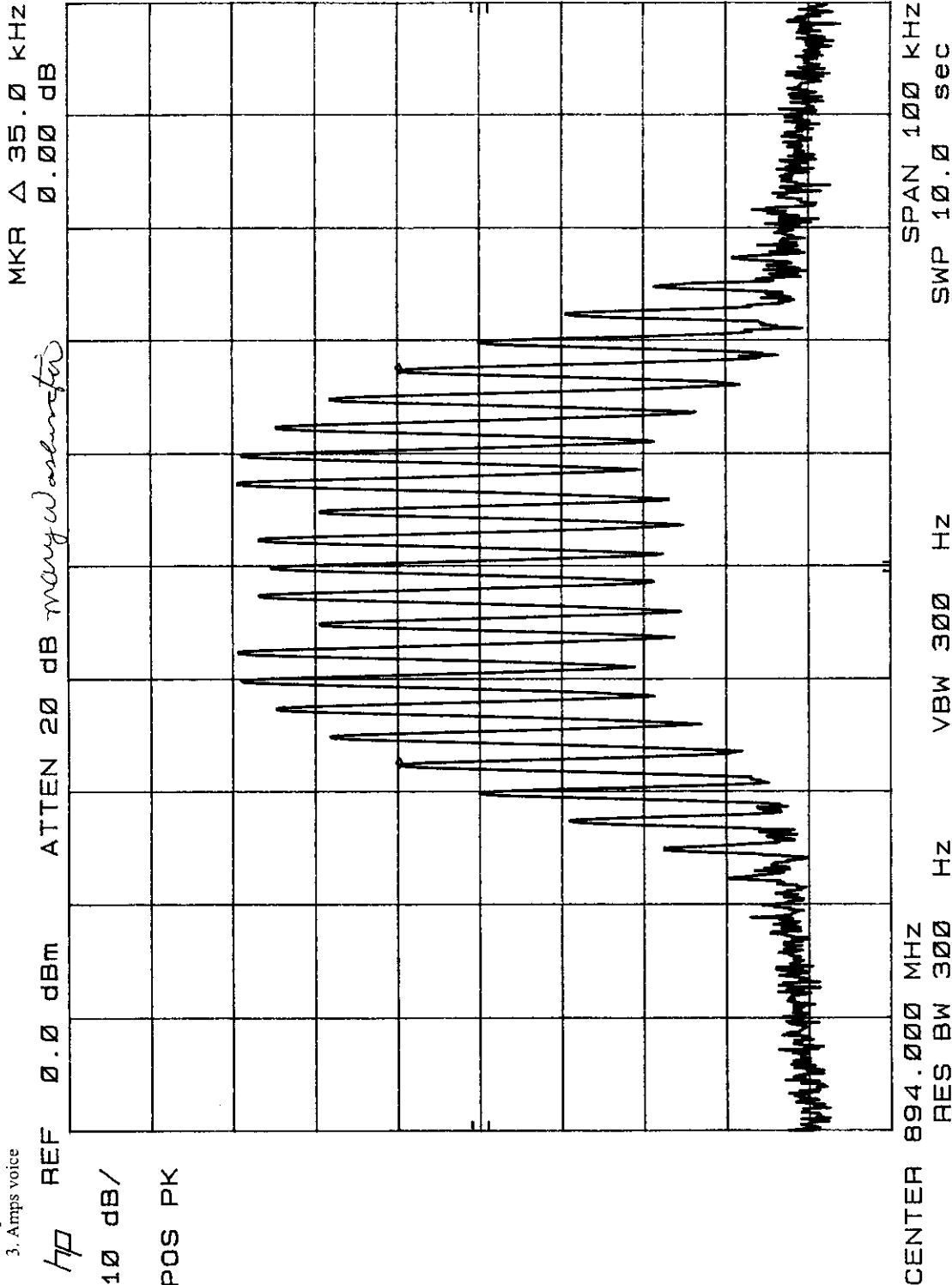

DATE: 01/00/00

CLIENT: POWERWAVE TECHNOLOGIES, INC. EUI: MCA9129-120 Multi-Channel Power Amplifier

TEST: Input Plot
NOTES: 1. $f_1 = 869$ MHz
2. $f_2 = 894$ MHz
3. Amps voice

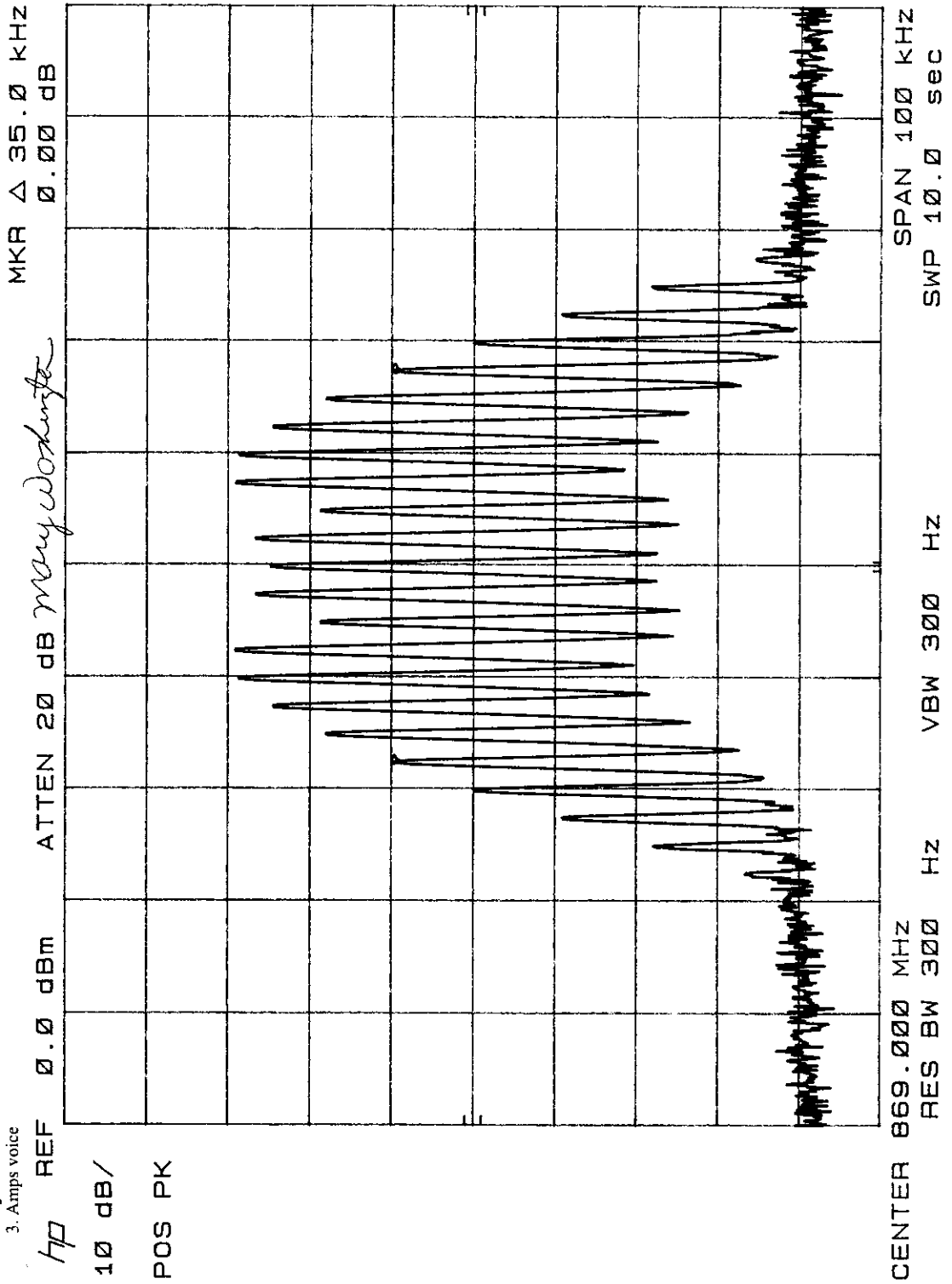

CLIENT: POWERWAVE TECHNOLOGIES, INC. EUT: MCA9129-120 Multi-Channel Power Amplifier DATE: 01/09/00

TEST: Input Plot
 NOTES: 1. $f_1 = 869$ MHz
 2. $f_2 = 894$ MHz
 3. Armps data

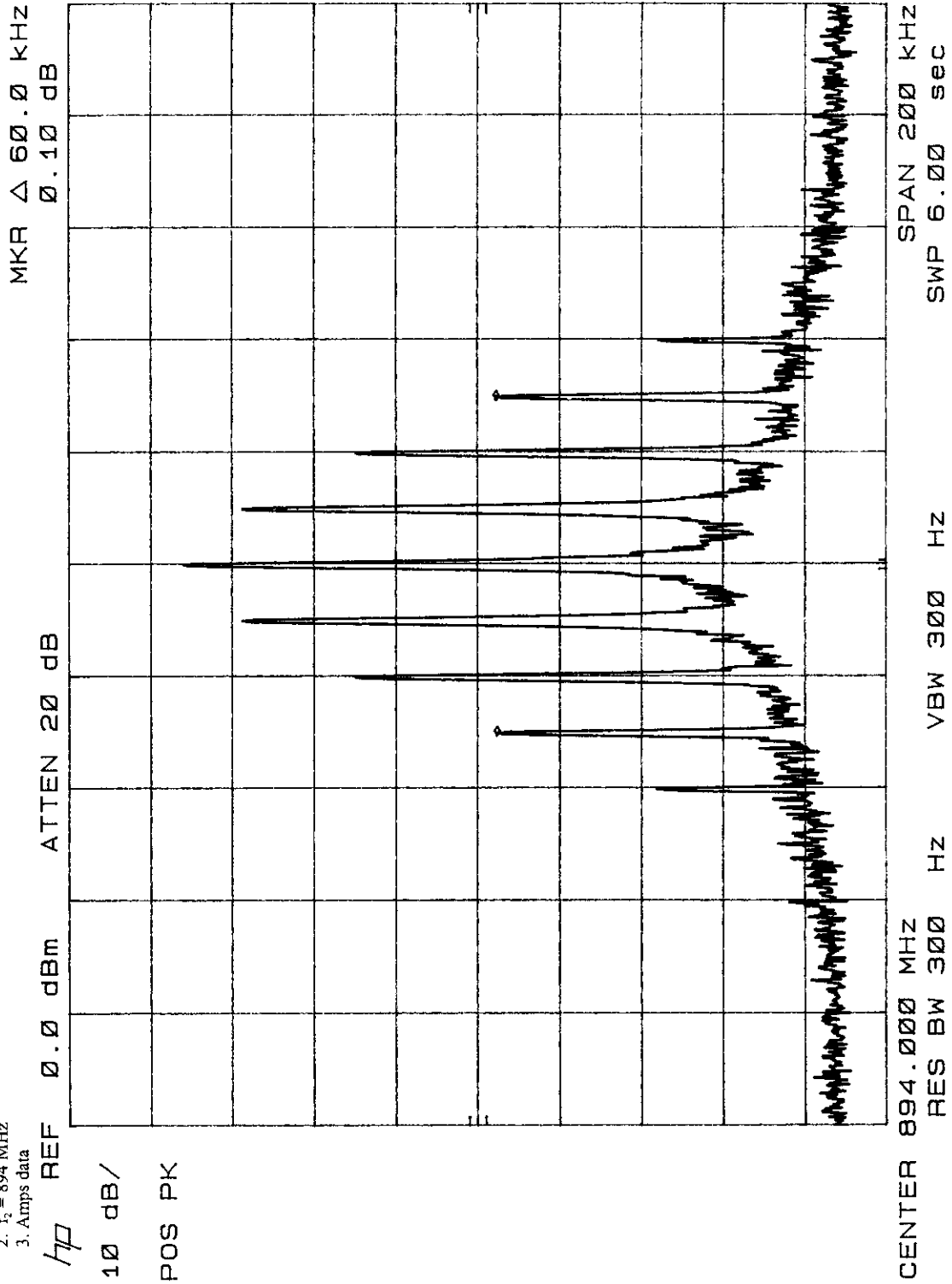

DATE: 01/00/00

CLIENT: POWERWAVE TECHNOLOGIES, INC. EUT: MCA9129-120 Multi-Channel Power Amplifier

TEST: Input Plot
NOTES: 1. $f_1 = 869$ MHz
2. $f_2 = 894$ MHz
3. Amps data

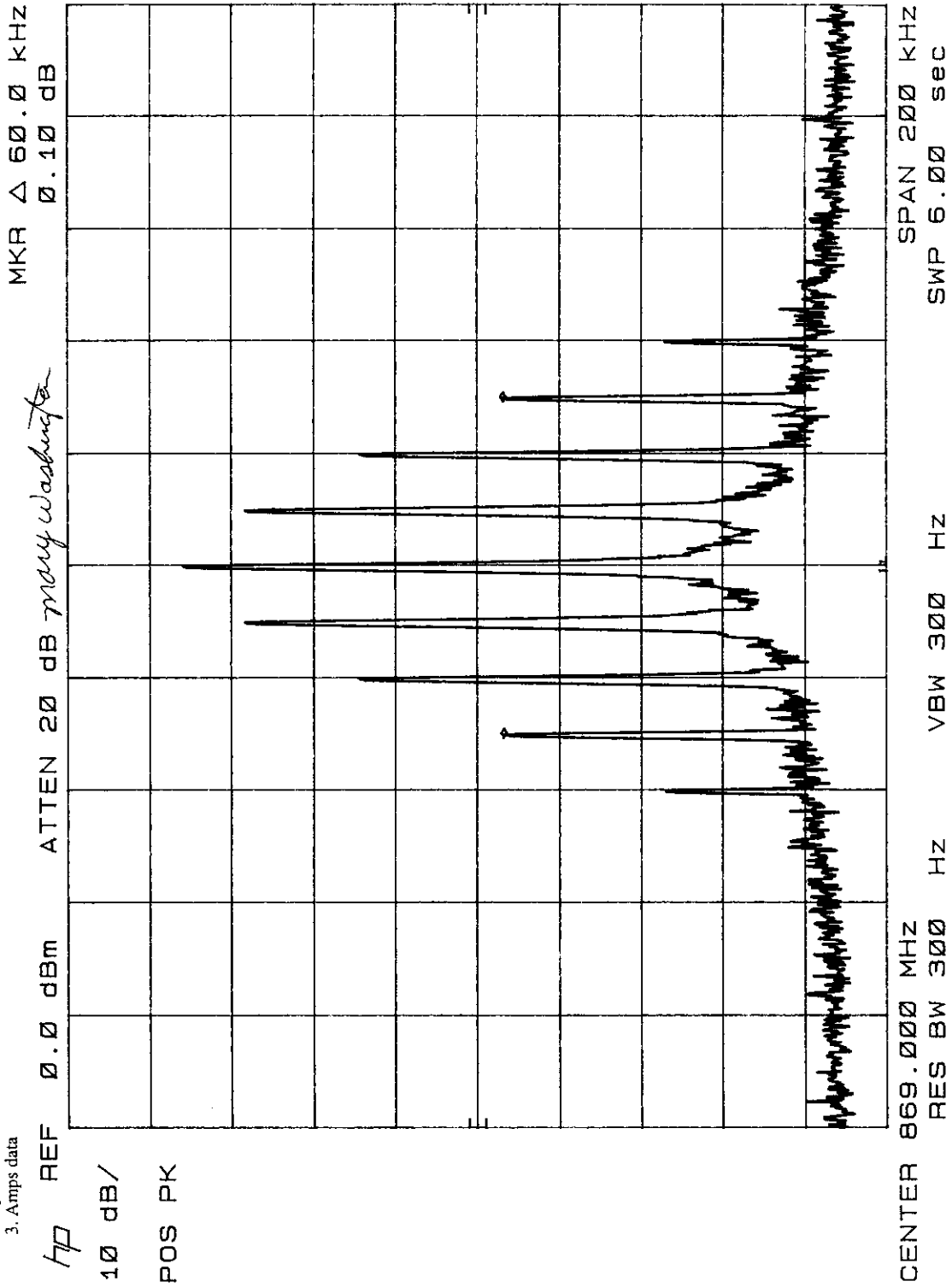

DATE: 01/09/00

CLIENT: POWERWAVE TECHNOLOGIES, INC. EUT: MCA9129-129 Multi-Channel Power Amplifier

TEST: Input Plot
 NOTES: 1. $f_1 = 869$ MHz
 2. $f_2 = 894$ MHz
 3. TDMA

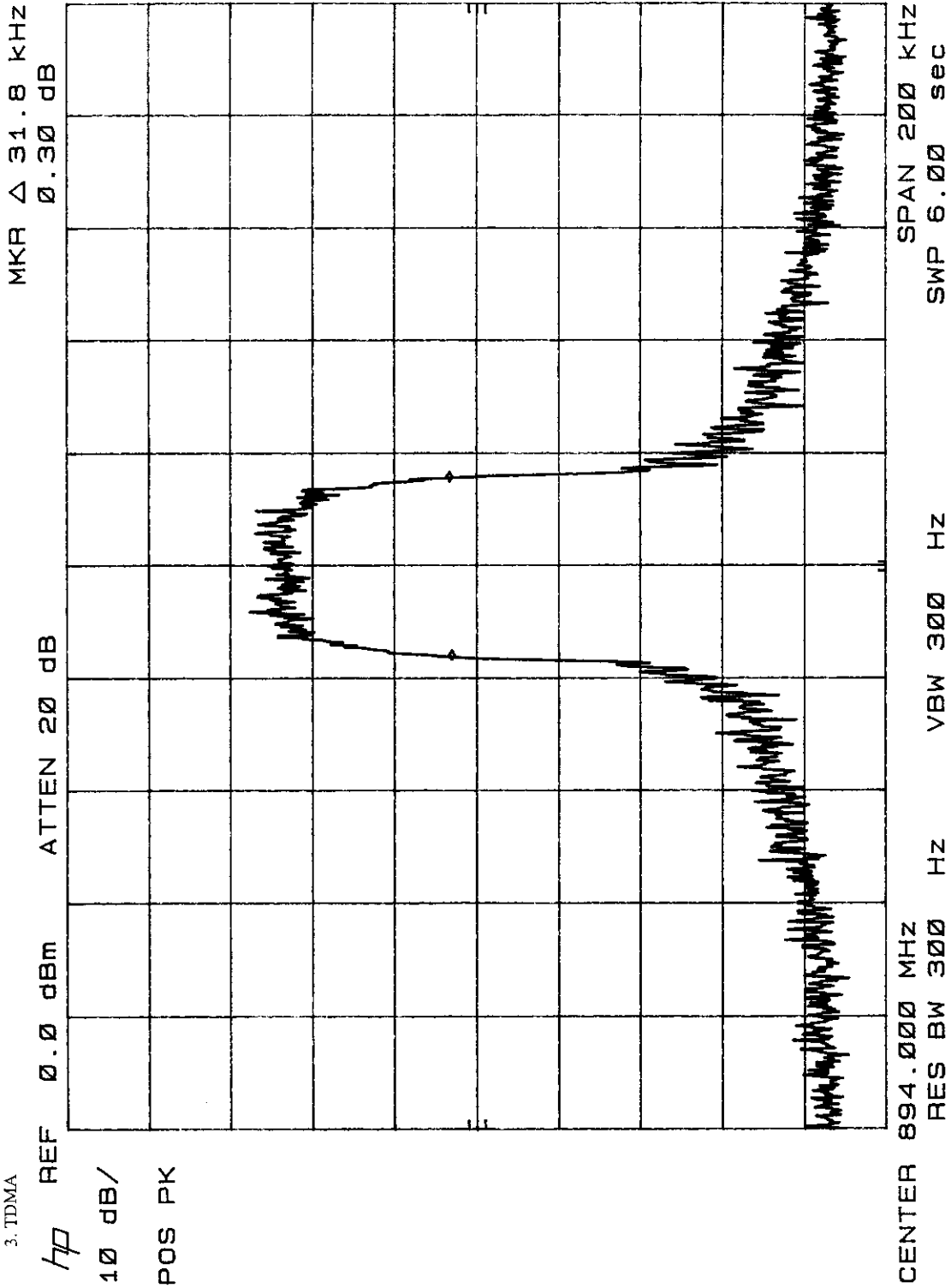

CLIENT: POWERWAVE TECHNOLOGIES, INC. EUI: MCA7127-120 MHz-CARRIER POWER AMP/PA

TEST: Input Plot
 NOTES: 1. $f_1 = 869$ MHz
 2. $f_2 = 894$ MHz
 3. TDMA

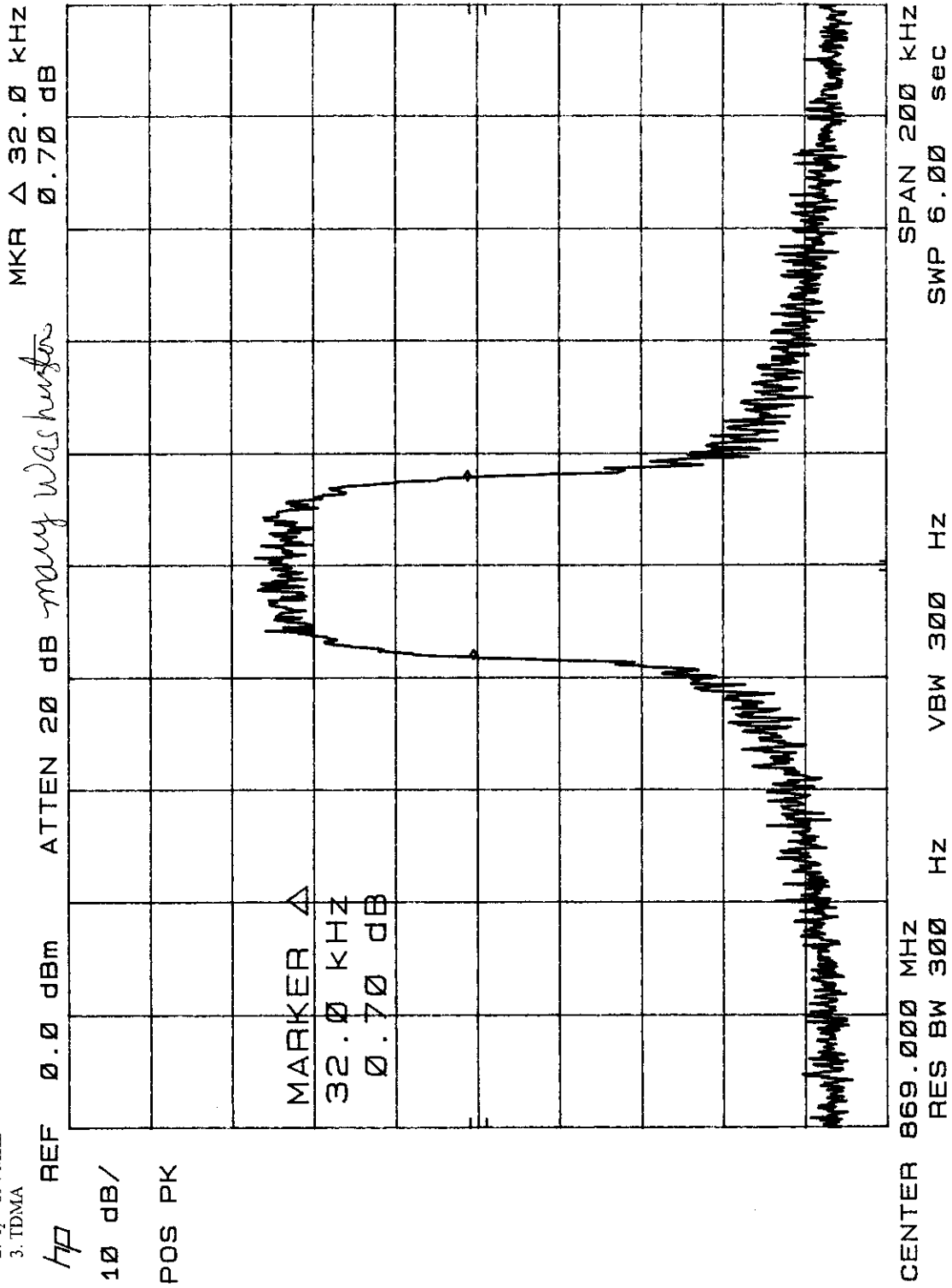

5 SIGNATURE PAGE

GENERAL REMARKS:

SUMMARY:

All tests according to the standards sited on page 1 of this report.

- Performed

- **Not** Performed

The Equipment Under Test

- **Fulfills** the general approval requirements cited on page 1.

- **Does not** fulfill the general approval requirements cited on page 1.

- TÜV PRODUCT SERVICE, INC. -

Responsible Engineer:



Mary Washington
(EMC Engineer)