

ENGINEERING TEST REPORT

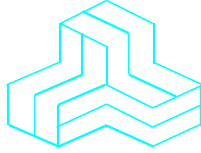

ENET Access Point
Model No.: ENET900AP

FCC ID: E5MDS-ENET900AP

Applicant:

Microwave Data Systems Inc.
175 Science Parkway
Rochester, NY
USA, 14620

In Accordance With

Federal Communications Commission (FCC)
Part 15, Subpart C, Section 15.247
Frequency Hopping Spread Spectrum Transmitters
Operating in 902.2 - 927.6 MHz Band

UltraTech's File No.: MIC-093F15C247

This Test report is Issued under the Authority of
Tri M. Luu, Professional Engineer,
Vice President of Engineering
UltraTech Group of Labs



Date: June 17, 2003

Report Prepared by: Dan Huynh

Tested by: Mr. Hung Trinh, EMI/RFI Technician

Issued Date: June 17, 2003

Test Dates: Jan. 30 - May 30, 2003

- *The results in this Test Report apply only to the sample(s) tested, and the sample tested is randomly selected.*
- *This report must not be used by the client to claim product endorsement by NVLAP or any agency of the US Government.*

UltraTech

3000 Bristol Circle, Oakville, Ontario, Canada, L6H 6G4
Tel.: (905) 829-1570 Fax.: (905) 829-8050
Website: www.ultratech-labs.com, Email: vic@ultratech-labs.com, Email: tri@ultratech-labs.com

31040/SIT

C-1376

46390-2049

200093-0

00-034





TABLE OF CONTENTS

EXHIBIT 1.	SUBMITTAL CHECK LIST	1
EXHIBIT 2.	INTRODUCTION.....	2
2.1.	SCOPE.....	2
2.2.	RELATED SUBMITTAL(S)/GRANT(S)	2
2.3.	NORMATIVE REFERENCES	2
EXHIBIT 3.	PERFORMANCE ASSESSMENT	3
3.1.	CLIENT INFORMATION	3
3.2.	EQUIPMENT UNDER TEST (EUT) INFORMATION	3
3.3.	EUT'S TECHNICAL SPECIFICATIONS.....	4
3.4.	ASSOCIATED ANTENNAS AND CABLE ASSEMBLY	4
3.5.	LIST OF EUT'S PORTS	5
3.6.	ANCILLARY EQUIPMENT	5
EXHIBIT 4.	EUT OPERATING CONDITIONS AND CONFIGURATIONS DURING TESTS	6
4.1.	CLIMATE TEST CONDITIONS	6
4.2.	OPERATIONAL TEST CONDITIONS & ARRANGEMENT FOR TESTS	6
EXHIBIT 5.	SUMMARY OF TEST RESULTS.....	7
5.1.	LOCATION OF TESTS	7
5.2.	APPLICABILITY & SUMMARY OF EMC EMISSION TEST RESULTS	7
5.3.	MODIFICATIONS INCORPORATED IN THE EUT FOR COMPLIANCE PURPOSES	7
EXHIBIT 6.	MEASUREMENTS, EXAMINATIONS & TEST DATA FOR EMC EMISSIONS.....	8
6.1.	TEST PROCEDURES	8
6.2.	MEASUREMENT UNCERTAINTIES.....	8
6.3.	MEASUREMENT EQUIPMENT USED	8
6.4.	ESSENTIAL/PRIMARY FUNCTIONS AS DECLARED BY THE MANUFACTURER.....	8
6.5.	COMPLIANCE WITH FCC PART 15 – GENERAL TECHNICAL REQUIREMENTS.....	9
6.6.	AC POWERLINE CONDUCTED EMISSIONS [47 CFR §15.107(A)]	13
6.7.	HOPPING CHANNEL CARRIER FREQUENCY CHARACTERISTICS [47 CFR §§ 15.247(A)(1) & (A)(1)(I)]	18
6.8.	PEAK OUTPUT POWER & EQUIVALENT ISOTROPIC RADIATED POWER (EIRP) [47 CFR § 15.247(B)].....	39
6.9.	RF EXPOSURE REQUIRMENTS [47 CFR §§ 15.247(B)(4), 1.1310 & 2.1091]	41
6.10.	TRANSMITTER BAND-EDGE & SPURIOUS CONDUCTED EMISSIONS [47 CFR § 15.247(c)].....	44
6.11.	TRANSMITTER SPURIOUS RADIATED EMISSIONS AT 3 METERS [47 CFR §§ 15.247(c), 15.209 & 15.205]	58
EXHIBIT 7.	MEASUREMENT UNCERTAINTY	72
7.1.	LINE CONDUCTED EMISSION MEASUREMENT UNCERTAINTY	72
7.2.	RADIATED EMISSION MEASUREMENT UNCERTAINTY.....	73
EXHIBIT 8.	MEASUREMENT METHODS.....	74
8.1.	GENERAL TEST CONDITIONS.....	74
8.2.	METHOD OF MEASUREMENTS - AC MAINS CONDUCTED EMISSIONS	75
8.3.	EQUIVALENT ISOTROPIC RADIATED POWER (EIRP).....	76
8.4.	SPURIOUS EMISSIONS (CONDUCTED & RADIATED).....	79
8.5.	ALTERNATIVE TEST PROCEDURES.....	82

EXHIBIT 1. SUBMITTAL CHECK LIST

Annex No.	Exhibit Type	Description of Contents	Quality Check (OK)
--	Test Report	<ul style="list-style-type: none"> ▪ Exhibit 1: Submittal check lists ▪ Exhibit 2: Introduction ▪ Exhibit 3: Performance Assessment ▪ Exhibit 4: EUT Operation and Configuration during Tests ▪ Exhibit 5: Summary of test Results ▪ Exhibit 6: Measurement Data ▪ Exhibit 7: Measurement Uncertainty ▪ Exhibit 8: Measurement Methods 	OK
1	Test Setup Photos	<ul style="list-style-type: none"> ▪ AC Conducted Emissions Setup Photos ▪ Radiated Emissions Setup Photos 	OK
2	External EUT Photos	External EUT Photos	OK
3	Internal EUT Photos	Internal EUT Photos	OK
4	Cover Letters	<ul style="list-style-type: none"> ▪ Letter from Ultratech for Certification Request ▪ Letter from the Applicant to appoint Ultratech to act as an agent ▪ Letter from the Applicant to request for Confidentiality Filing 	OK
5	Attestation Statements	Professional Installation Requirement	OK
6	ID Label/Location Info	<ul style="list-style-type: none"> ▪ ID Label ▪ Location of ID Label 	OK
7	Block Diagrams	Block Diagram	OK
8	Schematic Diagrams	Schematics	OK
9	Parts List/Tune Up Info	<ul style="list-style-type: none"> ▪ EL806 OEM Transnet Bill of Materials ▪ Access Point Bill of Materials 	OK
10	Operational Description	Theory of Operations	OK
11	RF Exposure Info	MPE Evaluation, see section 6.9 in this Test Report for details.	OK
12	Users Manual	MDS entraNET System Guide	OK

EXHIBIT 2. INTRODUCTION

2.1. SCOPE

Reference:	FCC Part 15, Subpart C, Section 15.247:2000
Title:	Telecommunication – 47 Code of Federal Regulations (CFR), Part 15
Purpose of Test:	To gain FCC Certification Authorization for Frequency Hopping Spread Spectrum Transmitters Operating in the Frequency Band 902 - 928 MHz .
Test Procedures:	Both conducted and radiated emissions measurements were conducted in accordance with American National Standards Institute ANSI C63.4 - American National Standard for Methods of Measurement of Radio-Noise Emissions from Low-Voltage Electrical and Electronic Equipment in the Range of 9 kHz to 40 GHz.
Environmental Classification:	[] Residential [x] Light-industry, Commercial [x] Industry

2.2. RELATED SUBMITTAL(S)/GRANT(S)

None

2.3. NORMATIVE REFERENCES

Publication	Year	Title
47 CFR Parts 0-19	2002	Code of Federal Regulations – Telecommunication
ANSI C63.4	1992	American National Standard for Methods of Measurement of Radio-Noise Emissions from Low-Voltage Electrical and Electronic Equipment in the Range of 9 kHz to 40 GHz
CISPR 22 & EN 55022	1997 1998	Limits and Methods of Measurements of Radio Disturbance Characteristics of Information Technology Equipment
CISPR 16-1	1999	Specification for Radio Disturbance and Immunity measuring apparatus and methods
FCC Public Notice DA 00-705	2000	Filing and Measurement Guidelines for Frequency Hopping Spread Spectrum Systems
FCC Public Notice DA 00-1407	2000	Part 15 Unlicensed Modular Transmitter Approval

EXHIBIT 3. PERFORMANCE ASSESSMENT

3.1. CLIENT INFORMATION

APPLICANT	
Name:	Microwave Data Systems Inc.
Address:	175 Science Parkway Rochester, NY USA, 14620
Contact Person:	Mr. Dennis McCarthy Agency Compliance Engineer Phone #: 585 242-8440 Fax #: 585 241-5590 Email Address: dmccarthy@microwavedata.com

MANUFACTURER	
Name:	Microwave Data Systems Inc.
Address:	175 Science Parkway Rochester, NY USA, 14620
Contact Person:	Mr. Dennis McCarthy Agency Compliance Engineer Phone #: 585 242-8440 Fax #: 585 241-5590 Email Address: dmccarthy@microwavedata.com

3.2. EQUIPMENT UNDER TEST (EUT) INFORMATION

The following information (with the exception of the Date of Receipt) has been supplied by the applicant.

Brand Name:	Microwave Data Systems Inc.
Product Name:	ENET Access Point
Model Name or Number:	ENET900AP
Serial Number:	Test Sample
Type of Equipment:	Frequency Hopping Spread Spectrum Transmitter
Input Power Supply Type:	External Regulated DC Sources
Primary User Functions of EUT:	Wireless Data Transfer - Half duplex data transceiver FHSS

3.3. EUT'S TECHNICAL SPECIFICATIONS

TRANSMITTER	
Equipment Type:	<input type="checkbox"/> Portable <input checked="" type="checkbox"/> Mobile <input checked="" type="checkbox"/> Base Station (fixed use)
Intended Operating Environment:	<input type="checkbox"/> Residential <input checked="" type="checkbox"/> Commercial, light industry & heavy industry
Power Supply Requirement:	13.8 Vdc Nominal
RF Output Power Rating:	1.0 Watt
Operating Frequency Range:	902.2 - 927.6 MHz
RF Output Impedance:	50 Ohms
Channel Spacing:	200 kHz
Duty Cycle:	Continuous
20 dB Bandwidth:	158.3 kHz
Modulation Type:	CPFSK
Channel Occupancy:	<ul style="list-style-type: none"> ▪ 286 ms within 20 second period (28 ms Hop Dwell Setting) ▪ 233 ms within 20 second period (7 ms Hop Dwell Setting)
Emission Designation:	Frequency Hopping Spread Spectrum
Oscillator Frequency(ies):	16MHz TCXO, 110.7MHz I.F. 10.7MHz second IF
Antenna Connector Type:	TNC

3.4. ASSOCIATED ANTENNAS AND CABLE ASSEMBLY

Brand	Model	Description
MDS ClearWave Antennas	Z1523A	902-960 MHz 6.4 dBd (8.5 dBi) yagi directional antenna, Black Teflon impregnated CORVEL® powder coat w/ 10ft. LMR 400 cable heat shrunk to boom and RPTNC (plug) male connector on the end includes MYK14 Heavy duty mounting bracket.
MDS ClearWave Antennas	Z1523B	902-960 MHz 6.4 dBd (8.5 dBi) yagi directional antenna, Black Teflon impregnated CORVEL® powder coat w/ 15ft. LMR 400 cable heat shrunk to boom and RPTNC (plug) male connector on the end includes MYK14 Heavy duty mounting bracket.
MDS ClearWave Antennas	Z1523C	902-960 MHz 6.4 dBd (8.5 dBi) yagi directional antenna, Black Teflon impregnated CORVEL® powder coat w/ 25ft. LMR 400 cable heat shrunk to boom and RPTNC (plug) male connector on the end includes MYK14 Heavy duty mounting bracket.
MDS ClearWave Antennas	Z1526	902-928 MHz 5 dBd (7.1 dBi) omni directional base station antenna with integral RG213 10ft pigtail and RPTNC (plug) male connector. Includes MMK9 heavy duty bracket for use with pipe OD's of up to 2 1/2".

3.5. LIST OF EUT'S PORTS

Port Number	EUT's Port Description	Number of Identical Ports	Connector Type	Cable Type (Shielded/Non-shielded)
1	Primary Power	1	2-Pin Power Plug	Non-shielded
2	Antenna	1	TNC	Shielded
3	COM1	1	6-Position Modular Jack	Non-shielded
4	COM2	1	8-Position Modular Jack	Non-shielded
5	LAN	1	RJ-45	Non-shielded

3.6. ANCILLARY EQUIPMENT

The EUT was tested while connected to the following representative configuration of ancillary equipment necessary to exercise the ports during tests:

Ancillary Equipment # 1	
Description:	Laptop
Brand:	HP
Model Name or Number:	5500CS
Serial Number:	TW63403246
Connected to EUT's Port:	COM1, to configure the unit for testing purposes only.

EXHIBIT 4. EUT OPERATING CONDITIONS AND CONFIGURATIONS DURING TESTS

4.1. CLIMATE TEST CONDITIONS

The climate conditions of the test environment are as follows:

Temperature:	21°C
Humidity:	51%
Pressure:	102 kPa
Power Input Source:	13.8 Vdc nominal

4.2. OPERATIONAL TEST CONDITIONS & ARRANGEMENT FOR TESTS

Operating Modes:	<ul style="list-style-type: none"> ▪ Each of lowest, middle and highest channel frequencies transmits continuously for emissions measurements. ▪ The EUT operates in normal Frequency Hopping mode for occupancy duration, and frequency separation.
Special Test Software & Hardware:	Special firmware and hardware provided by the Applicant are installed to allow the EUT to operate in hopping mode or at each channel frequency continuously. For example, the transmitter will be operated at each of lowest, middle and highest frequencies individually continuously during testing.
Transmitter Test Antenna:	The EUT is tested with the antenna fitted in a manner typical of normal intended use as non-integral antenna equipment.

Transmitter Test Signals	
Frequency Band(s):	902.2 - 927.6 MHz
Frequency(ies) Tested:	Lowest: 902.2 MHz Middle: 915.0 MHz Highest: 927.6 MHz
RF Power Output (measured maximum output power at antenna terminals):	1.0 Watt
Normal Test Modulation:	CPFSK
Modulating Signal Source:	Internal

EXHIBIT 5. SUMMARY OF TEST RESULTS

5.1. LOCATION OF TESTS

All of the measurements described in this report were performed at Ultratech Group of Labs located in the city of Oakville, Province of Ontario, Canada.

- AC Powerline Conducted Emissions were performed in UltraTech's shielded room, 24'(L) by 16'(W) by 8'(H).
- Radiated Emissions were performed at the Ultratech's 3 Meter Open Field Test Site (OFTS) situated in the Town of Oakville, province of Ontario.

The above sites have been calibrated in accordance with ANSI C63.4, and found to be in compliance with the requirements of Sec. 2.948 of the FCC Rules. The descriptions and site measurement data of the Oakville Open Field Test Site has been filed with FCC office (FCC File No.: 31040/SIT 1300B3) and Industry Canada office (Industry Canada File No.: IC2049). Last Date of Site Calibration: August 10, 2002.

5.2. APPLICABILITY & SUMMARY OF EMC EMISSION TEST RESULTS

FCC Paragraph	Test Requirements	Compliance (Yes/No)
15.107(a)	AC Power Line Conducted Emissions Measurements	Yes
15.247(a)(1) & 15.247(a)(1)(i)	Frequency Hopping Systems Characteristics	Yes
15.247(b)(2)	Peak Output Power	Yes
15.247(b)(4), 1.1307, 1.1310, 2.1091 & 2.1093	RF Exposure Limit	Yes
15.247(c)	Band-Edge and RF Conducted Spurious Emissions at the Transmitter Antenna Terminal	Yes
15.247(c), 15.209 & 15.205	Transmitter Spurious Radiated Emissions	Yes

The digital circuit portion of the EUT has been tested and verified to comply with FCC Part 15, Subpart B, Class A Digital Devices and the associated Radio Receiver operating in 902.2 - 927.6 MHz has also been tested and found to comply with FCC Part 15, Subpart B – Radio Receivers. The engineering test report is available upon FCC requests.

5.3. MODIFICATIONS INCORPORATED IN THE EUT FOR COMPLIANCE PURPOSES

None

EXHIBIT 6. MEASUREMENTS, EXAMINATIONS & TEST DATA FOR EMC EMISSIONS

6.1. TEST PROCEDURES

This section contains test results only. Details of test methods and procedures can be found in Exhibit 8 of this report, ANSI C63-4:1992 and FCC Public Notice @ DA 00-705 (March 30, 2000) – Filing and Measurement Guidelines for Frequency Hopping Spread Spectrum Systems.

6.2. MEASUREMENT UNCERTAINTIES

The measurement uncertainties stated were calculated in accordance with requirements of UKAS Document NIS 81 with a confidence level of 95%. Please refer to Exhibit 7 for Measurement Uncertainties.

6.3. MEASUREMENT EQUIPMENT USED

The measurement equipment used complied with the requirements of the Standards referenced in the Methods & Procedures ANSI C64-3:1992, FCC 15.247 and CISPR 16-1.

6.4. ESSENTIAL/PRIMARY FUNCTIONS AS DECLARED BY THE MANUFACTURER

The essential function of the EUT is to correctly communicate data to and from radios over RF link.

6.5. COMPLIANCE WITH FCC PART 15 – GENERAL TECHNICAL REQUIREMENTS

FCC Section	FCC Rules	Manufacturer's Clarification
15.31	The hopping function must be disabled for tests, which should be performed with the EUT transmitting on the number of frequencies specified in this Section. The measurements made at the upper and lower ends of the band of operation should be made with the EUT tuned to the highest and lowest available channels.	Hopping function was disabled during testing
15.203	Described how the EUT complies with the requirement that either its antenna is permanently attached, or that it employs a unique antenna connector, for every antenna proposed for use with the EUT. The exception is in those cases where EUT must be professionally installed. In order to demonstrate that professional installation is required, the following 3 points must be addressed: <ul style="list-style-type: none"> • The application (or intended use) of the EUT • The installation requirements of the EUT • The method by which the EUT will be marketed 	EUT must be professionally installed; see Microwave Data Systems Inc. Professional Installation attestation letter, which addresses the 3 professional installation requirements.
15.204	Provided the information for every antenna proposed for use with the EUT: (a) type (e.g. Yagi, patch, grid, dish, etc...), (b) manufacturer and model number (c) gain with reference to an isotropic radiator	Please refer to section 3.4 of this test report for details of antenna information
15.247(a)	Description of how the EUT meets the definition of a frequency hopping spread spectrum, found in Section 2.1. Based on the technical description.	The radio hops on 200KHz channels using a pseudo-random sequence. It utilizes greater than 50 frequencies and uses each frequency less than 0.4 seconds within any 20 second period.
15.247(a)	<u>Pseudo Frequency Hopping Sequence:</u> Describe how the hopping sequence is generated. Provide an example of the hopping sequence channels, in order to demonstrate that the sequence meets the requirements specified in the definition of a frequency hopping spread spectrum system, found in Section 2.1	The pseudo-random sequence is derived from a Linear Congruential Generator (LCG). $\text{rnd}(i+1) = (\text{rnd}(i)*b + a) \text{ mod } 128$ "a" and "b" are chosen based on system address (ADDR) and are qualified to guarantee a sequence of length 128. Skipped channels are removed from the sequence. Mapping of sequence index to frequency is based on $902.2\text{MHz} + \text{index} * 200\text{KHz}$, where index is a value between 0 and 127. A sample sequence is provided listed as ATTACHMENT #1.

FCC Section	FCC Rules	Manufacturer's Clarification
15.247(a)	<u>Equal Hopping Frequency Use:</u> Describe how each individual EUT meets the requirement that each of its hopping channels is used equally on average (e.g. that each new transmission event begins on the next channel in the hopping sequence after final channel used in the previous transmission events).	Dwell time is an equal fixed duration on each channel. Hopping is asynchronous to serial data input. Randomly presented data will be randomly distributed across all channels in the sequence.
15.247(g)	Describe how the EUT complies with the requirement that it be designed to be capable of operating as a true frequency hopping system	The radio will always hop on a minimum of 64 channels. Dwell time is an equal fixed duration on each channel. In the presence of continuous data all channels in the hop sequence will be used equally. This applies to a radio configured as either a master or a remote.
15.247(h)	Describe how the EUT complies with the requirement that it not have the ability to coordinated with other FHSS is an effort to avoid the simultaneous occupancy of individual hopping frequencies by multiple transmitters	Hopping is statically determined based on system address and other configurable parameters. The radio does NOT alter this pattern based on channel occupancy or any other dynamic factors.
Public Notice DA 00-705	<u>System Receiver Input Bandwidth:</u> Describe how the associated receiver(s) complies with the requirement that its input bandwidth (either RF or IF) matches the bandwidth of the transmitted signal.	The receiver has an IF bandwidth of 150 KHz, matching the bandwidth of the transmitted signal
Public Notice DA 00-705	<u>System Receiver Hopping Capability:</u> Describe how the associated receiver(s) has the ability to shift frequencies in synchronization with the transmitted signals	Once synchronization is achieved, all radios hop in lock step together with the master. Timing adjustments to cover clock drift are made based on the measured arrival time of dedicated SYNC messages.

ATTACHMENT #1

Sample Psuedo-Random Sequence (values 0-127)

```
seq_next: 0031 (001f)
seq_next: 0034 (0022)
seq_next: 0121 (0079)
seq_next: 0084 (0054)
seq_next: 0035 (0023)
seq_next: 0022 (0016)
seq_next: 0029 (001d)
seq_next: 0104 (0068)
seq_next: 0103 (0067)
seq_next: 0074 (004a)
seq_next: 0001 (0001)
seq_next: 0060 (003c)
seq_next: 0107 (006b)
seq_next: 0062 (003e)
seq_next: 0037 (0025)
seq_next: 0080 (0050)
seq_next: 0047 (002f)
seq_next: 0114 (0072)
seq_next: 0009 (0009)
seq_next: 0036 (0024)
seq_next: 0051 (0033)
seq_next: 0102 (0066)
seq_next: 0045 (002d)
```

ULTRATECH GROUP OF LABS

3000 Bristol Circle, Oakville, Ontario, Canada L6H 6G4
 Tel. #: 905-829-1570, Fax. #: 905-829-8050, Email: vic@ultratech-labs.com, Website: <http://www.ultratech-labs.com>

File #: MIC-093F15C247

June 17, 2003

All test results contained in this engineering test report are traceable to National Institute of Standards and Technology (NIST)

seq_next: 0056 (0038)
seq_next: 0119 (0077)
seq_next: 0026 (001a)
seq_next: 0017 (0011)
seq_next: 0012 (000c)
seq_next: 0123 (007b)
seq_next: 0014 (000e)
seq_next: 0053 (0035)
seq_next: 0032 (0020)
seq_next: 0063 (003f)
seq_next: 0066 (0042)
seq_next: 0025 (0019)
seq_next: 0116 (0074)
seq_next: 0067 (0043)
seq_next: 0054 (0036)
seq_next: 0061 (003d)
seq_next: 0008 (0008)
seq_next: 0007 (0007)
seq_next: 0106 (006a)
seq_next: 0033 (0021)
seq_next: 0092 (005c)
seq_next: 0011 (000b)
seq_next: 0094 (005e)
seq_next: 0069 (0045)
seq_next: 0112 (0070)
seq_next: 0079 (004f)
seq_next: 0018 (0012)
seq_next: 0041 (0029)
seq_next: 0068 (0044)
seq_next: 0083 (0053)
seq_next: 0006 (0006)
seq_next: 0077 (004d)
seq_next: 0088 (0058)
seq_next: 0023 (0017)
seq_next: 0058 (003a)
seq_next: 0049 (0031)
seq_next: 0044 (002c)
seq_next: 0027 (001b)
seq_next: 0046 (002e)
seq_next: 0085 (0055)
seq_next: 0064 (0040)
seq_next: 0095 (005f)
seq_next: 0098 (0062)
seq_next: 0057 (0039)
seq_next: 0020 (0014)
seq_next: 0099 (0063)
seq_next: 0086 (0056)
seq_next: 0093 (005d)
seq_next: 0040 (0028)
seq_next: 0039 (0027)
seq_next: 0010 (000a)
seq_next: 0065 (0041)
seq_next: 0124 (007c)
seq_next: 0043 (002b)
seq_next: 0126 (007e)
seq_next: 0101 (0065)
seq_next: 0016 (0010)
seq_next: 0111 (006f)
seq_next: 0050 (0032)
seq_next: 0073 (0049)
seq_next: 0100 (0064)
seq_next: 0115 (0073)
seq_next: 0038 (0026)
seq_next: 0109 (006d)
seq_next: 0120 (0078)
seq_next: 0055 (0037)
seq_next: 0090 (005a)
seq_next: 0081 (0051)
seq_next: 0076 (004c)
seq_next: 0059 (003b)
seq_next: 0078 (004e)
seq_next: 0117 (0075)

ULTRATECH GROUP OF LABS

3000 Bristol Circle, Oakville, Ontario, Canada L6H 6G4
Tel. #: 905-829-1570, Fax. #: 905-829-8050, Email: vic@ultratech-labs.com, Website: <http://www.ultratech-labs.com>

File #: MIC-093F15C247

June 17, 2003

All test results contained in this engineering test report are traceable to National Institute of Standards and Technology (NIST)

seq_next: 0096 (0060)
seq_next: 0127 (007f)
seq_next: 0002 (0002)
seq_next: 0089 (0059)
seq_next: 0052 (0034)
seq_next: 0003 (0003)
seq_next: 0118 (0076)
seq_next: 0125 (007d)
seq_next: 0072 (0048)
seq_next: 0071 (0047)
seq_next: 0042 (002a)
seq_next: 0097 (0061)
seq_next: 0028 (001c)
seq_next: 0075 (004b)
seq_next: 0030 (001e)
seq_next: 0005 (0005)
seq_next: 0048 (0030)
seq_next: 0015 (000f)
seq_next: 0082 (0052)
seq_next: 0105 (0069)
seq_next: 0004 (0004)
seq_next: 0019 (0013)
seq_next: 0070 (0046)
seq_next: 0013 (000d)
seq_next: 0024 (0018)
seq_next: 0087 (0057)
seq_next: 0122 (007a)
seq_next: 0113 (0071)
seq_next: 0108 (006c)
seq_next: 0091 (005b)
seq_next: 0110 (006e)
seq_next: 0021 (0015)
seq_next: 0000 (0000)

6.6. AC POWERLINE CONDUCTED EMISSIONS [47 CFR §15.107(a)]

6.6.1. Limits

The equipment shall meet the limits of the following table:

Frequency of Emission (MHz)	Class B Conducted Limit (dBµV)		Measuring Bandwidth
	Quasi-Peak	Average	
0.15 to 0.5	66 to 56*	56 to 46*	RBW = 9 kHz VBW ≥ 9 kHz for QP VBW = 1 Hz for Average
0.5 to 5	56	46	RBW = 9 kHz VBW ≥ 9 kHz for QP VBW = 1 Hz for Average
5 to 30	60	50	RBW = 9 kHz VBW ≥ 9 kHz for QP VBW = 1 Hz for Average

*Decreases linearly with the logarithm of the frequency

6.6.2. Method of Measurements

Refer to Exhibit 8, Section 8.2 of this test report & ANSI C63-4:1992

6.6.3. Test Arrangement

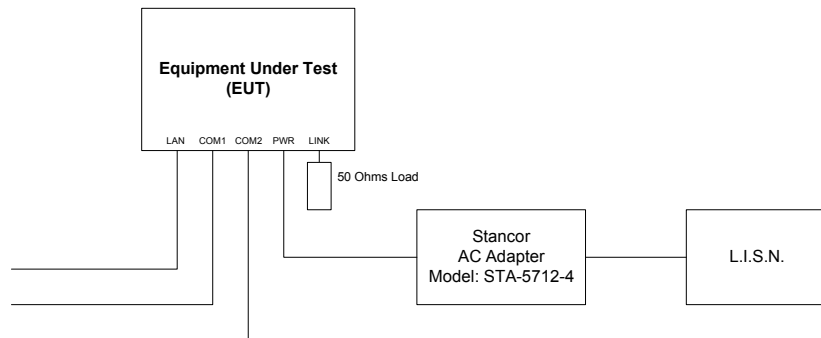

6.6.4. Test Equipment List

Test Instruments	Manufacturer	Model No.	Serial No.	Frequency Range
Spectrum Analyzer/ EMI Receiver	Hewlett Packard	HP 8593EM	3412A00103	9 kHz – 26.5 GHz
Transient Limiter	Hewlett Packard	11947A	310701998	9 kHz – 200 MHz 10 dB attenuation
L.I.S.N.	EMCO	3825/2	89071531	9 kHz – 200 MHz 50 Ohms / 50 µH
24'(L) x 16'(W) x 8'(H) RF Shielded Chamber	Braden Shielding

ULTRATECH GROUP OF LABS

3000 Bristol Circle, Oakville, Ontario, Canada L6H 6G4
Tel. #: 905-829-1570, Fax. #: 905-829-8050, Email: vic@ultratech-labs.com, Website: <http://www.ultratech-labs.com>

File #: MIC-093F15C247

June 17, 2003

All test results contained in this engineering test report are traceable to National Institute of Standards and Technology (NIST)

6.6.5. Test Data

Frequency (MHz)	RF Level (dB μ V)	Receiver Detector (P/QP/AVG)	QP Limit (dB μ V)	AVG Limit (dB μ V)	Margin (dB)	Pass/ Fail	Line Tested (L1/L2)
0.152	47.7	QP	65.9	55.9	-18.2	Pass	L1
0.152	17.6	AVG	65.9	55.9	-38.3	Pass	L1
0.204	46.0	QP	63.4	53.4	-17.4	Pass	L1
0.204	16.0	AVG	63.4	53.4	-37.4	Pass	L1
0.358	42.8	QP	58.8	48.8	-16.0	Pass	L1
0.358	13.6	AVG	58.8	48.8	-35.2	Pass	L1
1.140	37.0	QP	56.0	46.0	-19.0	Pass	L1
1.140	12.7	AVG	56.0	46.0	-33.3	Pass	L1
0.150	47.5	QP	66.0	56.0	-18.5	Pass	L2
0.150	17.5	AVG	66.0	56.0	-38.5	Pass	L2
0.182	46.4	QP	64.4	54.4	-18.0	Pass	L2
0.182	16.4	AVG	64.4	54.4	-38.0	Pass	L2
0.371	42.9	QP	58.5	48.5	-15.6	Pass	L2
0.371	13.1	AVG	58.5	48.5	-35.4	Pass	L2
1.175	38.1	QP	56.0	46.0	-17.9	Pass	L2
1.175	11.7	AVG	56.0	46.0	-34.3	Pass	L2

Note: See the following plots (1 – 2) for detailed measurements

Plot 1:
 AC Power Line Conducted Emissions
 Line Voltage: 120 Vac 60 Hz
 Line Tested: L1

hp

Signal	Freq (MHz)	PK Amp	QP Amp	AV Amp	QP Δ L1
1	0.152250	53.8	47.7	17.6	-18.2
2	0.204000	52.5	46.0	16.0	-17.5
3	0.357625	50.1	42.8	13.6	-16.0
4	1.140000	45.0	37.0	12.7	-19.0

ACTV DET: PEAK
 MEAS DET: PEAK QP AVG
 MKR 1.13 MHz
 32.45 dB μ V

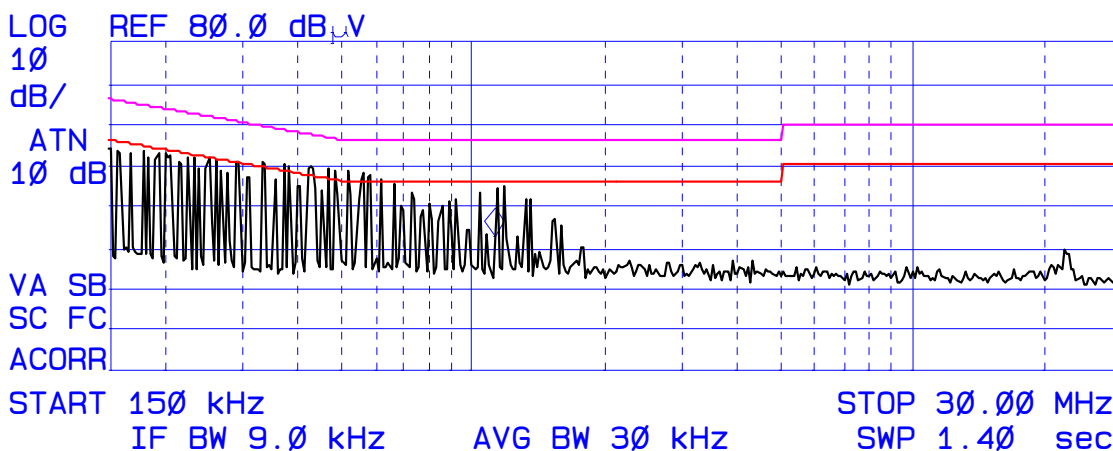

Plot 2:
 AC Power Line Conducted Emissions
 Line Voltage: 120 Vac 60 Hz
 Line Tested: L2

hp

Signal	Freq (MHz)	PK Amp	QP Amp	AV Amp	QP Δ L1
1	0.150000	54.1	47.5	17.5	-18.5
2	0.181875	53.1	46.4	16.4	-18.0
3	0.371000	50.8	42.9	13.1	-15.6
4	1.175000	46.3	38.1	11.7	-17.9

ACTV DET: PEAK
 MEAS DET: PEAK QP AVG
 MKR 370 kHz
 50.58 dB μ V

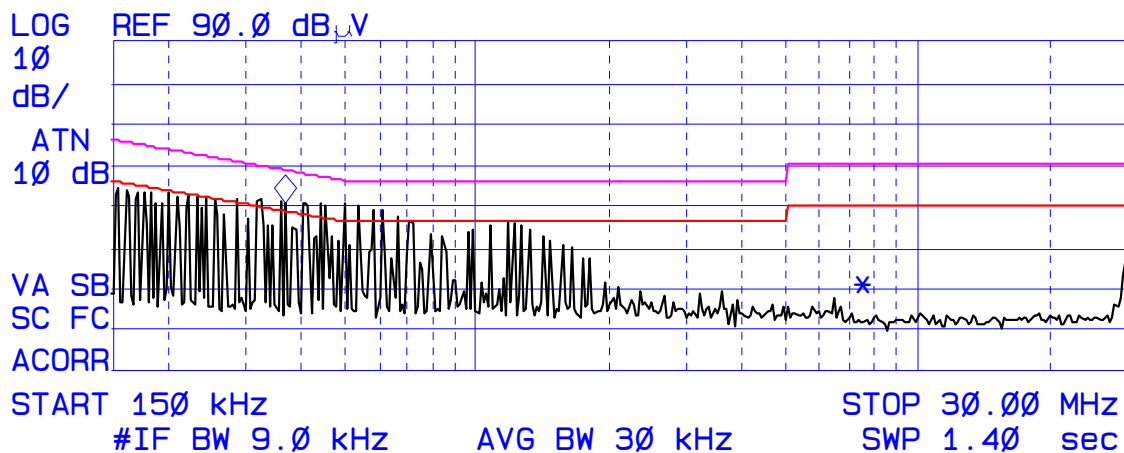

6.7. HOPPING CHANNEL CARRIER FREQUENCY CHARACTERISTICS [47 CFR §§ 15.247(a)(1) & (a)(1)(i)]

6.7.1. Limits

- **FCC 47 CFR, Para 15.247(a)(1):** Frequency hopping systems shall have hopping channel carrier frequencies separated by a minimum of 25 kHz or the 20 dB bandwidth of the hopping channel, whichever is greater. The system shall hop to channel frequencies that are selected at the system hopping rate from a pseudorandomly ordered list of hopping frequencies. Each frequency must be used equally on the average by each transmitter. The system receivers shall have input bandwidths that match the hopping channel bandwidths of their corresponding transmitters and shall shift frequencies in synchronization with the transmitted signals.
- **FCC 47 CFR, Para 15.247(a)(1)(i):** For frequency hopping systems operating in the 902–928 MHz band: if the 20 dB bandwidth of the hopping channel is less than 250 kHz, the system shall use at least 50 hopping frequencies and the average time of occupancy on any frequency shall not be greater than 0.4 seconds within a 20 second period; if the 20 dB bandwidth of the hopping channel is 250 kHz or greater, the system shall use at least 25 hopping frequencies and the average time of occupancy on any frequency shall not be greater than 0.4 seconds within a 10 second period. The maximum allowed 20 dB bandwidth of the hopping channel is 500 kHz.

6.7.2. Method of Measurements

Refer to FCC 15.247(a)(1), ANSI C63-4:1992 and Public Notice DA 00-705

Carrier Frequency Separation:

The hopping function of the EUT is enabled. Use the spectrum analyzer setting as follows:

- Span = wide enough to capture the peaks of two adjacent channels
- RBW = 1% of the span
- VBW = RBW
- Sweep = Auto
- Detector = peak
- Trace = max hold

Number of hopping frequency:

The hopping function of the EUT is enabled. Use the spectrum analyzer setting as follows:

- Span = the frequency band of operation
- RBW = 1% of the span
- VBW = RBW
- Sweep = Auto
- Detector = peak
- Trace = max hold

Time of Occupancy (Dwell Time):

The hopping function of the EUT is enabled. Use the spectrum analyzer setting as follows:

- Span = 0 Hz centered on a hopping channel
- RBW = 1 MHz
- VBW = RBW
- Sweep = as necessary to capture the entire dwell time per hopping channel
- Detector = peak
- Trace = max hold

If possible, use the marker-delta function to determine the dwell time. If this value varies with different modes of operation (e.g. data rate modulation format, etc.), repeat this test for each variation. The limit is specified in one of the subparagraphs of this Section. Submit this plot(s). An oscilloscope may be used instead of a spectrum analyzer.

20 dB Bandwidth:

Use the spectrum analyzer setting as follows:

- Span = approximately 2 to 3 times the 20 dB bandwidth, centered on a hopping channel
- RBW = 1% of the 20 dB bandwidth
- VBW = RBW
- Sweep = auto
- Detector = peak
- Trace = max hold
- The transmitter shall be transmitting at its maximum data rate.
- Allow the trace to stabilize.
- Use the marker-to-peak function to set the marker to the peak of the emission.
- Use the marker-delta function to measure 20 dB down on both sides of the emission.
- The 20 dB BW is the delta reading in frequency between two markers.

6.7.3. Test Arrangement

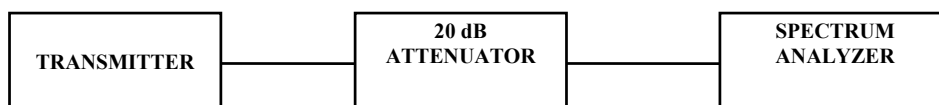

6.7.4. Test Equipment List

Test Instruments	Manufacturer	Model No.	Serial No.	Frequency Range
Spectrum Analyzer/ EMI Receiver	Advantest	R3271	15050203	100 Hz – 26.5 GHz
Attenuator	Weinschel Corp	24-20-34	BJ2357	DC – 8.5 GHz

6.7.5. Test data

Test Description	FCC Specification	Measured Values	Comments
20 dB BW of the hopping channel	500 kHz maximum	158.3 kHz	Pass, see plots 3 to 5 measurement details.
Channel Hopping Frequency Separation	Minimum of 25 kHz or 20dB BW whichever is greater.	200 kHz	Pass, see plot 6 for measurement details.
Number hopping frequencies	At least 50 hopping frequencies	Minimum number of hopping channels is 64.	Pass, see plot 7 for measurement details
Average Time of Occupancy	Not greater than 0.4 seconds within 20 second period	286 ms (0.286 s) within 20 second period	Pass, see plots 8 to 19 for measurement details.

Plot 3:
20 dB Bandwidth
Channel: Low, Tx. Frequency: 902.2 MHz, Modulation: 2 Level CPFSK

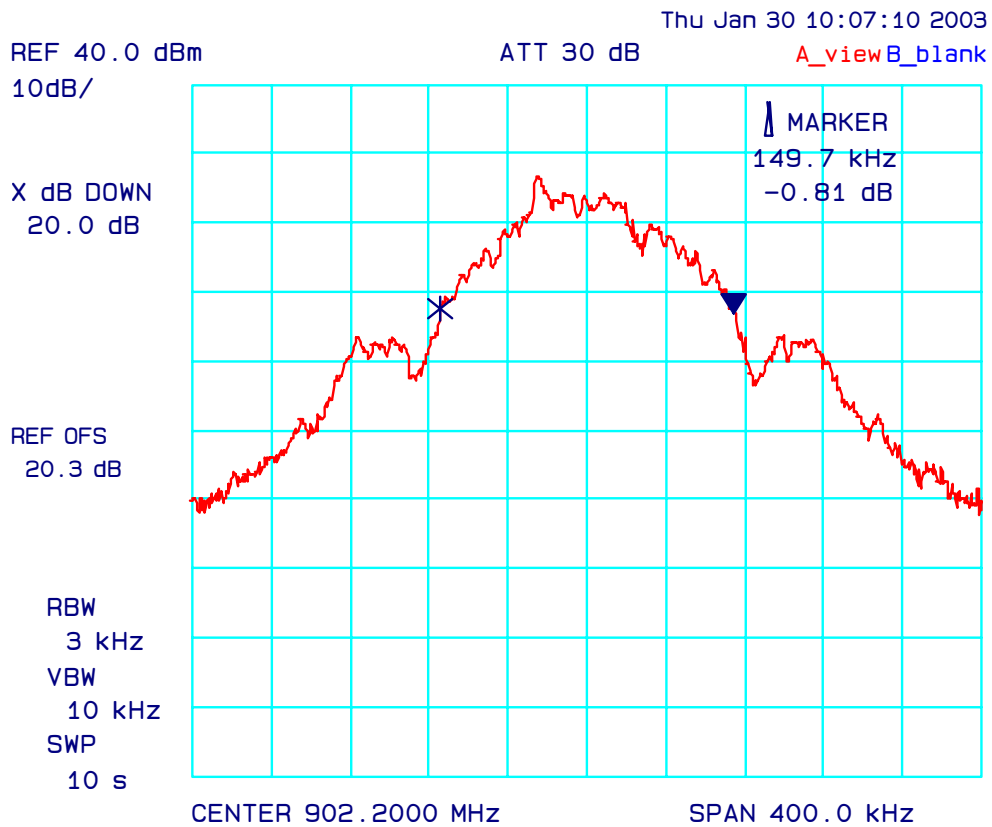

Plot 4:
20 dB Bandwidth
Channel: Mid, Tx. Frequency: 915 MHz, Modulation: 2 Level CPFSK

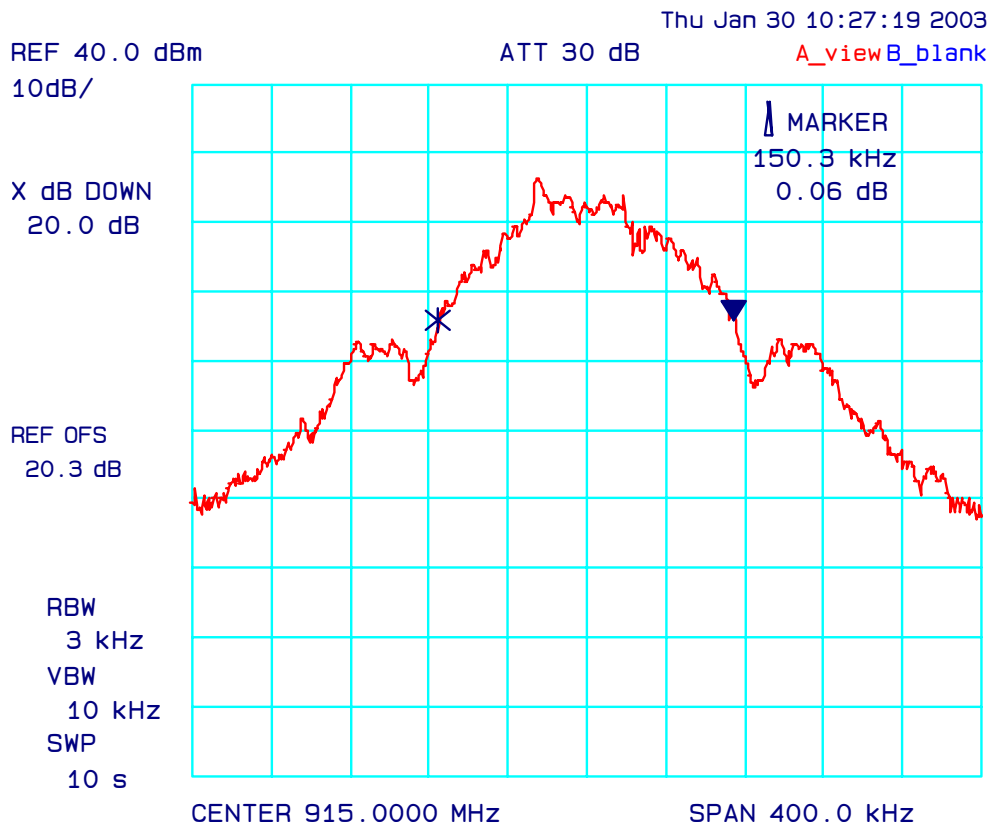

Plot 5:
20 dB Bandwidth
Channel: High, Tx. Frequency: 927.6 MHz, Modulation: 2 Level CPFSK

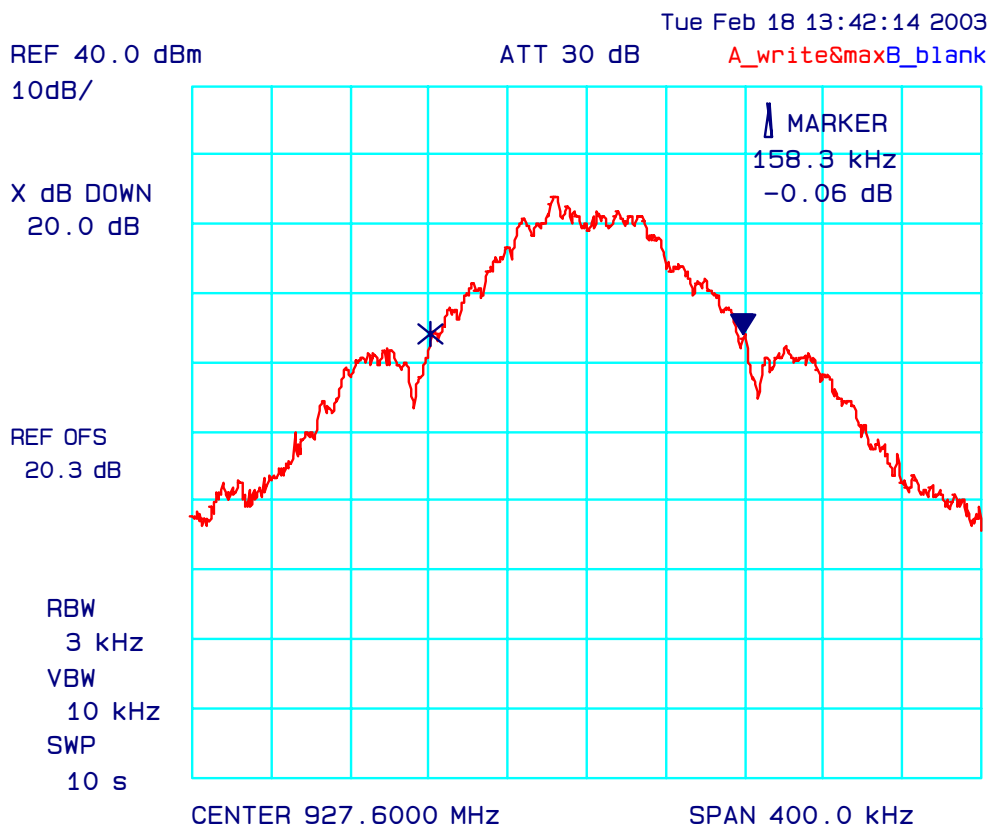

Plot 6:
Channel Hopping Frequency Separation

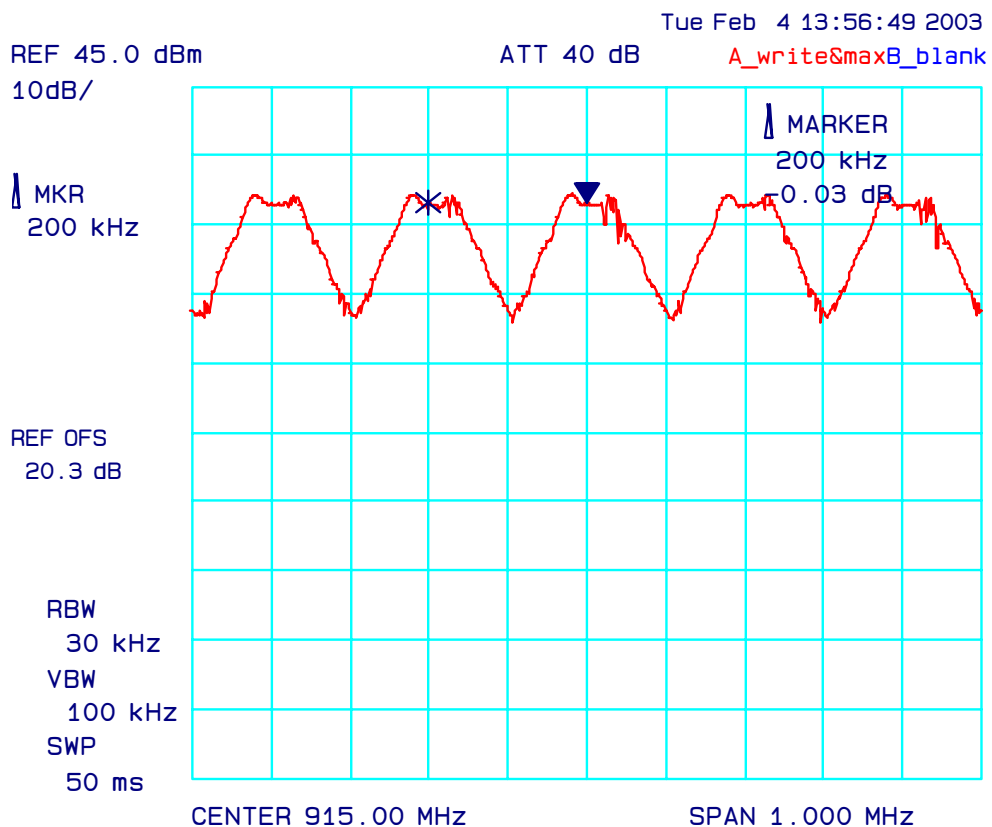

Plot 7:
Minimum Number of Hopping Channels

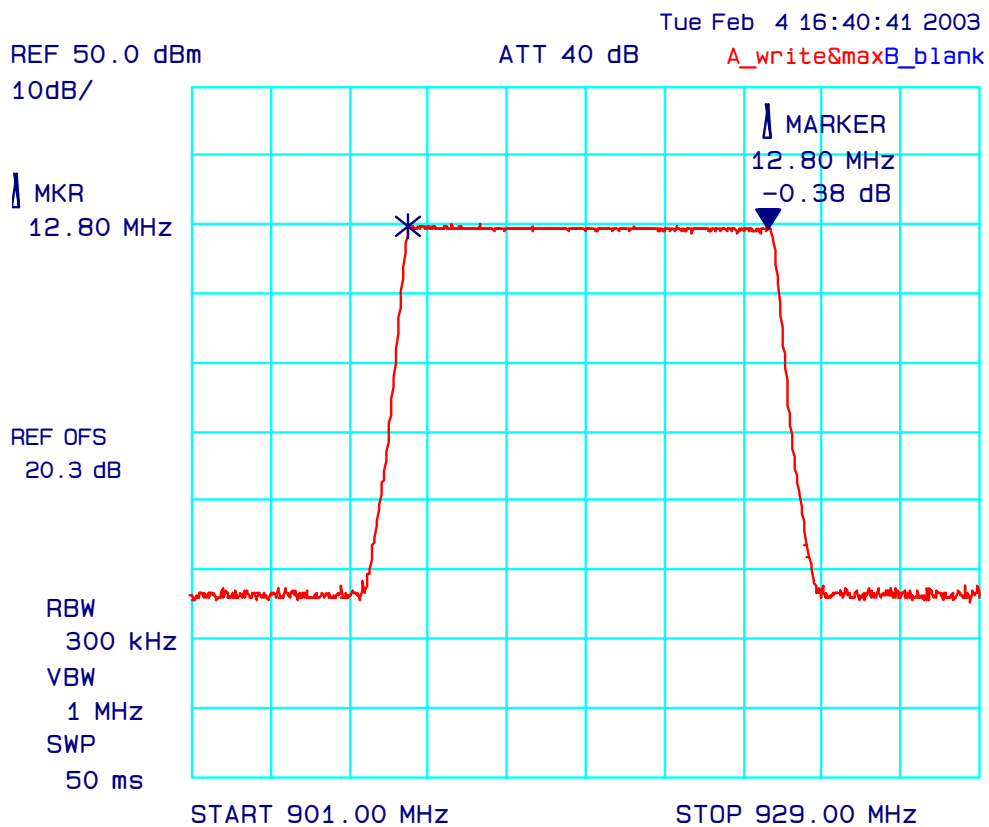

Plot 8:
Average Time of Occupancy
28 ms Hop Dwell Setting
Channel: Low, Tx. Frequency: 902.2 MHz, Modulation: 2 Level CPFSK

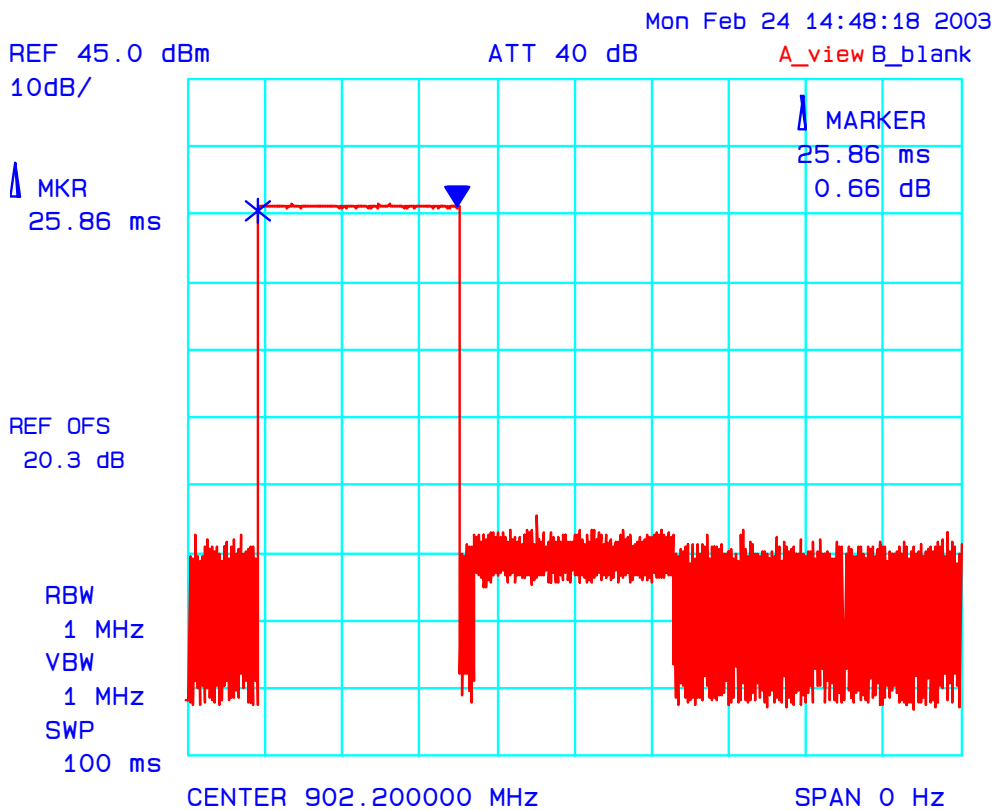

Dwell Time @ 902.2 MHz = 25.86 ms

Plot 9:
Average Time of Occupancy
28 ms Hop Dwell Setting
Channel: Low, Tx. Frequency: 902.2 MHz, Modulation: 2 Level CPFSK

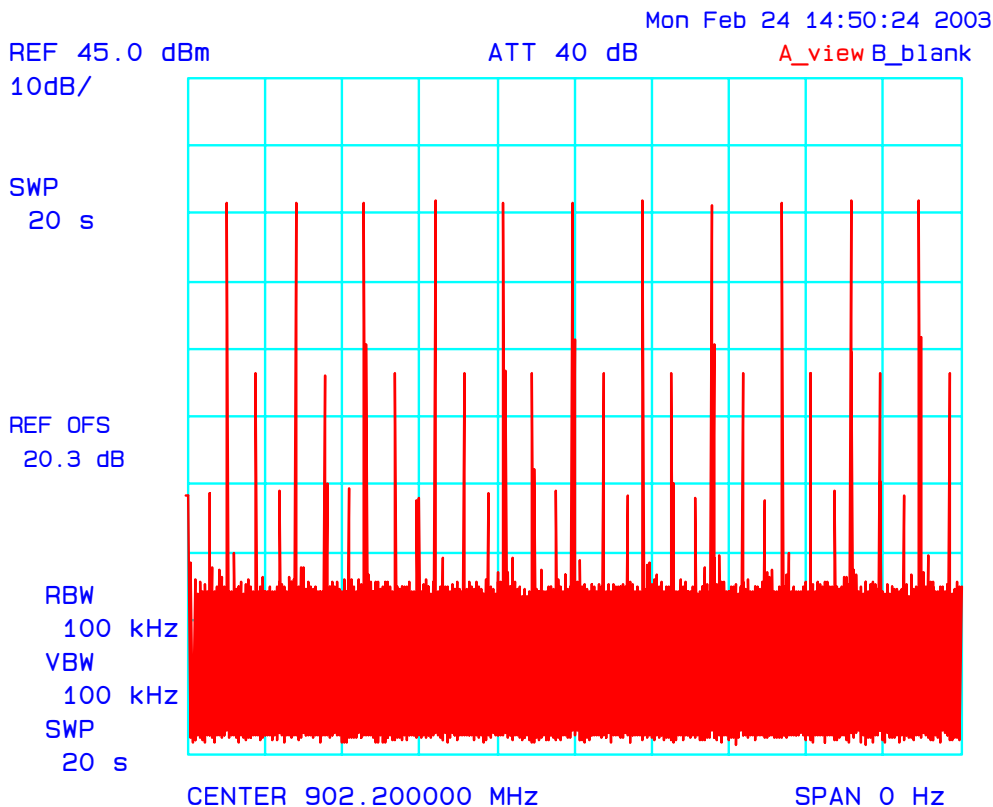

$$\begin{aligned} \text{Average time of occupancy in 20 s} &= (\text{Dwell Time @ 902.2 MHz}) \times (\text{number of hops in 20 s}) \\ &= 25.86 \text{ ms} \times 11 \\ &= 284.46 \text{ ms} \end{aligned}$$

Plot 10:
Average Time of Occupancy
28 ms Hop Dwell Setting
Channel: Mid, Tx. Frequency: 915 MHz, Modulation: 2 Level CPFSK

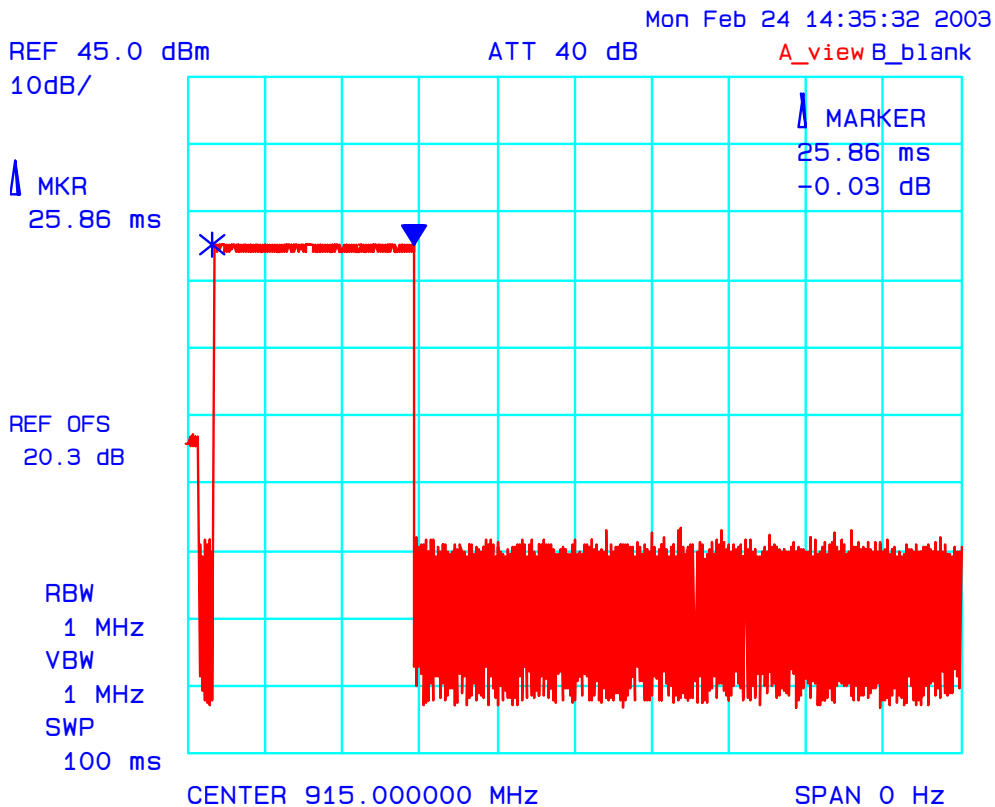

Dwell Time @ 915 MHz = 25.86 ms

Plot 11:
Average Time of Occupancy
28 ms Hop Dwell Setting
Channel: Mid, Tx. Frequency: 915 MHz, Modulation: 2 Level CPFSK

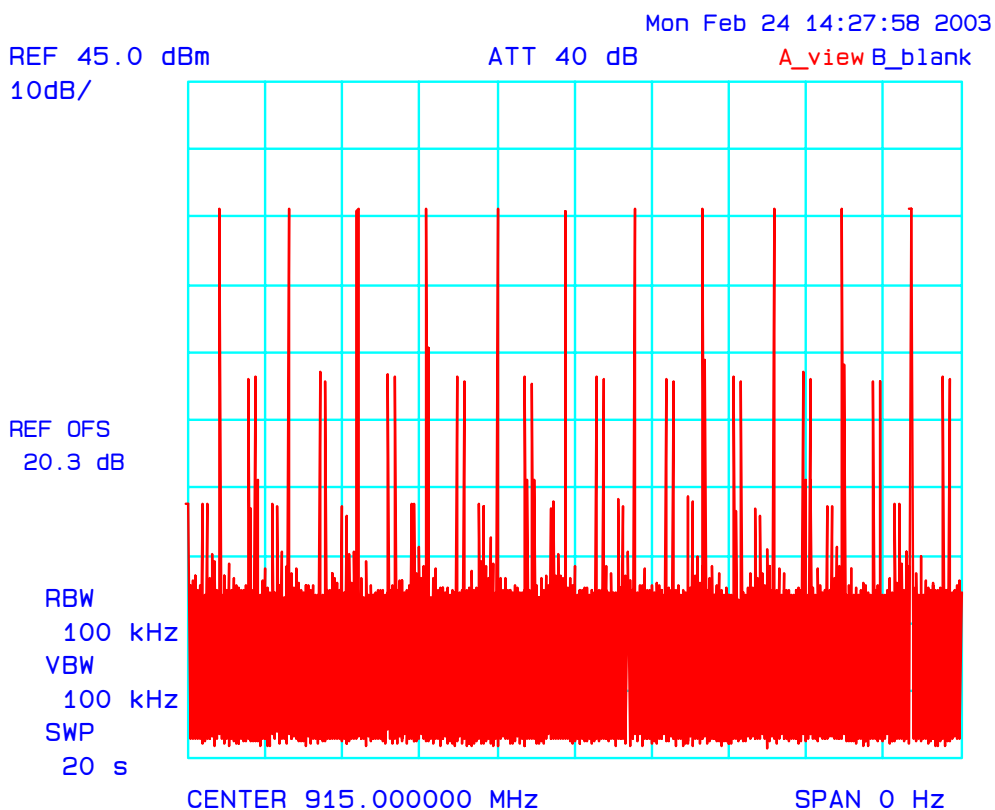

Average time of occupancy in 20 s = (Dwell Time @ 915 MHz) x (number of hops in 20 s)
= 25.86 ms x 11
= 284.46 ms

Plot 12:
Average Time of Occupancy
28 ms Hop Dwell Setting
Channel: High, Tx. Frequency: 927.6 MHz, Modulation: 2 Level CPFSK

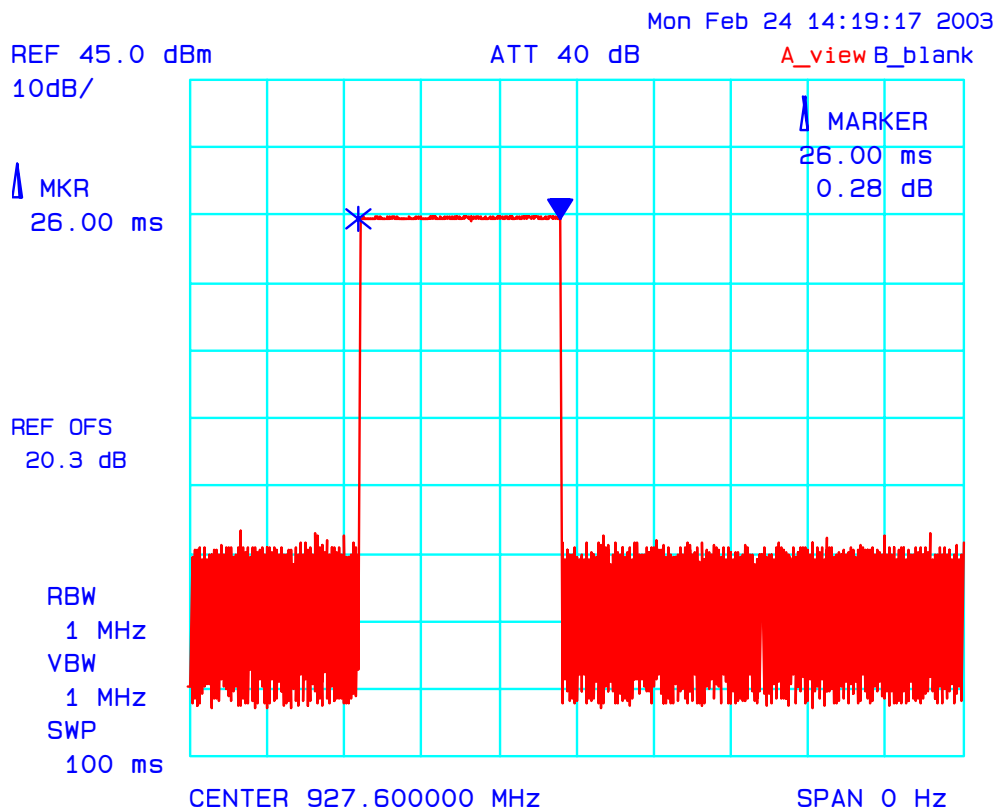

Dwell Time @ 927.6 MHz = 26.00 ms

Plot 13:
Average Time of Occupancy
28 ms Hop Dwell Setting
Channel: High, Tx. Frequency: 927.6 MHz, Modulation: 2 Level CPFSK

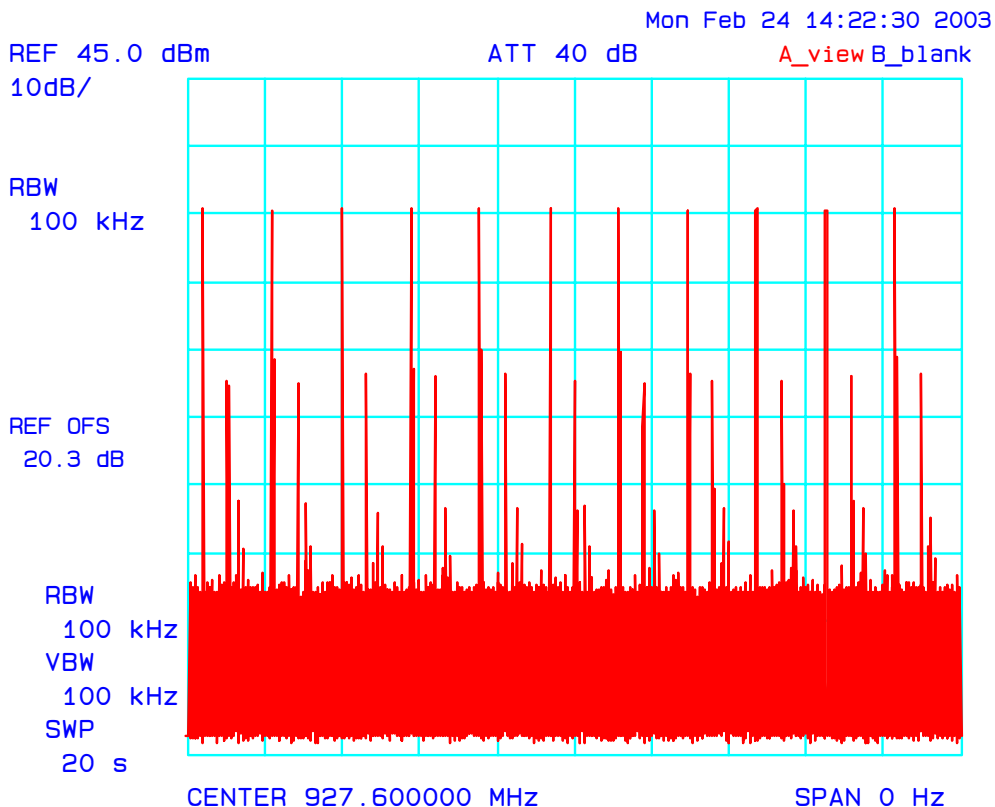

$$\begin{aligned} \text{Average time of occupancy in 20 s} &= (\text{Dwell Time @ 927.6 MHz}) \times (\text{number of hops in 20 s}) \\ &= 26.00 \text{ ms} \times 11 \\ &= 286 \text{ ms} \end{aligned}$$

Plot 14:
Average Time of Occupancy
7 ms Hop Dwell Setting
Channel: Low, Tx. Frequency: 902.2 MHz, Modulation: 2 Level CPFSK

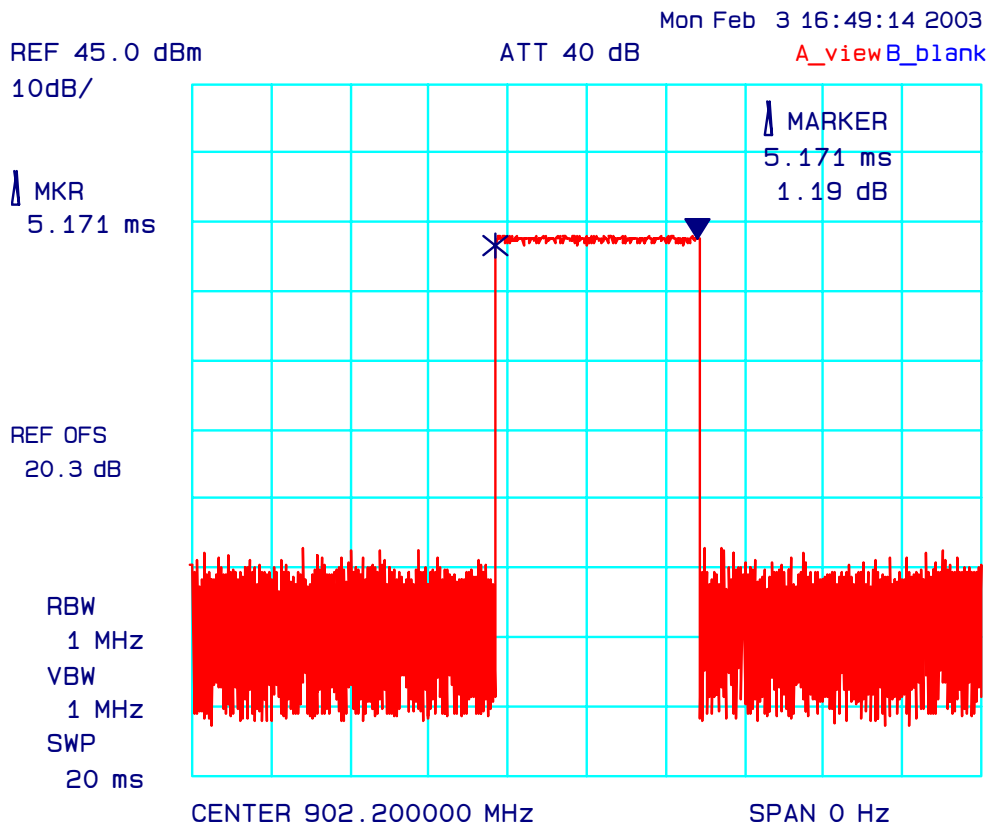

Dwell Time @ 902.2 MHz = 5.171 ms

Plot 15:
Average Time of Occupancy
7 ms Hop Dwell Setting
Channel: Low, Tx. Frequency: 902.2 MHz, Modulation: 2 Level CPFSK

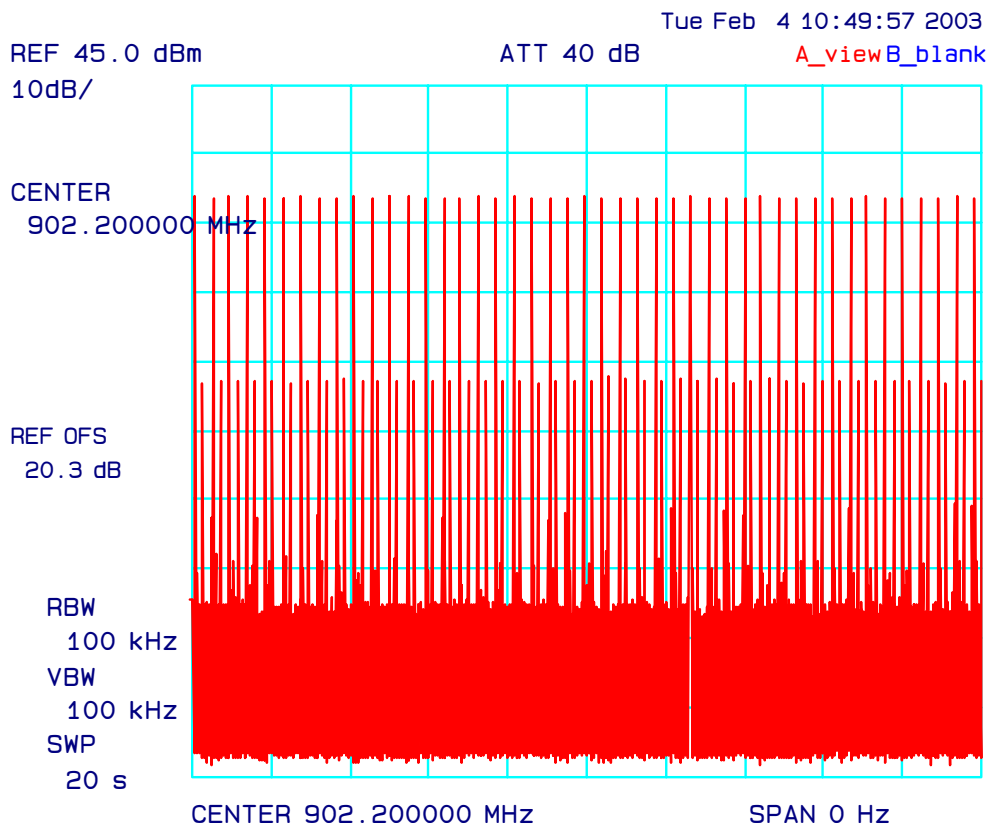

$$\begin{aligned} \text{Average time of occupancy in 20 s} &= (\text{Dwell Time @ 902.2 MHz}) \times (\text{number of hops in 20 s}) \\ &= 5.171 \text{ ms} \times 45 \\ &= 232.695 \text{ ms} \end{aligned}$$

Plot 16:
Average Time of Occupancy
7 ms Hop Dwell Setting
Channel: Mid, Tx. Frequency: 915MHz, Modulation: 2 Level CPFSK

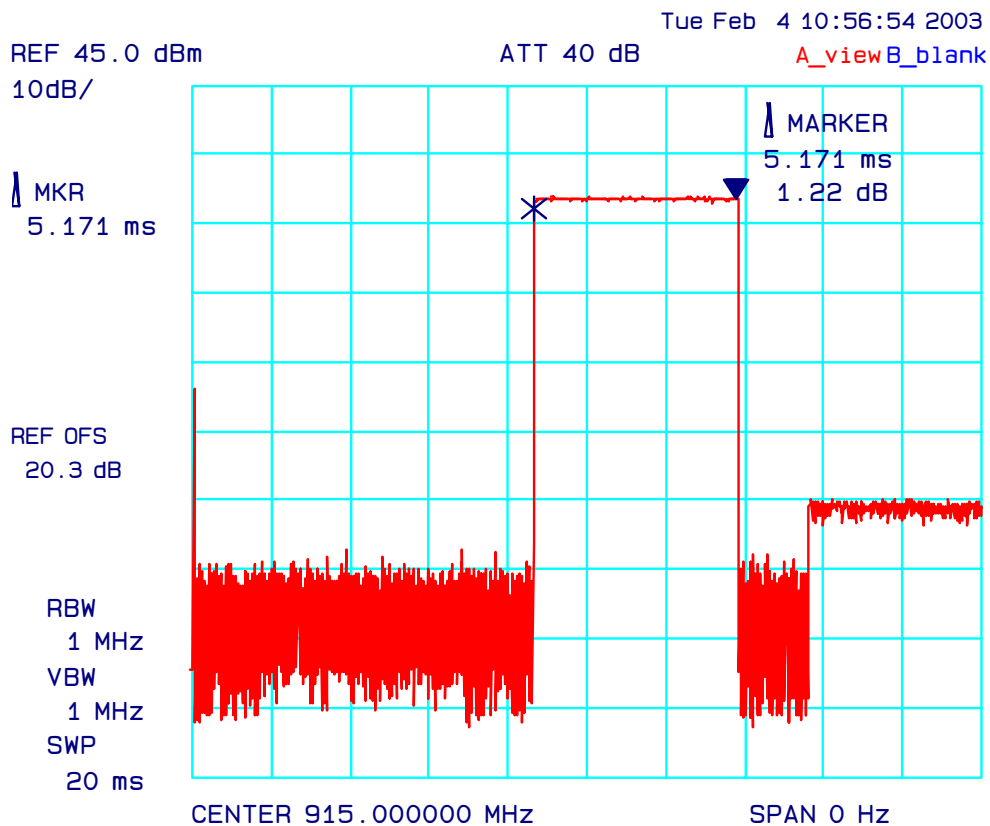

Dwell Time @ 915 MHz = 5.171 ms

Plot 17:
Average Time of Occupancy
7 ms Hop Dwell Setting
Channel: Mid, Tx. Frequency: 915 MHz, Modulation: 2 Level CPFSK

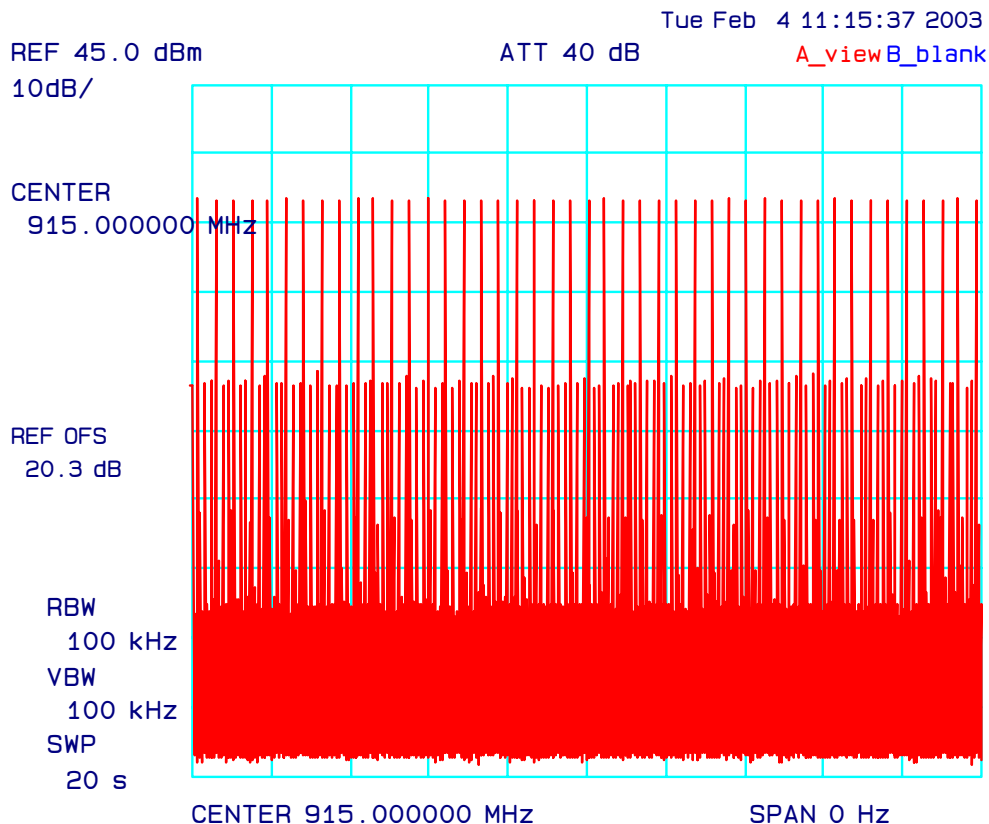

$$\begin{aligned} \text{Average time of occupancy in 20 s} &= (\text{Dwell Time @ 915 MHz}) \times (\text{number of hops in 20 s}) \\ &= 5.171 \text{ ms} \times 45 \\ &= 232.695 \text{ ms} \end{aligned}$$

Plot 18:
Average Time of Occupancy
7 ms Hop Dwell Setting
Channel: High, Tx. Frequency: 927.6Hz, Modulation: 2 Level CPFSK

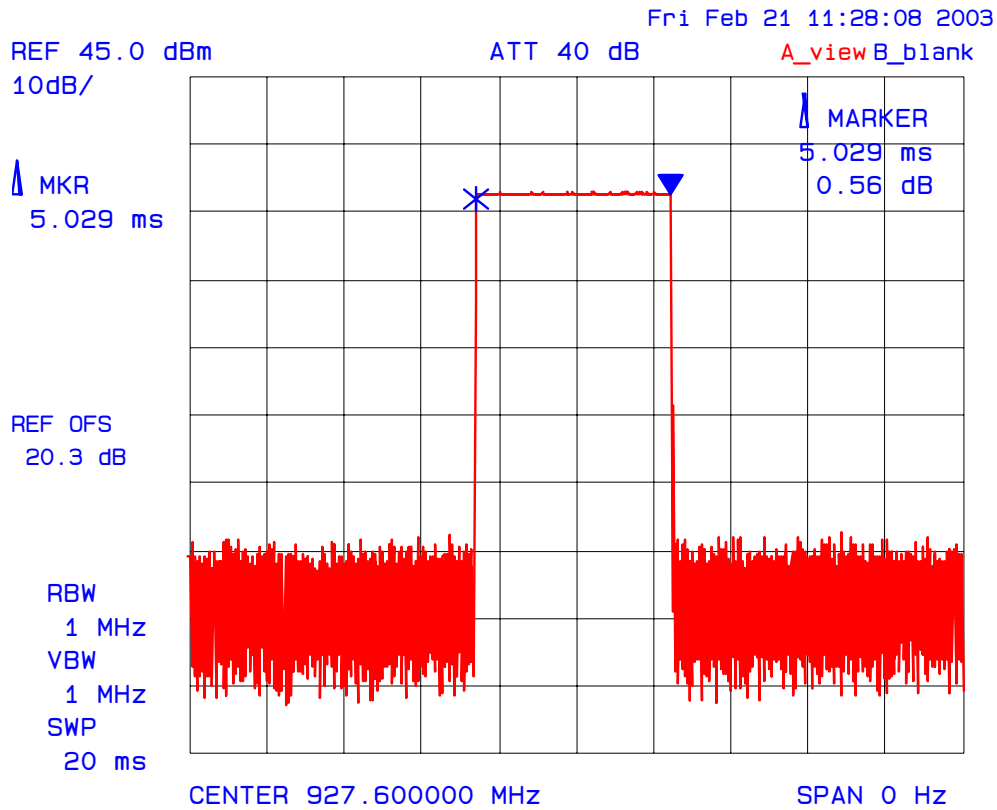

Dwell Time @ 927.6 MHz = 5.029 ms

Plot 19:
Average Time of Occupancy
7 ms Hop Dwell Setting
Channel: High, Tx. Frequency: 927.6 MHz, Modulation: 2 Level CPFSK

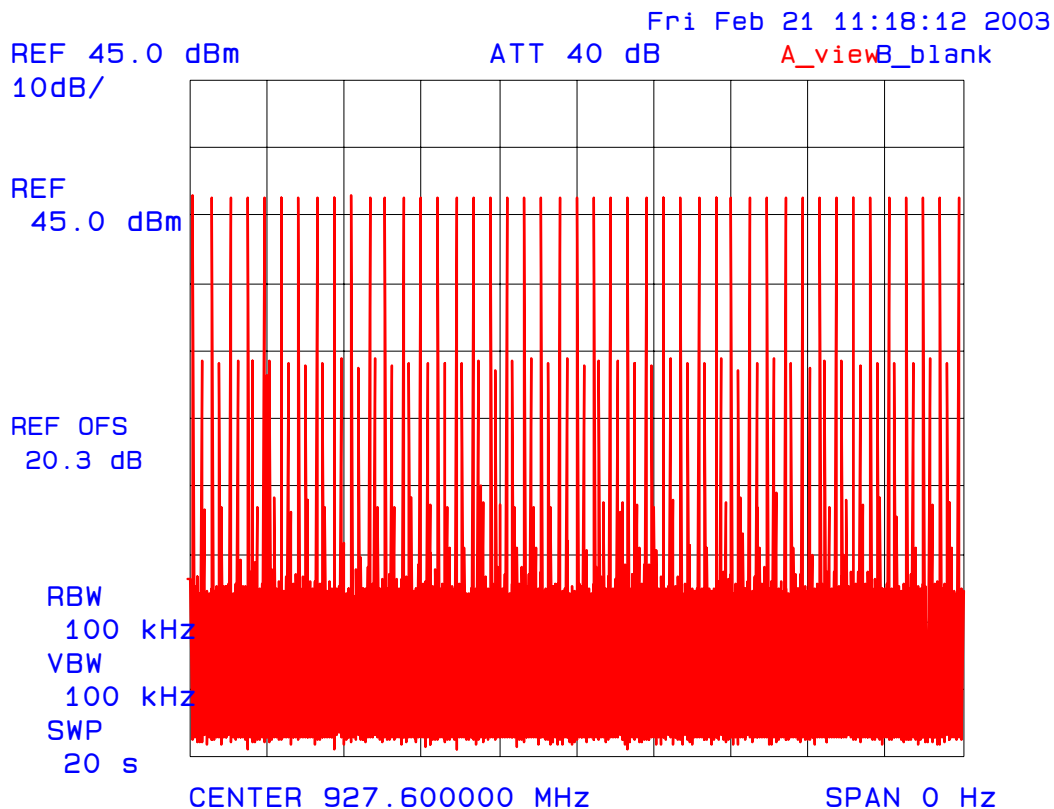

Average time of occupancy in 20 s = (Dwell Time @ 927.6 MHz) x (number of hops in 20 s)
= 5.029 ms x 45
= 226.305 ms

FCC Specification	Manufacturer's Explanation
FCC Requirement @ Section 15.247(a)(1): The system shall hop to channel frequencies that are selected at the system hopping rate from a pseudorandomly ordered list of hopping frequencies. Each frequency must be used equally on the average by each transmitter. The system receivers shall have input bandwidths that match the hopping channel bandwidths of their corresponding transmitters and shall shift frequencies in synchronization with the transmitted signals	Conform. Refer to section 6.5 of this report.
FCC Requirement @ Section 15.247(g): Describe how the EUT complies with the requirement that it be designed to be capable of operating as a true frequency hopping system	Conform. Refer to section 6.5 of this report.
FCC Requirement @ Section 15.247(h): Describe how the EUT complies with the requirement that it does not have the ability to coordinated with other FHSS is an effort to avoid the simultaneous occupancy of individual hopping frequencies by multiple transmitters	Conform. Refer to section 6.5 of this report.

6.8. PEAK OUTPUT POWER & EQUIVALENT ISOTROPIC RADIATED POWER (EIRP) [47 CFR § 15.247(b)]

6.8.1. Limits

- **47 CFR 15.247(b)(2):** 1 watt for systems employing at least 50 hopping channels; and, 0.25 watts for systems employing less than 50 hopping channels, but at least 25 hopping channels
- **47 CFR 15.247(b)(3):** If the antennas of directional gain greater than 6 dBi are used, the peak power from the intentional radiator shall be reduced below, as appropriate, by the amount in dB that the directional gain of the antenna exceeds 6 dBi.

6.8.2. Method of Measurements

FCC 47 CFR 15.247(b)(2)&(3), and ANSI C63-4:1992

6.8.3. Test Arrangement

Conducted Output Power at Antenna Terminals

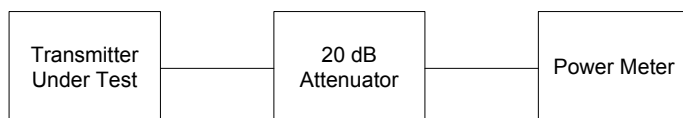

6.8.4. Test Equipment List

Test Instruments	Manufacturer	Model No.	Serial No.	Frequency Range
Power Meter	Hewlett Packard	436A	1725A02249	10 kHz – 50 GHz, sensor dependent
Power Sensor	Hewlett Packard	8481A	2702A68983	10 MHz – 18 GHz
Attenuator	Weinschel Corp	24-20-34	BJ2357	DC – 8.5 GHz

6.8.5. Test Data

6.8.5.1. Conducted RF Output Power & EIRP wrt. Omni Directional Base Station Antenna (7.1 dBi Gain)

Transmitter Channel	Frequency (MHz)	Peak Power at Antenna Terminal (dBm)	Minimum Antenna Cable Loss (dBm)	*Calculated EIRP (dBm)	FCC Conducted Power Limit (dBm)	FCC EIRP Limit (dBm)
Lowest	902.2	30.0	1.1	36.0	30.0	36.0
Middle	915.0	30.0	1.1	36.0	30.0	36.0
Highest	927.6	30.0	1.1	36.0	30.0	36.0

* EIRP = (Peak power at antenna terminal) + (EUT antenna again in dBi) - (Minimum antenna cable loss)

6.8.5.2. Conducted RF Output Power & EIRP wrt. Yagi Directional Antenna (8.5 dBi Gain)

Transmitter Channel	Frequency (MHz)	Peak Power at Antenna Terminal (dBm)	Minimum Antenna Cable Loss (dBm)	*Calculated EIRP (dBm)	FCC Conducted Power Limit (dBm)	FCC EIRP Limit (dBm)
Lowest	902.2	30.0	2.5	36.0	30.0	36.0
Middle	915.0	30.0	2.5	36.0	30.0	36.0
Highest	927.6	30.0	2.5	36.0	30.0	36.0

* EIRP = (Peak power at antenna terminal) + (EUT antenna again in dBi) - (Minimum antenna cable loss)

6.9. RF EXPOSURE REQUIRMENTS [47 CFR §§ 15.247(b)(4), 1.1310 & 2.1091]

6.9.1. Limits

- **FCC 15.247(b)(4):** Systems operating under provisions of this section shall be operated in a manner that ensures that the public is not exposed to radio frequency energy levels in excess of the Commission’s guidelines. See @ 1.1307(b)(1).
- **FCC 1.1310:-** The criteria listed in the following table shall be used to evaluate the environmental impact of human exposure to radio-frequency (RF) radiation as specified in 1.1307(b).

TABLE 1—LIMITS FOR MAXIMUM PERMISSIBLE EXPOSURE (MPE)

Frequency range (MHz)	Electric field strength (V/m)	Magnetic field strength (A/m)	Power density (mW/cm ²)	Averaging time (minutes)
(A) Limits for Occupational/Controlled Exposures				
0.3–3.0	614	1.63	*(100)	6
3.0–30	1842/f	4.89/f	*(900/f ²)	6
30–300	61.4	0.163	1.0	6
300–1500	f/300	6
1500–100,000	5	6
(B) Limits for General Population/Uncontrolled Exposure				
0.3–1.34	614	1.63	*(100)	30
1.34–30	824/f	2.19/f	*(180/f ²)	30
30–300	27.5	0.073	0.2	30
300–1500	f/1500	30
1500–100,000	1.0	30

f = frequency in MHz

* = Plane-wave equivalent power density

NOTE 1 TO TABLE 1: Occupational/controlled limits apply in situations in which persons are exposed as a consequence of their employment provided those persons are fully aware of the potential for exposure and can exercise control over their exposure. Limits for occupational/controlled exposure also apply in situations when an individual is transient through a location where occupational/controlled limits apply provided he or she is made aware of the potential for exposure.

NOTE 2 TO TABLE 1: General population/uncontrolled exposures apply in situations in which the general public may be exposed, or in which persons that are exposed as a consequence of their employment may not be fully aware of the potential for exposure or can not exercise control over their exposure.

6.9.2. Method of Measurements

Refer to FCC @ 1.1310, 2.1091 and Public Notice DA 00-705 (March 30, 2000)

- Spread spectrum transmitters operating under section 15.247 are categorically from routine environmental evaluation to demonstrating RF exposure compliance with respect to MPE and/or SAR limits. These devices are not exempted from compliance (As indicated in Section 15.247(b)(4), these transmitters are required to operate in a manner that ensures that exposure to public users and nearby persons) does not exceed the Commission’s RF exposure guidelines (see Section 1.1307 and 2.1093). Unless a device operates at substantially low power levels, with a low gain antenna(s), supporting information is generally needed to establish the various potential operating configurations and exposure conditions of a transmitter and its antenna(s) in order to determine compliance with the RF exposure guidelines.
- In order to demonstrate compliance with MPE requirements (see Section 2.1091), the following information is typically needed:
 - (1) Calculation that estimates the minimum separation distance (20 cm or more) between an antenna and persons required to satisfy power density limits defined for free space.
 - (2) Antenna installation and device operating instructions for installers (professional/unskilled users), and the parties responsible for ensuring compliance with the RF exposure requirement
 - (3) Any caution statements and/or warning labels that are necessary in order to comply with the exposure limits
 - (4) Any other RF exposure related issues that may affect MPE compliance

Calculation Method of RF Safety Distance:

$$S = PG/4\pi r^2 = EIRP/4\pi r^2$$

Where: P: power input to the antenna in mW
EIRP: Equivalent (effective) isotropic radiated power
S: power density mW/cm²
G: numeric gain of antenna relative to isotropic radiator
r: distance to centre of radiation in cm

$$r = \sqrt{EIRP/4\pi S}$$

- For portable transmitters (see Section 2.1093), or devices designed to operate next to a person's body, compliance is determined with respect to the SAR limit (define in the body tissues) for near-field exposure conditions. If the maximum average output power, operating condition configurations and exposure conditions are comparable to those of existing cellular and PCS phones., an SAR evaluation may be required in order to determine if such a device complies with SAR limit. When SAR evaluation data is not available, and the additional supporting information cannot assure compliance, the Commission may request that an SAR evaluation be performed, as provided for in Section 1.1307(d)

6.9.3. Test Data

The minimum separation distance between the antenna and bodies of users are calculated using the following formula:

$$\text{RF EXPOSURE DISTANCE LIMITS: } r = (PG/4\pi S)^{1/2} = (EIRP/4\pi S)^{1/2}$$

$$S = 902/1500 \text{ mW/cm}^2$$

$$EIRP = 36 \text{ dBm} = 3981 \text{ mW max. (Worst Case)}$$

$$r = (EIRP/4\pi S)^{1/2} = (3981/4\pi(902/1500))^{1/2} = 23 \text{ cm}$$

Therefore, the minimum separation distance from users is 23 cm when used with the antenna specified in this test report.

Evaluation of RF Exposure Compliance Requirements	
RF Exposure Requirements	Compliance with FCC Rules
Minimum calculated separation distance between antenna and persons required: 23 cm	Manufacturer' instruction for separation distance between antenna and persons required: 23 cm.
Antenna installation and device operating instructions for installers (professional/unskilled users), and the parties responsible for ensuring compliance with the RF exposure requirement	Antenna installation and device operating instructions shall be provided to installers to maintain and ensure compliance with RF exposure requirements.
Caution statements and/or warning labels that are necessary in order to comply with the exposure limits	Please refer to User's Manual for RF Exposure Information.
Any other RF exposure related issues that may affect MPE compliance	None.

6.10. TRANSMITTER BAND-EDGE & SPURIOUS CONDUCTED EMISSIONS [47 CFR § 15.247(c)]

6.10.1. Limits

In any 100 KHz bandwidth outside the operating frequency band, the radio frequency power that is produced by modulation products of the spreading sequence, the information sequence and the carrier frequency shall be at least 20 dB below that in any 100 KHz bandwidth within the band that contains the highest level of the desired power.

6.10.2. Method of Measurements

Refer to Exhibit 8, Section 8.4 of this test report, 47 CFR § 15.247(c) and ANSI C63-4:1992

6.10.3. Test Arrangement

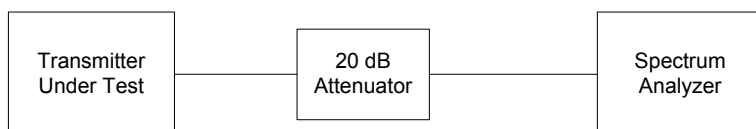

6.10.4. Test Equipment List

Test Instruments	Manufacturer	Model No.	Serial No.	Frequency Range
Spectrum Analyzer/ EMI Receiver	Advantest	R3271	15050203	100 Hz – 26.5 GHz
Attenuator	Weinschel Corp	24-20-34	BJ2357	DC – 8.5 GHz

6.10.5. Test Data

6.10.5.1. Band-Edge RF Conducted Emissions

Refer to the following test data plots 20 to 23 for measurement results:

Plot 20:
Band-Edge RF Conducted Emissions
Low End of Frequency Band
Single Frequency Mode

hp

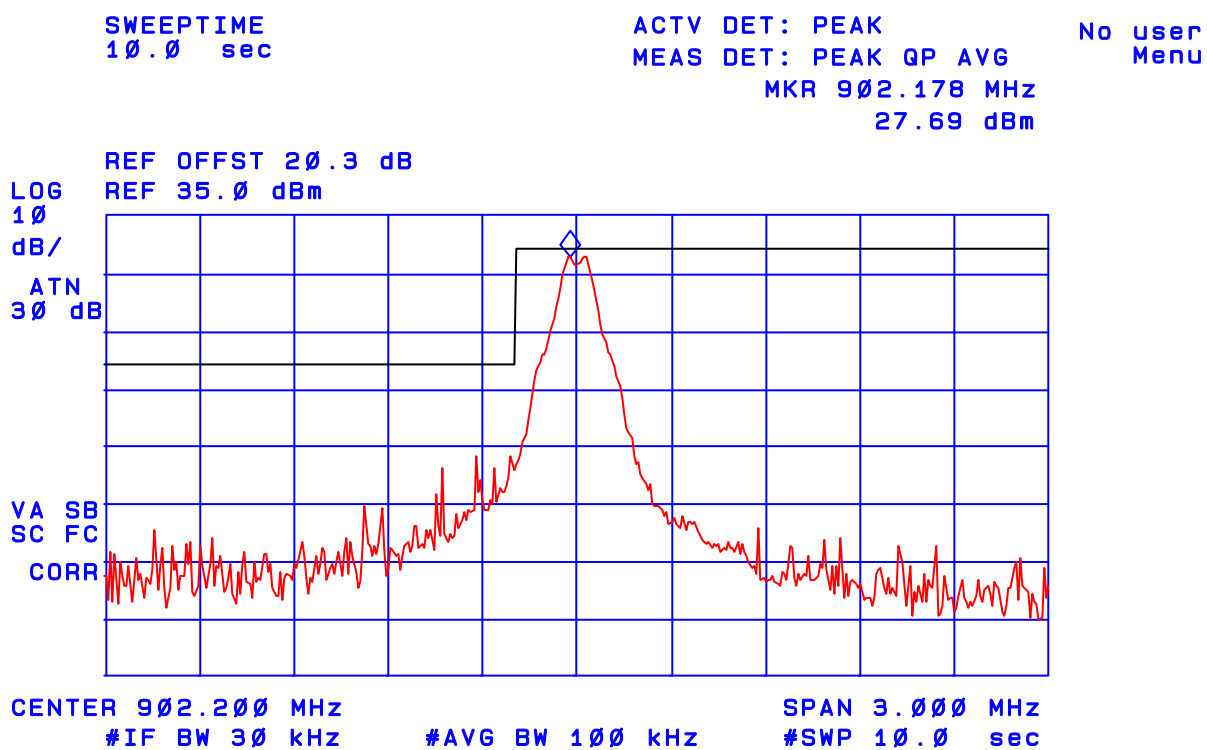

Plot 21:
Band-Edge RF Conducted Emissions
Low End of Frequency Band
Pseudorandom Channel Hopping Mode

hp

MARKER
902.170 MHz
29.34 dBm

ACTV DET: PEAK
MEAS DET: PEAK QP AVG
MKR 902.170 MHz
29.34 dBm

No user
Menu

REF OFFST 20.3 dB
LOG 10
dB/
ATN 30 dB
MA SB
SC FC
CORR

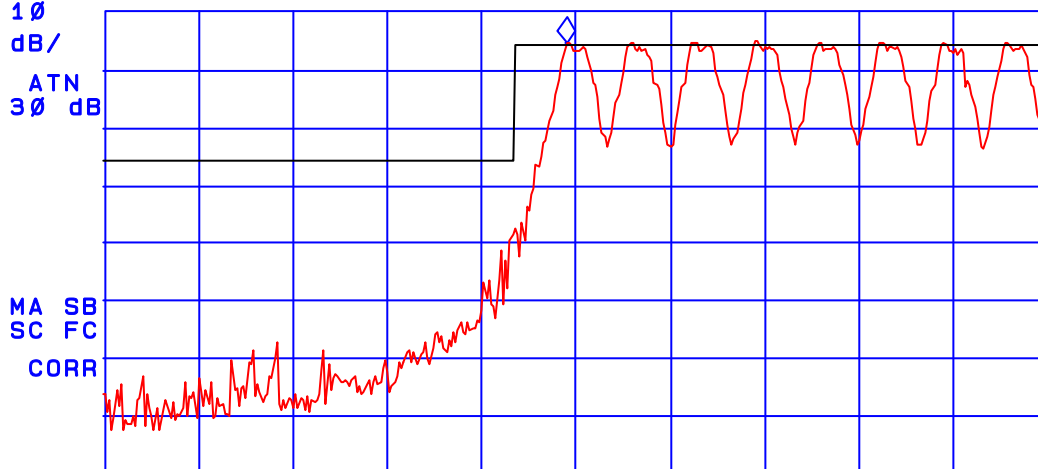

CENTER 902.200 MHz SPAN 3.000 MHz
#IF BW 30 kHz #AVG BW 100 kHz SWP 20.0 msec

Plot 22:
Band-Edge RF Conducted Emissions
High End of Frequency Band
Single Frequency Mode

hp

MARKER
927.623 MHz
28.32 dBm

ACTV DET: PEAK
MEAS DET: PEAK QP AVG
MKR 927.623 MHz
28.32 dBm

No user
Menu

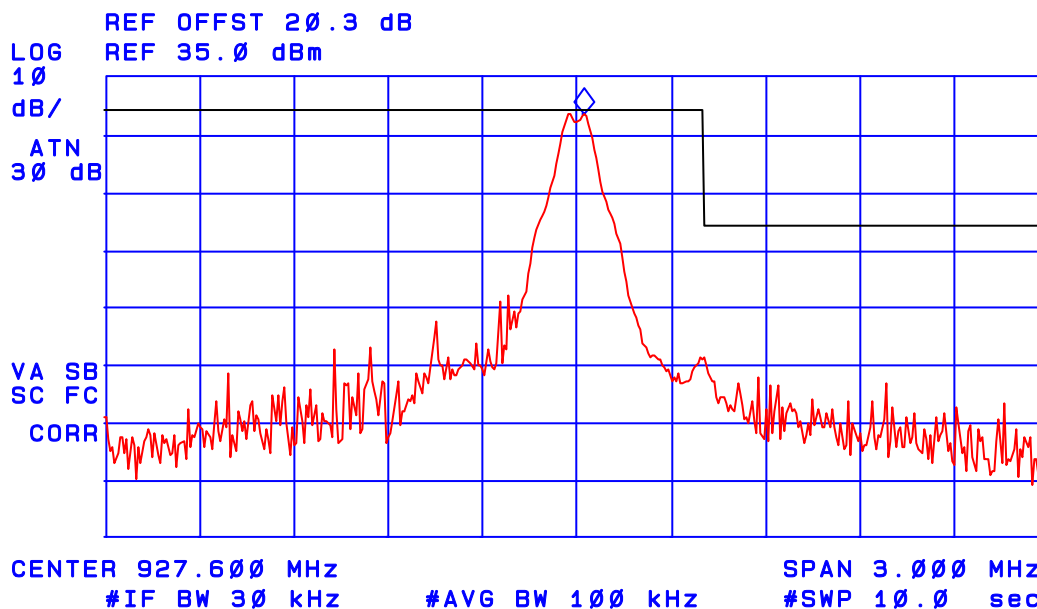

Plot 23:
Band-Edge RF Conducted Emissions
High End of Frequency Band
Pseudorandom Channel Hopping Mode

hp

ACTV DET: PEAK
MEAS DET: PEAK QP AVG
MKR 927.623 MHz
28.32 dBm
No user Menu

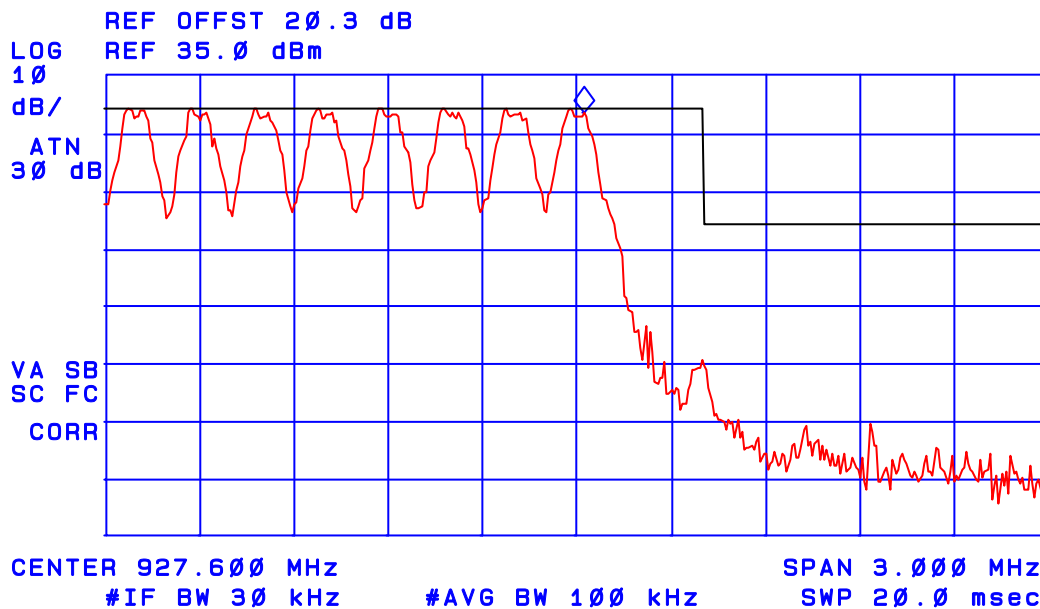

6.10.5.2. Spurious RF Conducted Emissions

6.10.5.2.1. Lowest Frequency (902.2 MHz)

The emissions were scanned from 10 MHz to 10 GHz; refer to the following test data plots 24 to 26 for measurement results.

Plot 24:
Spurious RF Conducted Emissions
Channel: Low, Tx. Frequency: 902.2 MHz, Modulation: 2 Level CPFSK

hp

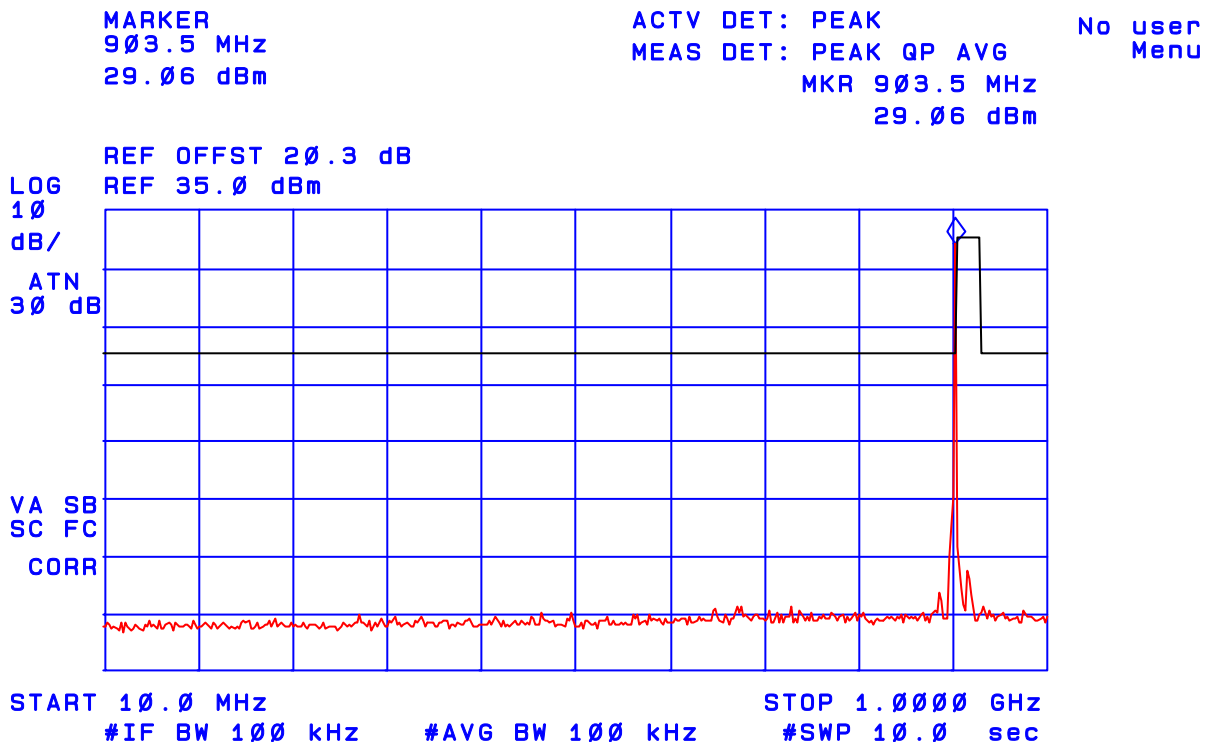

Plot 25:
Spurious RF Conducted Emissions
Channel: Low, Tx. Frequency: 902.2 MHz, Modulation: 2 Level CPFSK

hp

REF LEVEL
5.0 dBm

ACTV DET: PEAK
MEAS DET: PEAK QP AVG
MKR 1.808 GHz
-35.69 dBm

No user
Menu

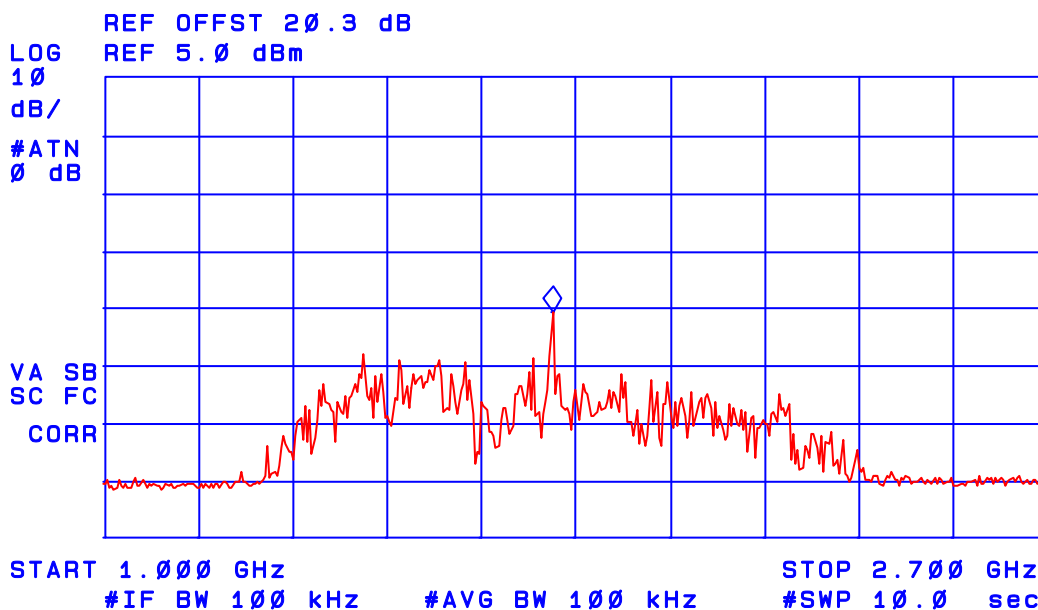

Plot 26:
Spurious RF Conducted Emissions
Channel: Low, Tx. Frequency: 902.2 MHz, Modulation: 2 Level CPFSK

hp

MARKER
6.314 GHz
-33.22 dBm

ACTV DET: PEAK
MEAS DET: PEAK QP AVG
MKR 6.314 GHz
-33.22 dBm

No user
Menu

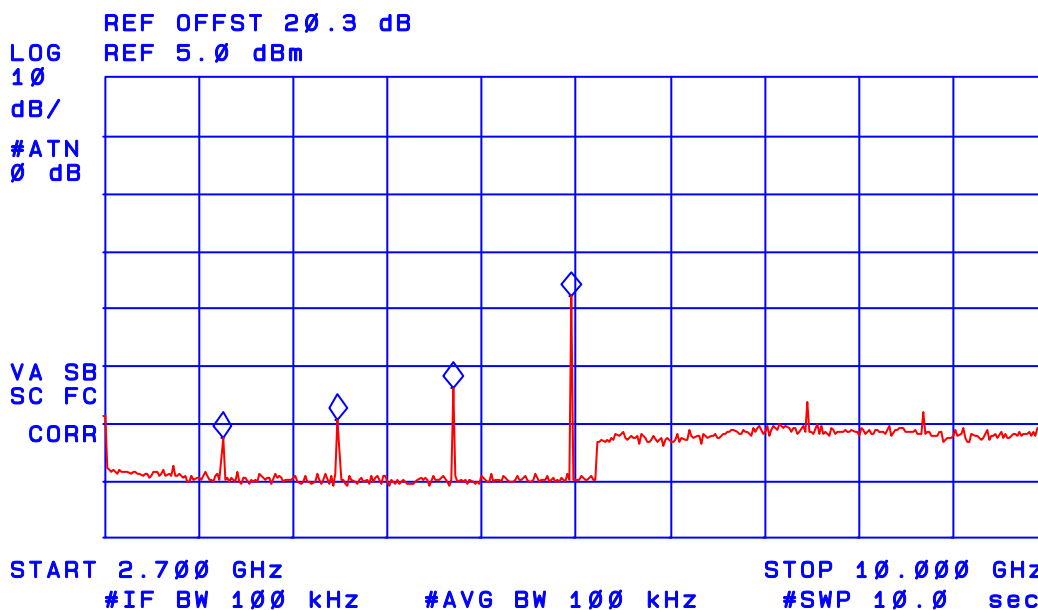

6.10.5.2.2. Middle Frequency (915.0 MHz)

The emissions were scanned from 10 MHz to 10 GHz; refer to the following test data plots 27 to 29 for measurement results.

Plot 27:
Spurious RF Conducted Emissions
Channel: Mid, Tx. Frequency: 915 MHz, Modulation: 2 Level CPFSK

hp

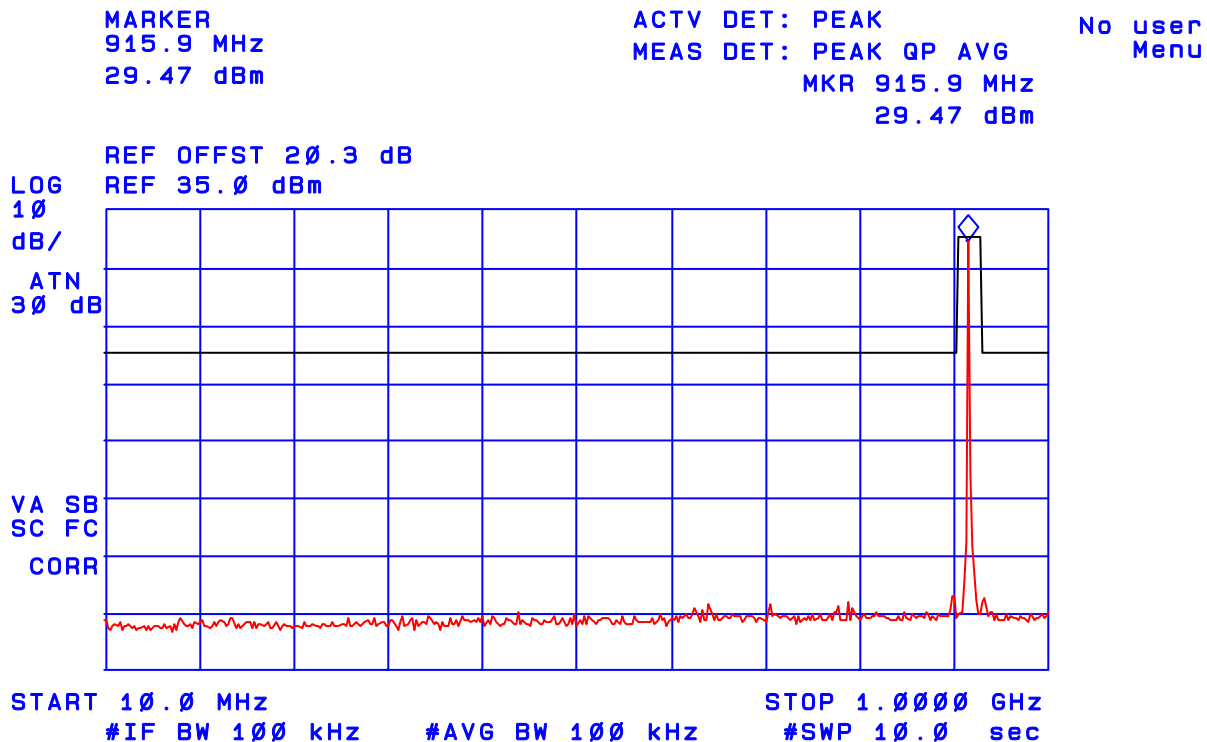

Plot 28:
Spurious RF Conducted Emissions
Channel: Mid, Tx. Frequency: 915 MHz, Modulation: 2 Level CPFSK

hp

MARKER
1.833 GHz
-37.13 dBm

ACTV DET: PEAK
MEAS DET: PEAK QP AVG
MKR 1.833 GHz
-37.13 dBm

No user
Menu

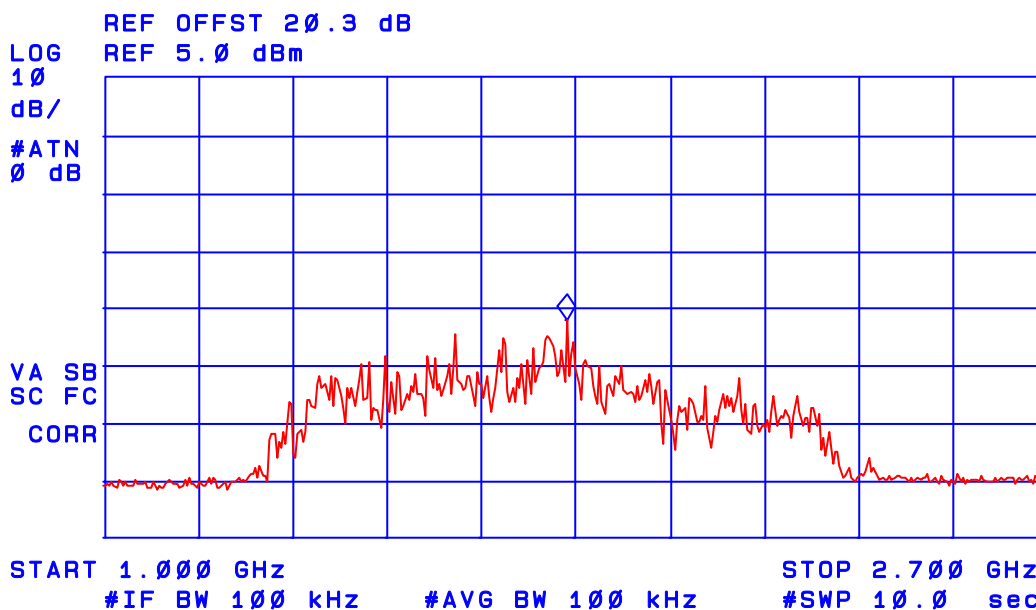

Plot 29:
Spurious RF Conducted Emissions
Channel: Mid, Tx. Frequency: 915 MHz, Modulation: 2 Level CPFSK

hp

MARKER
6.405 GHz
-35.48 dBm

ACTV DET: PEAK
MEAS DET: PEAK QP AVG
MKR 6.405 GHz
-35.48 dBm

No user
Menu

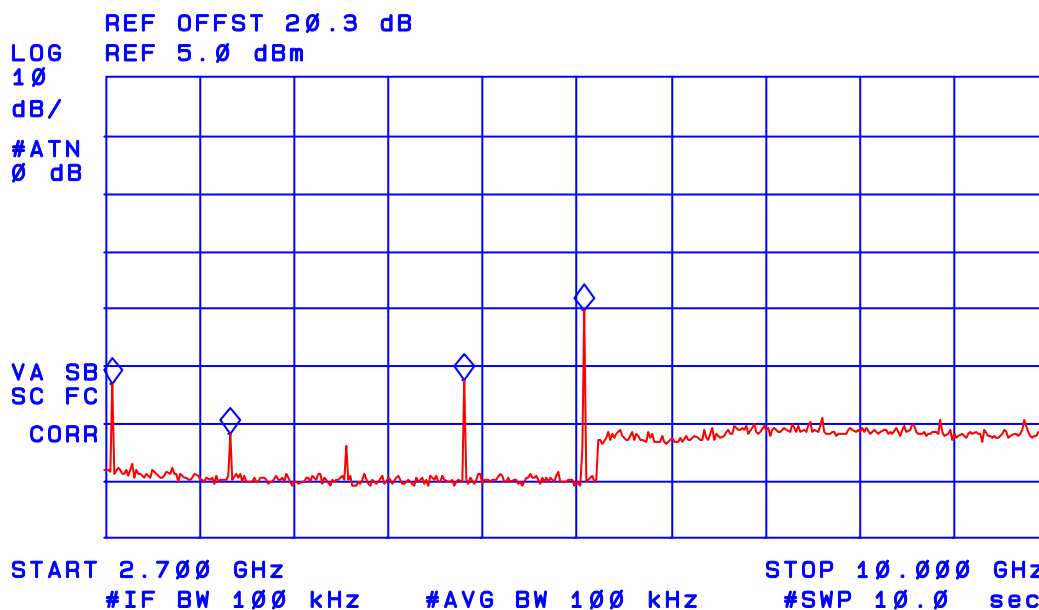

6.10.5.2.3. Highest Frequency (927.6 MHz)

The emissions were scanned from 10 MHz to 10 GHz; refer to the following test data plots 30 to 32 for measurement results.

Plot 30:
Spurious RF Conducted Emissions
Channel: High, Tx. Frequency: 927.6 MHz, Modulation: 2 Level CPFSK

hp

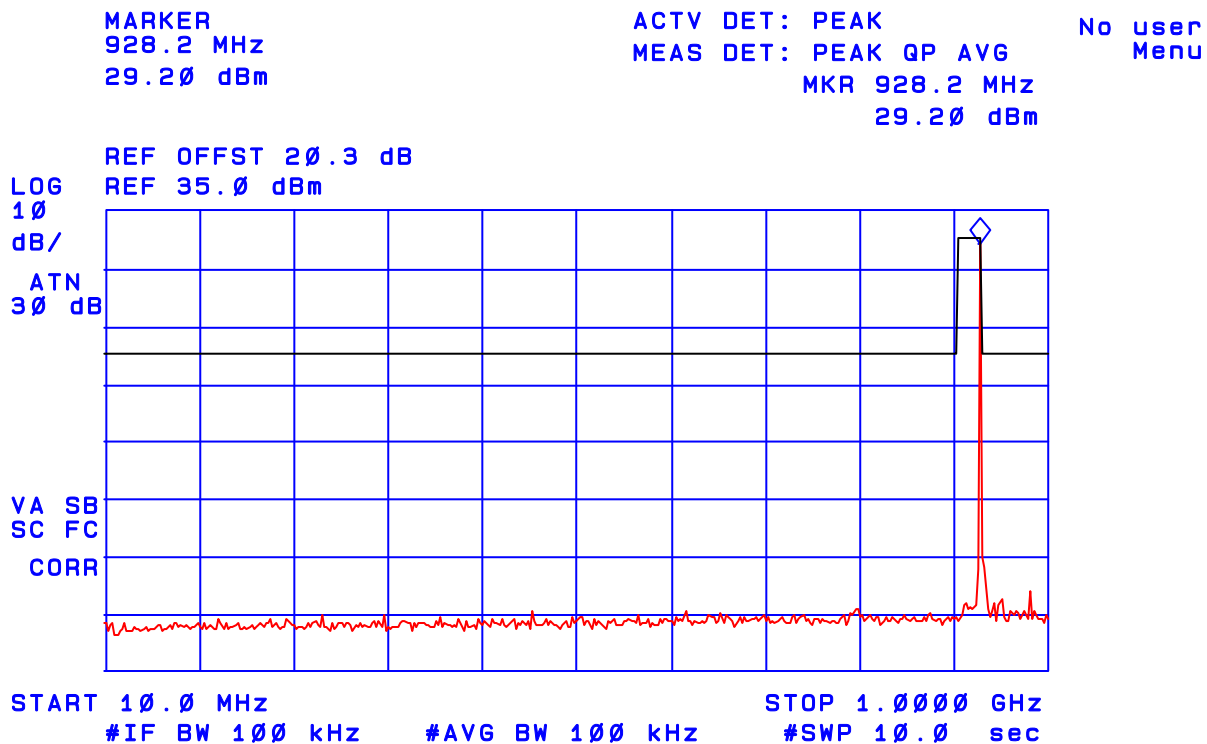

Plot 31:
Spurious RF Conducted Emissions
Channel: High, Tx. Frequency: 927.6 MHz, Modulation: 2 Level CPFSK

hp

MARKER
1.859 GHz
-38.81 dBm

ACTV DET: PEAK
MEAS DET: PEAK QP AVG
MKR 1.859 GHz
-38.81 dBm

No user
Menu

REF OFFST 20.3 dB
REF 5.0 dBm

LOG 10
dB/
#ATN 0 dB

VA SB
SC FC
CORR

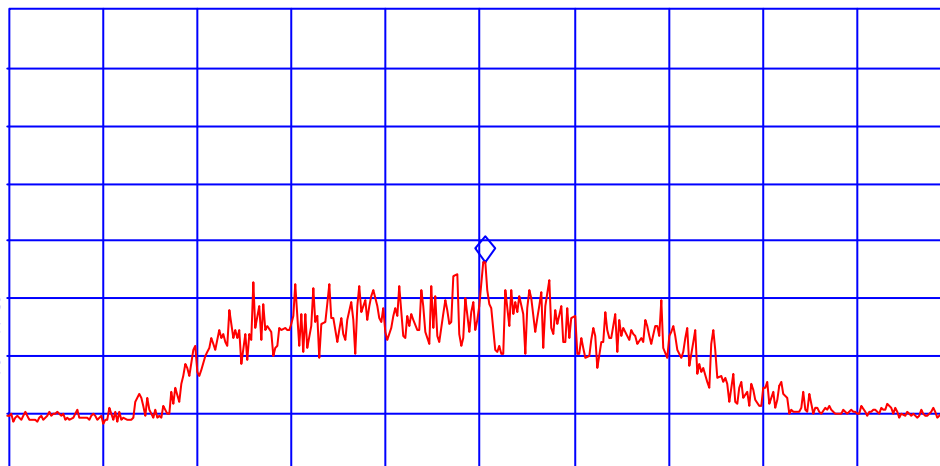

START 1.000 GHz STOP 2.700 GHz
#IF BW 100 kHz #AVG BW 100 kHz #SWP 10.0 sec

Plot 32:
Spurious RF Conducted Emissions
Channel: High, Tx. Frequency: 927.6 MHz, Modulation: 2 Level CPFSK

hp

MARKER
6.478 GHz
-33.20 dBm

ACTV DET: PEAK
MEAS DET: PEAK QP AVG
MKR 6.478 GHz
-33.20 dBm

No user
Menu

REF OFFST 20.3 dB
LOG 10
dB/
#ATN 0 dB

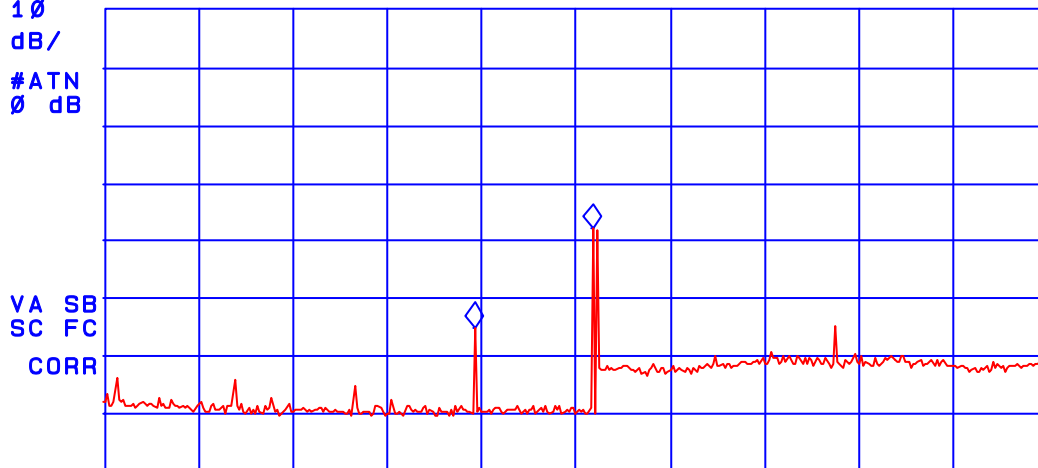

START 2.700 GHz #IF BW 100 kHz #AVG BW 100 kHz #SWP 10.0 sec
STOP 10.000 GHz

6.11. TRANSMITTER SPURIOUS RADIATED EMISSIONS AT 3 METERS [47 CFR §§ 15.247(c), 15.209 & 15.205]

6.11.1. Limits

In any 100 KHz bandwidth outside the operating frequency band, the radio frequency power that is produced by modulation products of the spreading sequence, the information sequence and the carrier frequency shall be either at least 20 dB below that in any 100 KHz bandwidth within the band that contains the highest level of the desired power or shall not exceed the general levels specified in section 15.209(a), which lesser attenuation.

All other emissions inside restricted bands specified in section 15.205(a) shall not exceed the general radiated emission limits specified in section 15.209(a)

Remarks:

- Applies to harmonics/spurious emissions that fall in the restricted bands listed in section 15.205. The maximum permitted average field strength is listed in section 15.209.
- **47 CFR § 15.237(c):** The emission limits as specified above are based on measurement instrument employing an average detector. The provisions in section 15.35 for limiting peak emissions apply.

FCC CFR 47, Part 15, Subpart C, Para. 15.205(a) - Restricted Frequency Bands

MHz	MHz	MHz	GHz
0.090-0.110	16.42-16.423	399.9-410	4.5-5.15
¹ 0.495-0.505	16.69475-16.69525	608-614	5.35-5.46
2.1735-2.1905	16.80425-16.80475	960-1240	7.25-7.75
4.125-4.128	25.5-25.67	1300-1427	8.025-8.5
4.17725-4.17775	37.5-38.25	1435-1626.5	9.0-9.2
4.20725-4.20775	73-74.6	1645.5-1646.5	9.3-9.5
6.215-6.218	74.8-75.2	1660-1710	10.6-12.7
6.26775-6.26825	108-121.94	1718.8-1722.2	13.25-13.4
6.31175-6.31225	123-138	2200-2300	14.47-14.5
8.291-8.294	149.9-150.05	2310-2390	15.35-16.2
8.362-8.366	156.52475-156.52525	2483.5-2500	17.7-21.4
8.37625-8.38675	156.7-156.9	2655-2900	22.01-23.12
8.41425-8.41475	162.0125-167.17	3260-3267	23.6-24.0
12.29-12.293	167.72-173.2	3332-3339	31.2-31.8
12.51975-12.52025	240-285	3345.8-3358	36.43-36.5
12.57675-12.57725	322-335.4	3600-4400	(²)
13.36-13.41.			

¹ Until February 1, 1999, this restricted band shall be 0.490-0.510 MHz.

² Above 38.6

47 CFR § 15.209(a)

-- Field Strength Limits within Restricted Frequency Bands --

Frequency (MHz)	Field Strength (microvolts/meter)	Measurement Distance (meters)
0.009 - 0.490	2,400 / F (kHz)	300
0.490 - 1.705	24,000 / F (kHz)	30
1.705 - 30.0	30	30
30 - 88	100	3
88 - 216	150	3
216 - 960	200	3
Above 960	500	3

6.11.2. Method of Measurements

Refer to Exhibit 8, Section 8.4 of this test report and ANSI 63.4-1992, Para. 8 for detailed radiated emissions measurement procedures.

The following measurement procedures were also applied:

- Applies to harmonics/spurious that fall in the restricted bands listed in Section 15.205. the maximum permitted average field strength is listed in Section 15.209. A Pre-Amp and highpass filter are used for this measurement.
- For measurement below 1 GHz, set RBW = 100 KHz, VBW \geq 100 KHz, SWEEP=AUTO.
- For measurement above 1 GHz, set RBW = 1 MHz, VBW = 1 MHz (Peak) & VBW = 10 Hz (Average), SWEEP=AUTO.
- If the emission is pulsed, modified the unit for continuous operation, then use the settings above for measurements, then correct the reading by subtracting the peak-average correction factor derived from the appropriate duty cycle calculation. See Section 15.35(b) and (c).

6.11.3. Test Arrangement

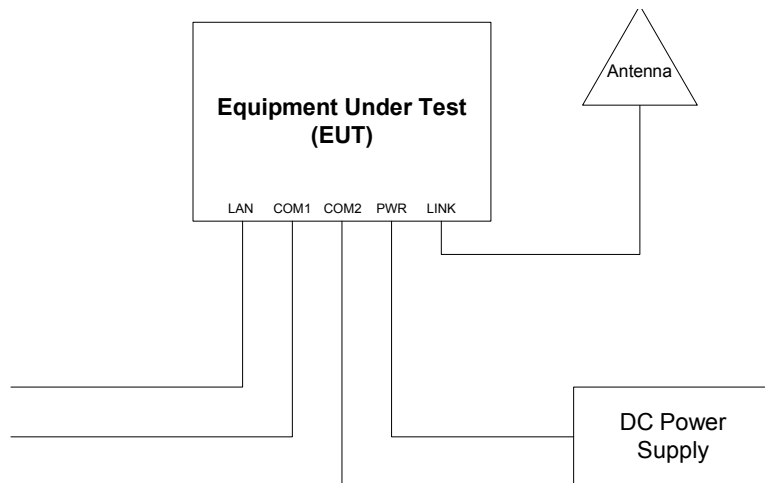

6.11.4. Test Equipment List

Test Instruments	Manufacturer	Model No.	Serial No.	Frequency Range
Spectrum Analyzer/ EMI Receiver	Advantest	R3271	15050203	100 Hz – 26.5 GHz
Microwave Amplifier	Hewlett Packard	8449B	3008A00769	1 GHz to 26.5 GHz
Biconilog Antenna	EMCO	3143	1029	20 MHz to 2 GHz
Horn Antenna	EMCO	3155	9701-5061	1 GHz – 18 GHz

6.11.5. Test Data

The following test results are the worst-case measurements:

6.11.5.1. EUT With MDS ClearWave Omni-directional Base Station Antenna

Lowest Frequency (902.2 MHz)

Frequency (MHz)	RF Peak Level (dB μ V/m)	RF Avg Level (dB μ V/m)	Antenna Plane (H/V)	Limit 15.209 (dB μ V/m)	Limit 15.247 (dB μ V/m)	Margin (dB)	Pass/Fail
902.2	131.86	--	V	--	--	--	--
902.2	131.86	--	H	--	--	--	--
2706.6	43.79	36.71	H	54.0	111.9	-17.3	Pass*
3608.8	46.04	37.66	V	54.0	111.9	-16.3	Pass*
3608.8	46.51	36.21	H	54.0	111.9	-17.8	Pass*
4511.0	46.39	37.99	V	54.0	111.9	-16.0	Pass*
8119.8	51.32	42.96	V	54.0	111.9	-11.0	Pass*
8119.8	53.89	43.19	H	54.0	111.9	-10.8	Pass*

The emissions were scanned from 10 MHz to 10 GHz and all emissions within 20 dB below the limits were recorded. See test data plots 33 & 34 for band-edge emissions.

* Frequency in restricted bands, therefore FCC 15.209 limit applied.

Plot 33:
Radiated Emissions @ 3 Meters
EUT with MDS ClearWave Omni-directional Base Station Antenna
Channel: Low, Tx. Frequency: 902.2 MHz, Modulation: 2 Level CPFSK
Vertical Polarization

hp

ACTV DET: PEAK
MEAS DET: PEAK QP AVG
MKR 902.180 MHz
131.86 dB μ V
No user Menu

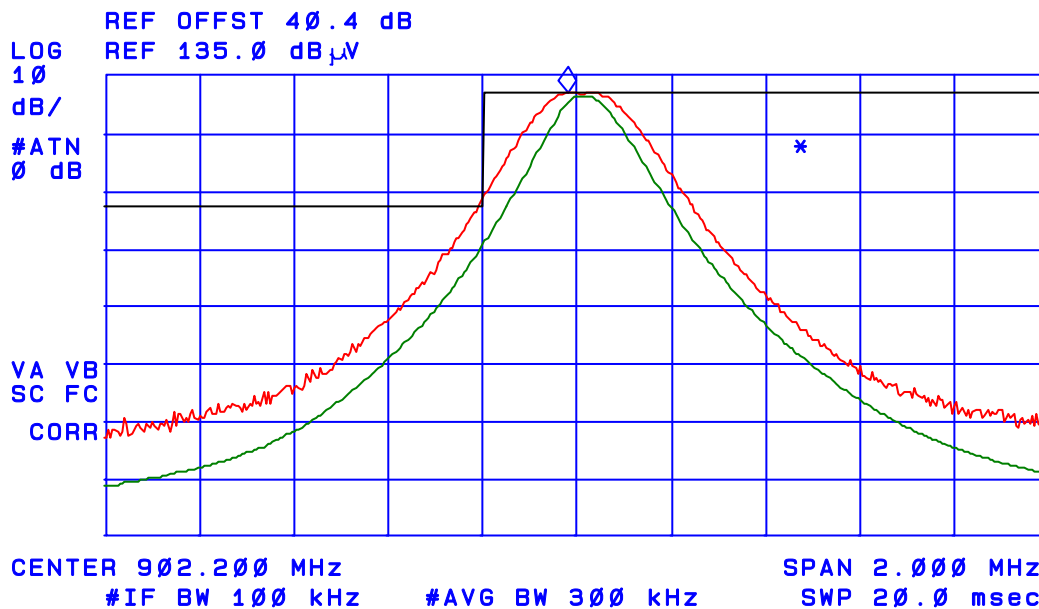

Trace A: Peak, RBW=100 kHz, VBW=300 kHz
Trace B: Average, RBW=100 kHz, VBW=10 Hz

Plot 34:
Radiated Emissions @ 3 Meters
EUT with MDS ClearWave Omni-directional Base Station Antenna
Channel: Low, Tx. Frequency: 902.2 MHz, Modulation: 2 Level CPFSK
Horizontal Polarization

hp

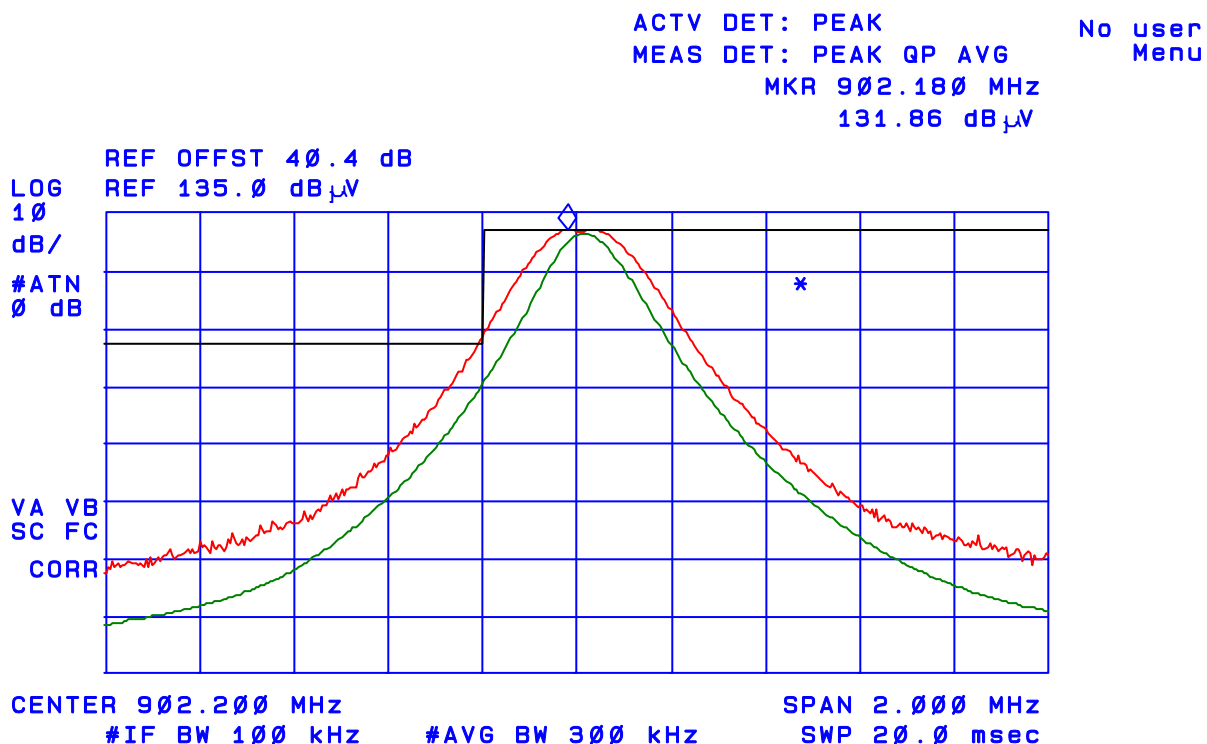

Trace A: Peak, RBW=100 kHz, VBW=300 kHz
Trace B: Average, RBW=100 kHz, VBW=10 Hz

Middle Frequency (915.0 MHz)

Frequency (MHz)	RF Peak Level (dB μ V/m)	RF Avg Level (dB μ V/m)	Antenna Plane (H/V)	Limit 15.209 (dB μ V/m)	Limit 15.247 (dB μ V/m)	Margin (dB)	Pass/Fail
915.00	132.69	--	V	--	--	--	--
915.00	130.85	--	H	--	--	--	--
2745.00	44.38	36.38	H	54.0	112.7	-17.6	Pass*
3660.00	47.24	41.03	V	54.0	112.7	-13.0	Pass*
3660.00	45.76	36.74	H	54.0	112.7	-17.3	Pass*
4575.00	46.79	37.67	V	54.0	112.7	-16.3	Pass*
7320.00	52.70	42.48	V	54.0	112.7	-11.5	Pass*
7320.00	53.97	44.96	H	54.0	112.7	-9.0	Pass*

The emissions were scanned from 10 MHz to 10 GHz and all emissions within 20 dB below the limits were recorded.

* Frequency in restricted bands, therefore FCC 15.209 limit applied.

Highest Frequency (927.6 MHz)

Frequency (MHz)	RF Peak Level (dB μ V/m)	RF Avg Level (dB μ V/m)	Antenna Plane (H/V)	Limit 15.209 (dB μ V/m)	Limit 15.247 (dB μ V/m)	Margin (dB)	Pass/Fail
927.60	126.43	--	V	--	--	--	--
927.60	128.16	--	H	--	--	--	--
2782.80	43.11	34.67	V	54.0	108.2	-19.3	Pass*
2782.80	43.16	34.72	H	54.0	108.2	-19.3	Pass*
3710.40	46.42	38.71	V	54.0	108.2	-15.3	Pass*
3710.40	44.52	36.12	H	54.0	108.2	-17.9	Pass*

The emissions were scanned from 10 MHz to 10 GHz and all emissions within 20 dB below the limits were recorded. See test data plots 35 & 36 for band-edge emissions.

* Frequency in restricted bands, therefore FCC 15.209 limit applied.

Plot 35:
Radiated Emissions @ 3 Meters
EUT with MDS ClearWave Omni-directional Base Station Antenna
Channel: High, Tx. Frequency: 927.6 MHz, Modulation: 2 Level CPFSK
Vertical Polarization

hp

ACTV DET: PEAK
MEAS DET: PEAK QP AVG
MKR 927.630 MHz
126.43 dB μ V
No user Menu

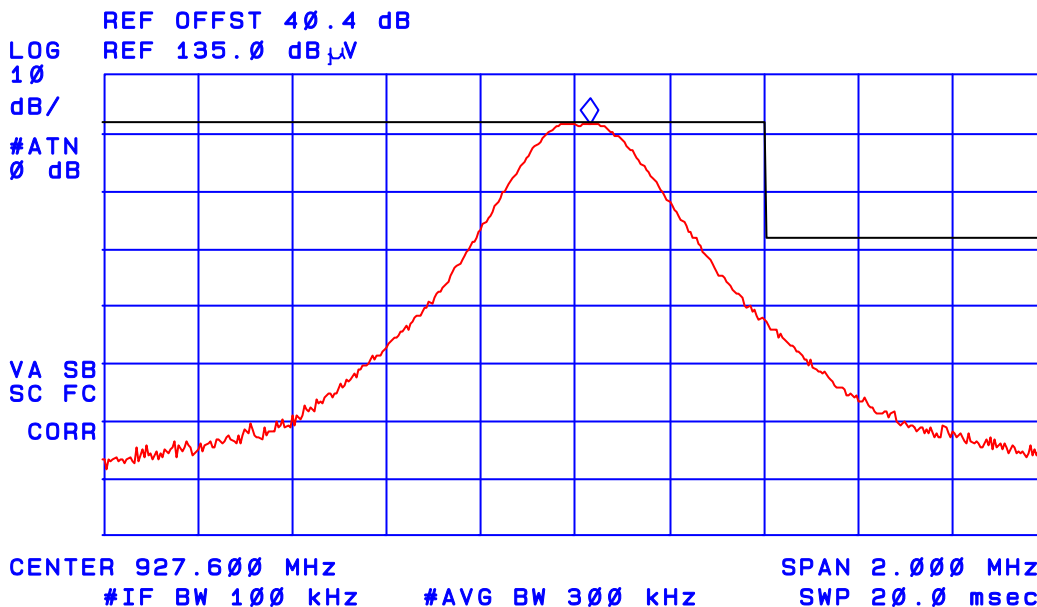

Plot 36:
Radiated Emissions @ 3 Meters
EUT with MDS ClearWave Omni-directional Base Station Antenna
Channel: High, Tx. Frequency: 927.6 MHz, Modulation: 2 Level CPFSK
Horizontal Polarization

hp

ACTV DET: PEAK
MEAS DET: PEAK QP AVG
MKR 927.630 MHz
128.16 dB μ V
No user Menu

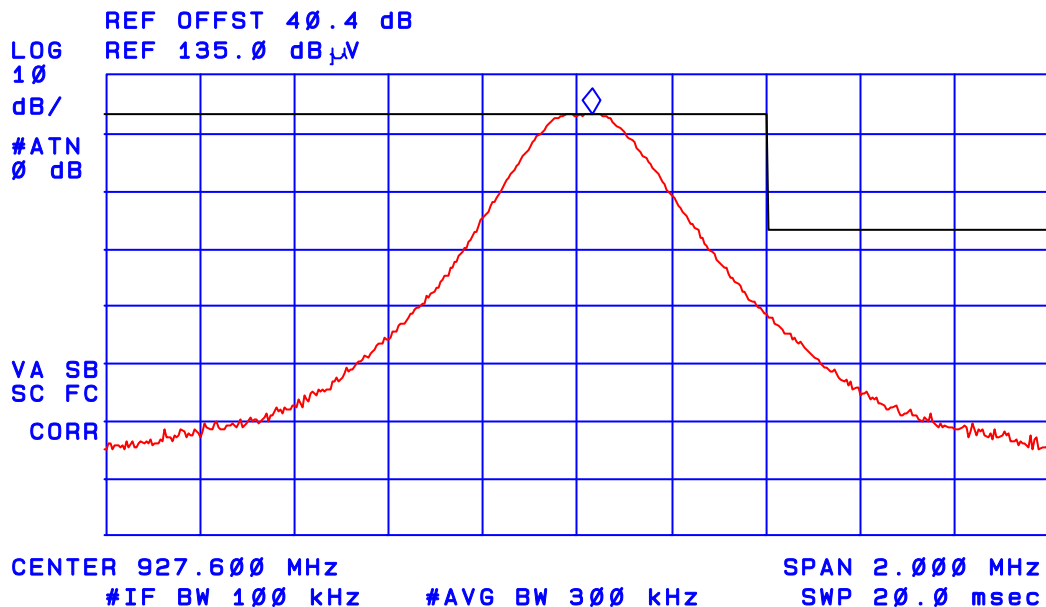

6.11.5.2. EUT With MDS ClearWave Yagi Directional Antenna

Lowest Frequency (902.2 MHz)

Frequency (MHz)	RF Peak Level (dBμV/m)	RF Avg Level (dBμV/m)	Antenna Plane (H/V)	Limit 15.209 (dBμV/m)	Limit 15.247 (dBμV/m)	Margin (dB)	Pass/Fail
902.2	129.30	--	V	--	--	--	--
902.2	131.53	--	H	--	--	--	--
2706.6	43.23	34.03	H	54.0	111.5	-20.0	Pass*
4511.0	48.84	44.39	V	54.0	111.5	-9.6	Pass*
4511.0	47.28	40.61	H	54.0	111.5	-13.4	Pass*

The emissions were scanned from 10 MHz to 10 GHz and all emissions within 20 dB below the limits were recorded. See test data plots 37 & 38 for band-edge emissions.

* Frequency in restricted bands, therefore FCC 15.209 limit applied.

Plot 37:
Radiated Emissions @ 3 Meters
EUT with MDS ClearWave Yagi Directional Antenna
Channel: Low, Tx. Frequency: 902.2 MHz, Modulation: 2 Level CPFSK
Vertical Polarization

hp

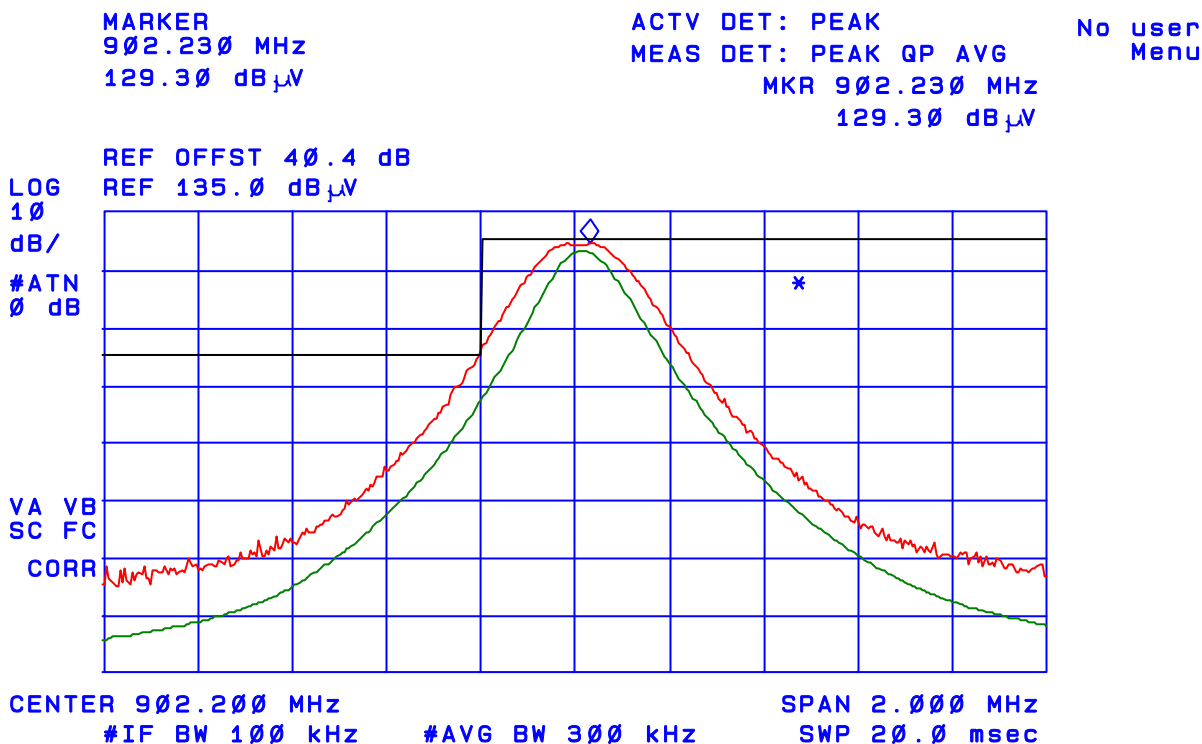

Trace A: Peak, RBW=100 kHz, VBW=300 kHz
Trace B: Average, RBW=100 kHz, VBW=10 Hz

Plot 38:
Radiated Emissions @ 3 Meters
EUT with MDS ClearWave Yagi Directional Antenna
Channel: Low, Tx. Frequency: 902.2 MHz, Modulation: 2 Level CPFSK
Horizontal Polarization

hp

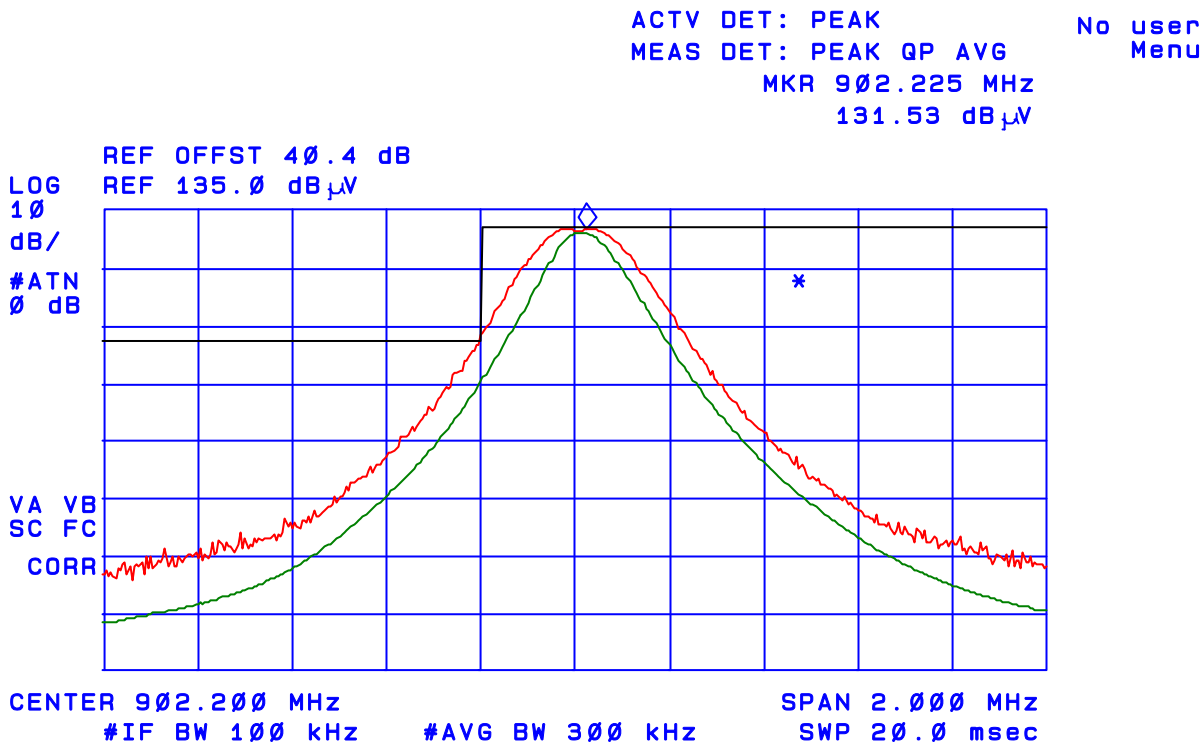

Trace A: Peak, RBW=100 kHz, VBW=300 kHz
Trace B: Average, RBW=100 kHz, VBW=10 Hz

Middle Frequency (915.0 MHz)

Frequency (MHz)	RF Peak Level (dBµV/m)	RF Avg Level (dBµV/m)	Antenna Plane (H/V)	Limit 15.209 (dBµV/m)	Limit 15.247 (dBµV/m)	Margin (dB)	Pass/Fail
915.00	126.70	--	V	--	--	--	--
915.00	130.09	--	H	--	--	--	--
3660.00	45.57	35.48	V	54.0	110.1	-18.5	Pass*
4575.00	48.24	42.44	V	54.0	110.1	-11.6	Pass*
4575.00	47.12	36.14	H	54.0	110.1	-17.9	Pass*

The emissions were scanned from 10 MHz to 10 GHz and all emissions within 20 dB below the limits were recorded.

* Frequency in restricted bands, therefore FCC 15.209 limit applied.

Highest Frequency (927.6 MHz)

Frequency (MHz)	RF Peak Level (dBµV/m)	RF Avg Level (dBµV/m)	Antenna Plane (H/V)	Limit 15.209 (dBµV/m)	Limit 15.247 (dBµV/m)	Margin (dB)	Pass/Fail
927.60	127.76	--	V	--	--	--	--
927.60	129.76	--	H	--	--	--	--
2782.80	42.49	34.46	H	54.0	109.8	-19.5	Pass*
3710.40	47.13	39.54	V	54.0	109.8	-14.5	Pass*
3710.40	47.15	39.15	H	54.0	109.8	-14.9	Pass*
4638.00	47.61	38.11	V	54.0	109.8	-15.9	Pass*

The emissions were scanned from 10 MHz to 10 GHz and all emissions within 20 dB below the limits were recorded. See test data plots 39 & 40 for band-edge emissions.

* Frequency in restricted bands, therefore FCC 15.209 limit applied.

Plot 39:
Radiated Emissions @ 3 Meters
EUT with MDS ClearWave Yagi Directional Antenna
Channel: High, Tx. Frequency: 927.6 MHz, Modulation: 2 Level CPFSK
Vertical Polarization

hp

ACTV DET: PEAK
MEAS DET: PEAK QP AVG
MKR 927.630 MHz
127.76 dB μ V
No user Menu

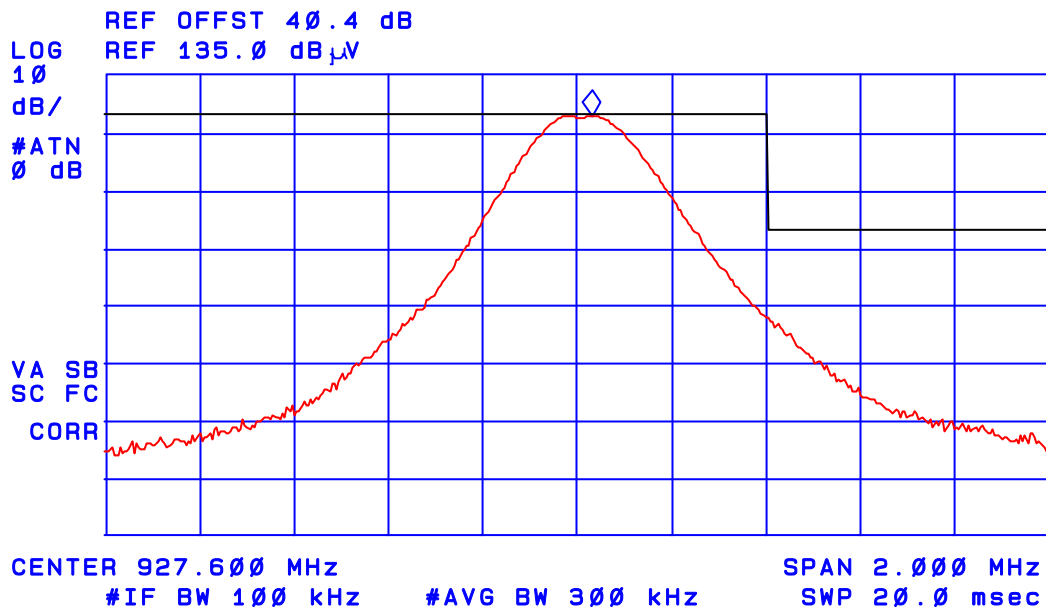

Plot 40:
Radiated Emissions @ 3 Meters
EUT with MDS ClearWave Yagi Directional Antenna
Channel: High, Tx. Frequency: 927.6 MHz, Modulation: 2 Level CPFSK
Horizontal Polarization

hp

ACTV DET: PEAK
MEAS DET: PEAK QP AVG
MKR 927.630 MHz
129.76 dB μ V
No user Menu

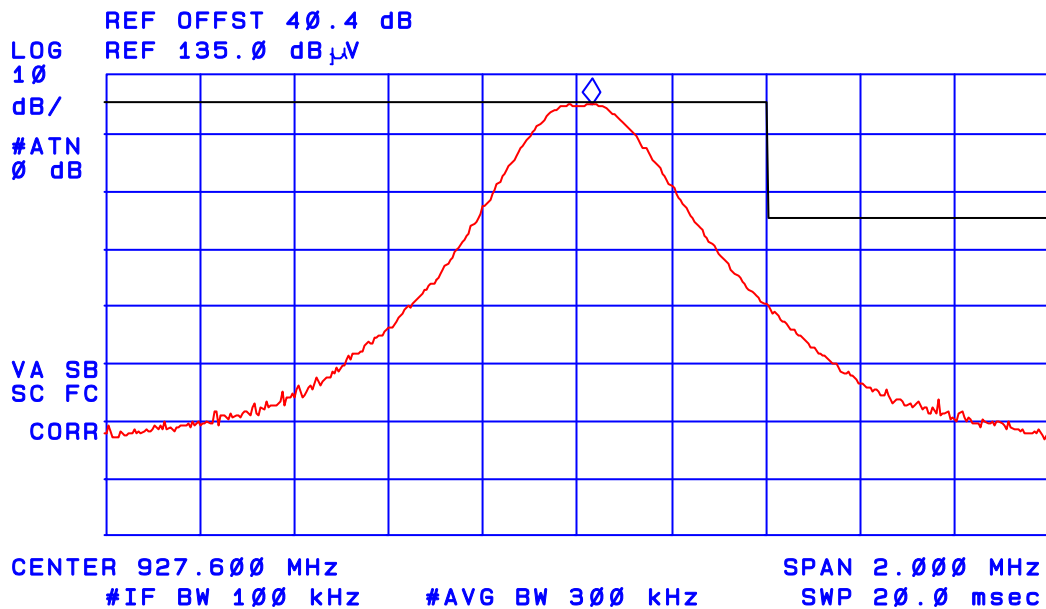

EXHIBIT 7. MEASUREMENT UNCERTAINTY

The measurement uncertainties stated were calculated in accordance with the requirements of NIST Technical Note 1297 and NIS 81 (1994)

7.1. LINE CONDUCTED EMISSION MEASUREMENT UNCERTAINTY

CONTRIBUTION (Line Conducted)	PROBABILITY DISTRIBUTION	UNCERTAINTY (dB)	
		9-150 kHz	0.15-30 MHz
EMI Receiver specification	Rectangular	± 1.5	± 1.5
LISN coupling specification	Rectangular	± 1.5	± 1.5
Cable and Input Transient Limiter calibration	Normal (k=2)	± 0.3	± 0.5
Mismatch: Receiver VRC $\Gamma_1 = 0.03$ LISN VRC $\Gamma_R = 0.8(9 \text{ kHz}) 0.2 (30 \text{ MHz})$ Uncertainty limits $20\text{Log}(1 \pm \Gamma_1 \Gamma_R)$	U-Shaped	± 0.2	± 0.3
System repeatability	Std. deviation	± 0.2	± 0.05
Repeatability of EUT	--	--	--
Combined standard uncertainty	Normal	± 1.25	± 1.30
Expanded uncertainty U	Normal (k=2)	± 2.50	± 2.60

Sample Calculation for Measurement Accuracy in 450 kHz to 30 MHz Band:

$$u_c(y) = \sqrt{\sum_{i=1}^m u_i^2(y)} = \pm \sqrt{(1.5^2 + 1.5^2)/3 + (0.5/2)^2 + (0.05/2)^2 + 0.35^2} = \pm 1.30 \text{ dB}$$

$$U = 2u_c(y) = \pm 2.6 \text{ dB}$$

7.2. RADIATED EMISSION MEASUREMENT UNCERTAINTY

CONTRIBUTION (Radiated Emissions)	PROBABILITY DISTRIBUTION	UNCERTAINTY (+ dB)	
		3 m	10 m
Antenna Factor Calibration	Normal (k=2)	± 1.0	± 1.0
Cable Loss Calibration	Normal (k=2)	± 0.3	± 0.5
EMI Receiver specification	Rectangular	± 1.5	± 1.5
Antenna Directivity	Rectangular	+0.5	+0.5
Antenna factor variation with height	Rectangular	± 2.0	± 0.5
Antenna phase center variation	Rectangular	0.0	± 0.2
Antenna factor frequency interpolation	Rectangular	± 0.25	± 0.25
Measurement distance variation	Rectangular	± 0.6	± 0.4
Site imperfections	Rectangular	± 2.0	± 2.0
Mismatch: Receiver VRC $\Gamma_1 = 0.2$ Antenna VRC $\Gamma_R = 0.67(\text{Bi}) 0.3 (\text{Lp})$ Uncertainty limits $20\text{Log}(1 \pm \Gamma_1 \Gamma_R)$	U-Shaped	+1.1 -1.25	± 0.5
System repeatability	Std. Deviation	± 0.5	± 0.5
Repeatability of EUT		-	-
Combined standard uncertainty	Normal	+2.19 / -2.21	+1.74 / -1.72
Expanded uncertainty U	Normal (k=2)	+4.38 / -4.42	+3.48 / -3.44

Calculation for maximum uncertainty when 3m biconical antenna including a factor of k = 2 is used:

$$U = 2u_c(y) = 2x(+2.19) = +4.38 \text{ dB} \quad \text{And} \quad U = 2u_c(y) = 2x(-2.21) = -4.42 \text{ dB}$$

EXHIBIT 8. MEASUREMENT METHODS

8.1. GENERAL TEST CONDITIONS

The following test conditions shall be applied throughout the tests covered in this report.

8.1.1. Normal temperature and humidity

- Normal temperature: +15°C to +35°C
- Relative Humidity: +20% to 75%

The actual values during tests shall be recorded in the test report.

8.1.2. Normal power source

8.1.2.1. Mains Voltage

The nominal test voltage of the equipment to be connected to mains shall be the nominal mains voltage which is the declared voltage or any of the declared voltages for which the equipment was designed.

The frequency of test power source corresponding to the AC mains shall be between 59 Hz and 61 Hz.

8.1.2.2. Battery Power Source.

For operation from battery power sources, the nominal test voltage shall be as declared by the equipment manufacturer. This shall be recorded in the test report.

8.1.3. Operating Condition of Equipment under Test

- All tests were carried out while the equipment operated at the following frequencies:
 - The lowest operating frequency,
 - The middle operating frequency and
 - The highest operating frequency
- Modulation were applied using the Test Data sequence
- The transmitter was operated at the highest output power, or in the case the equipment able to operate at more than one power level, at the lowest and highest output powers

8.2. METHOD OF MEASUREMENTS - AC MAINS CONDUCTED EMISSIONS

- AC Mains conducted emissions measurements were performed in accordance with the standard against appropriate limits for each detector function.
- The test was performed in the shielded room, 24'(L) by 16'(W) by 8'(H).
- The test was performed were made over the frequency range from 150 kHz to 30 MHz to determine the line-to-ground radio noise voltage which was conducted from the EUT power-input terminals that were directly connected to a public power network.
- The EUT normally received power from another device that connects to the public utility ac power lines, measurements would be made on that device with the EUT in operation to ensure that the device continues to comply with the appropriate limits while providing the EUT with power.
- If the EUT operates only from internal or dedicated batteries, with no provisions for connection to the public utility ac power lines, AC Mains conducted measurements are not required.
- Table-top devices were placed on a platform of nominal size 1 m by 1.5m raised 80 cm above the conducting ground plane.
- The EUT current-carrying power lead, except the ground (safety) lead, was individually connected through a LISN to the power source. All unused 50-Ohm connectors of the LISN was terminated in 50-ohm when not connected to the measuring instruments.
- The line cord of the EUT connected to one LISN which was connected to the measuring instrument. Those power cords for the units of devices not under measurement were connected to a separate multiple ac outlet. Drawings and photographs of typically conducted emission test setups were shown in the Test Report. Each current-carrying conductor of the EUT shall be individually tested.
- The EUT was normally operated with a ground (safety) connection, the EUT was connected to the ground at the LISN through a conductor provided in the lead from the ac power mains to the LISN.
- The excess length of the power cord was folded back and forth in an 8-shape on a wooden strip with a vertical prong located on the top of the LISN case.
- The EUT was set-up in its typical configuration and operated in its various modes as described in 3.2 of the test report.
- A preliminary scan was made by using spectrum analyzer system with the detector function set to PEAK mode (9 KHz RBW, VBW > RBW), frequency span 450 kHz to 30 MHz.
- The maximum conducted emission for a given mode of operation was found by using the following step-by-step procedure:
 - Step1. Monitor the frequency range of interest at a fixed EUT azimuth.
 - Step2. Manipulate the system cables and peripheral devices to produce highest amplitude signal relative to the limit. Note the amplitude and frequency of the suspect signal.
 - Step3. The effects of various modes of operation is examined. This is done by varying equipment operation modes as step 2 is being performed.
 - Step4. After completing step 1 through 3, record EUT and peripheral device configuration, mode of operation, cable configuration, signal levels and frequencies for final test.
- Each highest signal level at the maximized test configuration was zoomed in a small frequency span on the spectrum analyzer's display (the manipulation of cables and peripheral devices and EUT operation modes might have to be repeated to obtain the highest signal level with the spectrum analyzer set to PEAK detector mode 10 KHz RBW and VBW > RBW). The spectrum analyzer was then set to CISPR QUASI-PEAK detector mode (9 KHz RBW, 1 MHz VBW) and AVERAGE detector mode (10 kHz RBW, 1 Hz VBW). The final highest RF signal levels and frequencies were record.

- **Broad-band ac Powerline conducted emissions**:- If the EUT exhibits ac Powerline conducted emissions that exceed the limit with the instrument set to the quasi-peak mode, then measurements should be made in the average mode. If the amplitude measured in the quasi-peak mode is at least 6 dB higher than the amplitude measured in the average mode, the level measured in quasi peak mode may be reduced by 13 dB before comparing it to the limit.

8.3. EQUIVALENT ISOTROPIC RADIATED POWER (EIRP)

- The following shall be applied to the combination(s) of the radio device and its intended antenna(e).
- If the RF level is user adjustable, all measurements shall be made with the highest power level available to the user for that combination.
- The following method of measurement shall apply to both conducted and radiated measurements.
- The radiated measurements are performed at the Ultratech Calibrated Open Field Test Site.
- The measurement shall be performed using normal operation of the equipment with modulation.

Test procedure shall be as follows:

Step 1: Duty Cycle measurements

- Using a spectrum analyzer with the frequency span set to 0 Hz and the sweep time set at a suitable value to capture the envelope peaks and the duty cycle of the transmitter output signal;
- The duty cycle of the transmitter, $x = T_x \text{ on} / (T_x \text{ on} + T_x \text{ off})$ with $0 < x < 1$, is measure and recorded in the test report. For the purpose of testing, the equipment shall be operated with a duty cycle that is equal or more than 0.1.

Step 2: Calculation of Peak and Average EIRP

- The peak output power of the transmitter shall be determined using a wideband, calibrated RF Peak Power Meter with the power sensor with an integration period that exceeds the repetition period of the transmitter by a factor 5 or more. The observed value shall be recorded as “P” (in dBm);
- The Average EIRP shall be calculated from the above measured power output “A”, the observed duty cycle x, and the applicable antenna assembly gain “G” in dBi, according to the formula:

$$\text{Peak EIRP} = P + G$$

$$\text{Average EIRP} = \text{Peak EIRP} + 10\log(1/x)$$

Figure 1

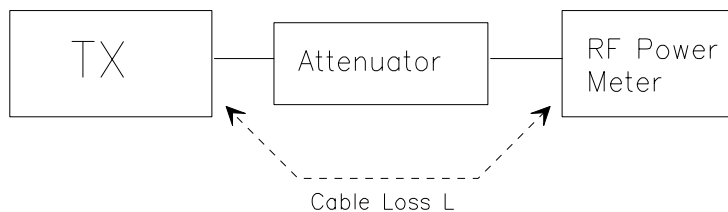

Step 3: Substitution Method. See Figure 2

- (a) The measurements was performed in the absence of modulation (un-modulated)
- (b) Test was performed at listed 3m open area test site (listed with FCC, IC, ITI, NVLAP, ACA & VCCI).
- (c) The transmitter under test was placed at the specified height on a non-conducting turntable (80 cm height)
- (d) The dipole test antenna was used and tuned to the transmitter carrier frequency.
- (e) The spectrum analyzer was tuned to transmitter carrier frequency. The test antenna was lowered or raised from 1 to 4 meters until the maximum signal level was detected.
- (f) The transmitter was rotated through 360° about a vertical axis until a higher maximum signal was received.
- (g) The test antenna was lowered or raised again from 1 to 4 meters until a maximum was obtained. This level was recorded.
- (h) The substitution dipole antenna and the signal generator replaced the transmitter and antenna under test in the same position, and the substitution dipole antenna was placed in vertical polarization. The test dipole antenna was lowered or raised as necessary to ensure that the maximum signal is stilled received.
- (i) The input signal to the substitution antenna was adjusted in level until an equal or a known related level to that detected from the transmitter was obtained in the test receiver. The maximum carrier radiated power is equal to the power supply by the generator.
- (j) The substitution antenna gain and cable loss were added to the signal generator level for the corrected ERP level.
- (k) Repeat steps (c) to (j) with the substitution antenna oriented in horizontal polarization.
- (l) Actual gain of the EUT's antenna is the difference of the measured ERP and measured RF power at the RF port. Correct the antenna gain if necessary.

Figure 2

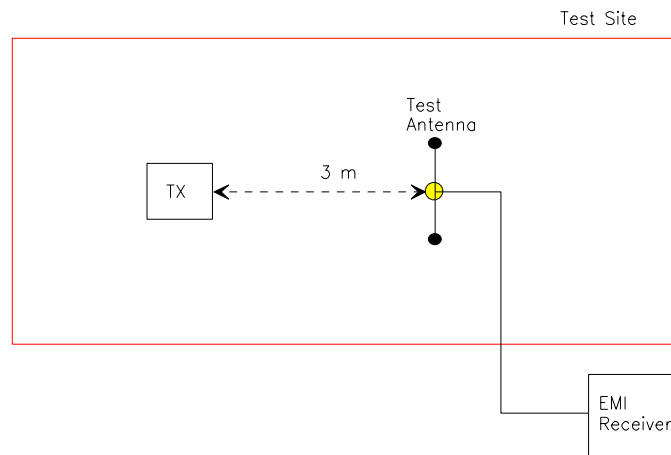
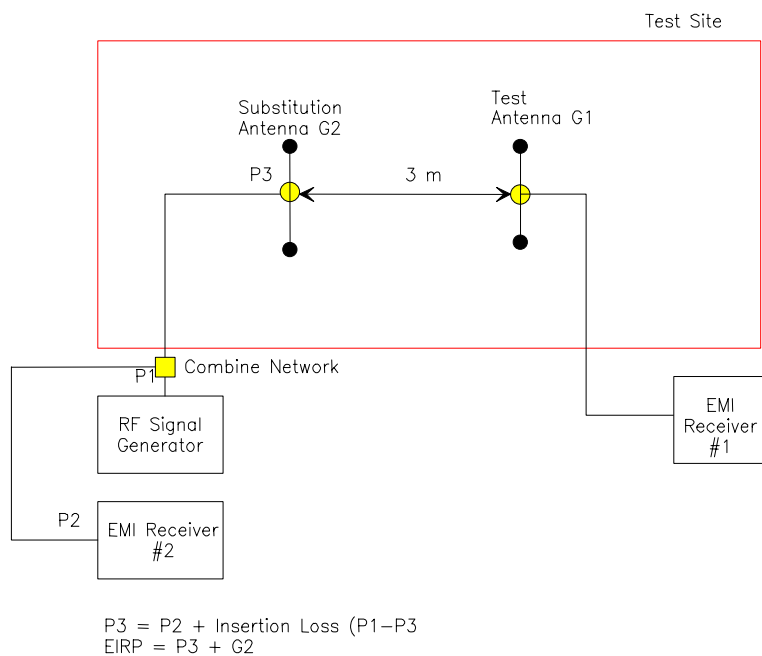

Figure 3



Use the following spectrum analyzer settings:

- Span = approximately 5 times the 20 dB BW, centered on a hopping channel
- RBW > 20 dB BW of the emission measured
- VBW = RBW
- Trace = max hold
- Allow the trace to stabilize
- Use the marker-to-marker function to set the marker to the peak of the emission.
- The indicated level is the peak output power (with the addition of the external attenuation and cable loss).
- The limit is specified in one of the subparagraphs of this Section.
- Submit this plot.
- A peak responding power meter may be used instead of a spectrum analyzer.

8.4. SPURIOUS EMISSIONS (CONDUCTED & RADIATED)

For both conducted and radiated measurements, the spurious emissions were scanned from the lowest frequency generated by the EUT or 10 MHz whichever is lower to 10th harmonic of the highest frequency generated by the EUT.

8.4.1. Band-Edge and Spurious Emissions (Conducted)

Band-Edge Compliance of RF Conducted Emissions:

Use the following spectrum analyzer settings:

- The radio was connected to the measuring equipment via a suitable attenuator.
- Span = wide enough to capture the peak level of the emission operating on the channel closest to the band-edge, as well as any modulation products which fall outside of the authorized band of operation.
- RBW = 1 % of the span
- VBW = RBW
- Sweep = auto
- Detector function = peak
- Trace = max hold
- Allow the trace to stabilize
- Set the marker on the emission at the band-edge, or on the highest modulation product outside of the band, if this level is greater than that at the band-edge
- Enable the marker-delta function, then use the marker-to-peak function to move the marker to the peak of the in-band emission.
- The marker-delta value now displayed must comply with the limit specified
- Now, using the same instrument settings, enable the hopping function of the EUT
- Allow the trace to stabilize
- Follow the same procedure listed above to determine if any spurious emissions cause by the hopping function also comply with the specify limits.
- Submit this plot

Spurious RF Conducted Emissions:

Use the following spectrum analyzer settings:

- The radio was connected to the measuring equipment via a suitable attenuator.
- Span = wide enough to capture the peak level of the in-band-emission and all spurious emissions (e.g. harmonics) from the lowest frequency generated in the EUT up through the 10th harmonic. Typically, several plots are required to cover this entire span.
- RBW = 100 kHz
- VBW = RBW
- Sweep = auto
- Detector function = peak
- Trace = max hold
- Allow the trace to stabilize
- Set the marker on the any spurious emission recorded. The level displayed must comply with the limit specified in this Section.
- Submit this plot

8.4.2. Spurious Emissions (Radiated)

- The radiated emission measurements were performed at the UltraTech's 3 Meter Open Field Test Site (OFTS) situated in the Town of Oakville, province of Ontario. The Attenuation Characteristics of OFTS have been filed to FCC, Industry Canada, ACA/Austel, NVLap and ITI.
- Radiated emissions measurements were made using the following test instruments:
 1. Calibrated EMCO BiconiLog antenna in the frequency range from 30 MHz to 2000 MHz.
 2. Calibrated Emco Horn antennas in the frequency range above 1000 MHz (1GHz - 40 GHz).
 3. The test is required for any spurious emission or modulation product that falls in a Restricted Band, as defined in Section 15.205. It must be performed with the highest gain of each type of antenna proposed for use with the EUT. Use the following spectrum analyzer settings:
 - RBW = 100 kHz for $f < 1\text{GHz}$ and $\text{RBW} = 1\text{ MHz}$ for $f \geq 1\text{ GHz}$
 - VBW = RBW
 - Sweep = auto
 - Detector function = peak
 - Trace = max hold
 - Follows the guidelines in ANSI C63.4-1992 with respect to maximizing the emission by rotating the EUT, measuring the emission while the EUT is situated in three orthogonal planes (if appropriate), adjusting the measurement antenna height and polarization, etc.. A pre-amp and highpass filter are required for this test, in order to provide the measuring system with sufficient sensitivity.
 - Allow the trace to stabilize.
 - The peak reading of the emission, after being corrected by the antenna correction factor, cable loss, pre-amp gain, etc.... is the peak field strength which comply with the limit specified in Section 15.35(b)

Calculation of Field Strength:

The field strength is calculated by adding the calibrated antenna factor and cable factor, and subtracting the Amplifier gain (if any) from the measured reading. The basic equation with a sample calculation is as follows:

$$\text{FS} = \text{RA} + \text{AF} + \text{CF} - \text{AG}$$

Where

FS	=	Field Strength
RA	=	Receiver/Analyzer Reading
AF	=	Antenna Factor
CF	=	Cable Attenuation Factor
AG	=	Amplifier Gain

Example: If a receiver reading of 60.0 dBuV is obtained, the antenna factor of 7.0 dB/m and cable factor of 1.0 dB are added, and the amplifier gain of 30 dB is subtracted. The actual field strength will be:

$$\begin{aligned}\text{Field Level} &= 60 + 7.0 + 1.0 - 30 = 38.0 \text{ dBuV/m.} \\ \text{Field Level} &= 10^{(38/20)} = 79.43 \text{ uV/m.}\end{aligned}$$

- Submit this test data
- Now set the VBW to 10Hz, while maintaining all of the other instrument settings. This peak level, once corrected, must comply with the limit specified in Section 15.209. If the dwell time per channel of the hopping signal is less than 100ms, then the reading obtained may be further adjusted by a “duty cycle correction factor”, derived from $10\log(\text{dwell time}/100\text{mS})$ in an effort to demonstrate compliance with the 15.209.
- Submit test data

Maximizing The Radiated Emissions:

- The frequencies of emissions was first detected. Then the amplitude of the emissions was measured at the specified measurement distance using required antenna height, polarization, and detector characteristics.
- During this process, cables and peripheral devices were manipulated within the range of likely configuration.
- For each mode of operation required to be tested, the frequency spectrum was monitored. Variations in antenna heights (from 1 meter to 4 meters above the ground plane), antenna polarization (horizontal plane and vertical plane), cable placement and peripheral placement were explored to produce the highest amplitude signal relative to the limit.

The maximum radiated emission for a given mode of operation was found by using the following step-by-step procedure:

- Step 1: Monitor the frequency range of interest at a fixed antenna height and EUT azimuth.
- Step 2: Manipulate the system cables to produce highest amplitude signal relative to the limit. Note the amplitude and frequency of the suspect signal.
- Step 3: Rotate the EUT 360 degrees to maximize the suspected highest amplitude signal. If the signal or another at a different frequency is observed to exceed the previously noted highest amplitude signal by 1 dB or more, go back to the azimuth and repeat Step 2. Otherwise, orient the EUT azimuth to repeat the highest amplitude observation and proceed.
- Step 4: Move the antenna over its full allowable range of travel (1 to 4 meters) to maximize the suspected highest amplitude signal. If the signal or another at a different frequency is observed to exceed the previously noted highest amplitude signal by 1 dB or more, return to Step 2 with the highest amplitude observation and proceed.
- Step 5: Change the polarization of the antenna and repeat Step 2 through 4. Compare the resulting suspected highest amplitude signal with that found for the other polarization. Select and note the higher of the two signals. This signal is termed the highest observed signal with respect to the limit for this EUT operational mode.
- Step 6: The effects of various modes of operation is examined. This is done by varying the equipment modes as steps 2 through 5 are being performed.
- Step 7: After completing steps 1 through 6, record the final highest emission level, frequency, antenna polarization and detector mode of the measuring instrument.

8.5. ALTERNATIVE TEST PROCEDURES

If the antenna conducted tests cannot be performed on this device, radiated tests show compliance with the peak output power limit specified in Section 15.247(b) and the spurious RF conducted emission limit specified in Section 15.247(c) are acceptable. As stated previously, a pre-amp, and, in the later case, a high pass filter, are required for the following measurements:

8.5.1. Peak Power Measurements

Calculate the transmitter's peak power using the following equation:

$$E = 30PG/d$$
$$P = (Ed)^2/30G$$

Where:

- E: measured maximum fundamental field strength in V/m. Utilizing a RBW, the 20 dB bandwidth of the emission VBW >RBW, peak detector function. Follow the procedures in C63.4-1992 with respect to maximizing the emission
- G is numeric gain of the transmitting antenna with reference to an isotropic radiator
- D is the distance in meters from which the field strength was measured
- P is the distance in meters from which the field strength was measured

8.5.2. Spurious RF conducted emissions

To demonstrate compliance with the spurious RF conducted emission requirement of Section 15.2479(c), use the following spectrum analyzer settings:

- Span = wide enough to fully capture the emission being measured
- RBW = 100 kHz
- Sweep = auto
- Detector function = peak
- Trace = max hold
- Measure the field strength of both the fundamental and all spurious emissions with these settings.
- Follow the procedures C62-4:1994 with respect to maximizing the emissions. The measured field strength of all spurious emissions must be below the measured field strength of the fundamental emission by the amount specified in Section 15.247©. Note that if the emission falls in a Restricted Band, as defined in Section 15.205, the procedure for measuring spurious radiated emissions listed above must be followed