



Produkte
 Products

Prüfbericht - Nr.: 12607853 001		Seite 1 von 34	
<i>Test Report No.:</i>		<i>Page 1 of 34</i>	
Auftraggeber: <i>Client:</i>	Kyocera Mita Corporation 2-28 1-Chome Tamatsukuri, Chuo-ku, Osaka 540-8585, Japan		
Gegenstand der Prüfung: <i>Test Item:</i>	RFID Module		
Bezeichnung: <i>Identification:</i>	2K9A0523	Serien-Nr.: <i>Serial No.:</i>	0-0500030, 0-0500035 SPL2K9001
Wareneingangs-Nr.: <i>Receipt No.:</i>	PT0214004465-1	Eingangsdatum: <i>Date of Receipt:</i>	2010-09-27
Prüfart: <i>Testing Location:</i>	TÜV Rheinland Japan Ltd. - Global Technology Assessment Center 4-25-2 Kita-Yamata, Tsuzuki-ku, Yokohama 224-0021, Japan		
Prüfgrundlage: <i>Test Specification:</i>	FCC 47 CFR Part 15, Subpart C, Section 15.225 (October 1, 2009) ANSI C63.4-2003 RSS-210 (Issue 7): 2007 RSS-Gen (Issue 2): 2007		
Prüfresultat: <i>Test Result:</i>	Der Prüfgegenstand entspricht oben genannter Prüfgrundlage(n). <i>The test item passed the test specification(s).</i>		
Prüflaboratorium: <i>Testing Laboratory:</i>	TÜV Rheinland Japan Ltd. - Global Technology Assessment Center 4-25-2 Kita-Yamata, Tsuzuki-ku, Yokohama 224-0021, Japan		
geprüft/ tested by:		kontrolliert/ reviewed by:	
2010-11-29 T. Sauter / Inspector 		2010-11-29 T. Cheung / Reviewer 	
Datum <i>Date</i>	Name/Stellung <i>Name/Position</i>	Unterschrift <i>Signature</i>	Datum <i>Date</i>
			Name/Stellung <i>Name/Position</i>
			Unterschrift <i>Signature</i>
Sonstiges / Other Aspects:			
This test report deals only with the intentional radiator portion of the tested product.			
Abkürzungen:		Abbreviations:	
P(pass) = entspricht Prüfgrundlage		P(pass) = passed	
F(fail) = entspricht nicht Prüfgrundlage		F(fail) = failed	
N/A = nicht anwendbar		N/A = not applicable	
N/T = nicht getestet		N/T = not tested	
<p>Dieser Prüfbericht bezieht sich nur auf das o.g. Prüfmuster und darf ohne Genehmigung der Prüfstelle nicht auszugsweise vervielfältigt werden. Dieser Bericht berechtigt nicht zur Verwendung eines Prüfzeichens. <i>This test report relates to the a. m. test sample. Without permission of the test center this test report is not permitted to be duplicated in extracts. This test report does not entitle to carry any safety mark on this or similar products.</i></p>			

TEST SUMMARY

3.2.1 VOLTAGE REQUIREMENTS, FCC 15.31(E)

RESULT: PASS

3.2.2 ANTENNA REQUIREMENTS, FCC 15.203, FCC 15.204 AND RSS-GEN 7.1.4

RESULT: PASS

5.1.1 FREQUENCY STABILITY, FCC 15.225(E), RSS-210 A2.6, RSS-GEN 4.7 AND RSS-GEN 7.2.4

RESULT: PASS

6.1.1 20dB BANDWIDTH, FCC 15.215(c)

RESULT: PASS

6.1.2 99% BANDWIDTH, RSS-GEN 4.6.1

6.1.3 FUNDAMENTAL AND IN-BAND RADIATED EMISSION, FCC 15.225(A)(B)(C), RSS-210 A2.6(A)(B)(C)

RESULT: PASS

6.1.4 OUT-OF-BAND RADIATED SPURIOUS EMISSION OF TRANSMITTER BELOW 30MHZ, FCC 15.225(D), FCC 15.209, RSS-210 A2.6(D) AND RSS-210 2.6

RESULT: PASS

6.1.5 RADIATED SPURIOUS EMISSION OF TRANSMITTER ABOVE 30MHZ, FCC 15.225(D), FCC 15.209, RSS-210 A2.6(D) AND RSS-210 2.6

RESULT: PASS

6.2.1 RADIATED SPURIOUS EMISSION OF RECEIVER, RSS-210 2.6 AND RSS-GEN 7.2.3.2

RESULT: N/A

7.1.1 AC POWER LINE CONDUCTED EMISSION OF TRANSMITTER, FCC 15.207 AND RSS-GEN 7.2.2

RESULT: PASS

7.2.1 AC POWER LINE CONDUCTED EMISSION OF RECEIVER, RSS-GEN 7.2.2

RESULT: N/A

Contents

1.	GENERAL REMARKS	5
1.1	COMPLEMENTARY MATERIALS	5
2.	TEST SITES	6
2.1	TEST FACILITIES	6
2.2	LIST OF TEST AND MEASUREMENT INSTRUMENTS	7
2.3	MEASUREMENT UNCERTAINTY	8
3.	GENERAL PRODUCT INFORMATION	9
3.1	PRODUCT FUNCTION AND INTENDED USE	9
3.2	SYSTEM DETAILS	9
3.2.1	<i>Voltage Requirements, FCC 15.31(e)</i>	<i>10</i>
3.2.2	<i>Antenna Requirements, FCC 15.203, FCC 15.204 and RSS-Gen 7.1.4</i>	<i>10</i>
3.3	INDEPENDENT OPERATION MODES	11
3.4	CLOCK FREQUENCIES	11
4.	TEST SET-UP AND OPERATION MODES	12
4.1	TEST METHODOLOGY	12
4.2	PHYSICAL CONFIGURATION FOR TESTING	12
4.3	TEST SOFTWARE	13
4.4	SPECIAL ACCESSORIES AND AUXILIARY EQUIPMENT	14
4.5	COUNTERMEASURES TO ACHIEVE EMC COMPLIANCE	15
5.	TEST RESULTS OF CONDUCTED MEASUREMENTS AT ANTENNA PORT	16
5.1.1	<i>Frequency Stability, FCC 15.225(e), RSS-210 A2.6, RSS-Gen 4.7 and RSS-Gen 7.2.4</i>	<i>16</i>
6.	TEST RESULTS OF RADIATED MEASUREMENTS	19
6.1	RADIATED EMISSION OF TRANSMITTER	19
6.1.1	<i>20dB Bandwidth, FCC 15.215(c)</i>	<i>19</i>
6.1.2	<i>99% Bandwidth, RSS-Gen 4.6.1</i>	<i>21</i>
6.1.3	<i>Fundamental and In-band Radiated Emission, FCC 15.225(a)(b)(c), RSS-210 A2.6(a)(b)(c) ..</i>	<i>23</i>
6.1.4	<i>Out-of-Band Radiated Spurious Emission of Transmitter below 30MHz, FCC 15.225(d), FCC 15.209, RSS-210 A2.6(d) and RSS-210 2.6</i>	<i>25</i>
6.1.5	<i>Radiated Spurious Emission of Transmitter above 30MHz, FCC 15.225(d), FCC 15.209, RSS-210 A2.6(d) and RSS-210 2.6</i>	<i>27</i>
6.2	RADIATED EMISSION OF RECEIVER	29
6.2.1	<i>Radiated Spurious Emission of Receiver, RSS-210 2.6 and RSS-Gen 7.2.3.2</i>	<i>29</i>
7.	TEST RESULTS OF AC POWER LINE CONDUCTED MEASUREMENTS	30
7.1	AC POWER LINE CONDUCTED EMISSION OF TRANSMITTER	30
7.1.1	<i>AC Power Line Conducted Emission of Transmitter, FCC 15.207 and RSS-Gen 7.2.2</i>	<i>30</i>

7.2	AC POWER LINE CONDUCTED EMISSION OF RECEIVER.....	32
7.2.1	<i>AC Power Line Conducted Emission of Receiver, RSS-Gen 7.2.2</i>	<i>32</i>
8.	PHOTOGRAPHS OF THE TEST SETUP.....	33
9.	LIST OF TABLES.....	33
10.	LIST OF FIGURES	33
11.	ATTACHMENT: PHOTOGRAPHS OF TEST SETUP.....	34

1. General Remarks

The tested RFID module was evaluated under the relevant FCC and IC requirements in order to apply for a Limited Modular Approval.

The RFID module is intended for use with the printers 3050ci, 3550ci, 4550ci and 5550ci by Kyocera Mita. These four printers have an identical construction. Their only difference is the printing speed, which is set by the internal software.

Testing was performed in two configurations: the RFID module tested in stand-alone basis (only connected to a test jig) and while inserted into a printer. The printer 3050ci was selected as representative model for testing purpose.

1.1 Complementary Materials

All attachments are integral parts of this test report.

This applies especially to the following document:

- (1) Photographs of Test Setup by TÜV Rheinland Japan Ltd.

2. Test Sites

2.1 Test Facilities

TÜV Rheinland Japan Ltd. - Global Technology Assessment Center
4-25-2 Kita-Yamata, Tsuzuki-ku, Yokohama 224-0021, Japan

The used test equipment is in accordance with CISPR 16 for measurement of radio interference.

The Federal Communications Commission has reviewed the technical characteristics of the radiated and conducted emission facility, and has found these test facilities to be in compliance with the requirements of section 2.948 of the FCC rules. The description of the test facility is listed under FCC registration number 299054.

The Industry Canada has reviewed the technical characteristics of the radiated and conducted emission facility, and has found these test facilities to be in compliance. The description of the test facility is listed under OATS filing number 3466B.

The test facility is accredited by VLAC (member of ILAC) under number VLAC-017 according to ISO/IEC 17025:2005. TÜV Rheinland Japan Ltd. is accredited by the Federal Communications Commission as a Conformity Assessment Body under Designation Number JP0017 and Test Firm Registration Number 386498.

2.2 List of Test and Measurement Instruments

Table 1: List of Test and Measurement Equipment

Kind of Equipment	Manufacturer	Model Name	Serial Number	Equipment ID	Calibrated until
For Antenna Port Conducted Emission					
Receiver	Rohde & Schwarz	ESU 8	100025	RF-0020	2011-02
Temperature Chamber	Voetsch	VT 4018	585660250 90010	BT-8012	2011-08
For AC Power Line Conducted Emission					
Receiver	Rohde & Schwarz	ESU 8	100025	RF-0020	2011-02
Receiver	Rohde & Schwarz	ESU 40	100029	RF-0021	2010-12
LISN	Rohde & Schwarz	ENV216	100276	RF-0016	2011-06
LISN	Schwarzbeck Mess-Elektronik	NSLK 8128 (4X32/50A)	8128-239	RF-0017	2011-05
For Radiated Emission					
Receiver	Rohde & Schwarz	ESU 8	100025	RF-0020	2011-02
RF Selector (10m)	Toyo Corporation	NS4900	0703-182	RF-0029	2011-05
3dB Attenuator 50Ohm	Tamagawa Electronics Co., Ltd.	CFA-01	-	RF-0265	2011-05
Low Noise Pre- Amplifier	TSJ	MLA-10K01- B01-35	1370750	RF-0253	2010-11
Loop Antenna with power supply, 9kHz- 30MHz	Rohde & Schwarz	HFH2-Z2	100139	RF-0048	2011-02
Biconical Antenna, 30- 300MHz	EMCO	3110B	9603-2379	RF-0207	2011-02
Trilog Antenna, 30- 1000MHz	Schwarzbeck	VULB9168	0245	RF-0019	2011-05
Constant Voltage Constant Frequency Stabilizers					
CVCF (Shielded Room)	NF Corporation	ESU2000S	9075612	RF-0210	N/A
CVCF Booster (Shielded Room)	NF Corporation	ESU2000B	9074403	RF-0211	N/A
CVCF (10m chamber)	NF Corporation	ESU2000S	9075612	RF-0212	N/A
CVCF Booster (10m chamber)	NF Corporation	ESU2000B	9074403	RF-0213	N/A

2.3 Measurement Uncertainty

Table 2: Emission Measurement Uncertainty

Measurement Type	Frequency	Uncertainty
AC Power Line Conducted Emission	150kHz - 30MHz	±3.0dB
Antenna Port Conducted Emission	< 1GHz	±0.39dB
	> 1GHz	±0.68dB
Radiated Emission	9kHz - 30MHz	±4.0dB
	above 30MHz	±4.7dB

3. General Product Information

3.1 Product Function and Intended Use

The EUT (Equipment Under Test) is an RFID reader-writer module intended to be used with a dedicated multifunction printer. It communicates with tags placed on the printer toner cartridges by RFID protocol.

The EUT has four antennas which cannot operate simultaneously. Only one antenna at a time is operable while the EUT is active.

3.2 System Details

Radio standard: ISO 15693
 Specified output power: 0.2nW EIRP
 Antenna gain: -53dBi
 Antenna type: Loop antenna
 Antenna mounting type: Printed
 Frequency range: 13.56MHz
 Number of channels: 1
 Modulation type: ASK
 FCC classification: DXX
 Emission designator: A1D

Rated voltage: DC3.3V ± 15%
 Rated current: 100mA
 Protection class: III

Test voltage: Refer to each test item.

Table 3: List of Cables used for Testing, Configuration with Test Jig

No.	Interface	Cable Length for Testing, Shielding	Interface Classification
1.	4-wire flat cable [EUT <-> Test Jig]	0.4m, un-shielded for radiated measurements, 1m, shielded for other measurements	DC Power and Signal Port
2.	BNC coaxial cable [EUT <-> Spectrum Analyzer] (for antenna port conducted measurements only)	1m, shielded	Signal Port
3.	AC Mains for Test Jig	2m, un-shielded	AC Power Port

Table 4: List of Cables used for Testing, Configuration with Printer

No.	Interface	Cable Length for Testing, Shielding	Interface Classification
1.	AC Mains	2.5m, un-shielded	AC Power Port
2.	USB	1m, shielded	Signal Port
3.	Ethernet	1m, un-shielded	Signal Port

3.2.1 Voltage Requirements, FCC 15.31(e)

RESULT:

PASS

The maximum carrier output field level for the EUT was measured between 85% and 115% of the nominal rated supply voltage. Hence it complies with the power supply requirements.

3.2.2 Antenna Requirements, FCC 15.203, FCC 15.204 and RSS-Gen 7.1.4

RESULT:

PASS

The EUT has printed antennas together with the circuit. Hence it complies with the requirements.

3.3 Independent Operation Modes

The EUT was fully tested on a stand-alone basis (only attached to a test jig). Fundamental and in-band radiated emission measurements as well as radiated and AC power line conducted spurious emission measurements were performed additionally with the EUT installed into a host (printer). The test system was configured in both cases in a typical fashion (as a customer would normally use it).

The justification and manipulation of cables and equipment in order to simulate a worst-case behavior of the test setup has been carried out as prescribed in ANSI C63.4:2003.

The basic operation modes are:

- A. Continuously writing mode (sending data to RFID tag) at 13.56MHz according to ISO 15693
- B. Continuously reading mode (reading signals from RFID tags) at 13.56MHz according to ISO 15693
- C. Continuously transmitting (Tx) mode, unmodulated signal

Note:

The EUT is a transceiver. In modes A and B, transmitter and receiver are both active.

In the configuration where the EUT is used in a printer, operation of the RFID module is performed in both modes A and B at the same time (read/write mode).

3.4 Clock Frequencies

The highest clock frequency generated by the EUT is 13.56MHz.

4. Test Set-up and Operation Modes

4.1 Test Methodology

The test methodology used is based on the requirements of 47 CFR Part 15, Sections 15.31, 15.33, 15.35, 15.205, 15.207, 15.209 and 15.225.

The test methods, which have been used, are based on ANSI C63.4-2003 and RSS-Gen (Issue 2).

For details, see under each test item.

4.2 Physical Configuration for Testing

Figure 1: Setup for Antenna Port Conducted Measurements

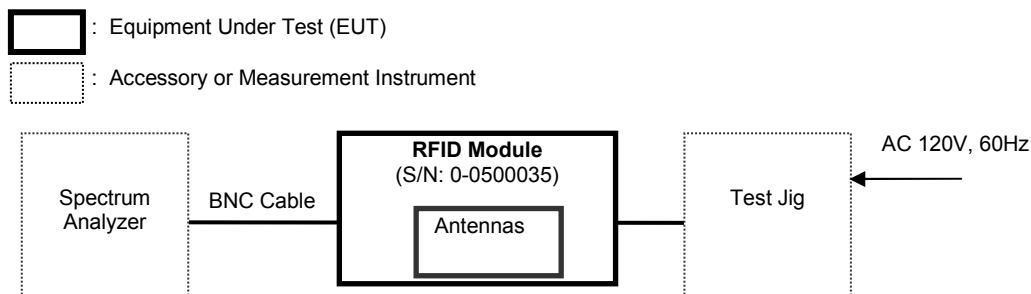

Notes:

The test jig was used to supply the EUT with DC voltage.

For antenna conducted measurements, the tested antenna was replaced by a 50Ω antenna connector.

For more details, refer to section: Photographs of the Test Set-Up.

Figure 2: Setup for Radiated and AC Power Line Conducted Emission Measurements, Configuration with Test Jig

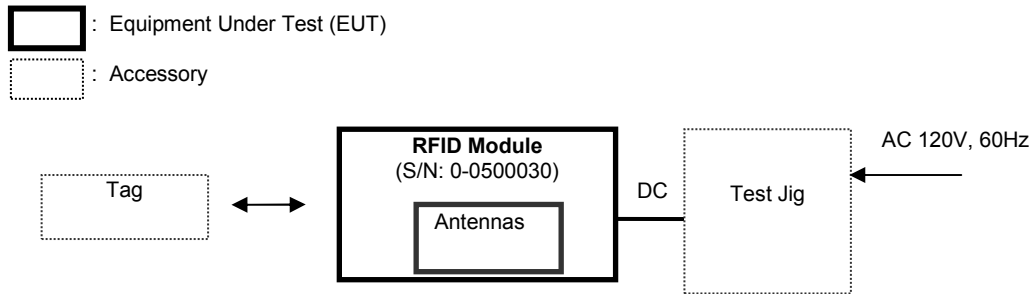

Note:

The test jig was used to supply the EUT with DC voltage. In addition, it can select the antenna used and the operation mode.

Figure 3: Setup for Radiated and AC Power Line Conducted Emission Measurements, Configuration with Printer

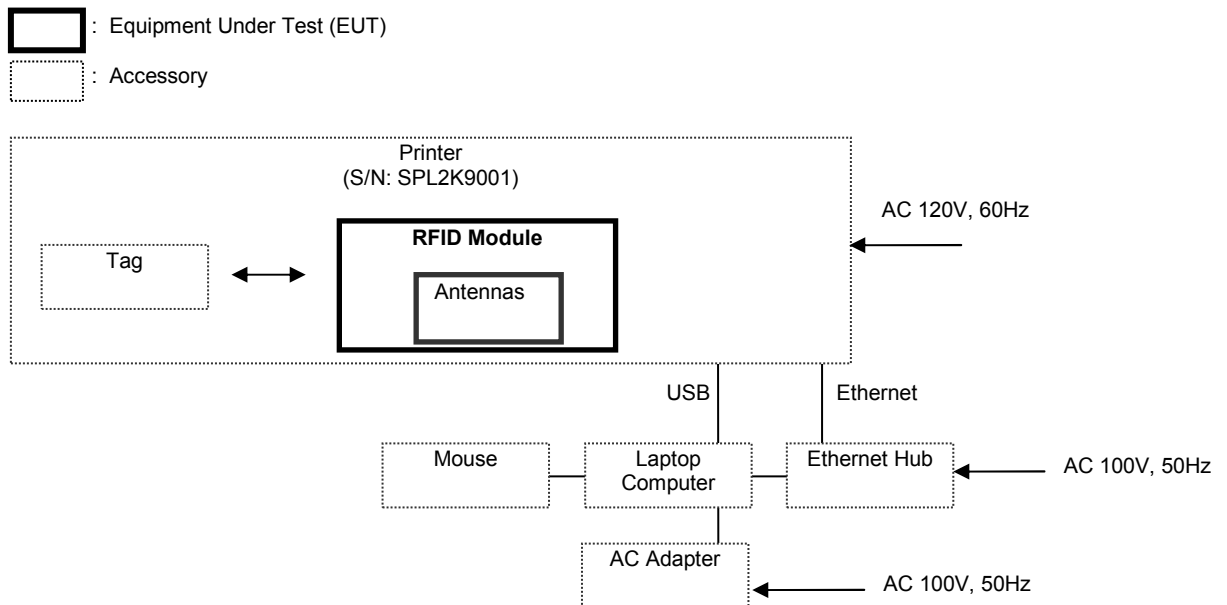

For more details, refer to section: Photographs of the Test Set-Up.

4.3 Test Software

No software was used for testing.

4.4 Special Accessories and Auxiliary Equipment

The product has been tested together with the following additional accessories:

1. Product: Test Jig
Manufacturer: Kyocera Mita
Model: Unspecified
Rated Voltage: AC 100-120V
Input Current: Unspecified
Frequency: 50/60Hz
Serial Number: Unspecified

2. Product: Printer
Manufacturer: Kyocera Mita
Model: 3050ci
Rated Voltage: AC 120V
Input Current: Unspecified
Frequency: 60Hz
Serial Number: SPL2K9001

3. Product: Laptop Computer
Manufacturer: IBM
Model: ThinkPad X60s
Rated Voltage: DC 20V
Input Current: 3.5A
Serial Number: LV-D3639 06/08

4. Product: AC Adapter for Laptop Computer
Manufacturer: Lenovo
Model: 65W 20V
Rated Voltage: AC 100-240V
Input Current: 1.5A
Frequency: 50/60Hz
Serial Number: 11S92P1156Z1ZBGFG7T4R5

5. Product: Mouse
Manufacturer: Elecom
Model: M-N2USV
Rated Voltage: DC 5V
Input Current: Unspecified
Serial Number: 40602928

6. Product: Ethernet Hub
Manufacturer: Buffalo
Model: Giga Switching Hub, LSW3-GT-5NS(D1)
Rated Voltage: AC 100V
Input Power: 5W
Frequency: 50/60Hz
Serial Number: 16485784211186

4.5 Countermeasures to achieve EMC Compliance

No additional measures were employed to achieve compliance.

5. Test Results of Conducted Measurements at Antenna Port

5.1.1 Frequency Stability, FCC 15.225(e), RSS-210 A2.6, RSS-Gen 4.7 and RSS-Gen 7.2.4

RESULT: **PASS**

Date of testing: 2010-09-27

Ambient temperature: 25°C
Relative humidity: 47%
Atmospheric pressure: 1018hPa

Low test voltage: DC 2.805V
Normal test voltage: DC 3.3V
High test voltage: DC 3.795V

Lowest test temperature: -20°C
Normal test temperature: 20°C
Highest test temperature: 50°C

Requirements:

The frequency tolerance of the carrier signal shall be maintained within $\pm 0.01\%$ of the operating frequency over a temperature variation of -20°C to $+50^{\circ}\text{C}$ at normal supply voltage, and for a variation in the primary supply voltage from 85% to 115% of the rated supply voltage at a temperature of 20°C .

Test procedure:

ANSI C63.4-2003 and RSS-Gen 4.7

The EUT was placed inside a temperature chamber and set to operation mode C (continuous unmodulated transmitter signal). The frequency of the carrier signal was measured with a spectrum analyzer.

Measurements were performed for every 10°C inside the specified temperature interval. Measurements started after the temperature was sufficiently stabilized and were performed at start-up of the EUT, and then after 2, 5 and 10 minutes.

This test was then repeated at a temperature of 20°C for a variation of $\pm 15\%$ of the input voltage. Since the EUT does not incorporate a voltage regulator, voltage variation measurements were performed on the EUT power supply.

Table 5: Frequency Stability at 50°C, DC 3.3V

Elapsed Time [min]	Nominal Frequency [MHz]	Measured Frequency [MHz]	Deviation [%]	Limit [%]	Result
Start-up	13.56	13.560017	0.00013	0.01	Pass
2	13.56	13.560013	0.00010	0.01	Pass
5	13.56	13.560008	0.00006	0.01	Pass
10	13.56	13.560008	0.00006	0.01	Pass

Table 6: Frequency Stability at 40°C, DC 3.3V

Elapsed Time [min]	Nominal Frequency [MHz]	Measured Frequency [MHz]	Deviation [%]	Limit [%]	Result
Start-up	13.56	13.560071	0.00052	0.01	Pass
2	13.56	13.560063	0.00046	0.01	Pass
5	13.56	13.560059	0.00043	0.01	Pass
10	13.56	13.560059	0.00043	0.01	Pass

Table 7: Frequency Stability at 30°C, DC 3.3V

Elapsed Time [min]	Nominal Frequency [MHz]	Measured Frequency [MHz]	Deviation [%]	Limit [%]	Result
Start-up	13.56	13.560130	0.00096	0.01	Pass
2	13.56	13.560122	0.00090	0.01	Pass
5	13.56	13.560118	0.00087	0.01	Pass
10	13.56	13.560114	0.00084	0.01	Pass

Table 8: Frequency Stability at 20°C, DC 3.3V

Elapsed Time [min]	Nominal Frequency [MHz]	Measured Frequency [MHz]	Deviation [%]	Limit [%]	Result
Start-up	13.56	13.560181	0.00133	0.01	Pass
2	13.56	13.560172	0.00127	0.01	Pass
5	13.56	13.560168	0.00124	0.01	Pass
10	13.56	13.560168	0.00124	0.01	Pass

Table 9: Frequency Stability at 10°C, DC 3.3V

Elapsed Time [min]	Nominal Frequency [MHz]	Measured Frequency [MHz]	Deviation [%]	Limit [%]	Result
Start-up	13.56	13.560223	0.00164	0.01	Pass
2	13.56	13.560214	0.00158	0.01	Pass
5	13.56	13.560214	0.00158	0.01	Pass
10	13.56	13.560214	0.00158	0.01	Pass

Table 10: Frequency Stability at 0°C, DC 3.3V

Elapsed Time [min]	Nominal Frequency [MHz]	Measured Frequency [MHz]	Deviation [%]	Limit [%]	Result
Start-up	13.56	13.560240	0.00177	0.01	Pass
2	13.56	13.560240	0.00177	0.01	Pass
5	13.56	13.560240	0.00177	0.01	Pass
10	13.56	13.560240	0.00177	0.01	Pass

Table 11: Frequency Stability at -10°C, DC 3.3V

Elapsed Time [min]	Nominal Frequency [MHz]	Measured Frequency [MHz]	Deviation [%]	Limit [%]	Result
Start-up	13.56	13.560240	0.00177	0.01	Pass
2	13.56	13.560244	0.00180	0.01	Pass
5	13.56	13.560244	0.00180	0.01	Pass
10	13.56	13.560244	0.00180	0.01	Pass

Table 12: Frequency Stability at -20°C, DC 3.3V

Elapsed Time [min]	Nominal Frequency [MHz]	Measured Frequency [MHz]	Deviation [%]	Limit [%]	Result
Start-up	13.56	13.560223	0.00164	0.01	Pass
2	13.56	13.560219	0.00162	0.01	Pass
5	13.56	13.560219	0.00162	0.01	Pass
10	13.56	13.560219	0.00162	0.01	Pass

Table 13: Frequency Stability at 20°C, DC 2.805V

Elapsed Time [min]	Nominal Frequency [MHz]	Measured Frequency [MHz]	Deviation [%]	Limit [%]	Result
Start-up	13.56	13.560122	0.00090	0.01	Pass
2	13.56	13.560122	0.00090	0.01	Pass
5	13.56	13.560122	0.00090	0.01	Pass
10	13.56	13.560122	0.00090	0.01	Pass

Table 14: Frequency Stability at 20°C, DC 3.795V

Elapsed Time [min]	Nominal Frequency [MHz]	Measured Frequency [MHz]	Deviation [%]	Limit [%]	Result
Start-up	13.56	13.560193	0.00142	0.01	Pass
2	13.56	13.560193	0.00142	0.01	Pass
5	13.56	13.560193	0.00142	0.01	Pass
10	13.56	13.560193	0.00142	0.01	Pass

6. Test Results of Radiated Measurements

6.1 Radiated Emission of Transmitter

6.1.1 20dB Bandwidth, FCC 15.215(c)

RESULT:

PASS

Date of testing: 2010-09-28

Ambient temperature: 25°C

Relative humidity: 62%

Atmospheric pressure: 1004hPa

Requirements:

The 20dB bandwidth of the emission shall be contained within the frequency band designated in the rule section under which the equipment is operated.

In the present case, the frequency band is from 13.110MHz to 14.010MHz, therefore the 20dB bandwidth should be maintained within this frequency band.

Test procedure:

ANSI C63.4-2003

The EUT was placed on a nonconductive turntable 0.8m above the ground plane and set to operation mode A. Measurements were made at 3m distance with a loop antenna connected to a spectrum analyzer.

Measurement was performed with a suitable span to encompass the peak of the fundamental and using the following settings: RBW = 1kHz, VBW = 3kHz.

Table 15: 20dB Bandwidth Edge Frequencies

20dB Bandwidth Edge Side	Operating Frequency [MHz]	Edge Frequency [MHz]	Limit [MHz]	Margin [MHz]
Low	13.56	13.5583	13.1100	0.4483
High	13.56	13.5620	14.0100	0.4480

Table 16: 20dB Bandwidth

Operating Frequency [MHz]	20dB Bandwidth [kHz]
13.56	3.70

Figure 4: 20dB Bandwidth

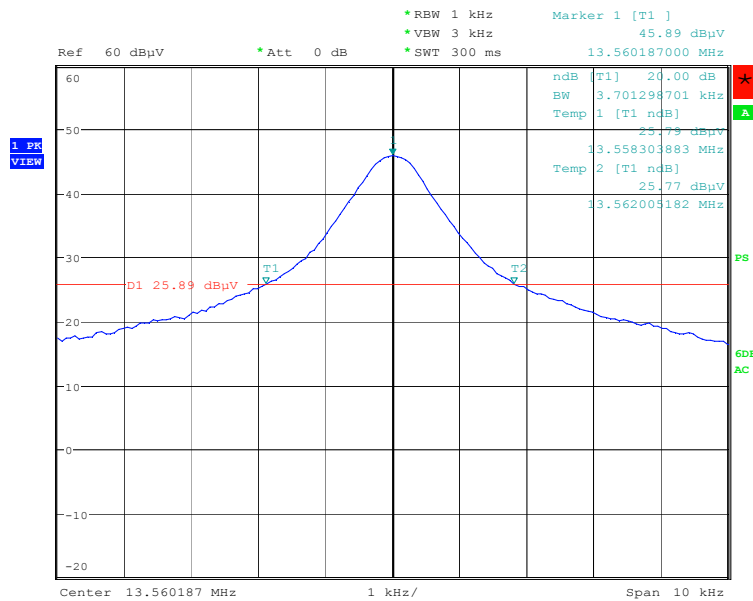

20dB bandwidth, Mode A

Date: 28.SEP.2010 16:55:09

6.1.2 99% Bandwidth, RSS-Gen 4.6.1

Date of testing: 2010-09-28

Ambient temperature: 25°C

Relative humidity: 62%

Atmospheric pressure: 1004hPa

Requirements:

The 99% bandwidth shall be reported according to RSS-Gen 4.6.1.

Test procedure:

RSS-Gen 4.6.1.

The EUT was placed on a nonconductive turntable 0.8m above the ground plane and set to operation mode A. Measurements were made at 3m distance with a loop antenna connected to a spectrum analyzer.

The spectrum analyzer resolution bandwidth (100Hz) corresponded to 1% of the span (10kHz). The 99% bandwidth was measured by using the OBW function of the analyzer with a 99% coverage setting.

Table 17: 99% Bandwidth, Mode A

Operating Frequency [MHz]	99% Bandwidth [kHz]
13.56	1.12

Figure 5: 99% Bandwidth, Mode A

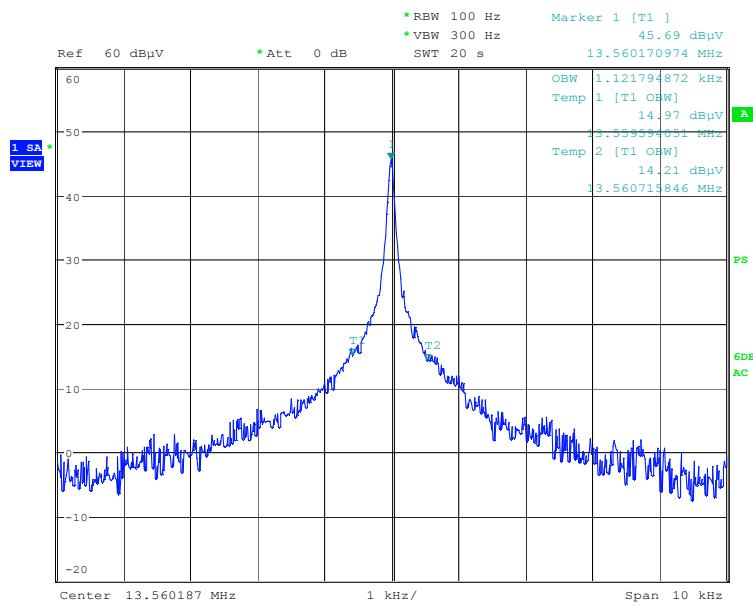

99% bandwidth, Mode A
 Date: 28.SEP.2010 17:19:53

6.1.3 Fundamental and In-band Radiated Emission, FCC 15.225(a)(b)(c), RSS-210 A2.6(a)(b)(c)

RESULT:

PASS

Date of testing: 2010-09-28, 2010-11-18

Ambient temperature: 25, 22°C

Relative humidity: 62, 43%

Atmospheric pressure: 1004, 1015hPa

Frequency range: 13.110MHz – 14.010MHz

Measurement distance: 3m

Kind of test site: Semi Anechoic Chamber

Requirements:

The emissions from the intentional radiator shall not exceed the field strength specified in FCC 15.225(a)(b)(c) and RSS-210 A2.6(a)(b)(c).

Test procedure:

ANSI C63.4-2003

Two configurations were investigated in modes A and B: the case where the EUT is attached to a test jig and the case where the EUT is inserted into a printer. The EUT was placed on a nonconductive turntable 0.8m above the ground plane in the configuration with test jig. It was tested as a floor standing unit in the configuration with printer. Precheck measurements showed that the configuration in which the EUT is attached to the test jig corresponds to the worst case and final measurement was performed in this configuration in modes A and B.

Before final measurements of radiated emissions were performed, the EUT was scanned to determine its emission spectrum profile. The physical arrangement of the test system, the associated cabling and the EUT orientation (X, Y, Z) were varied in order to ensure that maximum emission amplitudes were attained. The supplying voltage was additionally varied with $\pm 15\%$ of the normal voltage to achieve worst case conditions (test voltages: DC 2.805, 3.3 and 3.795V).

Final radiated emission measurements were performed with a loop antenna at 3m distance. At each measured frequency, the EUT was rotated 360° and the loop antenna was rotated around its axis in order to determine the emission's maximum level.

For frequencies between 10MHz and 30MHz, the spectrum analyzer's 6 dB bandwidth was set to 9 kHz, and the analyzer was operated in the CISPR quasi-peak detection mode.

The highest emission amplitudes relative to the appropriate limit are recorded in this report. The 30m limits were extrapolated to a 3m distance using a 40dB correction factor.

Table 18: Fundamental Emission, Mode A

Freq. [MHz]	EUT Orientation	Reading QP [dBuV]	Factor [dB(1/m)]	Field QP [dBuV/m]	Limit QP [dBuV/m]	Margin [dB]	Test Voltage [V]
13.560	Y	22.1	20.3	42.4	124.0	81.6	3.795

Note: Field QP = Reading QP + Factor

Table 19: Fundamental Emission, Mode B

Freq. [MHz]	EUT Orientation	Reading QP [dBuV]	Factor [dB(1/m)]	Field QP [dBuV/m]	Limit QP [dBuV/m]	Margin [dB]	Test Voltage [V]
13.560	Y	21.2	20.3	41.5	124.0	82.5	3.795

Note: Field QP = Reading QP + Factor

Table 20: In-band Radiated Emission, Mode A

Freq. [MHz]	EUT Orientation	Reading QP [dBuV]	Factor [dB(1/m)]	Field QP [dBuV/m]	Limit QP [dBuV/m]	Margin [dB]	Test Voltage [V]
13.110	Y	6.5	20.3	26.8	69.5	42.7	3.795
13.410	Y	6.4	20.3	26.7	80.5	53.8	3.795
13.553	Y	9.9	20.3	30.2	90.5	60.3	3.795
13.567	Y	10.9	20.3	31.2	90.5	59.3	3.795
13.710	Y	6.2	20.3	26.5	80.5	54.0	3.795
14.010	Y	6.2	20.4	26.5	69.5	43.0	3.795

Note: Field QP = Reading QP + Factor

Table 21: In-band Radiated Emission, Mode B

Freq. [MHz]	EUT Orientation	Reading QP [dBuV]	Factor [dB(1/m)]	Field QP [dBuV/m]	Limit QP [dBuV/m]	Margin [dB]	Test Voltage [V]
13.110	Y	5.4	20.3	25.7	69.5	43.8	3.795
13.410	Y	5.3	20.3	25.6	80.5	54.9	3.795
13.553	Y	8.4	20.3	28.7	90.5	61.8	3.795
13.567	Y	9.3	20.3	29.6	90.5	60.9	3.795
13.710	Y	5.3	20.3	25.6	80.5	54.9	3.795
14.010	Y	5.3	20.4	25.6	69.5	43.9	3.795

Note: Field QP = Reading QP + Factor

6.1.4 Out-of-Band Radiated Spurious Emission of Transmitter below 30MHz, FCC 15.225(d), FCC 15.209, RSS-210 A2.6(d) and RSS-210 2.6

RESULT: **PASS**

Date of testing: 2010-09-28, 2010-09-29, 2010-11-18

Ambient temperature: 25, 24, 22°C

Relative humidity: 62, 41, 43%

Atmospheric pressure: 1004, 1011, 1015hPa

Frequency range: 9kHz – 30MHz

Measurement distance: 3m

Kind of test site: Semi Anechoic Chamber

Requirements:

The emissions from the intentional radiator shall not exceed the field strength specified in FCC 15.209(a), RSS-210 A2.6(d) and RSS-210 2.7.

Test procedure:

ANSI C63.4-2003 and RSS-Gen 4.9.

Two configurations were investigated in modes A and B: the case where the EUT is attached to a test jig and the case where the EUT is inserted into a printer. The EUT was placed on a nonconductive turntable 0.8m above the ground plane in the configuration with test jig. It was tested as a floor standing unit in the configuration with printer. Precheck measurements showed that the configuration in which the EUT is attached to the test jig corresponds to the worst case and final measurement was performed in this configuration.

Before final measurements of radiated emissions were performed, the EUT was scanned to determine its emission spectrum profile. The physical arrangement of the test system, the associated cabling and the EUT orientation (X, Y, Z) were varied in order to ensure that maximum emission amplitudes were attained.

The spectrum was examined from 9kHz to 30MHz. Final radiated emission measurements were performed with a loop antenna at 3m distance. At each measured frequency, the EUT was rotated 360° and the loop antenna was rotated around its axis in order to determine the emission's maximum level.

The spectrum analyzer was operated in the CISPR quasi-peak detection mode. For frequencies between 9kHz and 150kHz, the spectrum analyzer's 6 dB bandwidth was set to 200Hz. For frequencies between 150kHz and 30MHz, the spectrum analyzer's 6 dB bandwidth was set to 9kHz.

The highest emission amplitudes relative to the appropriate limit are recorded in this report for the worst case operation mode (mode A). The 30m limit was extrapolated to a

3m distance using a 40dB correction factor. Emissions other than those mentioned are small or not detectable.

Table 22: Radiated Emission, Quasi-Peak Data, 9kHz – 30MHz, Mode A

Frequency [MHz]	EUT Orientation	Reading QP [dBuV]	Factor [dB(1/m)]	Level QP [dBuV/m]	Limit QP [dBuV/m]	Margin [dB]
27.12	Y	4.4	21.9	26.3	69.5	43.2

Note: Level QP = Reading QP + Factor

6.1.5 Radiated Spurious Emission of Transmitter above 30MHz, FCC 15.225(d), FCC 15.209, RSS-210 A2.6(d) and RSS-210 2.6

RESULT: **PASS**

Date of testing: 2010-09-28, 2010-09-29, 2010-11-18

Ambient temperature: 25, 24, 22°C

Relative humidity: 62, 41, 43%

Atmospheric pressure: 1004, 1011, 1015hPa

Frequency range: 30MHz – 136MHz

Measurement distance: 3m

Kind of test site: Semi Anechoic Chamber

Requirements:

The emissions from the intentional radiator shall not exceed the field strength specified in FCC 15.209(a), RSS-210 A2.6(d) and RSS-210 2.7.

Test procedure:

ANSI C63.4-2003 and RSS-Gen 4.9.

Two configurations were investigated in modes A and B: the case where the EUT is attached to a test jig and the case where the EUT is inserted into a printer. The EUT was placed on a nonconductive turntable 0.8m above the ground plane in the configuration with test jig. It was tested as a floor standing unit in the configuration with printer. Final measurements were performed in both configurations.

Before final measurements of radiated emissions were performed, the EUT was scanned to determine its emission spectrum profile. The physical arrangement of the test system and the associated cabling were varied in order to ensure that maximum emission amplitudes were attained. In the configuration with the test jig, the EUT orientation (X, Y, Z) was additionally varied to achieve worst case conditions.

The spectrum was examined from 30MHz to the 10th harmonic of the fundamental transmitter frequency (136MHz). Final radiated emission measurements were made at 3m distance.

At each frequency where a spurious emission was found, the EUT was rotated 360° and the antenna was raised and lowered from 1 to 4m in order to determine the emission's maximum level. Measurements were taken using both horizontal and vertical antenna polarizations.

The spectrum analyzer's 6 dB bandwidth was set to 120 kHz and the analyzer was operated in the CISPR quasi-peak detection mode.

Produkte
 Products

Prüfbericht - Nr.: 12607853 001

Seite 28 von 34

Test Report No.:

Page 28 of 34

The highest emission amplitudes relative to the appropriate limit were recorded in this report for the worst case operation mode (mode A for configuration with test jig). Emissions other than those mentioned are small or not detectable.

Table 23: Radiated Emission, Quasi Peak Data, 30MHz – 136MHz, Horizontal and Vertical Antenna Orientations, Configuration with Test Jig, Mode A

Freq. [MHz]	EUT / Antenna Orientation	Reading QP [dBµV]	Factor [dB(1/m)]	Level QP [dBµV/m]	Limit [dBµV/m]	Margin QP [dB]	Height [cm]	Angle [°]
32.03	Y / H	45.6	-24.3	21.3	40.0	18.7	101	359
50.28	Y / H	34.6	-22.9	11.7	40.0	28.3	396	56

Note: Level QP = Reading QP + Factor

Table 24: Radiated Emission, Quasi Peak Data, 30MHz – 136MHz, Horizontal and Vertical Antenna Orientations, Configuration with Printer, Modes A & B

Freq. [MHz]	EUT Orientation	Reading QP [dBµV]	Factor [dB(1/m)]	Level QP [dBµV/m]	Limit [dBµV/m]	Margin QP [dB]	Height [cm]	Angle [°]
69.859	V	60.4	-27.3	33.1	40.0	6.9	100	52
87.352	V	59.5	-26.5	33.0	40.0	7.0	145	272
98.463	H	60.5	-26.1	34.4	43.5	9.1	228	194
122.251	V	61.3	-24.5	36.8	43.5	6.7	100	85

Note: Level QP = Reading QP + Factor

6.2 Radiated Emission of Receiver

6.2.1 Radiated Spurious Emission of Receiver, RSS-210 2.6 and RSS-Gen 7.2.3.2

RESULT: N/A

Requirements:

The emissions from the unintentional radiator shall not exceed the field strength specified in RSS-210 Table 2 (and RSS-Gen Table 1).

Test procedure:

ANSI C63.4-2003 and RSS-Gen 4.10

The test was not performed, since the EUT has no receiver-only mode. Refer to the data for the radiated spurious emission of transmitter for the measurement results of the combined operation of transmitter and receiver.

7. Test Results of AC Power Line Conducted Measurements

7.1 AC Power Line Conducted Emission of Transmitter

7.1.1 AC Power Line Conducted Emission of Transmitter, FCC 15.207 and RSS-Gen 7.2.2

RESULT: **PASS**

Date of testing: 2010-09-30, 2010-11-17

Ambient temperature: 25, 24°C

Relative humidity: 61, 32%

Atmospheric pressure: 1015, 1016hPa

Frequency range: 0.15 – 30MHz

Kind of test site: Shielded Room

Requirements:

The AC power line conducted emission on any frequency within the band 150 kHz to 30MHz shall not exceed the limits specified in FCC 15.207 and RSS-Gen 7.2.2.

Test procedure:

ANSI C63.4-2003.

Two configurations were investigated in modes A and B: the case where the EUT is attached to a test jig and the case where the EUT is inserted into a printer. The EUT was placed on a wooden table 0.8m above the ground plane in the configuration with test jig. It was tested as a floor standing unit in the configuration with printer. A vertical conducting plane of the screened room was located 40cm to the rear of the EUT in the configuration with test jig. The AC input of the EUT was connected to a Line Impedance Stabilization Network (LISN). Final measurements were performed in both configurations.

The physical arrangement of the test system and associated cabling was varied to determine the effect on the EUT's emissions in amplitude and frequency in order to ensure that maximum emission amplitudes were attained.

The measurements were performed with the spectrum analyzer operating in the CISPR quasi-peak and average detection modes. The analyzer's 6 dB bandwidth was set to 9kHz. No video filter less than 10 times the resolution bandwidth was used.

The highest emission amplitudes relative to the appropriate limit were recorded in this report for the worst case operation mode (mode B for configuration with test jig). Emissions other than those mentioned are small or not detectable.

Table 25: AC Power Line Conducted Emission, Quasi Peak and Average Data, 0.15 - 30MHz, Phase N (N) and L1 (L), Configuration with Test Jig, Mode B

Freq. [MHz]	Phase	Reading QP [dBµV]	Reading AV [dBµV]	Factor [dB]	Level QP [dBµV]	Level AV [dBµV]	Limit QP [dBµV]	Limit AV [dBµV]	Margin QP [dB]	Margin AV [dB]
0.15068	N	36.3	11.7	9.6	45.9	21.3	66.0	56.0	20.1	34.7
0.15097	L1	36.5	11.8	9.6	46.1	21.4	65.9	55.9	19.8	34.5
0.15776	L1	35.4	11.4	9.6	45.0	21.0	65.6	55.6	20.6	34.6
0.17037	N	33.5	10.4	9.6	43.1	20.0	64.9	54.9	21.8	34.9
0.17661	N	32.4	10.0	9.6	42.0	19.6	64.6	54.6	22.6	35.0
0.28702	N	35.0	34.5	9.7	44.7	44.2	60.6	50.6	15.9	6.4
0.28615	L1	25.8	19.4	9.7	35.5	29.1	60.6	50.6	25.1	21.5
0.56884	N	26.0	23.0	9.7	35.7	32.7	56.0	46.0	20.3	13.3
0.57680	L1	23.5	20.2	9.7	33.2	29.9	56.0	46.0	22.8	16.1
0.86515	N	19.4	15.7	9.7	29.1	25.4	56.0	46.0	26.9	20.6
2.59392	N	19.5	15.1	9.8	29.3	24.9	56.0	46.0	26.7	21.1
3.41892	L1	20.9	16.7	9.8	30.7	26.5	56.0	46.0	25.3	19.5
3.70351	N	22.3	17.2	9.8	32.1	27.0	56.0	46.0	23.9	19.0
3.70396	L1	21.5	17.2	9.8	31.3	27.0	56.0	46.0	24.7	19.0
13.56041	N	43.1	31.1	10.1	53.2	41.2	60.0	50.0	6.8	8.8
13.56001	L1	42.7	30.7	10.1	52.8	40.8	60.0	50.0	7.2	9.2
18.37397	N	18.8	-2.4	10.3	29.1	7.9	60.0	50.0	30.9	42.1
19.42768	L1	18.9	-2.4	10.2	29.1	7.8	60.0	50.0	30.9	42.2
21.24365	N	20.4	-2.3	10.3	30.7	8.0	60.0	50.0	29.3	42.0

Note: Level QP = Reading QP + Factor, Level AV = Reading AV + Factor

Table 26: AC Power Line Conducted Emission, Quasi Peak and Average Data, 0.15 - 30MHz, Phase N (N) and L1 (L), Configuration with Printer, Modes A & B

Freq. [MHz]	Phase	Reading QP [dBµV]	Reading AV [dBµV]	Factor [dB]	Level QP [dBµV]	Level AV [dBµV]	Limit QP [dBµV]	Limit AV [dBµV]	Margin QP [dB]	Margin AV [dB]
0.30893	N	27.4	21.7	9.7	37.1	31.4	60.0	50.0	22.9	18.6
0.30954	L1	27.2	22.3	9.7	36.9	32.0	60.0	50.0	23.1	18.0
2.12313	L1	26.2	25.6	9.8	36.0	35.4	56.0	46.0	20.0	10.6
2.12457	N	26.5	25.4	9.8	36.3	35.2	56.0	46.0	19.7	10.8
4.48346	N	25.8	23.8	9.8	35.6	33.6	56.0	46.0	20.4	12.4
5.15356	N	25.4	23.6	9.9	35.3	33.5	60.0	50.0	24.7	16.5
7.42548	N	27.6	19.7	10.0	37.6	29.7	60.0	50.0	22.4	20.3
7.54606	L1	30.2	22.0	10.0	40.2	32.0	60.0	50.0	19.8	18.0
8.87774	N	29.2	22.3	10.0	39.2	32.3	60.0	50.0	20.8	17.7
9.09149	L1	37.5	28.5	10.1	47.6	38.6	60.0	50.0	12.4	11.4
9.32168	N	35.6	30.9	10.1	45.7	41.0	60.0	50.0	14.3	9.0
9.79534	L1	35.5	29.8	10.1	45.6	39.9	60.0	50.0	14.4	10.1
10.38558	N	34.7	29.0	10.1	44.8	39.1	60.0	50.0	15.2	10.9
10.62291	L1	34.1	29.5	10.1	44.2	39.6	60.0	50.0	15.8	10.4
13.56000	L1	22	15.8	10.1	32.1	25.9	60.0	50.0	27.9	24.1
13.56000	N	23.9	18.0	10.1	34.0	28.1	60.0	50.0	26.0	21.9
13.56897	N	27.1	19.4	10.1	37.2	29.5	60.0	50.0	22.8	20.5
13.57202	L1	27.4	21.2	10.1	37.5	31.3	60.0	50.0	22.5	18.7
23.25625	L1	28.6	22.0	10.3	38.9	32.3	60.0	50.0	21.1	17.7
25.72868	N	31.2	24.8	10.4	41.6	35.2	60.0	50.0	18.4	14.8

Note: Level QP = Reading QP + Factor, Level AV = Reading AV + Factor

7.2 AC Power Line Conducted Emission of Receiver

7.2.1 AC Power Line Conducted Emission of Receiver, RSS-Gen 7.2.2

RESULT: N/A

Requirements:

The AC power line conducted emission on any frequency within the band 150 kHz to 30MHz shall not exceed the limits specified in RSS-Gen 7.2.2.

Test procedure:

ANSI C63.4-2003 and RSS-Gen 4.10

The test was not performed, since the EUT has no receiver-only mode. Refer to the data for the AC power line conducted emission of transmitter for the measurement results of the combined operation of transmitter and receiver.

8. Photographs of the Test Setup

Refer to the attached document: Photographs of Test Setup

9. List of Tables

Table 1: List of Test and Measurement Equipment	7
Table 2: Emission Measurement Uncertainty	8
Table 3: List of Cables used for Testing, Configuration with Test Jig	9
Table 4: List of Cables used for Testing, Configuration with Printer	10
Table 5: Frequency Stability at 50°C, DC 3.3V	17
Table 6: Frequency Stability at 40°C, DC 3.3V	17
Table 7: Frequency Stability at 30°C, DC 3.3V	17
Table 8: Frequency Stability at 20°C, DC 3.3V	17
Table 9: Frequency Stability at 10°C, DC 3.3V	17
Table 10: Frequency Stability at 0°C, DC 3.3V	18
Table 11: Frequency Stability at -10°C, DC 3.3V	18
Table 12: Frequency Stability at -20°C, DC 3.3V	18
Table 13: Frequency Stability at 20°C, DC 2.805V	18
Table 14: Frequency Stability at 20°C, DC 3.795V	18
Table 15: 20dB Bandwidth Edge Frequencies	20
Table 16: 20dB Bandwidth	20
Table 17: 99% Bandwidth, Mode A	22
Table 18: Fundamental Emission, Mode A	24
Table 19: Fundamental Emission, Mode B	24
Table 20: In-band Radiated Emission, Mode A	24
Table 21: In-band Radiated Emission, Mode B	24
Table 22: Radiated Emission, Quasi-Peak Data, 9kHz – 30MHz, Mode A	26
Table 23: Radiated Emission, Quasi Peak Data, 30MHz – 136MHz, Horizontal and Vertical Antenna Orientations, Configuration with Test Jig, Mode A	28
Table 24: Radiated Emission, Quasi Peak Data, 30MHz – 136MHz, Horizontal and Vertical Antenna Orientations, Configuration with Printer, Modes A & B	28
Table 25: AC Power Line Conducted Emission, Quasi Peak and Average Data, 0.15 - 30MHz, Phase N (N) and L1 (L), Configuration with Test Jig, Mode B	31
Table 26: AC Power Line Conducted Emission, Quasi Peak and Average Data, 0.15 - 30MHz, Phase N (N) and L1 (L), Configuration with Printer, Modes A & B	31

10. List of Figures

Figure 1: Setup for Antenna Port Conducted Measurements	12
Figure 2: Setup for Radiated and AC Power Line Conducted Emission Measurements, Configuration with Test Jig	13
Figure 3: Setup for Radiated and AC Power Line Conducted Emission Measurements, Configuration with Printer	13
Figure 4: 20dB Bandwidth	20
Figure 5: 99% Bandwidth, Mode A	22

11. Attachment: Photographs of Test Setup

10 pages following