



EMI TEST REPORT

Test Report No. : 28CE0270-YK-01-A

Applicant : OMRON Corporation
Type of Equipment : RFID system
Model No. : V680-HA63A, V680-HS51
FCC ID : E4E6CYSIDV6800406
Test Standard : FCC Part15 Subpart C: 2007
Test Result : Complied

1. This test report shall not be reproduced except in full or partial, without the written approval of UL Japan, Inc.
2. The results in this report apply only to the sample tested.
3. This sample tested is in compliance with the limits of the above regulation.
4. The test results in this test report are traceable to the national or international standards.

Date of test: November 1, 2 and 6, 2007

Tested by: A. Sato & G. Ishiwata
Akira Sato & Go Ishiwata

Approved by: O. Watatani
Osamu Watatani
Manager of Yamakita EMC Lab.

UL Japan, Inc.
YAMAKITA EMC LAB.

Table of Contents	Page
1 Applicant Information	3
2 Equipment under test (E.U.T.)	3
3 Test Specification, Procedures and Results	4
4 System Test Configuration	6
5 Conducted Emissions	7
6 Radiated Emissions (Fundamental, Spurious and Outside the Allocated bands)	8
7 20dB Bandwidth & Occupied Bandwidth (99%)	9
8 Frequency Tolerance	9
<u>Contents of Appendixes</u>	10
APPENDIX 1: Photographs of test setup	11
APPENDIX 2: Test Data	15
APPENDIX 3: Test instruments	25

1 Applicant Information

Company Name : OMRON Corporation
Address : 3-2 Narutani, Nakayama-cho, Ayabe-shi, Kyoto-fu, 623-0105 JAPAN
Telephone Number : +81-773-42-6662
Facsimile Number : +81-773-42-6135
Contact Person : Shuichi Matsui

2 Equipment under test (E.U.T.)

2.1 Identification of E.U.T.

Type of Equipment : RFID system
Model No. : V680-HA63A (Amplifier), V680-HS51 (Antenna)
Serial No. : V680-HA63A: 30X06V, V680-HS51: -
Rating : DC7.5V
Country of Manufacture : Japan
Receipt Date of Sample : November 1, 2007
Condition of EUT : Engineering prototype
(Not for Sale: This sample is equivalent to mass-produced items.)
Modification of EUT : No modification by the test lab.

2.2 Product Description

Model: V680-HA63A / V680-HS51 is an Amplifier / Antenna of RFID system.

Equipment type : Transceiver
Frequency of operation : 13.56 MHz
Clock frequency : 12MHz (USB), 16MHz (CPU)
Type of modulation : ASK
Antenna model & type : V680-HS51, Loop coil antenna
Antenna connector type : BNC
ITU code : A1D
Operation temperature range : -10 ~ +55 deg. C. (Amplifier)
-10 ~ +60 deg. C. (Antenna)

*FCC Part15.31 (e)

The ID Controller provides the Amplifier with stable power supply and the equipment complies power supply regulation.

*FCC Part15.203

The EUT has an external and particular antenna connector, but it is installed by the professionals.
Therefore, the equipment complies with the antenna requirement of Section 15.203.

UL Japan, Inc.
YAMAKITA EMC LAB.

3 Test Specification, Procedures and Results

3.1 Test specification

Test specification : FCC Part15 Subpart C: 2006
 Title : FCC 47CFR Part15 Radio Frequency Device Subpart C Intentional Radiators
 Section 15.207: Conducted limits
 Section 15.209: Radiated emission limits, general requirements
 Section 15.215: Additional provisions to the general radiated emission limitations
 Section 15.225: Operation within the band 13.110-14.010MHz

3.2 Procedures & Results

Item	Test Procedure	Specification	Remarks	Deviation	Worst Margin	Results
Conducted Emission	ANSI C63.4: 2003 7. AC powerline conducted emission measurements	Section 15.207	-	N/A	5.9dB (0.3801MHz, L1, AV)	Complied
Electric Field Strength of Fundamental Emission	ANSI C63.4: 2003 13. Measurement of intentional radiators	Section 15.225 (a)	Radiated	N/A	71.9dB (Vertical)	Complied
Electric Field Strength of Outside the Allocated bands	ANSI C63.4: 2003 13. Measurement of intentional radiators	Section 15.225 (b) (c)	Radiated	N/A	46.0dB (13.110MHz, Vertical)	Complied
Electric Field Strength of Spurious Emission	ANSI C63.4: 2003 13. Measurement of intentional radiators	Section 15.209, Section 15.225 (d)	Radiated	N/A	3.4dB (61.01MHz, Vertical)	Complied
20dB Bandwidth	ANSI C63.4: 2003 13. Measurement of intentional radiators	Section 15.215(c)	Radiated	N/A	-	Complied
Frequency Tolerance	ANSI C63.4: 2003 13. Measurement of intentional radiators	Section 15.225 (e)	Radiated	N/A	-	Complied

* Other than mentioned in 3.3, no addition, exclusion nor deviation has been made from the standard.

3.3 Addition to standard

Item	Test Procedure	Specification	Remarks	Worst Margin	Results
Occupied Bandwidth (99%)	ANSI C63.4:2003 13. Measurement of intentional radiators RSS-Gen 4.6.1	RSS-Gen 4.6.1	Radiated	-	Complied

UL Japan, Inc.
YAMAKITA EMC LAB.

3.4 Uncertainty

The following uncertainties have been calculated to provide a confidence level of 95% using a coverage factor k=2.

	No.1 open site	No.2 open site	No.1 anechoic chamber
Conducted emission			
150kHz-30MHz	2.8 dB	2.8 dB	2.8 dB
Radiated emission (3m)			
<30MHz	2.3 dB	2.3 dB	2.2 dB
30-300MHz	4.5 dB	4.4 dB	4.5 dB
300-1000MHz	4.3 dB	4.3 dB	4.3 dB

Frequency tolerance	
	±0.000014MHz

Conducted Emission Test

The data listed in this test report has enough margin, more than site margin.

Radiated Emission Test

The data listed in this report meets the limits unless the uncertainty is taken into consideration.

3.5 Test Location

UL Japan, Inc. Yamakita EMC Lab.
 907, Kawanishi, Yamakita-machi, Ashigarakami-gun, Kanagawa-ken 258-0124 JAPAN
 Telephone number : +81 465 77 1011
 Facsimile number : +81 465 77 2112
 NVLAP Lab. code : 200441-0

No. 1 test site has been fully described in a report submitted to FCC office, and accepted on August 26, 2005 (Registration No.: 95486).

IC Registration No. : 2973B-1

No. 2 test site has been fully described in a report submitted to FCC office, and accepted on April 4, 2005 (Registration No.: 466226).

IC Registration No. : 2973B-3

No. 1 anechoic chamber has been fully described in a report submitted to FCC office, and accepted on November 2, 2005 (Registration No.: 95967).

IC Registration No. : 2973B-2

Test room	Width x Depth x Height (m)	Test room	Width x Depth x Height (m)
No.1 shielded room	8.0 x 5.0 x 2.5	No.1 Semi-anechoic chamber	10.0 x 7.5 x 5.7
No.2 shielded room	5.0 x 4.0 x 2.5		
No.3 shielded room	4.0 x 5.0 x 2.7		

3.6 Test Setup, Data of EMI & Test instruments

Refer to Appendix 1 to 3.

UL Japan, Inc.
YAMAKITA EMC LAB.

4 System Test Configuration

4.1 Justification

The EUT exercise program used during testing was designed to exercise the various system components in a manner similar to typical use.

Operation: Transmitting (13.56MHz)

Justification: The system was configured in typical fashion (as a customer would normally use it) for testing.

4.2 Configuration of Tested System

■: Ferrite core (Standard attachment)

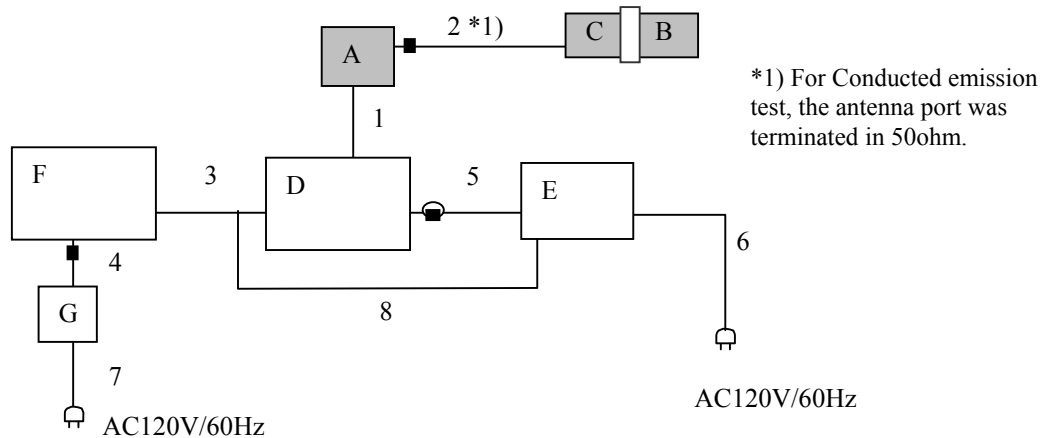

* Test data was taken under worst case conditions.

Description of EUT and support equipment

No.	Item	Model number	Serial number	Manufacturer	FCC ID (Remarks)
A	Amplifier	V680-HA63A	30X06V	Omron	E4E6CYSIDV6800406 (EUT)
B	RFID Tag	V680-D1KP52MT	28207V	Omron	(EUT)
C	Antenna	V680-HS51	-	Omron	(EUT)
D	ID Controller	V680-CA5D01	27Y06V	Omron	-
E	Power Supply	S8VS-03024	18460M	Omron	-
F	Personal Computer	2655-86J	97-630VG 07/01	IBM	(D.o.C.)
G	AC Adaptor	02K6665	11S02K6665Z1 Z2U81409EF	IBM	-

List of cables used

No.	Name	Length (m)	Shield		Remark
			Connector	Cable	
1	Amplifier cable	5.0	Shielded	Shielded	-
2	Antenna cable	2.0	Shielded	Shielded	-
3	RS232C cable	15.0	Shielded	Shielded	-
4	DC power cable	1.8	Unshielded	Unshielded	-
5	DC power cable	0.8	Unshielded	Unshielded	-
6	AC power cable	1.7	Unshielded	Unshielded	-
7	AC power cable	1.0	Unshielded	Unshielded	-
8	Ground cable	1.2	Unshielded	Unshielded	-

UL Japan, Inc.
YAMAKITA EMC LAB.

5 Conducted Emissions

5.1 Operating environment

The test was carried out in No.3 shielded room.

Temperature : See test data
Humidity : See test data

5.2 Test configuration

EUT was placed on a wooden platform of nominal size, 1m by 1.8m, raised 80cm above the conducting ground plane. The rear of tabletop was located 40cm to the vertical conducting plane. EUT was located 80cm from LISN and excess AC cable was bundled in center. The rear of EUT, including peripherals was aligned and was flushed with rear of tabletop. All other surfaces of tabletop were at least 80cm from any other grounded conducting surface. A drawing of the set up is shown in the photos of Appendix 1.

5.3 Test conditions

Frequency range : 0.15 - 30MHz
EUT position : Table top
EUT operation mode : Transmitting

5.4 Test procedure

The EUT was connected to a LISN (AMN).
An overview sweep with peak detection has been performed.
The Conducted emission measurements were made with the following detector function of the test receiver.
Detector: QP/AV
IF Bandwidth: 10kHz

5.5 Results

Summary of the test results : Pass

Date : November 2, 2007 Test engineer : Akira Sato

6 Radiated Emissions (Fundamental, Spurious and Outside the Allocated bands)

6.1 Operating environment

The test was carried out in No.1 anechoic chamber.

Temperature : See test data
 Humidity : See test data

6.2 Test configuration

EUT was placed on a urethane platform of nominal size, 0.5m by 0.5m, raised 80cm above the conducting ground plane. A drawing of the set up is shown in the photos of Appendix 1.

6.3 Test conditions

Frequency range : 9kHz - 1GHz
 EUT position : Table top
 EUT operation mode : Transmitting

6.4 Test procedure

The Radiated Electric Field Strength intensity has been measured with a ground plane and at a distance of 3m.

Frequency: From 9kHz to 30MHz at distance 3m

The EUT was rotated a full revolution in order to obtain the maximum value of the electric field intensity. The measurements were performed for each antenna angle 0deg., 45deg. and 90deg.

Frequency: From 30MHz to 1GHz at distance 3m

The measuring antenna height was varied between 1 and 4m and EUT was rotated a full revolution in order to obtain the maximum value of the electric field intensity.

The measurements were performed for both vertical and horizontal antenna polarization.

Measurements were performed with QP, PK, and AV detector.

The radiated emission measurements were made with the following detector function of the test receiver.

	9kHz to 90kHz & 110kHz to 150kHz	90kHz to 110kHz	150kHz to 490kHz	490kHz to 30MHz	30MHz to 1GHz
Detector Type	PK/AV	QP	PK/AV	QP	QP
IF Bandwidth	200Hz	200Hz	9kHz	9kHz	120kHz
Measuring antenna	Loop antenna				Biconical (30-299.99MHz) Logperiodic (300MHz-1GHz)

The EUT and its antennas were previously checked at each position of three or two axes. The position in which the maximum noise occurred was chosen to put into measurement. See the table and photographs in page 13 to 14. With the position, the noise levels of all the frequencies were measured.

* Part 15 Section 15.31 (f)(2) (9kHz-30MHz)

9kHz – 490kHz [Limit at 3m]= [Limit at 300m]-40log (3[m]/300[m])

490kHz – 30MHz [Limit at 3m]= [Limit at 30m]-40log (3[m]/30[m])

6.5 Results

Summary of the test results : Pass

Date : November 6, 2007

Test engineer : Go Ishiwata

UL Japan, Inc.
YAMAKITA EMC LAB.

7 20dB Bandwidth & Occupied Bandwidth (99%)

Test Procedure

The measurement was performed in the antenna height to gain the maximum of Electric field strength.

Summary of the test results: Pass

Date : November 2, 2007 Test engineer : Go Ishiwata

8 Frequency Tolerance

Test Procedure

The measurement was performed in the antenna height to gain the maximum of Electric field strength.
The temperature test was started after the temperature stabilization time of 30 minutes.

Summary of the test results: Pass

Date : November 1, 2007 Test engineer : Go Ishiwata

APPENDIX 1: Photographs of test setup

Page 11	:	Conducted emission
Page 12	:	Radiated emission
Page 13 - 14	:	Pre-check of the worst position

APPENDIX 2: Test Data

Page 15 - 17	:	Conducted Emission
Page 18 - 20	:	Radiated Emission
18	:	Fundamental and Outside the Allocated bands
19-20	:	Spurious emission
Page 21	:	Bandwidth
Page 22 - 24	:	Frequency Tolerance

APPENDIX 3: Test instruments

Page 25	:	Test instruments
---------	---	------------------

Conducted emission

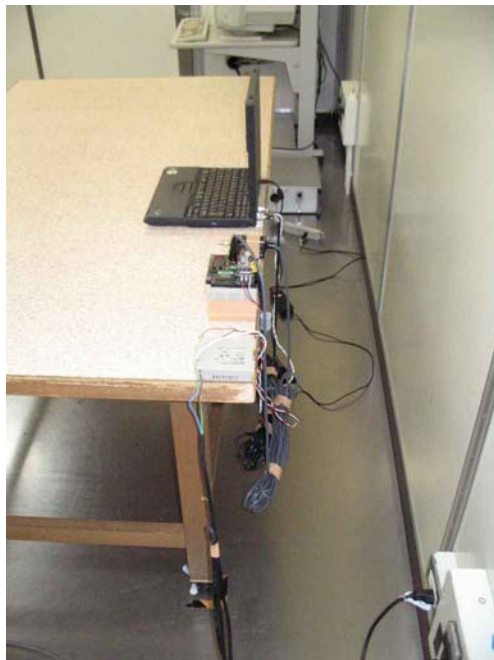
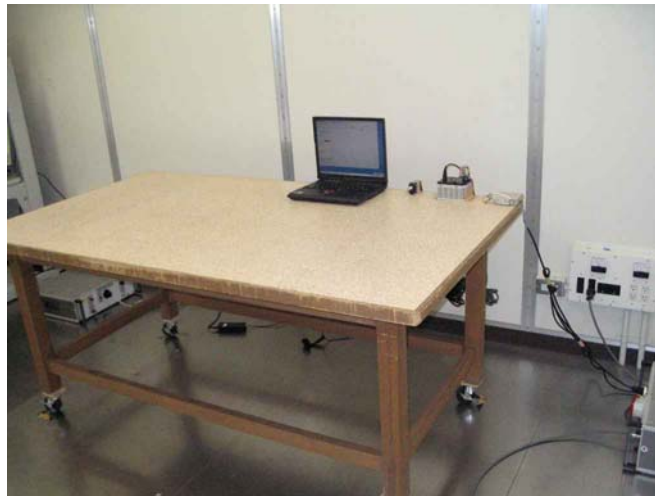

UL Japan, Inc.
YAMAKITA EMC LAB.

907 Kawanishi, Yamakita-machi, Ashigarakami-gun, Kanagawa-ken, 258-0124 JAPAN
Telephone: +81 465 77 1011 Facsimile: +81 465 77 2112

MF060b (18.06.07)

Radiated emission

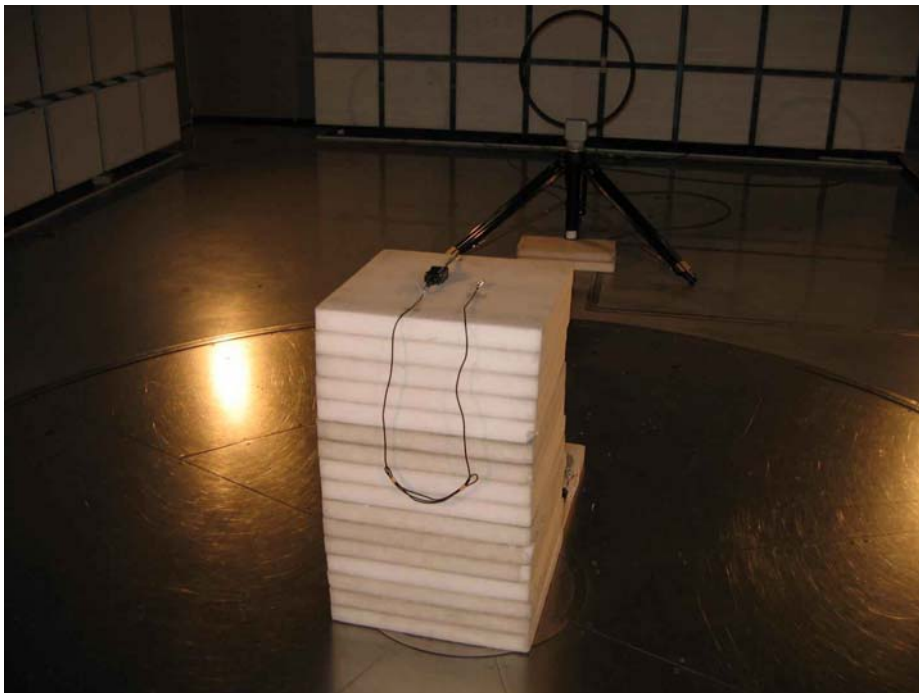
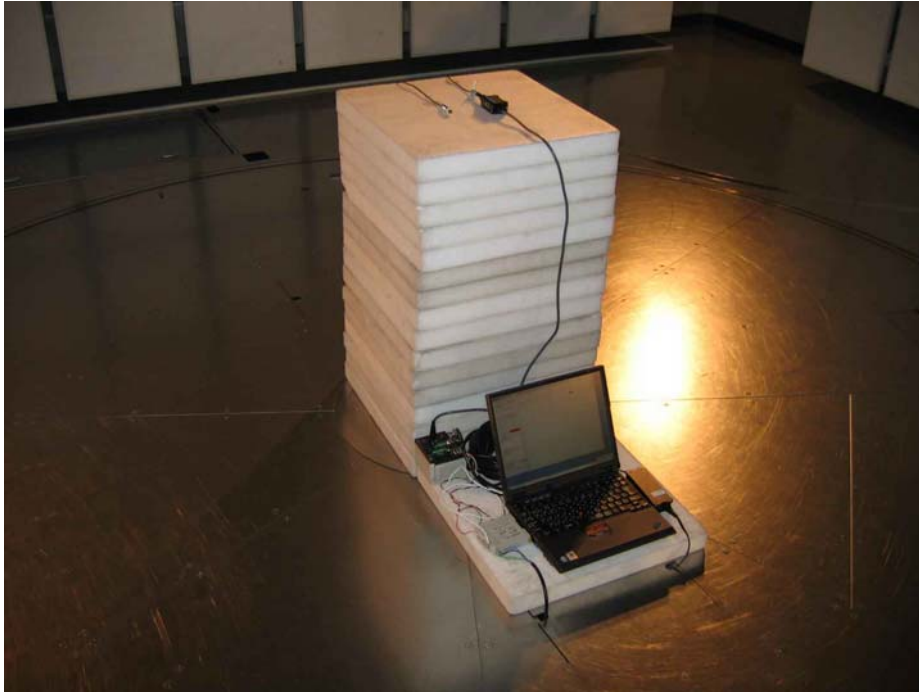

UL Japan, Inc.
YAMAKITA EMC LAB.

907 Kawanishi, Yamakita-machi, Ashigarakami-gun, Kanagawa-ken, 258-0124 JAPAN
Telephone: +81 465 77 1011 Facsimile: +81 465 77 2112

MF060b (18.06.07)

Pre-check of the worst position (Amplifier)



UL Japan, Inc.
YAMAKITA EMC LAB.

907 Kawanishi, Yamakita-machi, Ashigarakami-gun, Kanagawa-ken, 258-0124 JAPAN
Telephone: +81 465 77 1011 Facsimile: +81 465 77 2112

MF060b (18.06.07)

Pre-check of the worst position (Antenna)



Worst-case combination

	Amplifier	Antenna
Horizontal	X	X
Vertical	X	Y

UL Japan, Inc.
YAMAKITA EMC LAB.

DATA OF CONDUCTION TEST

UL Japan, Inc.
YAMAKITA No.3 SHIELD ROOM
Report No. : 28CE0270-YK-01-A

Applicant : OMRON Corporation
Kind of Equipment : RFID System
Model No. : V680-HA63A/V680-HS51
Serial No. : 30X06V/-
Power : AC120V/60Hz
Mode : Transmitting Mode(13.56MHz)
Remarks :
Date : 11/2/2007
Phase : Single Phase
Temperature : 21 °C Engineer : Akira Sato
Humidity : 55 %
Regulation : FCC Part15C § 15.207. (CISPR Pub.22)

No.	FREQ. [MHz]	READING(N)		READING(L1)		LISN FACTOR [dB]	CABLE LOSS [dB]	ATTEN. [dB]	RESULT		LIMITS		MARGIN	
		QP [dB μV]	AV [dB μV]	QP [dB μV]	AV [dB μV]				QP [dB]	AV [dB μV]	QP [dB μV]	AV [dB μV]	QP [dB]	AV [dB]
1.	0.1919	47.6	38.7	48.5	40.6	0.1	0.1	0.0	48.7	40.8	64.0	54.0	15.3	13.2
2.	0.2588	39.2	-	41.7	-	0.1	0.1	0.0	41.9	-	61.5	51.5	19.6	-
3.	0.3801	48.2	41.4	49.3	42.1	0.1	0.2	0.0	49.6	42.4	58.3	48.3	8.7	5.9
4.	0.6380	34.3	-	35.9	-	0.1	0.2	0.0	36.2	-	56.0	46.0	19.8	-
5.	1.7216	29.3	-	29.5	-	0.1	0.3	0.0	29.9	-	56.0	46.0	26.1	-
6.	13.5592	33.4	-	33.1	-	0.8	1.4	0.0	35.6	-	60.0	50.0	24.4	-
7.	23.1587	40.9	28.7	41.0	28.6	1.2	1.9	0.0	44.1	31.8	60.0	50.0	15.9	18.2
8.	27.2926	38.8	-	39.7	-	1.3	2.1	0.0	43.1	-	60.0	50.0	16.9	-

CALCULATION: READING + LISN FACTOR + CABLE LOSS + ATTEN.

■ LISN:KLS-05(NSLK8126) ■ COAXIAL CABLE:KCC-24/25/26/28
■ PULSE LIMITER:KPL-02 ■ EMI RECEIVER:KTR-03(ESHS10)

DATA OF CONDUCTION TEST

UL Japan, Inc.
YAMAKITA No.3 SHIELD ROOM
Report No. : 28CE0270-YK-01-A

Applicant : OMRON Corporation
Kind of Equipment : RFID System
Model No. : V680-HA63A/V680-HS51
Serial No. : 30X06V/-
Power : AC120V/60Hz
Mode : Transmitting Mode (13.56MHz)
Remarks :
Date : 11/2/2007
Phase : Single Phase
Temperature : 21 °C
Humidity : 55 %
Regulation : FCC Part15C § 15.207. (CISPR Pub.22)

Engineer : Akira Sato

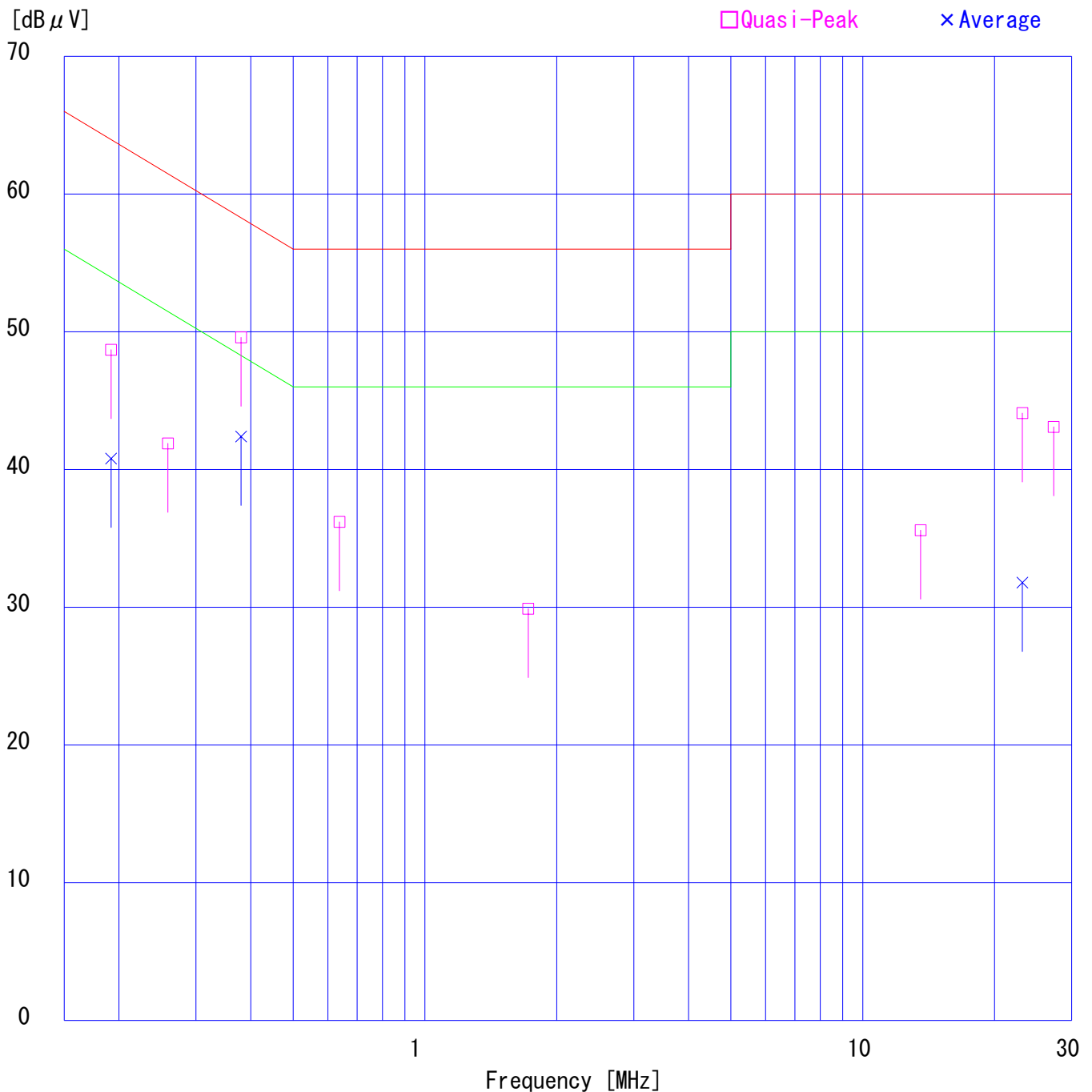

DATA OF CONDUCTION TEST CHART

UL Japan, Inc.
YAMAKITA No.3 SHIELD ROOM
Report No. : 28CE0270-YK-01-A

Applicant : OMRON Corporation
Kind of Equipment : RFID System
Model No. : V680-HA63A/V680-HS51
Serial No. : 30X06V/-
Power : AC120V/60Hz
Mode : Transmitting Mode (13.56MHz)
Remarks :
Date : 11/2/2007
Phase : Single Phase
Temperature : 21 °C
Humidity : 55 %
Regulation 1 : FCC Part15C § 15.207. (CISPR Pub.22)
Regulation 2 : None
Engineer : Akira Sato

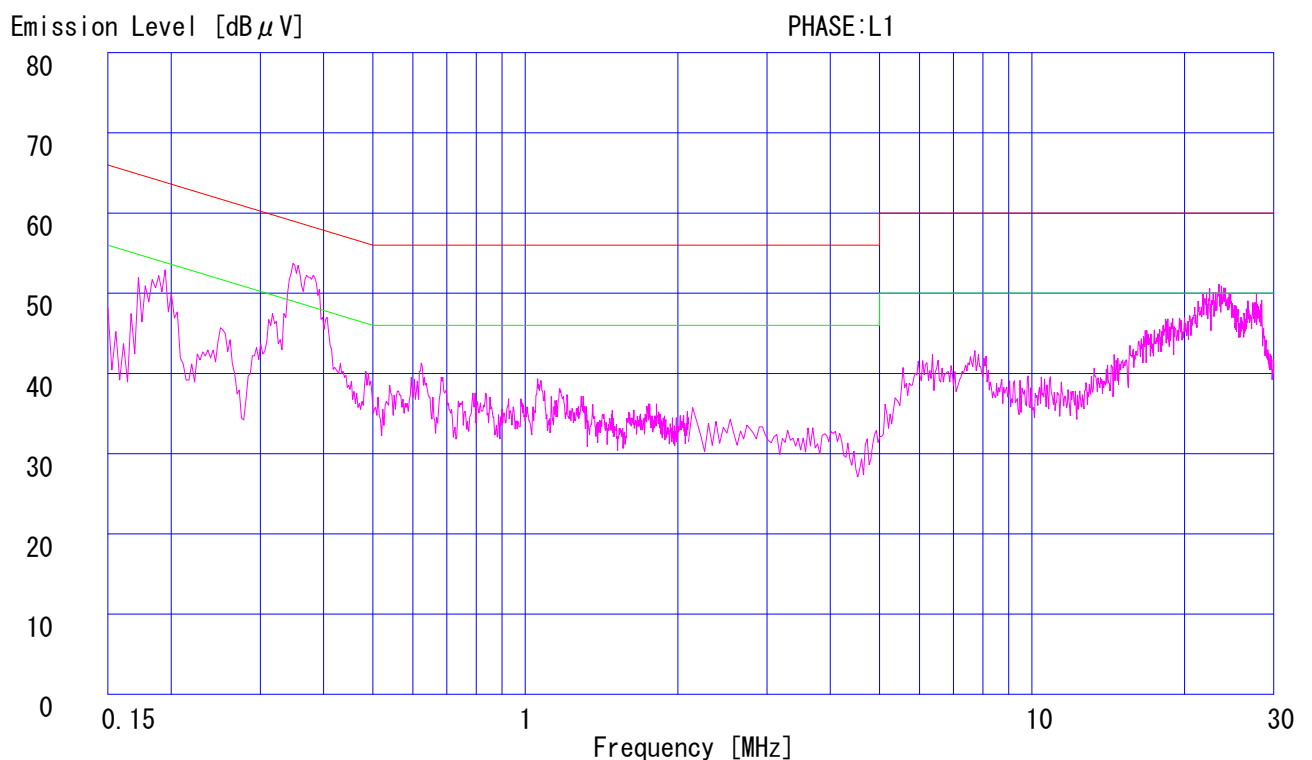
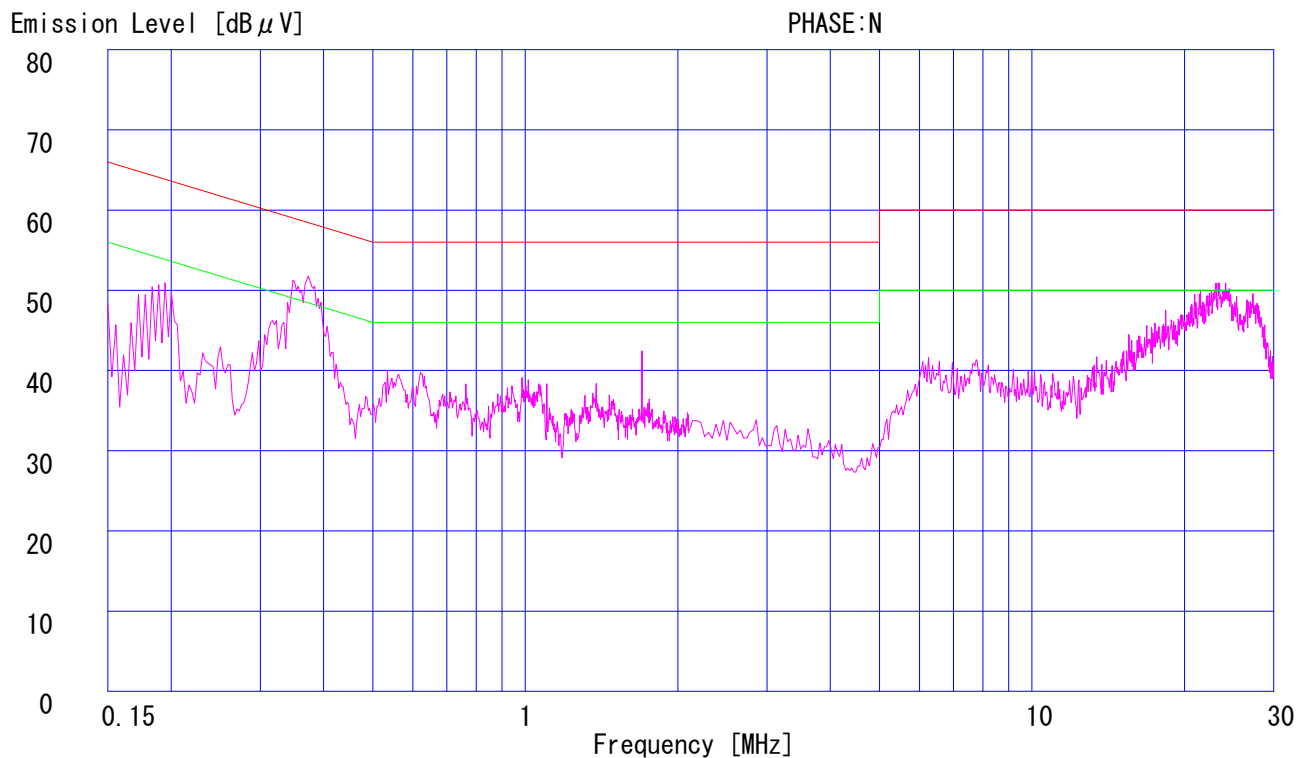

Data of Field Strength and Outside Filed Strength: FCC15.225

UL Japan, Inc.
YAMAKITA No1 Anechoic Chamber

Company : OMRON Corporation	Report No. : 28CE0270-YK-01-A
Equipment : RFID System	Regulation : FCC Part15 SupartC 15.225
Model : V680-HA63A/V680-HS51	Test Distance : 3m
Sample No. : 30X06V/-	Date : 2007/11/06
FCC ID : E4E6CYSIDV6800406	Temperature : 20deg.C
Power : DC24V	Humidity : 61%
Mode : Transmitting (13.56MHz)	
Remarks : -	

ENGINEER : Go Ishiwata

Field strength

No.	FREQ [MHz]	T/R Reading		ANT Factor [dB]	ATTEN [dB]	CABLE LOSS [dB]	AMP GAIN [dB]	RESULT		LIMIT (3m) [dBuV/m]	MARGIN	
		Hor [dBuV]	Ver [dBuV]					Hor [dBuV/m]	Ver [dBuV/m]		Hor [dB]	Ver [dB]
1	13.560	54.2	60.3	19.5	0.0	0.7	28.4	46.0	52.1	124.0	78.0	71.9

Field strength of 13.553MHz to 13.567MHz Limit(3m) = 84dBuV/m + 40log 30m/3m
= 124dBuV/m (FCC15.225(a))

Outside Field strength

No.	FREQ [MHz]	T/R Reading		ANT Factor [dB]	ATTEN [dB]	CABLE LOSS [dB]	AMP GAIN [dB]	RESULT		LIMIT (3m) [dBuV/m]	MARGIN	
		Hor [dBuV]	Ver [dBuV]					Hor [dBuV/m]	Ver [dBuV/m]		Hor [dB]	Ver [dB]
1	13.110	31.6	31.7	19.5	0.0	0.7	28.4	23.4	23.5	69.5	46.1	46.0
2	13.410	31.6	31.8	19.5	0.0	0.7	28.4	23.4	23.6	80.5	57.1	56.9
3	13.553	40.9	41.8	19.5	0.0	0.7	28.4	32.7	33.6	90.5	57.8	56.9
4	13.567	40.0	40.6	19.5	0.0	0.7	28.4	31.8	32.4	90.5	58.7	58.1
5	13.710	31.5	31.6	19.6	0.0	0.7	28.4	23.4	23.5	80.5	57.1	57.0
6	14.010	31.5	31.6	19.6	0.0	0.7	28.5	23.3	23.4	69.5	46.2	46.1

Outside filed strength frequencies

- filed strength band $F_c \pm 7\text{kHz}$: 13.553MHz to 13.567MHz
 - Outside filde strength $F_c \pm 150\text{kHz}$: 13.410MHz to 13.710MHz
 - Outside filde strength $F_c \pm 450\text{kHz}$: 13.110MHz to 14.010MHz
- $F_c = 13.56\text{MHz}$

Limits (3m)

- 13.410MHz to 13.553MHz and 13.567MHz to 13.710MHz : $50.5\text{dBuV/m} + 40\log 30\text{m}/3\text{m} = 90.5\text{dBuV/m}$ (FCC15.225(b))
- 13.110MHz to 14.010MHz and 13.710MHz to 14.010MHz : $40.5\text{dBuV/m} + 40\log 30\text{m}/3\text{m} = 80.5\text{dBuV/m}$ (15.225(c))
- Below 13.110MHz and Above 14.010MHz : $29.5\text{dBuV/m} + 40\log 30\text{m}/3\text{m} = 69.5\text{dBuV/m}$ (FCC15.225(d)and FCC15.209)

Antenna: KLP-01(HFH2-Z2) 0.009-30MHz
KCC-30/31/32/34(RE)
AMP: KAF-05(8447D)
Receiver: KTR-05

DATA OF RADIATION TEST

UL Japan, Inc.

YAMAKITA No.1 ANECHOIC CHAMBER

Report No. : 28CE0270-YK-01-A

Applicant : OMRON Corporation
Kind of Equipment : RFID System
Model No. : V680-HA63A/V680-HS51
Serial No. : 30X06V/-
Power : DC24V
Mode : Transmitting Mode(13.56MHz)
Remarks : EUT X:Hor Y:Ver
Date : 11/6/2007
Test Distance : 3 m
Temperature : 20 °C Engineer : Go Ishiwata
Humidity : 61 %
Regulation : FCC Part15C § 15.209 9KHz-30MHz (3m)

No.	FREQ. [MHz]	ANT TYPE	READING		ANT FACTOR [dB/m]	AMP GAIN [dB]	CABLE LOSS [dB]	ATTEN. [dB]	RESULT		LIMITS		MARGIN	
			HOR [dB μ V]	VER					HOR [dB μ V/m]	VER	HOR [dB]	VER		
1.	27.12	BB	31.5	35.4	20.4	28.5	1.0	0.0	24.4	28.3	69.5	45.1	41.2	

CALCULATION: READING + ANT. FACTOR + CABLE LOSS - AMP. GAIN + ATTEN.

■ ANTENNA: KLP-01 (HFH2-Z2) 9kHz-30MHz

■ CABLE: KCC-30/31/32/34 ■ PREAMP: KAF-05 (8447D) ■ EMI RECEIVER: KTR-05 (ESCI)

DATA OF RADIATION TEST

UL Japan, Inc.
YAMAKITA No.1 ANECHOIC CHAMBER
Report No. : 28CE0270-YK-01-A

Applicant : OMRON Corporation
 Kind of Equipment : RFID System
 Model No. : V680-HA63A/V680-HS51
 Serial No. : 30X06V/-
 Power : DC24V
 Mode : Transmitting Mode(13.56MHz)
 Remarks : EUT X:Hor Y:Ver
 Date : 11/6/2007
 Test Distance : 3 m
 Temperature : 20 °C
 Humidity : 61 %
 Regulation : FCC Part15C § 15.209

Engineer : Go Ishiwata

No.	FREQ. [MHz]	ANT TYPE	READING		ANT FACTOR [dB/m]	AMP GAIN [dB]	CABLE LOSS [dB]	ATTEN. [dB]	RESULT		LIMITS [dB μ V/m]	MARGIN	
			HOR [dB μ V]	VER					HOR [dB μ V/m]	VER		HOR [dB]	VER
1.	40.68	BB	23.6	30.3	13.7	28.8	1.2	5.8	15.5	22.2	40.0	24.5	17.8
2.	54.24	BB	26.3	31.2	9.6	28.6	1.4	5.8	14.5	19.4	40.0	25.5	20.6
3.	61.01	BB	42.7	49.6	8.4	28.7	1.5	5.8	29.7	36.6	40.0	10.3	3.4
4.	67.80	BB	35.5	44.0	7.0	28.5	1.6	5.8	21.4	29.9	40.0	18.6	10.1
5.	78.08	BB	33.5	46.2	6.6	28.6	1.7	5.8	19.0	31.7	40.0	21.0	8.3
6.	81.36	BB	28.5	41.6	6.9	28.6	1.8	5.8	14.4	27.5	40.0	25.6	12.5
7.	94.92	BB	29.8	38.0	9.5	28.6	2.0	5.8	18.5	26.7	43.5	25.0	16.8
8.	108.48	BB	27.7	33.0	11.7	28.4	2.1	5.8	18.9	24.2	43.5	24.6	19.3
9.	122.05	BB	31.0	39.9	13.4	28.4	2.3	5.8	24.1	33.0	43.5	19.4	10.5
10.	128.82	BB	32.7	40.1	13.8	28.4	2.3	5.8	26.2	33.6	43.5	17.3	9.9
11.	135.60	BB	29.5	35.1	14.2	28.4	2.4	5.8	23.5	29.1	43.5	20.0	14.4
12.	248.90	BB	37.9	38.6	17.6	27.7	3.3	5.8	36.9	37.6	46.0	9.1	8.4
13.	401.04	BB	35.8	37.7	17.1	28.4	4.7	5.9	35.1	37.0	46.0	10.9	9.0
14.	912.00	BB	29.5	26.6	22.1	28.7	6.8	5.9	35.6	32.7	46.0	10.4	13.3

CALCULATION: READING + ANT. FACTOR + CABLE LOSS - AMP. GAIN + ATTEN.

■ ANTENNA: KBA-03 (BBA9106) 30-299.99MHz/KLA-03 (USLP9143) 300-1000MHz
 ■ CABLE: KCC-30/31/32/34 ■ PREAMP: KAF-05 (8447D) ■ EMI RECEIVER: KTR-05 (ESC1)

Bandwidth: FCC 15.215(c)

COMPANY	: OMRON Corporation	UL Japan. Inc. Yamakita No.1 Anechoic chamber
Equipment	: RFID System	REPORT No. : 28CE0270-YK-01-A
MODEL NUMBER	: V680-HA63A/V680-HS51	REGULATION : FCC Part15SubpartC 215(c)
SERIAL NUMBER	: 30X06V/-	DATE : 2007/11/02
FCC ID	: E4E6CYSIDV6800406	TEMP./HUMI : 24°C/54%
POWER	: DC24V	TEST MODE : Transmitting
		ENGINEER : Go Ishiwata

20dB Bandwidth: 5.65kHz

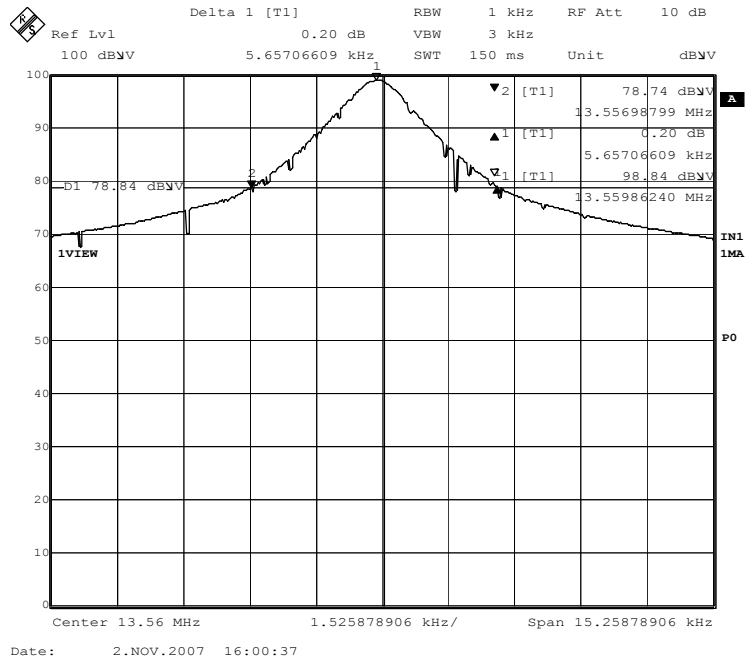

OBW(99%): 6.41kHz

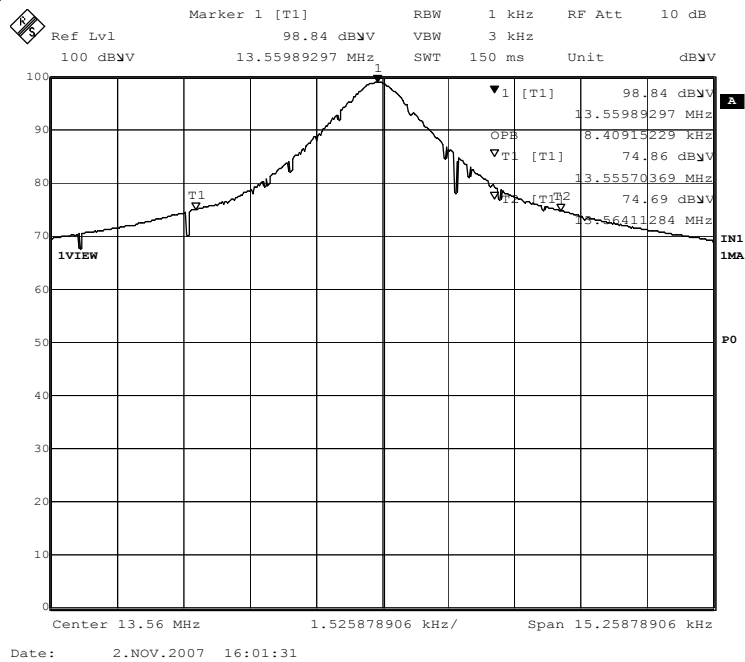

Data of Frequency Tolerance: FCC 15.225(e)

UL Japan, Inc.
YAMAKITA No.4 Shield room

Company : OMRON Corporation	Report No. : 28CE0270-YK-01-A
Equipment : RFID System	Regulation : FCC Part15 SupartC 15.225 (e)
Model : V680-HA63A/V680-HS51	
Sample No. : 30X06V/-	Date : 2007/11/01
FCC ID : E4E6CYSIDV6800406	Temperature : 23deg.C
Power : DC24V	Humidity : 48%
Mode : Transmitting (13.56MHz)	

ENGINEER : Go Ishiwata

Temperature Variation: -30deg.C

Test Conditions	Original Frequency (MHz)	Measure Frequency (MHz)	Frequency Error (kHz)	Frequency tolerance (%)	Limit (%)
startup	13.56	13.55998	-0.00002	-0.00015	0.01
after 2minutes	13.56	13.55998	-0.00002	-0.00015	0.01
after 5minutes	13.56	13.55998	-0.00002	-0.00015	0.01
after 10minutes	13.56	13.55999	-0.00001	-0.00007	0.01

Temperature Variation: -20deg.C

Test Conditions	Original Frequency (MHz)	Measure Frequency (MHz)	Frequency Error (kHz)	Frequency tolerance (%)	Limit (%)
startup	13.56	13.55999	-0.00001	-0.00007	0.01
after 2minutes	13.56	13.55999	-0.00001	-0.00007	0.01
after 5minutes	13.56	13.55999	-0.00001	-0.00007	0.01
after 10minutes	13.56	13.55999	-0.00001	-0.00007	0.01

Temperature Variation: -10deg.C

Test Conditions	Original Frequency (MHz)	Measure Frequency (MHz)	Frequency Error (kHz)	Frequency tolerance (%)	Limit (%)
startup	13.56	13.55997	-0.00003	-0.00022	0.01
after 2minutes	13.56	13.55996	-0.00004	-0.00029	0.01
after 5minutes	13.56	13.55996	-0.00004	-0.00029	0.01
after 10minutes	13.56	13.55996	-0.00004	-0.00029	0.01

Temperature Variation: 0deg.C

Test Conditions	Original Frequency (MHz)	Measure Frequency (MHz)	Frequency Error (kHz)	Frequency tolerance (%)	Limit (%)
startup	13.56	13.55993	-0.00007	-0.00052	0.01
after 2minutes	13.56	13.55992	-0.00008	-0.00059	0.01
after 5minutes	13.56	13.55992	-0.00008	-0.00059	0.01
after 10minutes	13.56	13.55992	-0.00008	-0.00059	0.01

Data of Frequency Tolerance: FCC 15.225(e)

UL Japan, Inc.
YAMAKITA No.4 Shield room

Company : OMRON Corporation	Report No. : 28CE0270-YK-01-A
Equipment : RFID System	Regulation : FCC Part15 SupartC 15.225 (e)
Model : V680-HA63A/V680-HS51	
Sample No. : 30X06V/-	Date : 2007/11/01
FCC ID : E4E6CYSIDV6800406	Temperature : 23deg.C
Power : DC24V	Humidity : 48%
Mode : Transmitting (13.56MHz)	

ENGINEER : Go Ishiwata

Temperature Variation: 10deg.C

Test Conditions	Original Frequency (MHz)	Measure Frequency (MHz)	Frequency Error (kHz)	Frequency tolerance (%)	Limit (%)
startup	13.56	13.55993	-0.00007	-0.00052	0.01
after 2minutes	13.56	13.55992	-0.00008	-0.00059	0.01
after 5minutes	13.56	13.55991	-0.00009	-0.00066	0.01
after 10minutes	13.56	13.55990	-0.00010	-0.00074	0.01

Temperature Variation: 20deg.C

Test Conditions	Original Frequency (MHz)	Measure Frequency (MHz)	Frequency Error (kHz)	Frequency tolerance (%)	Limit (%)
startup	13.56	13.55988	-0.00012	-0.00088	0.01
after 2minutes	13.56	13.55987	-0.00013	-0.00096	0.01
after 5minutes	13.56	13.55986	-0.00014	-0.00103	0.01
after 10minutes	13.56	13.55986	-0.00014	-0.00103	0.01

Temperature Variation: 30deg.C

Test Conditions	Original Frequency (MHz)	Measure Frequency (MHz)	Frequency Error (kHz)	Frequency tolerance (%)	Limit (%)
startup	13.56	13.55985	-0.00015	-0.00111	0.01
after 2minutes	13.56	13.55984	-0.00016	-0.00118	0.01
after 5minutes	13.56	13.55983	-0.00017	-0.00125	0.01
after 10minutes	13.56	13.55982	-0.00018	-0.00133	0.01

Temperature Variation: 40deg.C

Test Conditions	Original Frequency (MHz)	Measure Frequency (MHz)	Frequency Error (kHz)	Frequency tolerance (%)	Limit (%)
startup	13.56	13.55982	-0.00018	-0.00133	0.01
after 2minutes	13.56	13.55981	-0.00019	-0.00140	0.01
after 5minutes	13.56	13.55980	-0.00020	-0.00147	0.01
after 10minutes	13.56	13.55979	-0.00021	-0.00155	0.01

Temperature Variation: 50deg.C

Test Conditions	Original Frequency (MHz)	Mesure Frequency (MHz)	Frequency Error (kHz)	Frequency tolerance (%)	Limit (%)
startup	13.56	13.55979	-0.00021	-0.00155	0.01
after 2minutes	13.56	13.55978	-0.00022	-0.00162	0.01
after 5minutes	13.56	13.55978	-0.00022	-0.00162	0.01
after 10minutes	13.56	13.55978	-0.00022	-0.00162	0.01

Data of Frequency Tolerance: FCC 15.225(e)

UL Japan, Inc.
YAMAKITA No.4 Shield room

Company : OMRON Corporation
Equipment : RFID System
Model : V680-HA63A/V680-HS51
Sample No. : 30X06V/-
FCC ID : E4E6CYSIDV6800406
Power : DC24V
Mode : Transmitting (13.56MHz)

Report No. : 28CE0270-YK-01-A
Regulation : FCC Part15 SupartC 15.225 (e)

Date : 2007/11/01
Temperature : 23deg.C
Humidity : 48%

ENGINEER : Go Ishiwata

Input Voltage:DC20.4V (85%)

Temperature Variation: 20deg.C

Test Conditions	Original Frequency (MHz)	Measure Frequency (MHz)	Frequency Error (kHz)	Frequency tolerance (%)	Limit (%)
startup	13.56	13.55987	-0.00013	-0.00096	0.01
after 2minutes	13.56	13.55986	-0.00014	-0.00103	0.01
after 5minutes	13.56	13.55986	-0.00014	-0.00103	0.01
after 10minutes	13.56	13.55986	-0.00014	-0.00103	0.01

Input Voltage:DC27.6V(115%)

Temperature Variation: 20deg.C

Test Conditions	Original Frequency (MHz)	Measure Frequency (MHz)	Frequency Error (kHz)	Frequency tolerance (%)	Limit (%)
startup	13.56	13.55986	-0.00014	-0.00103	0.01
after 2minutes	13.56	13.55986	-0.00014	-0.00103	0.01
after 5minutes	13.56	13.55986	-0.00014	-0.00103	0.01
after 10minutes	13.56	13.55986	-0.00014	-0.00103	0.01

APPENDIX 3 Test Instruments

EMI test equipment

Control No.	Instrument	Manufacturer	Model No	Test Item	Calibration Date * Interval(month)
YA-CE	Conducted emission(software)	UL Japan	CE(Ver.1.6)	CE	-
YA-RE	Radiated emission(software)	UL Japan	RE(Ver.1.5)	RE	-
KCC-24/25/26 /28/KPL-02/K RM-02	Coaxial Cable/Pulse Limiter/RF Relay Matrix	Fujikura/Suhner/PMM/TSJ	5D-2W/5D-2W/S04272B/S04272B/PL01/RFM-E321	CE	2007/09/20 * 12
KLS-05	LISN(AMN)	Schwarzbeck	NSLK8126	CE (EUT)	2007/09/20 * 12
KLS-06	LISN(AMN)	Schwarzbeck	NSLK8127	CE	2007/09/20 * 12
KSA-02	Spectrum Analyzer	Advantest	R3265A	CE	2006/12/02 * 12
KTM-07	Terminator	TME	CT-01BP	CE	2007/10/30 * 12
KTR-03	Test Receiver	Rohde & Schwarz	ESHS10	CE	2007/02/05 * 12
KOS-10	Humidity Indicator	Custom	CTH-190	CE	2006/07/10 * 24
KJM-04	Measure	TAJIMA	GL19-55	CE	-
KAEC-01	Anechoic Chamber	JSE	Semi 3m	RE/BW	2007/08/26 * 12
KAF-05	Pre Amplifier	Agilent	8447D	RE/BW	2007/04/13 * 12
KAT6-01	Attenuator	INMET	18N-6dB	RE/BW	2007/03/28 * 12
KBA-03	Biconical Antenna	Schwarzbeck	BBA9106	RE	2007/01/06 * 12
KCC-30/31/32 /34/KRM-03	Coaxial Cable/RF Relay Matrix	Fujikura/Suhner/TSJ	5D-2W/S04272B/RFM-E421	RE/BW	2007/11/01 * 12
KLA-03	Logperiodic Antenna	Schwarzbeck	USLP9143	RE	2007/01/06 * 12
KSA-04	Spectrum Analyzer	Advantest	R3271A	RE/FT	2007/09/25 * 12
KTR-05	Test Receiver	Rohde & Schwarz	ESCI	RE/BW	2007/06/26 * 12
KOS-02	Humidity Indicator	Custom	CTH-190	RE/BW	2006/07/10 * 24
KJM-01	Measure	TAJIMA	GL19-55	RE/BW	-
KLP-01	Loop Antenna	Rohde & Schwarz	HFH2-Z2	RE/BW	2007/06/11 * 12
KCH-01	Temperature and Humidity Chamber	Tabai Espec	PL-1KT	FT	2006/12/28 * 12
KOS-07	Humidity Indicator	Custom	CTH-190	FT	2006/10/06 * 24
KFC-01	Microwave Counter	Advantest	R5373	FT	2007/04/04 * 12
KSCA-01	Search coil	TSJ	SC01	FT	Pre Check
KCC-A2	Coaxial Cable	Fujikura	5D-2W	FT	2007/05/15 * 12

The expiration date of the calibration is the end of the expired month .

All equipment is calibrated with traceable calibrations . Each calibration is traceable to the national or international standards .

Test Item :

CE: Conducted emission,
RE: Radiated emission,
BW: Bandwidth,
FT: Frequency tolerance