

Rhein Tech Laboratories  
360 Herndon Parkway  
Suite 1400  
Herndon, VA 20170  
www.rheintech.com

Client: Samsung EMC  
Model: SWL-2200U  
FCC ID: E2XSWL-2200U  
FCC/IC: 15.247/RSS-210  
Report #: 2002055

## **APPENDIX B: ANTENNA SPECIFICATIONS**

Please see the following pages.

Antenna : SEMCO WLAN Chip Antenna (12.5\*3\*2.5 mm ceramic)

Test JIG : 2200U

Antenna Position :

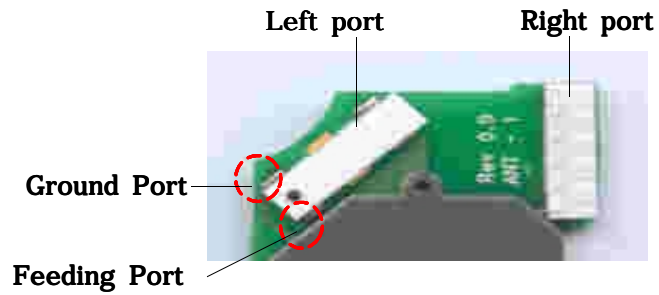

Matching Circuit : Matching circuit needed

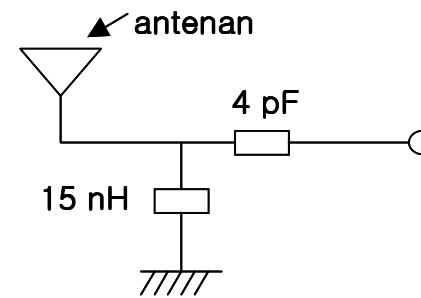

Antenna Radiation Pattern Direction

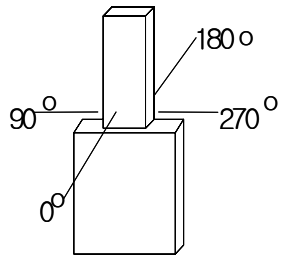

Azimuth Plane (XY plane)

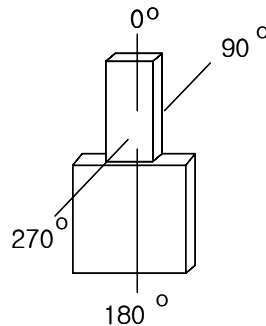

Elevation 1 Plane (YZ plane)

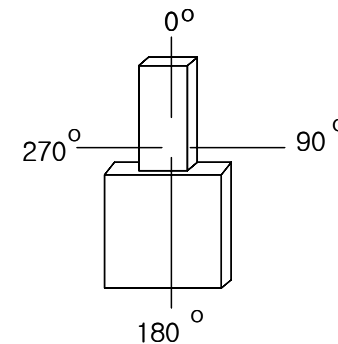

Elevation 2 Plane (ZX plane)

Antenna : SEMCO WLAN Chip Antenna

VSWR Result

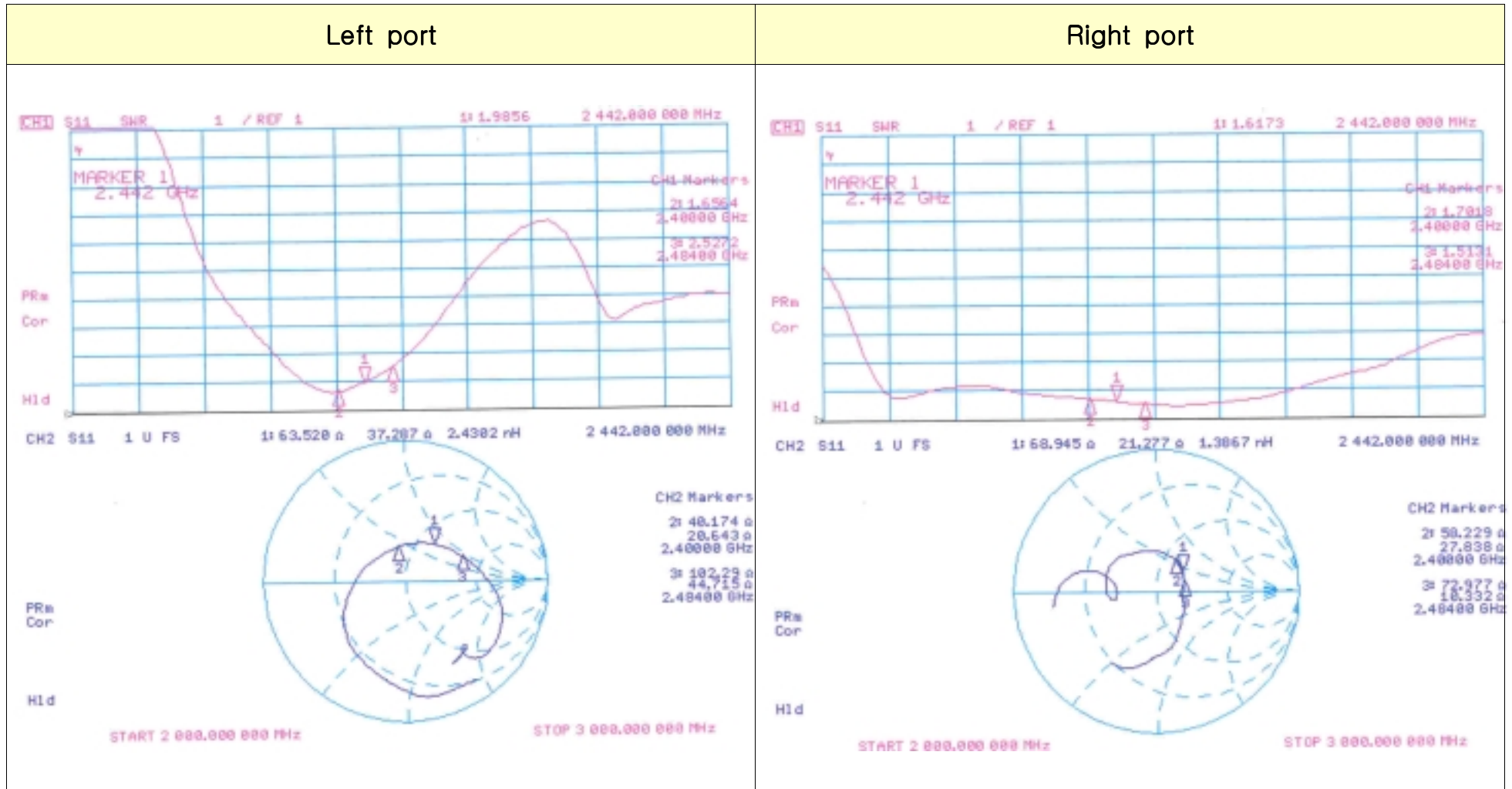

Antenna : SEMCO WLAN Chip Antenna

Radiation Pattern Result (Left port)

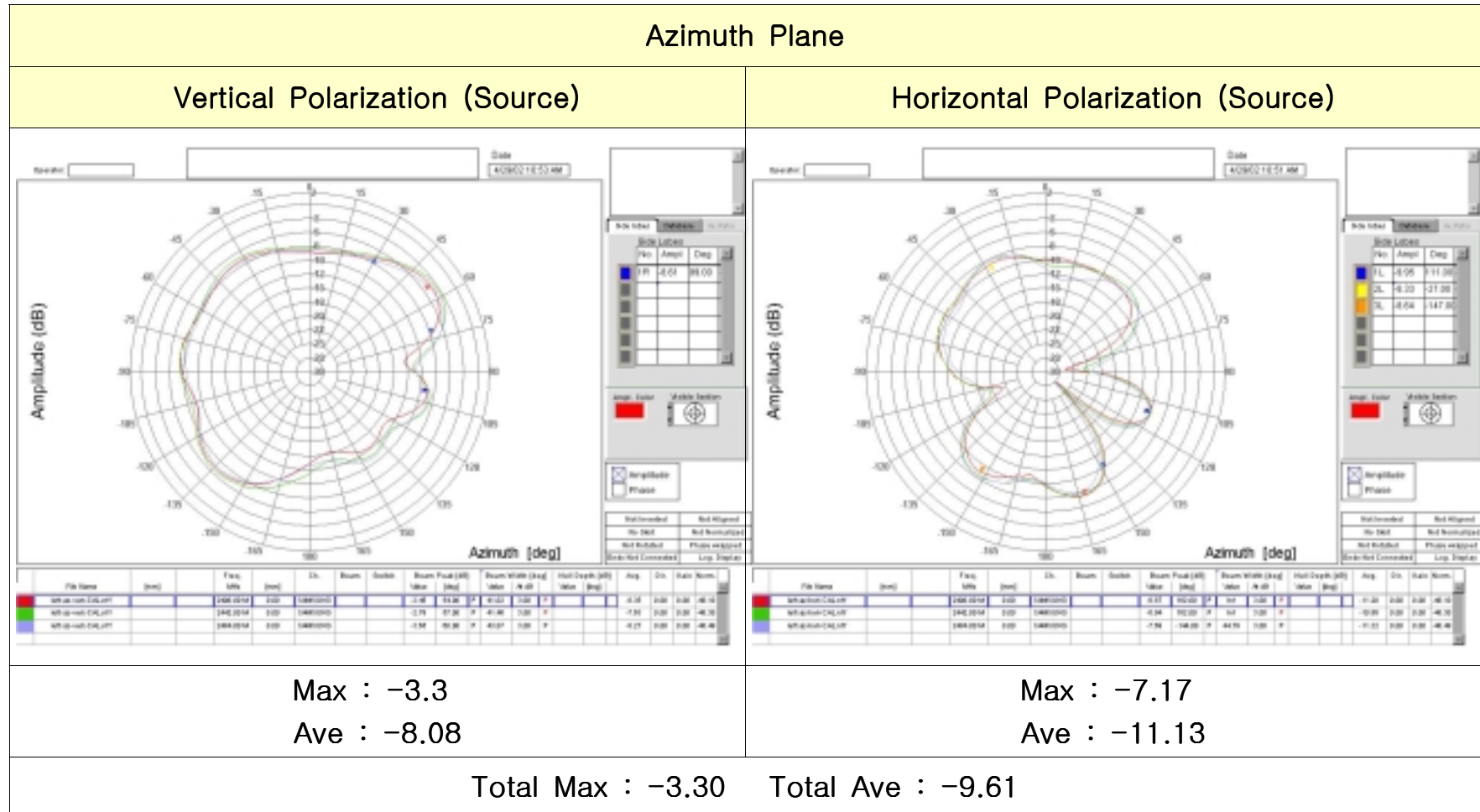

Antenna : SEMCO WLAN Chip Antenna

### Radiation Pattern Result (Left port)

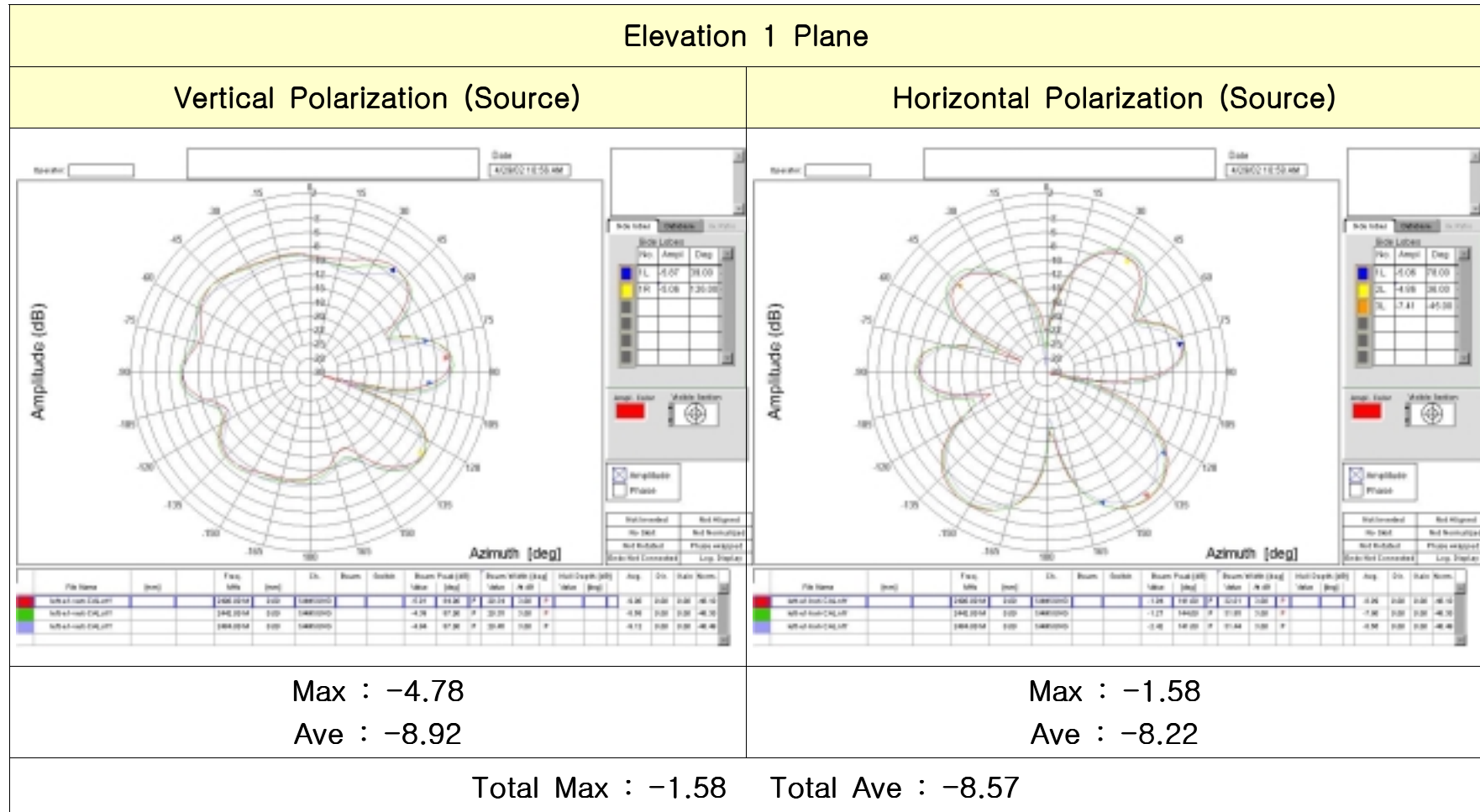

Antenna : SEMCO WLAN Chip Antenna

Radiation Pattern Result (Left port)

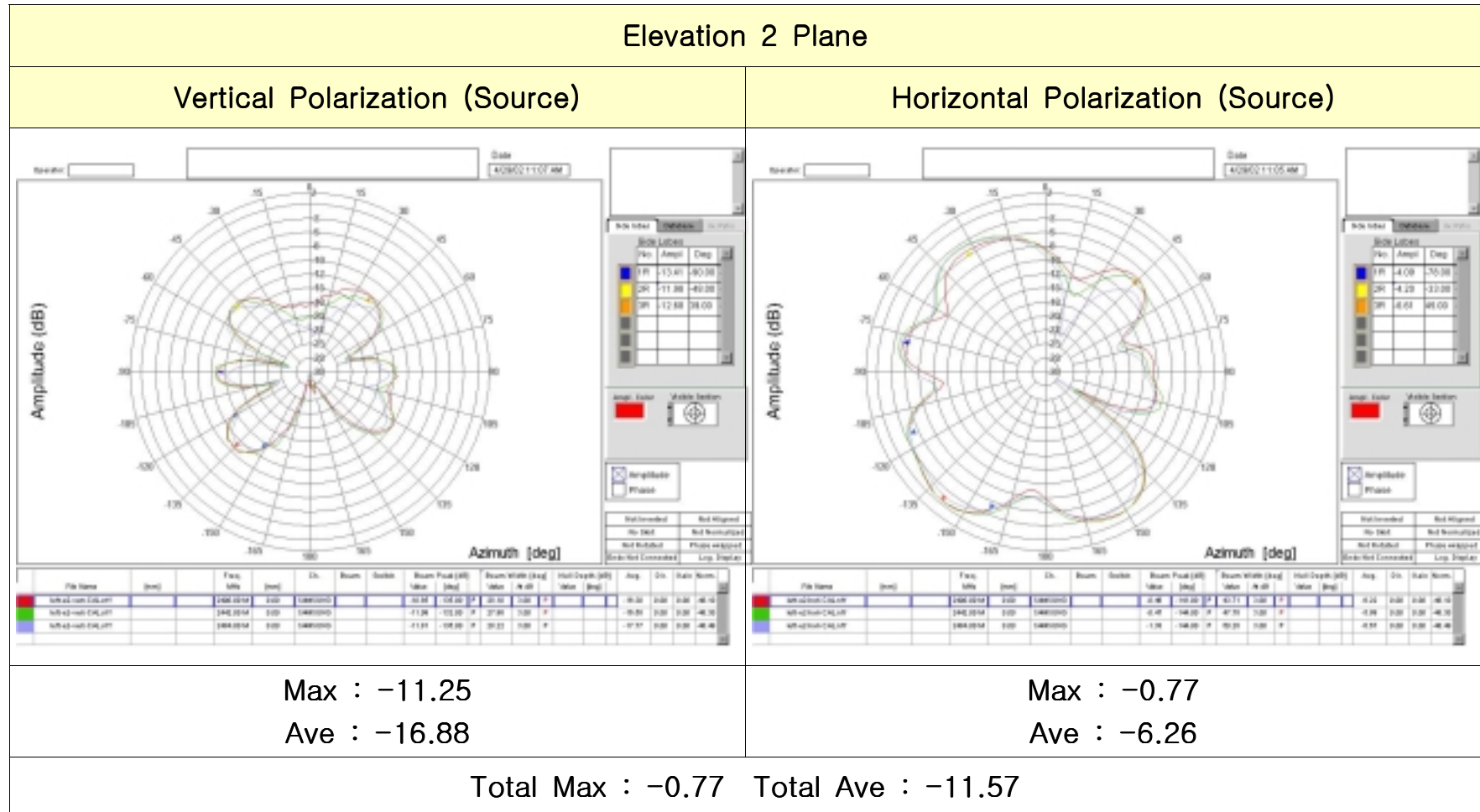

Antenna : SEMCO WLAN Chip Antenna

Radiation Pattern Result (Right port)

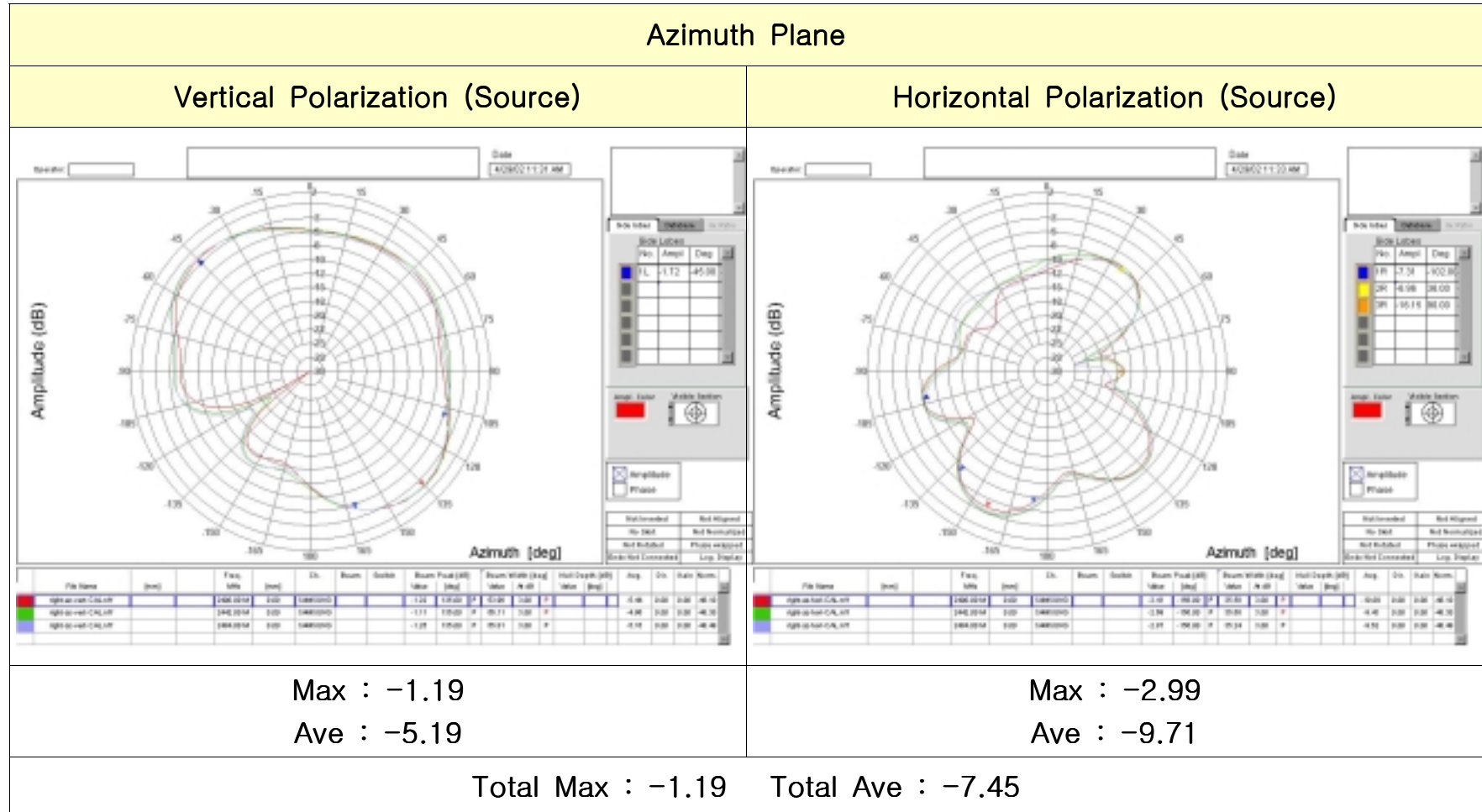

Antenna : SEMCO WLAN Chip Antenna

Radiation Pattern Result (Right port)

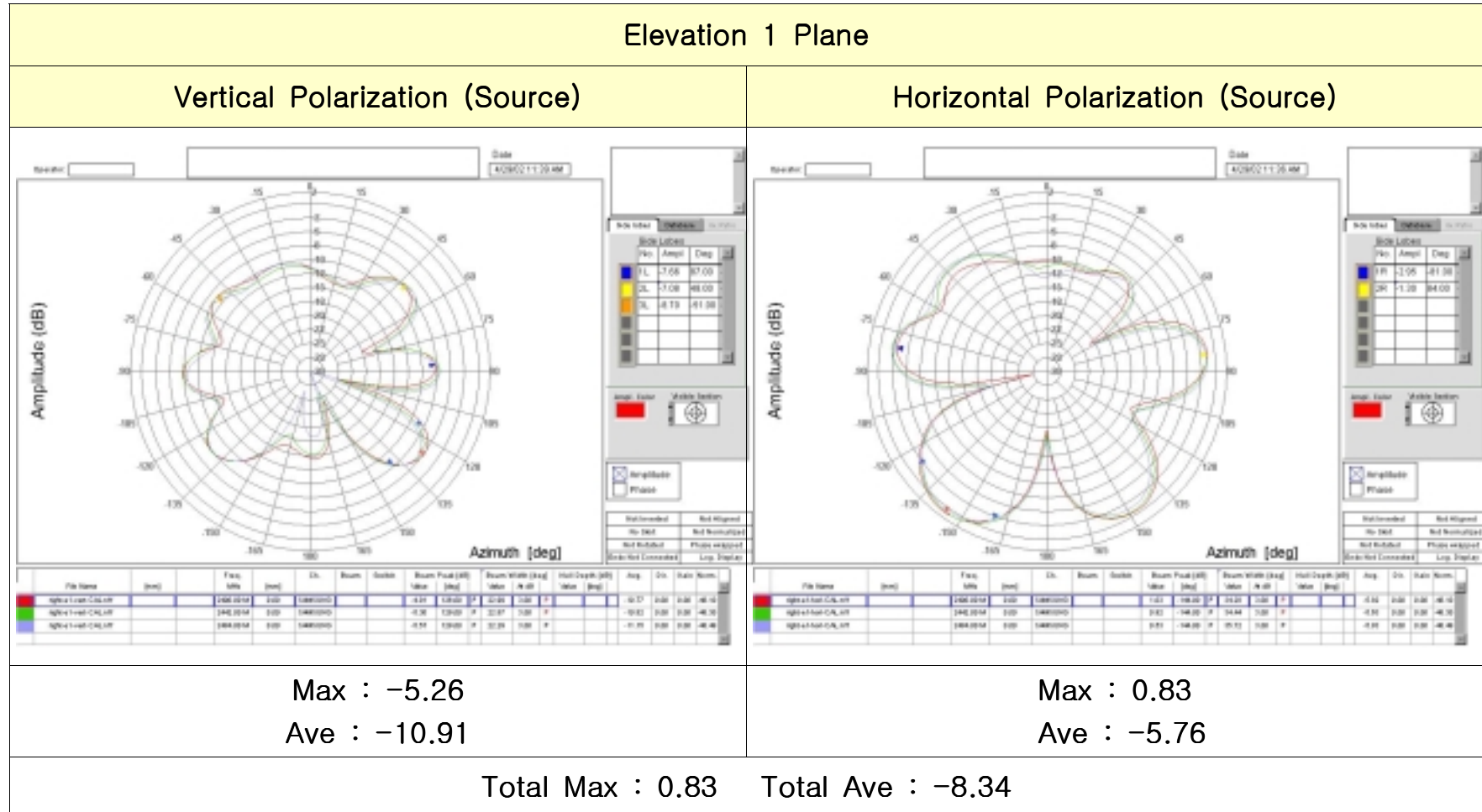



Antenna : SEMCO WLAN Chip Antenna

Radiation Pattern Result (Right port)

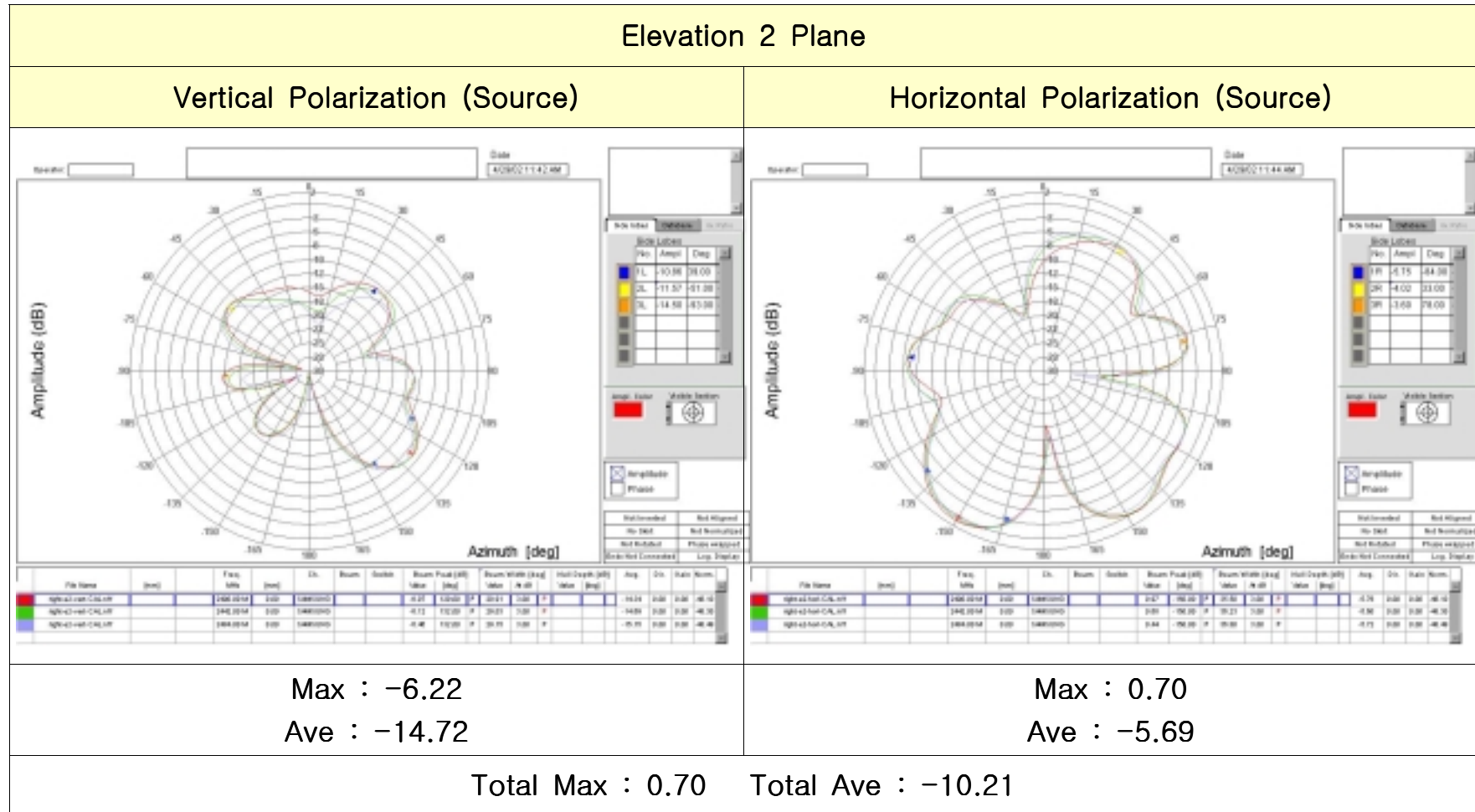

Antenna : SEMCO WLAN Chip Antenna

Radiation Pattern Result

■ Source : Vertical Polarization [dBi]

Port	Azimuth (all)		Elevation 1 (all)		Elevation 2 (all)	
	Max	Ave	Max	Ave	Max	Ave
Left	-3.30	-8.08	-4.78	-8.92	-11.25	-16.88
Right	-1.19	-5.19	-5.26	-10.91	-6.22	-14.72

■ Source : Horizontal Polarization [dBi]

Port	Azimuth (all)		Elevation 1 (all)		Elevation 2 (all)	
	Max	Ave	Max	Ave	Max	Ave
Left	-7.17	-11.13	-1.58	-8.22	-0.77	-6.26
Right	-2.99	-9.71	0.83	-5.76	0.7	-5.69

■ Total Average [dBi]

Left port	-5.91
Right port	-4.52