

**SAMSUNG**

# Magic wave SWL-1000

User's, Installation & Operation Guide



## Notice

These SWL-1000D and SWL-1000N have been tested and found to comply with Part 15 of the FCC rules.

Operation of this devices are subject to the following two conditions:

- (1) This device may not cause harmful interference.
- (2) This device must accept any interference received, including interference that may cause undesired operation.

This device must be installed and used in strict accordance with the manufacture's instructions. However, there is no guarantee that interference to radio communications will not occur in a particular commercial installation.

If this device does cause interference, the user/operator shall promptly stop operating the device until harmful interference has been eliminated.

## Service

MagicWave is the trademark of the SAMSUNG in wireless LAN.

The most recent software and user documentation for all MagicWave products is available on our World Wide Web.

WWW <http://www.sem.samsung.co.kr>

R&D Dept. of the Head Office [82-331-210-6662](tel:82-331-210-6662)

## Table of Contents

<b>Section 1.</b> MagicWave Introduction .....	3
<b>Section 2.</b> Network Installation .....	6
<b>Section 3.</b> Hardware and Software Installation .....	8
<b>Section 4.</b> MagicWave Access Point Installation Guide and Manual ...	12

# Chapter 1. MagicWave Introduction

## MagicWave Overview

The MagicWave(SWL-1000x) is a wireless LAN adapter card that provide wireless connections between IBM-PC's.

The function of the MagicWave SWL-1000AP(Access Point) is to transfer information from a wired LAN to a wireless LAN and from the wireless LAN back to the wired LAN.

When operating, the MagicWave is invisible to most users (Normally , unless the user is an administrator, the MagicWave can not be seen or accessed by users on the network.)

The MagicWave is similar to Ethernet, a most widely used network card, but it can be used on motion when applied to note-PC because of the wireless connection.

The MagicWave is designed to operate with IEEE 802.11 compliant radio cards, Wireless LAN International Standards, and use a protocol(CSMA/CA) of collision evasion method for protect a collision on the network, so a high speed communication is possible.

The MagicWave supports DSSS(direct sequence spread spectrum), This is a radio technique which scrambles the data prior to transmission and uses a correlation technique on receive to improve the signal to noise ratio and makes a possibility to communicate in the office having a wall, a compartment.

MagicWave provides network driver software to support most of the commonly used network software and diagnostic programs.

## MAIN CHARACTERISTIC

The MagicWave supports a Peer to Peer communication which makes point-to-point and point-to-multipoint communications possible, which makes the communications between wireless LAN users easy.

A wireless network can be connected to a wired Ethernet through a network interface called an Access Point. Since all the protocols for a wired network are supported through an Access Point, all the services for a wired network are available for a wireless network users.

The MagicWave supports various network softwares. The network driver is supplied to support most network software such as MS Windows 4 Workgroup 3.11, Windows95, Windows NT, etc.

The SWL-1000N for note-PC is small and portable as a roaming function is provided for users who would like to get network services while moving around.

**SPECIFICATIONS****◆ System Interface**

	SWL-1000N	SWL-1000D
ETHER Controller	Am79c930	Am79c930
PC Interface	PCMCIA	ISA
Configuration	Plug and Play	Plug and Play
LAN Standard	IEEE802.11(CSMA/CA)	IEEE802.11(CSMA/CA)
LAN Interface	Radio Frequency	Radio Frequency

**◆ Radio Specifications**

Frequency	2.412, 2.417, 2.422, 2.427, 2.432, 2.437, 2.442, 2.447, 2.452, 2.457, 2.462, 2.467, 2.472GHz, SUM 13	2.412, 2.417, 2.422, 2.427, 2.432, 2.437, 2.442, 2.447, 2.452, 2.457, 2.462, 2.467, 2.472GHz, SUM 13
Output Power	less than 10mW/MHz	less than 10mW/MHz
transmission rate	2Mbps	2Mbps
Modulation Methods	DQPSK	DQPSK
Receive Signal Level	-83dBm	-83dBm
Main Lobe BandWidth	22MHz	22MHz
BER	less than 10 <sup>-8</sup>	less than 10 <sup>-8</sup>

**◆ Transmission Range**

Outdoor	300m	300m
In the office having a compartment (About 1.5 m height)	50m	50m
In the office having a wall (Don't have made with concrete or metal)	30m	30m
In the office having a wall made of concrete	20m	20m

\* The range may be affected by the environment

### ◆ Physical Specifications

Adapter card size	105mm*53mm*5mm	180mm*110mm*10mm
Antenna size		85mm*80mm*15mm
Weight	38g	145g
operating temperature	-10℃ +50℃	
소비 전력		
Sleep mode	0.1W	N/A
Standby mode	0.2W	N/A
receive mode	1.3W	2.5W
transmission mode	1.7W	3.8W

### ◆ Supplied Software (both SWL-1000N and 1000D)

MS Windows for Workgroup 3.11(NDIS2) / WIN95(NDIS3) / Windows NT Driver  
Test and install program

### ◆ Operating State Indication Lamp

Power, transmission, receive LED

\* Power : SWL-1000D (turns on when the system is powered on)

SWL-1000N (turns on with beep sound when the PC initializes the wireless LAN card in the PCMCIA slot on system booting)

Tx : turns on when transmitting data.

Rx : turns on when receiving data.

A Wireless LAN card automatically starts to operate when inserted into the slot while the system is on because most notebook PC support hot plugging in Windows95 environment. To remove the card while the system is in operation, follow the next steps:

- Click on the icon shaped a PCMCIA card on the right bottom menu bar.
- Click on the card removal message when it appears next to the icon.
- Remove the card when the permission appears in a small box.

## Section 2. Network Installation

The number of computers connected, Ethernet installation, and the desired network applications determines the type of network, Ad-Hoc or Infrastructure .

The wireless LAN can easily be installed and used while one must connect cables to install a wired LAN.

### Ad-Hoc NETWORK (Point to point communication)

An Ad-Hoc Network is suitable for the environment in which connections to wired network are not necessary and can be constructed by only wireless LAN adapter cards.

You can use the network immediately after setting up the network parameters using the supplied network driver.

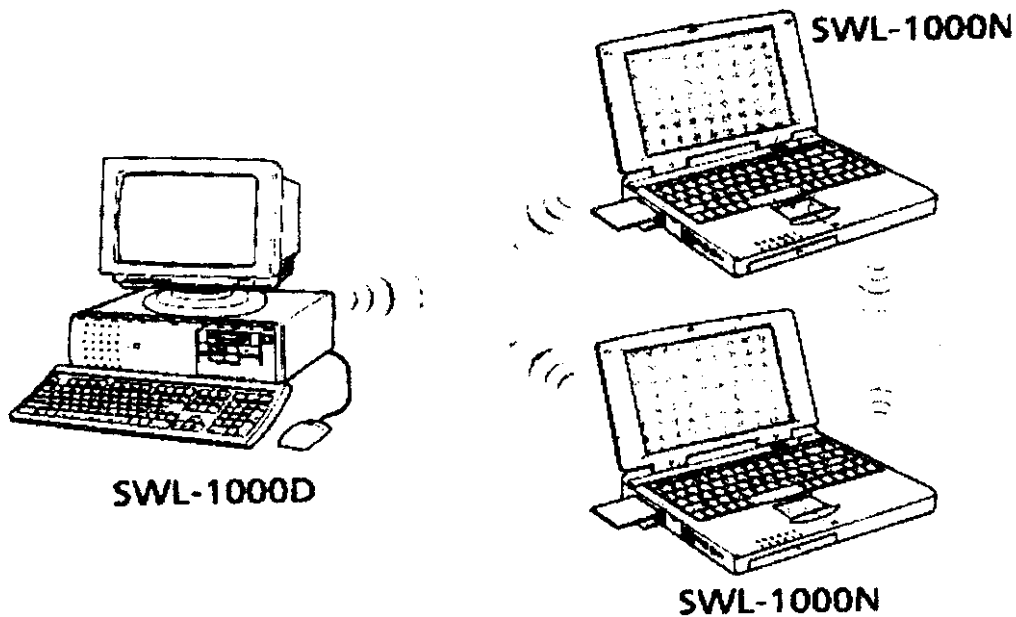

### Infrastructure NETWORK

A wireless LAN can be used to access all the services that are available for a wired LAN through an access point which connects the wireless LAN to a wired network.

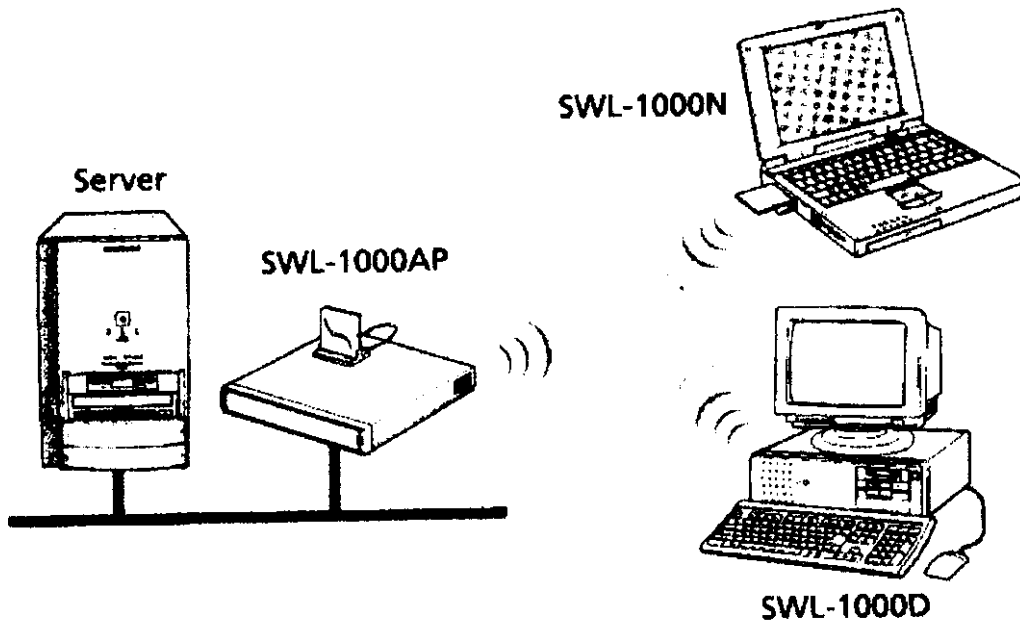

Roaming function is also supplied to Infrastructure Network users who are in motion.

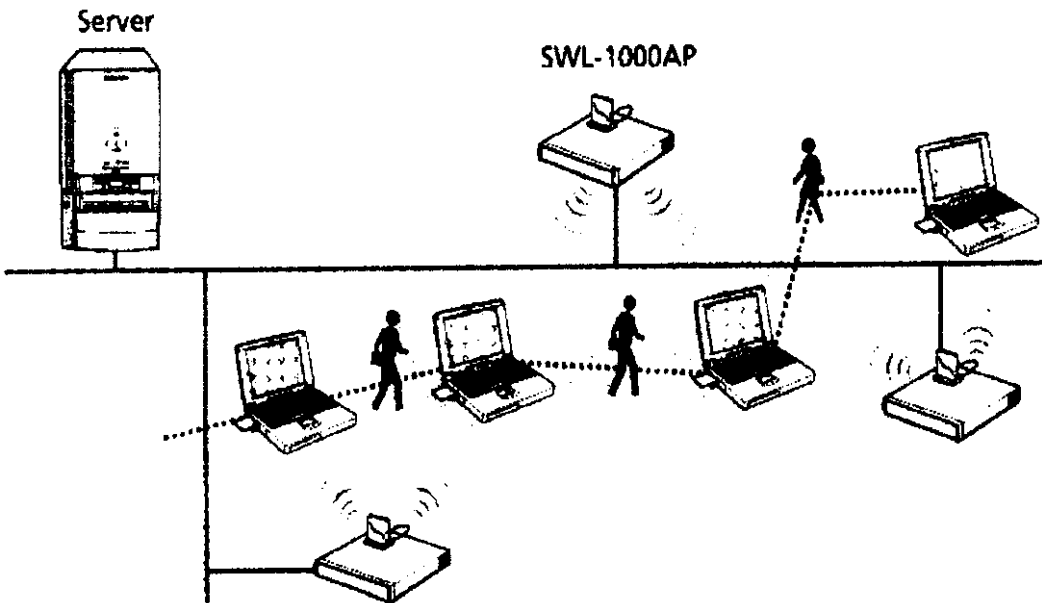

Roaming is a service that disconnects the user from an access point allotted to the previous cell and connects to the one allotted to a new cell when the user moves into the cell.

## Section 3. Hardware and Software installation

### UNPACKING AND INSPECTION

After opening the box, verify that all parts are included and check your computer and network environment.

#### Package Contents

- (1) SWL-1000N(PCMCIA) or 1000D(ISA)
- (2) SWL-1000AP((On purchasing Access Point, a SWL-1000N or SWL-1000D adapter card added)
- (3) Users Manual
- (4) A Network Driver and Utility Disk
- (5) Power Cable (SWL-1000AP only)
- (6) A System booting Disk (SWL-1000AP only)
- (7) External Antenna (SWL-1000D only)

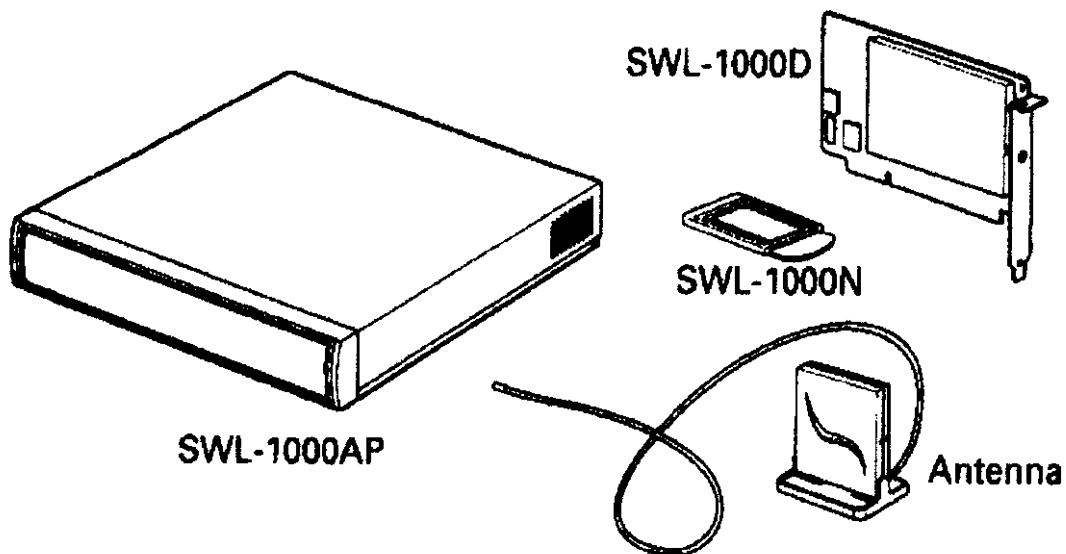

#### PC configuration

For the SWL-1000D, verify that your computer has an extra IRQ I/O Address. SWL-1000D is ISA Plug&Play card supporting IRQ 9,10,11,12. Some multimedia PC may not have an extra IRQ.

#### Required Equipment for Network Connection

- . If you want to use Ad-Hoc Network, you can install with only SWL-1000D,1000N adapter cards.
- . If you want to use Infrastructure Network, you must install Access Point(SWL-1000AP) first.

Equipment required to install Access Point is

- (1) Access Point (SWL-1000AP)



- (2) PCMCIA Wireless LAN adapter card (SWL-1000N, or SWL-1000D and External Antenna)
- (3) Access Point system booting disk.

## HARDWARE INSTALLATION

### Desktop PC adapter card (SWL-1000D)

1. Turn the PC off, uncover the case, and remove the Dummy Bracket of the empty expansion ISA slot.
2. Insert carefully a MagicWave wireless LAN card to the PC slot and turn the screw to fix it tightly.
3. Then, insert the antenna to the antenna port protruding from the back of the PC as in the following picture.
4. Turn the PC on and confirm that the adapter card is recognized by the PC by checking the LED before you put the cover over the PC.

\* verification procedure through LED

Red LED : power LED, lights when the computer turns on.

Orange LED : blinks when receiving data.

green LED : blinks when transmitting data.

The card is operating normally when an orange and a green LED's blink alternately.

- \* After inserting the card, install the device driver following the instruction. If a message that the PC failed to recognize the card appears, check the card by following the procedure "Magicwave diagnostics" on page 56. Contact your local service centre for further help.

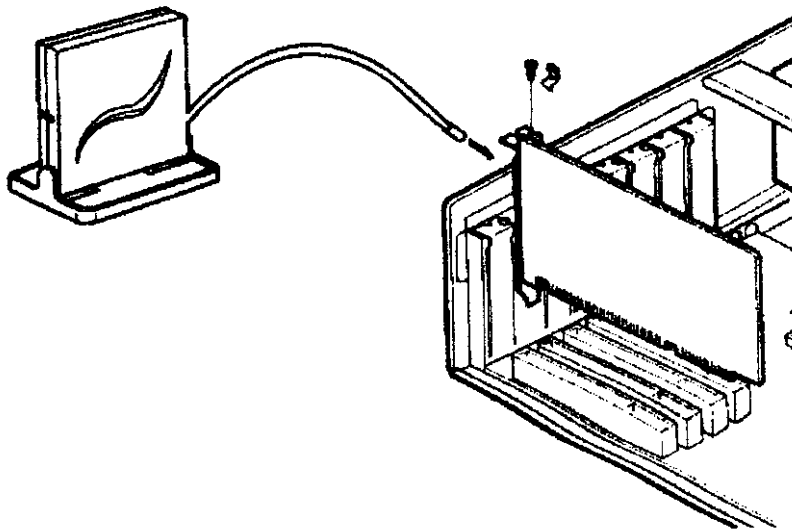

- \* An SWL-1000D supports ISA Plug and Play. The card is automatically recognized and installed in Windows 95 environment. If your system does not support the Plug and Play, you can use the utility for ISA PnP (not included in the package).

### Note-PC adapter card (SWL-1000N)

You can insert the card into note-PC while the power is on or off.

- . When inserting the card while using your notebook PC.

Insert the SWL-1000N adapter card into the PCMCIA slot. A pleasant "chirp" sound indicates the regular operation. A low monotonous tone indicates a failure of the recognition.

- . When inserting the card before turning your notebook PC on.

The success or failure of the card recognition is also indicated by the sound as above. If the card is successfully recognized, install the device driver following the instructions on page 29.

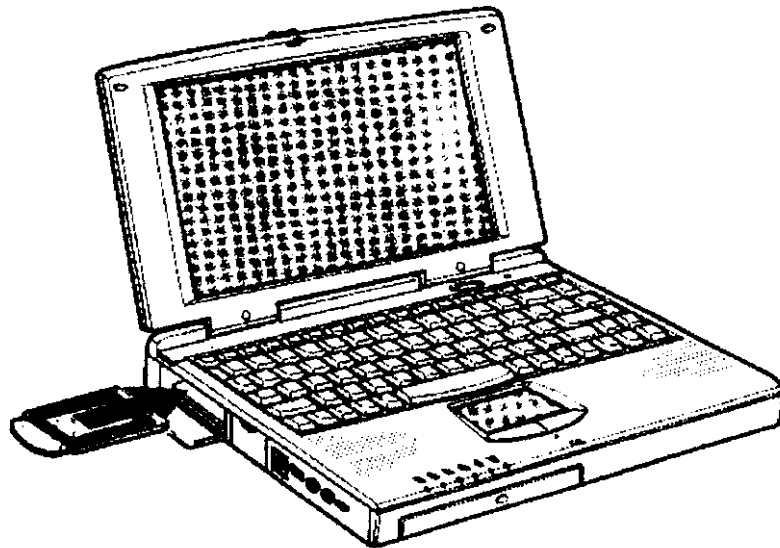

### Access Point (SWL-1000AP)

A MagicWave Access Point connects a MagicWave wireless LAN to existing wired LAN as explained before.

An Access Point is equipped with an Ethernet adapter card supporting 10base-T, 10base2 and a MagicWave wireless LAN adapter card.

Installation can be done easily as follows:

1. Verify that 220V is selected and plug the power cord into the socket.
2. Connect the network cable to Ethernet card port(10base-T or 10base2) on the back of the Access Point.
3. Make sure that you hear the nice ascending tones, and check if the LED on the back of the adapter card blinks after the system is booted.
4. The Access Point is working normally if the red LED is on, and the green LED is blinking.

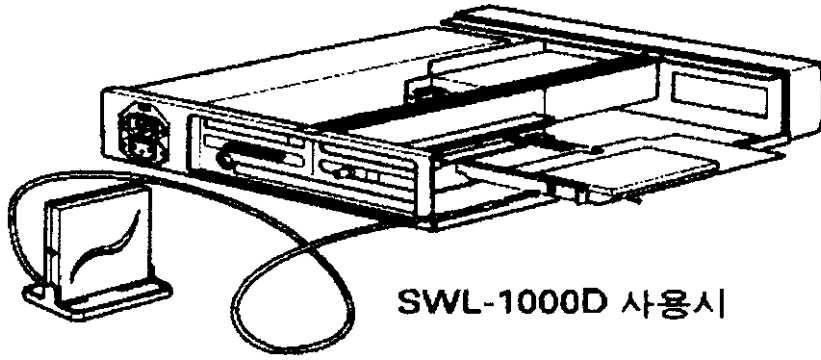

SWL-1000D 사용시

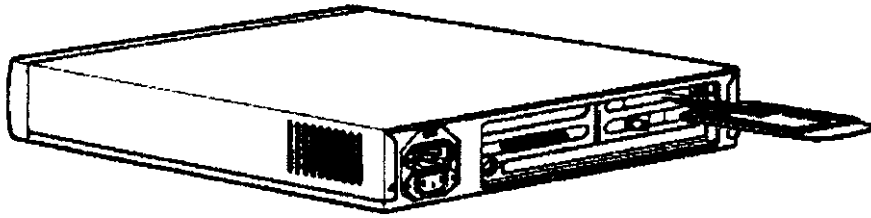

## Section 4. MagicWave Access Point Installation Guide and Manual.

### SETTING UP THE ACCESS POINT

In order to connect SWL-1000AP to the existing Ethernet to build an infrastructure network you must modify CONFIG.TXT in the booting disk.

#### Format of CONFIG.TXT

CONFIG.TXT comprises a start line, an end line and parameter lines.

Each line is of the form :

%PARAMETER : VALUE

The slash character "/" is a comment delimiter. All text after the slash character and up to the end of the line will be ignored. The file must start with the line %SWL-1000AP and finish with the line %END.

It is recommended to make and use a backup diskette and keep the original system diskette in a safe place.

```
%SWL-1000AP / config file

%REV : 100

/ SAMSUNG SWL-1000AP

%RTS_THRESHOLD: 2301
%SHORT_RETRY: 15
%LONG_RETRY: 15
%CHANNEL: 3
%ESS_ID: SAMSUNG
%LOCALIP: 123.45.67.89
%SERIAL: 12345
%GATEWAY: 123.45.67.1

%END
```

## Parameter Descriptions

The available parameters are described below. Some parameters can be ignored but are assigned by default values.

%REV: must be contained in config.txt and identifies the version of the software on the booting diskette. This field is read by a software and better not be modified by the user.

%RTS\_THRESHOLD: determines the size of RTS(Request-To-Send)/CTS(Clear-To-Send) frames and the frames to be used. Normally assigned by the default value 2301.

%SHORT\_RETRY: specifies the number of the transmissions of RTS/CTS which will be attempted before aborting when the communication between clients is interfered. Note that RTS/CTS are delivered back and forth between the clients to monitor the channel for the possibility of communications. The default value is 15.

%LONG\_RETRY: specifies the number of trials of the data retransmissions when the channel or a client causes the cease of data transmissions. The default value is 15, which is the same as that for Ethernet.

%CHANNEL: specifies the operating channel number for the SWL-1000AP (Any channel between 1 and 13 can be used, but the channels used by adjacent Access Points should be apart by more than 5 channels.)

%ESS\_ID: is used to name the wireless LAN group. The default value is SAMSUNG but can be arbitrarily assigned by the user. Its value must be the same as that of its clients. So if the roaming is to be supported, the value of ESS\_ID of all the Access Points should be the same.

%LOCALIP: is needed when a user manages the Access Point by Telnet or uses web manager utilities. A user can access a manage program for the Access Point by putting in the assigned IP address on Telnet or on web browser.

%SERIAL: is serial number for the unit and must be filled. A SWL-1000AP will not boot if the serial number does not match.

%GATEWAY: is needed to connect to an external network by using the TCP/IP protocol. SWL-1000AP stores all the IP addresses received from TCP/IP ARP (Address Resolution Protocol) message. If the destination is an IP address instead of a local network, the packets are sent to a gateway.

## **MAGICWAVE TROUBLESHOOTING.**

If the Magicwave Access Point does not operate normally, the following examples of diagnoses can help:

1. When the unit fails to power on:

- . Make sure that the power cord is fully seated in the socket on the back of the unit.

2. When the unit fails to boot:

- Check the installation floppy disk. Insert the diskette in a computer and use the commands CHKDSK or SCANDISK to check the files.
- If no problem is found with the floppy diskette, please contact your local service centre or the retailer where you purchased the unit.

3. When the unit boots but plays a discordant sound.

- This indicates that the unit failed to initialize. The most likely cause is that the radio card is not installed properly or is installed in a wrong slot.
- Make sure that the radio card is properly installed and then boot the system again.

4. When the unit plays a nice "chirp" sound but fails to communicate.

- The most likely cause is bad configurations of the portable units or LAN attached to computers.
- Check the states of SWL-1000D or SWL-1000N that is installed in the Access Point (SWL-1000AP).

## MAGICWAVE ACCESS POINT WEB MANAGER UTILITY

MagicWave Access Point Web Manager can be accessed through Internet Explorer Web Browser, and its URL is the address specified as the Local IP in CONFIG.TXT of the Access Point.

- URL(Uniform Resource Locator) : The address of the location where the information of web manager is.
- The new contents of the Access Point web page are not automatically loaded, so press "refresh" or "reload" button for an updated information.

## FCC Notice

The SWL-1000D and the SWL-1000N complies with Part 15 of the FCC Rules. Operation is subject to the following two conditions: (1) This device may not cause harmful interference. and (2) this device must accept any interference received, including interference that may cause undesired operation.

Note: The SWL-1000N and SWL-1000D have been tested and found to comply with the limits for a Class B digital device and a low power transmitter, pursuant to Part 15 of the FCC Rules. These limits are designed to provide reasonable protection against harmful interference in a residential installation. This equipment generates, uses and can radiate radio frequency energy and, if not installed and used in accordance with the instructions, may cause harmful interference to radio communications. However, there is no guarantee that interference will not occur in a particular installation. If this equipment does cause harmful interference to radio or television reception, which can be determined by turning the equipment off and on, the user is encouraged to try to correct the interference by one or more of the following measures:

- Reorient or relocate the receiving antenna.
- Increase the separation between the equipment and receiver.
- Connect the equipment into an output on a circuit different from that to which the receiver is connected.
- Consult the dealer or an experienced radio/TV technician for help.

The SWL-1000D was tested and found to comply with the limits for a Class B digital device, however it is not certified for residential use by the FCC. The SWL-1000D is authorized only for use in commercial and industrial installations only.

The SWL-1000N is authorized only for use in all installations.