

ELECTROMAGNETIC EMISSIONS COMPLIANCE REPORT

INTENTIONAL RADIATOR CERTIFICATION TO FCC PART 22 SUBPART H, PART 24 SUBPART E and PART 27

OF

Product Name: Smart Phone

Brand Name: Dell

Model No.: V04B

FCC ID: E2KV04B001

Report No.: EH/2011/A0015

Issue Date: Nov. 14, 2011

FCC Rule Part: 2 , 22H, 24E &27

Prepared for: Dell Inc.
One Dell Way, Round Rock, TX 78682

Prepared by: SGS Taiwan Ltd.
Electronics & Communication Laboratory
No. 134, Wu Kung Rd., Wuku Industrial
Zone, Taipei County, Taiwan.

Note: This report shall not be reproduced except in full, without the written approval of SGS Taiwan Ltd. This document may be altered or revised by SGS Taiwan Ltd. personnel only, and shall be noted in the revision section of the document.

Unless otherwise stated the results shown in this test report refer only to the sample(s) tested and such sample(s) are retained for 90 days only.

除非另有說明，此報告結果僅對測試之樣品負責，同時此樣品僅保留90天。本報告未經本公司書面許可，不可部份複製。

This document is issued by the Company subject to its General Conditions of Service printed overleaf, available on request or accessible at www.sgs.com/terms_and_conditions.htm and, for electronic format documents, subject to Terms and Conditions for Electronic Documents at www.sgs.com/terms_e-document.htm. Attention is drawn to the limitation of liability, indemnification and jurisdiction issues defined therein. Any holder of this document is advised that information contained hereon reflects the Company's findings at the time of its intervention only and within the limits of Client's instructions, if any. The Company's sole responsibility is to its Client and this document does not exonerate parties to a transaction from exercising all their rights and obligations under the transaction documents. This document cannot be reproduced except in full, without prior written approval of the Company. Any unauthorized alteration, forgery or falsification of the content or appearance of this document is unlawful and offenders may be prosecuted to the fullest extent of the law.

VERIFICATION OF COMPLIANCE

Applicant: Dell Inc.
One Dell Way, Round Rock, TX 78682

Product Name: Smart Phone

Brand Name: Dell

FCC ID: E2KV04B001

Model No.: V04B

Model Difference: N/A

File Number: EH/2011/A0015

Date of test: Oct. 20, 2011 ~ Nov. 13, 2011

Date of EUT Received: Oct. 20, 2011

We hereby certify that:

The above equipment was tested by SGS Taiwan Ltd. Electronics & Communication Laboratory. The test data, data evaluation, test procedures, and equipment configurations shown in this report were made in accordance with the procedures given in TIA/EIA-603-C-2004 and the energy emitted by the sample EUT tested as described in this report is in compliance with conducted and radiated emission limits of FCC Rule FCC PART 22 subpart H, PART 24 subpart E and PART 27.

The test results of this report relate only to the tested sample identified in this report.

Test By: *Lion Wang* **Date:** Nov. 14, 2011

Lion Wang / Engineer

Prepared By: *Gigi yeh* **Date:** Nov. 14, 2011

Gigi Yeh / Clerk

Approved By *Jim Chang* **Date:** Nov. 14, 2011

Jim Chang / Supervisor

Unless otherwise stated the results shown in this test report refer only to the sample(s) tested and such sample(s) are retained for 90 days only.

除非另有說明，此報告結果僅對測試之樣品負責，同時此樣品僅保留90天。本報告未經本公司書面許可，不可部份複製。

This document is issued by the Company subject to its General Conditions of Service printed overleaf, available on request or accessible at www.sgs.com/terms_and_conditions.htm and for electronic format documents, subject to Terms and Conditions for Electronic Documents at www.sgs.com/terms_e-document.htm. Attention is drawn to the limitation of liability, indemnification and jurisdiction issues defined therein. Any holder of this document is advised that information contained hereon reflects the Company's findings at the time of its intervention only and within the limits of Client's instructions, if any. The Company's sole responsibility is to its Client and this document does not exonerate parties to a transaction from exercising all their rights and obligations under the transaction documents. This document cannot be reproduced except in full, without prior written approval of the Company. Any unauthorized alteration, forgery or falsification of the content or appearance of this document is unlawful and offenders may be prosecuted to the fullest extent of the law.

SGS Taiwan Ltd. No.134, Wu Kung Road, Wuku Industrial Zone, Taipei County, Taiwan / 台北縣五股工業區五工路 134 號

台灣檢驗科技股份有限公司

t (886-2) 2299-3279

f (886-2) 2298-0488

www.tw.sgs.com

Member of SGS Group

Version

Version No.	Date	Description
00	Nov. 14, 2011	Initial creation of document

Unless otherwise stated the results shown in this test report refer only to the sample(s) tested and such sample(s) are retained for 90 days only.

除非另有說明，此報告結果僅對測試之樣品負責，同時此樣品僅保留90天。本報告未經本公司書面許可，不可部份複製。

This document is issued by the Company subject to its General Conditions of Service printed overleaf, available on request or accessible at www.sgs.com/terms_and_conditions.htm and, for electronic format documents, subject to Terms and Conditions for Electronic Documents at www.sgs.com/terms_e-document.htm. Attention is drawn to the limitation of liability, indemnification and jurisdiction issues defined therein. Any holder of this document is advised that information contained hereon reflects the Company's findings at the time of its intervention only and within the limits of Client's instructions, if any. The Company's sole responsibility is to its Client and this document does not exonerate parties to a transaction from exercising all their rights and obligations under the transaction documents. This document cannot be reproduced except in full, without prior written approval of the Company. Any unauthorized alteration, forgery or falsification of the content or appearance of this document is unlawful and offenders may be prosecuted to the fullest extent of the law.

SGS Taiwan Ltd. No.134, Wu Kung Road, Wuku Industrial Zone, Taipei County, Taiwan / 台北縣五股工業區五工路 134 號

台灣檢驗科技股份有限公司 t (886-2) 2299-3279

f (886-2) 2298-0488

www.tw.sgs.com

Member of SGS Group

Table of Contents

1. GENERAL PRODUCT INFORMATION	6
1.1. Related Submittal(s) / Grant (s)	8
1.2. Test Methodology	8
1.3. Test Facility	8
1.4. Special Accessories	8
1.5. Equipment Modifications.....	8
2. SYSTEM TEST CONFIGURATION	9
2.1. EUT Configuration	9
2.2. EUT Exercise	9
2.3. Test Procedure.....	9
2.4. Measurement Equipment Used:	10
2.5. Configuration of Tested System.....	12
3. SUMMARY OF TEST RESULTS	13
4. DESCRIPTION OF TEST MODES	14
5. MEASUREMENT UNCERTAINTY FOR FIELD STRENGTH OF	15
SPURIOUS RADIATION	15
6. RF POWER OUTPUT MEASUREMENT	16
6.1. Standard Applicable:	16
6.2. Test Set-up:	17
6.3. Measurement Procedure:	17
6.4. Measurement Equipment Used:	17
6.5. Measurement Result:	18
7. ERP, EIRP MEASUREMENT	25
7.1. Standard Applicable:	25
7.2. Test SET-UP (Block Diagram of Configuration):	25
7.3. Measurement Procedure:	27
7.4. Measurement Equipment Used:	27
7.5. Measurement Result:	28
8. 99% OCCUPIED BANDWIDTH MEASUREMENT	37
8.1. Standard Applicable:	37
8.2. Test Set-up:	37
8.3. Measurement Procedure:	37
8.4. Measurement Equipment Used:	37
8.5. Measurement Result:	38

Unless otherwise stated the results shown in this test report refer only to the sample(s) tested and such sample(s) are retained for 90 days only.

除非另有說明，此報告結果僅對測試之樣品負責，同時此樣品僅保留90天。本報告未經本公司書面許可，不可部份複製。

This document is issued by the Company subject to its General Conditions of Service printed overleaf, available on request or accessible at www.sgs.com/terms_and_conditions.htm and for electronic format documents, subject to Terms and Conditions for Electronic Documents at www.sgs.com/terms_e-document.htm. Attention is drawn to the limitation of liability, indemnification and jurisdiction issues defined therein. Any holder of this document is advised that information contained hereon reflects the Company's findings at the time of its intervention only and within the limits of Client's instructions, if any. The Company's sole responsibility is to its Client and this document does not exonerate parties to a transaction from exercising all their rights and obligations under the transaction documents. This document cannot be reproduced except in full, without prior written approval of the Company. Any unauthorized alteration, forgery or falsification of the content or appearance of this document is unlawful and offenders may be prosecuted to the fullest extent of the law.

SGS Taiwan Ltd. No.134, Wu Kung Road, Wuku Industrial Zone, Taipei County, Taiwan / 台北縣五股工業區五工路 134 號

台灣檢驗科技股份有限公司

t (886-2) 2299-3279

f (886-2) 2298-0488

www.tw.sgs.com

Member of SGS Group

9. OUT OF BAND EMISSION AT ANTENNA TERMINALS54

9.1. Standard Applicable:54

9.2. Test SET-UP:.....54

9.3. Measurement Procedure:54

9.4. Measurement Equipment Used:54

9.5. Measurement Result:55

10. FIELD STRENGTH OF SPURIOUS RADIATION MEASUREMENT91

10.1. Standard Applicable:91

10.2. EUT Setup (Block Diagram of Configuration):.....91

10.3. Measurement Procedure:91

10.4. Measurement Equipment Used:91

10.5. Measurement Result:91

11. FREQUENCY STABILITY V.S. TEMPERATURE MEASUREMENT110

11.1. Standard Applicable:110

11.2. Test Set-up:110

11.3. Measurement Procedure:110

11.4. Measurement Equipment Used:110

11.5. Measurement Result:111

12. FREQUENCY STABILITY V.S. VOLTAGE MEASUREMENT113

12.1. Standard Applicable:113

12.2. Test Set-up:113

12.3. Measurement Procedure:113

12.4. Measurement Equipment Used:113

12.5. Measurement Result:114

PHOTOGRAPHS OF SET UP115

PHOTOGRAPHS OF EUT117

Unless otherwise stated the results shown in this test report refer only to the sample(s) tested and such sample(s) are retained for 90 days only.

除非另有說明，此報告結果僅對測試之樣品負責，同時此樣品僅保留90天。本報告未經本公司書面許可，不可部份複製。

This document is issued by the Company subject to its General Conditions of Service printed overleaf, available on request or accessible at www.sgs.com/terms_and_conditions.htm and for electronic format documents, subject to Terms and Conditions for Electronic Documents at www.sgs.com/terms_e-document.htm. Attention is drawn to the limitation of liability, indemnification and jurisdiction issues defined therein. Any holder of this document is advised that information contained hereon reflects the Company's findings at the time of its intervention only and within the limits of Client's instructions, if any. The Company's sole responsibility is to its Client and this document does not exonerate parties to a transaction from exercising all their rights and obligations under the transaction documents. This document cannot be reproduced except in full, without prior written approval of the Company. Any unauthorized alteration, forgery or falsification of the content or appearance of this document is unlawful and offenders may be prosecuted to the fullest extent of the law.

1. GENERAL PRODUCT INFORMATION

General:

Product Name:	Smart Phone	
Brand Name:	Dell	
Model No.:	V04B	
Model Difference:	N/A	
Simple Hands-Free:	Model No.: DA80 525283 FOSTER, Supplier: PCH	
Data Cable / USB Cable:	Model No.: G6YM1, Supplier: PCH	
Power Supply:	3.7Vdc Li-ion battery or 5Vdc by AC/DC power adapter	
	Battery:	Model No.: V04B, Supplier: Dell
	Adapter:	Model No.: 32HD9, Supplier: PCH

GSM and WCDMA:

	Operating Frequency		Rated Power
Cellular Phone Standards Frequency Range and Power	GSM/GPRS 850 Class 12	824 MHz– 849MHz	32.5 dBm
	GSM/GPRS 1900 Class 12	1850MHz – 1910MHz	29.5 dBm
	EDGE 850, Class 12	824 MHz– 849MHz	27 dBm
	EDGE 1900, Class 12	1850MHz – 1910MHz	26 dBm
	WCDMA/HSUPA/HSDPA Band IV	1712.4MHz –1752.6MHz	23 dBm
	HSUPA data rate: uplink up to 2Mbps HSDPA data rate: downlink up to 7.2Mbps		
Hardware Version:	N/A		
Software Version:	N/A		
Type of Emission	GSM 850: 248KGXW, GSM 1900: 246KGXW EDGE 850: 248KG7W, EDGE 1900: 250KG7W GPRS 850: 245KG7W, GPRS 1900: 246KG7W WCDMA Band IV: 4M14F9W, HSUPA Band IV: 4M14F9W HSDPA Band IV: 4M14F9W		
IMEI	358862040005275		

Unless otherwise stated the results shown in this test report refer only to the sample(s) tested and such sample(s) are retained for 90 days only.

除非另有說明，此報告結果僅對測試之樣品負責，同時此樣品僅保留90天。本報告未經本公司書面許可，不可部份複製。

This document is issued by the Company subject to its General Conditions of Service printed overleaf, available on request or accessible at www.sgs.com/terms_and_conditions.htm and for electronic format documents, subject to Terms and Conditions for Electronic Documents at www.sgs.com/terms_e-document.htm. Attention is drawn to the limitation of liability, indemnification and jurisdiction issues defined therein. Any holder of this document is advised that information contained hereon reflects the Company's findings at the time of its intervention only and within the limits of Client's instructions, if any. The Company's sole responsibility is to its Client and this document does not exonerate parties to a transaction from exercising all their rights and obligations under the transaction documents. This document cannot be reproduced except in full, without prior written approval of the Company. Any unauthorized alteration, forgery or falsification of the content or appearance of this document is unlawful and offenders may be prosecuted to the fullest extent of the law.

SGS Taiwan Ltd. No.134, Wu Kung Road, Wuku Industrial Zone, Taipei County, Taiwan / 台北縣五股工業區五工路 134 號

台灣檢驗科技股份有限公司

t (886-2) 2299-3279

f (886-2) 2298-0488

www.tw.sgs.com

Member of SGS Group

Final Amplifier Voltage and Current Information:

Test Mode	DC voltage (V)	DC current (mA)
GSM 850	3.7 Vdc	450
GSM 1900	3.7 Vdc	410
GPRS 850	3.7 Vdc	360
GPRS 1900	3.7 Vdc	350
EDGE 850	3.7 Vdc	300
EDGE 1900	3.7 Vdc	290
WCDMA B4	3.7 Vdc	650
HSUPA B4	3.7 Vdc	570
HSDPA B4	3.7 Vdc	580

This test report applies for GSM/GPRS/EDGE 850/1900 and WCDMA/HSDPA/HSUPA Bands IV.

Unless otherwise stated the results shown in this test report refer only to the sample(s) tested and such sample(s) are retained for 90 days only.

除非另有說明，此報告結果僅對測試之樣品負責，同時此樣品僅保留90天。本報告未經本公司書面許可，不可部份複製。

This document is issued by the Company subject to its General Conditions of Service printed overleaf, available on request or accessible at www.sgs.com/terms_and_conditions.htm and for electronic format documents, subject to Terms and Conditions for Electronic Documents at www.sgs.com/terms_e-document.htm. Attention is drawn to the limitation of liability, indemnification and jurisdiction issues defined therein. Any holder of this document is advised that information contained hereon reflects the Company's findings at the time of its intervention only and within the limits of Client's instructions, if any. The Company's sole responsibility is to its Client and this document does not exonerate parties to a transaction from exercising all their rights and obligations under the transaction documents. This document cannot be reproduced except in full, without prior written approval of the Company. Any unauthorized alteration, forgery or falsification of the content or appearance of this document is unlawful and offenders may be prosecuted to the fullest extent of the law.

1.1. Related Submittal(s) / Grant (s)

This submittal(s) (test report) is intended for FCC ID: **E2KV04B001** filing to comply with Section Part 22 subpart H, Part 24 subpart E and Part 27 of the FCC CFR 47 Rules.

1.2. Test Methodology

Both conducted and radiated testing were performed according to the procedures document of TIA/EIA 603C and FCC CFR 47.1046, 2.1047, 2.1049, 2.1051, 2.1053, 2.1055 and 2.1057.

1.3. Test Facility

The measurement facilities used to collect the 3m Radiated Emission and AC power line conducted data are located on the address of SGS Taiwan Ltd. Electronics & Communication Laboratory No. 134, Wu Kung Rd., Wuku Industrial Zone, Taipei Country, Taiwan which are constructed and calibrated to meet the FCC requirements in documents ANSI C63.4: 2003. FCC Registration Number are: 990257 and 236194, Canada Registration Number: 4620A-4

The 10 m Open Area Test Sites located on the address of SGS Taiwan Ltd. Electronics & Communication Laboratory No. 29, Pau-Tou-Tsuo Valley Chia-Pau Tsuen, Linkou Hsiang, Taipei county, which is constructed and calibrated to meet the CISPR 22/EN 55022 requirements. SGS Site No. 1(3 & 10 meters) and FCC Registration Number: 94644.

All equipment is calibrated externally and traceable to SI (International System of Unit).

1.4. Special Accessories

Not available for this EUT intended for grant.

1.5. Equipment Modifications

Not available for this EUT intended for grant.

Unless otherwise stated the results shown in this test report refer only to the sample(s) tested and such sample(s) are retained for 90 days only.

除非另有說明，此報告結果僅對測試之樣品負責，同時此樣品僅保留90天。本報告未經本公司書面許可，不可部份複製。

This document is issued by the Company subject to its General Conditions of Service printed overleaf, available on request or accessible at www.sgs.com/terms_and_conditions.htm and for electronic format documents, subject to Terms and Conditions for Electronic Documents at www.sgs.com/terms_e-document.htm. Attention is drawn to the limitation of liability, indemnification and jurisdiction issues defined therein. Any holder of this document is advised that information contained hereon reflects the Company's findings at the time of its intervention only and within the limits of Client's instructions, if any. The Company's sole responsibility is to its Client and this document does not exonerate parties to a transaction from exercising all their rights and obligations under the transaction documents. This document cannot be reproduced except in full, without prior written approval of the Company. Any unauthorized alteration, forgery or falsification of the content or appearance of this document is unlawful and offenders may be prosecuted to the fullest extent of the law.

SGS Taiwan Ltd. No.134, Wu Kung Road, Wuku Industrial Zone, Taipei County, Taiwan / 台北縣五股工業區五工路 134 號

台灣檢驗科技股份有限公司

t (886-2) 2299-3279

f (886-2) 2298-0488

www.tw.sgs.com

Member of SGS Group

2. SYSTEM TEST CONFIGURATION

2.1. EUT Configuration

The EUT configuration for testing is installed on RF field strength measurement to meet the Commissions requirement and operating in a manner which intends to maximize its emission characteristics in a continuous normal application.

2.2. EUT Exercise

The EUT (Transmitter) was operated in the engineering mode to fix the Tx frequency which was for the purpose of the measurements.

2.3. Test Procedure

2.3.1 AC Power Line Conducted Emissions

The EUT is placed on a turn table which is 0.8 m above ground plane. According to the requirements in Section 7 and 13 of ANSI C63.4: 2003. Conducted emissions from the EUT measured in the frequency range between 0.15 MHz and 30MHz using CISPR Quasi-Peak and Average detector mode.

2.3.2 Conducted Measurement at Antenna Port:

According to measurement procured TIA/EIA 603C, the EUT is placed on a turn table which is 0.8 m above ground plane. A low loss of RF cable was used to connect the antenna port of EUT to measurement equipment.

2.3.3 Radiated Emissions (ERP/EIRP):

The EUT is a placed on as turn table which is 80 cm above ground plane. The turn table shall rotate 360 degrees to determine the position of maximum emission level. EUT is set 3m away from the receiving antenna which varied from 1m to 4m to find out the highest emission. And also, each emission was to be maximized by changing the polarization of receiving antenna both Horizontal and Vertical. In order to find out the max. emission, the relative positions of this hand-held transmitter (EUT) was rotated through three orthogonal axes and measurement procedures for electric field radiated emissions above 1 GHz the EUT measurement is to be made "while keeping the antenna in the 'cone of radiation' from that area and pointed at the area both in azimuth and elevation, with polarization oriented for maximum response." is still within the 3dB illumination BW of the measurement antenna according to the requirements in Section 2 of TIA/EIA 603C.

Unless otherwise stated the results shown in this test report refer only to the sample(s) tested and such sample(s) are retained for 90 days only.

除非另有說明，此報告結果僅對測試之樣品負責，同時此樣品僅保留90天。本報告未經本公司書面許可，不可部份複製。

This document is issued by the Company subject to its General Conditions of Service printed overleaf, available on request or accessible at www.sgs.com/terms_and_conditions.htm and for electronic format documents, subject to Terms and Conditions for Electronic Documents at www.sgs.com/terms_e-document.htm. Attention is drawn to the limitation of liability, indemnification and jurisdiction issues defined therein. Any holder of this document is advised that information contained hereon reflects the Company's findings at the time of its intervention only and within the limits of Client's instructions, if any. The Company's sole responsibility is to its Client and this document does not exonerate parties to a transaction from exercising all their rights and obligations under the transaction documents. This document cannot be reproduced except in full, without prior written approval of the Company. Any unauthorized alteration, forgery or falsification of the content or appearance of this document is unlawful and offenders may be prosecuted to the fullest extent of the law.

SGS Taiwan Ltd.

No.134, Wu Kung Road, Wuku Industrial Zone, Taipei County, Taiwan / 台北縣五股工業區五工路 134 號

台灣檢驗科技股份有限公司 t (886-2) 2299-3279

f (886-2) 2298-0488

www.tw.sgs.com

Member of SGS Group

2.4. Measurement Equipment Used:

Conducted Emission Test Site					
EQUIPMENT TYPE	MFR	MODEL NUMBER	SERIAL NUMBER	LAST CAL.	CAL DUE.
Spectrum Analyzer	Agilent	E4446A	MY43360126	04/19/2010	04/18/2012
Spectrum Analyzer	Agilent	E4440A	US41160416	01/23/2010	01/22/2012
Radio Communication Analyzer	R&S	CMU200	102189	05/13/2010	05/12/2012
800 – 1000MHz Filter	Micro-Tronics	BRM13462	001	01/05/2011	01/04/2012
1800 – 2000MHz Filter	Micro-Tronics	BRM13463	001	01/05/2011	01/04/2012
Temperature Chamber	TERCHY	MHG-120LF	911009	04/14/2010	04/13/2012
Temperature Chamber	GIANT FORCE	GTH-150-40-CP-AR	MAA0512-018	02/05/2010	02/04/2012
DC Block	Agilent	BLK-18	155452	07/05/2011	07/04/2012
Attenuator	Mini-Circuit	BW-S20W5	N/A	07/05/2011	07/04/2012
Attenuator	Mini-Circuit	BW-S10W5	N/A	07/05/2011	07/04/2012
Attenuator	Mini-Circuit	BW-S6W5	N/A	07/05/2011	07/04/2012
Splitter	Agilent	11636B	N/A	07/05/2011	07/04/2012
DC Power Supply	Chroma	41901	777188	04/17/2010	04/16/2012
Power Meter	Anritsu	ML2495A	1005007	02/17/2010	02/16/2012

Unless otherwise stated the results shown in this test report refer only to the sample(s) tested and such sample(s) are retained for 90 days only.

除非另有說明，此報告結果僅對測試之樣品負責，同時此樣品僅保留90天。本報告未經本公司書面許可，不可部份複製。

This document is issued by the Company subject to its General Conditions of Service printed overleaf, available on request or accessible at www.sgs.com/terms_and_conditions.htm and for electronic format documents, subject to Terms and Conditions for Electronic Documents at www.sgs.com/terms_e-document.htm. Attention is drawn to the limitation of liability, indemnification and jurisdiction issues defined therein. Any holder of this document is advised that information contained hereon reflects the Company's findings at the time of its intervention only and within the limits of Client's instructions, if any. The Company's sole responsibility is to its Client and this document does not exonerate parties to a transaction from exercising all their rights and obligations under the transaction documents. This document cannot be reproduced except in full, without prior written approval of the Company. Any unauthorized alteration, forgery or falsification of the content or appearance of this document is unlawful and offenders may be prosecuted to the fullest extent of the law.

ERP, EIRP MEASUREMENT EQUIPMENT List 966 Chamber					
EQUIPMENT TYPE	MFR	MODEL NUMBER	SERIAL NUMBER	LAST CAL.	CAL DUE.
Spectrum Analyzer	R&S	FSP 40	100034	02/12/2010	02/11/2012
Bilog Antenna	SCHWAZBECK	VULB9160	3136	11/19/2010	11/18/2011
Dipole Antenna	SCHWAZBECK	VHAP	908/909	07/10/2010	07/09/2012
Dipole Antenna	SCHWAZBECK	UHAP	891/892	07/10/2010	07/09/2012
Hor.n antenna	SCHWAZBECK	BBHA 9120D	309	01/22/2010	01/21/2012
Horn antenna	SCHWAZBECK	BBHA 9120D	9120D-673	05/09/2010	05/08/2012
Signal Generator	R&S	SMR40	100210	01/22/2010	01/21/2012
Signal Generator	Agilent	E4438C	MY45093613	06/11/2011	06/10/2012
Pre-Amplifier	Agilent	8447D	1937A02834	11/28/2010	11/27/2011
Pre-Amplifier	Agilent	8449B	3008A01973	01/05/2010	01/04/2012
Attenuator	Mini-Circuit	BW-S20W5	001	07/05/2011	07/04/2012
Attenuator	Mini-Circuit	BW-S10W5	001	07/05/2011	07/04/2012
Attenuator	Mini-Circuit	BW-S6W5	001	07/05/2011	07/04/2012
Radio Communication Analyzer	R&S	CMU200	102189	05/13/2010	05/12/2012
Turn Table	HD	DT420	N/A	N.C.R	N.C.R
Antenna Tower	HD	MA240-N	240/657	N.C.R	N.C.R
Controller	HD	HD100	N/A	N.C.R	N.C.R
Low Loss Cable	HUBER+SUHNER	SUCOFLEX 104PEA-10M	10m	01/05/2011	01/04/2012
Low Loss Cable	HUBER+SUHNER	SUCOFLEX 104PEA-3M	3m	01/05/2010	01/04/2012
Filter 800-1000	Micro-Tronics	BRM13462	1	01/05/2010	01/04/2012
Filter 1800-2000	Micro-Tronics	BRM13463	1	01/05/2010	01/04/2012
3m Site	SGS	966 chamber	N/A	11/09/2011	11/08/2012

Unless otherwise stated the results shown in this test report refer only to the sample(s) tested and such sample(s) are retained for 90 days only.

除非另有說明，此報告結果僅對測試之樣品負責，同時此樣品僅保留90天。本報告未經本公司書面許可，不可部份複製。

This document is issued by the Company subject to its General Conditions of Service printed overleaf, available on request or accessible at www.sgs.com/terms_and_conditions.htm and for electronic format documents, subject to Terms and Conditions for Electronic Documents at www.sgs.com/terms_e-document.htm. Attention is drawn to the limitation of liability, indemnification and jurisdiction issues defined therein. Any holder of this document is advised that information contained hereon reflects the Company's findings at the time of its intervention only and within the limits of Client's instructions, if any. The Company's sole responsibility is to its Client and this document does not exonerate parties to a transaction from exercising all their rights and obligations under the transaction documents. This document cannot be reproduced except in full, without prior written approval of the Company. Any unauthorized alteration, forgery or falsification of the content or appearance of this document is unlawful and offenders may be prosecuted to the fullest extent of the law.

SGS Taiwan Ltd. No.134, Wu Kung Road, Wuku Industrial Zone, Taipei County, Taiwan / 台北縣五股工業區五工路 134 號

台灣檢驗科技股份有限公司 t (886-2) 2299-3279

f (886-2) 2298-0488

www.tw.sgs.com

Member of SGS Group

2.5. Configuration of Tested System

Fig. 2-1 Configuration of Tested System (Fixed Channel)

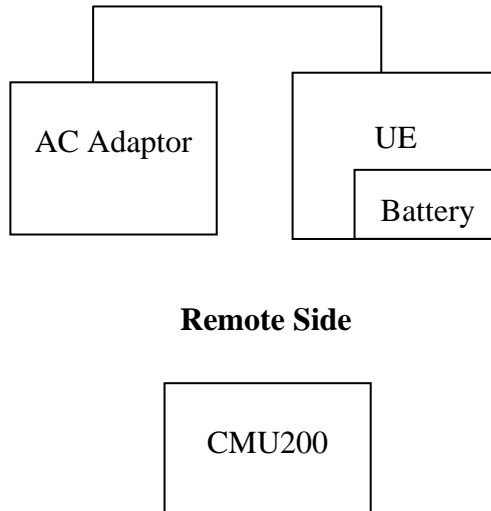

Table 2-1 Equipment Used in Tested System

Item	Equipment	Mfr/Brand	Model/ Type No.	Series No.	Data Cable	Power Cord
1.	Universal Radio Communication Tester	R&S	CMU200	102189	shielded	Un-shielded

Unless otherwise stated the results shown in this test report refer only to the sample(s) tested and such sample(s) are retained for 90 days only.

除非另有說明，此報告結果僅對測試之樣品負責，同時此樣品僅保留90天。本報告未經本公司書面許可，不可部份複製。

This document is issued by the Company subject to its General Conditions of Service printed overleaf, available on request or accessible at www.sgs.com/terms_and_conditions.htm and for electronic format documents, subject to Terms and Conditions for Electronic Documents at www.sgs.com/terms_e-document.htm. Attention is drawn to the limitation of liability, indemnification and jurisdiction issues defined therein. Any holder of this document is advised that information contained hereon reflects the Company's findings at the time of its intervention only and within the limits of Client's instructions, if any. The Company's sole responsibility is to its Client and this document does not exonerate parties to a transaction from exercising all their rights and obligations under the transaction documents. This document cannot be reproduced except in full, without prior written approval of the Company. Any unauthorized alteration, forgery or falsification of the content or appearance of this document is unlawful and offenders may be prosecuted to the fullest extent of the law.

SGS Taiwan Ltd. No.134, Wu Kung Road, Wuku Industrial Zone, Taipei County, Taiwan / 台北縣五股工業區五工路 134 號

台灣檢驗科技股份有限公司 t (886-2) 2299-3279

f (886-2) 2298-0488

www.tw.sgs.com

Member of SGS Group

3. SUMMARY OF TEST RESULTS

FCC Rules	Description Of Test	Result
§2.1046(a)	RF Power Output	Compliant
§2.1046(a) §22.913(a)(2) §24.232(c) §27.50(d)(2)	ERP/ EIRP measurement	Compliant
§2.1049(h)	99% Occupied Bandwidth	Compliant
§2.1051 §22.917(a) §24.238(a) §27.53(g)	Out of Band Emissions at Antenna Terminals and Band Edge	Compliant
§2.1053 §22.917(a) §24.238(a) §27.53(g)	Field Strength of Spurious Radiation	Compliant
§2.1055(a)(1) §22.355 §24.235 §27.54	Frequency Stability vs. Temperature	Compliant
§2.1055(d)(2) §22.355 §24.235 §27.54	Frequency Stability vs. Voltage	Compliant

Unless otherwise stated the results shown in this test report refer only to the sample(s) tested and such sample(s) are retained for 90 days only.

除非另有說明，此報告結果僅對測試之樣品負責，同時此樣品僅保留90天。本報告未經本公司書面許可，不可部份複製。

This document is issued by the Company subject to its General Conditions of Service printed overleaf, available on request or accessible at www.sgs.com/terms_and_conditions.htm and for electronic format documents, subject to Terms and Conditions for Electronic Documents at www.sgs.com/terms_e-document.htm. Attention is drawn to the limitation of liability, indemnification and jurisdiction issues defined therein. Any holder of this document is advised that information contained hereon reflects the Company's findings at the time of its intervention only and within the limits of Client's instructions, if any. The Company's sole responsibility is to its Client and this document does not exonerate parties to a transaction from exercising all their rights and obligations under the transaction documents. This document cannot be reproduced except in full, without prior written approval of the Company. Any unauthorized alteration, forgery or falsification of the content or appearance of this document is unlawful and offenders may be prosecuted to the fullest extent of the law.

SGS Taiwan Ltd. No.134, Wu Kung Road, Wuku Industrial Zone, Taipei County, Taiwan / 台北縣五股工業區五工路 134 號

台灣檢驗科技股份有限公司

t (886-2) 2299-3279

f (886-2) 2298-0488

www.tw.sgs.com

Member of SGS Group

Max ERP/EIRP measurement result:

	dBm	dB	W
GSM 850 Band	25.17	ERP	0.329
GSM 1900 Band	29.32	EIRP	0.855
EDGE 850 Band	23.94	ERP	0.248
EDGE 1900 Band	29.12	EIRP	0.817
GPRS 850 Band	24.91	ERP	0.310
GPRS 1900 Band	30.26	EIRP	1.062
WCDMA Band IV	27.71	EIRP	0.590
HSUPA Band IV	29.22	EIRP	0.836
HSDPA Band IV	29.08	EIRP	0.809

4. DESCRIPTION OF TEST MODES

The EUT has been tested under operating condition.

EUT staying in continuous transmitting mode. Channel Low, Mid and High for each band with rated data rate were chosen for full testing.

The field strength of spurious radiation emission was measured as EUT stand-up position (E1 mode) and lie down position (E1, E2 mode) for GSM/GPRS/EDGE and WCDMA Band 4 with power adaptors. The worst-case of E2 position for GSM 850 band, H position for GPRS 1900, E2 position HSUPA Band IV were reported.

Unless otherwise stated the results shown in this test report refer only to the sample(s) tested and such sample(s) are retained for 90 days only.

除非另有說明，此報告結果僅對測試之樣品負責，同時此樣品僅保留90天。本報告未經本公司書面許可，不可部份複製。

This document is issued by the Company subject to its General Conditions of Service printed overleaf, available on request or accessible at www.sgs.com/terms_and_conditions.htm and for electronic format documents, subject to Terms and Conditions for Electronic Documents at www.sgs.com/terms_e-document.htm. Attention is drawn to the limitation of liability, indemnification and jurisdiction issues defined therein. Any holder of this document is advised that information contained hereon reflects the Company's findings at the time of its intervention only and within the limits of Client's instructions, if any. The Company's sole responsibility is to its Client and this document does not exonerate parties to a transaction from exercising all their rights and obligations under the transaction documents. This document cannot be reproduced except in full, without prior written approval of the Company. Any unauthorized alteration, forgery or falsification of the content or appearance of this document is unlawful and offenders may be prosecuted to the fullest extent of the law.

5. MEASUREMENT UNCERTAINTY FOR FIELD STRENGTH OF SPURIOUS RADIATION

Measurement uncertainty (Polarization : Vertical)	30MHz - 180MHz: 3.37dB
	180MHz -417MHz: 3.19dB
	0.417GHz-1GHz: 3.19dB
	1GHz - 18GHz: 4.04dB
	18GHz - 40GHz: 4.04dB

Measurement uncertainty (Polarization : Horizontal)	30MHz - 167MHz: 4.22dB
	167MHz -500MHz: 3.44dB
	0.5GHz-1GHz: 3.39dB
	1GHz - 18GHz: 4.08dB
	18GHz - 40GHz: 4.08dB

Unless otherwise stated the results shown in this test report refer only to the sample(s) tested and such sample(s) are retained for 90 days only.

除非另有說明，此報告結果僅對測試之樣品負責，同時此樣品僅保留90天。本報告未經本公司書面許可，不可部份複製。

This document is issued by the Company subject to its General Conditions of Service printed overleaf, available on request or accessible at www.sgs.com/terms_and_conditions.htm and for electronic format documents, subject to Terms and Conditions for Electronic Documents at www.sgs.com/terms_e-document.htm. Attention is drawn to the limitation of liability, indemnification and jurisdiction issues defined therein. Any holder of this document is advised that information contained hereon reflects the Company's findings at the time of its intervention only and within the limits of Client's instructions, if any. The Company's sole responsibility is to its Client and this document does not exonerate parties to a transaction from exercising all their rights and obligations under the transaction documents. This document cannot be reproduced except in full, without prior written approval of the Company. Any unauthorized alteration, forgery or falsification of the content or appearance of this document is unlawful and offenders may be prosecuted to the fullest extent of the law.

SGS Taiwan Ltd. No.134, Wu Kung Road, Wuku Industrial Zone, Taipei County, Taiwan / 台北縣五股工業區五工路 134 號

台灣檢驗科技股份有限公司

t (886-2) 2299-3279

f (886-2) 2298-0488

www.tw.sgs.com

Member of SGS Group

6. RF POWER OUTPUT MEASUREMENT

6.1. Standard Applicable:

According to FCC §2.1046.

FCC 22.913(a) Mobile station are limited to 7W.

FCC 24.232(c) Peak Power Measurement limited to 2W

Part 27, 50(d) (2) mobile / portable stations are limited to 1W

3GPP Power limitation for HSDPA and HSUPA

Maximum Output Powers for HSDPA

Sub-test in table C.10.1.4	Power Class 3		Power Class 4	
	Power (dBm)	Tol (dB)	Power (dBm)	Tol (dB)
1	+24	+1.7/-3.7	+21	+2.7/-2.7
2	+24	+1.7/-3.7	+21	+2.7/-2.7
3	+23.5	+2.2/-3.7	+20.5	+3.2/-2.7
4	+23.5	+2.2/-3.7	+20.5	+3.2/-2.7

Maximum Output Powers for HSUPA

Sub-test in table C.11.1.3	Power Class 3		Power Class 4	
	Power (dBm)	Tol (dB)	Power (dBm)	Tol (dB)
1	+24	+1.7/-6.7	+21	+2.7/-5.7
2	+22	+3.7/-5.2	+19	+4.7/-4.2
3	+23	+2.7/-5.2	+20	+3.7/-4.2
4	+22	+3.7/-5.2	+19	+4.7/-4.2
5	+24	+1.7/-6.7	+21	+2.7/-5.7

Unless otherwise stated the results shown in this test report refer only to the sample(s) tested and such sample(s) are retained for 90 days only.

除非另有說明，此報告結果僅對測試之樣品負責，同時此樣品僅保留90天。本報告未經本公司書面許可，不可部份複製。

This document is issued by the Company subject to its General Conditions of Service printed overleaf, available on request or accessible at www.sgs.com/terms_and_conditions.htm and for electronic format documents, subject to Terms and Conditions for Electronic Documents at www.sgs.com/terms_e-document.htm. Attention is drawn to the limitation of liability, indemnification and jurisdiction issues defined therein. Any holder of this document is advised that information contained hereon reflects the Company's findings at the time of its intervention only and within the limits of Client's instructions, if any. The Company's sole responsibility is to its Client and this document does not exonerate parties to a transaction from exercising all their rights and obligations under the transaction documents. This document cannot be reproduced except in full, without prior written approval of the Company. Any unauthorized alteration, forgery or falsification of the content or appearance of this document is unlawful and offenders may be prosecuted to the fullest extent of the law.

6.2. Test Set-up:

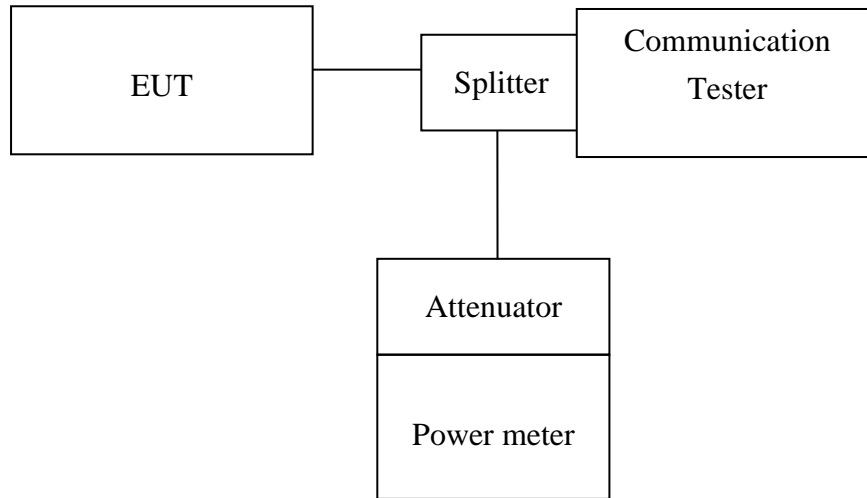

Note: Measurement setup for testing on Antenna connector

6.3. Measurement Procedure:

The transmitter output was connected to a calibrated attenuator, the other end of which was connected to a power meter. Transmitter output was read off the power meter in dBm. The power output at the transmitter antenna port was determined by adding the value of the attenuator to the power meter reading.

6.4. Measurement Equipment Used:

Refer to section 2.4 in this report

Unless otherwise stated the results shown in this test report refer only to the sample(s) tested and such sample(s) are retained for 90 days only.

除非另有說明，此報告結果僅對測試之樣品負責，同時此樣品僅保留90天。本報告未經本公司書面許可，不可部份複製。

This document is issued by the Company subject to its General Conditions of Service printed overleaf, available on request or accessible at www.sgs.com/terms_and_conditions.htm and for electronic format documents, subject to Terms and Conditions for Electronic Documents at www.sgs.com/terms_e-document.htm. Attention is drawn to the limitation of liability, indemnification and jurisdiction issues defined therein. Any holder of this document is advised that information contained hereon reflects the Company's findings at the time of its intervention only and within the limits of Client's instructions, if any. The Company's sole responsibility is to its Client and this document does not exonerate parties to a transaction from exercising all their rights and obligations under the transaction documents. This document cannot be reproduced except in full, without prior written approval of the Company. Any unauthorized alteration, forgery or falsification of the content or appearance of this document is unlawful and offenders may be prosecuted to the fullest extent of the law.

6.5. Measurement Result:

5.5.1 RF Conducted Output Power

5.5.1.1.: GSM/EDGE (GMSK; 8-PSK)

Result:

EUT Mode	Frequency (MHz)	CH	Peak Power (1TS) (dBm)	Average Power (1TS) (dBm)
GSM 850 (GMSK)	824.2	128	32.80	32.70
	836.6	190	32.80	32.70
	848.8	251	32.70	32.60

EUT Mode	Frequency (MHz)	CH	Peak Power (1TS) (dBm)	Peak Power (2TS) (dBm)	Peak Power (3TS) (dBm)	Peak Power (4TS) (dBm)
GPRS 850 (GMSK)	824.2	128	32.90	30.50	28.70	27.40
	836.6	190	33.00	30.90	28.70	27.30
	848.8	251	32.80	30.40	28.80	27.50

EUT Mode	Frequency (MHz)	CH	Average Power (1TS) (dBm)	Average Power (2TS) (dBm)	Average Power (3TS) (dBm)	Average Power (4TS) (dBm)
GPRS 850 (GMSK)	824.2	128	32.80	30.40	28.60	27.30
	836.6	190	32.90	30.80	28.60	27.20
	848.8	251	32.60	30.30	28.70	27.40

Unless otherwise stated the results shown in this test report refer only to the sample(s) tested and such sample(s) are retained for 90 days only.

除非另有說明，此報告結果僅對測試之樣品負責，同時此樣品僅保留90天。本報告未經本公司書面許可，不可部份複製。

This document is issued by the Company subject to its General Conditions of Service printed overleaf, available on request or accessible at www.sgs.com/terms_and_conditions.htm and for electronic format documents, subject to Terms and Conditions for Electronic Documents at www.sgs.com/terms_e-document.htm. Attention is drawn to the limitation of liability, indemnification and jurisdiction issues defined therein. Any holder of this document is advised that information contained hereon reflects the Company's findings at the time of its intervention only and within the limits of Client's instructions, if any. The Company's sole responsibility is to its Client and this document does not exonerate parties to a transaction from exercising all their rights and obligations under the transaction documents. This document cannot be reproduced except in full, without prior written approval of the Company. Any unauthorized alteration, forgery or falsification of the content or appearance of this document is unlawful and offenders may be prosecuted to the fullest extent of the law.

SGS Taiwan Ltd. No.134, Wu Kung Road, Wuku Industrial Zone, Taipei County, Taiwan / 台北縣五股工業區五工路 134 號

台灣檢驗科技股份有限公司 t (886-2) 2299-3279

f (886-2) 2298-0488

www.tw.sgs.com

Member of SGS Group

EUT Mode	Frequency (MHz)	CH	Peak Power (1TS) (dBm)	Peak Power (2TS) (dBm)	Peak Power (3TS) (dBm)	Peak Power (4TS) (dBm)
EDGE 850 (8PSK)	824.2	128	29.60	28.20	26.00	24.80
	836.6	190	29.60	28.30	26.00	24.90
	848.8	251	29.60	28.20	26.00	24.80

EUT Mode	Frequency (MHz)	CH	Average Power (1TS) (dBm)	Average Power (2TS) (dBm)	Average Power (3TS) (dBm)	Average Power (4TS) (dBm)
EDGE 850 (8PSK)	824.2	128	26.40	25.00	22.90	21.70
	836.6	190	26.40	25.10	22.90	21.70
	848.8	251	26.40	25.00	22.80	21.60

EUT Mode	Frequency (MHz)	CH	Peak Power (1TS) (dBm)	Average Power (1TS) (dBm)
GSM 1900 (GMSK)	1850.2	512	29.00	28.90
	1880.0	661	29.00	28.90
	1909.8	810	28.90	28.80

EUT Mode	Frequency (MHz)	CH	Peak Power (1TS) (dBm)	Peak Power (2TS) (dBm)	Peak Power (3TS) (dBm)	Peak Power (4TS) (dBm)
GPRS 1900 (GMSK)	1850.2	512	28.90	27.30	25.00	24.00
	1880.0	661	28.90	27.30	25.10	23.90
	1909.8	810	28.80	27.10	25.10	23.80

Unless otherwise stated the results shown in this test report refer only to the sample(s) tested and such sample(s) are retained for 90 days only.

除非另有說明，此報告結果僅對測試之樣品負責，同時此樣品僅保留90天。本報告未經本公司書面許可，不可部份複製。

This document is issued by the Company subject to its General Conditions of Service printed overleaf, available on request or accessible at www.sgs.com/terms_and_conditions.htm and for electronic format documents, subject to Terms and Conditions for Electronic Documents at www.sgs.com/terms_e-document.htm. Attention is drawn to the limitation of liability, indemnification and jurisdiction issues defined therein. Any holder of this document is advised that information contained hereon reflects the Company's findings at the time of its intervention only and within the limits of Client's instructions, if any. The Company's sole responsibility is to its Client and this document does not exonerate parties to a transaction from exercising all their rights and obligations under the transaction documents. This document cannot be reproduced except in full, without prior written approval of the Company. Any unauthorized alteration, forgery or falsification of the content or appearance of this document is unlawful and offenders may be prosecuted to the fullest extent of the law.

SGS Taiwan Ltd. No.134, Wu Kung Road, Wuku Industrial Zone, Taipei County, Taiwan / 台北縣五股工業區五工路 134 號

台灣檢驗科技股份有限公司 t (886-2) 2299-3279

f (886-2) 2298-0488

www.tw.sgs.com

Member of SGS Group

EUT Mode	Frequency (MHz)	CH	Average Power (1TS) (dBm)	Average Power (2TS) (dBm)	Average Power (3TS) (dBm)	Average Power (4TS) (dBm)
GPRS 1900 (GMSK)	1850.2	512	28.70	27.20	24.90	23.90
	1880.0	661	28.80	27.20	25.00	23.80
	1909.8	810	28.70	27.00	25.00	23.70

EUT Mode	Frequency (MHz)	CH	Peak Power (1TS) (dBm)	Peak Power (2TS) (dBm)	Peak Power (3TS) (dBm)	Peak Power (4TS) (dBm)
EDGE 1900 (8PSK)	1850.2	512	28.00	27.40	25.10	24.00
	1880.0	661	28.40	27.50	25.30	24.20
	1909.8	810	28.20	27.40	25.20	24.10

EUT Mode	Frequency (MHz)	CH	Average Power (1TS) (dBm)	Average Power (2TS) (dBm)	Average Power (3TS) (dBm)	Average Power (4TS) (dBm)
EDGE 1900 (8PSK)	1850.2	512	24.80	24.20	21.90	21.00
	1880.0	661	25.20	24.30	22.10	21.10
	1909.8	810	25.00	27.20	22.00	21.00

Offset:

GSM 1900 & EDGE 1900: 0.5dBm

GSM 850 & EDGE 850: 0.3dBm

Note: TS stands for the time slot of uplink transmission.

Unless otherwise stated the results shown in this test report refer only to the sample(s) tested and such sample(s) are retained for 90 days only.

除非另有說明，此報告結果僅對測試之樣品負責，同時此樣品僅保留90天。本報告未經本公司書面許可，不可部份複製。

This document is issued by the Company subject to its General Conditions of Service printed overleaf, available on request or accessible at www.sgs.com/terms_and_conditions.htm and for electronic format documents, subject to Terms and Conditions for Electronic Documents at www.sgs.com/terms_e-document.htm. Attention is drawn to the limitation of liability, indemnification and jurisdiction issues defined therein. Any holder of this document is advised that information contained hereon reflects the Company's findings at the time of its intervention only and within the limits of Client's instructions, if any. The Company's sole responsibility is to its Client and this document does not exonerate parties to a transaction from exercising all their rights and obligations under the transaction documents. This document cannot be reproduced except in full, without prior written approval of the Company. Any unauthorized alteration, forgery or falsification of the content or appearance of this document is unlawful and offenders may be prosecuted to the fullest extent of the law.

SGS Taiwan Ltd. No.134, Wu Kung Road, Wuku Industrial Zone, Taipei County, Taiwan / 台北縣五股工業區五工路 134 號

台灣檢驗科技股份有限公司 t (886-2) 2299-3279

f (886-2) 2298-0488

www.tw.sgs.com

Member of SGS Group

5.5.1.2: WCDMA mode

The following tests were completed according to the test requirements outlined in section 5.2 of the 3GPP TS34.121-1 V8.4.0 specification. The EUT supports power Class 3, which has a nominal maximum output power of 24 dBm (+1.7/-3.7). RMC 12.2kps is used for this testing.

Results:

UMTS B4	WCDMA		HSDPA		HSUPA	
	PK(dBm)	AV(dBm)	PK(dBm)	AV(dBm)	PK(dBm)	AV(dBm)
CH 1312	26.75	23.00	26.71	22.88	26.74	22.71
CH 1413	26.58	22.86	26.45	22.69	26.40	22.55
CH 1513	26.70	22.83	26.68	22.74	26.64	22.75

Note: The results above reflect max power with all up bits.

Unless otherwise stated the results shown in this test report refer only to the sample(s) tested and such sample(s) are retained for 90 days only.

除非另有說明，此報告結果僅對測試之樣品負責，同時此樣品僅保留90天。本報告未經本公司書面許可，不可部份複製。

This document is issued by the Company subject to its General Conditions of Service printed overleaf, available on request or accessible at www.sgs.com/terms_and_conditions.htm and for electronic format documents, subject to Terms and Conditions for Electronic Documents at www.sgs.com/terms_e-document.htm. Attention is drawn to the limitation of liability, indemnification and jurisdiction issues defined therein. Any holder of this document is advised that information contained hereon reflects the Company's findings at the time of its intervention only and within the limits of Client's instructions, if any. The Company's sole responsibility is to its Client and this document does not exonerate parties to a transaction from exercising all their rights and obligations under the transaction documents. This document cannot be reproduced except in full, without prior written approval of the Company. Any unauthorized alteration, forgery or falsification of the content or appearance of this document is unlawful and offenders may be prosecuted to the fullest extent of the law.

SGS Taiwan Ltd. No.134, Wu Kung Road, Wuku Industrial Zone, Taipei County, Taiwan / 台北縣五股工業區五工路 134 號

台灣檢驗科技股份有限公司

t (886-2) 2299-3279

f (886-2) 2298-0488

www.tw.sgs.com

Member of SGS Group

5.5.13: HSDPA Release 6 mode

The following 4 Sub-Tests were completed according to the test requirements outlined in section 5.2A of the 3GPP TS34.121-1 V8.4.0 specification. All TX power requirements for Power Class 3 were met according to table 5.2AA.5 and 5.2B.5 All UE channels and power ratio's are set according to table C10.1.4 & C11.1.3 in the 3GPP TS34.121-1 V8.4.0. RMC 12.2kps is used for this testing

HSDPA SUB-TEST Setting

Table C.10.1.4: β values for transmitter characteristics tests with HS-DPCCH(FOR HSDPA)

Sub-test	β_c	β_d	β_d (SF)	β_c/β_d	β_{HS} (Note 1, Note 2)	CM (dB) (Note 3)	MPR (dB) (Note 3)	RMC (Kbps)
1	2/15	15/15	64	2/15	4/15	0.0	0.0	12.2
2	12/15 (Note 4)	15/15 (Note 4)	64	12/15 (Note 4)	24/15	1.0	0.0	12.2
3	15/15	8/15	64	15/8	30/15	1.5	0.5	12.2
4	15/15	4/15	64	15/4	30/15	1.5	0.5	12.2

Note: The recommended HSDPA MPRs are implemented as per following sub-tests.

Results:

Mode	Sub-test	Transmitter Power (dBm) Channel			Power Class 3 Limita- tion (dBm)	Comments
		1312	1413	1513		
HSDPA (B4)	1	22.71	22.96	22.67	20.3dBm – 25.7dBm	Pass
	2	22.88	22.72	22.68	20.3dBm – 25.7dBm	Pass
	3	22.23	22.51	22.14	19.8dBm – 25.7dBm	Pass
	4	22.30	22.52	22.26	19.8dBm – 25.7dBm	Pass

Unless otherwise stated the results shown in this test report refer only to the sample(s) tested and such sample(s) are retained for 90 days only.

除非另有說明，此報告結果僅對測試之樣品負責，同時此樣品僅保留90天。本報告未經本公司書面許可，不可部份複製。

This document is issued by the Company subject to its General Conditions of Service printed overleaf, available on request or accessible at www.sgs.com/terms_and_conditions.htm and for electronic format documents, subject to Terms and Conditions for Electronic Documents at www.sgs.com/terms_e-document.htm. Attention is drawn to the limitation of liability, indemnification and jurisdiction issues defined therein. Any holder of this document is advised that information contained hereon reflects the Company's findings at the time of its intervention only and within the limits of Client's instructions, if any. The Company's sole responsibility is to its Client and this document does not exonerate parties to a transaction from exercising all their rights and obligations under the transaction documents. This document cannot be reproduced except in full, without prior written approval of the Company. Any unauthorized alteration, forgery or falsification of the content or appearance of this document is unlawful and offenders may be prosecuted to the fullest extent of the law.

5.5.1.4: HSPA (HSDPA & HSUPA) Release 6 mode

The following 5 Sub-Tests were completed according to the test requirements outlined in section 5.2A of the 3GPP TS34.121-1 V8.4.0 specification. All TX power requirements for Power Class 3 were met according to table 5.2AA.5 and 5.2B.5 All UE channels and power ratio's are set according to table C11.1.3 in the 3GPP TS34.121-1 V8.4.0. RMC 12.2kps is used for this testing

HSPA SUB-TEST Setting

Table C.11.1.3: β values for transmitter characteristics tests with HS-DPCCH and E-DCH(FOR HSUPA)

Sub-test	β_c	β_d	β_d (SF)	β_c/β_d	β_{HS}	β_{ec}	β_{ed}	β_{ed} (SF)	β_{ed} (Codes)	CM (dB)	MPR (dB)	AG Index	E-TFCI	RMC (Kbps)
1	11/15 (Note 3)	15/15 (Note 3)	64	11/15 (Note 3)	22/15	209/225	1309/225	4	1	1.0	0.0	20	75	12.2
2	6/15	15/15	64	6/15	12/15	12/15	94/75	4	1	3.0	2.0	12	67	12.2
3	15/15	9/15	64	15/9	30/15	30/15	β_{ed1} : 47/15 β_{ed2} : 47/15	4 4	2	2.0	1.0	15	92	12.2
4	2/15	15/15	64	2/15	4/15	2/15	56/75	4	1	3.0	2.0	17	71	12.2
5	15/15 (Note 4)	15/15 (Note 4)	64	15/15 (Note 4)	30/15	24/15	134/15	4	1	1.0	0.0	21	81	12.2

Note: The recommended HSUPA are implemented as per following sub-tests.

Results:

Mode	Sub-test	TX Power (dBm) Channel			Power Class 3 Limitation (dBm)	Comments
		1312	1413	1513		
HSUPA(B4)	1	22.92	22.84	22.77	18.8dBm – 25.7dBm	Pass
	2	20.97	20.91	20.81	16.8dBm – 25.7dBm	Pass
	3	21.98	21.86	21.85	17.8dBm – 25.7dBm	Pass
	4	21.10	20.96	20.85	16.8dBm – 25.7dBm	Pass
	5	22.81	22.70	22.68	18.8dBm – 25.7dBm	Pass

Unless otherwise stated the results shown in this test report refer only to the sample(s) tested and such sample(s) are retained for 90 days only.

除非另有說明，此報告結果僅對測試之樣品負責，同時此樣品僅保留90天。本報告未經本公司書面許可，不可部份複製。

This document is issued by the Company subject to its General Conditions of Service printed overleaf, available on request or accessible at www.sgs.com/terms_and_conditions.htm and for electronic format documents, subject to Terms and Conditions for Electronic Documents at www.sgs.com/terms_e-document.htm. Attention is drawn to the limitation of liability, indemnification and jurisdiction issues defined therein. Any holder of this document is advised that information contained hereon reflects the Company's findings at the time of its intervention only and within the limits of Client's instructions, if any. The Company's sole responsibility is to its Client and this document does not exonerate parties to a transaction from exercising all their rights and obligations under the transaction documents. This document cannot be reproduced except in full, without prior written approval of the Company. Any unauthorized alteration, forgery or falsification of the content or appearance of this document is unlawful and offenders may be prosecuted to the fullest extent of the law.

5.5.1 .5Minimum Communications Power Measurement

PCS 1900 band

PCL	0	1	2	3	4	5	6	7	8
Output power (dBm)	28.9	27.3	25.1	23.1	21	18.9	17.2	15.1	12.9
PCL	9	10	11	12	13	14	15	16	17
Output power (dBm)	11.1	9.1	7	5.1	2.9	0.8	-0.1		

Note: The EUT output power was controlled by simulator. Set Communication Tester CMU200 PCL as above, and get the mobile phone output power reading.

WCDMA/HSDPA/HSUPA band IV

The EUT output power was controlled by simulator. Set Communication Tester CMU200 function key “UE Power Control” and enter max rated power 24dBm. The EUT is going to be set to max output power to 24dBm. then record the read(see page 15 for measurement data) . The min. power was measures by a function key “minimum power” then record the read. It is -52.5dBm. The power variation can be 0.1dB step by setting.

Unless otherwise stated the results shown in this test report refer only to the sample(s) tested and such sample(s) are retained for 90 days only.

除非另有說明，此報告結果僅對測試之樣品負責，同時此樣品僅保留90天。本報告未經本公司書面許可，不可部份複製。

This document is issued by the Company subject to its General Conditions of Service printed overleaf, available on request or accessible at www.sgs.com/terms_and_conditions.htm and for electronic format documents, subject to Terms and Conditions for Electronic Documents at www.sgs.com/terms_e-document.htm. Attention is drawn to the limitation of liability, indemnification and jurisdiction issues defined therein. Any holder of this document is advised that information contained hereon reflects the Company's findings at the time of its intervention only and within the limits of Client's instructions, if any. The Company's sole responsibility is to its Client and this document does not exonerate parties to a transaction from exercising all their rights and obligations under the transaction documents. This document cannot be reproduced except in full, without prior written approval of the Company. Any unauthorized alteration, forgery or falsification of the content or appearance of this document is unlawful and offenders may be prosecuted to the fullest extent of the law.

7. ERP, EIRP MEASUREMENT

7.1. Standard Applicable:

According to FCC §2.1046

FCC 22.913(a) Mobile station are limited to 7W ERP.

FCC 24.232(b) Mobile station are limited to 2W EIRP.

FCC 27.50(d)(2) Fixed, mobile, and portable (hand-held) stations are limited to 1W EIRP.

7.2. Test SET-UP (Block Diagram of Configuration):

(A) Radiated Emission Test Set-Up, Frequency Below 1000MHz

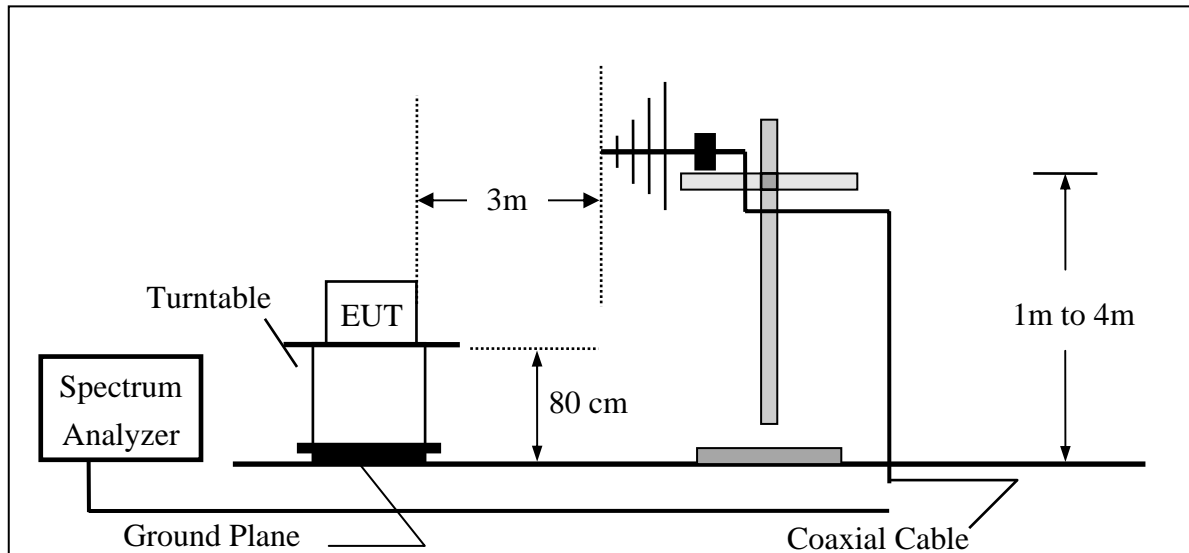

Unless otherwise stated the results shown in this test report refer only to the sample(s) tested and such sample(s) are retained for 90 days only.

除非另有說明，此報告結果僅對測試之樣品負責，同時此樣品僅保留90天。本報告未經本公司書面許可，不可部份複製。

This document is issued by the Company subject to its General Conditions of Service printed overleaf, available on request or accessible at www.sgs.com/terms_and_conditions.htm and for electronic format documents, subject to Terms and Conditions for Electronic Documents at www.sgs.com/terms_e-document.htm. Attention is drawn to the limitation of liability, indemnification and jurisdiction issues defined therein. Any holder of this document is advised that information contained hereon reflects the Company's findings at the time of its intervention only and within the limits of Client's instructions, if any. The Company's sole responsibility is to its Client and this document does not exonerate parties to a transaction from exercising all their rights and obligations under the transaction documents. This document cannot be reproduced except in full, without prior written approval of the Company. Any unauthorized alteration, forgery or falsification of the content or appearance of this document is unlawful and offenders may be prosecuted to the fullest extent of the law.

SGS Taiwan Ltd.

台灣檢驗科技股份有限公司

No.134, Wu Kung Road, Wuku Industrial Zone, Taipei County, Taiwan / 台北縣五股工業區五工路 134 號

t (886-2) 2299-3279

f (886-2) 2298-0488

www.tw.sgs.com

Member of SGS Group

(B) Radiated Emission Test Set-UP Frequency Over 1 GHz

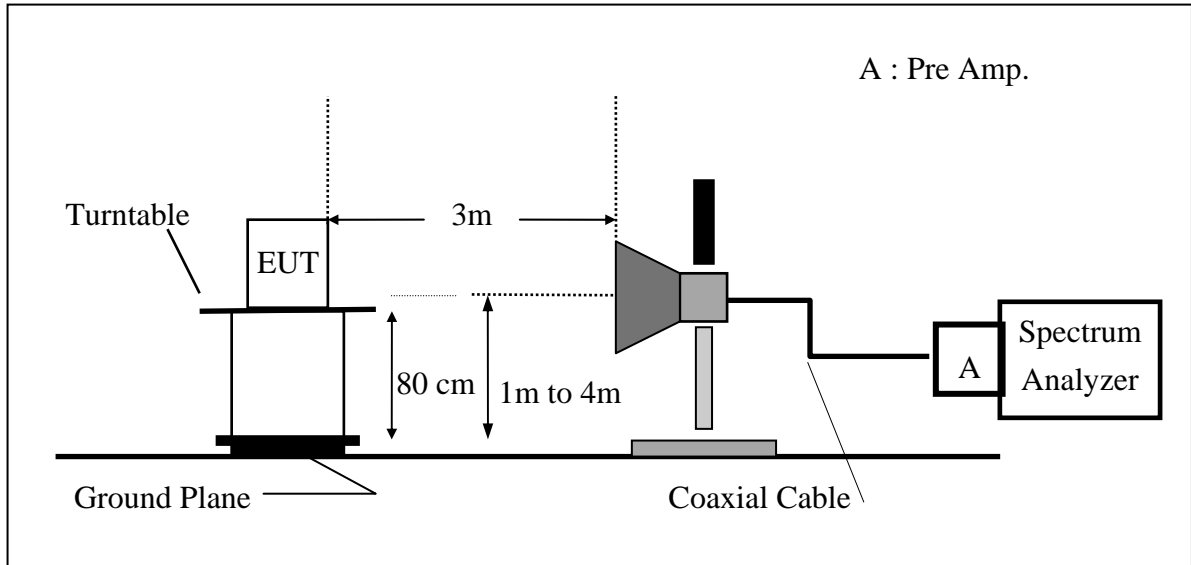

(C) Substituted Method Test Set-UP

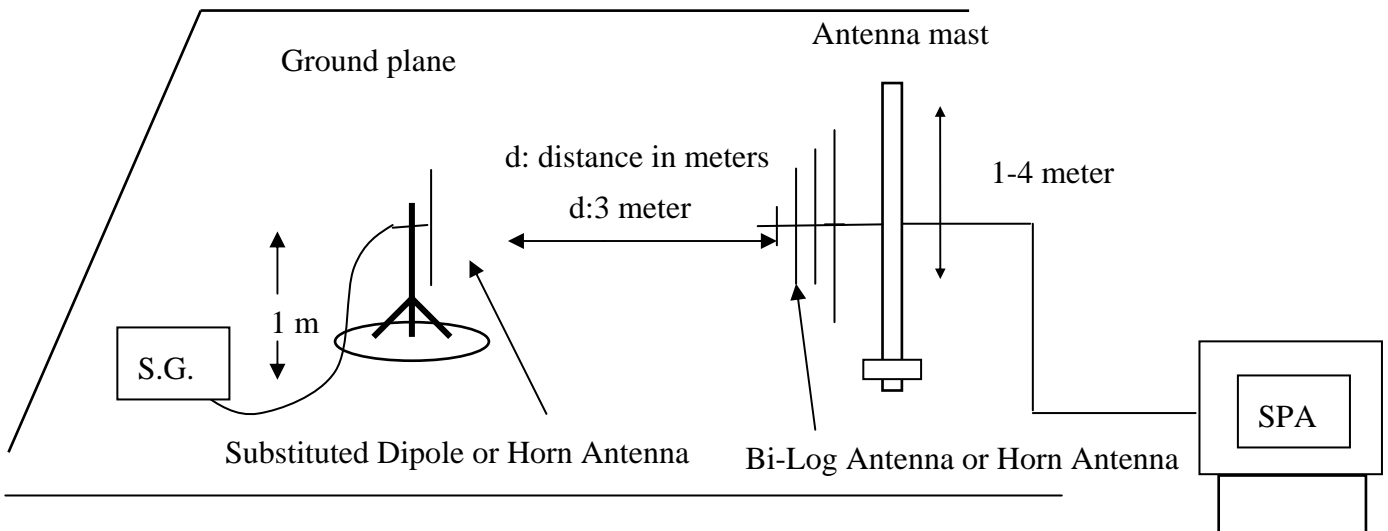

Unless otherwise stated the results shown in this test report refer only to the sample(s) tested and such sample(s) are retained for 90 days only.

除非另有說明，此報告結果僅對測試之樣品負責，同時此樣品僅保留90天。本報告未經本公司書面許可，不可部份複製。

This document is issued by the Company subject to its General Conditions of Service printed overleaf, available on request or accessible at www.sgs.com/terms_and_conditions.htm and for electronic format documents, subject to Terms and Conditions for Electronic Documents at www.sgs.com/terms_e-document.htm. Attention is drawn to the limitation of liability, indemnification and jurisdiction issues defined therein. Any holder of this document is advised that information contained hereon reflects the Company's findings at the time of its intervention only and within the limits of Client's instructions, if any. The Company's sole responsibility is to its Client and this document does not exonerate parties to a transaction from exercising all their rights and obligations under the transaction documents. This document cannot be reproduced except in full, without prior written approval of the Company. Any unauthorized alteration, forgery or falsification of the content or appearance of this document is unlawful and offenders may be prosecuted to the fullest extent of the law.

7.3. Measurement Procedure:

The EUT was placed on a non-conductive turntable using a non-conductive support. The radiated emission at the fundamental frequency was measured at 3 m with a test antenna and EMI spectrum analyzer.

During the measurement, the EUT was in communication with the station. The highest emission was recorded with the rotation of the turntable and the lowering of the test antenna from 4m to 1m. The reading was recorded and the field strength (E in dBuV/m) was calculated.

ERP in frequency band 824.2 –848.80MHz were measured using a substitution method. The EUT was replaced by a dipole antenna connected, the S.G. output was recorded and ERP was calculated as follows:

EIRP in frequency band 1710-1755MHz and 1850.2 –1909.8MHz were measured using a substitution method. The EUT was replaced by a horn antenna connected, the S.G. output was recorded and EIRP was calculated as follows:

$$\text{ERP} = \text{S.G. output (dBm)} + \text{Antenna Gain (dBd)} - \text{Cable Loss (dB)}$$

$$\text{EIRP} = \text{S.G. output (dBm)} + \text{Antenna Gain (dBi)} - \text{Cable Loss (dB)}$$

7.4. Measurement Equipment Used:

Refer to section 2.4 in this report

Unless otherwise stated the results shown in this test report refer only to the sample(s) tested and such sample(s) are retained for 90 days only.

除非另有說明，此報告結果僅對測試之樣品負責，同時此樣品僅保留90天。本報告未經本公司書面許可，不可部份複製。

This document is issued by the Company subject to its General Conditions of Service printed overleaf, available on request or accessible at www.sgs.com/terms_and_conditions.htm and for electronic format documents, subject to Terms and Conditions for Electronic Documents at www.sgs.com/terms_e-document.htm. Attention is drawn to the limitation of liability, indemnification and jurisdiction issues defined therein. Any holder of this document is advised that information contained hereon reflects the Company's findings at the time of its intervention only and within the limits of Client's instructions, if any. The Company's sole responsibility is to its Client and this document does not exonerate parties to a transaction from exercising all their rights and obligations under the transaction documents. This document cannot be reproduced except in full, without prior written approval of the Company. Any unauthorized alteration, forgery or falsification of the content or appearance of this document is unlawful and offenders may be prosecuted to the fullest extent of the law.

7.5. Measurement Result:

EUT				Measurement					
Operation Band	Pol.	Fundamental Frequency	CH	Antenna Pol.	S.G. Output	Antenna Gain	Cable Loss	ERP	Limit
		MHz		V/H	dBm	dBd	dB	dBm	dBm
GSM 850	H	824.20	128	V	24.20	3.96	-4.22	23.94	38.45
				H	23.76	3.96	-4.22	23.50	38.45
		836.60	190	V	24.53	4.00	-4.24	24.29	38.45
				H	23.83	4.00	-4.24	23.59	38.45
		848.80	251	V	24.91	4.03	-4.33	24.61	38.45
				H	24.21	4.03	-4.33	23.91	38.45
	E1	824.20	128	V	20.69	3.96	-4.22	20.43	38.45
				H	24.68	3.96	-4.22	24.43	38.45
		836.60	190	V	21.29	4.00	-4.24	21.05	38.45
				H	24.95	4.00	-4.24	24.71	38.45
		848.80	251	V	21.91	4.03	-4.33	21.61	38.45
				H	25.08	4.03	-4.33	24.78	38.45
	E2	824.20	128	V	20.58	3.96	-4.22	20.32	38.45
				H	25.42	3.96	-4.22	25.16	38.45
		836.60	190	V	20.59	4.00	-4.24	20.35	38.45
				H	25.41	4.00	-4.24	25.17	38.45
		848.80	251	V	20.19	4.03	-4.33	19.89	38.45
				H	25.31	4.03	-4.33	25.01	38.45

Remark :

- (1) The RBW,VBW of SPA for frequency RBW=300 KHz, VBW=1MHz

Unless otherwise stated the results shown in this test report refer only to the sample(s) tested and such sample(s) are retained for 90 days only.

除非另有說明，此報告結果僅對測試之樣品負責，同時此樣品僅保留90天。本報告未經本公司書面許可，不可部份複製。

This document is issued by the Company subject to its General Conditions of Service printed overleaf, available on request or accessible at www.sgs.com/terms_and_conditions.htm and for electronic format documents, subject to Terms and Conditions for Electronic Documents at www.sgs.com/terms_e-document.htm. Attention is drawn to the limitation of liability, indemnification and jurisdiction issues defined therein. Any holder of this document is advised that information contained hereon reflects the Company's findings at the time of its intervention only and within the limits of Client's instructions, if any. The Company's sole responsibility is to its Client and this document does not exonerate parties to a transaction from exercising all their rights and obligations under the transaction documents. This document cannot be reproduced except in full, without prior written approval of the Company. Any unauthorized alteration, forgery or falsification of the content or appearance of this document is unlawful and offenders may be prosecuted to the fullest extent of the law.

EUT				Measurement					
Operation Band	Pol.	Fundamental Frequency	CH	Antenna Pol.	S.G. Output	Antenna Gain	Cable Loss	EIRP	Limit
		MHz		V/H	dBm	dBi	dB	dBm	dBm
GSM 1900	H	1850.20	512	V	28.35	4.17	-5.49	27.03	33.00
				H	30.13	4.51	-5.49	29.16	33.00
		1880.00	661	V	28.44	4.13	-5.56	27.01	33.00
				H	30.45	4.44	-5.56	29.32	33.00
		1909.80	810	V	29.28	4.09	-5.56	27.82	33.00
				H	29.61	4.36	-5.56	28.41	33.00
	E1	1850.20	512	V	29.27	4.17	-5.49	27.95	33.00
				H	23.56	4.51	-5.49	22.58	33.00
		1880.00	661	V	27.66	4.13	-5.56	26.23	33.00
				H	22.81	4.44	-5.56	21.69	33.00
		1909.80	810	V	27.92	4.09	-5.56	26.46	33.00
				H	23.17	4.36	-5.56	21.98	33.00
	E2	1850.20	512	V	30.07	4.17	-5.49	28.76	33.00
				H	28.62	4.51	-5.49	27.64	33.00
		1880.00	661	V	27.57	4.13	-5.56	26.14	33.00
				H	28.06	4.44	-5.56	26.94	33.00
		1909.80	810	V	29.16	4.09	-5.56	27.70	33.00
				H	26.89	4.36	-5.56	25.70	33.00

Remark :

- (1) The RBW,VBW of SPA for frequency RBW=300K, VBW=1MHz

Unless otherwise stated the results shown in this test report refer only to the sample(s) tested and such sample(s) are retained for 90 days only.

除非另有說明，此報告結果僅對測試之樣品負責，同時此樣品僅保留90天。本報告未經本公司書面許可，不可部份複製。

This document is issued by the Company subject to its General Conditions of Service printed overleaf, available on request or accessible at www.sgs.com/terms_and_conditions.htm and for electronic format documents, subject to Terms and Conditions for Electronic Documents at www.sgs.com/terms_e-document.htm. Attention is drawn to the limitation of liability, indemnification and jurisdiction issues defined therein. Any holder of this document is advised that information contained hereon reflects the Company's findings at the time of its intervention only and within the limits of Client's instructions, if any. The Company's sole responsibility is to its Client and this document does not exonerate parties to a transaction from exercising all their rights and obligations under the transaction documents. This document cannot be reproduced except in full, without prior written approval of the Company. Any unauthorized alteration, forgery or falsification of the content or appearance of this document is unlawful and offenders may be prosecuted to the fullest extent of the law.

SGS Taiwan Ltd. No.134, Wu Kung Road, Wuku Industrial Zone, Taipei County, Taiwan / 台北縣五股工業區五工路 134 號

台灣檢驗科技股份有限公司

t (886-2) 2299-3279

f (886-2) 2298-0488

www.tw.sgs.com

Member of SGS Group

EUT				Measurement					
Operation Band	Pol.	Fundamental Frequency	CH	Antenna Pol.	S.G. Output	Antenna Gain	Cable Loss	ERP	Limit
		MHz		V/H	dBm	dBd	dB	dBm	dBm
EDGE 850 (1up)	H	824.20	128	V	21.90	3.96	-4.22	21.64	38.45
				H	21.26	3.96	-4.22	21.00	38.45
		836.60	190	V	22.17	4.00	-4.24	21.93	38.45
				H	21.39	4.00	-4.24	21.15	38.45
		848.80	251	V	22.58	4.03	-4.33	22.28	38.45
				H	21.67	4.03	-4.33	21.37	38.45
	E1	824.20	128	V	18.03	3.96	-4.22	17.77	38.45
				H	22.95	3.96	-4.22	22.69	38.45
		836.60	190	V	18.23	4.00	-4.24	17.99	38.45
				H	23.25	4.00	-4.24	23.01	38.45
		848.80	251	V	18.81	4.03	-4.33	18.51	38.45
				H	23.26	4.03	-4.33	22.96	38.45
	E2	824.20	128	V	17.17	3.96	-4.22	16.91	38.45
				H	23.98	3.96	-4.22	23.72	38.45
		836.60	190	V	17.03	4.00	-4.24	16.79	38.45
				H	24.18	4.00	-4.24	23.94	38.45
		848.80	251	V	17.56	4.03	-4.33	17.26	38.45
				H	23.73	4.03	-4.33	23.43	38.45

Remark :

- (1) The RBW,VBW of SPA for frequency RBW=300 KHz, VBW=1MHz

Unless otherwise stated the results shown in this test report refer only to the sample(s) tested and such sample(s) are retained for 90 days only.

除非另有說明，此報告結果僅對測試之樣品負責，同時此樣品僅保留90天。本報告未經本公司書面許可，不可部份複製。

This document is issued by the Company subject to its General Conditions of Service printed overleaf, available on request or accessible at www.sgs.com/terms_and_conditions.htm and for electronic format documents, subject to Terms and Conditions for Electronic Documents at www.sgs.com/terms_e-document.htm. Attention is drawn to the limitation of liability, indemnification and jurisdiction issues defined therein. Any holder of this document is advised that information contained hereon reflects the Company's findings at the time of its intervention only and within the limits of Client's instructions, if any. The Company's sole responsibility is to its Client and this document does not exonerate parties to a transaction from exercising all their rights and obligations under the transaction documents. This document cannot be reproduced except in full, without prior written approval of the Company. Any unauthorized alteration, forgery or falsification of the content or appearance of this document is unlawful and offenders may be prosecuted to the fullest extent of the law.

EUT				Measurement					
Operation Band	Pol.	Fundamental Frequency	CH	Antenna Pol.	S.G. Output	Antenna Gain	Cable Loss	EIRP	Limit
		MHz		V/H	dBm	dBi	dB	dBm	dBm
EDGE 1900 (1up)	H	1850.20	512	V	27.88	4.17	-5.49	26.56	33.00
				H	30.10	4.51	-5.49	29.12	33.00
		1880.00	661	V	25.68	4.13	-5.56	24.25	33.00
				H	28.99	4.44	-5.56	27.86	33.00
		1909.80	810	V	25.93	4.09	-5.56	24.47	33.00
				H	28.81	4.36	-5.56	27.62	33.00
	E1	1850.20	512	V	28.33	4.17	-5.49	27.02	33.00
				H	22.55	4.51	-5.49	21.57	33.00
		1880.00	661	V	27.08	4.13	-5.56	25.66	33.00
				H	22.66	4.44	-5.56	21.53	33.00
		1909.80	810	V	28.82	4.09	-5.56	27.36	33.00
				H	23.82	4.36	-5.56	22.63	33.00
	E2	1850.20	512	V	29.52	4.17	-5.49	28.2	33.00
				H	27.79	4.51	-5.49	26.82	33.00
		1880.00	661	V	27.14	4.13	-5.56	25.71	33.00
				H	27.55	4.44	-5.56	26.43	33.00
		1909.80	810	V	28.92	4.09	-5.56	27.46	33.00
				H	26.91	4.36	-5.56	25.72	33.00

Remark :

- (1) The RBW,VBW of SPA for frequency RBW=300K, VBW=1MHz

Unless otherwise stated the results shown in this test report refer only to the sample(s) tested and such sample(s) are retained for 90 days only.

除非另有說明，此報告結果僅對測試之樣品負責，同時此樣品僅保留90天。本報告未經本公司書面許可，不可部份複製。

This document is issued by the Company subject to its General Conditions of Service printed overleaf, available on request or accessible at www.sgs.com/terms_and_conditions.htm and for electronic format documents, subject to Terms and Conditions for Electronic Documents at www.sgs.com/terms_e-document.htm. Attention is drawn to the limitation of liability, indemnification and jurisdiction issues defined therein. Any holder of this document is advised that information contained hereon reflects the Company's findings at the time of its intervention only and within the limits of Client's instructions, if any. The Company's sole responsibility is to its Client and this document does not exonerate parties to a transaction from exercising all their rights and obligations under the transaction documents. This document cannot be reproduced except in full, without prior written approval of the Company. Any unauthorized alteration, forgery or falsification of the content or appearance of this document is unlawful and offenders may be prosecuted to the fullest extent of the law.

SGS Taiwan Ltd. No.134, Wu Kung Road, Wuku Industrial Zone, Taipei County, Taiwan / 台北縣五股工業區五工路 134 號

台灣檢驗科技股份有限公司

t (886-2) 2299-3279

f (886-2) 2298-0488

www.tw.sgs.com

Member of SGS Group

EUT				Measurement					
Operation Band	Pol.	Fundamental Frequency	CH	Antenna Pol.	S.G. Output	Antenna Gain	Cable Loss	ERP	Limit
		MHz		V/H	dBm	dBd	dB	dBm	dBm
GPRS 850 (1up)	H	824.20	128	V	24.25	3.96	-4.22	23.99	38.45
				H	21.05	3.96	-4.22	20.79	38.45
		836.60	190	V	24.35	4.00	-4.24	24.11	38.45
				H	21.74	4.00	-4.24	21.50	38.45
		848.80	251	V	25.45	4.03	-4.33	25.15	38.45
				H	22.11	4.03	-4.33	21.81	38.45
	E1	824.20	128	V	22.65	3.96	-4.22	22.39	38.45
				H	22.26	4.00	-4.24	22.02	38.45
		836.60	190	V	24.70	4.00	-4.24	24.46	38.45
				H	23.04	4.03	-4.33	22.74	38.45
		848.80	251	V	24.66	4.03	-4.33	24.36	38.45
				H	22.78	3.96	-4.22	22.52	38.45
	E2	824.20	128	V	24.72	3.96	-4.22	24.46	38.45
				H	23.24	4.00	-4.24	23.00	38.45
		836.60	190	V	25.11	4.00	-4.24	24.87	38.45
				H	22.05	4.03	-4.33	21.75	38.45
848.80		251	V	25.21	4.03	-4.33	24.91	38.45	
			H	24.25	3.96	-4.22	23.99	38.45	

Remark :

- (1) The RBW,VBW of SPA for frequency RBW=300 KHz, VBW=1MHz

Unless otherwise stated the results shown in this test report refer only to the sample(s) tested and such sample(s) are retained for 90 days only.

除非另有說明，此報告結果僅對測試之樣品負責，同時此樣品僅保留90天。本報告未經本公司書面許可，不可部份複製。

This document is issued by the Company subject to its General Conditions of Service printed overleaf, available on request or accessible at www.sgs.com/terms_and_conditions.htm and for electronic format documents, subject to Terms and Conditions for Electronic Documents at www.sgs.com/terms_e-document.htm. Attention is drawn to the limitation of liability, indemnification and jurisdiction issues defined therein. Any holder of this document is advised that information contained hereon reflects the Company's findings at the time of its intervention only and within the limits of Client's instructions, if any. The Company's sole responsibility is to its Client and this document does not exonerate parties to a transaction from exercising all their rights and obligations under the transaction documents. This document cannot be reproduced except in full, without prior written approval of the Company. Any unauthorized alteration, forgery or falsification of the content or appearance of this document is unlawful and offenders may be prosecuted to the fullest extent of the law.

EUT				Measurement					
Operation Band	Pol.	Fundamental Frequency	CH	Antenna Pol.	S.G. Output	Antenna Gain	Cable Loss	EIRP	Limit
		MHz		V/H	dBm	dBi	dB	dBm	dBm
GPRS 1900 (1up)	H	1850.20	512	V	24.70	4.51	-5.49	23.72	33.00
				H	31.57	4.17	-5.49	30.26	33.00
		1880.00	661	V	29.21	4.13	-5.56	27.78	33.00
				H	22.91	4.44	-5.56	21.79	33.00
		1909.80	810	V	22.68	4.36	-5.56	21.49	33.00
				H	30.03	4.09	-5.56	28.57	33.00
	E1	1850.20	512	V	29.57	4.17	-5.49	28.26	33.00
				H	22.78	4.51	-5.49	21.81	33.00
		1880.00	661	V	26.32	4.13	-5.56	24.89	33.00
				H	25.69	4.44	-5.56	24.57	33.00
		1909.80	810	V	26.53	4.09	-5.56	25.07	33.00
				H	24.59	4.36	-5.56	23.40	33.00
	E2	1850.20	512	V	27.71	4.17	-5.49	26.39	33.00
				H	31.18	4.51	-5.49	30.21	33.00
		1880.00	661	V	26.96	4.13	-5.56	25.53	33.00
				H	28.24	4.44	-5.56	27.11	33.00
		1909.80	810	V	27.79	4.09	-5.56	26.33	33.00
				H	28.28	4.36	-5.56	27.09	33.00

Remark :

- (1) The RBW,VBW of SPA for frequency RBW=300K, VBW=1MHz

Unless otherwise stated the results shown in this test report refer only to the sample(s) tested and such sample(s) are retained for 90 days only.

除非另有說明，此報告結果僅對測試之樣品負責，同時此樣品僅保留90天。本報告未經本公司書面許可，不可部份複製。

This document is issued by the Company subject to its General Conditions of Service printed overleaf, available on request or accessible at www.sgs.com/terms_and_conditions.htm and for electronic format documents, subject to Terms and Conditions for Electronic Documents at www.sgs.com/terms_e-document.htm. Attention is drawn to the limitation of liability, indemnification and jurisdiction issues defined therein. Any holder of this document is advised that information contained hereon reflects the Company's findings at the time of its intervention only and within the limits of Client's instructions, if any. The Company's sole responsibility is to its Client and this document does not exonerate parties to a transaction from exercising all their rights and obligations under the transaction documents. This document cannot be reproduced except in full, without prior written approval of the Company. Any unauthorized alteration, forgery or falsification of the content or appearance of this document is unlawful and offenders may be prosecuted to the fullest extent of the law.

EUT				Measurement					
Operation Band	Pol.	Fundamental Frequency	CH	Antenna Pol.	S.G. Output	Antenna Gain	Cable Loss	EIRP	Limit
		MHz		V/H	dBm	dBi	dB	dBm	dBm
WCDMA Band IV	H	1712.40	1312	V	26.96	4.4	-5.40	25.95	30.00
				H	23.98	4.79	-5.40	23.37	30.00
		1732.60	1413	V	25.92	4.35	-5.42	24.85	30.00
				H	23.45	4.78	-5.42	22.81	30.00
		1752.60	1513	V	25.39	4.31	-5.44	24.27	30.00
				H	23.54	4.77	-5.44	22.87	30.00
	E1	1712.40	1312	V	24.22	4.40	-5.40	23.22	30.00
				H	21.75	4.79	-5.40	21.15	30.00
		1732.60	1413	V	25.01	4.35	-5.42	23.94	30.00
				H	23.13	4.78	-5.42	22.48	30.00
		1752.60	1513	V	25.66	4.31	-5.44	24.53	30.00
				H	23.73	4.77	-5.44	23.05	30.00
	E2	1712.40	1312	V	23.55	4.40	-5.40	22.55	30.00
				H	27.82	4.79	-5.4	27.21	30.00
		1732.60	1413	V	22.53	4.35	-5.42	21.45	30.00
				H	28.35	4.78	-5.42	27.71	30.00
		1752.60	1513	V	22.14	4.31	-5.44	21.02	30.00
				H	27.05	4.77	-5.44	26.38	30.00

Remark :

- (1) The RBW,VBW of SPA for frequency RBW= 5MHz , VBW= 8MHz

Unless otherwise stated the results shown in this test report refer only to the sample(s) tested and such sample(s) are retained for 90 days only.

除非另有說明，此報告結果僅對測試之樣品負責，同時此樣品僅保留90天。本報告未經本公司書面許可，不可部份複製。

This document is issued by the Company subject to its General Conditions of Service printed overleaf, available on request or accessible at www.sgs.com/terms_and_conditions.htm and for electronic format documents, subject to Terms and Conditions for Electronic Documents at www.sgs.com/terms_e-document.htm. Attention is drawn to the limitation of liability, indemnification and jurisdiction issues defined therein. Any holder of this document is advised that information contained hereon reflects the Company's findings at the time of its intervention only and within the limits of Client's instructions, if any. The Company's sole responsibility is to its Client and this document does not exonerate parties to a transaction from exercising all their rights and obligations under the transaction documents. This document cannot be reproduced except in full, without prior written approval of the Company. Any unauthorized alteration, forgery or falsification of the content or appearance of this document is unlawful and offenders may be prosecuted to the fullest extent of the law.

EUT				Measurement					
Operation Band	Pol.	Fundamental Frequency	CH	Antenna Pol.	S.G. Output	Antenna Gain	Cable Loss	EIRP	Limit
		MHz		V/H	dBm	dBi	dB	dBm	dBm
HSUPA Band IV	H	1712.40	1312	V	29.75	4.40	-5.40	28.75	30.00
				H	24.85	4.79	-5.40	24.24	30.00
		1732.60	1413	V	27.35	4.36	-5.42	26.28	30.00
				H	24.66	4.78	-5.42	24.02	30.00
		1752.60	1513	V	28.19	4.31	-5.44	27.06	30.00
				H	26.3	4.77	-5.44	25.63	30.00
	E1	1712.40	1312	V	27.18	4.40	-5.40	26.17	30.00
				H	24.63	4.79	-5.40	24.02	30.00
		1732.60	1413	V	26.23	4.35	-5.42	25.16	30.00
				H	24.32	4.78	-5.42	23.68	30.00
		1752.60	1513	V	27.71	4.31	-5.44	26.59	30.00
				H	26.47	4.76	-5.44	25.80	30.00
	E2	1712.40	1312	V	25.39	4.40	-5.40	24.39	30.00
				H	29.83	4.79	-5.40	29.22	30.00
		1732.60	1413	V	23.27	4.35	-5.42	22.20	30.00
				H	29.09	4.78	-5.42	28.45	30.00
		1752.60	1513	V	24.56	4.31	-5.44	23.43	30.00
				H	29.24	4.77	-5.44	28.57	30.00

Remark :

- (1) The RBW,VBW of SPA for frequency RBW= 5MHz , VBW= 8MHz

Unless otherwise stated the results shown in this test report refer only to the sample(s) tested and such sample(s) are retained for 90 days only.

除非另有說明，此報告結果僅對測試之樣品負責，同時此樣品僅保留90天。本報告未經本公司書面許可，不可部份複製。

This document is issued by the Company subject to its General Conditions of Service printed overleaf, available on request or accessible at www.sgs.com/terms_and_conditions.htm and for electronic format documents, subject to Terms and Conditions for Electronic Documents at www.sgs.com/terms_e-document.htm. Attention is drawn to the limitation of liability, indemnification and jurisdiction issues defined therein. Any holder of this document is advised that information contained hereon reflects the Company's findings at the time of its intervention only and within the limits of Client's instructions, if any. The Company's sole responsibility is to its Client and this document does not exonerate parties to a transaction from exercising all their rights and obligations under the transaction documents. This document cannot be reproduced except in full, without prior written approval of the Company. Any unauthorized alteration, forgery or falsification of the content or appearance of this document is unlawful and offenders may be prosecuted to the fullest extent of the law.

EUT				Measurement					
Operation Band	Pol.	Fundamental Frequency	CH	Antenna Pol.	S.G. Output	Antenna Gain	Cable Loss	EIRP	Limit
		MHz		V/H	dBm	dBi	dB	dBm	dBm
HSDPA Band IV	H	1712.40	1312	V	29.42	4.40	-5.40	28.41	30.00
				H	24.75	4.79	-5.40	24.14	30.00
		1732.60	1413	V	27.13	4.35	-5.42	26.06	30.00
				H	24.64	4.78	-5.42	24.00	30.00
		1752.60	1513	V	28.13	4.31	-5.44	27.01	30.00
				H	26.19	4.77	-5.44	25.52	30.00
	E1	1712.40	1312	V	27.03	4.40	-5.40	26.03	30.00
				H	24.45	4.79	-5.40	23.84	30.00
		1732.60	1413	V	26.15	4.35	-5.42	25.08	30.00
				H	24.26	4.78	-5.42	23.62	30.00
		1752.60	1513	V	27.60	4.31	-5.44	26.47	30.00
				H	26.34	4.76	-5.44	25.67	30.00
	E2	1712.40	1312	V	24.83	4.40	-5.40	23.83	30.00
				H	29.69	4.79	-5.4	29.08	30.00
		1732.60	1413	V	23.22	4.35	-5.42	22.15	30.00
				H	29.08	4.78	-5.42	28.44	30.00
		1752.60	1513	V	24.25	4.31	-5.44	23.12	30.00
				H	29.11	4.77	-5.44	28.44	30.00

Remark :

- (1) The RBW,VBW of SPA for frequency RBW= 5MHz , VBW= 8MHz

Unless otherwise stated the results shown in this test report refer only to the sample(s) tested and such sample(s) are retained for 90 days only.

除非另有說明，此報告結果僅對測試之樣品負責，同時此樣品僅保留90天。本報告未經本公司書面許可，不可部份複製。

This document is issued by the Company subject to its General Conditions of Service printed overleaf, available on request or accessible at www.sgs.com/terms_and_conditions.htm and for electronic format documents, subject to Terms and Conditions for Electronic Documents at www.sgs.com/terms_e-document.htm. Attention is drawn to the limitation of liability, indemnification and jurisdiction issues defined therein. Any holder of this document is advised that information contained hereon reflects the Company's findings at the time of its intervention only and within the limits of Client's instructions, if any. The Company's sole responsibility is to its Client and this document does not exonerate parties to a transaction from exercising all their rights and obligations under the transaction documents. This document cannot be reproduced except in full, without prior written approval of the Company. Any unauthorized alteration, forgery or falsification of the content or appearance of this document is unlawful and offenders may be prosecuted to the fullest extent of the law.

8. 99% OCCUPIED BANDWIDTH MEASUREMENT

8.1. Standard Applicable:

According to §FCC 2.1049.

8.2. Test Set-up:

Refer to section 5.2 in this report

8.3. Measurement Procedure:

The EUT's output RF connector was connected with a short cable to the spectrum analyzer, RBW (10/30KHz) was set to about 1% of emission BW, VBW= 3 times RBW(30/100KHz), -26dBc display line was placed on the screen (or 99% bandwidth), the occupied bandwidth is the delta frequency between the two points where the display line intersects the signal trace.

8.4. Measurement Equipment Used:

Refer to section 2.4 in this report

Unless otherwise stated the results shown in this test report refer only to the sample(s) tested and such sample(s) are retained for 90 days only.

除非另有說明，此報告結果僅對測試之樣品負責，同時此樣品僅保留90天。本報告未經本公司書面許可，不可部份複製。

This document is issued by the Company subject to its General Conditions of Service printed overleaf, available on request or accessible at www.sgs.com/terms_and_conditions.htm and, for electronic format documents, subject to Terms and Conditions for Electronic Documents at www.sgs.com/terms_e-document.htm. Attention is drawn to the limitation of liability, indemnification and jurisdiction issues defined therein. Any holder of this document is advised that information contained hereon reflects the Company's findings at the time of its intervention only and within the limits of Client's instructions, if any. The Company's sole responsibility is to its Client and this document does not exonerate parties to a transaction from exercising all their rights and obligations under the transaction documents. This document cannot be reproduced except in full, without prior written approval of the Company. Any unauthorized alteration, forgery or falsification of the content or appearance of this document is unlawful and offenders may be prosecuted to the fullest extent of the law.

SGS Taiwan Ltd.

台灣檢驗科技股份有限公司

No.134, Wu Kung Road, Wuku Industrial Zone, Taipei County, Taiwan / 台北縣五股工業區五工路 134 號

t (886-2) 2299-3279

f (886-2) 2298-0488

www.tw.sgs.com

Member of SGS Group

8.5. Measurement Result:

EUT Mode	Frequency (MHz)	CH	99% Bandwidth (MHz)
GSM 850	824.20	128	0.2446
	836.60	190	0.2465
	848.80	251	0.2482

EUT Mode	Frequency (MHz)	CH	99% Bandwidth (MHz)
GSM 1900	1850.20	512	0.2456
	1880.00	661	0.2470
	1909.80	810	0.2373

EUT Mode	Frequency (MHz)	CH	99% Bandwidth (MHz)
EDGE 850	824.20	128	0.2387
	836.60	190	0.2425
	848.80	251	0.2482

EUT Mode	Frequency (MHz)	CH	99% Bandwidth (MHz)
EDGE 1900	1850.20	512	0.2496
	1880.00	661	0.2504
	1909.80	810	0.2436

Unless otherwise stated the results shown in this test report refer only to the sample(s) tested and such sample(s) are retained for 90 days only.

除非另有說明，此報告結果僅對測試之樣品負責，同時此樣品僅保留90天。本報告未經本公司書面許可，不可部份複製。

This document is issued by the Company subject to its General Conditions of Service printed overleaf, available on request or accessible at www.sgs.com/terms_and_conditions.htm and for electronic format documents, subject to Terms and Conditions for Electronic Documents at www.sgs.com/terms_e-document.htm. Attention is drawn to the limitation of liability, indemnification and jurisdiction issues defined therein. Any holder of this document is advised that information contained hereon reflects the Company's findings at the time of its intervention only and within the limits of Client's instructions, if any. The Company's sole responsibility is to its Client and this document does not exonerate parties to a transaction from exercising all their rights and obligations under the transaction documents. This document cannot be reproduced except in full, without prior written approval of the Company. Any unauthorized alteration, forgery or falsification of the content or appearance of this document is unlawful and offenders may be prosecuted to the fullest extent of the law.

EUT Mode	Frequency (MHz)	CH	99% Bandwidth (MHz)
GPRS 850	824.20	128	0.2396
	836.60	190	0.2426
	848.80	251	0.2460

EUT Mode	Frequency (MHz)	CH	99% Bandwidth (MHz)
GPRS 1900	1850.20	512	0.2437
	1880.00	661	0.2449
	1909.80	810	0.2462

EUT Mode	Frequency (MHz)	CH	99% Bandwidth (MHz)
WCDMA IV	1712.40	1312	4.1253
	1732.60	1413	4.1467
	1752.60	1513	4.1357

EUT Mode	Frequency (MHz)	CH	99% Bandwidth (MHz)
HSUPA IV	1712.40	1312	4.1388
	1732.60	1413	4.1350
	1752.60	1513	4.1322

EUT Mode	Frequency (MHz)	CH	99% Bandwidth (MHz)
HSDPA IV	1712.40	1312	4.1360
	1732.60	1413	4.1424
	1752.60	1513	4.1209

Unless otherwise stated the results shown in this test report refer only to the sample(s) tested and such sample(s) are retained for 90 days only.

除非另有說明，此報告結果僅對測試之樣品負責，同時此樣品僅保留90天。本報告未經本公司書面許可，不可部份複製。

This document is issued by the Company subject to its General Conditions of Service printed overleaf, available on request or accessible at www.sgs.com/terms_and_conditions.htm and for electronic format documents, subject to Terms and Conditions for Electronic Documents at www.sgs.com/terms_e-document.htm. Attention is drawn to the limitation of liability, indemnification and jurisdiction issues defined therein. Any holder of this document is advised that information contained hereon reflects the Company's findings at the time of its intervention only and within the limits of Client's instructions, if any. The Company's sole responsibility is to its Client and this document does not exonerate parties to a transaction from exercising all their rights and obligations under the transaction documents. This document cannot be reproduced except in full, without prior written approval of the Company. Any unauthorized alteration, forgery or falsification of the content or appearance of this document is unlawful and offenders may be prosecuted to the fullest extent of the law.

SGS Taiwan Ltd. No.134, Wu Kung Road, Wuku Industrial Zone, Taipei County, Taiwan / 台北縣五股工業區五工路 134 號

台灣檢驗科技股份有限公司 t (886-2) 2299-3279

f (886-2) 2298-0488

www.tw.sgs.com

Member of SGS Group

Figure 8-1: GSM 850 Channel Low

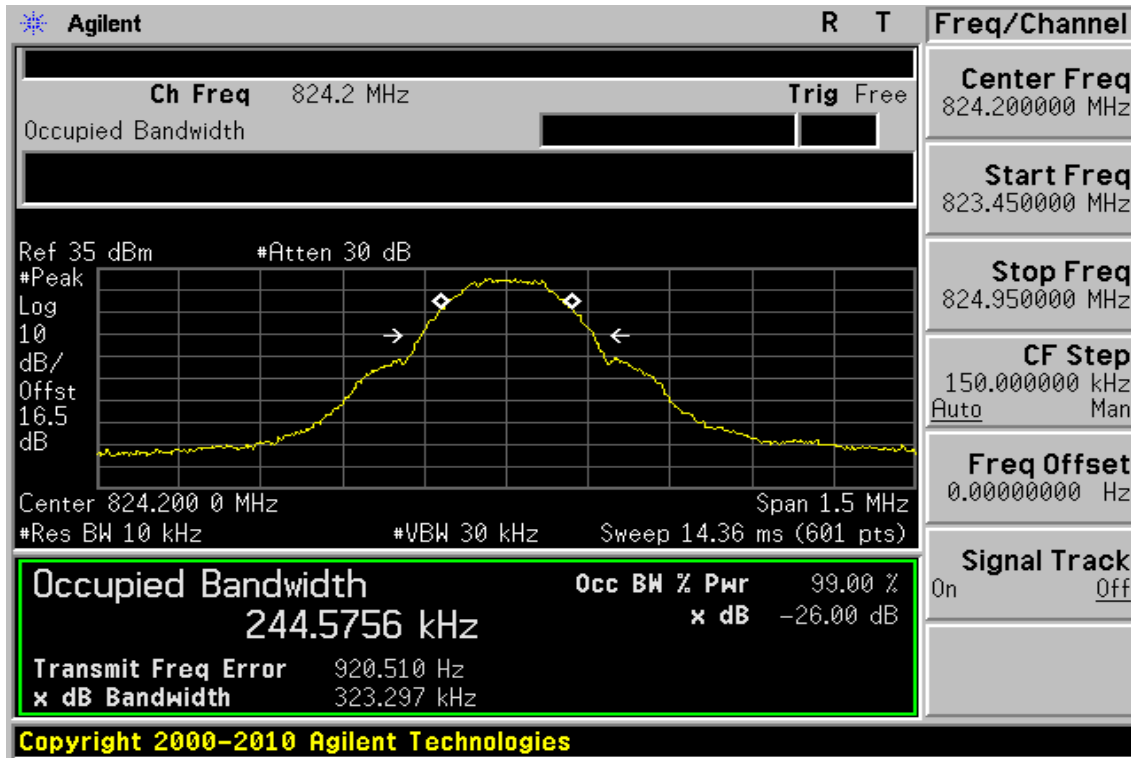
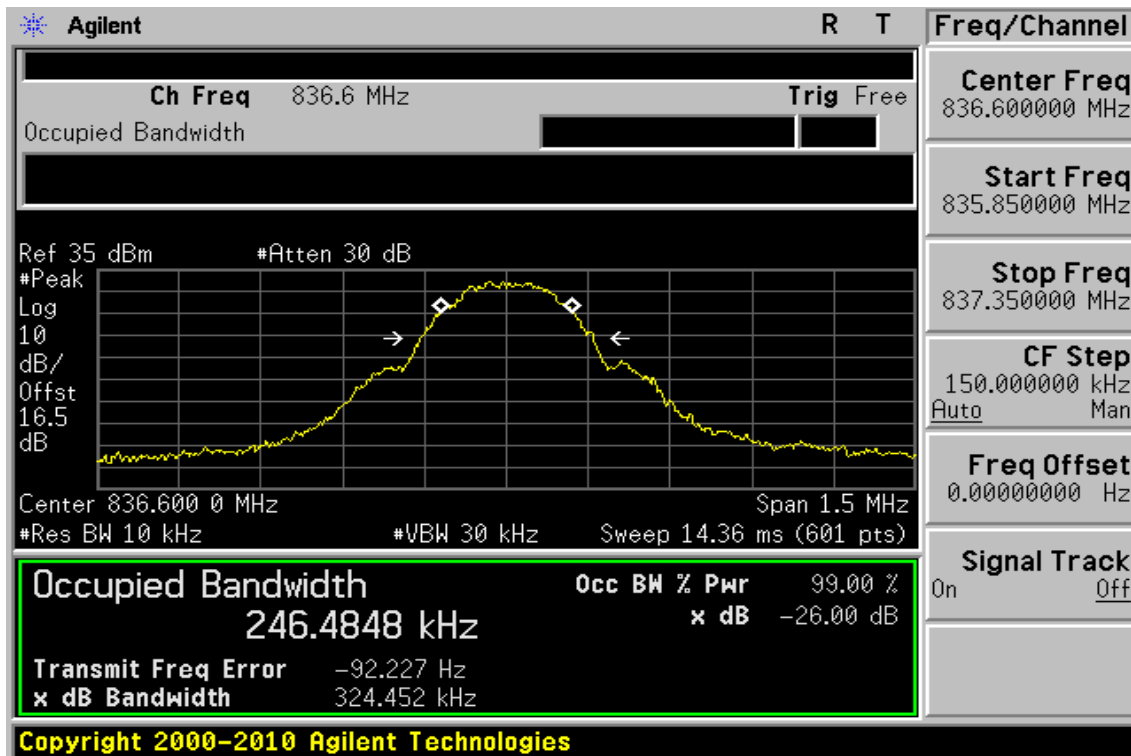

Figure 8-2: GSM 850 Channel Mid



Unless otherwise stated the results shown in this test report refer only to the sample(s) tested and such sample(s) are retained for 90 days only.

除非另有說明，此報告結果僅對測試之樣品負責，同時此樣品僅保留90天。本報告未經本公司書面許可，不可部份複製。

This document is issued by the Company subject to its General Conditions of Service printed overleaf, available on request or accessible at www.sgs.com/terms_and_conditions.htm and for electronic format documents, subject to Terms and Conditions for Electronic Documents at www.sgs.com/terms_e-document.htm. Attention is drawn to the limitation of liability, indemnification and jurisdiction issues defined therein. Any holder of this document is advised that information contained hereon reflects the Company's findings at the time of its intervention only and within the limits of Client's instructions, if any. The Company's sole responsibility is to its Client and this document does not exonerate parties to a transaction from exercising all their rights and obligations under the transaction documents. This document cannot be reproduced except in full, without prior written approval of the Company. Any unauthorized alteration, forgery or falsification of the content or appearance of this document is unlawful and offenders may be prosecuted to the fullest extent of the law.

SGS Taiwan Ltd. No.134, Wu Kung Road, Wuku Industrial Zone, Taipei County, Taiwan / 台北縣五股工業區五工路 134 號

台灣檢驗科技股份有限公司

t (886-2) 2299-3279

f (886-2) 2298-0488

www.tw.sgs.com

Member of SGS Group

Figure 8-3: GSM 850 Channel High

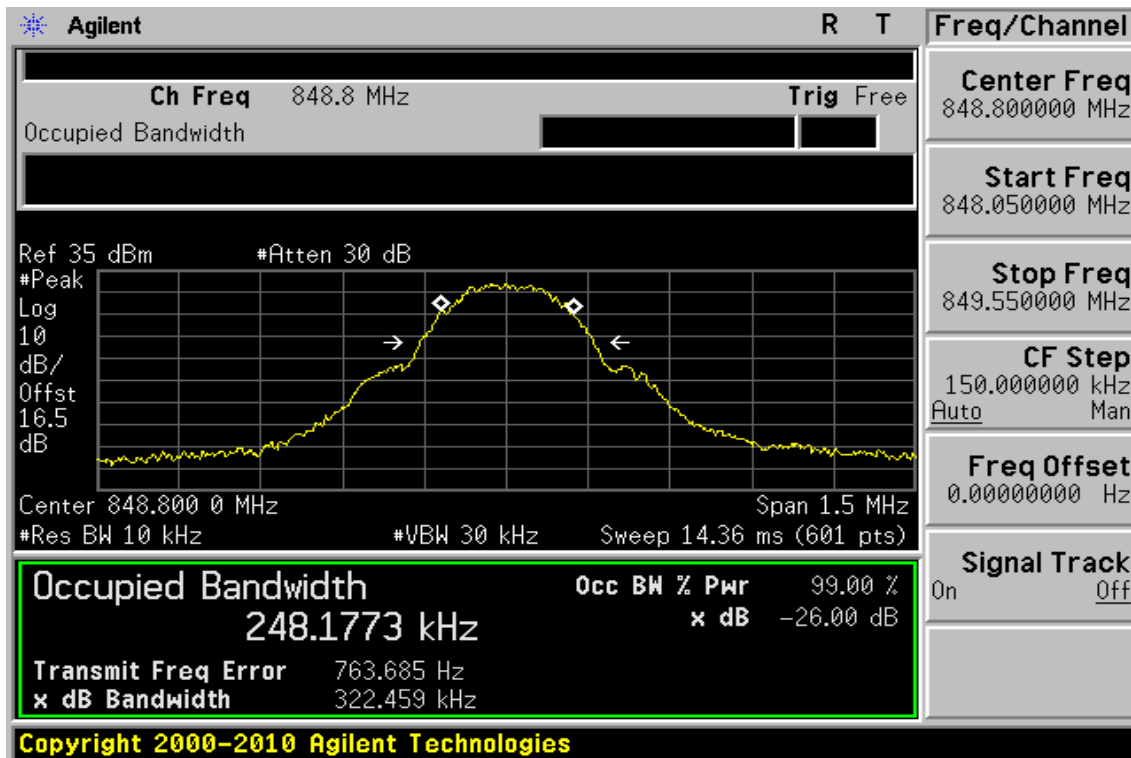
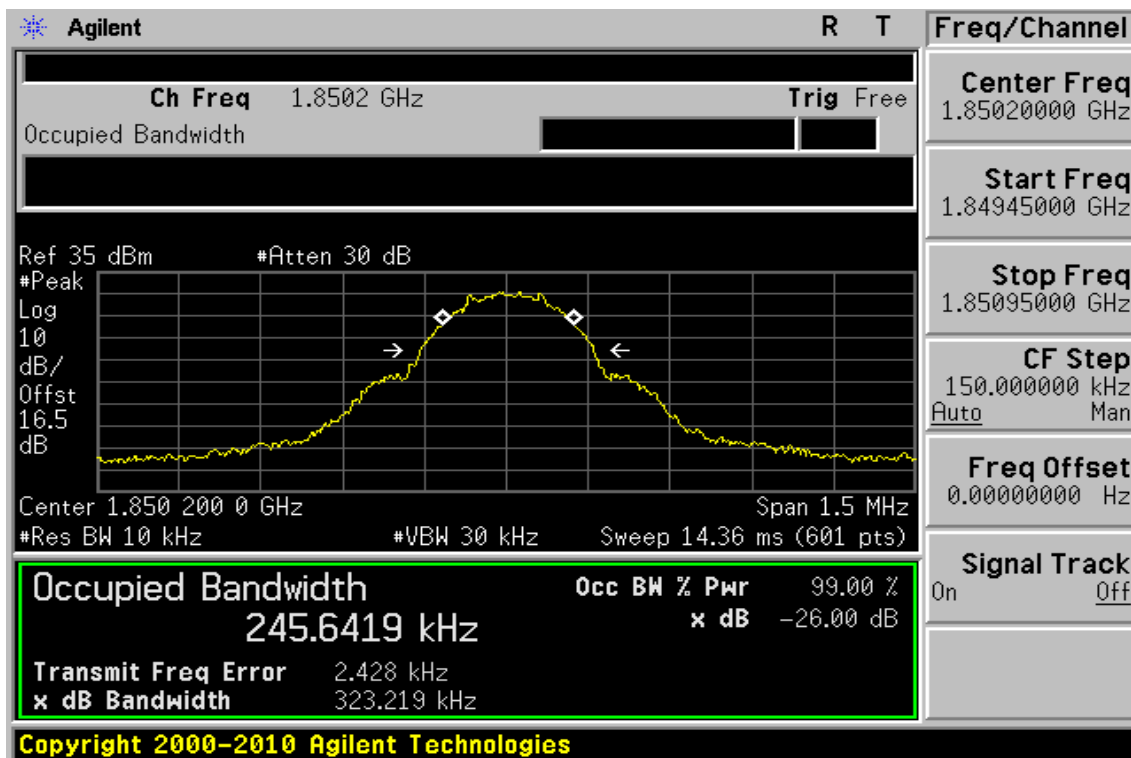

Figure 8-4: GSM 1900 Channel Low



Unless otherwise stated the results shown in this test report refer only to the sample(s) tested and such sample(s) are retained for 90 days only.

除非另有說明，此報告結果僅對測試之樣品負責，同時此樣品僅保留90天。本報告未經本公司書面許可，不可部份複製。

This document is issued by the Company subject to its General Conditions of Service printed overleaf, available on request or accessible at www.sgs.com/terms_and_conditions.htm and for electronic format documents, subject to Terms and Conditions for Electronic Documents at www.sgs.com/terms_e-document.htm. Attention is drawn to the limitation of liability, indemnification and jurisdiction issues defined therein. Any holder of this document is advised that information contained hereon reflects the Company's findings at the time of its intervention only and within the limits of Client's instructions, if any. The Company's sole responsibility is to its Client and this document does not exonerate parties to a transaction from exercising all their rights and obligations under the transaction documents. This document cannot be reproduced except in full, without prior written approval of the Company. Any unauthorized alteration, forgery or falsification of the content or appearance of this document is unlawful and offenders may be prosecuted to the fullest extent of the law.

SGS Taiwan Ltd. No.134, Wu Kung Road, Wuku Industrial Zone, Taipei County, Taiwan / 台北縣五股工業區五工路 134 號

台灣檢驗科技股份有限公司

t (886-2) 2299-3279

f (886-2) 2298-0488

www.tw.sgs.com

Member of SGS Group

Figure 8-5: GSM 1900 Channel Mid

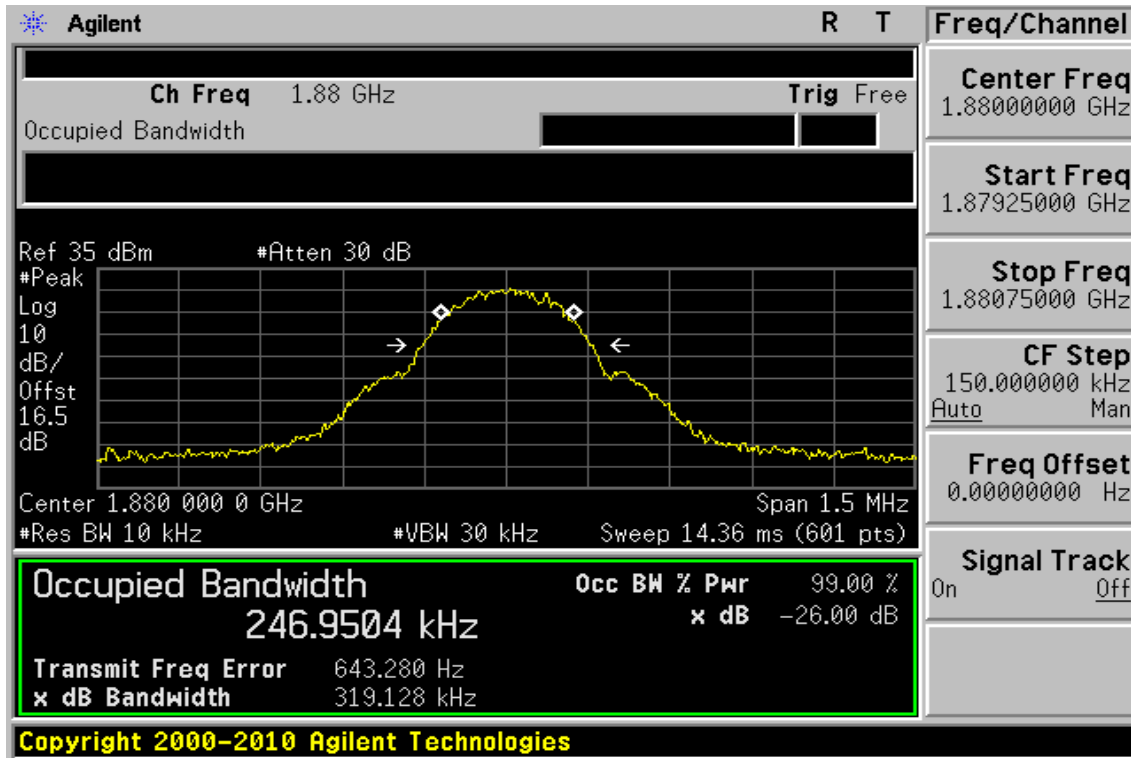
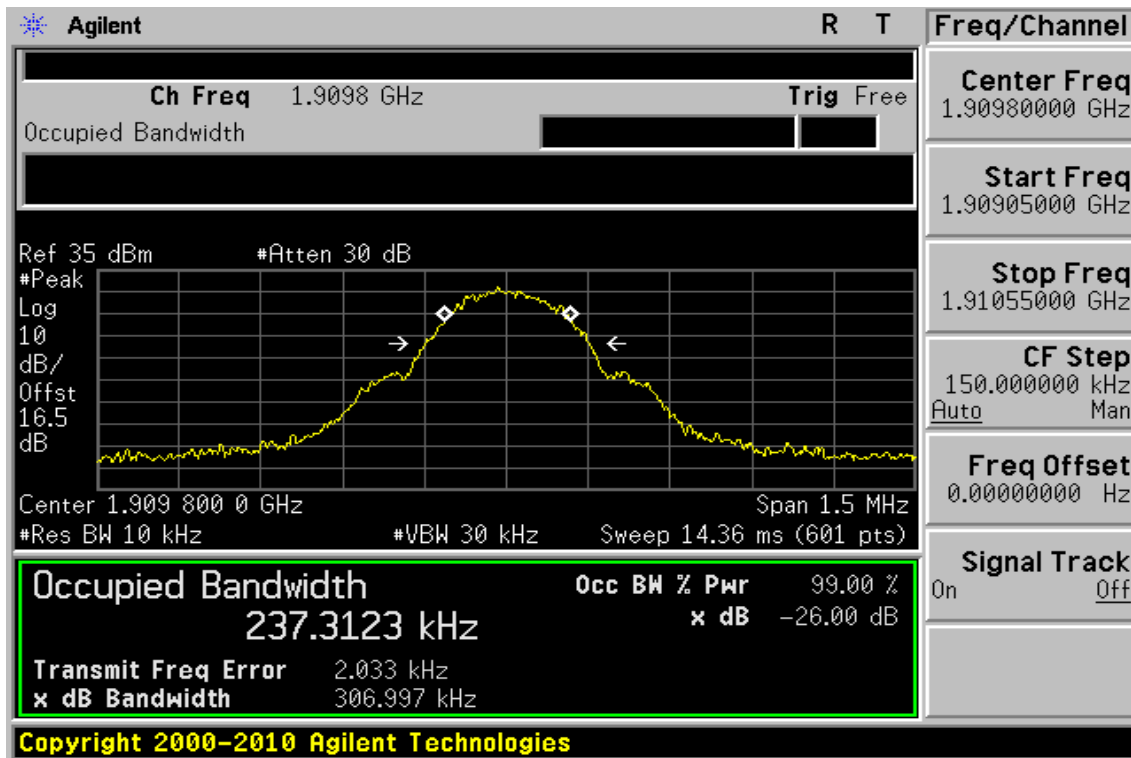

Figure 8-6: GSM 1900 Channel High



Unless otherwise stated the results shown in this test report refer only to the sample(s) tested and such sample(s) are retained for 90 days only.

除非另有說明，此報告結果僅對測試之樣品負責，同時此樣品僅保留90天。本報告未經本公司書面許可，不可部份複製。

This document is issued by the Company subject to its General Conditions of Service printed overleaf, available on request or accessible at www.sgs.com/terms_and_conditions.htm and for electronic format documents, subject to Terms and Conditions for Electronic Documents at www.sgs.com/terms_e-document.htm. Attention is drawn to the limitation of liability, indemnification and jurisdiction issues defined therein. Any holder of this document is advised that information contained hereon reflects the Company's findings at the time of its intervention only and within the limits of Client's instructions, if any. The Company's sole responsibility is to its Client and this document does not exonerate parties to a transaction from exercising all their rights and obligations under the transaction documents. This document cannot be reproduced except in full, without prior written approval of the Company. Any unauthorized alteration, forgery or falsification of the content or appearance of this document is unlawful and offenders may be prosecuted to the fullest extent of the law.

SGS Taiwan Ltd. No.134, Wu Kung Road, Wuku Industrial Zone, Taipei County, Taiwan / 台北縣五股工業區五工路 134 號

台灣檢驗科技股份有限公司

t (886-2) 2299-3279

f (886-2) 2298-0488

www.tw.sgs.com

Member of SGS Group

Figure 8-7: EDGE 850 Channel Low

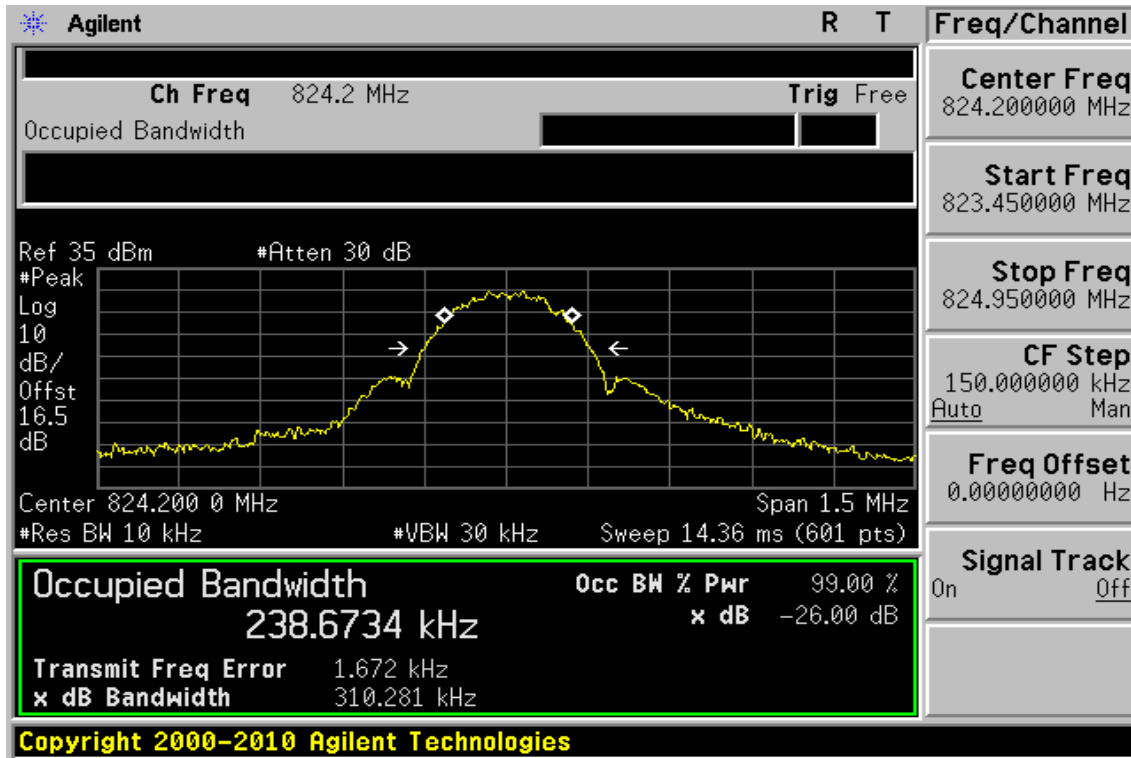
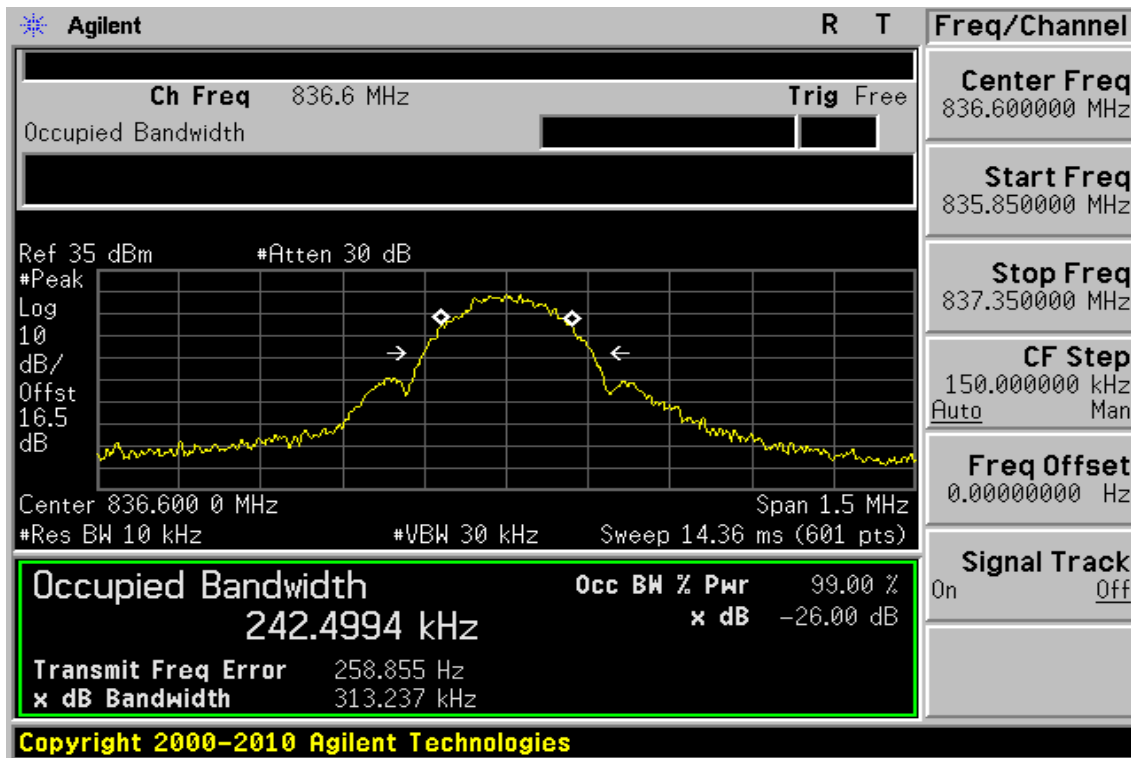

Figure 8-8: EDGE 850 Channel Mid



Unless otherwise stated the results shown in this test report refer only to the sample(s) tested and such sample(s) are retained for 90 days only.

除非另有說明，此報告結果僅對測試之樣品負責，同時此樣品僅保留90天。本報告未經本公司書面許可，不可部份複製。

This document is issued by the Company subject to its General Conditions of Service printed overleaf, available on request or accessible at www.sgs.com/terms_and_conditions.htm and for electronic format documents, subject to Terms and Conditions for Electronic Documents at www.sgs.com/terms_e-document.htm. Attention is drawn to the limitation of liability, indemnification and jurisdiction issues defined therein. Any holder of this document is advised that information contained hereon reflects the Company's findings at the time of its intervention only and within the limits of Client's instructions, if any. The Company's sole responsibility is to its Client and this document does not exonerate parties to a transaction from exercising all their rights and obligations under the transaction documents. This document cannot be reproduced except in full, without prior written approval of the Company. Any unauthorized alteration, forgery or falsification of the content or appearance of this document is unlawful and offenders may be prosecuted to the fullest extent of the law.

SGS Taiwan Ltd. No.134, Wu Kung Road, Wuku Industrial Zone, Taipei County, Taiwan / 台北縣五股工業區五工路 134 號

台灣檢驗科技股份有限公司 t (886-2) 2299-3279

f (886-2) 2298-0488

www.tw.sgs.com

Member of SGS Group

Figure 8-9: EDGE 850 Channel High

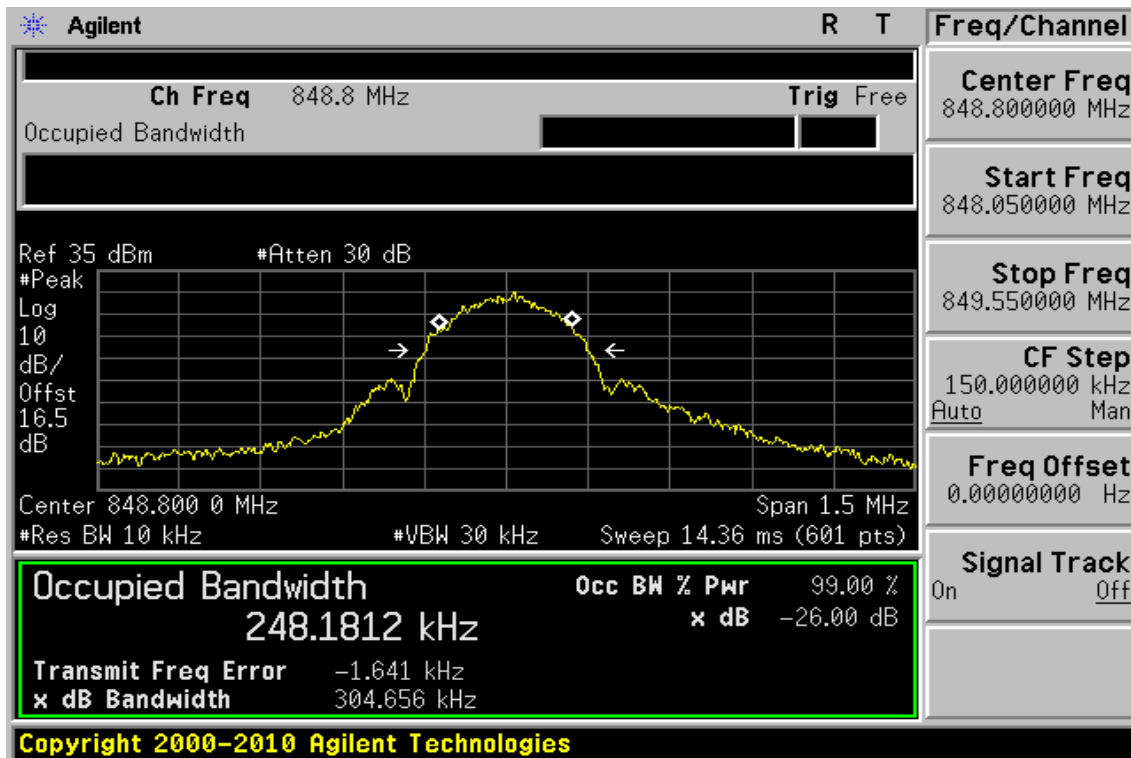
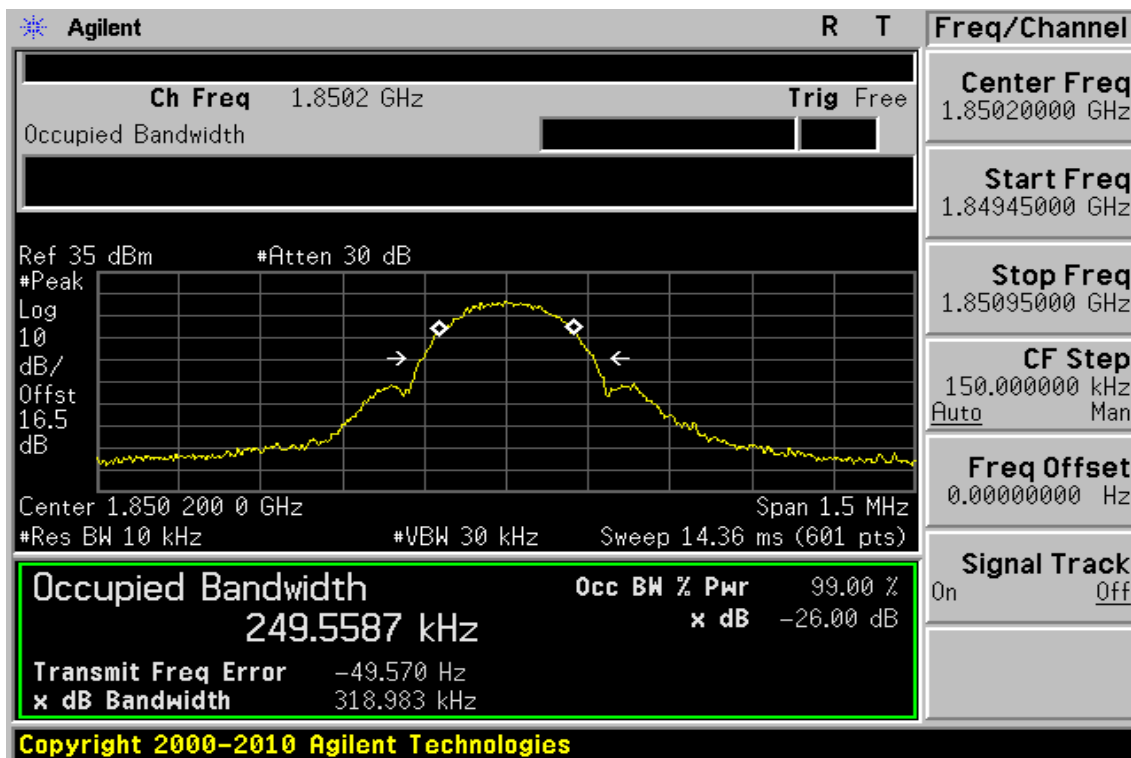

Figure 8-10: EDGE 1900 Channel Low



Unless otherwise stated the results shown in this test report refer only to the sample(s) tested and such sample(s) are retained for 90 days only.

除非另有說明，此報告結果僅對測試之樣品負責，同時此樣品僅保留90天。本報告未經本公司書面許可，不可部份複製。

This document is issued by the Company subject to its General Conditions of Service printed overleaf, available on request or accessible at www.sgs.com/terms_and_conditions.htm and for electronic format documents, subject to Terms and Conditions for Electronic Documents at www.sgs.com/terms_e-document.htm. Attention is drawn to the limitation of liability, indemnification and jurisdiction issues defined therein. Any holder of this document is advised that information contained hereon reflects the Company's findings at the time of its intervention only and within the limits of Client's instructions, if any. The Company's sole responsibility is to its Client and this document does not exonerate parties to a transaction from exercising all their rights and obligations under the transaction documents. This document cannot be reproduced except in full, without prior written approval of the Company. Any unauthorized alteration, forgery or falsification of the content or appearance of this document is unlawful and offenders may be prosecuted to the fullest extent of the law.

SGS Taiwan Ltd. No.134, Wu Kung Road, Wuku Industrial Zone, Taipei County, Taiwan / 台北縣五股工業區五工路 134 號

台灣檢驗科技股份有限公司 t (886-2) 2299-3279

f (886-2) 2298-0488

www.tw.sgs.com

Member of SGS Group

Figure 8-11: EDGE 1900 Channel Mid

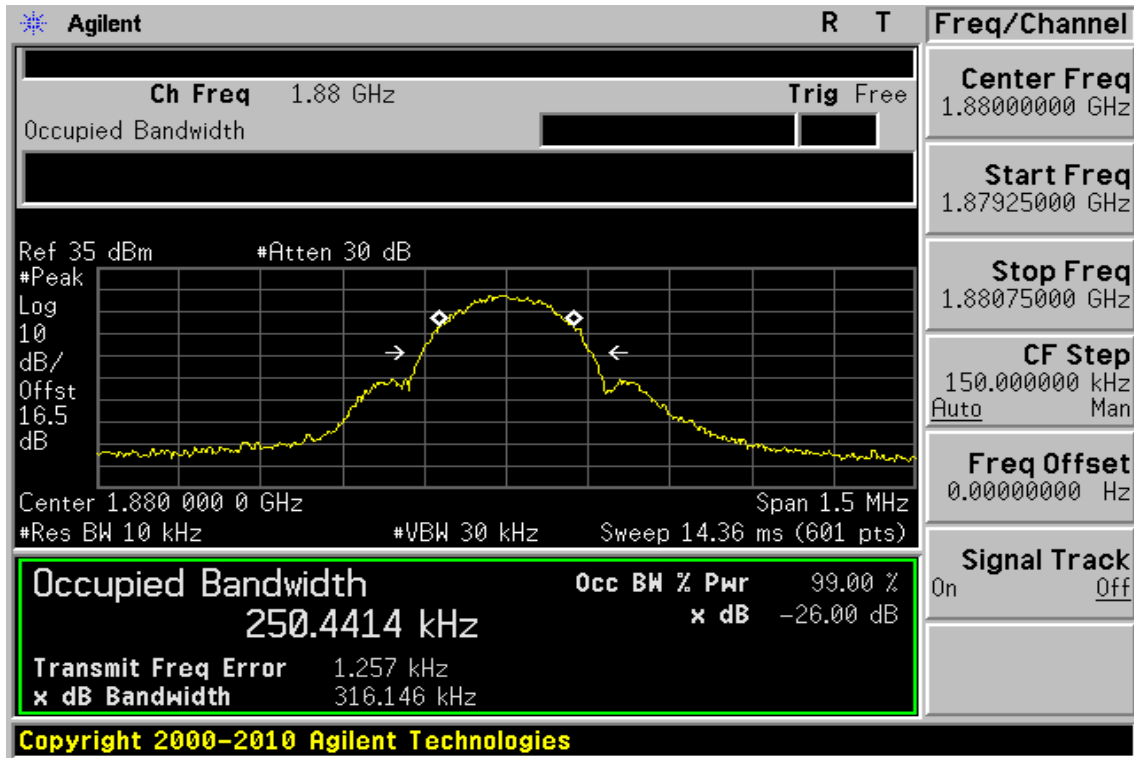
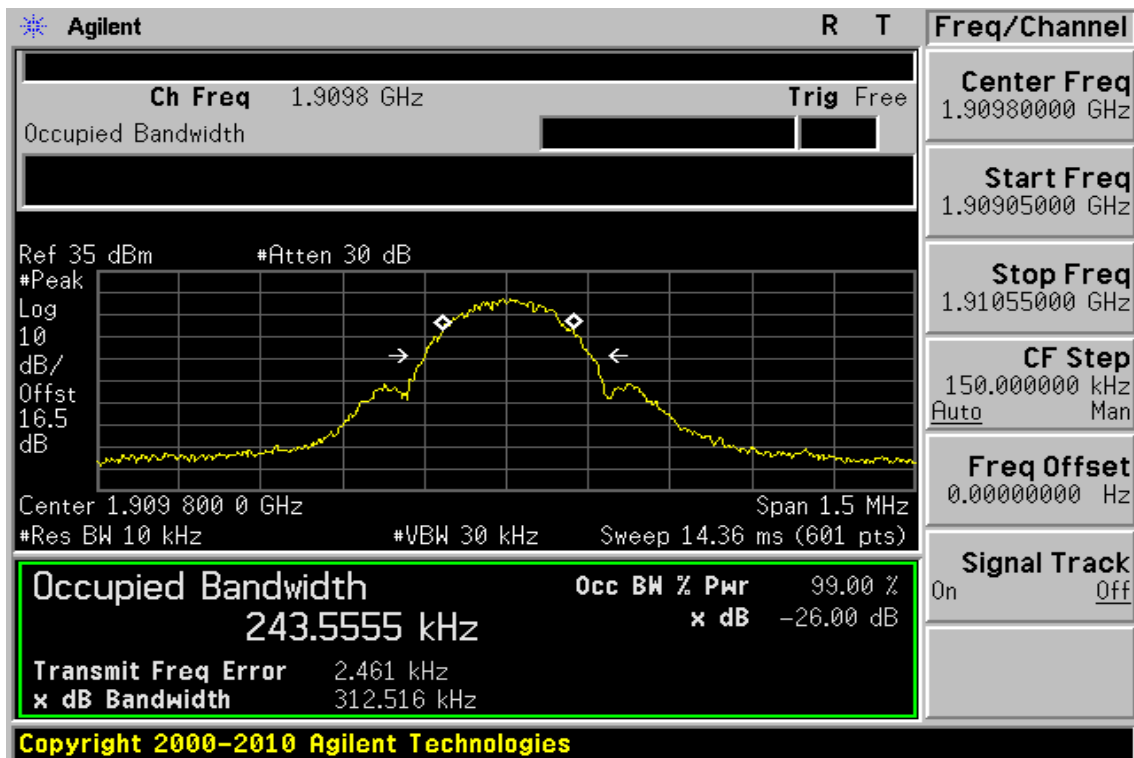

Figure 8-12: EDGE 1900 Channel High



Unless otherwise stated the results shown in this test report refer only to the sample(s) tested and such sample(s) are retained for 90 days only.

除非另有說明，此報告結果僅對測試之樣品負責，同時此樣品僅保留90天。本報告未經本公司書面許可，不可部份複製。

This document is issued by the Company subject to its General Conditions of Service printed overleaf, available on request or accessible at www.sgs.com/terms_and_conditions.htm and for electronic format documents, subject to Terms and Conditions for Electronic Documents at www.sgs.com/terms_e-document.htm. Attention is drawn to the limitation of liability, indemnification and jurisdiction issues defined therein. Any holder of this document is advised that information contained hereon reflects the Company's findings at the time of its intervention only and within the limits of Client's instructions, if any. The Company's sole responsibility is to its Client and this document does not exonerate parties to a transaction from exercising all their rights and obligations under the transaction documents. This document cannot be reproduced except in full, without prior written approval of the Company. Any unauthorized alteration, forgery or falsification of the content or appearance of this document is unlawful and offenders may be prosecuted to the fullest extent of the law.

SGS Taiwan Ltd. No.134, Wu Kung Road, Wuku Industrial Zone, Taipei County, Taiwan / 台北縣五股工業區五工路 134 號

台灣檢驗科技股份有限公司

t (886-2) 2299-3279

f (886-2) 2298-0488

www.tw.sgs.com

Member of SGS Group

Figure 8-13: GPRS 850 Channel Low

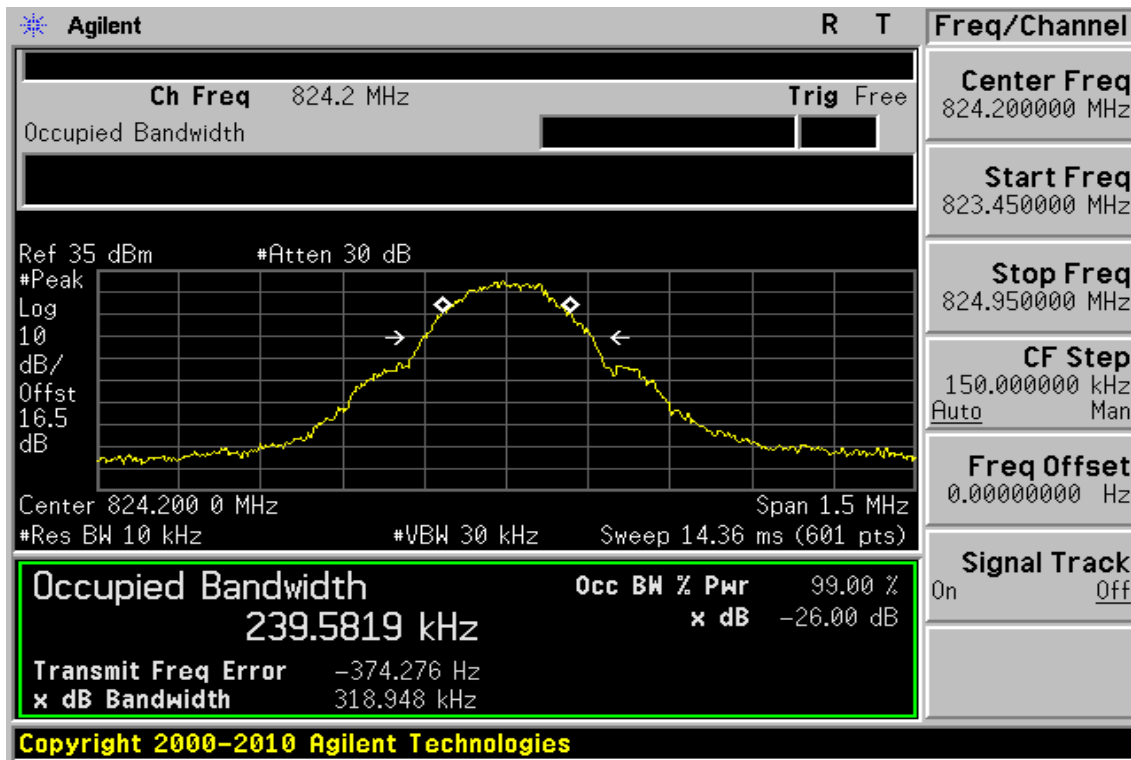
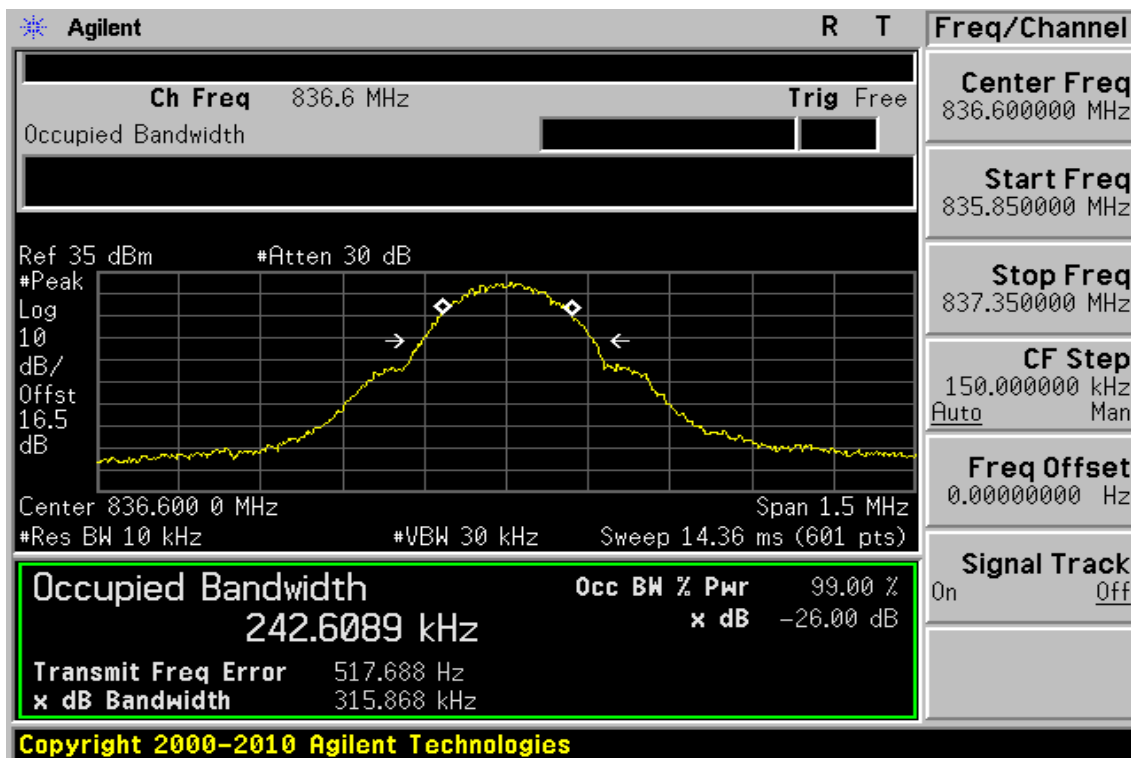

Figure 8-14: GPRS 850 Channel Mid



Unless otherwise stated the results shown in this test report refer only to the sample(s) tested and such sample(s) are retained for 90 days only.

除非另有說明，此報告結果僅對測試之樣品負責，同時此樣品僅保留90天。本報告未經本公司書面許可，不可部份複製。

This document is issued by the Company subject to its General Conditions of Service printed overleaf, available on request or accessible at www.sgs.com/terms_and_conditions.htm and for electronic format documents, subject to Terms and Conditions for Electronic Documents at www.sgs.com/terms_e-document.htm. Attention is drawn to the limitation of liability, indemnification and jurisdiction issues defined therein. Any holder of this document is advised that information contained hereon reflects the Company's findings at the time of its intervention only and within the limits of Client's instructions, if any. The Company's sole responsibility is to its Client and this document does not exonerate parties to a transaction from exercising all their rights and obligations under the transaction documents. This document cannot be reproduced except in full, without prior written approval of the Company. Any unauthorized alteration, forgery or falsification of the content or appearance of this document is unlawful and offenders may be prosecuted to the fullest extent of the law.

SGS Taiwan Ltd. No.134, Wu Kung Road, Wuku Industrial Zone, Taipei County, Taiwan / 台北縣五股工業區五工路 134 號

台灣檢驗科技股份有限公司 t (886-2) 2299-3279

f (886-2) 2298-0488

www.tw.sgs.com

Member of SGS Group

Figure 8-15: GPRS 850 Channel High

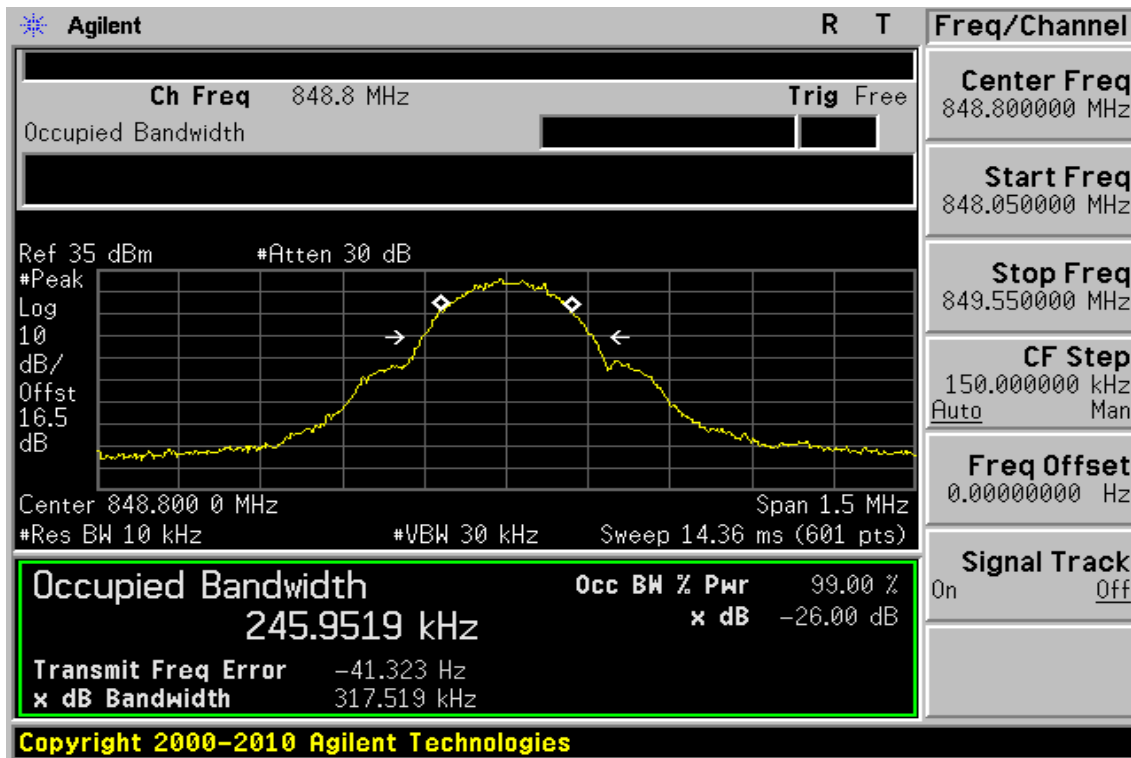
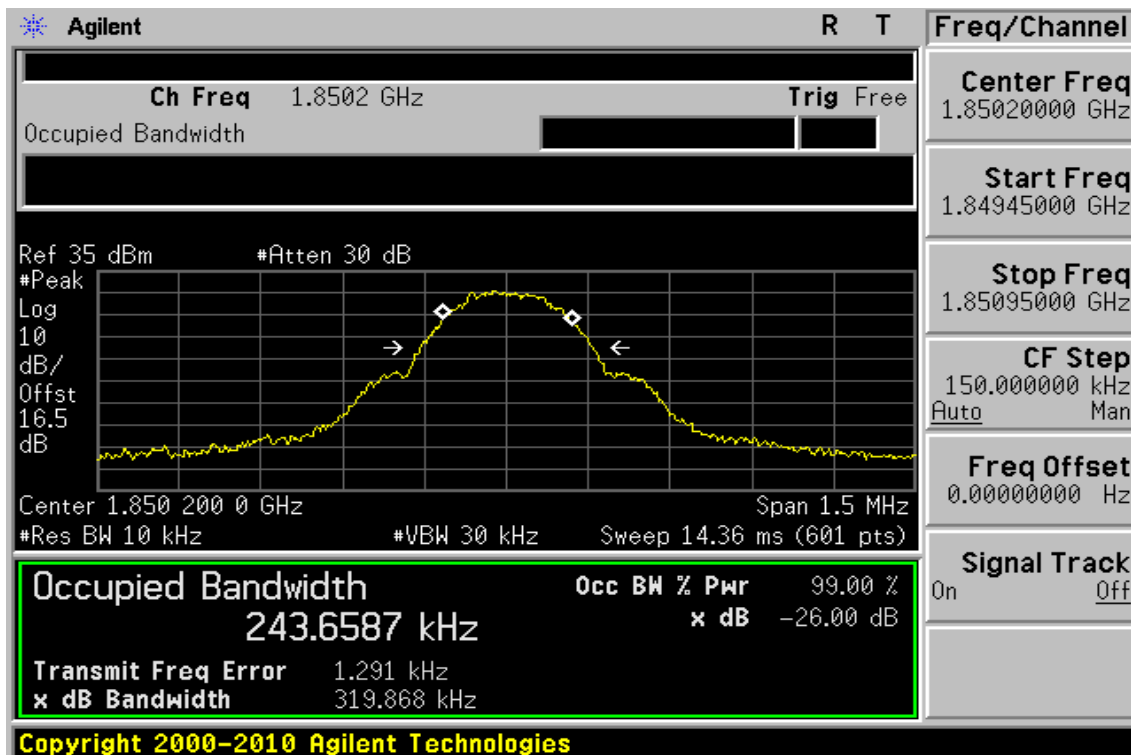

Figure 8-16: GPRS 1900 Channel Low



Unless otherwise stated the results shown in this test report refer only to the sample(s) tested and such sample(s) are retained for 90 days only.

除非另有說明，此報告結果僅對測試之樣品負責，同時此樣品僅保留90天。本報告未經本公司書面許可，不可部份複製。

This document is issued by the Company subject to its General Conditions of Service printed overleaf, available on request or accessible at www.sgs.com/terms_and_conditions.htm and for electronic format documents, subject to Terms and Conditions for Electronic Documents at www.sgs.com/terms_e-document.htm. Attention is drawn to the limitation of liability, indemnification and jurisdiction issues defined therein. Any holder of this document is advised that information contained hereon reflects the Company's findings at the time of its intervention only and within the limits of Client's instructions, if any. The Company's sole responsibility is to its Client and this document does not exonerate parties to a transaction from exercising all their rights and obligations under the transaction documents. This document cannot be reproduced except in full, without prior written approval of the Company. Any unauthorized alteration, forgery or falsification of the content or appearance of this document is unlawful and offenders may be prosecuted to the fullest extent of the law.

SGS Taiwan Ltd. No.134, Wu Kung Road, Wuku Industrial Zone, Taipei County, Taiwan / 台北縣五股工業區五工路 134 號

台灣檢驗科技股份有限公司 t (886-2) 2299-3279

f (886-2) 2298-0488

www.tw.sgs.com

Member of SGS Group

Figure 8-17: GPRS 1900 Channel Mid

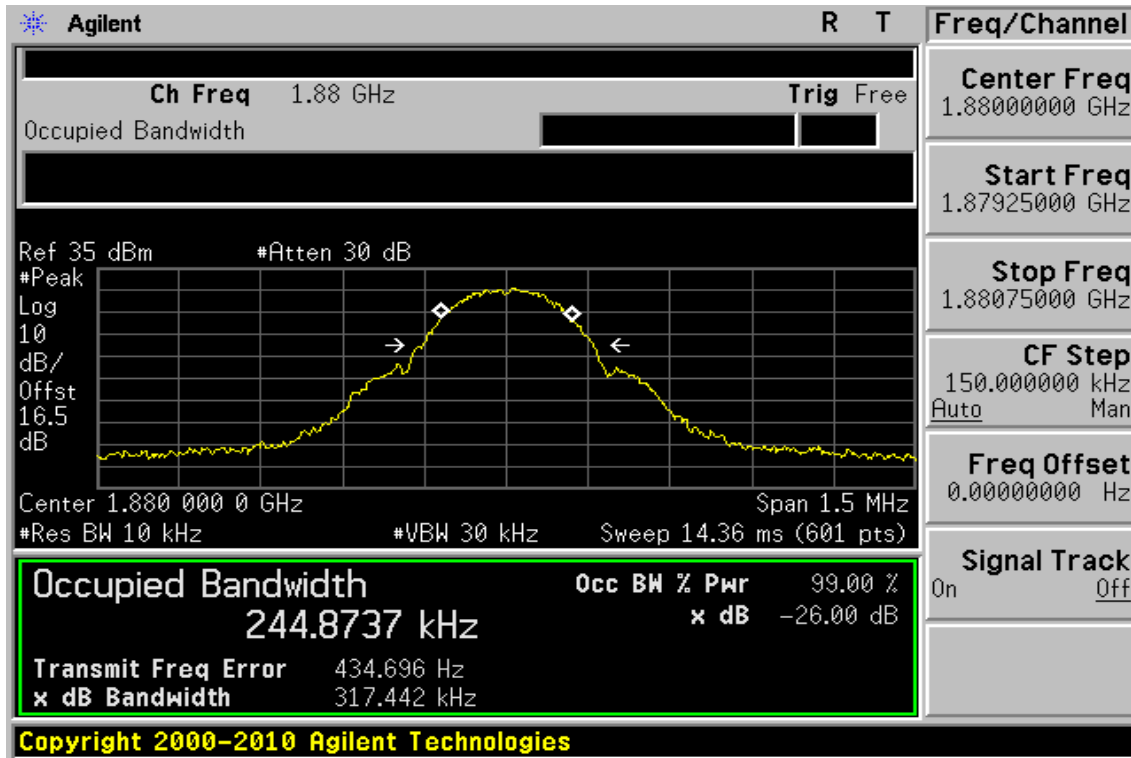
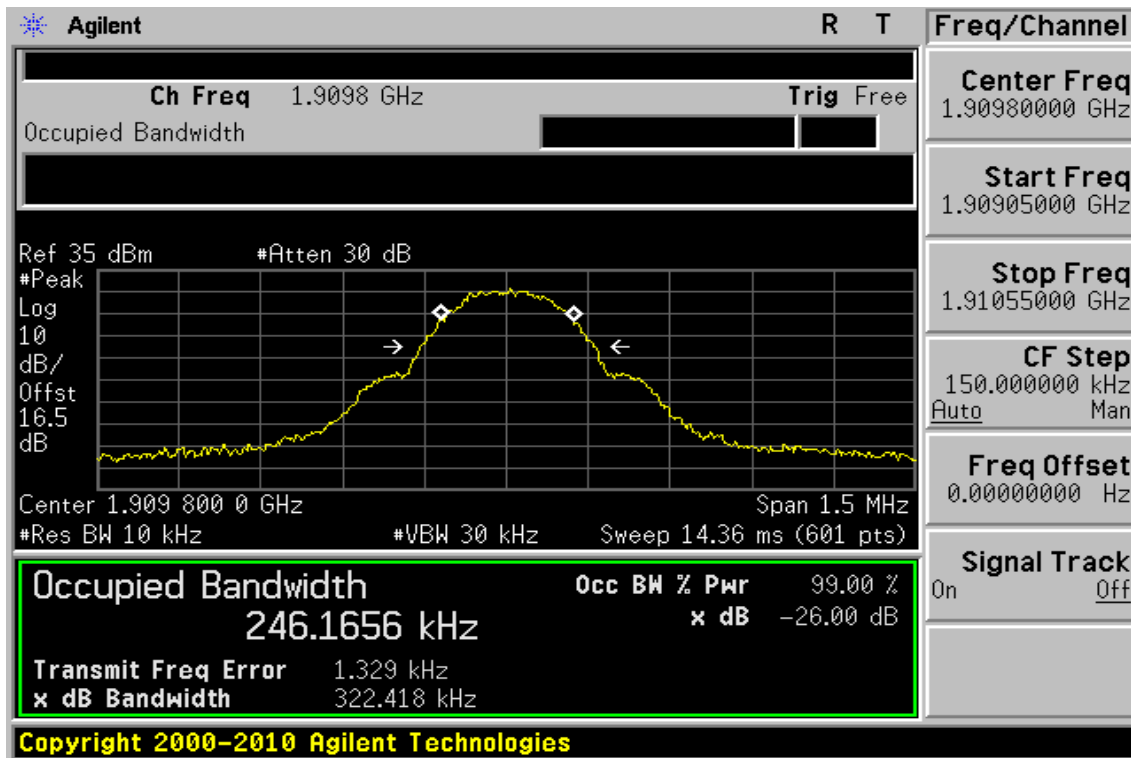

Figure 8-18: GPRS 1900 Channel High



Unless otherwise stated the results shown in this test report refer only to the sample(s) tested and such sample(s) are retained for 90 days only.

除非另有說明，此報告結果僅對測試之樣品負責，同時此樣品僅保留90天。本報告未經本公司書面許可，不可部份複製。

This document is issued by the Company subject to its General Conditions of Service printed overleaf, available on request or accessible at www.sgs.com/terms_and_conditions.htm and for electronic format documents, subject to Terms and Conditions for Electronic Documents at www.sgs.com/terms_e-document.htm. Attention is drawn to the limitation of liability, indemnification and jurisdiction issues defined therein. Any holder of this document is advised that information contained hereon reflects the Company's findings at the time of its intervention only and within the limits of Client's instructions, if any. The Company's sole responsibility is to its Client and this document does not exonerate parties to a transaction from exercising all their rights and obligations under the transaction documents. This document cannot be reproduced except in full, without prior written approval of the Company. Any unauthorized alteration, forgery or falsification of the content or appearance of this document is unlawful and offenders may be prosecuted to the fullest extent of the law.

SGS Taiwan Ltd. No.134, Wu Kung Road, Wuku Industrial Zone, Taipei County, Taiwan / 台北縣五股工業區五工路 134 號

台灣檢驗科技股份有限公司 t (886-2) 2299-3279

f (886-2) 2298-0488

www.tw.sgs.com

Member of SGS Group

Figure 8-19: WCDMA IV Channel Low

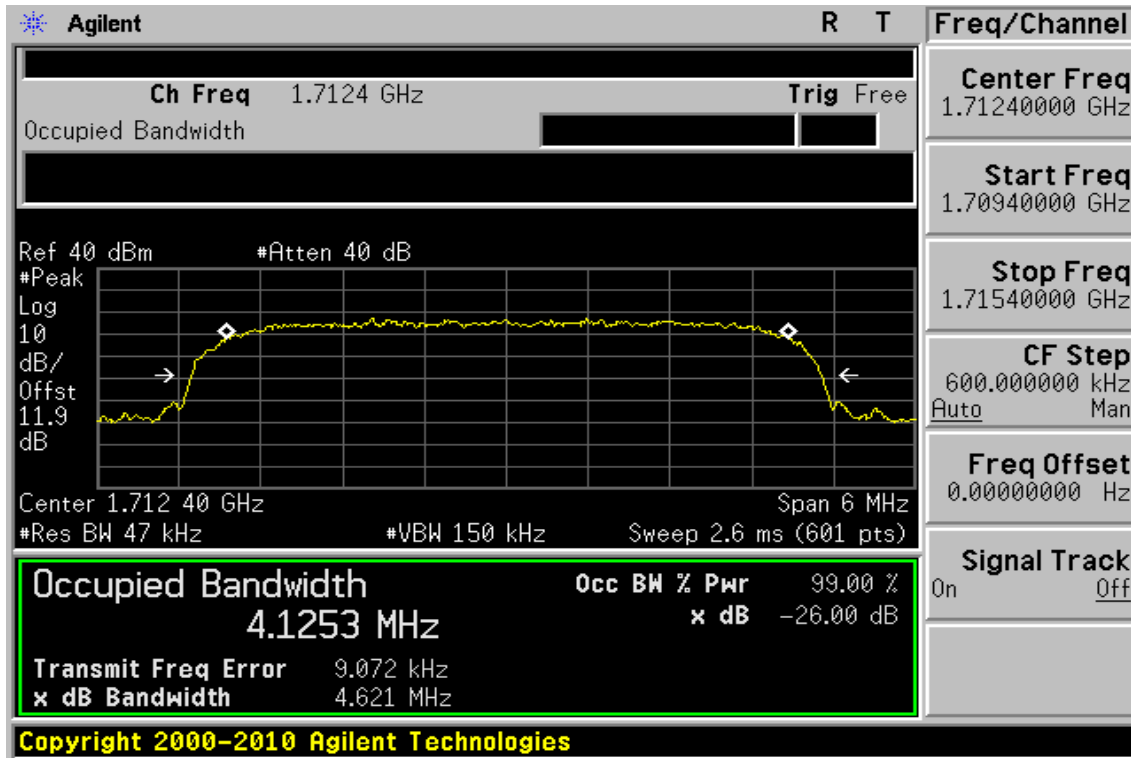
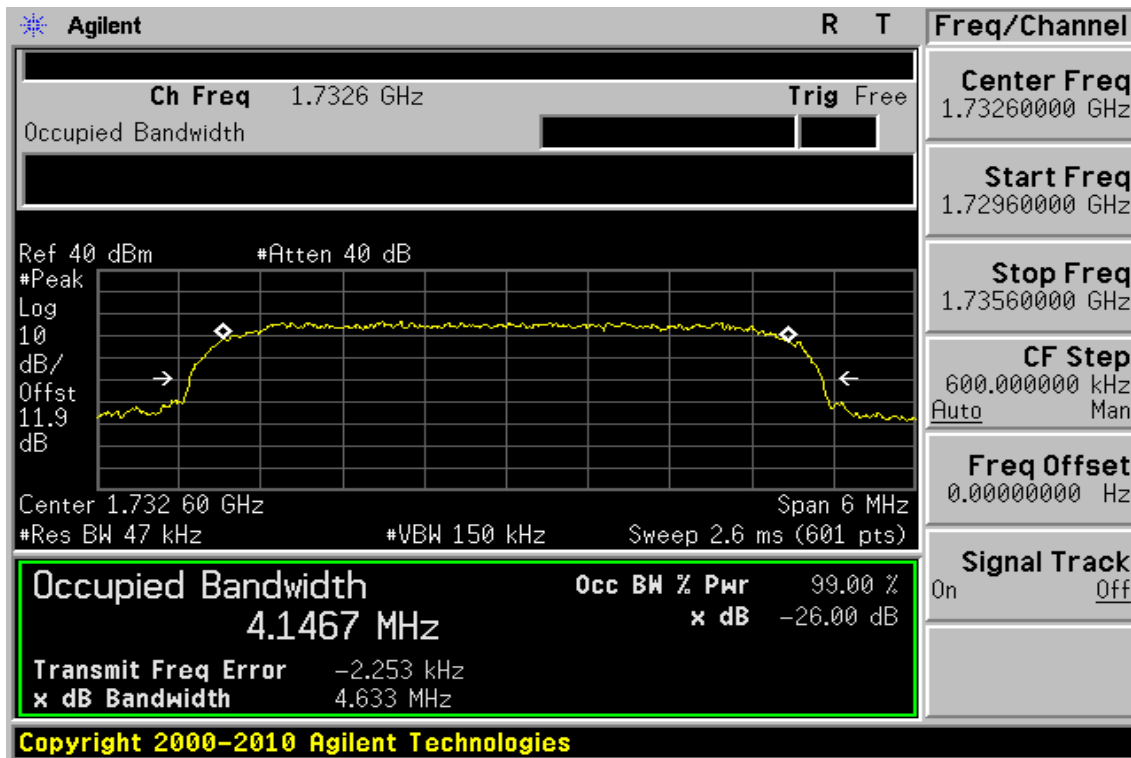

Figure 8-20: WCDMA IV Channel Mid



Unless otherwise stated the results shown in this test report refer only to the sample(s) tested and such sample(s) are retained for 90 days only.

除非另有說明，此報告結果僅對測試之樣品負責，同時此樣品僅保留90天。本報告未經本公司書面許可，不可部份複製。

This document is issued by the Company subject to its General Conditions of Service printed overleaf, available on request or accessible at www.sgs.com/terms_and_conditions.htm and for electronic format documents, subject to Terms and Conditions for Electronic Documents at www.sgs.com/terms_e-document.htm. Attention is drawn to the limitation of liability, indemnification and jurisdiction issues defined therein. Any holder of this document is advised that information contained hereon reflects the Company's findings at the time of its intervention only and within the limits of Client's instructions, if any. The Company's sole responsibility is to its Client and this document does not exonerate parties to a transaction from exercising all their rights and obligations under the transaction documents. This document cannot be reproduced except in full, without prior written approval of the Company. Any unauthorized alteration, forgery or falsification of the content or appearance of this document is unlawful and offenders may be prosecuted to the fullest extent of the law.

SGS Taiwan Ltd. No.134, Wu Kung Road, Wuku Industrial Zone, Taipei County, Taiwan / 台北縣五股工業區五工路 134 號

台灣檢驗科技股份有限公司 t (886-2) 2299-3279

f (886-2) 2298-0488

www.tw.sgs.com

Member of SGS Group

Figure 8-21: WCDMA IV Channel High

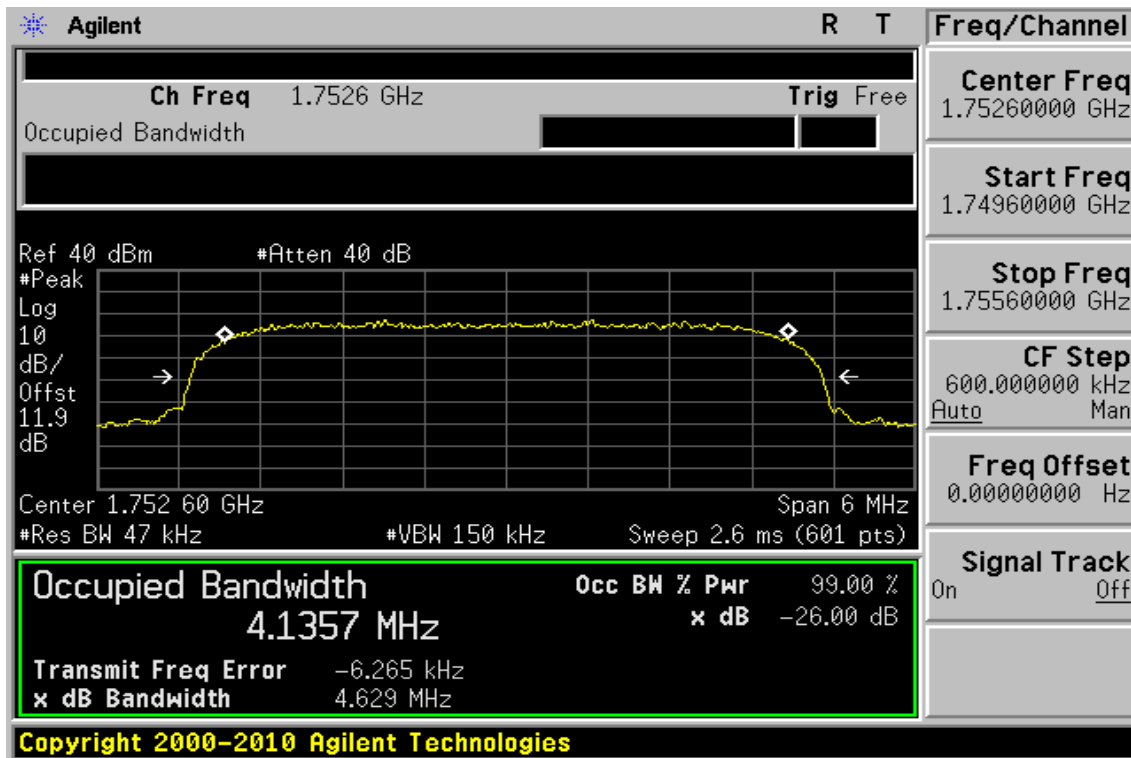
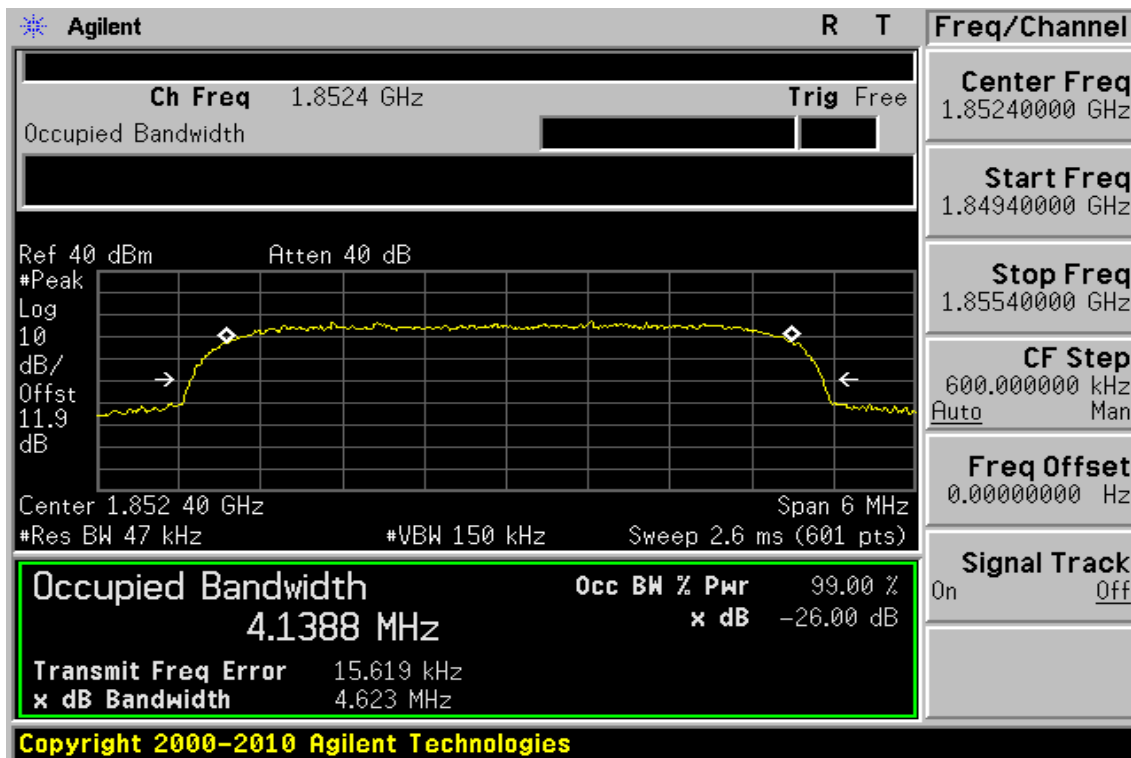

Figure 8-22: HSUPA IV Channel Low



Unless otherwise stated the results shown in this test report refer only to the sample(s) tested and such sample(s) are retained for 90 days only.

除非另有說明，此報告結果僅對測試之樣品負責，同時此樣品僅保留90天。本報告未經本公司書面許可，不可部份複製。

This document is issued by the Company subject to its General Conditions of Service printed overleaf, available on request or accessible at www.sgs.com/terms_and_conditions.htm and for electronic format documents, subject to Terms and Conditions for Electronic Documents at www.sgs.com/terms_e-document.htm. Attention is drawn to the limitation of liability, indemnification and jurisdiction issues defined therein. Any holder of this document is advised that information contained hereon reflects the Company's findings at the time of its intervention only and within the limits of Client's instructions, if any. The Company's sole responsibility is to its Client and this document does not exonerate parties to a transaction from exercising all their rights and obligations under the transaction documents. This document cannot be reproduced except in full, without prior written approval of the Company. Any unauthorized alteration, forgery or falsification of the content or appearance of this document is unlawful and offenders may be prosecuted to the fullest extent of the law.

SGS Taiwan Ltd. No.134, Wu Kung Road, Wuku Industrial Zone, Taipei County, Taiwan / 台北縣五股工業區五工路 134 號

台灣檢驗科技股份有限公司

t (886-2) 2299-3279

f (886-2) 2298-0488

www.tw.sgs.com

Member of SGS Group

Figure 8-23: HSUPA IV Channel Mid

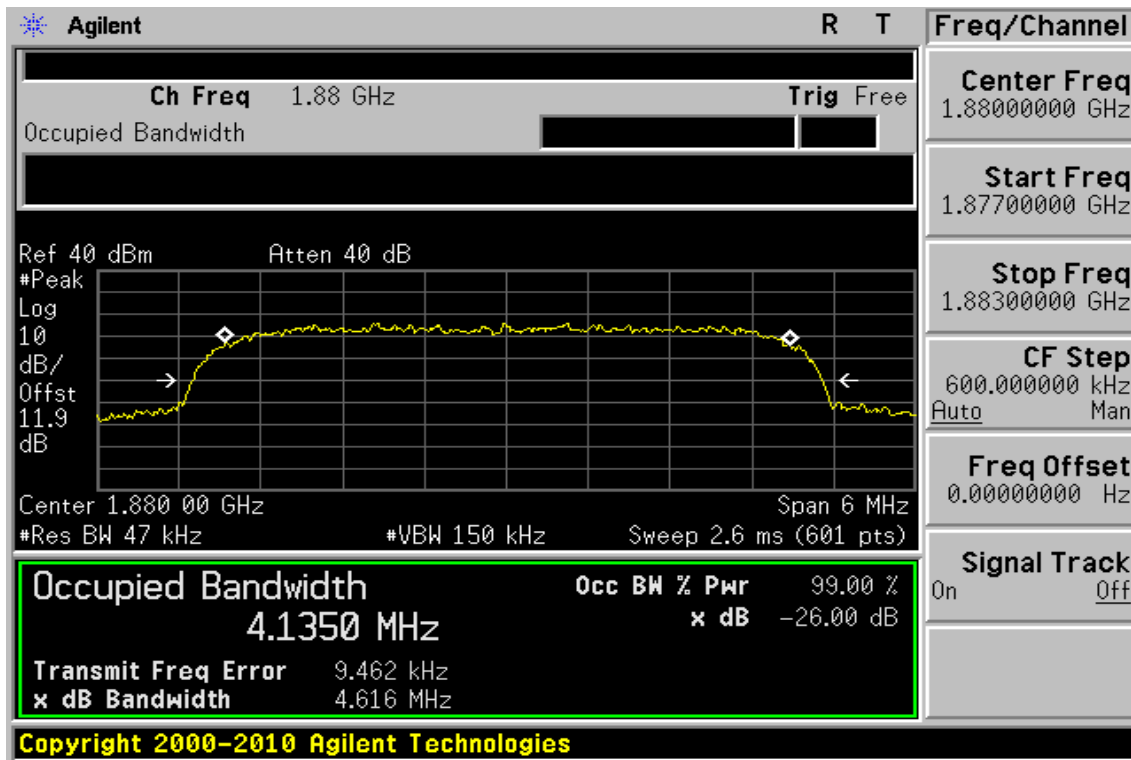
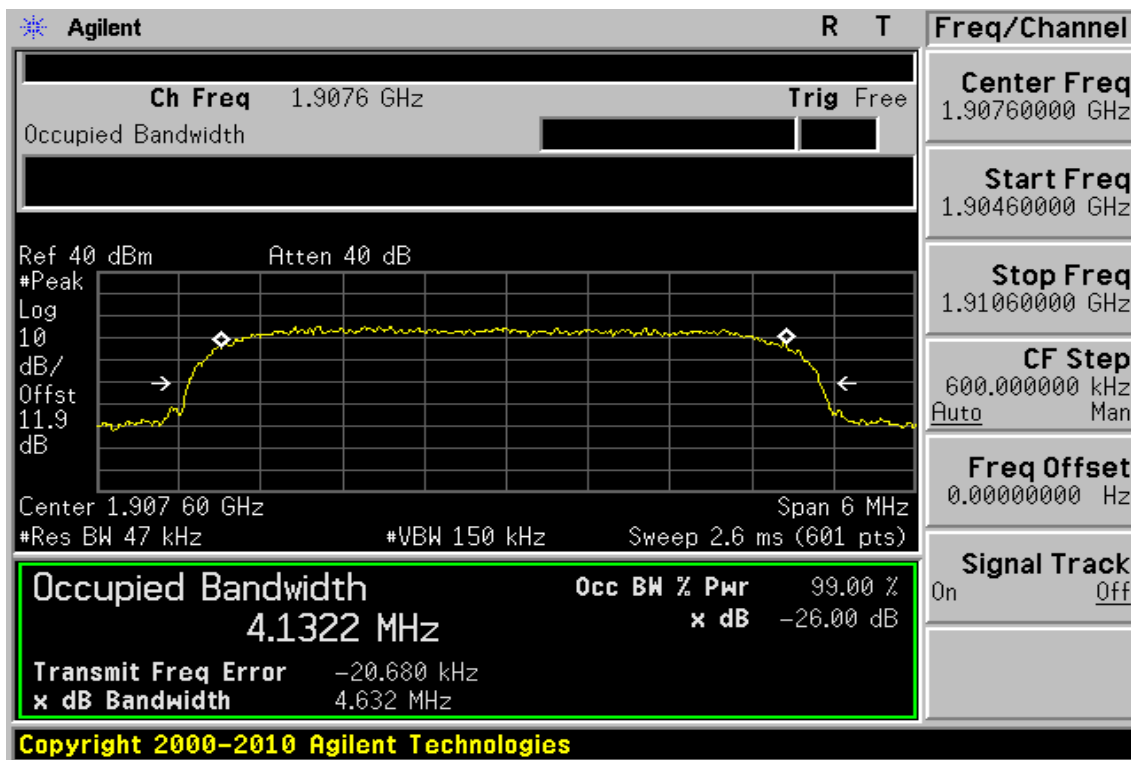

Figure 8-24: HSUPA IV Channel High



Unless otherwise stated the results shown in this test report refer only to the sample(s) tested and such sample(s) are retained for 90 days only.

除非另有說明，此報告結果僅對測試之樣品負責，同時此樣品僅保留90天。本報告未經本公司書面許可，不可部份複製。

This document is issued by the Company subject to its General Conditions of Service printed overleaf, available on request or accessible at www.sgs.com/terms_and_conditions.htm and for electronic format documents, subject to Terms and Conditions for Electronic Documents at www.sgs.com/terms_e-document.htm. Attention is drawn to the limitation of liability, indemnification and jurisdiction issues defined therein. Any holder of this document is advised that information contained hereon reflects the Company's findings at the time of its intervention only and within the limits of Client's instructions, if any. The Company's sole responsibility is to its Client and this document does not exonerate parties to a transaction from exercising all their rights and obligations under the transaction documents. This document cannot be reproduced except in full, without prior written approval of the Company. Any unauthorized alteration, forgery or falsification of the content or appearance of this document is unlawful and offenders may be prosecuted to the fullest extent of the law.

SGS Taiwan Ltd. No.134, Wu Kung Road, Wuku Industrial Zone, Taipei County, Taiwan / 台北縣五股工業區五工路 134 號

台灣檢驗科技股份有限公司 t (886-2) 2299-3279

f (886-2) 2298-0488

www.tw.sgs.com

Member of SGS Group

Figure 8-25: HSDPA IV Channel Low

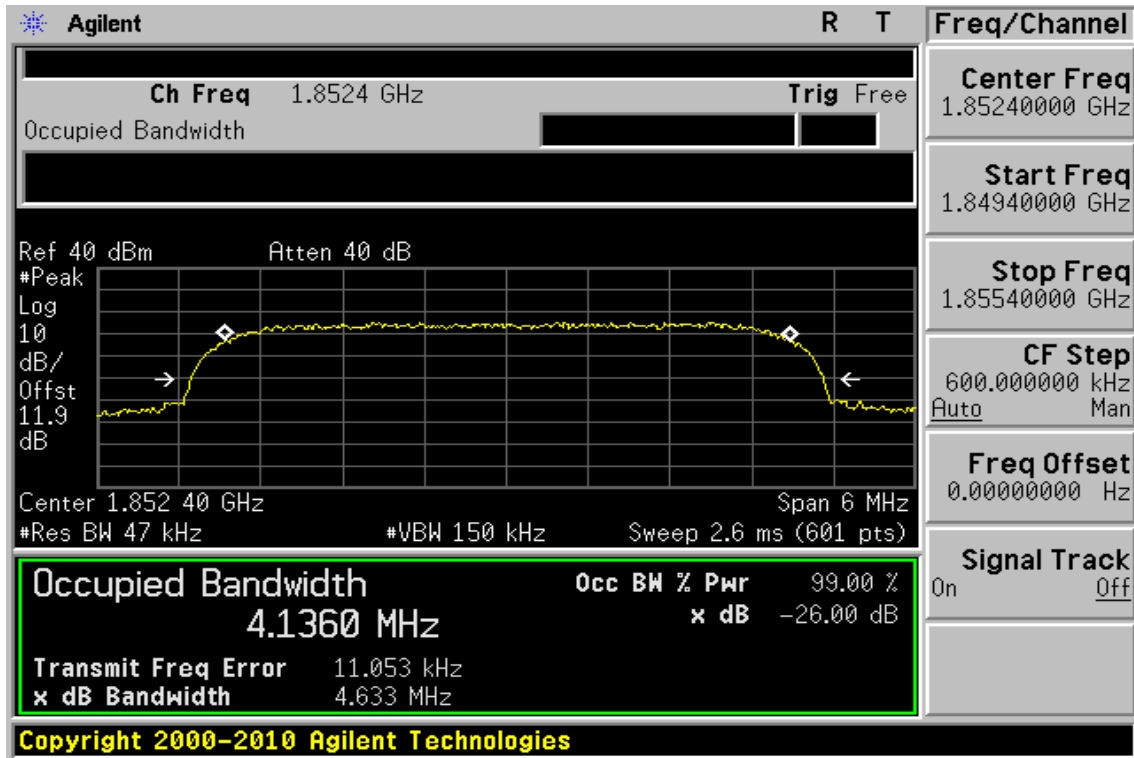
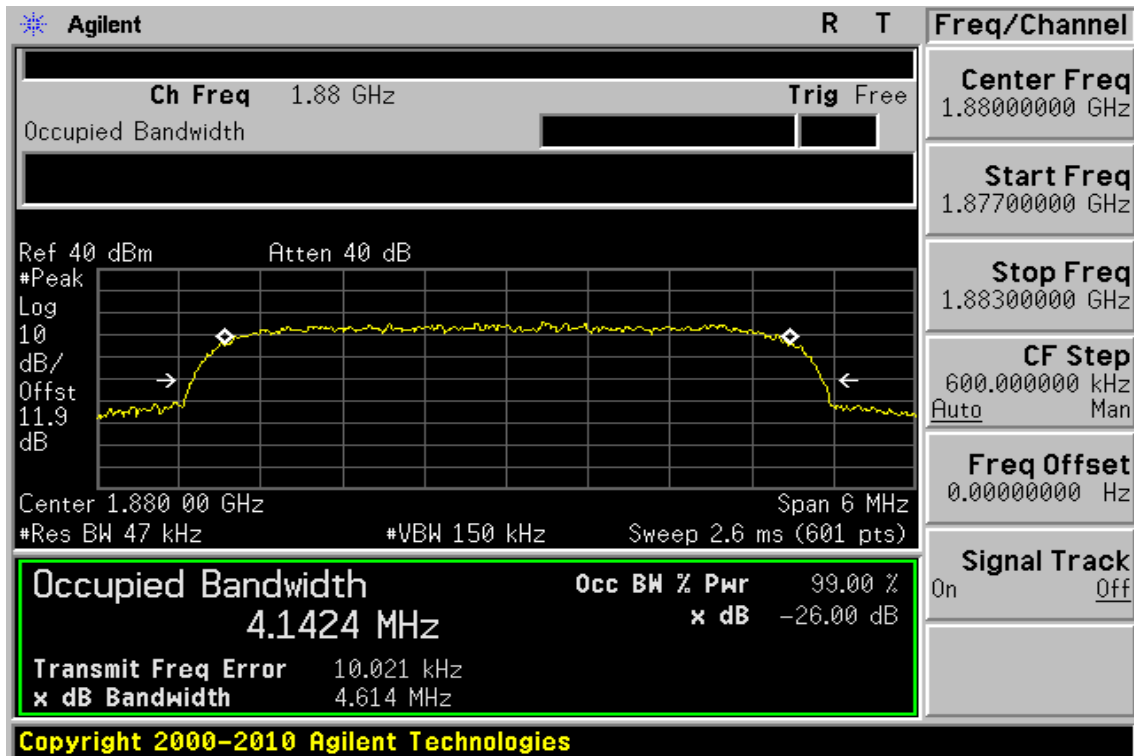

Figure 8-26: HSDPA IV Channel Mid



Unless otherwise stated the results shown in this test report refer only to the sample(s) tested and such sample(s) are retained for 90 days only.

除非另有說明，此報告結果僅對測試之樣品負責，同時此樣品僅保留90天。本報告未經本公司書面許可，不可部份複製。

This document is issued by the Company subject to its General Conditions of Service printed overleaf, available on request or accessible at www.sgs.com/terms_and_conditions.htm and for electronic format documents, subject to Terms and Conditions for Electronic Documents at www.sgs.com/terms_e-document.htm. Attention is drawn to the limitation of liability, indemnification and jurisdiction issues defined therein. Any holder of this document is advised that information contained hereon reflects the Company's findings at the time of its intervention only and within the limits of Client's instructions, if any. The Company's sole responsibility is to its Client and this document does not exonerate parties to a transaction from exercising all their rights and obligations under the transaction documents. This document cannot be reproduced except in full, without prior written approval of the Company. Any unauthorized alteration, forgery or falsification of the content or appearance of this document is unlawful and offenders may be prosecuted to the fullest extent of the law.

SGS Taiwan Ltd. No.134, Wu Kung Road, Wuku Industrial Zone, Taipei County, Taiwan / 台北縣五股工業區五工路 134 號

台灣檢驗科技股份有限公司

t (886-2) 2299-3279

f (886-2) 2298-0488

www.tw.sgs.com

Member of SGS Group

Figure 8-27: HSDPA IV Channel High

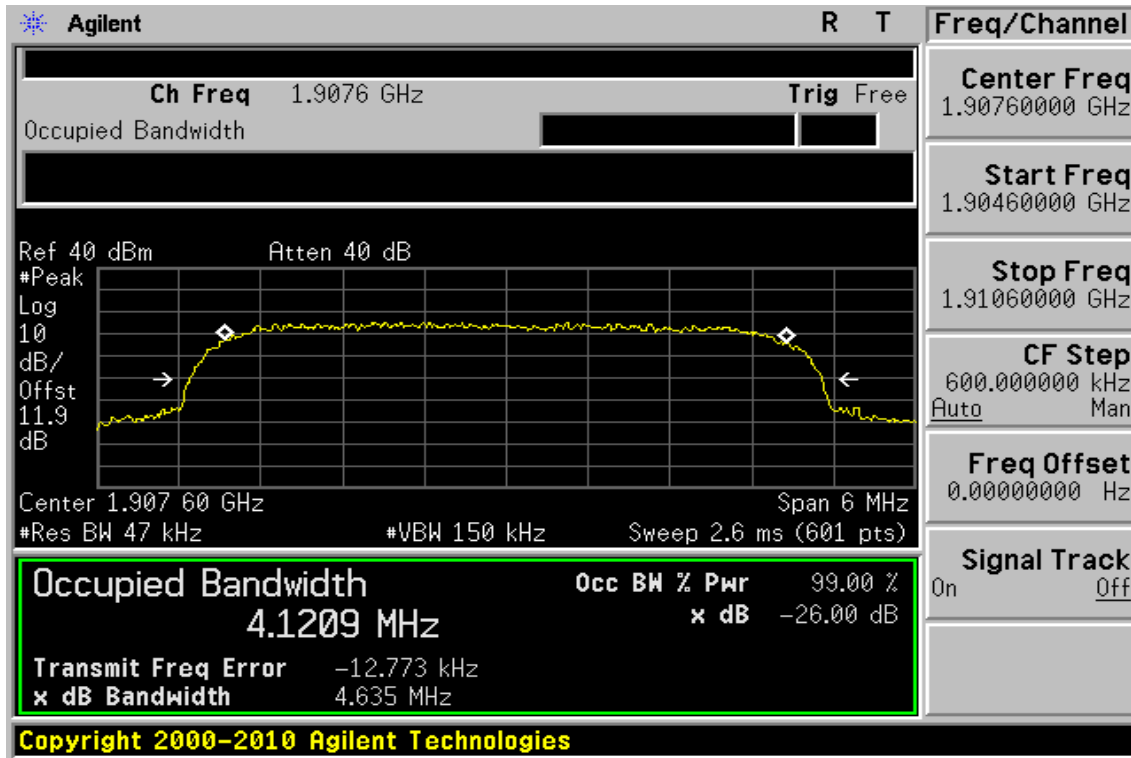

Unless otherwise stated the results shown in this test report refer only to the sample(s) tested and such sample(s) are retained for 90 days only.

除非另有說明，此報告結果僅對測試之樣品負責，同時此樣品僅保留90天。本報告未經本公司書面許可，不可部份複製。

This document is issued by the Company subject to its General Conditions of Service printed overleaf, available on request or accessible at www.sgs.com/terms_and_conditions.htm and for electronic format documents, subject to Terms and Conditions for Electronic Documents at www.sgs.com/terms_e-document.htm. Attention is drawn to the limitation of liability, indemnification and jurisdiction issues defined therein. Any holder of this document is advised that information contained hereon reflects the Company's findings at the time of its intervention only and within the limits of Client's instructions, if any. The Company's sole responsibility is to its Client and this document does not exonerate parties to a transaction from exercising all their rights and obligations under the transaction documents. This document cannot be reproduced except in full, without prior written approval of the Company. Any unauthorized alteration, forgery or falsification of the content or appearance of this document is unlawful and offenders may be prosecuted to the fullest extent of the law.

SGS Taiwan Ltd. No.134, Wu Kung Road, Wuku Industrial Zone, Taipei County, Taiwan / 台北縣五股工業區五工路 134 號

台灣檢驗科技股份有限公司

t (886-2) 2299-3279

f (886-2) 2298-0488

www.tw.sgs.com

Member of SGS Group

9. OUT OF BAND EMISSION AT ANTENNA TERMINALS

9.1. Standard Applicable:

According to FCC §2.1051.

FCC §22.917(a), §24.238(a), §27.53(g) the magnitude of each spurious and harmonic emission that can be detected when the equipment is operated under the conditions specified in the instruction manual and/ or alignment procedure, shall not be less than $43 + 10 \log$ (mean output power in watts) dBc below the mean power output outside a license's frequency block (-13dBm)

9.2. Test SET-UP:

Refer to section 5.2 in this report

9.3. Measurement Procedure:

The RF output of the transceiver was connected to a spectrum analyzer through appropriate attenuation. The resolution bandwidth of the spectrum analyzer was set at 1MHz, sufficient scans were taken to show the out of band Emissions if any up to 10th harmonic.

For the out of band: Set the RBW, VBW = 1MHz, Start=30MHz, Stop= 10 th harmonic. Limit = -13dBm

Band Edge Requirements: In the 1 MHz bands immediately outside and adjacent to the frequency block, a resolution bandwidth of at least 1 percent of the emission bandwidth of the fundamental emission of the transmitter may be employed to measure the out of band Emissions. Limit, -13dBm.

Conducted Emission:

1. To connect Antenna Port of EUT to Spectrum.
2. Set RBW = 1MHz & VBW = 1MHz on Spectrum.
3. Sweep the frequency to determine spurious emission as seen on spectrum from span of 30 to 1G, 1G to 2.5G, 2.5G to 7.5G, 7.5G to 10G ,10G to 15G and 15G to 20GHz
Via Software, combine 6 spans of frequency range into one plot

9.4. Measurement Equipment Used:

Refer to section 2.4 in this report

Unless otherwise stated the results shown in this test report refer only to the sample(s) tested and such sample(s) are retained for 90 days only.

除非另有說明，此報告結果僅對測試之樣品負責，同時此樣品僅保留90天。本報告未經本公司書面許可，不可部份複製。

This document is issued by the Company subject to its General Conditions of Service printed overleaf, available on request or accessible at www.sgs.com/terms_and_conditions.htm and, for electronic format documents, subject to Terms and Conditions for Electronic Documents at www.sgs.com/terms_e-document.htm. Attention is drawn to the limitation of liability, indemnification and jurisdiction issues defined therein. Any holder of this document is advised that information contained hereon reflects the Company's findings at the time of its intervention only and within the limits of Client's instructions, if any. The Company's sole responsibility is to its Client and this document does not exonerate parties to a transaction from exercising all their rights and obligations under the transaction documents. This document cannot be reproduced except in full, without prior written approval of the Company. Any unauthorized alteration, forgery or falsification of the content or appearance of this document is unlawful and offenders may be prosecuted to the fullest extent of the law.

SGS Taiwan Ltd. No.134, Wu Kung Road, Wuku Industrial Zone, Taipei County, Taiwan / 台北縣五股工業區五工路 134 號

台灣檢驗科技股份有限公司 t (886-2) 2299-3279

f (886-2) 2298-0488

www.tw.sgs.com

Member of SGS Group

9.5. Measurement Result:

Figure 9-1: Out of Band emission at antenna terminals – GSM 850 Channel Lowest

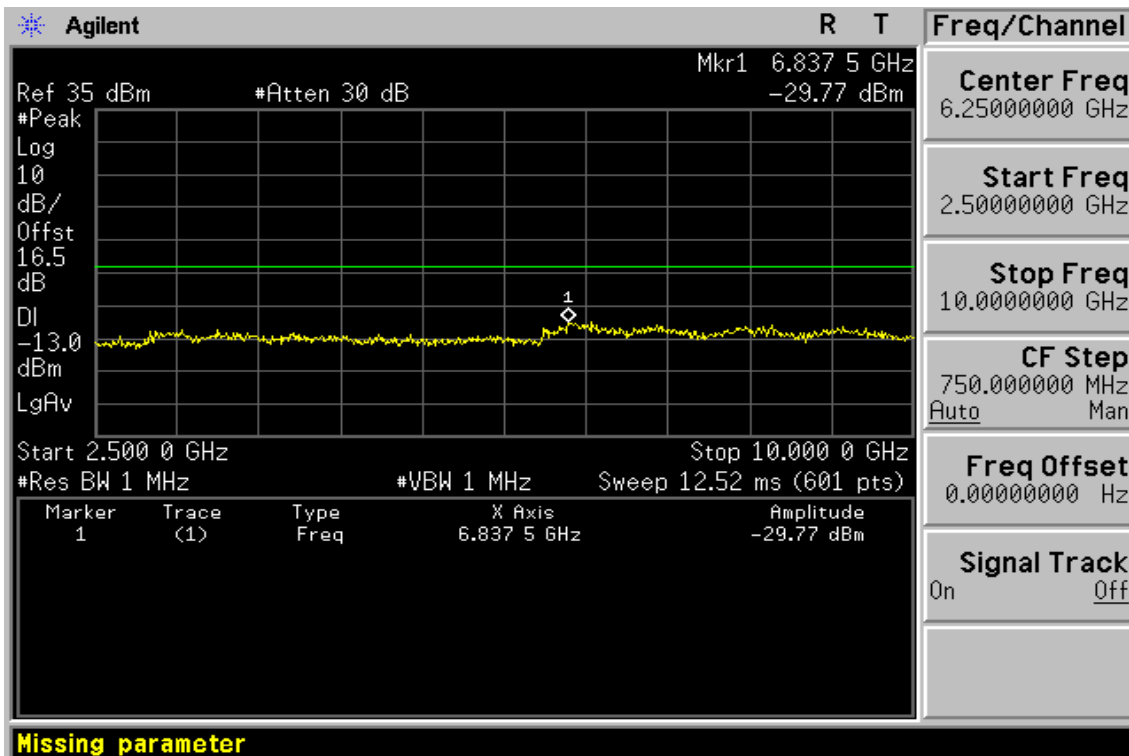
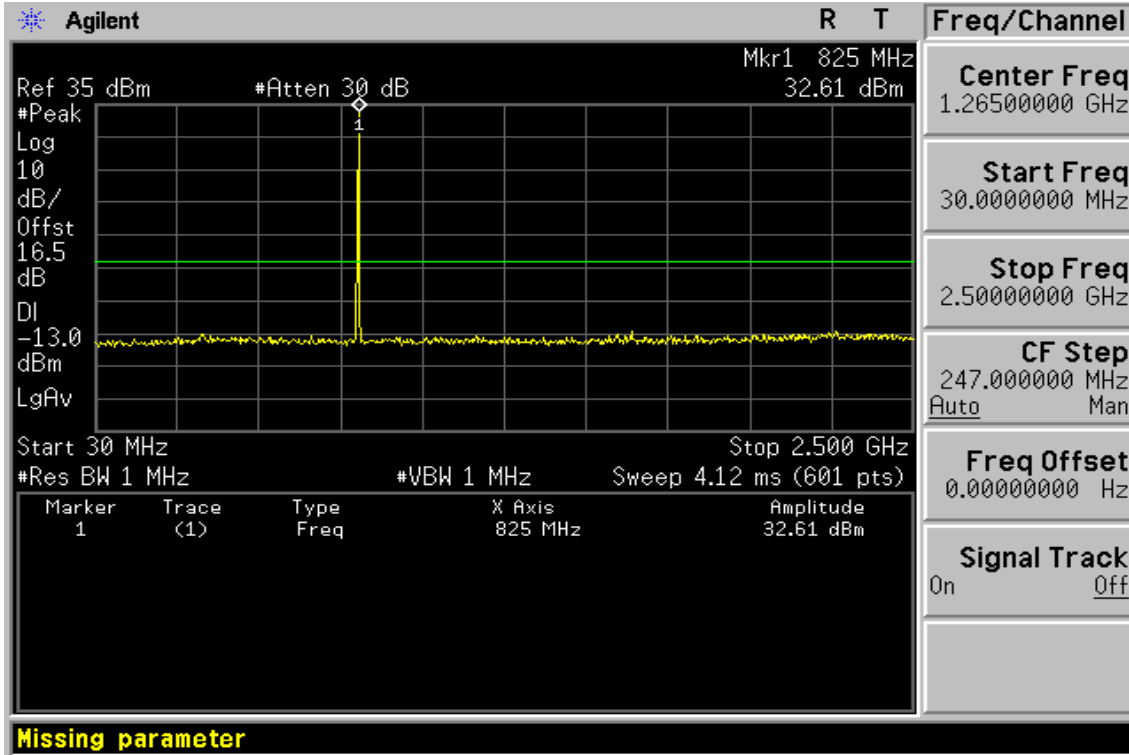

Unless otherwise stated the results shown in this test report refer only to the sample(s) tested and such sample(s) are retained for 90 days only.

除非另有說明，此報告結果僅對測試之樣品負責，同時此樣品僅保留90天。本報告未經本公司書面許可，不可部份複製。

This document is issued by the Company subject to its General Conditions of Service printed overleaf, available on request or accessible at www.sgs.com/terms_and_conditions.htm and for electronic format documents, subject to Terms and Conditions for Electronic Documents at www.sgs.com/terms_e-document.htm. Attention is drawn to the limitation of liability, indemnification and jurisdiction issues defined therein. Any holder of this document is advised that information contained hereon reflects the Company's findings at the time of its intervention only and within the limits of Client's instructions, if any. The Company's sole responsibility is to its Client and this document does not exonerate parties to a transaction from exercising all their rights and obligations under the transaction documents. This document cannot be reproduced except in full, without prior written approval of the Company. Any unauthorized alteration, forgery or falsification of the content or appearance of this document is unlawful and offenders may be prosecuted to the fullest extent of the law.

SGS Taiwan Ltd. No.134, Wu Kung Road, Wuku Industrial Zone, Taipei County, Taiwan / 台北縣五股工業區五工路 134 號

台灣檢驗科技股份有限公司 t (886-2) 2299-3279

f (886-2) 2298-0488

www.tw.sgs.com

Member of SGS Group

Figure 9-2: Out of Band emission at antenna terminals – GSM 850Channel Mid

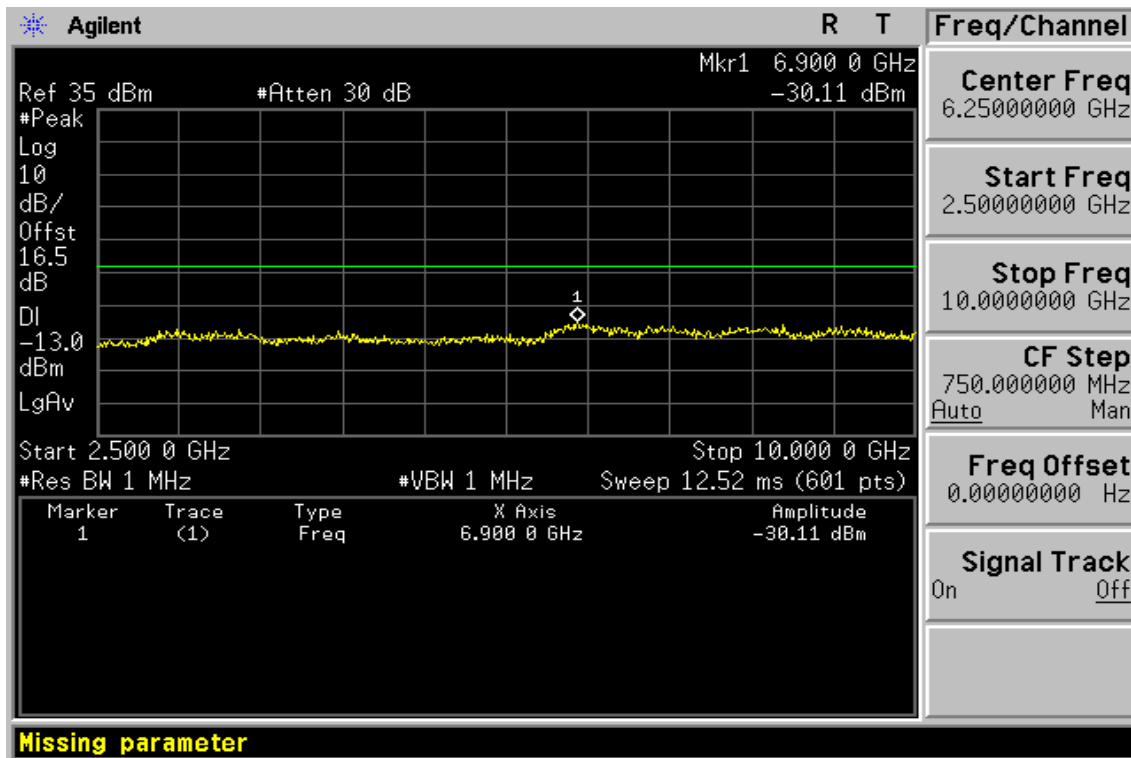
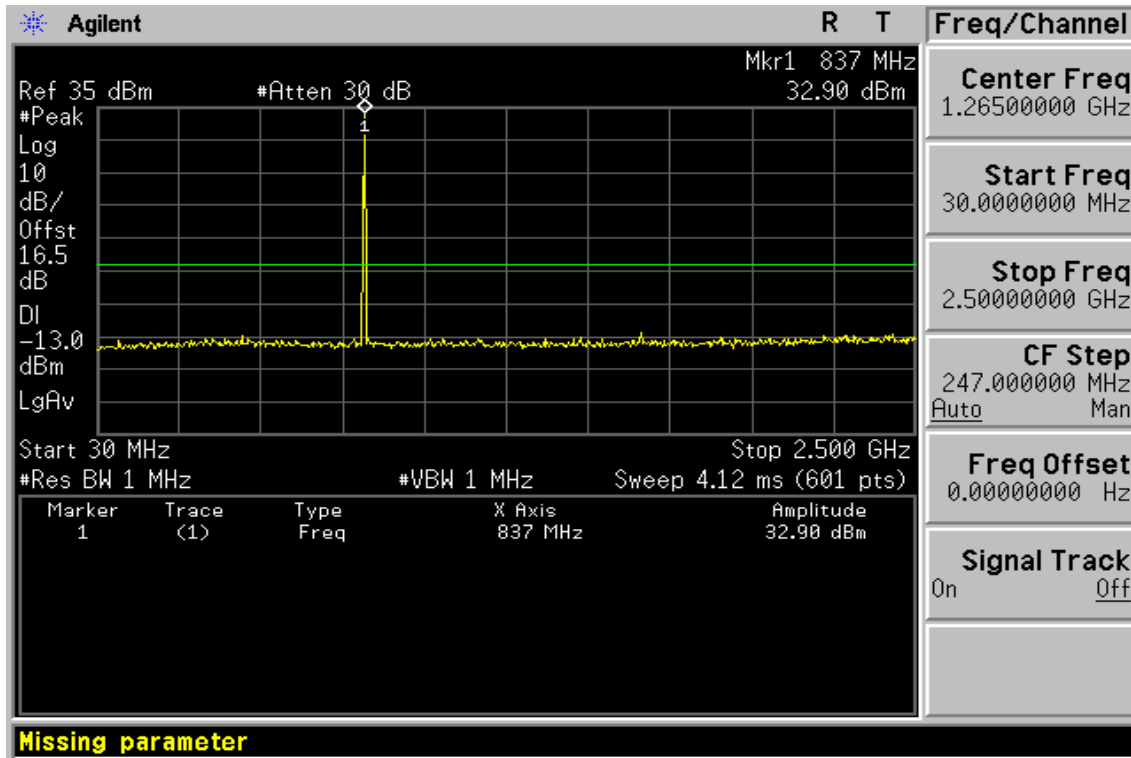

Unless otherwise stated the results shown in this test report refer only to the sample(s) tested and such sample(s) are retained for 90 days only.

除非另有說明，此報告結果僅對測試之樣品負責，同時此樣品僅保留90天。本報告未經本公司書面許可，不可部份複製。

This document is issued by the Company subject to its General Conditions of Service printed overleaf, available on request or accessible at www.sgs.com/terms_and_conditions.htm and for electronic format documents, subject to Terms and Conditions for Electronic Documents at www.sgs.com/terms_e-document.htm. Attention is drawn to the limitation of liability, indemnification and jurisdiction issues defined therein. Any holder of this document is advised that information contained hereon reflects the Company's findings at the time of its intervention only and within the limits of Client's instructions, if any. The Company's sole responsibility is to its Client and this document does not exonerate parties to a transaction from exercising all their rights and obligations under the transaction documents. This document cannot be reproduced except in full, without prior written approval of the Company. Any unauthorized alteration, forgery or falsification of the content or appearance of this document is unlawful and offenders may be prosecuted to the fullest extent of the law.

SGS Taiwan Ltd. No.134, Wu Kung Road, Wuku Industrial Zone, Taipei County, Taiwan / 台北縣五股工業區五工路 134 號

台灣檢驗科技股份有限公司 t (886-2) 2299-3279

f (886-2) 2298-0488

www.tw.sgs.com

Member of SGS Group

Figure 9-3: Out of Band emission at antenna terminals – GSM 850 Channel Highest

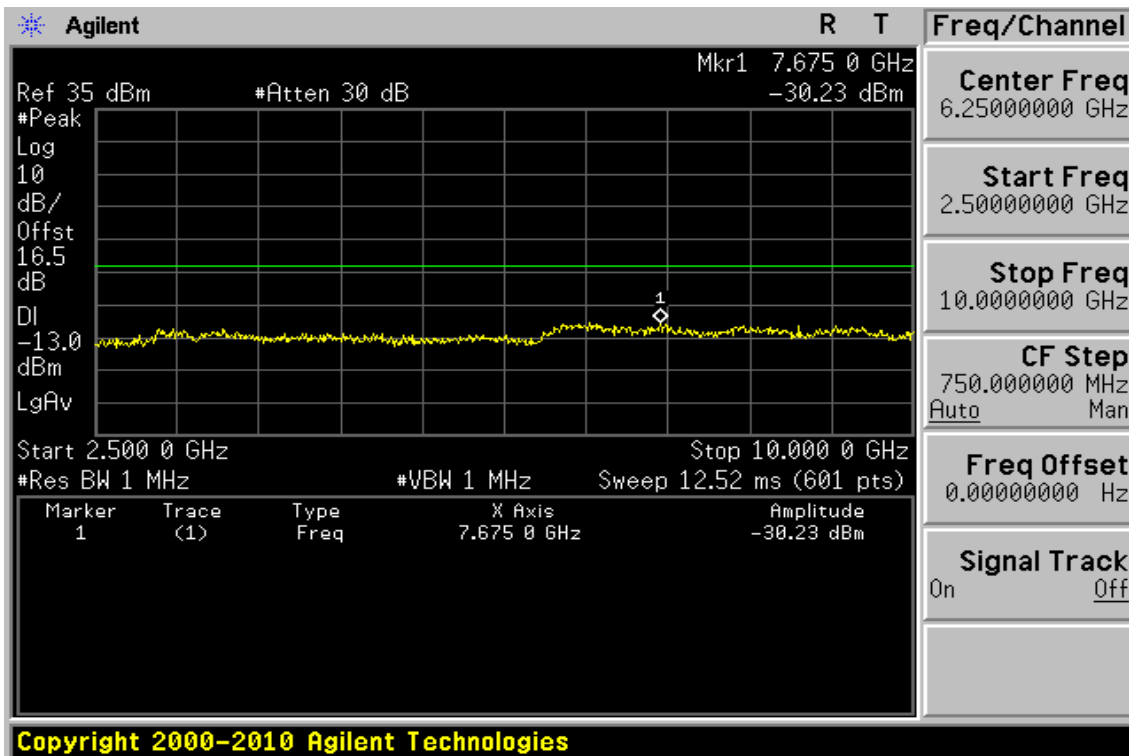
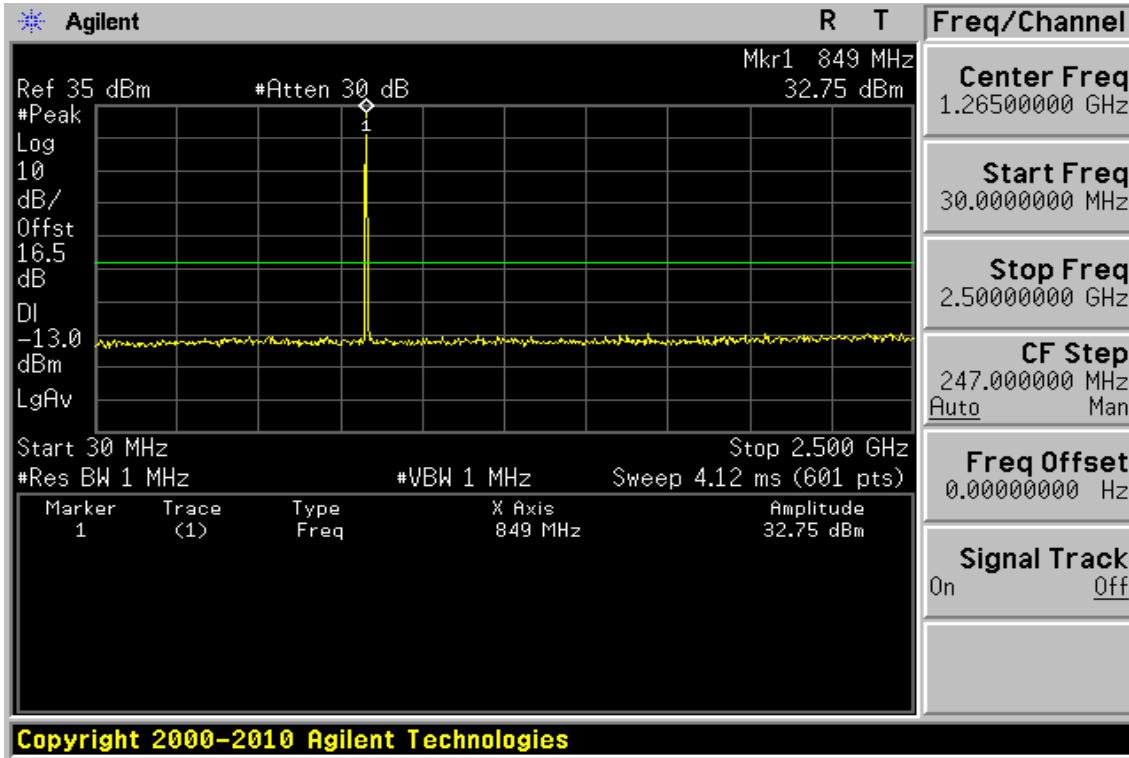

Unless otherwise stated the results shown in this test report refer only to the sample(s) tested and such sample(s) are retained for 90 days only.

除非另有說明，此報告結果僅對測試之樣品負責，同時此樣品僅保留90天。本報告未經本公司書面許可，不可部份複製。

This document is issued by the Company subject to its General Conditions of Service printed overleaf, available on request or accessible at www.sgs.com/terms_and_conditions.htm and for electronic format documents, subject to Terms and Conditions for Electronic Documents at www.sgs.com/terms_e-document.htm. Attention is drawn to the limitation of liability, indemnification and jurisdiction issues defined therein. Any holder of this document is advised that information contained hereon reflects the Company's findings at the time of its intervention only and within the limits of Client's instructions, if any. The Company's sole responsibility is to its Client and this document does not exonerate parties to a transaction from exercising all their rights and obligations under the transaction documents. This document cannot be reproduced except in full, without prior written approval of the Company. Any unauthorized alteration, forgery or falsification of the content or appearance of this document is unlawful and offenders may be prosecuted to the fullest extent of the law.

Figure 9-4: Band edge emission at antenna terminals – GSM 850 Channel Lowest

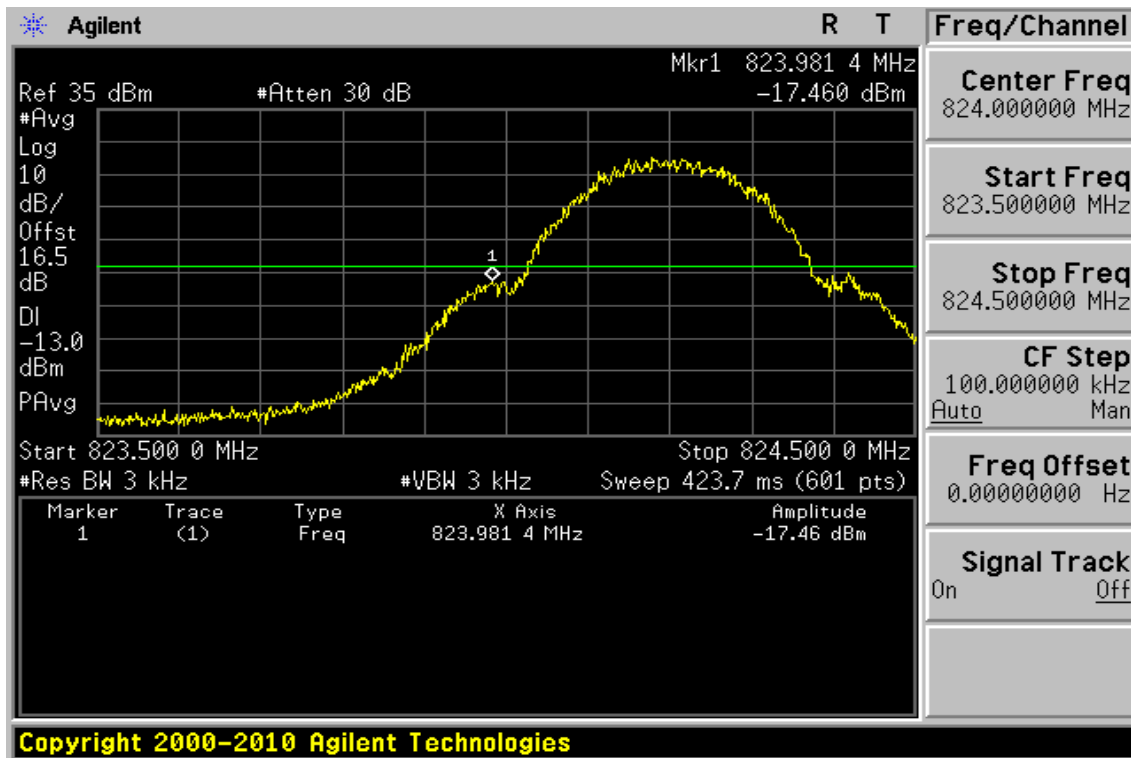
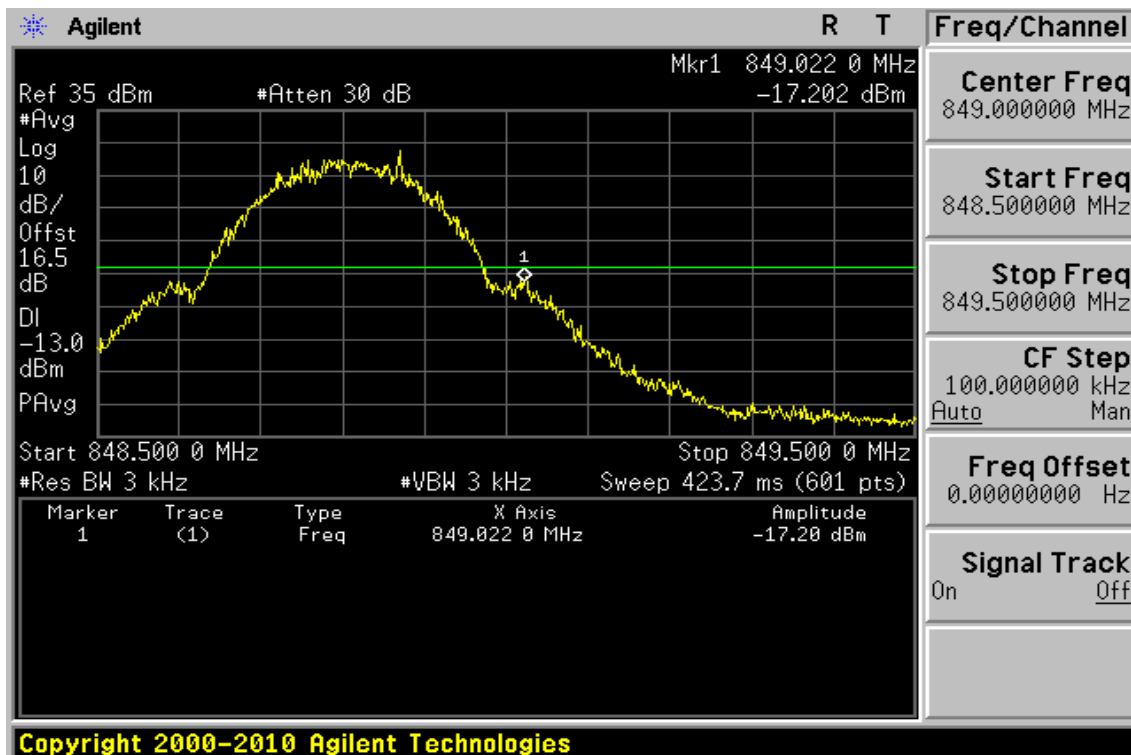

Figure 9-5: Band edge emission at antenna terminals – GSM 850 Channel Highest



Unless otherwise stated the results shown in this test report refer only to the sample(s) tested and such sample(s) are retained for 90 days only.

除非另有說明，此報告結果僅對測試之樣品負責，同時此樣品僅保留90天。本報告未經本公司書面許可，不可部份複製。

This document is issued by the Company subject to its General Conditions of Service printed overleaf, available on request or accessible at www.sgs.com/terms_and_conditions.htm and for electronic format documents, subject to Terms and Conditions for Electronic Documents at www.sgs.com/terms_e-document.htm. Attention is drawn to the limitation of liability, indemnification and jurisdiction issues defined therein. Any holder of this document is advised that information contained hereon reflects the Company's findings at the time of its intervention only and within the limits of Client's instructions, if any. The Company's sole responsibility is to its Client and this document does not exonerate parties to a transaction from exercising all their rights and obligations under the transaction documents. This document cannot be reproduced except in full, without prior written approval of the Company. Any unauthorized alteration, forgery or falsification of the content or appearance of this document is unlawful and offenders may be prosecuted to the fullest extent of the law.

Figure 9-6: Out of Band emission at antenna terminals – GSM 1900 Channel Lowest

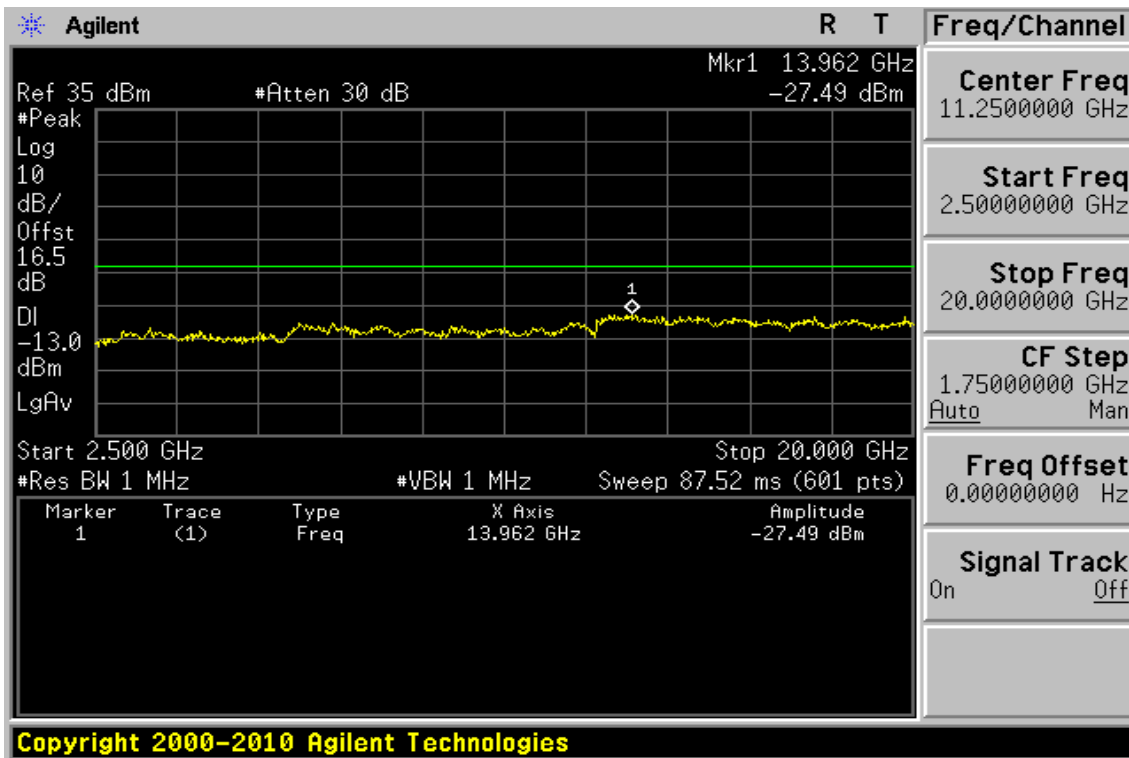
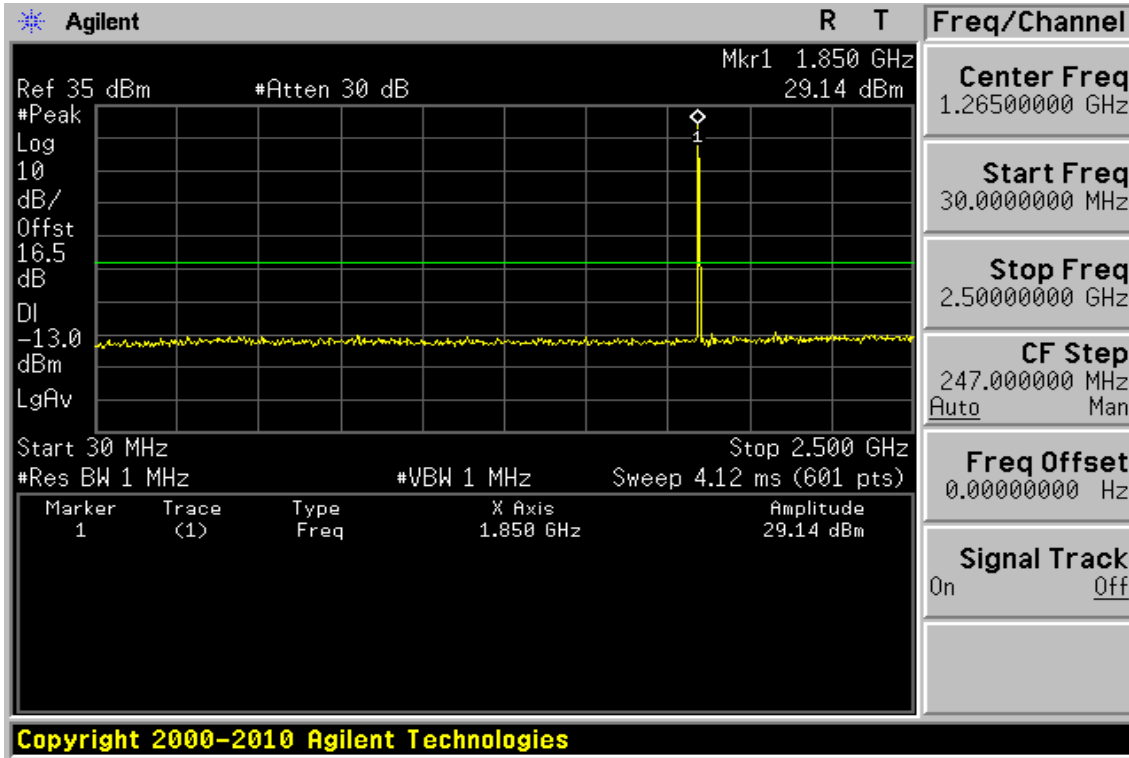

Unless otherwise stated the results shown in this test report refer only to the sample(s) tested and such sample(s) are retained for 90 days only.

除非另有說明，此報告結果僅對測試之樣品負責，同時此樣品僅保留90天。本報告未經本公司書面許可，不可部份複製。

This document is issued by the Company subject to its General Conditions of Service printed overleaf, available on request or accessible at www.sgs.com/terms_and_conditions.htm and for electronic format documents, subject to Terms and Conditions for Electronic Documents at www.sgs.com/terms_e-document.htm. Attention is drawn to the limitation of liability, indemnification and jurisdiction issues defined therein. Any holder of this document is advised that information contained hereon reflects the Company's findings at the time of its intervention only and within the limits of Client's instructions, if any. The Company's sole responsibility is to its Client and this document does not exonerate parties to a transaction from exercising all their rights and obligations under the transaction documents. This document cannot be reproduced except in full, without prior written approval of the Company. Any unauthorized alteration, forgery or falsification of the content or appearance of this document is unlawful and offenders may be prosecuted to the fullest extent of the law.

Figure 9-7: Out of Band emission at antenna terminals – GSM 1900Channel Mid

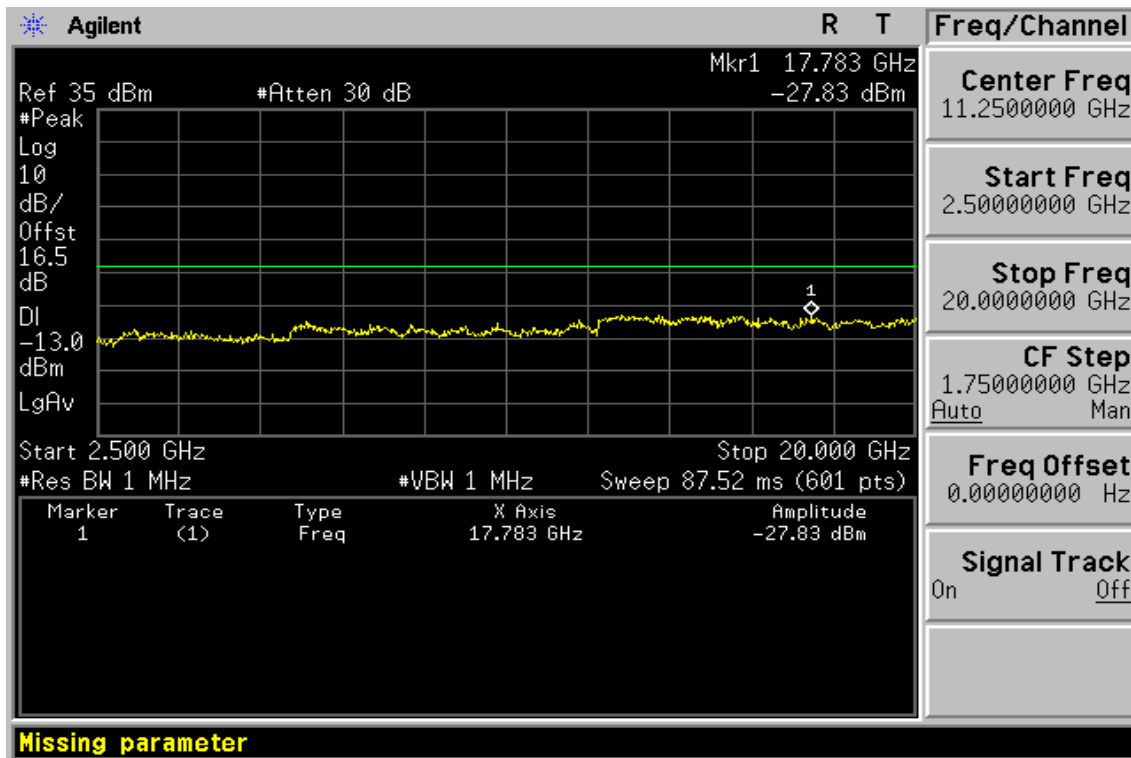
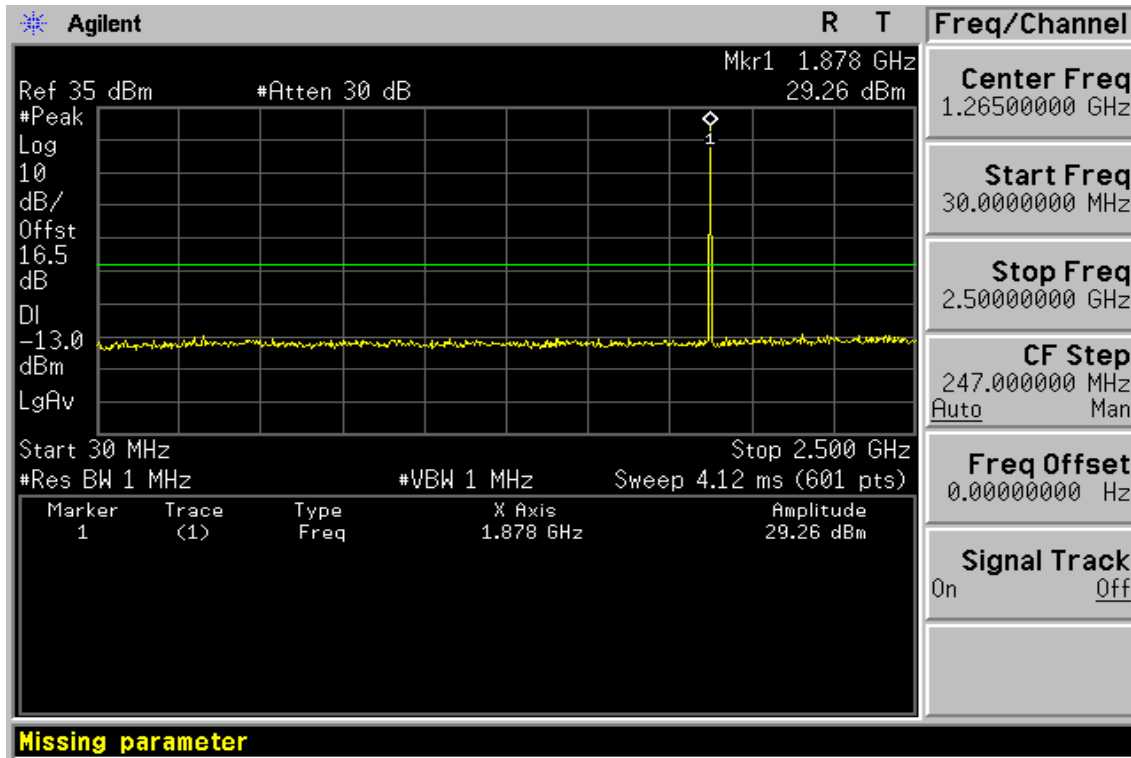

Unless otherwise stated the results shown in this test report refer only to the sample(s) tested and such sample(s) are retained for 90 days only.

除非另有說明，此報告結果僅對測試之樣品負責，同時此樣品僅保留90天。本報告未經本公司書面許可，不可部份複製。

This document is issued by the Company subject to its General Conditions of Service printed overleaf, available on request or accessible at www.sgs.com/terms_and_conditions.htm and for electronic format documents, subject to Terms and Conditions for Electronic Documents at www.sgs.com/terms_e-document.htm. Attention is drawn to the limitation of liability, indemnification and jurisdiction issues defined therein. Any holder of this document is advised that information contained hereon reflects the Company's findings at the time of its intervention only and within the limits of Client's instructions, if any. The Company's sole responsibility is to its Client and this document does not exonerate parties to a transaction from exercising all their rights and obligations under the transaction documents. This document cannot be reproduced except in full, without prior written approval of the Company. Any unauthorized alteration, forgery or falsification of the content or appearance of this document is unlawful and offenders may be prosecuted to the fullest extent of the law.

Figure 9-8: Out of Band emission at antenna terminals – GSM 1900 Channel Highest

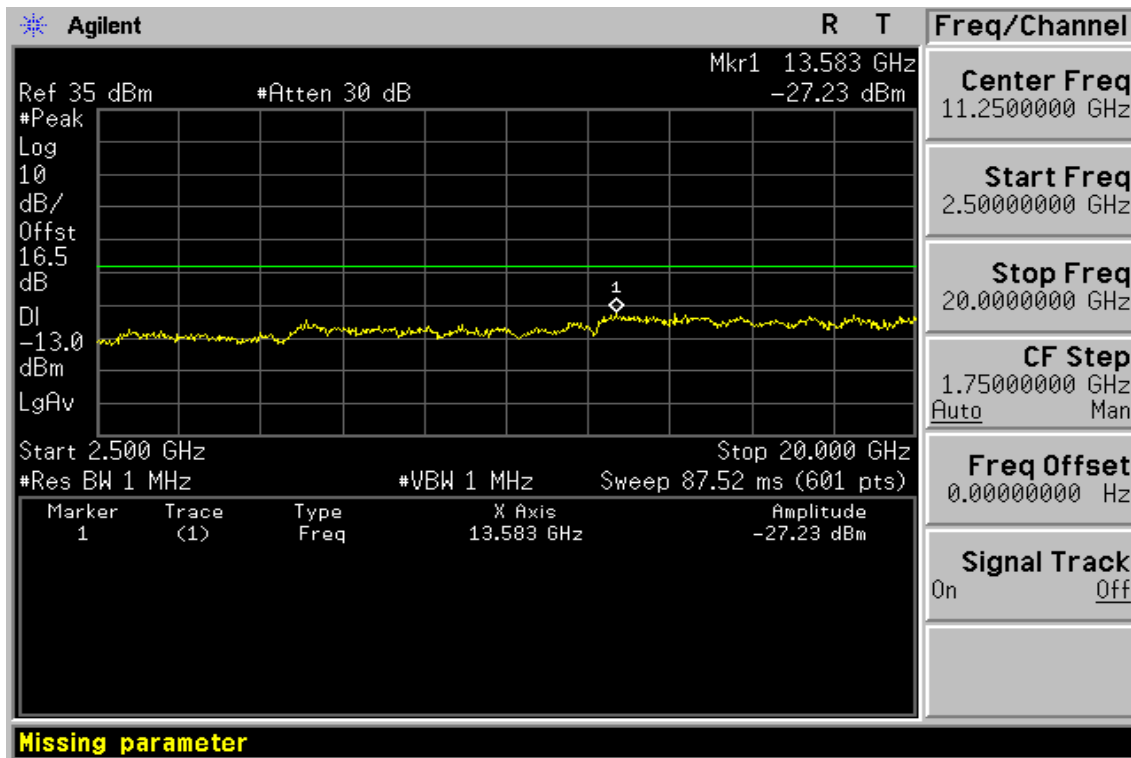
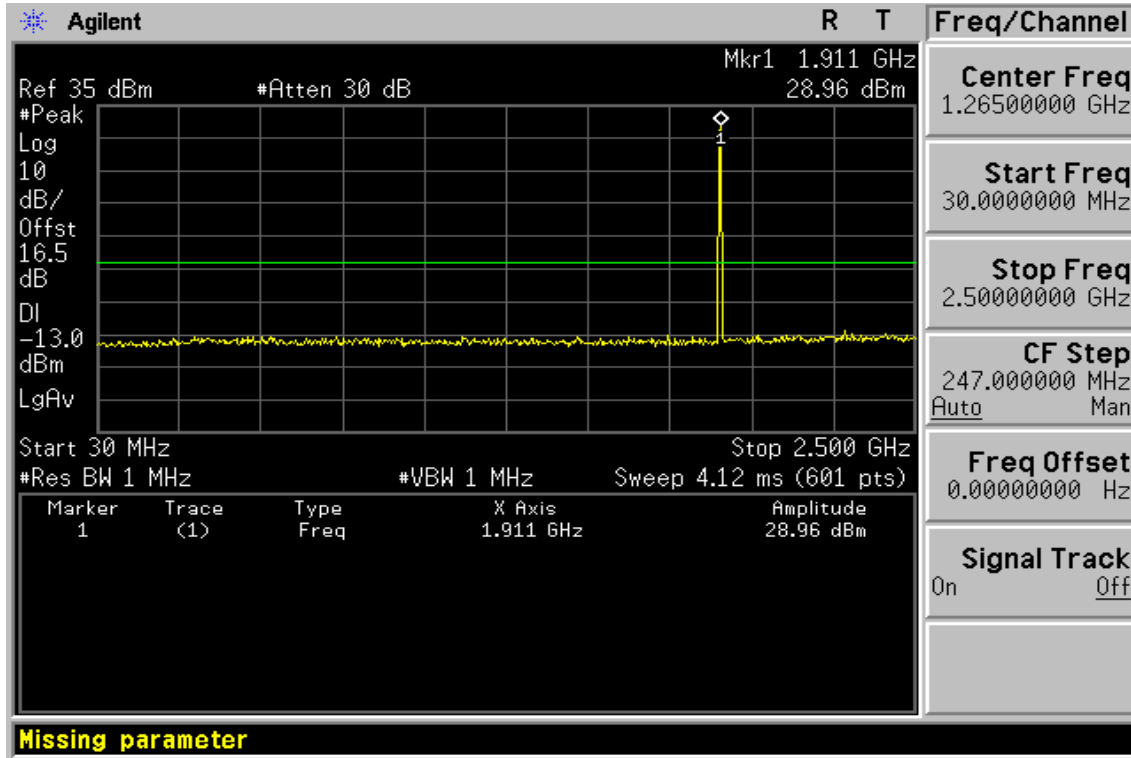

Unless otherwise stated the results shown in this test report refer only to the sample(s) tested and such sample(s) are retained for 90 days only.

除非另有說明，此報告結果僅對測試之樣品負責，同時此樣品僅保留90天。本報告未經本公司書面許可，不可部份複製。

This document is issued by the Company subject to its General Conditions of Service printed overleaf, available on request or accessible at www.sgs.com/terms_and_conditions.htm and for electronic format documents, subject to Terms and Conditions for Electronic Documents at www.sgs.com/terms_e-document.htm. Attention is drawn to the limitation of liability, indemnification and jurisdiction issues defined therein. Any holder of this document is advised that information contained hereon reflects the Company's findings at the time of its intervention only and within the limits of Client's instructions, if any. The Company's sole responsibility is to its Client and this document does not exonerate parties to a transaction from exercising all their rights and obligations under the transaction documents. This document cannot be reproduced except in full, without prior written approval of the Company. Any unauthorized alteration, forgery or falsification of the content or appearance of this document is unlawful and offenders may be prosecuted to the fullest extent of the law.

Figure 9-9: Bad edge emission at antenna terminals – GSM 1900 Channel Lowest

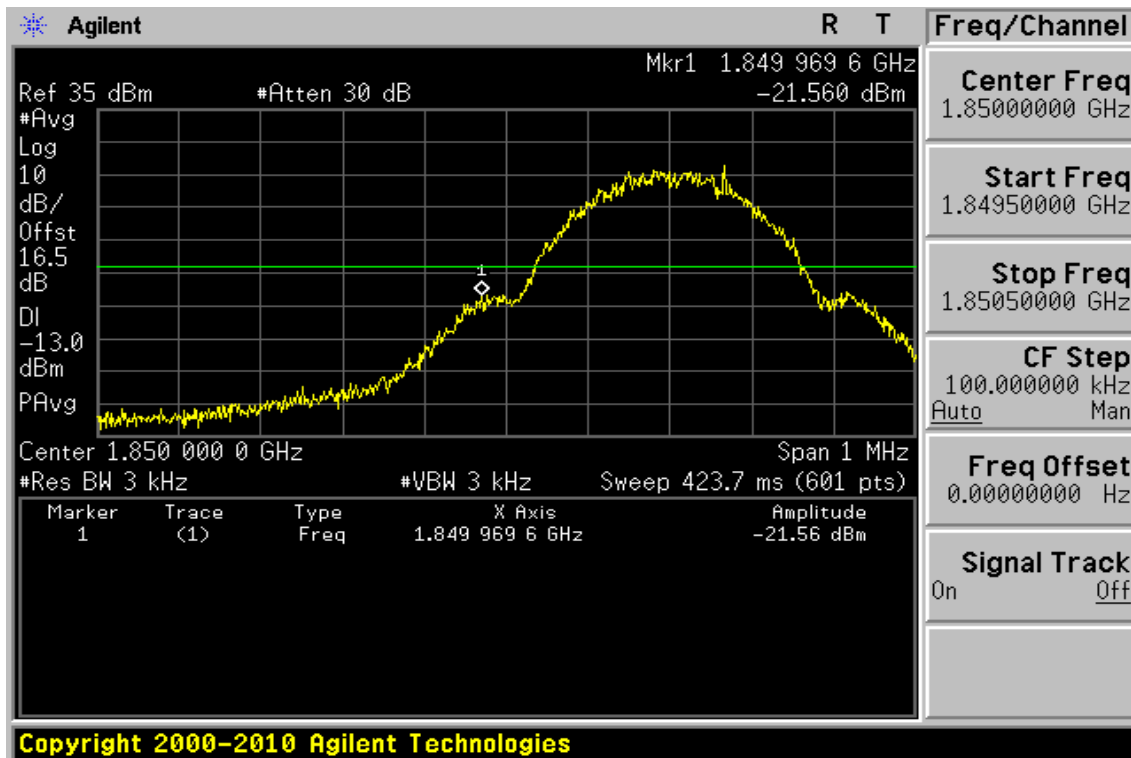
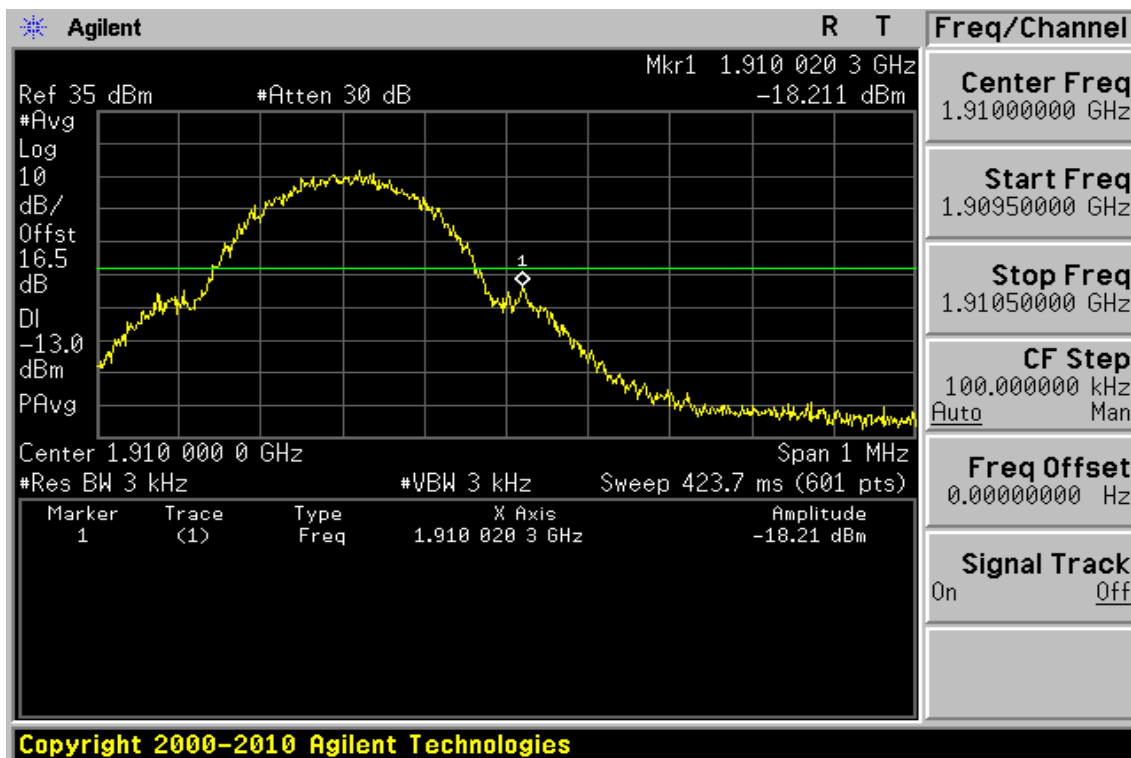

Figure 9-10: Band edge emission at antenna terminals – GSM 1900 Channel Highest



Unless otherwise stated the results shown in this test report refer only to the sample(s) tested and such sample(s) are retained for 90 days only.

除非另有說明，此報告結果僅對測試之樣品負責，同時此樣品僅保留90天。本報告未經本公司書面許可，不可部份複製。

This document is issued by the Company subject to its General Conditions of Service printed overleaf, available on request or accessible at www.sgs.com/terms_and_conditions.htm and for electronic format documents, subject to Terms and Conditions for Electronic Documents at www.sgs.com/terms_e-document.htm. Attention is drawn to the limitation of liability, indemnification and jurisdiction issues defined therein. Any holder of this document is advised that information contained hereon reflects the Company's findings at the time of its intervention only and within the limits of Client's instructions, if any. The Company's sole responsibility is to its Client and this document does not exonerate parties to a transaction from exercising all their rights and obligations under the transaction documents. This document cannot be reproduced except in full, without prior written approval of the Company. Any unauthorized alteration, forgery or falsification of the content or appearance of this document is unlawful and offenders may be prosecuted to the fullest extent of the law.

Figure 9-11: Out of Band emission at antenna terminals – EDGE 850 Channel Lowest

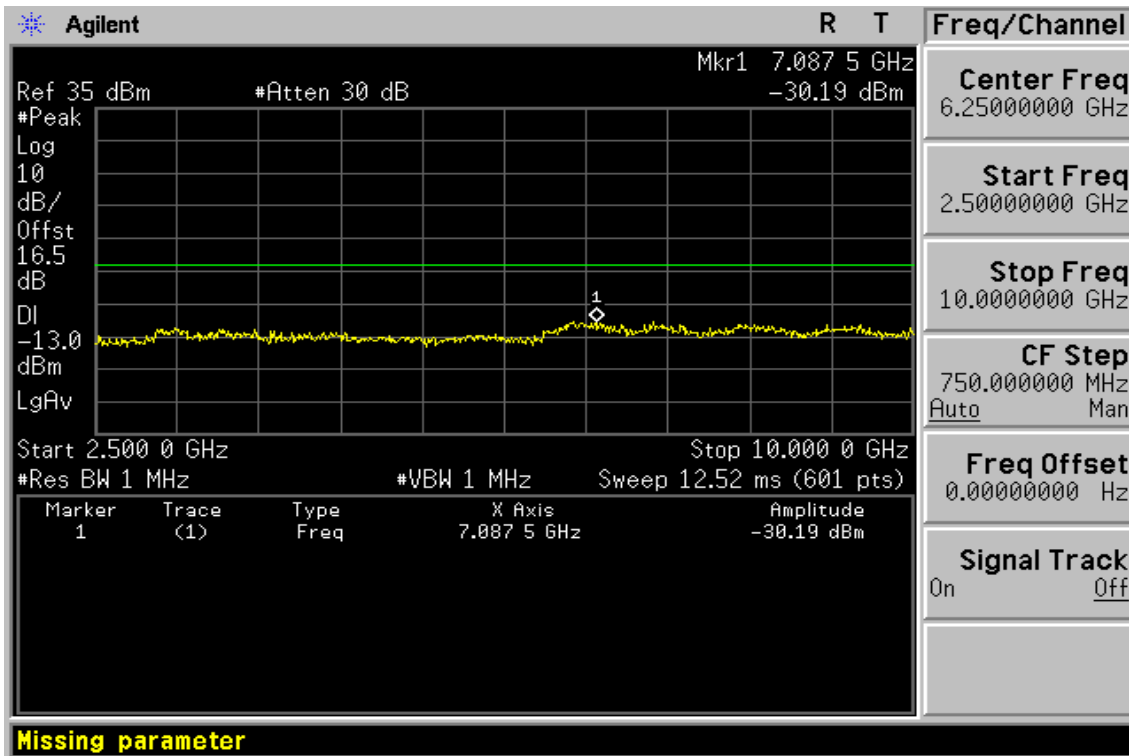
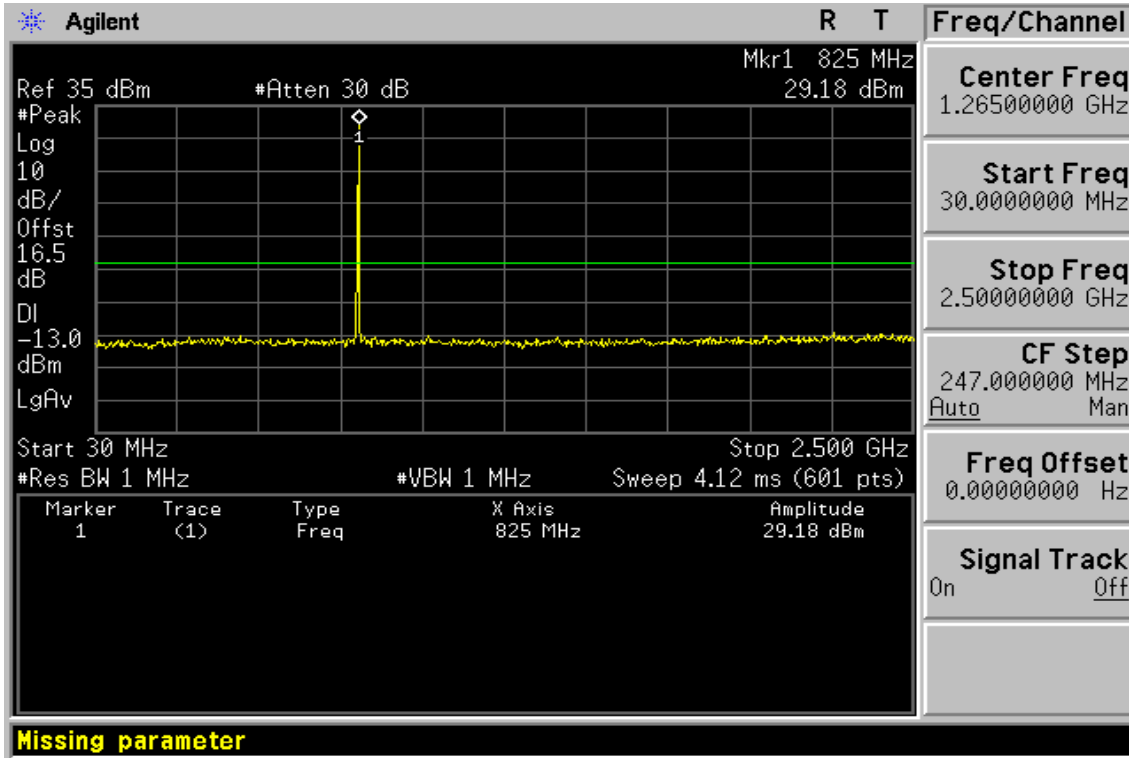

Unless otherwise stated the results shown in this test report refer only to the sample(s) tested and such sample(s) are retained for 90 days only.

除非另有說明，此報告結果僅對測試之樣品負責，同時此樣品僅保留90天。本報告未經本公司書面許可，不可部份複製。

This document is issued by the Company subject to its General Conditions of Service printed overleaf, available on request or accessible at www.sgs.com/terms_and_conditions.htm and for electronic format documents, subject to Terms and Conditions for Electronic Documents at www.sgs.com/terms_e-document.htm. Attention is drawn to the limitation of liability, indemnification and jurisdiction issues defined therein. Any holder of this document is advised that information contained hereon reflects the Company's findings at the time of its intervention only and within the limits of Client's instructions, if any. The Company's sole responsibility is to its Client and this document does not exonerate parties to a transaction from exercising all their rights and obligations under the transaction documents. This document cannot be reproduced except in full, without prior written approval of the Company. Any unauthorized alteration, forgery or falsification of the content or appearance of this document is unlawful and offenders may be prosecuted to the fullest extent of the law.

Figure 9-12: Out of Band emission at antenna terminals – EDGE 850 Channel Mid

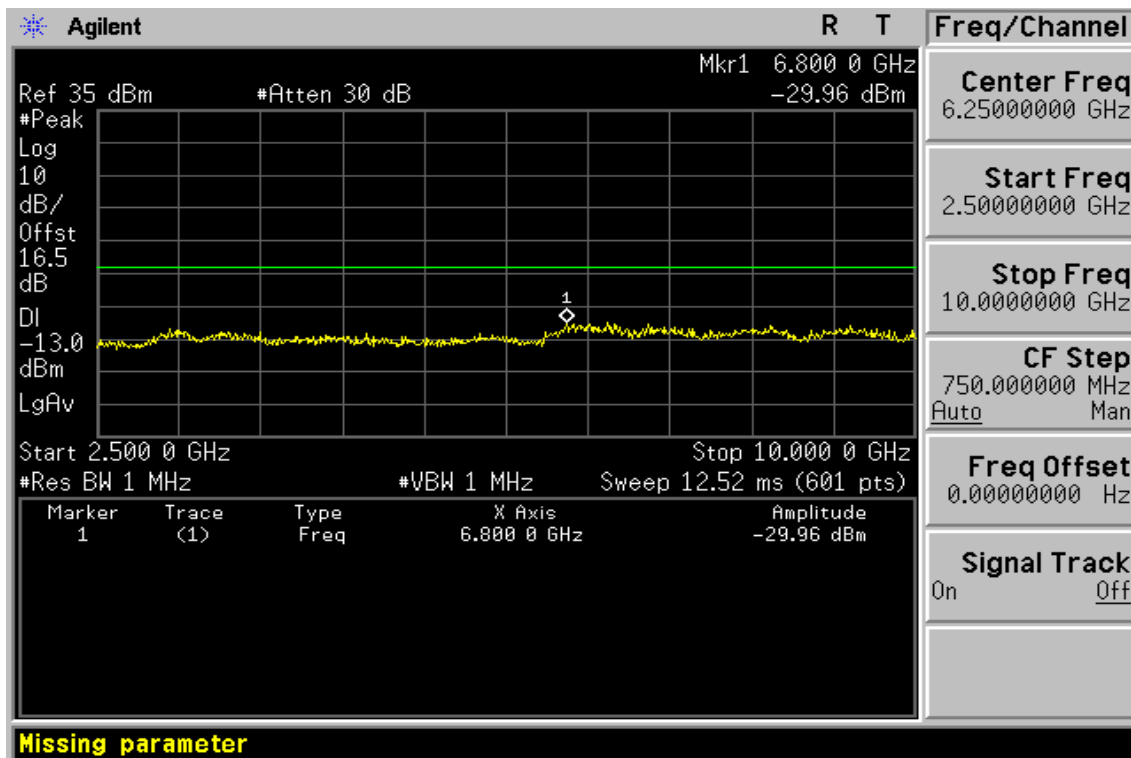
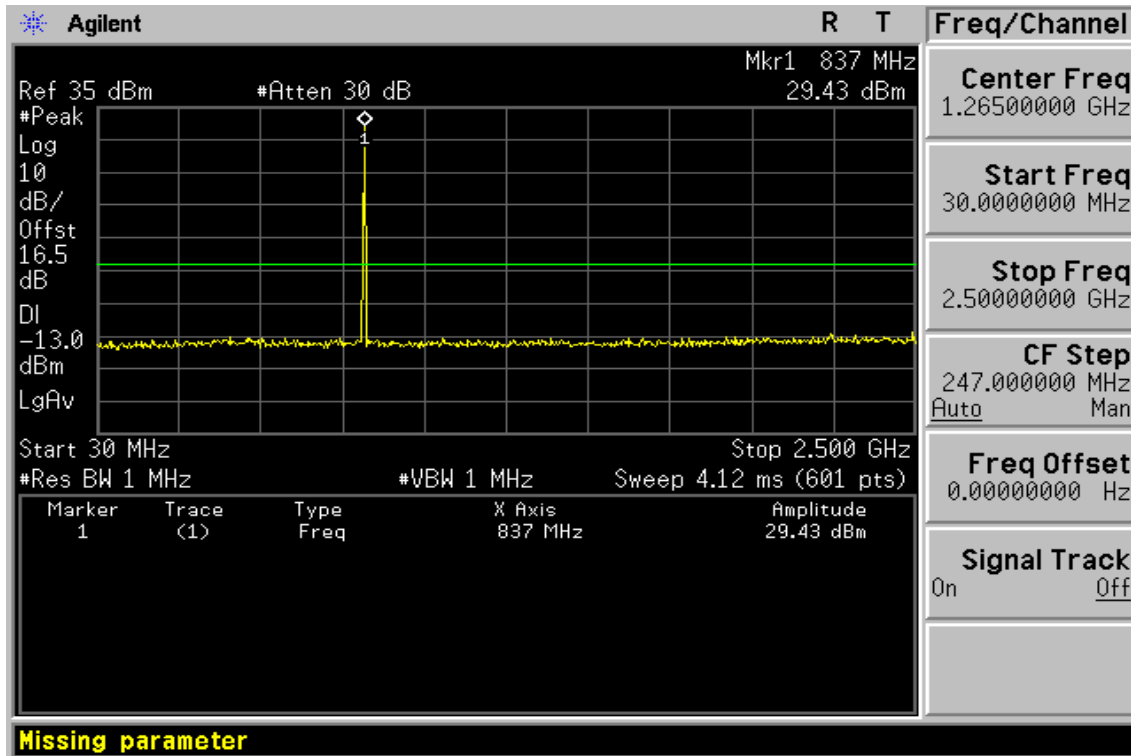

Unless otherwise stated the results shown in this test report refer only to the sample(s) tested and such sample(s) are retained for 90 days only.

除非另有說明，此報告結果僅對測試之樣品負責，同時此樣品僅保留90天。本報告未經本公司書面許可，不可部份複製。

This document is issued by the Company subject to its General Conditions of Service printed overleaf, available on request or accessible at www.sgs.com/terms_and_conditions.htm and for electronic format documents, subject to Terms and Conditions for Electronic Documents at www.sgs.com/terms_e-document.htm. Attention is drawn to the limitation of liability, indemnification and jurisdiction issues defined therein. Any holder of this document is advised that information contained hereon reflects the Company's findings at the time of its intervention only and within the limits of Client's instructions, if any. The Company's sole responsibility is to its Client and this document does not exonerate parties to a transaction from exercising all their rights and obligations under the transaction documents. This document cannot be reproduced except in full, without prior written approval of the Company. Any unauthorized alteration, forgery or falsification of the content or appearance of this document is unlawful and offenders may be prosecuted to the fullest extent of the law.

Figure 9-13: Out of Band emission at antenna terminals – EDGE 850 Channel Highest

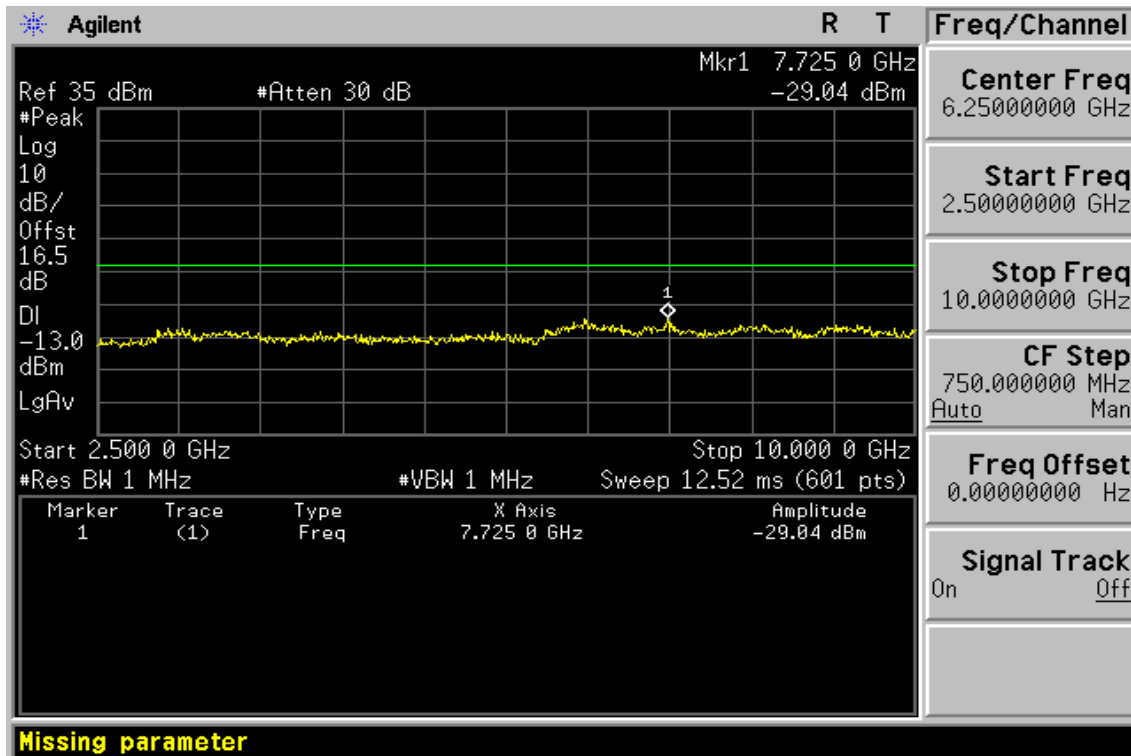
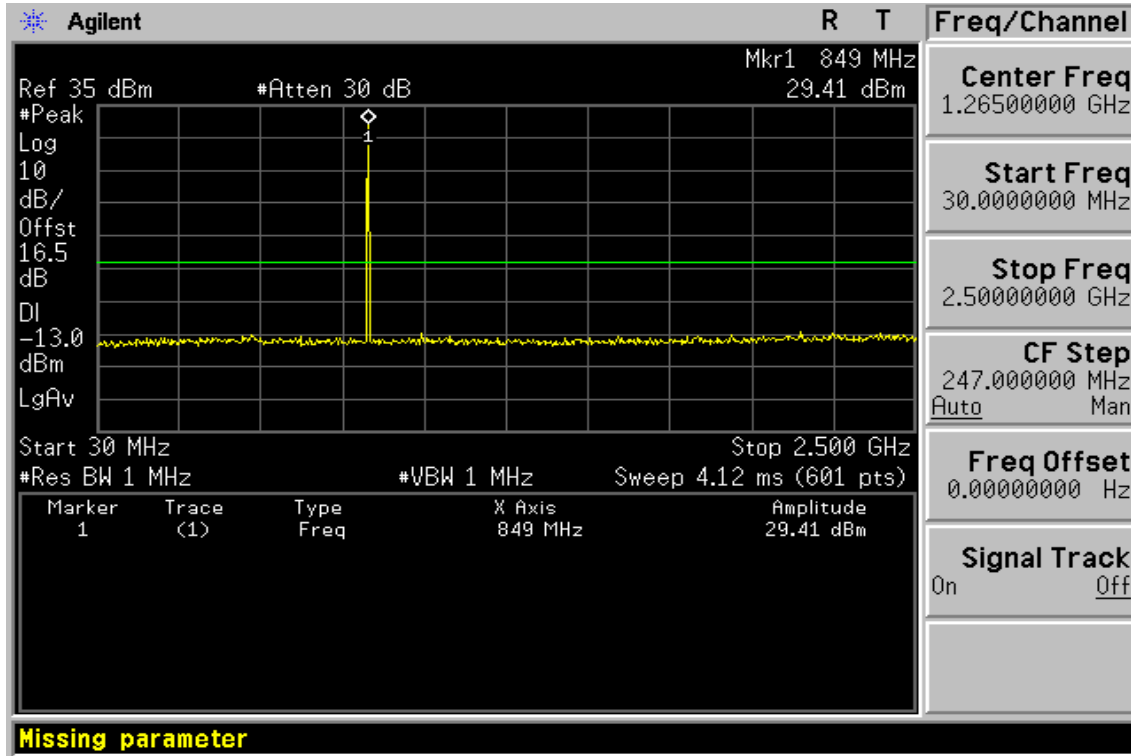

Unless otherwise stated the results shown in this test report refer only to the sample(s) tested and such sample(s) are retained for 90 days only.

除非另有說明，此報告結果僅對測試之樣品負責，同時此樣品僅保留90天。本報告未經本公司書面許可，不可部份複製。

This document is issued by the Company subject to its General Conditions of Service printed overleaf, available on request or accessible at www.sgs.com/terms_and_conditions.htm and for electronic format documents, subject to Terms and Conditions for Electronic Documents at www.sgs.com/terms_e-document.htm. Attention is drawn to the limitation of liability, indemnification and jurisdiction issues defined therein. Any holder of this document is advised that information contained hereon reflects the Company's findings at the time of its intervention only and within the limits of Client's instructions, if any. The Company's sole responsibility is to its Client and this document does not exonerate parties to a transaction from exercising all their rights and obligations under the transaction documents. This document cannot be reproduced except in full, without prior written approval of the Company. Any unauthorized alteration, forgery or falsification of the content or appearance of this document is unlawful and offenders may be prosecuted to the fullest extent of the law.

Figure 9-14: Band edge emission at antenna terminals – EDGE 850 Channel Lowest

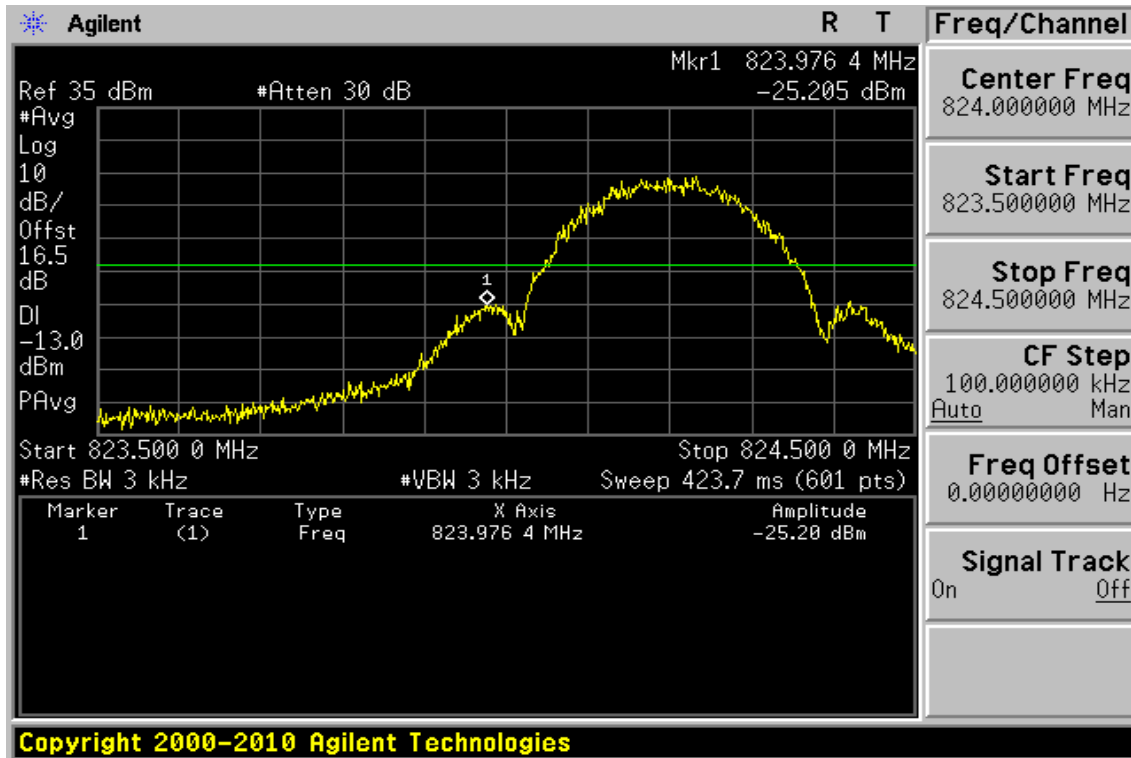
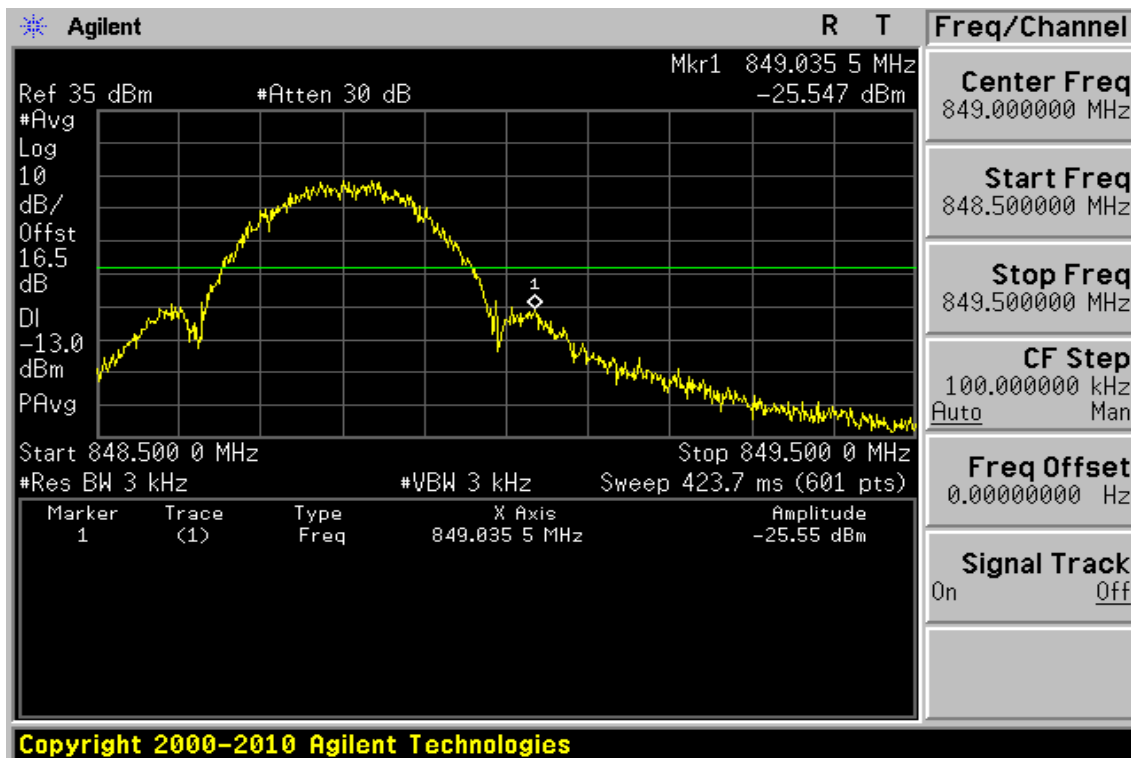

Figure 9-15: Band edge emission at antenna terminals – EDGE 850 Channel Highest



Unless otherwise stated the results shown in this test report refer only to the sample(s) tested and such sample(s) are retained for 90 days only.

除非另有說明，此報告結果僅對測試之樣品負責，同時此樣品僅保留90天。本報告未經本公司書面許可，不可部份複製。

This document is issued by the Company subject to its General Conditions of Service printed overleaf, available on request or accessible at www.sgs.com/terms_and_conditions.htm and for electronic format documents, subject to Terms and Conditions for Electronic Documents at www.sgs.com/terms_e-document.htm. Attention is drawn to the limitation of liability, indemnification and jurisdiction issues defined therein. Any holder of this document is advised that information contained hereon reflects the Company's findings at the time of its intervention only and within the limits of Client's instructions, if any. The Company's sole responsibility is to its Client and this document does not exonerate parties to a transaction from exercising all their rights and obligations under the transaction documents. This document cannot be reproduced except in full, without prior written approval of the Company. Any unauthorized alteration, forgery or falsification of the content or appearance of this document is unlawful and offenders may be prosecuted to the fullest extent of the law.

SGS Taiwan Ltd. No.134, Wu Kung Road, Wuku Industrial Zone, Taipei County, Taiwan / 台北縣五股工業區五工路 134 號

台灣檢驗科技股份有限公司

t (886-2) 2299-3279

f (886-2) 2298-0488

www.tw.sgs.com

Member of SGS Group

Figure 9-16: Out of Band emission at antenna terminals – EDGE 1900Channel Lowest

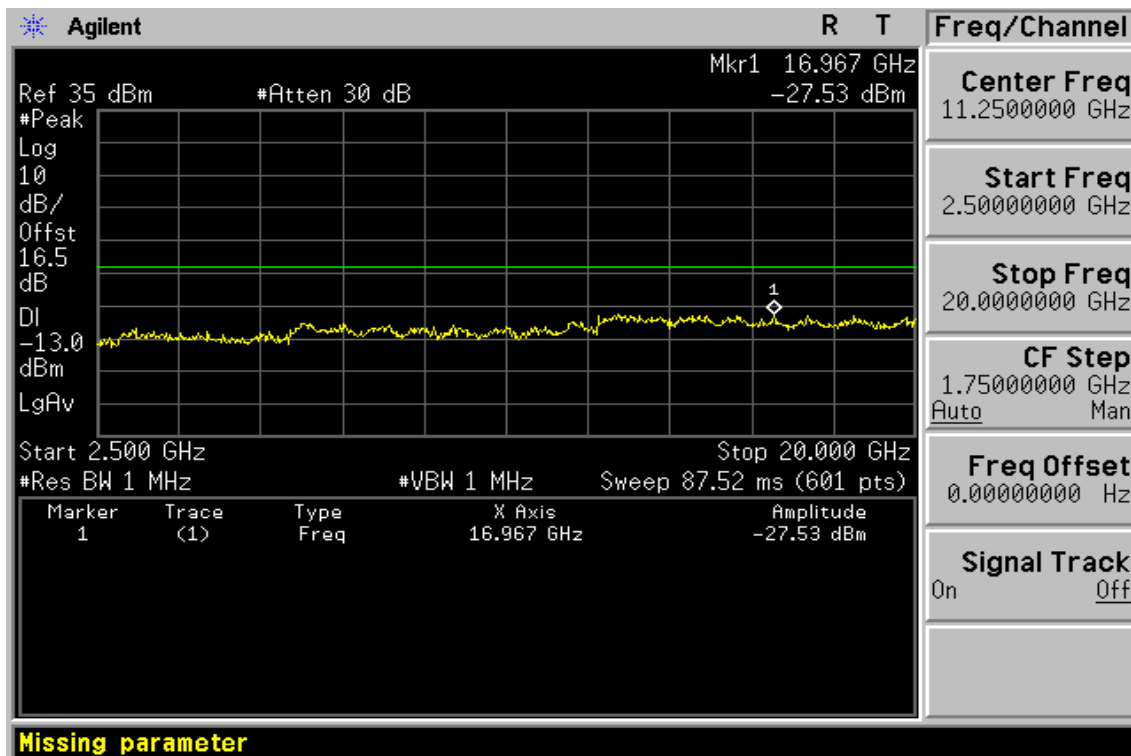
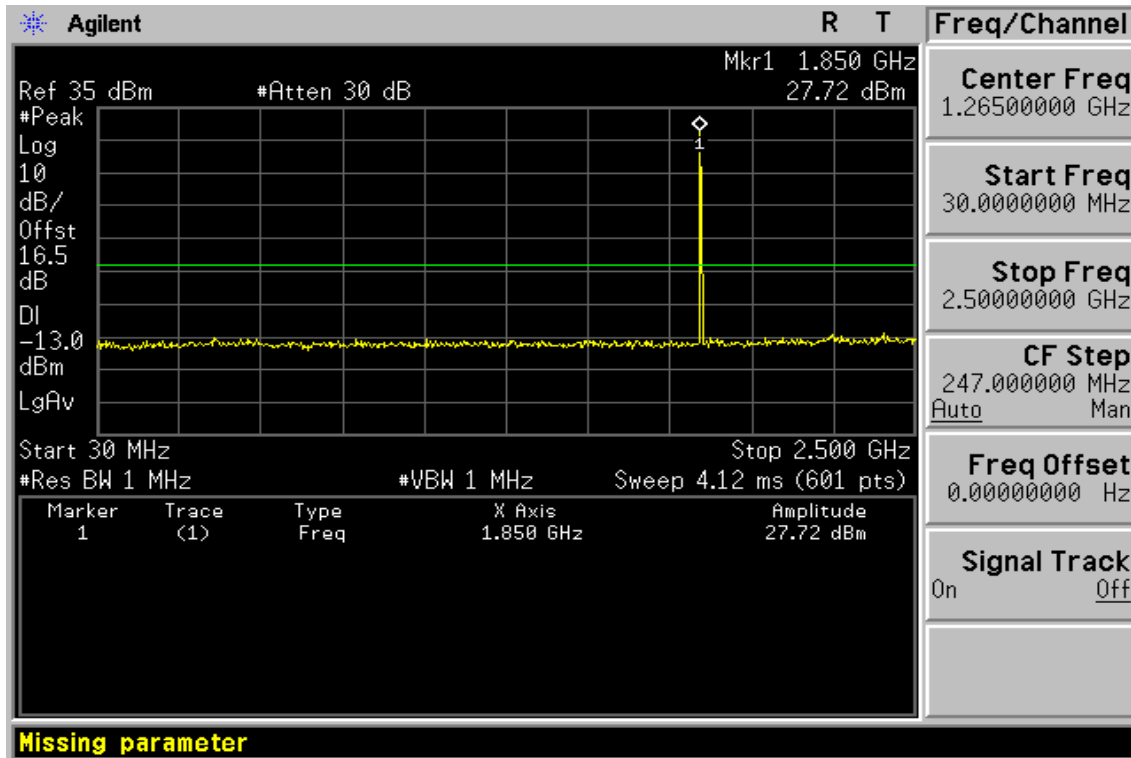

Unless otherwise stated the results shown in this test report refer only to the sample(s) tested and such sample(s) are retained for 90 days only.

除非另有說明，此報告結果僅對測試之樣品負責，同時此樣品僅保留90天。本報告未經本公司書面許可，不可部份複製。

This document is issued by the Company subject to its General Conditions of Service printed overleaf, available on request or accessible at www.sgs.com/terms_and_conditions.htm and for electronic format documents, subject to Terms and Conditions for Electronic Documents at www.sgs.com/terms_e-document.htm. Attention is drawn to the limitation of liability, indemnification and jurisdiction issues defined therein. Any holder of this document is advised that information contained hereon reflects the Company's findings at the time of its intervention only and within the limits of Client's instructions, if any. The Company's sole responsibility is to its Client and this document does not exonerate parties to a transaction from exercising all their rights and obligations under the transaction documents. This document cannot be reproduced except in full, without prior written approval of the Company. Any unauthorized alteration, forgery or falsification of the content or appearance of this document is unlawful and offenders may be prosecuted to the fullest extent of the law.

Figure 9-17: Out of Band emission at antenna terminals – EDGE 1900 Channel Mid

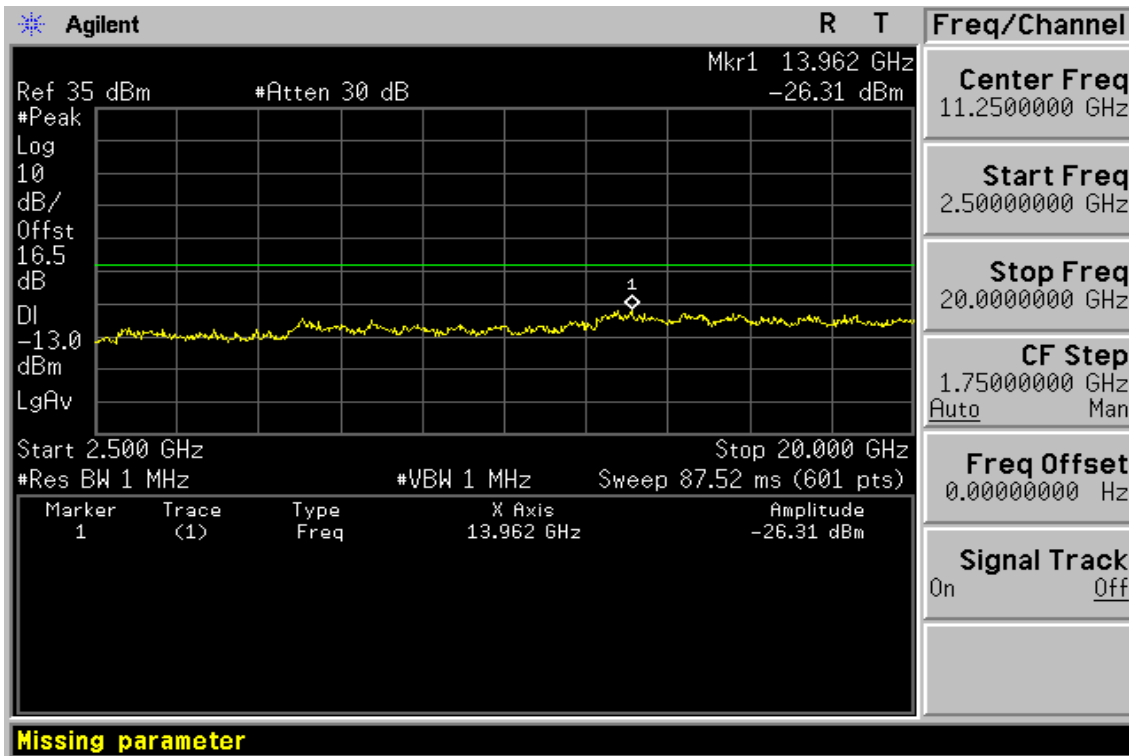
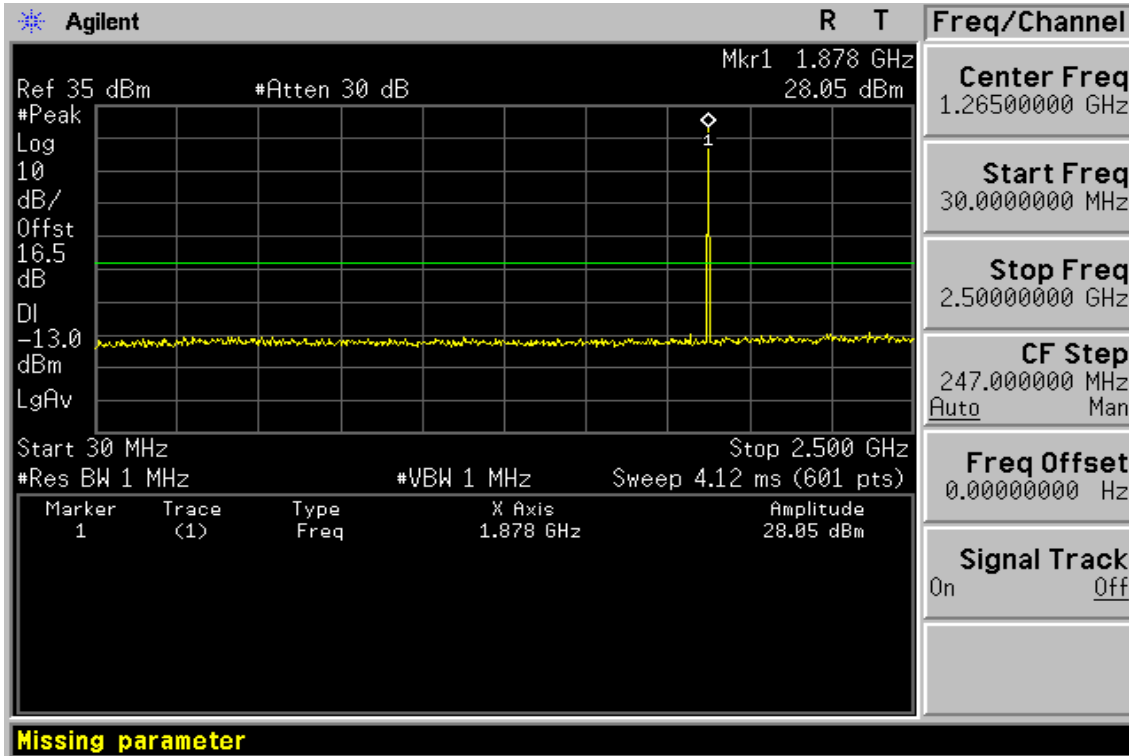

Unless otherwise stated the results shown in this test report refer only to the sample(s) tested and such sample(s) are retained for 90 days only.

除非另有說明，此報告結果僅對測試之樣品負責，同時此樣品僅保留90天。本報告未經本公司書面許可，不可部份複製。

This document is issued by the Company subject to its General Conditions of Service printed overleaf, available on request or accessible at www.sgs.com/terms_and_conditions.htm and for electronic format documents, subject to Terms and Conditions for Electronic Documents at www.sgs.com/terms_e-document.htm. Attention is drawn to the limitation of liability, indemnification and jurisdiction issues defined therein. Any holder of this document is advised that information contained hereon reflects the Company's findings at the time of its intervention only and within the limits of Client's instructions, if any. The Company's sole responsibility is to its Client and this document does not exonerate parties to a transaction from exercising all their rights and obligations under the transaction documents. This document cannot be reproduced except in full, without prior written approval of the Company. Any unauthorized alteration, forgery or falsification of the content or appearance of this document is unlawful and offenders may be prosecuted to the fullest extent of the law.

Figure 9-18: Out of Band emission at antenna terminals – EDGE 1900 Channel Highest

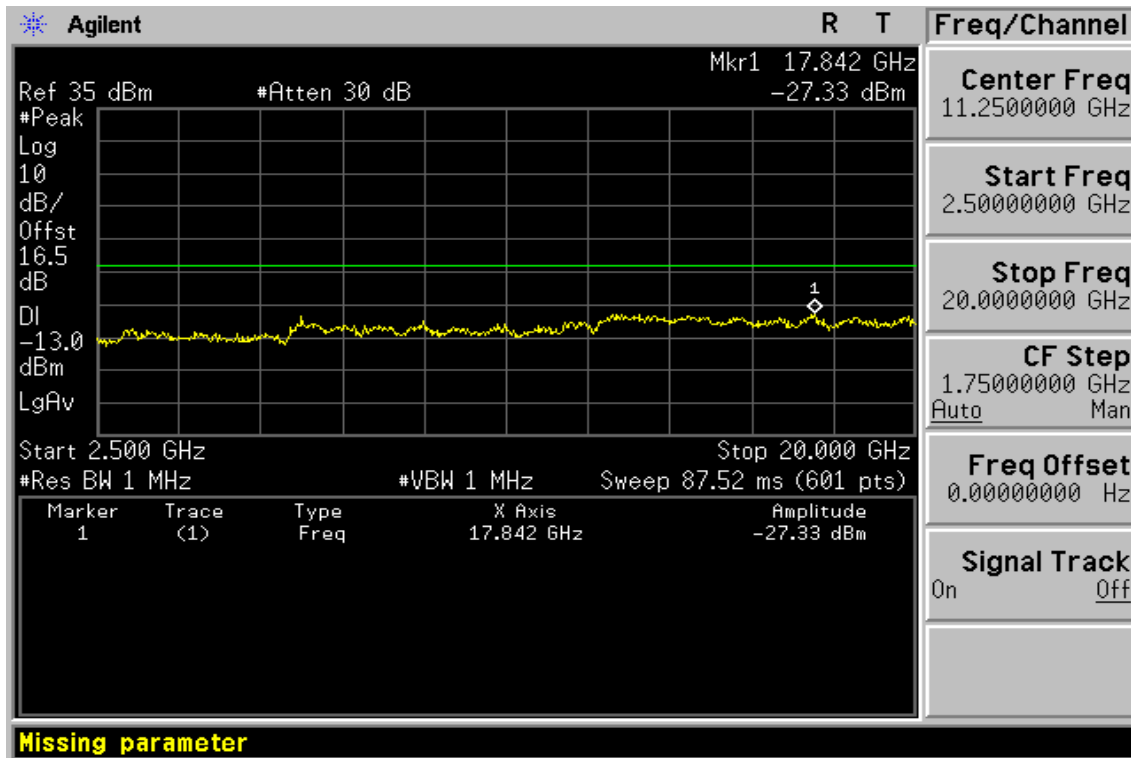
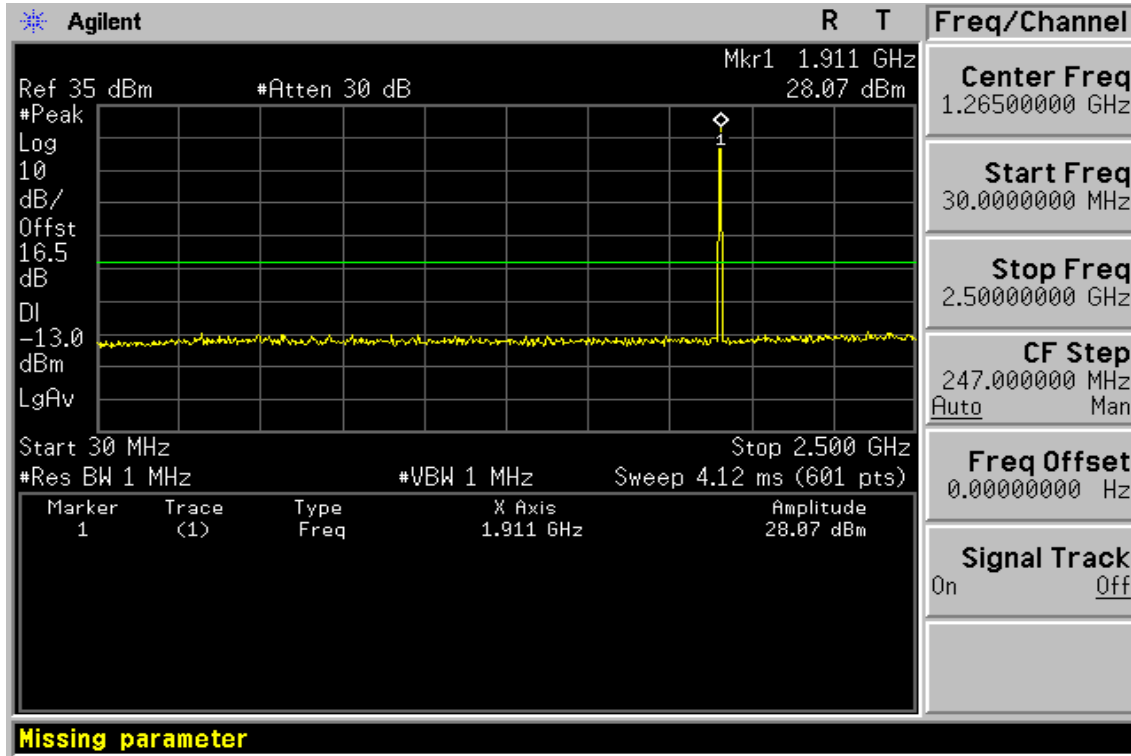

Unless otherwise stated the results shown in this test report refer only to the sample(s) tested and such sample(s) are retained for 90 days only.

除非另有說明，此報告結果僅對測試之樣品負責，同時此樣品僅保留90天。本報告未經本公司書面許可，不可部份複製。

This document is issued by the Company subject to its General Conditions of Service printed overleaf, available on request or accessible at www.sgs.com/terms_and_conditions.htm and for electronic format documents, subject to Terms and Conditions for Electronic Documents at www.sgs.com/terms_e-document.htm. Attention is drawn to the limitation of liability, indemnification and jurisdiction issues defined therein. Any holder of this document is advised that information contained hereon reflects the Company's findings at the time of its intervention only and within the limits of Client's instructions, if any. The Company's sole responsibility is to its Client and this document does not exonerate parties to a transaction from exercising all their rights and obligations under the transaction documents. This document cannot be reproduced except in full, without prior written approval of the Company. Any unauthorized alteration, forgery or falsification of the content or appearance of this document is unlawful and offenders may be prosecuted to the fullest extent of the law.

SGS Taiwan Ltd. No.134, Wu Kung Road, Wuku Industrial Zone, Taipei County, Taiwan / 台北縣五股工業區五工路 134 號

台灣檢驗科技股份有限公司 t (886-2) 2299-3279

f (886-2) 2298-0488

www.tw.sgs.com

Member of SGS Group

Figure 9-19: Bad edge emission at antenna terminals – EDGE 1900 Channel Lowest

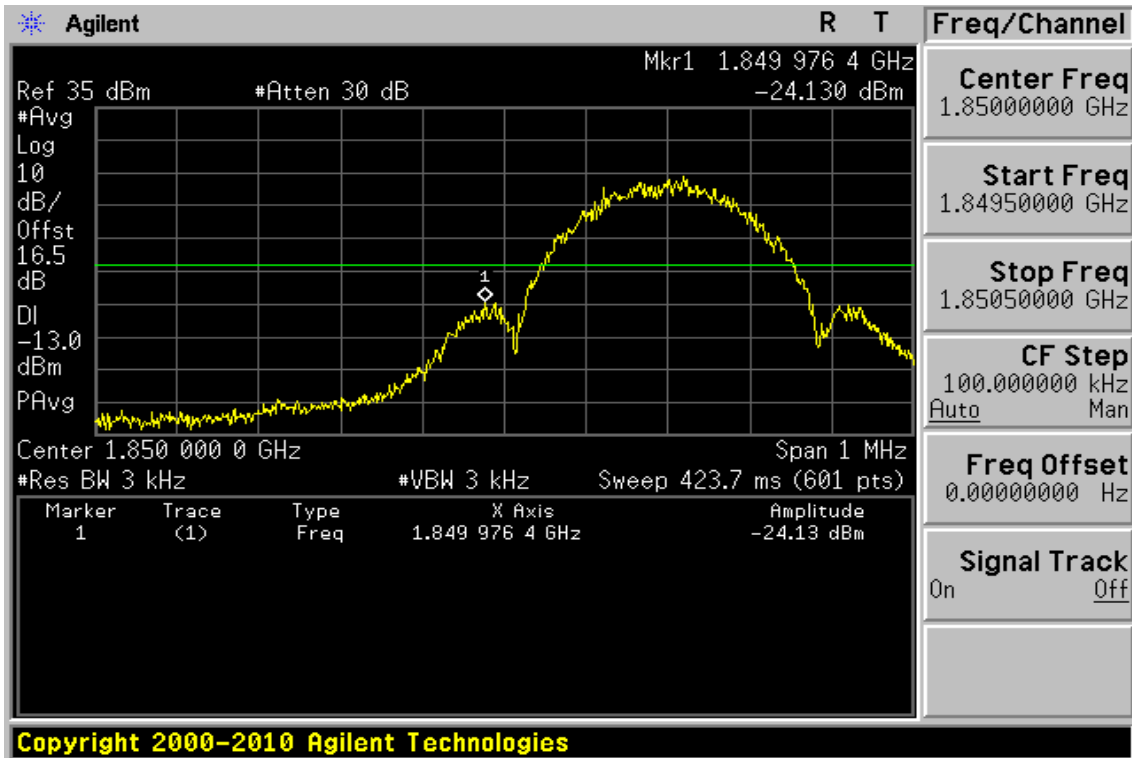
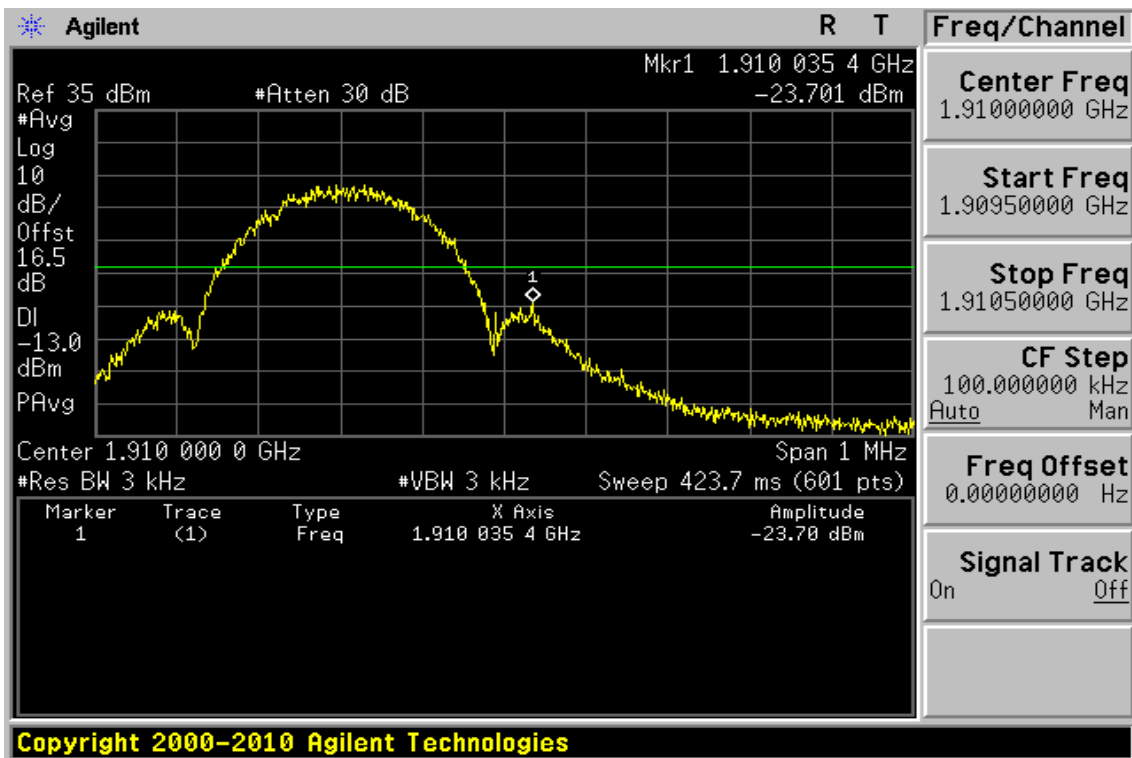

Figure 9-20: Band edge emission at antenna terminals – EDGE 1900 Channel Highest



Unless otherwise stated the results shown in this test report refer only to the sample(s) tested and such sample(s) are retained for 90 days only.

除非另有說明，此報告結果僅對測試之樣品負責，同時此樣品僅保留90天。本報告未經本公司書面許可，不可部份複製。

This document is issued by the Company subject to its General Conditions of Service printed overleaf, available on request or accessible at www.sgs.com/terms_and_conditions.htm and for electronic format documents, subject to Terms and Conditions for Electronic Documents at www.sgs.com/terms_e-document.htm. Attention is drawn to the limitation of liability, indemnification and jurisdiction issues defined therein. Any holder of this document is advised that information contained hereon reflects the Company's findings at the time of its intervention only and within the limits of Client's instructions, if any. The Company's sole responsibility is to its Client and this document does not exonerate parties to a transaction from exercising all their rights and obligations under the transaction documents. This document cannot be reproduced except in full, without prior written approval of the Company. Any unauthorized alteration, forgery or falsification of the content or appearance of this document is unlawful and offenders may be prosecuted to the fullest extent of the law.

SGS Taiwan Ltd. No.134, Wu Kung Road, Wuku Industrial Zone, Taipei County, Taiwan / 台北縣五股工業區五工路 134 號

台灣檢驗科技股份有限公司

t (886-2) 2299-3279

f (886-2) 2298-0488

www.tw.sgs.com

Member of SGS Group

Figure 9-21: Out of Band emission at antenna terminals – GPRS 850 Channel Lowest

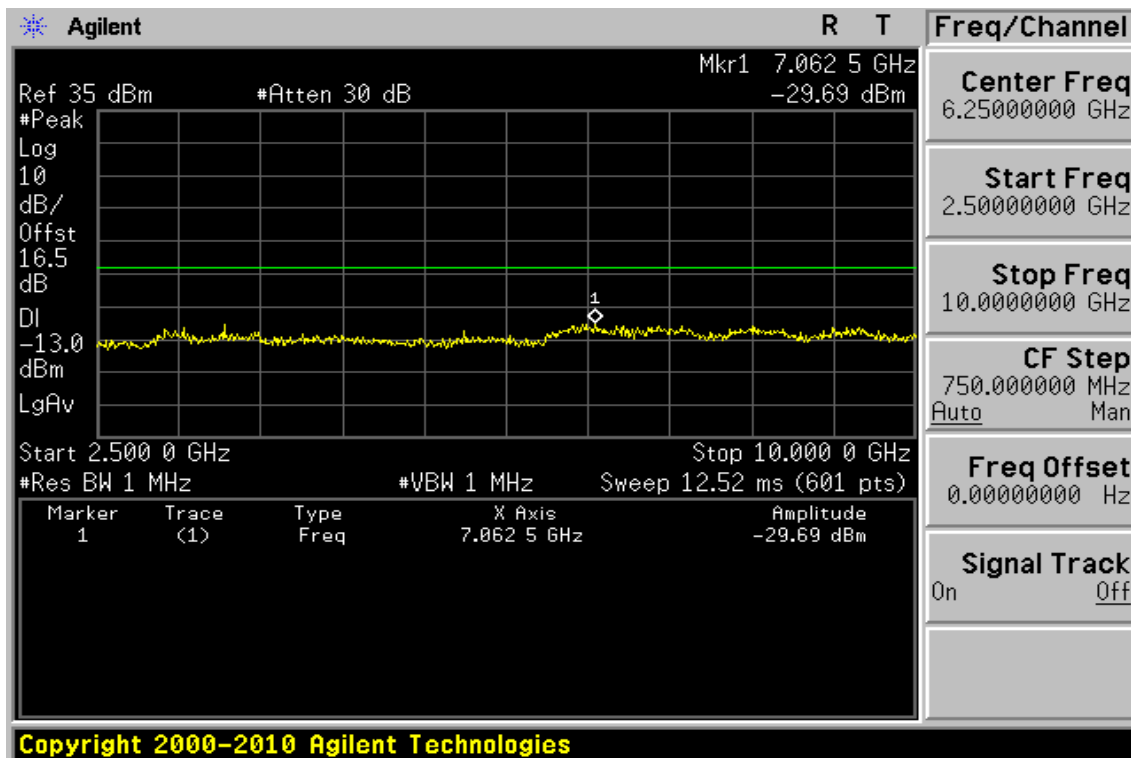
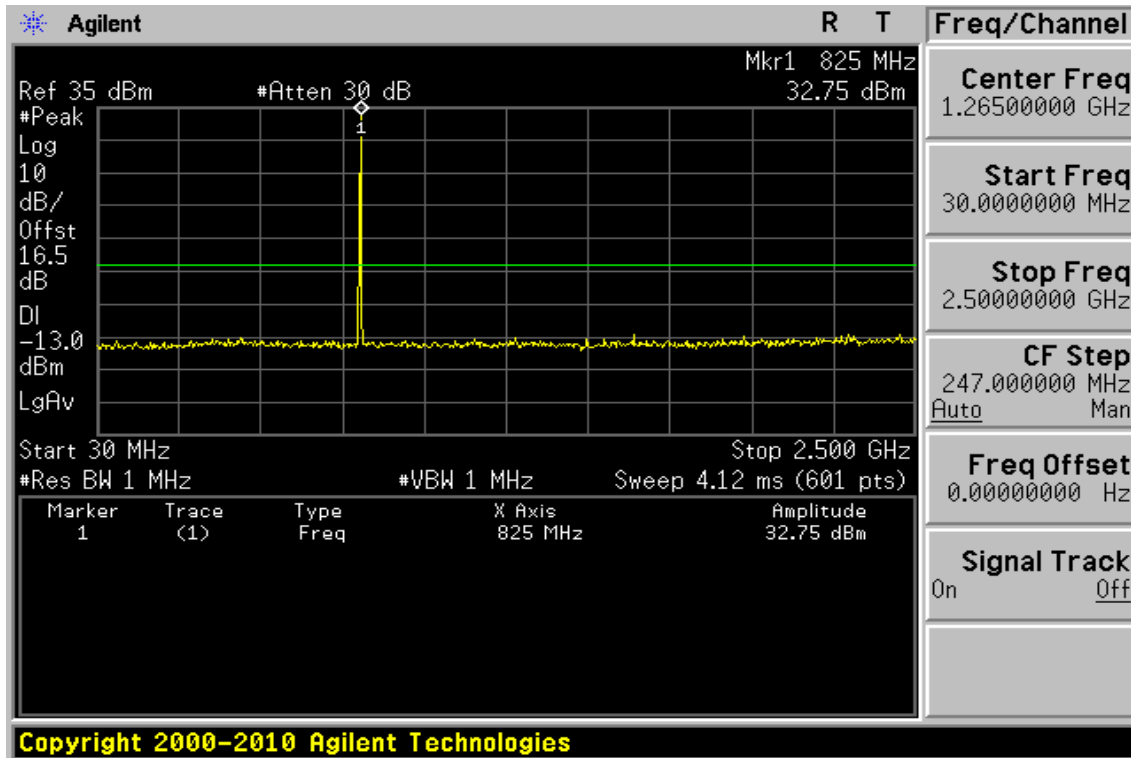

Unless otherwise stated the results shown in this test report refer only to the sample(s) tested and such sample(s) are retained for 90 days only.

除非另有說明，此報告結果僅對測試之樣品負責，同時此樣品僅保留90天。本報告未經本公司書面許可，不可部份複製。

This document is issued by the Company subject to its General Conditions of Service printed overleaf, available on request or accessible at www.sgs.com/terms_and_conditions.htm and for electronic format documents, subject to Terms and Conditions for Electronic Documents at www.sgs.com/terms_e-document.htm. Attention is drawn to the limitation of liability, indemnification and jurisdiction issues defined therein. Any holder of this document is advised that information contained hereon reflects the Company's findings at the time of its intervention only and within the limits of Client's instructions, if any. The Company's sole responsibility is to its Client and this document does not exonerate parties to a transaction from exercising all their rights and obligations under the transaction documents. This document cannot be reproduced except in full, without prior written approval of the Company. Any unauthorized alteration, forgery or falsification of the content or appearance of this document is unlawful and offenders may be prosecuted to the fullest extent of the law.

Figure 9-22: Out of Band emission at antenna terminals – GPRS 850 Channel Mid

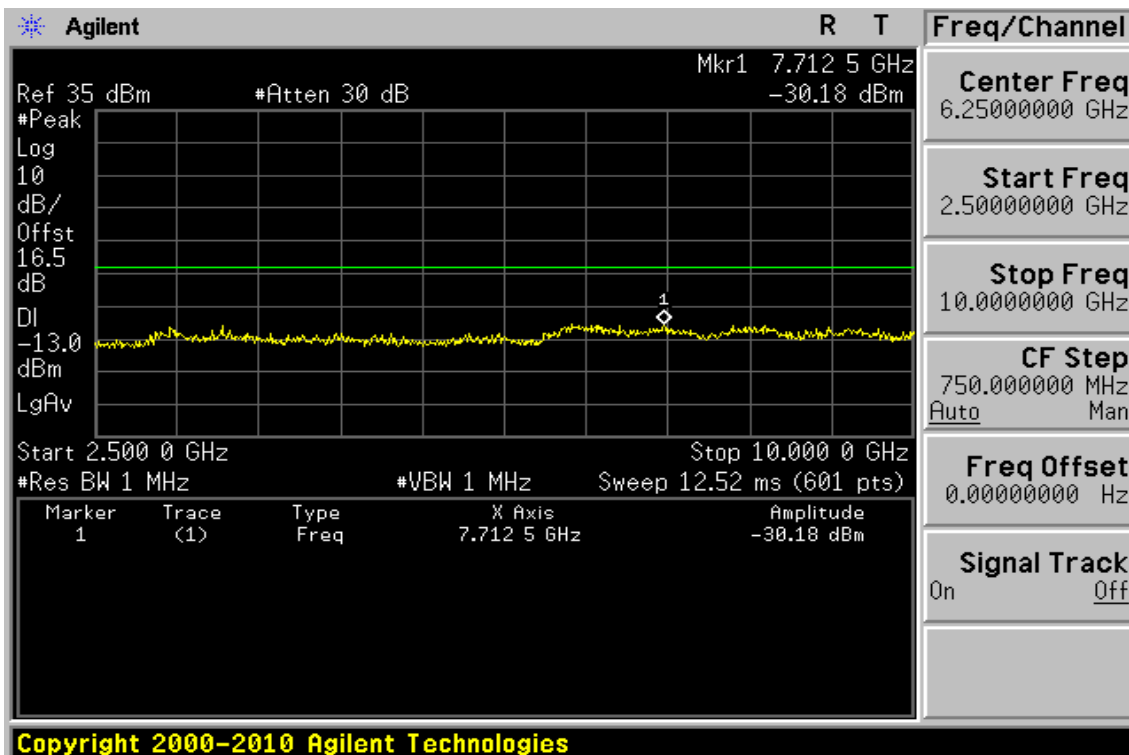
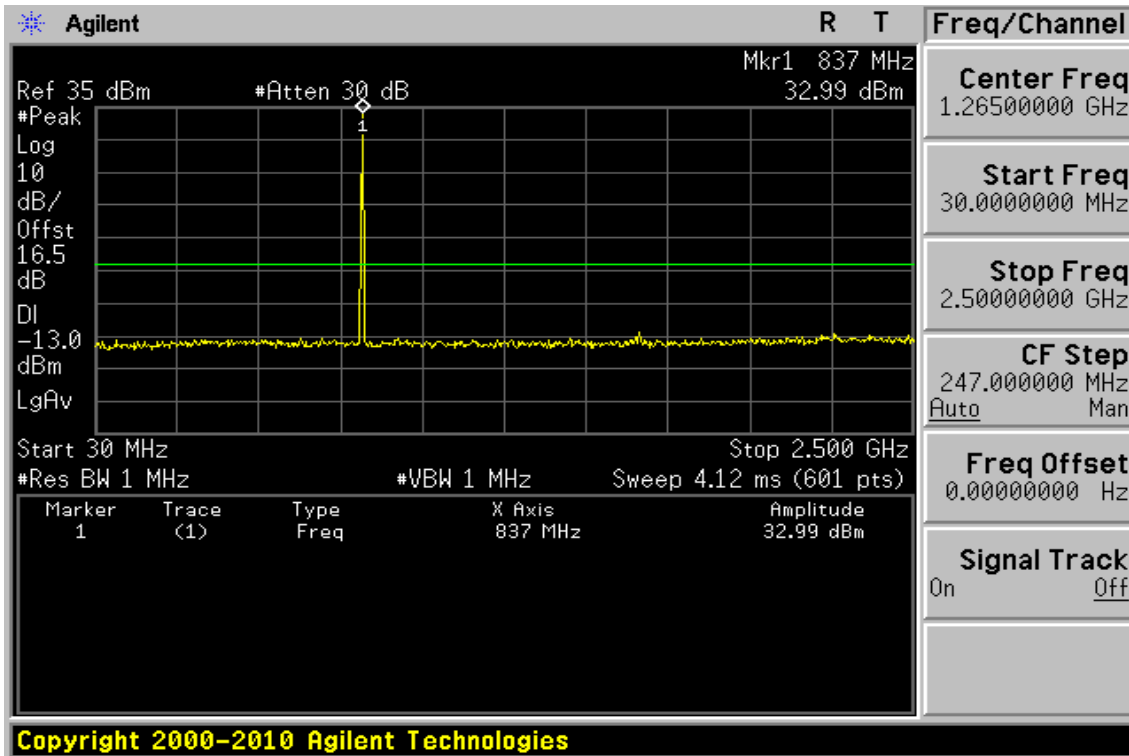

Unless otherwise stated the results shown in this test report refer only to the sample(s) tested and such sample(s) are retained for 90 days only.

除非另有說明，此報告結果僅對測試之樣品負責，同時此樣品僅保留90天。本報告未經本公司書面許可，不可部份複製。

This document is issued by the Company subject to its General Conditions of Service printed overleaf, available on request or accessible at www.sgs.com/terms_and_conditions.htm and for electronic format documents, subject to Terms and Conditions for Electronic Documents at www.sgs.com/terms_e-document.htm. Attention is drawn to the limitation of liability, indemnification and jurisdiction issues defined therein. Any holder of this document is advised that information contained hereon reflects the Company's findings at the time of its intervention only and within the limits of Client's instructions, if any. The Company's sole responsibility is to its Client and this document does not exonerate parties to a transaction from exercising all their rights and obligations under the transaction documents. This document cannot be reproduced except in full, without prior written approval of the Company. Any unauthorized alteration, forgery or falsification of the content or appearance of this document is unlawful and offenders may be prosecuted to the fullest extent of the law.

SGS Taiwan Ltd. No.134, Wu Kung Road, Wuku Industrial Zone, Taipei County, Taiwan / 台北縣五股工業區五工路 134 號

台灣檢驗科技股份有限公司

t (886-2) 2299-3279

f (886-2) 2298-0488

www.tw.sgs.com

Member of SGS Group

Figure 9-23: Out of Band emission at antenna terminals – GPRS 850 Channel Highest

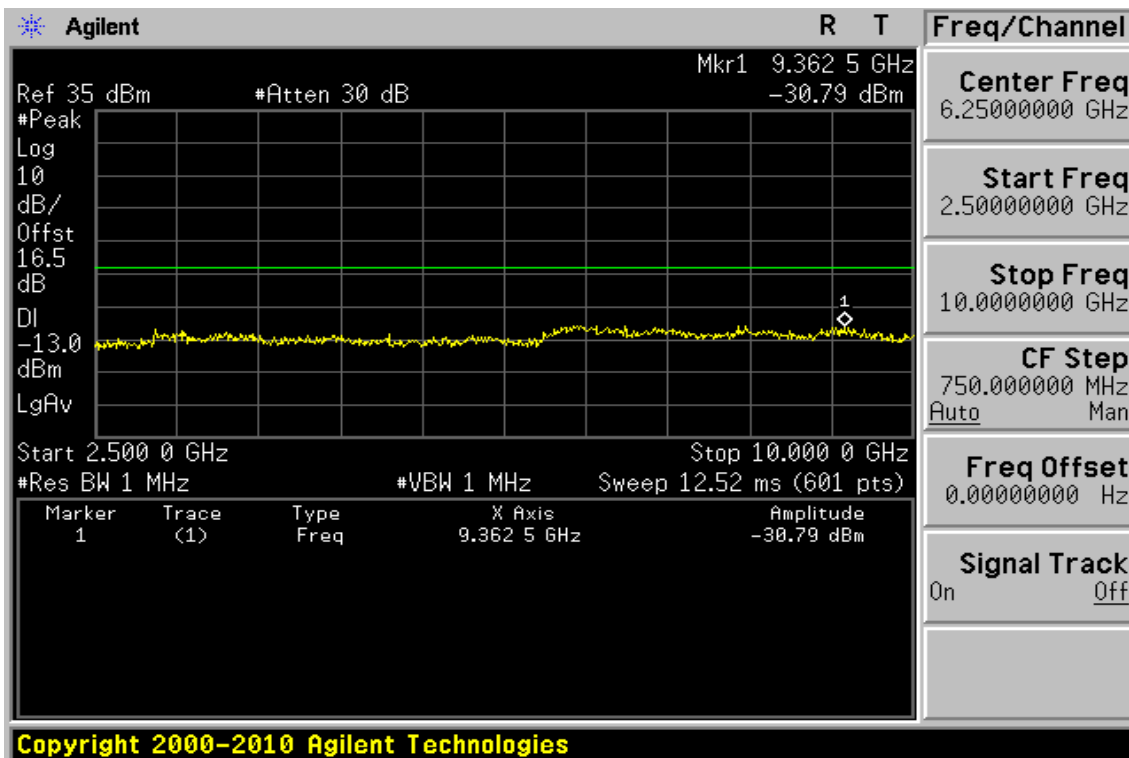
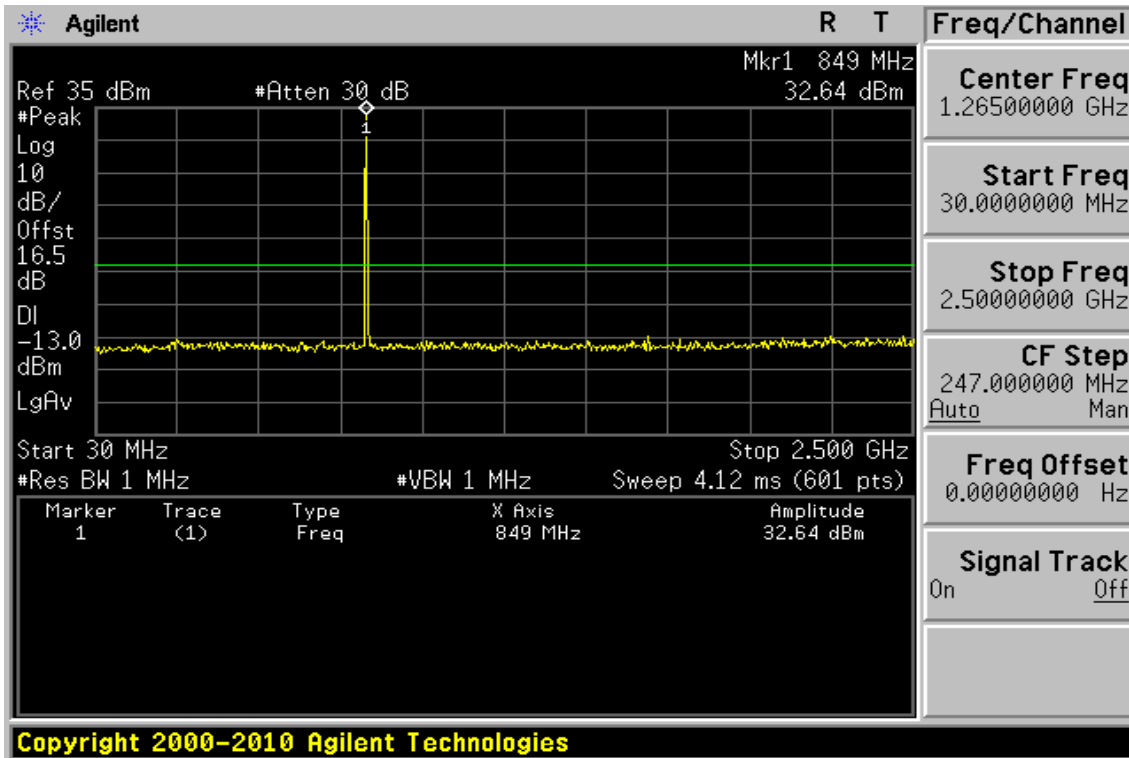

Unless otherwise stated the results shown in this test report refer only to the sample(s) tested and such sample(s) are retained for 90 days only.

除非另有說明，此報告結果僅對測試之樣品負責，同時此樣品僅保留90天。本報告未經本公司書面許可，不可部份複製。

This document is issued by the Company subject to its General Conditions of Service printed overleaf, available on request or accessible at www.sgs.com/terms_and_conditions.htm and for electronic format documents, subject to Terms and Conditions for Electronic Documents at www.sgs.com/terms_e-document.htm. Attention is drawn to the limitation of liability, indemnification and jurisdiction issues defined therein. Any holder of this document is advised that information contained hereon reflects the Company's findings at the time of its intervention only and within the limits of Client's instructions, if any. The Company's sole responsibility is to its Client and this document does not exonerate parties to a transaction from exercising all their rights and obligations under the transaction documents. This document cannot be reproduced except in full, without prior written approval of the Company. Any unauthorized alteration, forgery or falsification of the content or appearance of this document is unlawful and offenders may be prosecuted to the fullest extent of the law.

Figure 9-24: Band edge emission at antenna terminals – GPRS 850 Channel Lowest

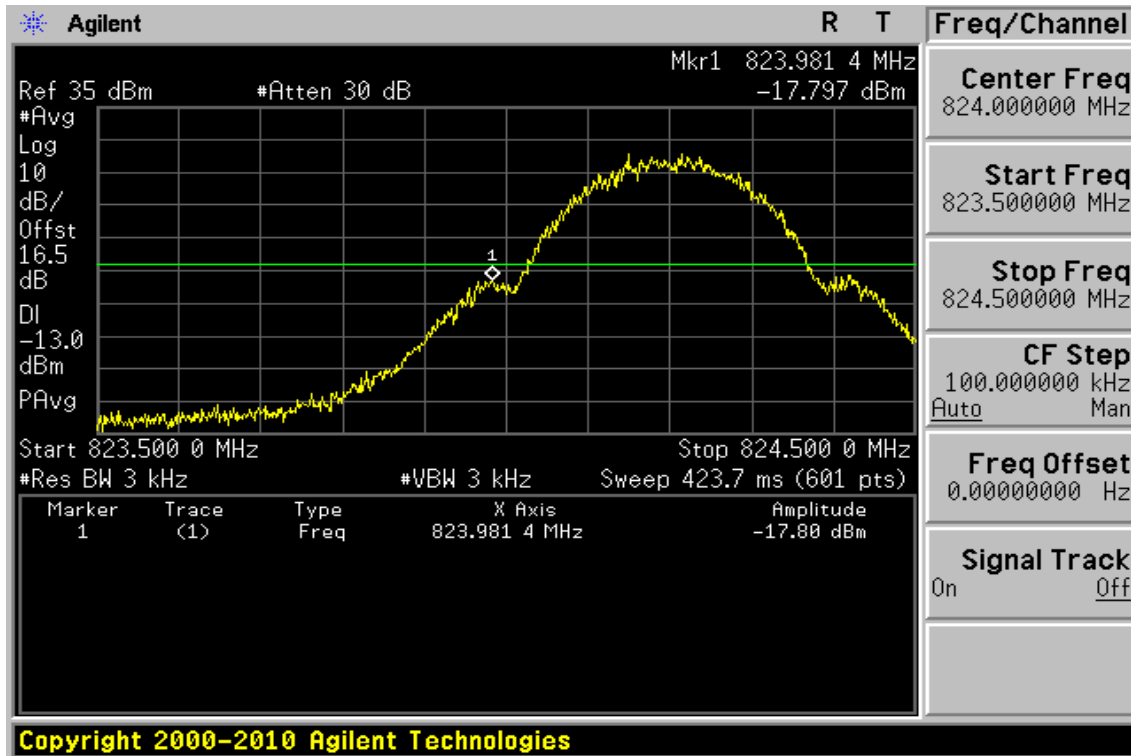
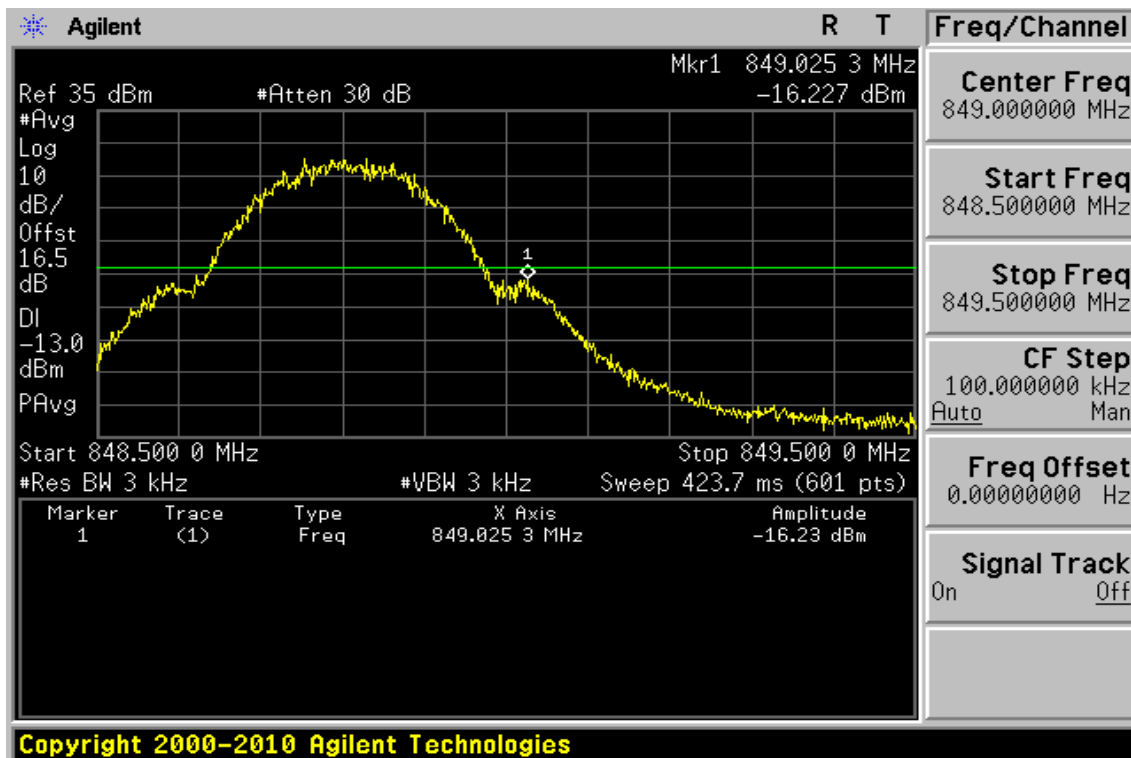

Figure 9-25: Band edge emission at antenna terminals – GPRS 850 Channel Highest



Unless otherwise stated the results shown in this test report refer only to the sample(s) tested and such sample(s) are retained for 90 days only.

除非另有說明，此報告結果僅對測試之樣品負責，同時此樣品僅保留90天。本報告未經本公司書面許可，不可部份複製。

This document is issued by the Company subject to its General Conditions of Service printed overleaf, available on request or accessible at www.sgs.com/terms_and_conditions.htm and for electronic format documents, subject to Terms and Conditions for Electronic Documents at www.sgs.com/terms_e-document.htm. Attention is drawn to the limitation of liability, indemnification and jurisdiction issues defined therein. Any holder of this document is advised that information contained hereon reflects the Company's findings at the time of its intervention only and within the limits of Client's instructions, if any. The Company's sole responsibility is to its Client and this document does not exonerate parties to a transaction from exercising all their rights and obligations under the transaction documents. This document cannot be reproduced except in full, without prior written approval of the Company. Any unauthorized alteration, forgery or falsification of the content or appearance of this document is unlawful and offenders may be prosecuted to the fullest extent of the law.

SGS Taiwan Ltd. No.134, Wu Kung Road, Wuku Industrial Zone, Taipei County, Taiwan / 台北縣五股工業區五工路 134 號

台灣檢驗科技股份有限公司

t (886-2) 2299-3279

f (886-2) 2298-0488

www.tw.sgs.com

Member of SGS Group

Figure 9-26: Out of Band emission at antenna terminals – GPRS 1900 Channel Lowest

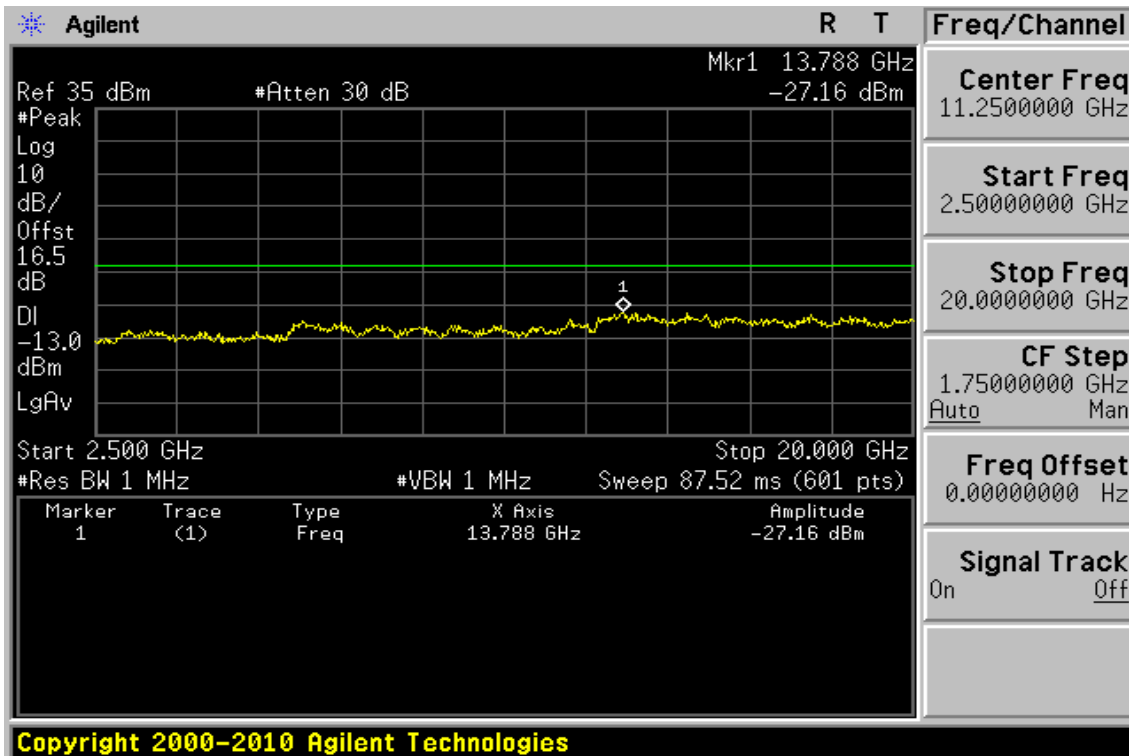
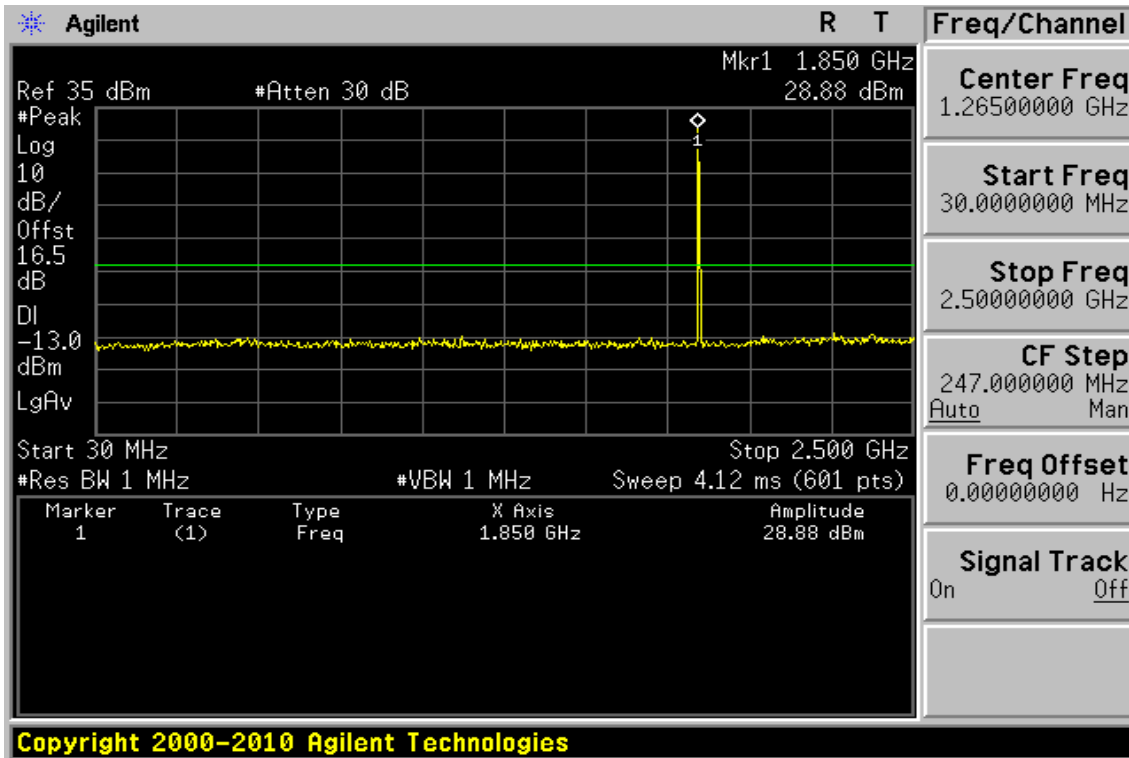

Unless otherwise stated the results shown in this test report refer only to the sample(s) tested and such sample(s) are retained for 90 days only.

除非另有說明，此報告結果僅對測試之樣品負責，同時此樣品僅保留90天。本報告未經本公司書面許可，不可部份複製。

This document is issued by the Company subject to its General Conditions of Service printed overleaf, available on request or accessible at www.sgs.com/terms_and_conditions.htm and for electronic format documents, subject to Terms and Conditions for Electronic Documents at www.sgs.com/terms_e-document.htm. Attention is drawn to the limitation of liability, indemnification and jurisdiction issues defined therein. Any holder of this document is advised that information contained hereon reflects the Company's findings at the time of its intervention only and within the limits of Client's instructions, if any. The Company's sole responsibility is to its Client and this document does not exonerate parties to a transaction from exercising all their rights and obligations under the transaction documents. This document cannot be reproduced except in full, without prior written approval of the Company. Any unauthorized alteration, forgery or falsification of the content or appearance of this document is unlawful and offenders may be prosecuted to the fullest extent of the law.

Figure 9-27: Out of Band emission at antenna terminals – GPRS 1900 Channel Mid

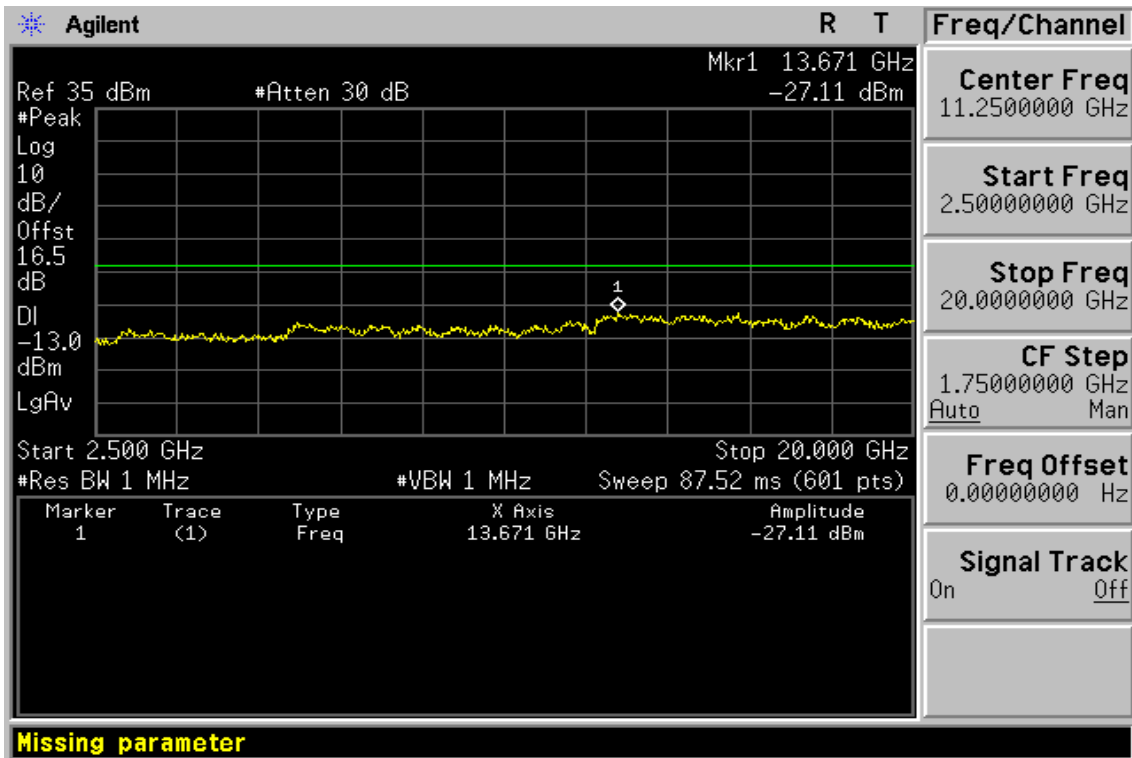
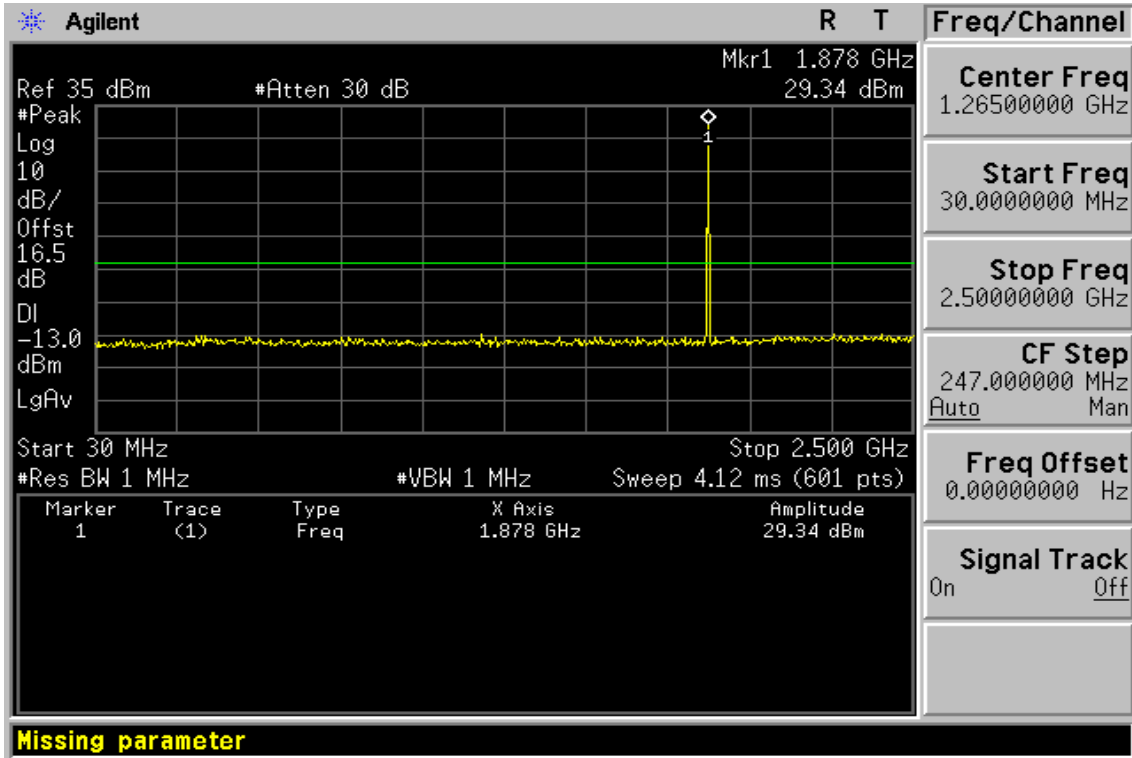

Unless otherwise stated the results shown in this test report refer only to the sample(s) tested and such sample(s) are retained for 90 days only.

除非另有說明，此報告結果僅對測試之樣品負責，同時此樣品僅保留90天。本報告未經本公司書面許可，不可部份複製。

This document is issued by the Company subject to its General Conditions of Service printed overleaf, available on request or accessible at www.sgs.com/terms_and_conditions.htm and for electronic format documents, subject to Terms and Conditions for Electronic Documents at www.sgs.com/terms_e-document.htm. Attention is drawn to the limitation of liability, indemnification and jurisdiction issues defined therein. Any holder of this document is advised that information contained hereon reflects the Company's findings at the time of its intervention only and within the limits of Client's instructions, if any. The Company's sole responsibility is to its Client and this document does not exonerate parties to a transaction from exercising all their rights and obligations under the transaction documents. This document cannot be reproduced except in full, without prior written approval of the Company. Any unauthorized alteration, forgery or falsification of the content or appearance of this document is unlawful and offenders may be prosecuted to the fullest extent of the law.

Figure 9-28: Out of Band emission at antenna terminals – GPRS 1900 Channel Highest

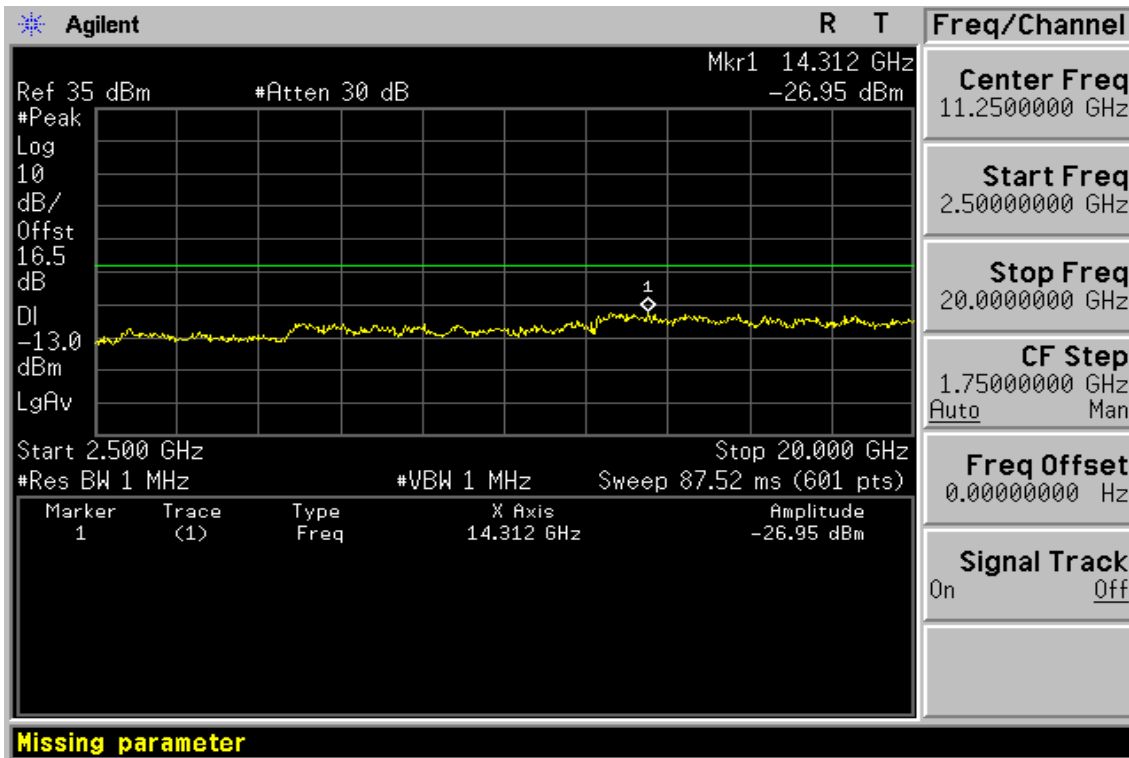
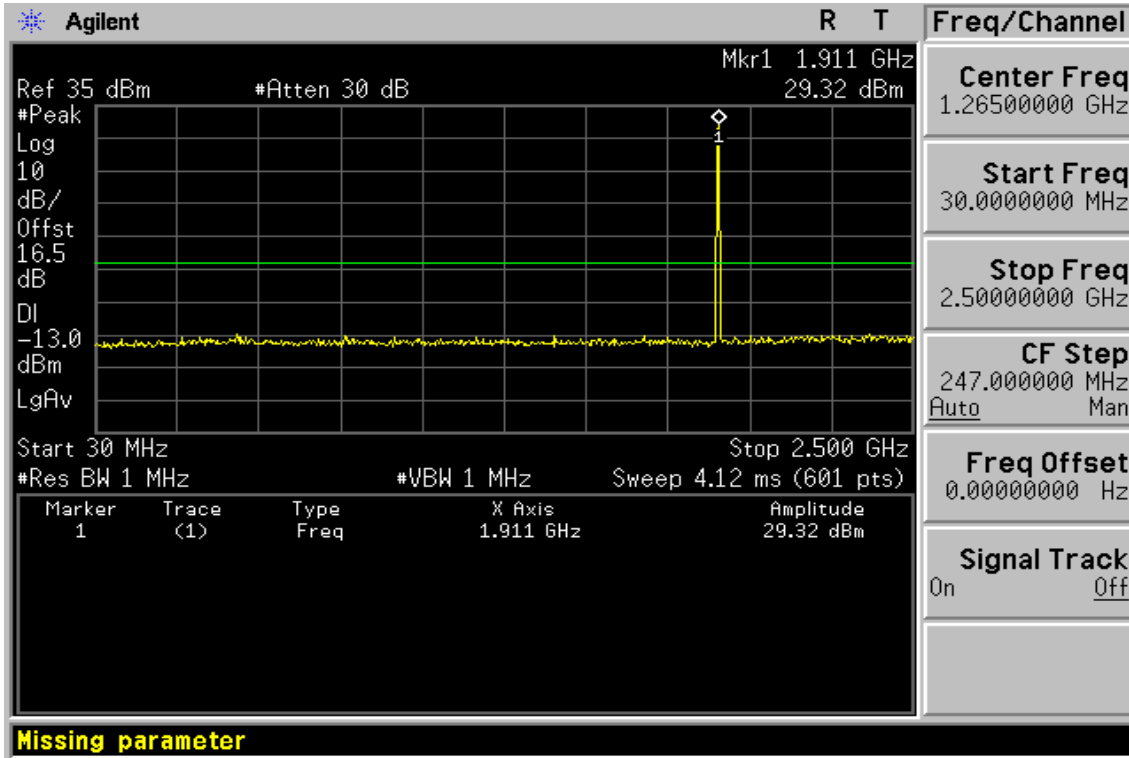

Unless otherwise stated the results shown in this test report refer only to the sample(s) tested and such sample(s) are retained for 90 days only.

除非另有說明，此報告結果僅對測試之樣品負責，同時此樣品僅保留90天。本報告未經本公司書面許可，不可部份複製。

This document is issued by the Company subject to its General Conditions of Service printed overleaf, available on request or accessible at www.sgs.com/terms_and_conditions.htm and for electronic format documents, subject to Terms and Conditions for Electronic Documents at www.sgs.com/terms_e-document.htm. Attention is drawn to the limitation of liability, indemnification and jurisdiction issues defined therein. Any holder of this document is advised that information contained hereon reflects the Company's findings at the time of its intervention only and within the limits of Client's instructions, if any. The Company's sole responsibility is to its Client and this document does not exonerate parties to a transaction from exercising all their rights and obligations under the transaction documents. This document cannot be reproduced except in full, without prior written approval of the Company. Any unauthorized alteration, forgery or falsification of the content or appearance of this document is unlawful and offenders may be prosecuted to the fullest extent of the law.

Figure 9-29: Bad edge emission at antenna terminals – GPRS 1900 Channel Lowest

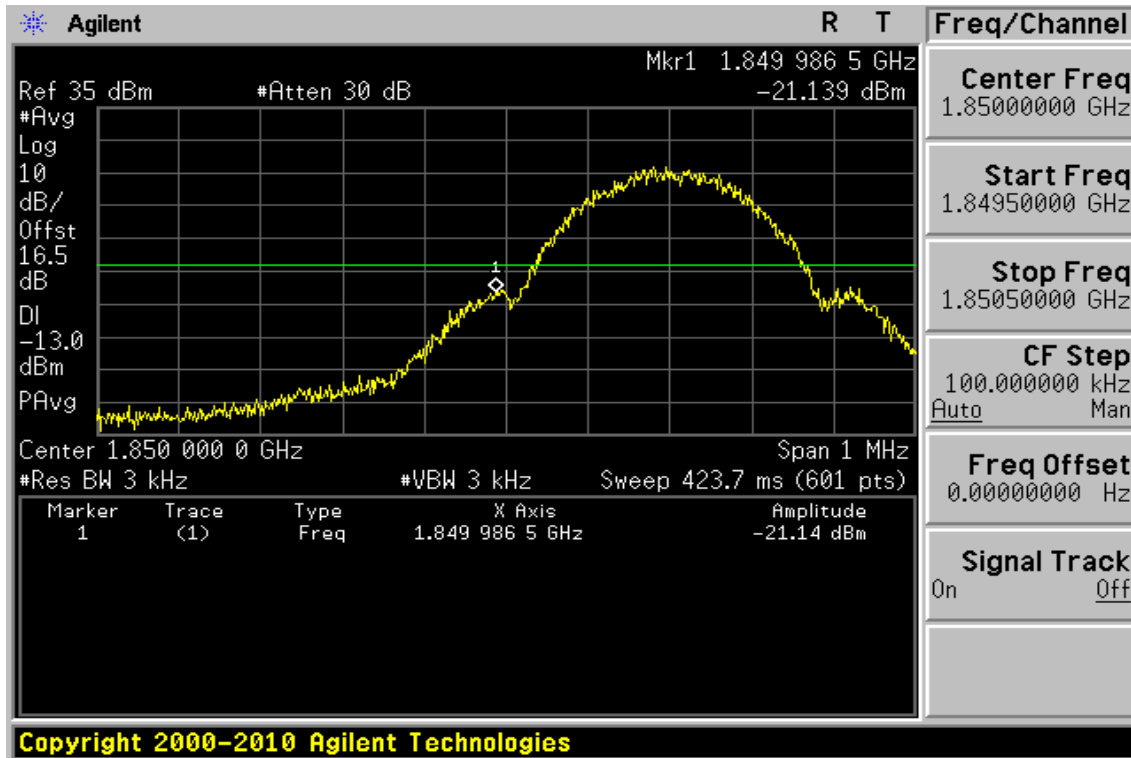
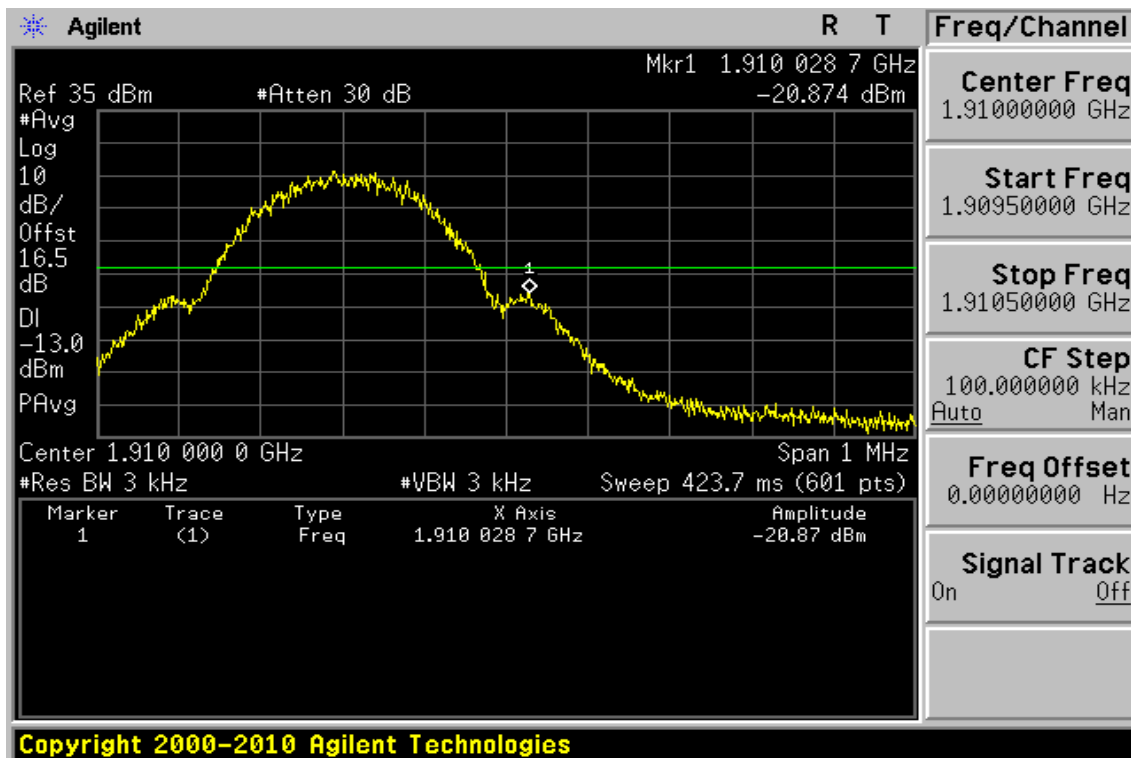

Figure 9-30: Band edge emission at antenna terminals – GPRS 1900 Channel Highest



Unless otherwise stated the results shown in this test report refer only to the sample(s) tested and such sample(s) are retained for 90 days only.

除非另有說明，此報告結果僅對測試之樣品負責，同時此樣品僅保留90天。本報告未經本公司書面許可，不可部份複製。

This document is issued by the Company subject to its General Conditions of Service printed overleaf, available on request or accessible at www.sgs.com/terms_and_conditions.htm and for electronic format documents, subject to Terms and Conditions for Electronic Documents at www.sgs.com/terms_e-document.htm. Attention is drawn to the limitation of liability, indemnification and jurisdiction issues defined therein. Any holder of this document is advised that information contained hereon reflects the Company's findings at the time of its intervention only and within the limits of Client's instructions, if any. The Company's sole responsibility is to its Client and this document does not exonerate parties to a transaction from exercising all their rights and obligations under the transaction documents. This document cannot be reproduced except in full, without prior written approval of the Company. Any unauthorized alteration, forgery or falsification of the content or appearance of this document is unlawful and offenders may be prosecuted to the fullest extent of the law.

SGS Taiwan Ltd. No.134, Wu Kung Road, Wuku Industrial Zone, Taipei County, Taiwan / 台北縣五股工業區五工路 134 號

台灣檢驗科技股份有限公司

t (886-2) 2299-3279

f (886-2) 2298-0488

www.tw.sgs.com

Member of SGS Group

Figure 9-31: Out of Band emission at antenna terminals – WCDMA IV Channel Lowest

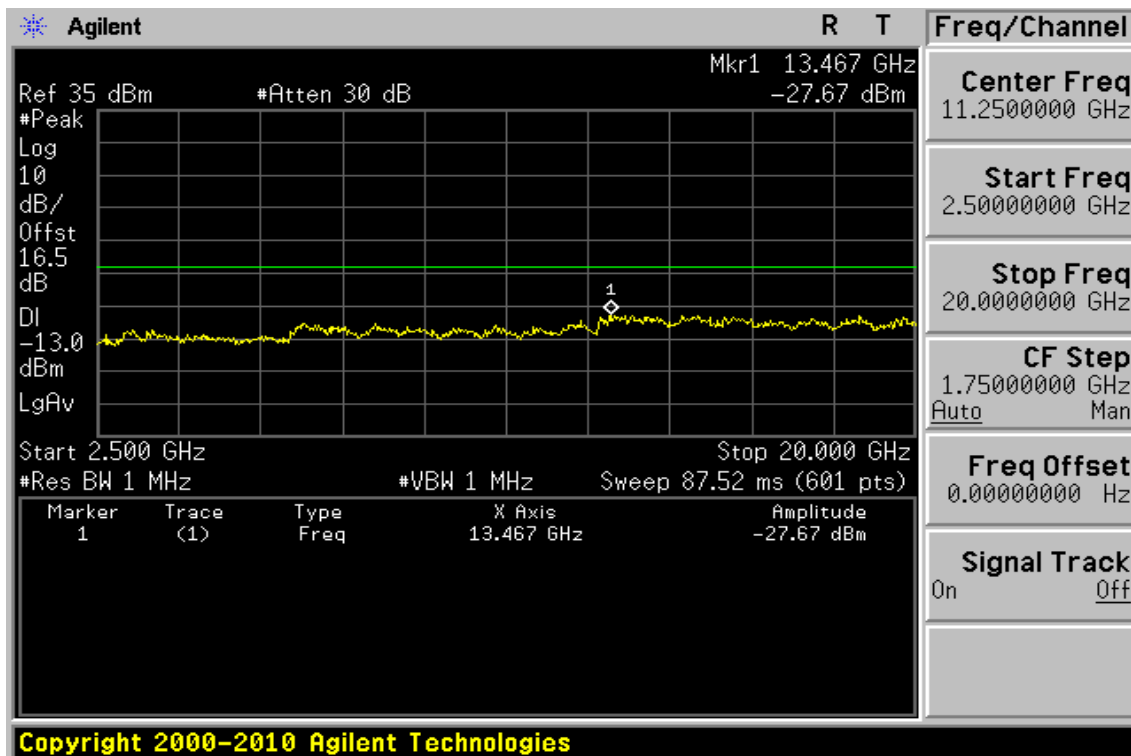
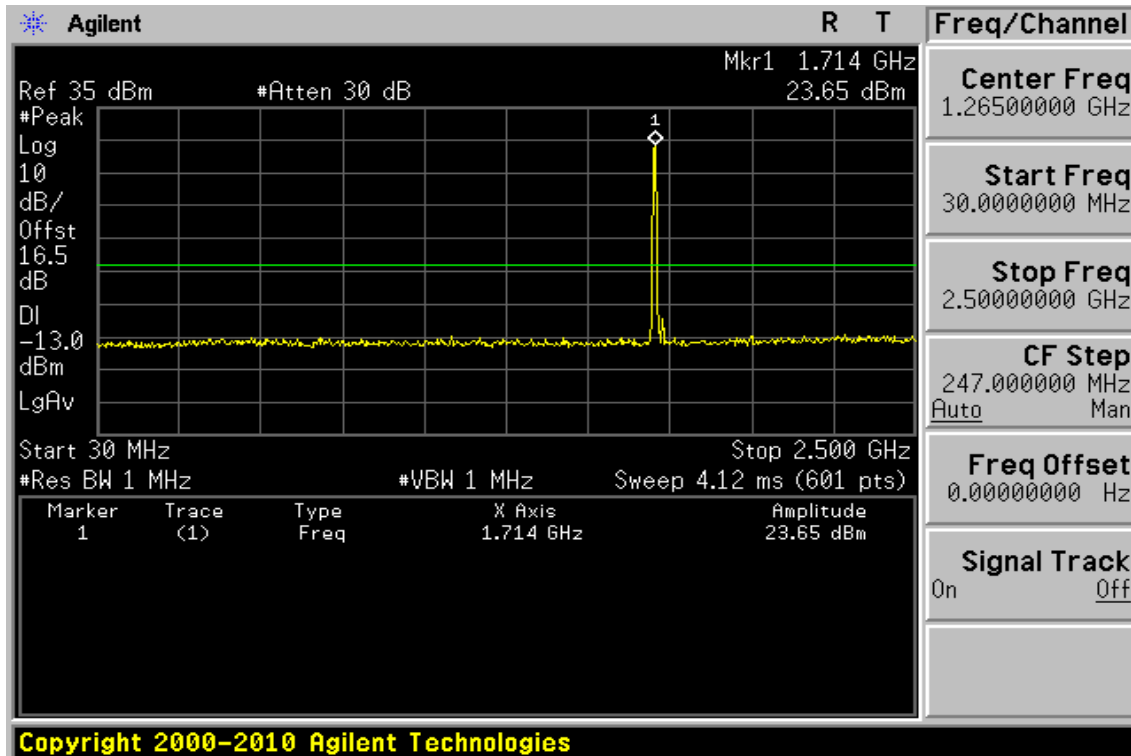

Unless otherwise stated the results shown in this test report refer only to the sample(s) tested and such sample(s) are retained for 90 days only.

除非另有說明，此報告結果僅對測試之樣品負責，同時此樣品僅保留90天。本報告未經本公司書面許可，不可部份複製。

This document is issued by the Company subject to its General Conditions of Service printed overleaf, available on request or accessible at www.sgs.com/terms_and_conditions.htm and for electronic format documents, subject to Terms and Conditions for Electronic Documents at www.sgs.com/terms_e-document.htm. Attention is drawn to the limitation of liability, indemnification and jurisdiction issues defined therein. Any holder of this document is advised that information contained hereon reflects the Company's findings at the time of its intervention only and within the limits of Client's instructions, if any. The Company's sole responsibility is to its Client and this document does not exonerate parties to a transaction from exercising all their rights and obligations under the transaction documents. This document cannot be reproduced except in full, without prior written approval of the Company. Any unauthorized alteration, forgery or falsification of the content or appearance of this document is unlawful and offenders may be prosecuted to the fullest extent of the law.

Figure 9-32: Out of Band emission at antenna terminals – WCDMA IV Channel Mid

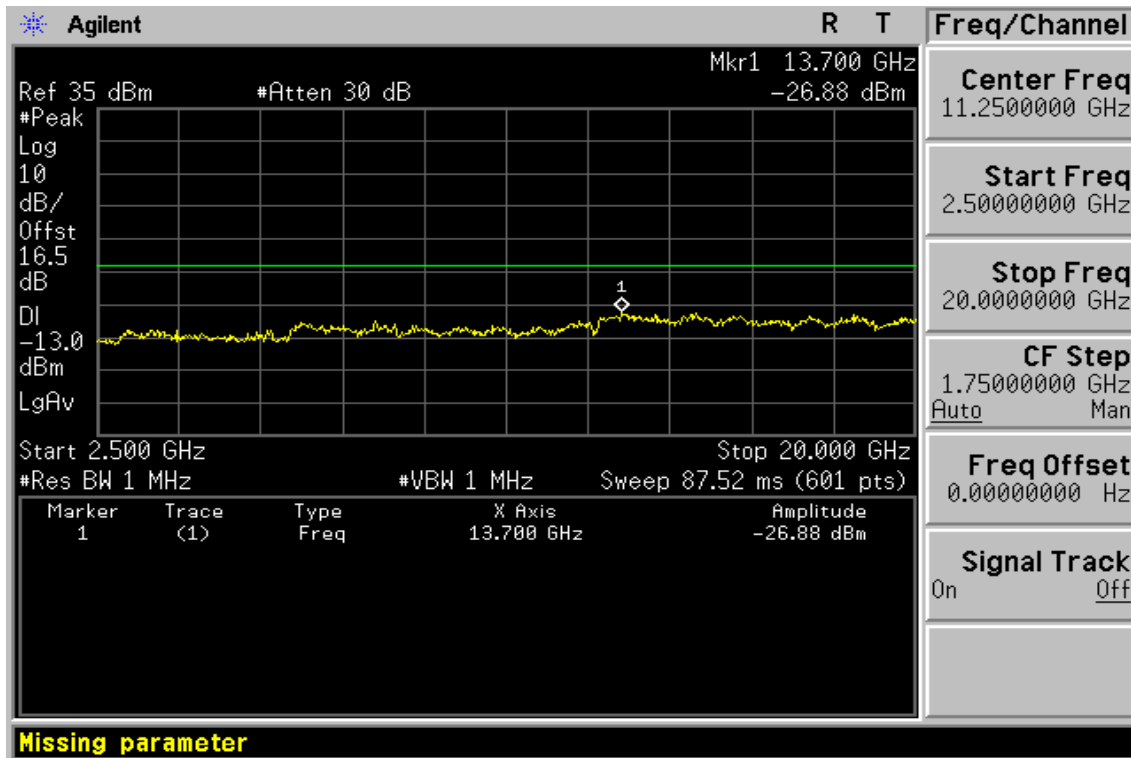
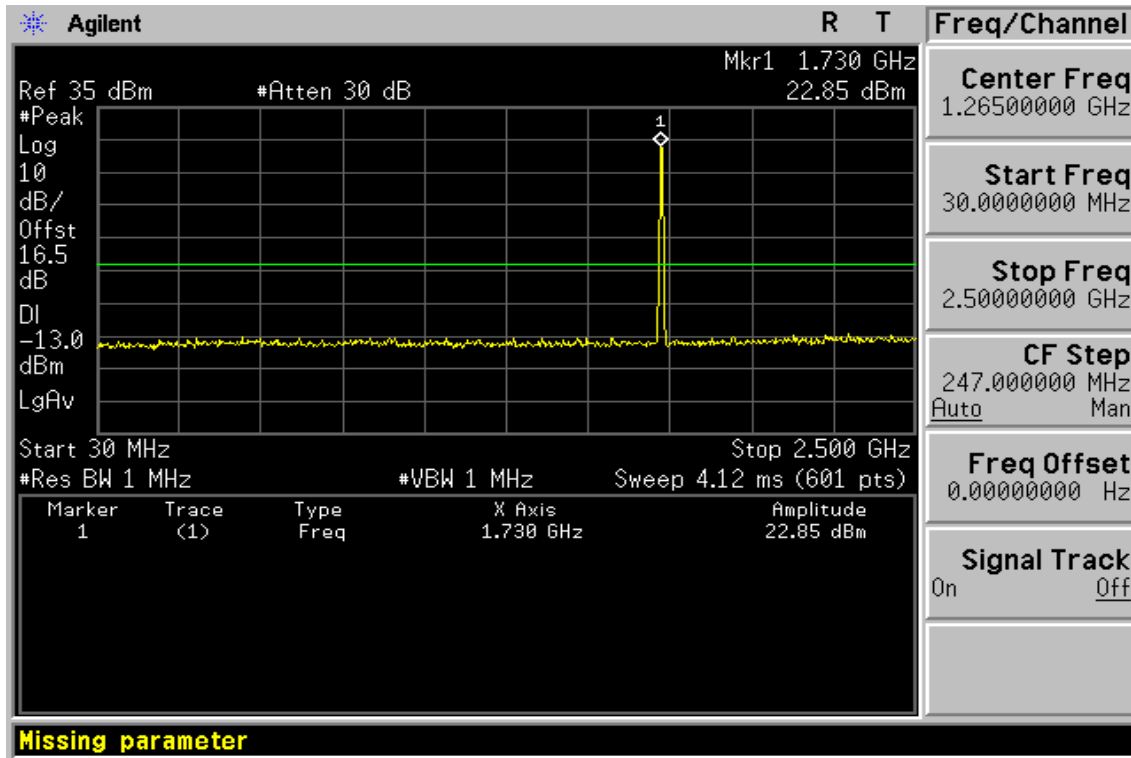

Unless otherwise stated the results shown in this test report refer only to the sample(s) tested and such sample(s) are retained for 90 days only.

除非另有說明，此報告結果僅對測試之樣品負責，同時此樣品僅保留90天。本報告未經本公司書面許可，不可部份複製。

This document is issued by the Company subject to its General Conditions of Service printed overleaf, available on request or accessible at www.sgs.com/terms_and_conditions.htm and for electronic format documents, subject to Terms and Conditions for Electronic Documents at www.sgs.com/terms_e-document.htm. Attention is drawn to the limitation of liability, indemnification and jurisdiction issues defined therein. Any holder of this document is advised that information contained hereon reflects the Company's findings at the time of its intervention only and within the limits of Client's instructions, if any. The Company's sole responsibility is to its Client and this document does not exonerate parties to a transaction from exercising all their rights and obligations under the transaction documents. This document cannot be reproduced except in full, without prior written approval of the Company. Any unauthorized alteration, forgery or falsification of the content or appearance of this document is unlawful and offenders may be prosecuted to the fullest extent of the law.

SGS Taiwan Ltd. No.134, Wu Kung Road, Wuku Industrial Zone, Taipei County, Taiwan / 台北縣五股工業區五工路 134 號

台灣檢驗科技股份有限公司

t (886-2) 2299-3279

f (886-2) 2298-0488

www.tw.sgs.com

Member of SGS Group

Figure 9-33: Out of Band emission at antenna terminals – WCDMA IV Channel Highest

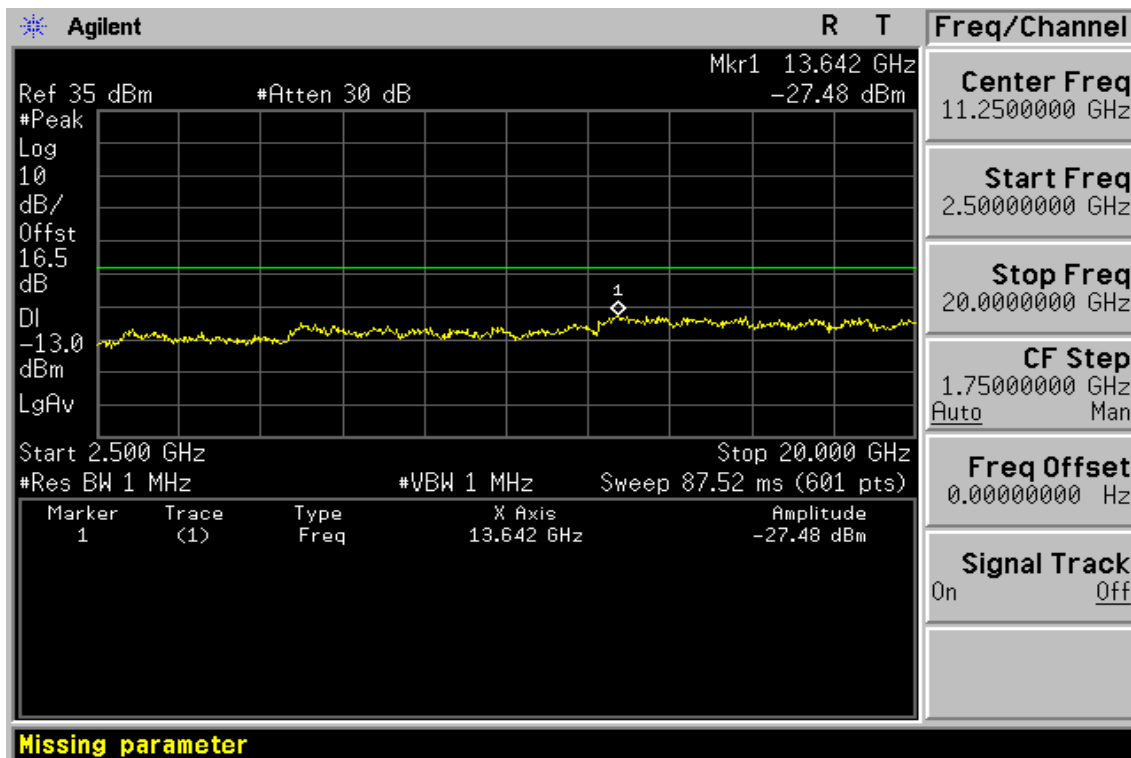
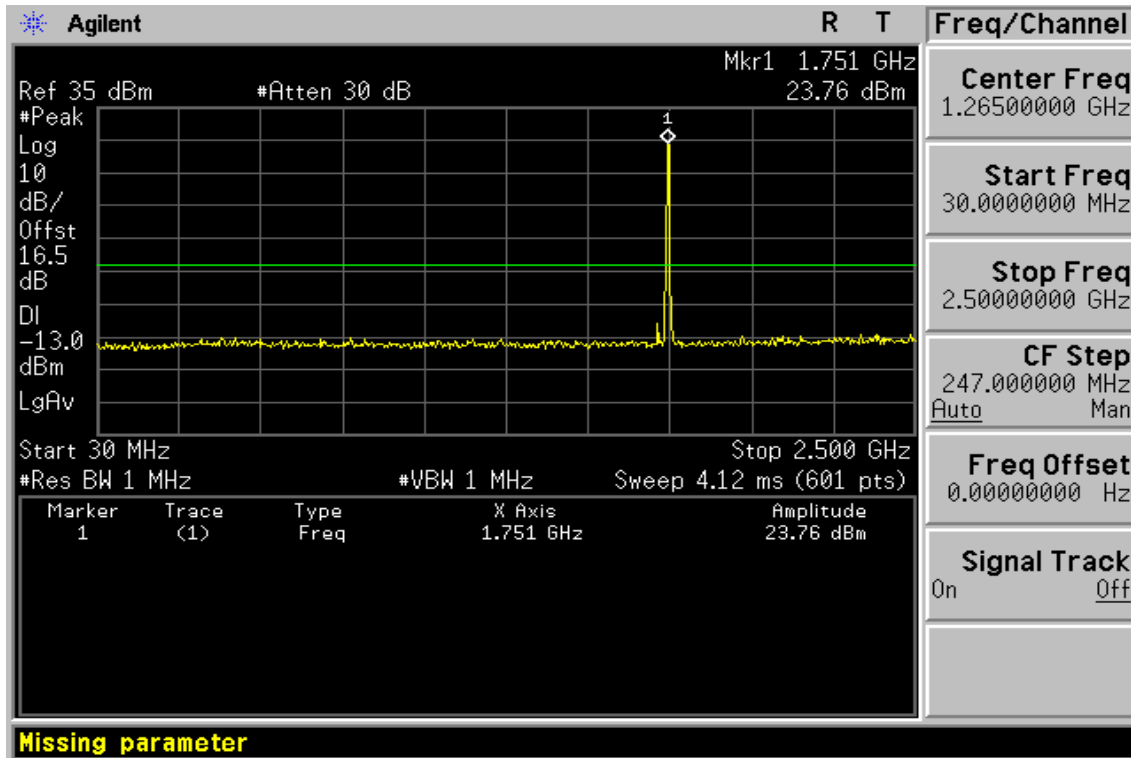

Unless otherwise stated the results shown in this test report refer only to the sample(s) tested and such sample(s) are retained for 90 days only.

除非另有說明，此報告結果僅對測試之樣品負責，同時此樣品僅保留90天。本報告未經本公司書面許可，不可部份複製。

This document is issued by the Company subject to its General Conditions of Service printed overleaf, available on request or accessible at www.sgs.com/terms_and_conditions.htm and for electronic format documents, subject to Terms and Conditions for Electronic Documents at www.sgs.com/terms_e-document.htm. Attention is drawn to the limitation of liability, indemnification and jurisdiction issues defined therein. Any holder of this document is advised that information contained hereon reflects the Company's findings at the time of its intervention only and within the limits of Client's instructions, if any. The Company's sole responsibility is to its Client and this document does not exonerate parties to a transaction from exercising all their rights and obligations under the transaction documents. This document cannot be reproduced except in full, without prior written approval of the Company. Any unauthorized alteration, forgery or falsification of the content or appearance of this document is unlawful and offenders may be prosecuted to the fullest extent of the law.

Figure 9-34: Bad edge emission at antenna terminals – WCDMA IV Channel Lowest

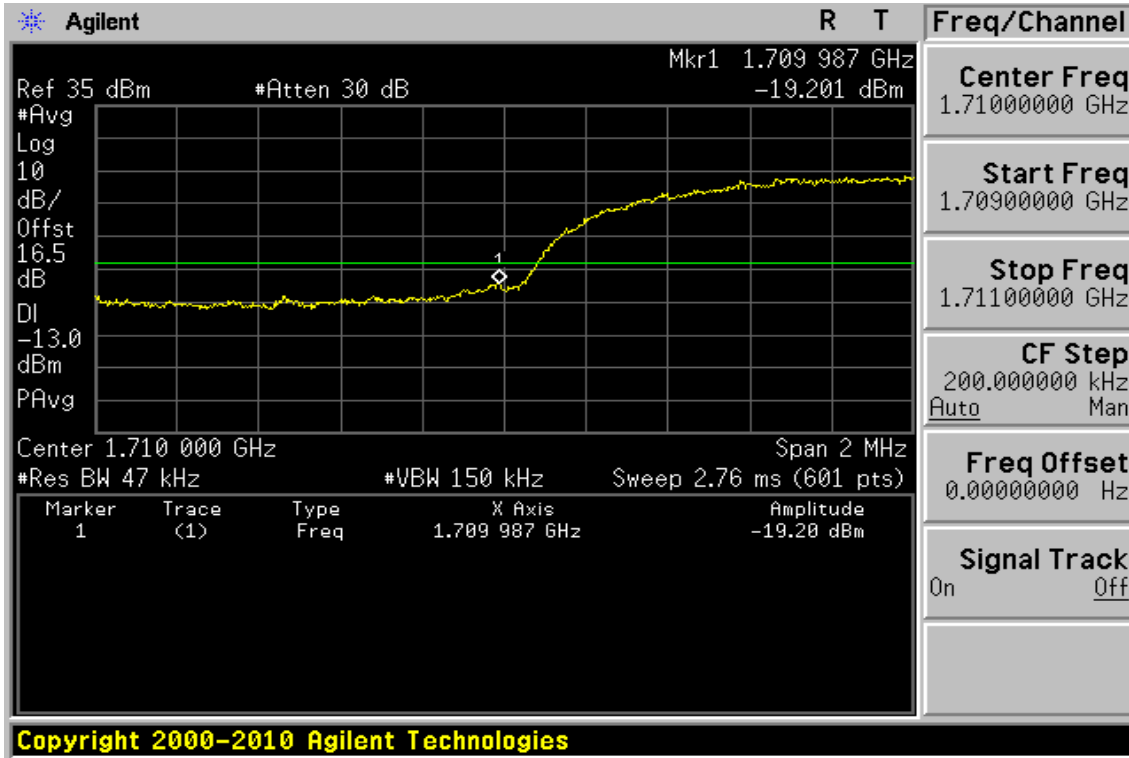
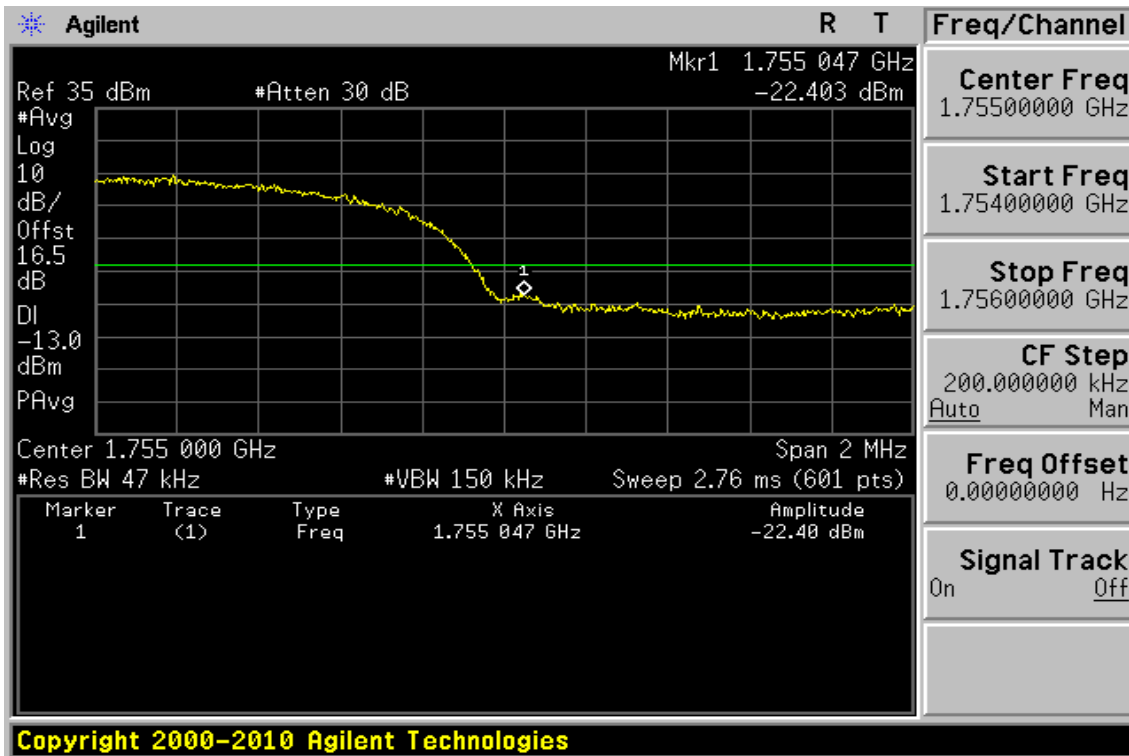

Figure 9-35: Band edge emission at antenna terminals – WCDMA IV Channel Highest



Unless otherwise stated the results shown in this test report refer only to the sample(s) tested and such sample(s) are retained for 90 days only.

除非另有說明，此報告結果僅對測試之樣品負責，同時此樣品僅保留90天。本報告未經本公司書面許可，不可部份複製。

This document is issued by the Company subject to its General Conditions of Service printed overleaf, available on request or accessible at www.sgs.com/terms_and_conditions.htm and for electronic format documents, subject to Terms and Conditions for Electronic Documents at www.sgs.com/terms_e-document.htm. Attention is drawn to the limitation of liability, indemnification and jurisdiction issues defined therein. Any holder of this document is advised that information contained hereon reflects the Company's findings at the time of its intervention only and within the limits of Client's instructions, if any. The Company's sole responsibility is to its Client and this document does not exonerate parties to a transaction from exercising all their rights and obligations under the transaction documents. This document cannot be reproduced except in full, without prior written approval of the Company. Any unauthorized alteration, forgery or falsification of the content or appearance of this document is unlawful and offenders may be prosecuted to the fullest extent of the law.

SGS Taiwan Ltd. No.134, Wu Kung Road, Wuku Industrial Zone, Taipei County, Taiwan / 台北縣五股工業區五工路 134 號

台灣檢驗科技股份有限公司

t (886-2) 2299-3279

f (886-2) 2298-0488

www.tw.sgs.com

Member of SGS Group

Figure 9-36: Out of Band emission at antenna terminals – HSUPA IV Channel Lowest

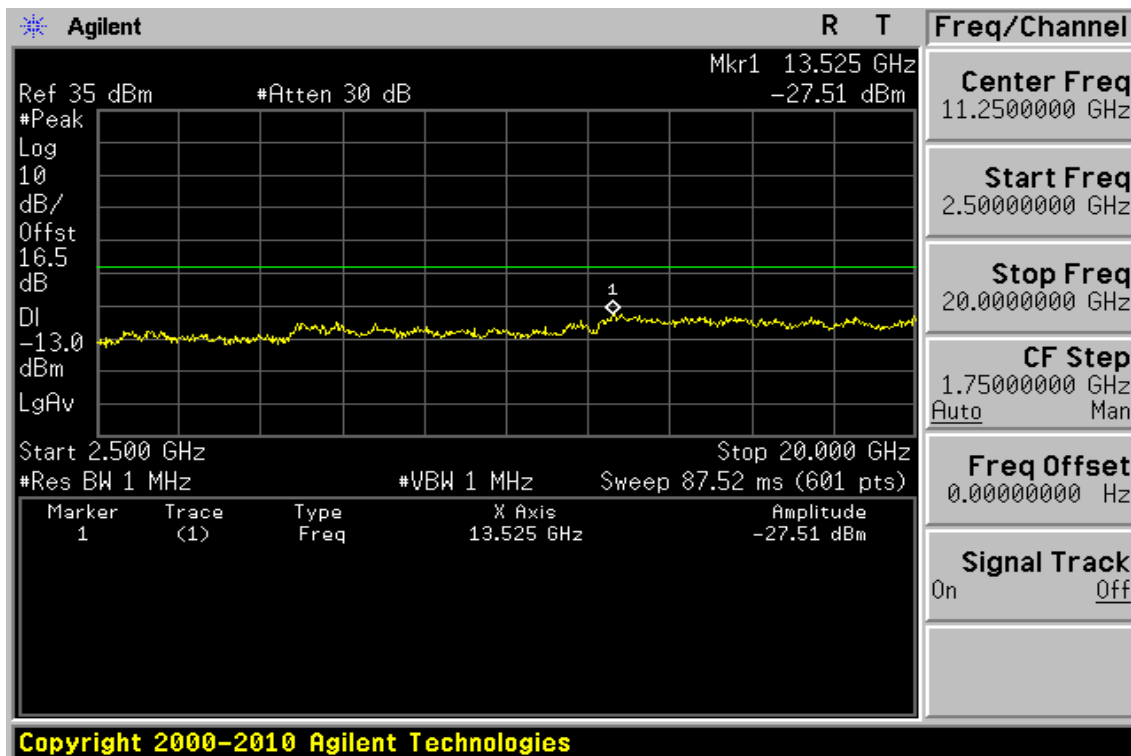
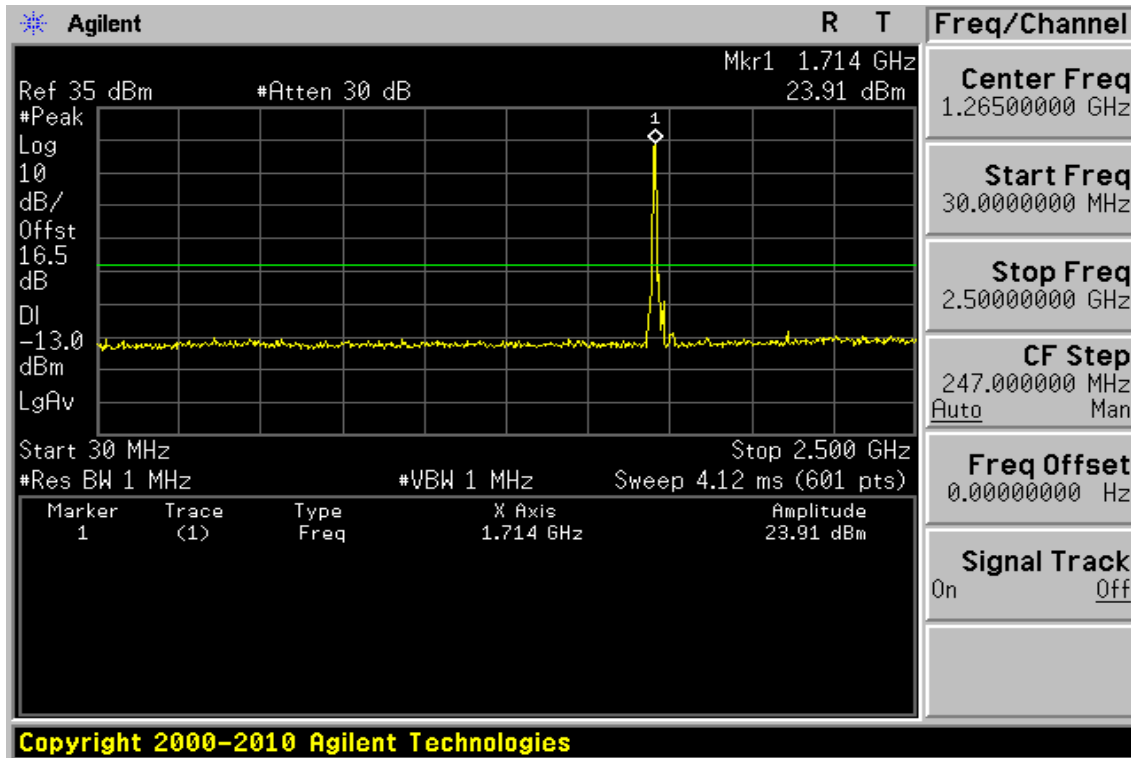

Unless otherwise stated the results shown in this test report refer only to the sample(s) tested and such sample(s) are retained for 90 days only.

除非另有說明，此報告結果僅對測試之樣品負責，同時此樣品僅保留90天。本報告未經本公司書面許可，不可部份複製。

This document is issued by the Company subject to its General Conditions of Service printed overleaf, available on request or accessible at www.sgs.com/terms_and_conditions.htm and for electronic format documents, subject to Terms and Conditions for Electronic Documents at www.sgs.com/terms_e-document.htm. Attention is drawn to the limitation of liability, indemnification and jurisdiction issues defined therein. Any holder of this document is advised that information contained hereon reflects the Company's findings at the time of its intervention only and within the limits of Client's instructions, if any. The Company's sole responsibility is to its Client and this document does not exonerate parties to a transaction from exercising all their rights and obligations under the transaction documents. This document cannot be reproduced except in full, without prior written approval of the Company. Any unauthorized alteration, forgery or falsification of the content or appearance of this document is unlawful and offenders may be prosecuted to the fullest extent of the law.

Figure 9-37: Out of Band emission at antenna terminals – HSUPA IV Channel Mid

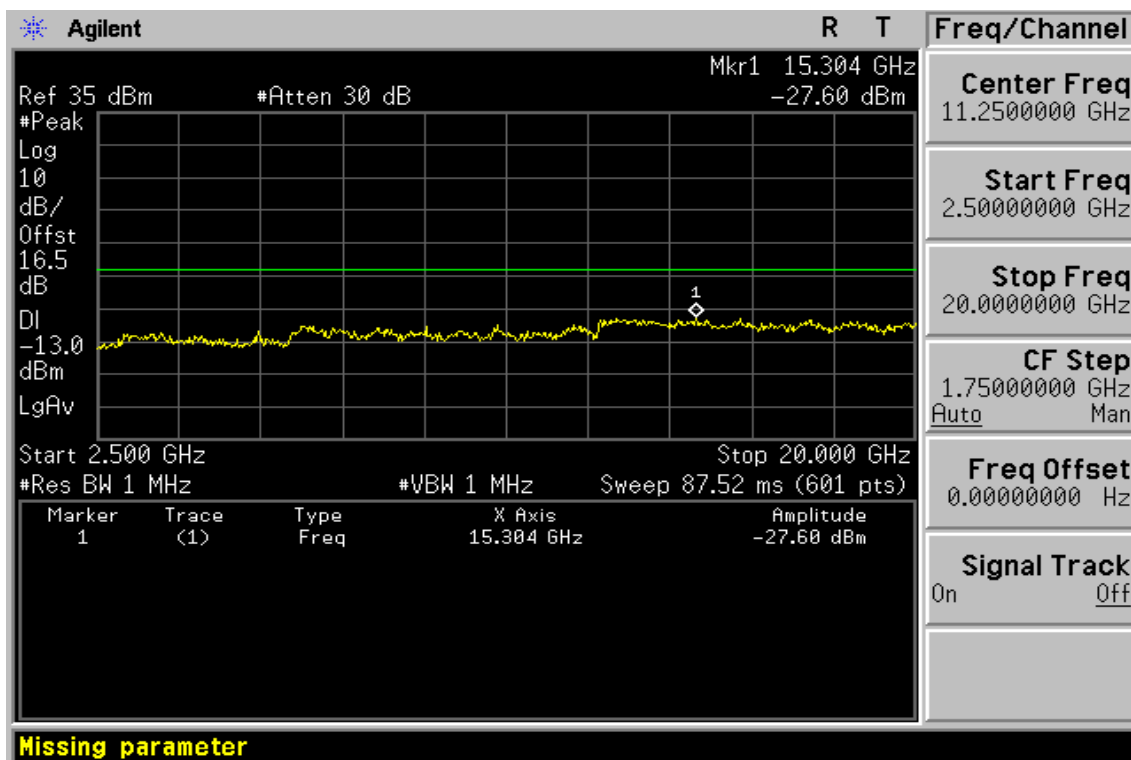
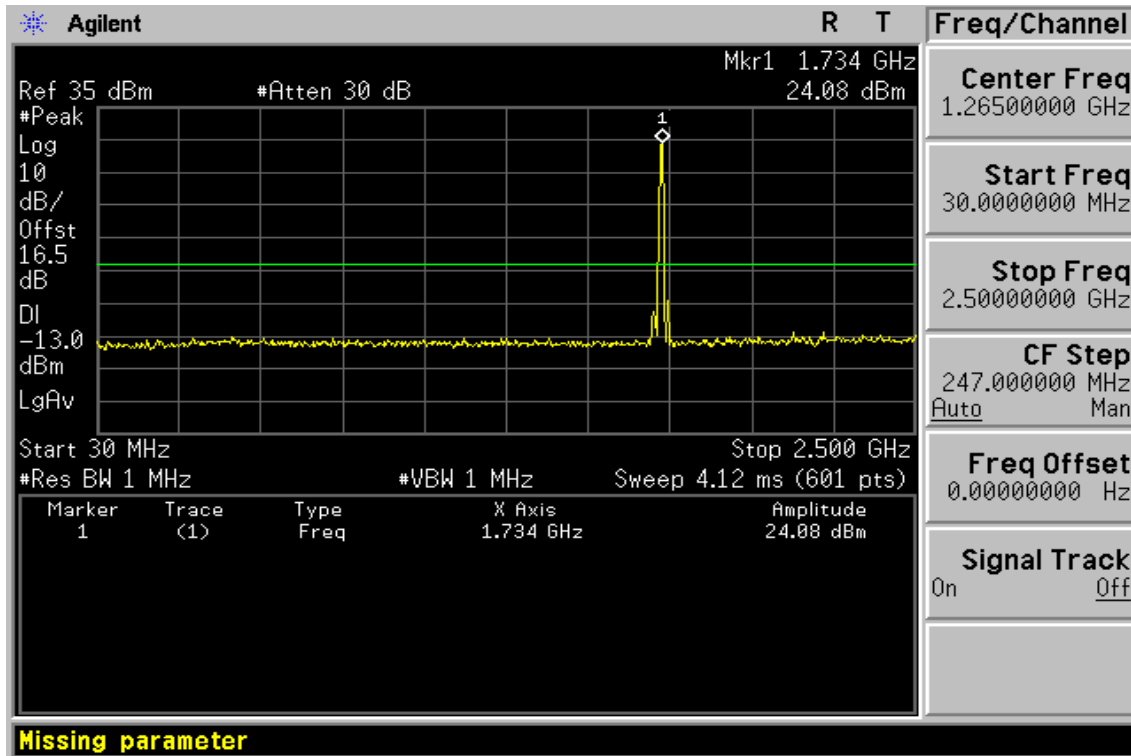

Unless otherwise stated the results shown in this test report refer only to the sample(s) tested and such sample(s) are retained for 90 days only.

除非另有說明，此報告結果僅對測試之樣品負責，同時此樣品僅保留90天。本報告未經本公司書面許可，不可部份複製。

This document is issued by the Company subject to its General Conditions of Service printed overleaf, available on request or accessible at www.sgs.com/terms_and_conditions.htm and for electronic format documents, subject to Terms and Conditions for Electronic Documents at www.sgs.com/terms_e-document.htm. Attention is drawn to the limitation of liability, indemnification and jurisdiction issues defined therein. Any holder of this document is advised that information contained hereon reflects the Company's findings at the time of its intervention only and within the limits of Client's instructions, if any. The Company's sole responsibility is to its Client and this document does not exonerate parties to a transaction from exercising all their rights and obligations under the transaction documents. This document cannot be reproduced except in full, without prior written approval of the Company. Any unauthorized alteration, forgery or falsification of the content or appearance of this document is unlawful and offenders may be prosecuted to the fullest extent of the law.

SGS Taiwan Ltd. No.134, Wu Kung Road, Wuku Industrial Zone, Taipei County, Taiwan / 台北縣五股工業區五工路 134 號

台灣檢驗科技股份有限公司

t (886-2) 2299-3279

f (886-2) 2298-0488

www.tw.sgs.com

Member of SGS Group

Figure 9-38: Out of Band emission at antenna terminals – HSUPA IV Channel Highest

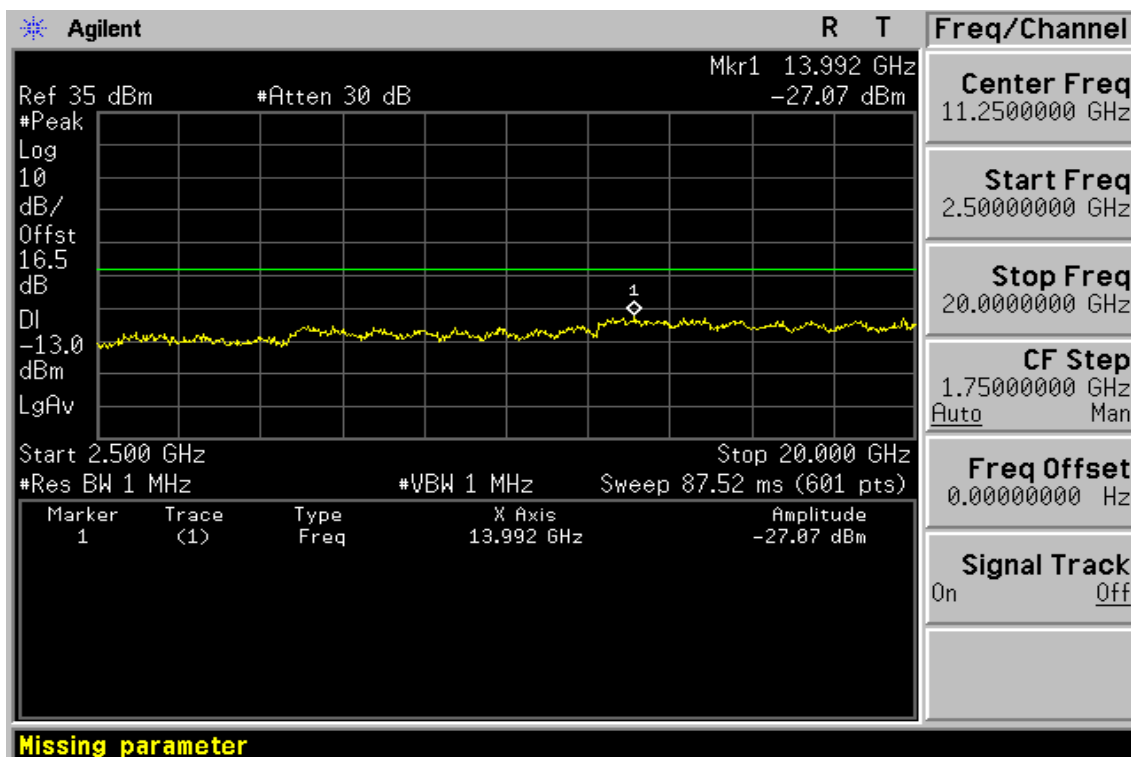
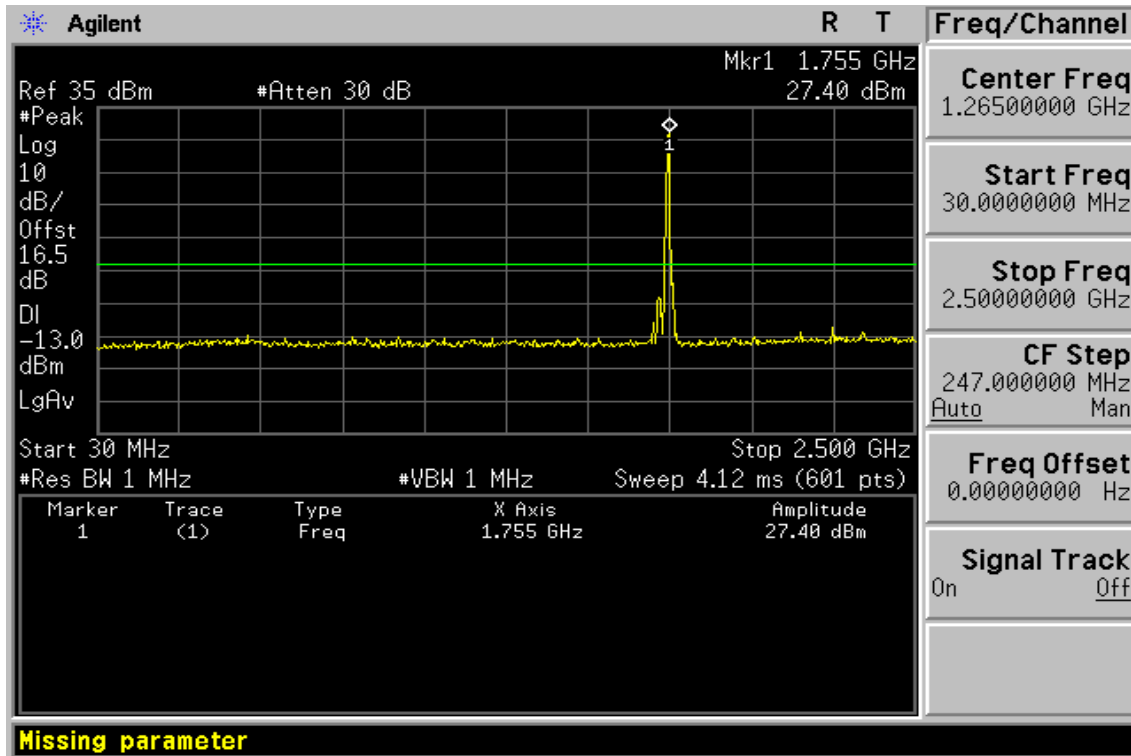

Unless otherwise stated the results shown in this test report refer only to the sample(s) tested and such sample(s) are retained for 90 days only.

除非另有說明，此報告結果僅對測試之樣品負責，同時此樣品僅保留90天。本報告未經本公司書面許可，不可部份複製。

This document is issued by the Company subject to its General Conditions of Service printed overleaf, available on request or accessible at www.sgs.com/terms_and_conditions.htm and for electronic format documents, subject to Terms and Conditions for Electronic Documents at www.sgs.com/terms_e-document.htm. Attention is drawn to the limitation of liability, indemnification and jurisdiction issues defined therein. Any holder of this document is advised that information contained hereon reflects the Company's findings at the time of its intervention only and within the limits of Client's instructions, if any. The Company's sole responsibility is to its Client and this document does not exonerate parties to a transaction from exercising all their rights and obligations under the transaction documents. This document cannot be reproduced except in full, without prior written approval of the Company. Any unauthorized alteration, forgery or falsification of the content or appearance of this document is unlawful and offenders may be prosecuted to the fullest extent of the law.

SGS Taiwan Ltd. No.134, Wu Kung Road, Wuku Industrial Zone, Taipei County, Taiwan / 台北縣五股工業區五工路 134 號

台灣檢驗科技股份有限公司

t (886-2) 2299-3279

f (886-2) 2298-0488

www.tw.sgs.com

Member of SGS Group

Figure 9-39: Bad edge emission at antenna terminals – HSUPA IV Channel Lowest

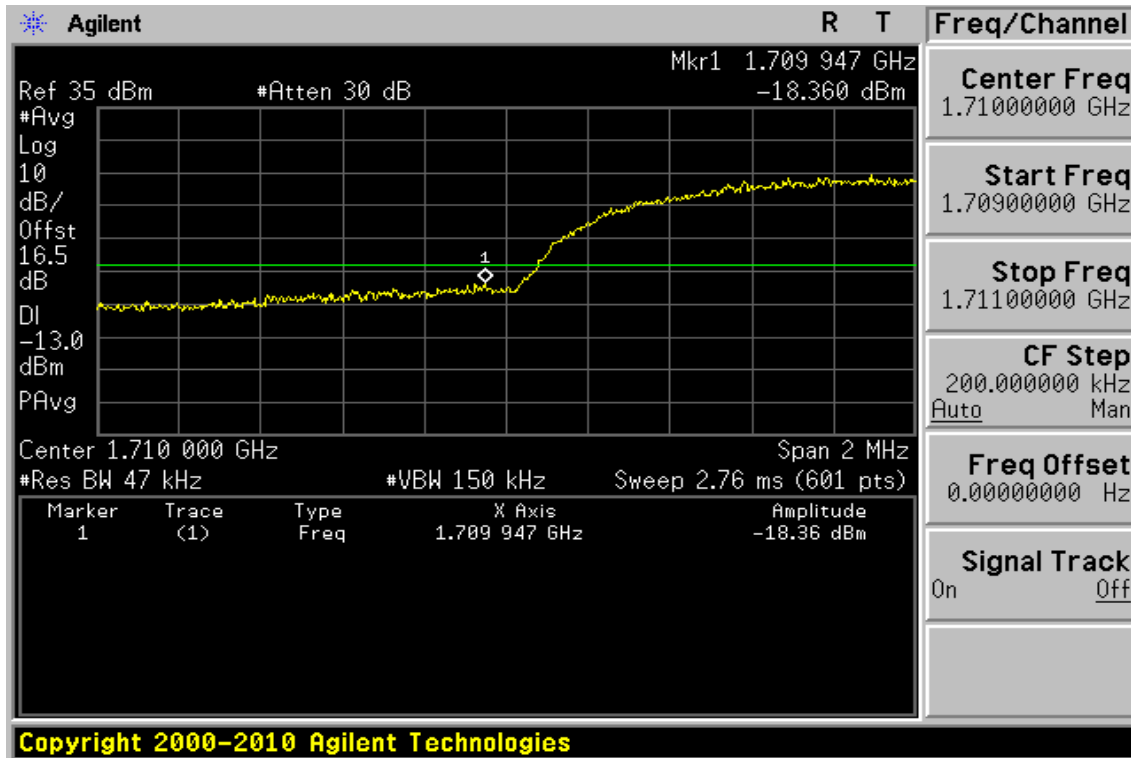
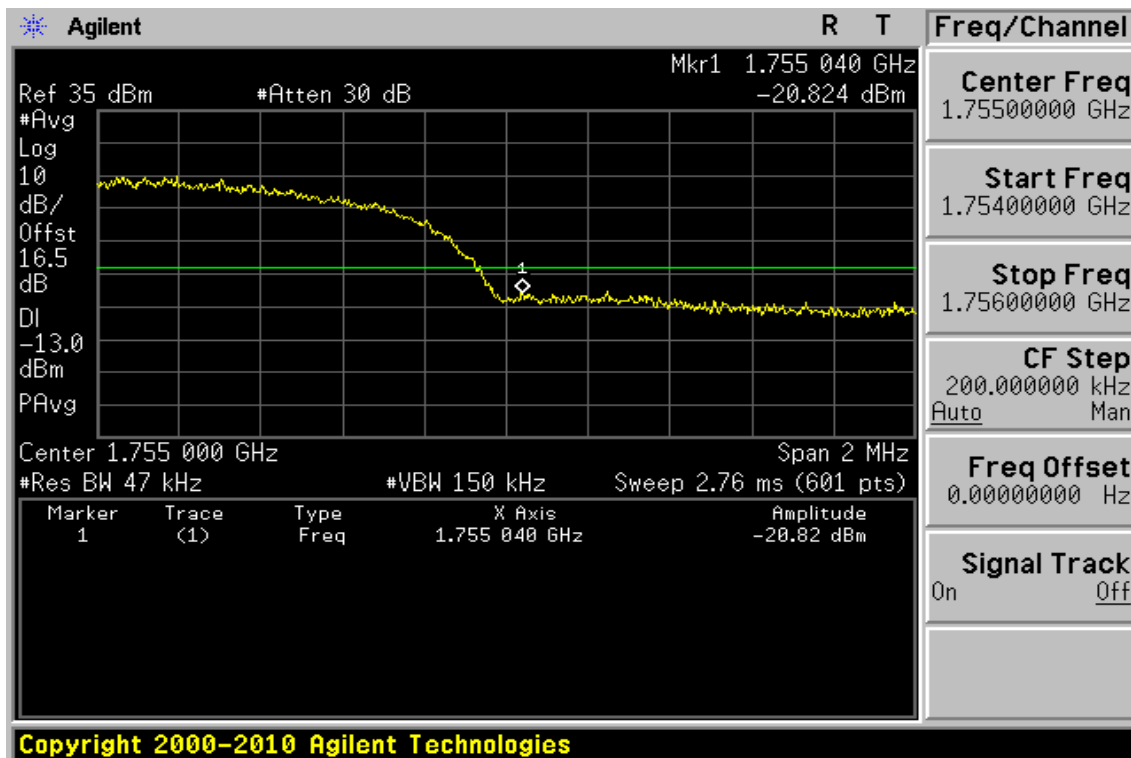

Figure 9-40: Band edge emission at antenna terminals – HSUPA IV Channel Highest



Unless otherwise stated the results shown in this test report refer only to the sample(s) tested and such sample(s) are retained for 90 days only.

除非另有說明，此報告結果僅對測試之樣品負責，同時此樣品僅保留90天。本報告未經本公司書面許可，不可部份複製。

This document is issued by the Company subject to its General Conditions of Service printed overleaf, available on request or accessible at www.sgs.com/terms_and_conditions.htm and for electronic format documents, subject to Terms and Conditions for Electronic Documents at www.sgs.com/terms_e-document.htm. Attention is drawn to the limitation of liability, indemnification and jurisdiction issues defined therein. Any holder of this document is advised that information contained hereon reflects the Company's findings at the time of its intervention only and within the limits of Client's instructions, if any. The Company's sole responsibility is to its Client and this document does not exonerate parties to a transaction from exercising all their rights and obligations under the transaction documents. This document cannot be reproduced except in full, without prior written approval of the Company. Any unauthorized alteration, forgery or falsification of the content or appearance of this document is unlawful and offenders may be prosecuted to the fullest extent of the law.

Figure 9-41: Out of Band emission at antenna terminals – HSDPA IV Channel Lowest

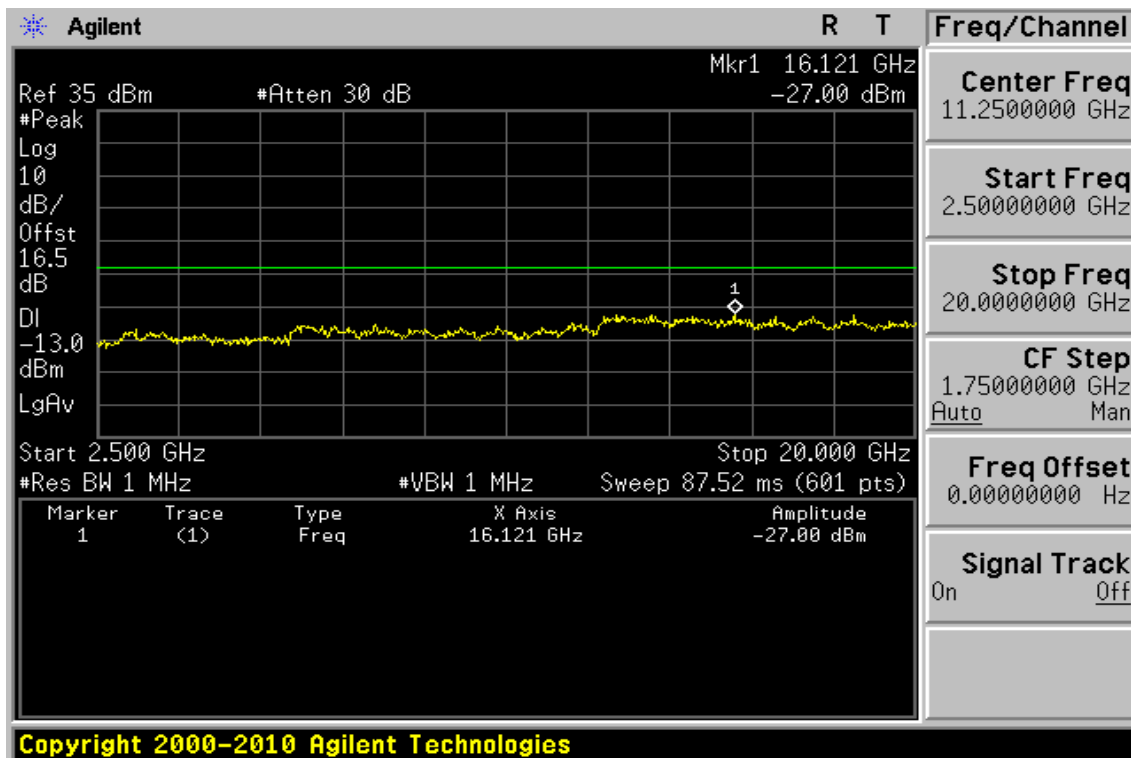
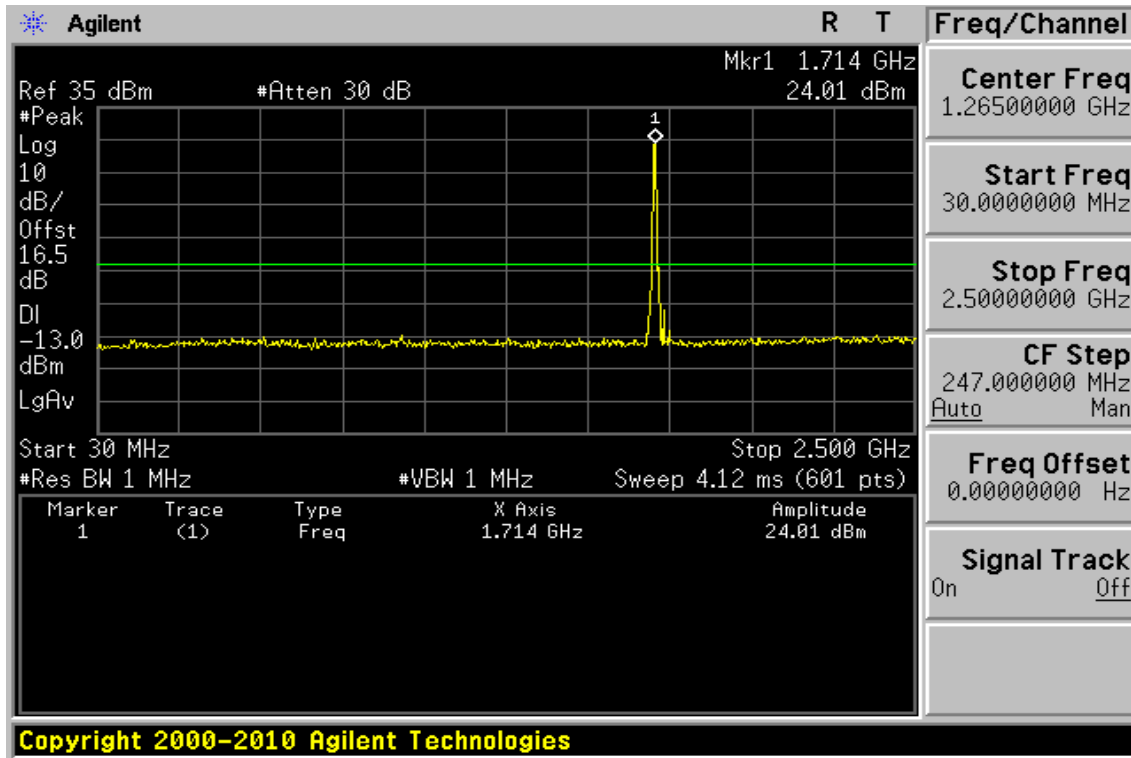

Unless otherwise stated the results shown in this test report refer only to the sample(s) tested and such sample(s) are retained for 90 days only.

除非另有說明，此報告結果僅對測試之樣品負責，同時此樣品僅保留90天。本報告未經本公司書面許可，不可部份複製。

This document is issued by the Company subject to its General Conditions of Service printed overleaf, available on request or accessible at www.sgs.com/terms_and_conditions.htm and for electronic format documents, subject to Terms and Conditions for Electronic Documents at www.sgs.com/terms_e-document.htm. Attention is drawn to the limitation of liability, indemnification and jurisdiction issues defined therein. Any holder of this document is advised that information contained hereon reflects the Company's findings at the time of its intervention only and within the limits of Client's instructions, if any. The Company's sole responsibility is to its Client and this document does not exonerate parties to a transaction from exercising all their rights and obligations under the transaction documents. This document cannot be reproduced except in full, without prior written approval of the Company. Any unauthorized alteration, forgery or falsification of the content or appearance of this document is unlawful and offenders may be prosecuted to the fullest extent of the law.

SGS Taiwan Ltd. No.134, Wu Kung Road, Wuku Industrial Zone, Taipei County, Taiwan / 台北縣五股工業區五工路 134 號

台灣檢驗科技股份有限公司

t (886-2) 2299-3279

f (886-2) 2298-0488

www.tw.sgs.com

Member of SGS Group

Figure 9-42: Out of Band emission at antenna terminals – HSDPA IV Channel Mid

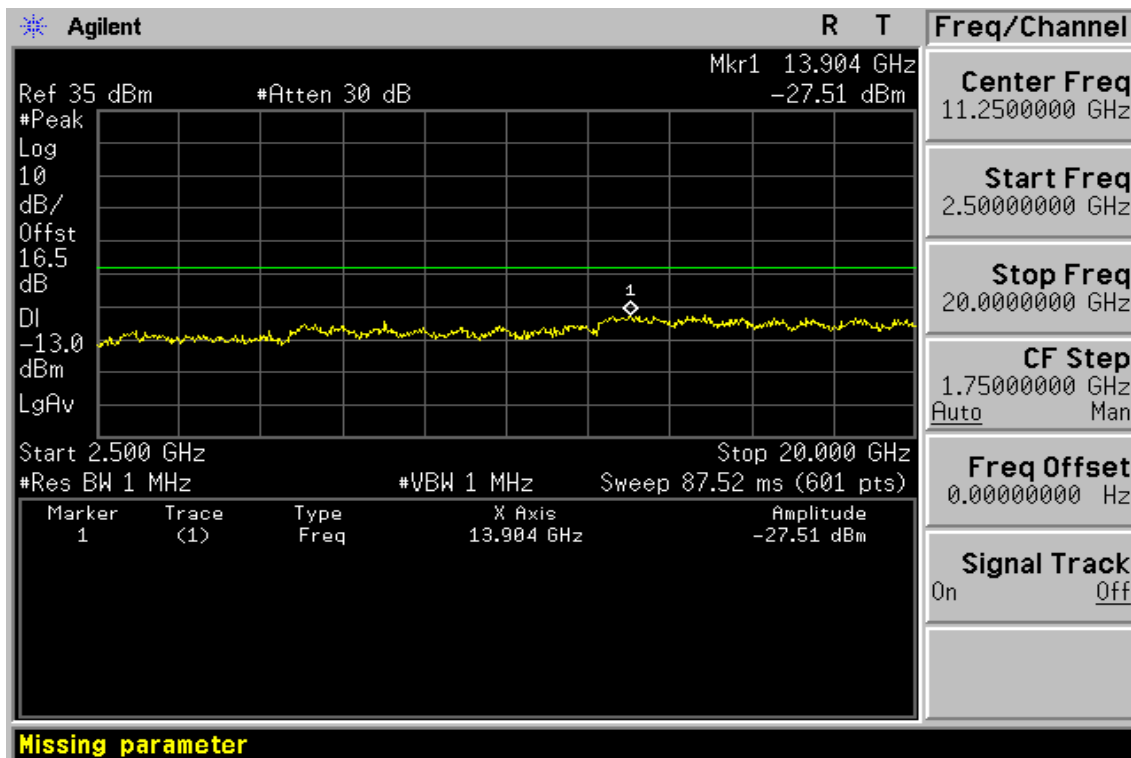
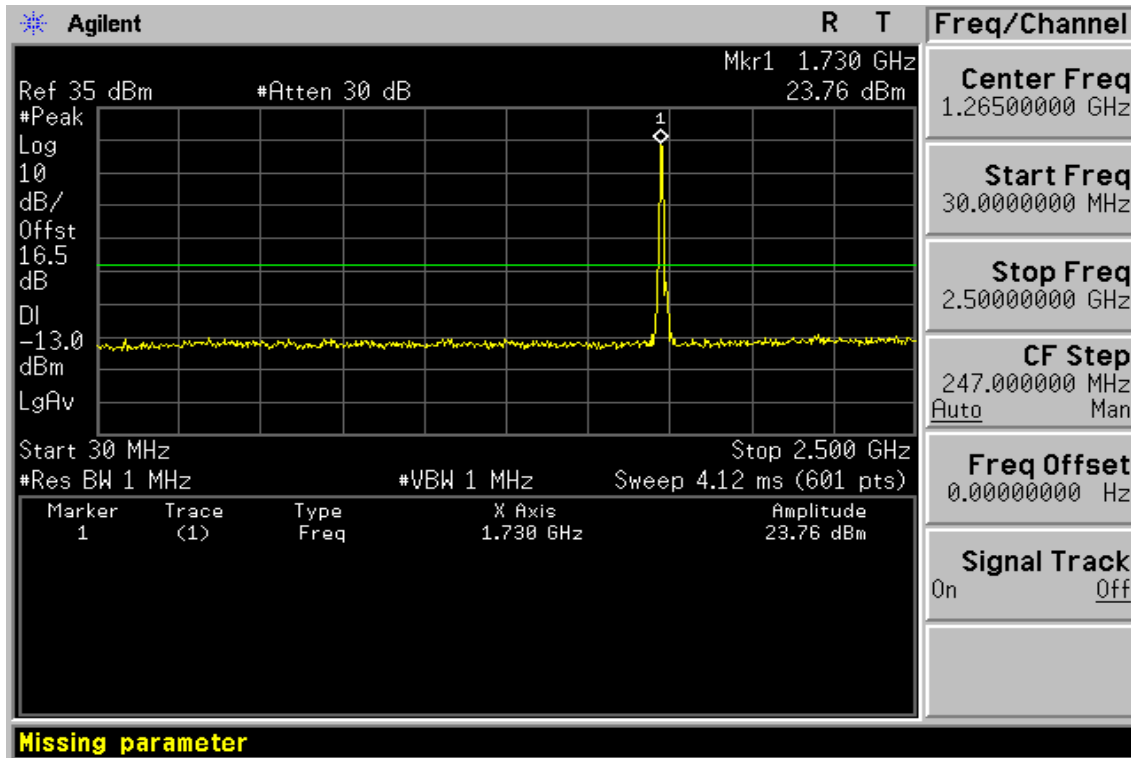

Unless otherwise stated the results shown in this test report refer only to the sample(s) tested and such sample(s) are retained for 90 days only.

除非另有說明，此報告結果僅對測試之樣品負責，同時此樣品僅保留90天。本報告未經本公司書面許可，不可部份複製。

This document is issued by the Company subject to its General Conditions of Service printed overleaf, available on request or accessible at www.sgs.com/terms_and_conditions.htm and for electronic format documents, subject to Terms and Conditions for Electronic Documents at www.sgs.com/terms_e-document.htm. Attention is drawn to the limitation of liability, indemnification and jurisdiction issues defined therein. Any holder of this document is advised that information contained hereon reflects the Company's findings at the time of its intervention only and within the limits of Client's instructions, if any. The Company's sole responsibility is to its Client and this document does not exonerate parties to a transaction from exercising all their rights and obligations under the transaction documents. This document cannot be reproduced except in full, without prior written approval of the Company. Any unauthorized alteration, forgery or falsification of the content or appearance of this document is unlawful and offenders may be prosecuted to the fullest extent of the law.

Figure 9-43: Out of Band emission at antenna terminals – HSDPA IV Channel Highest

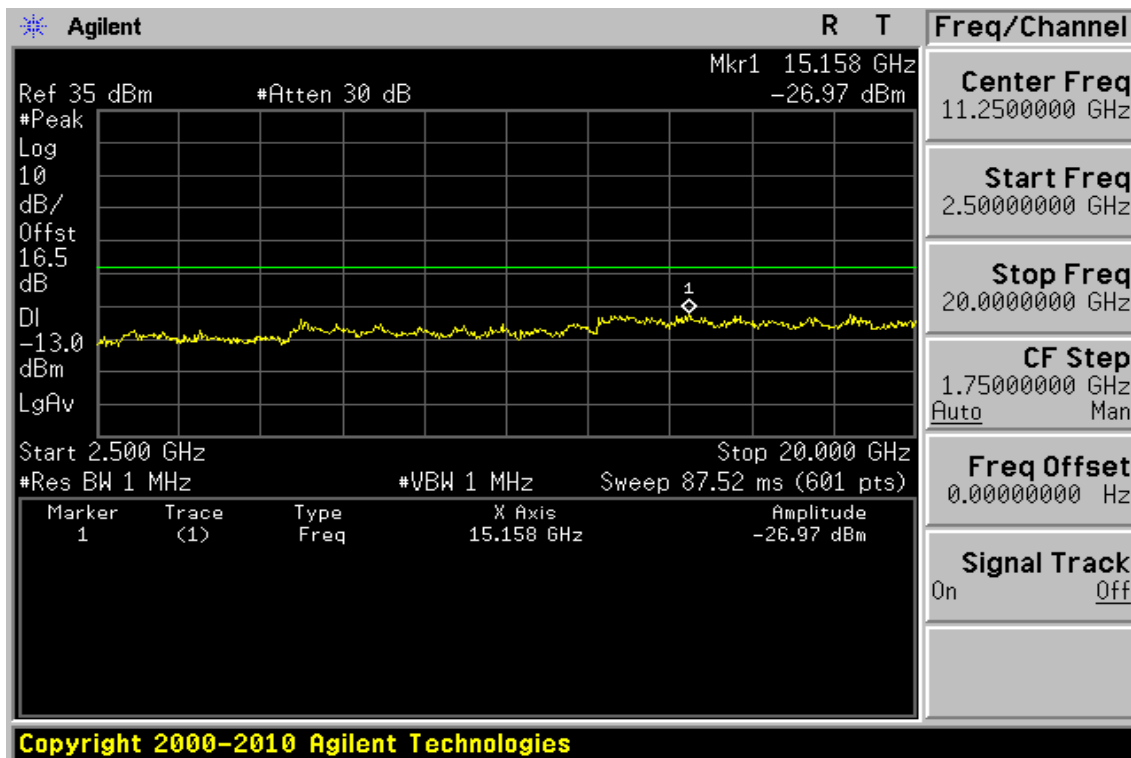
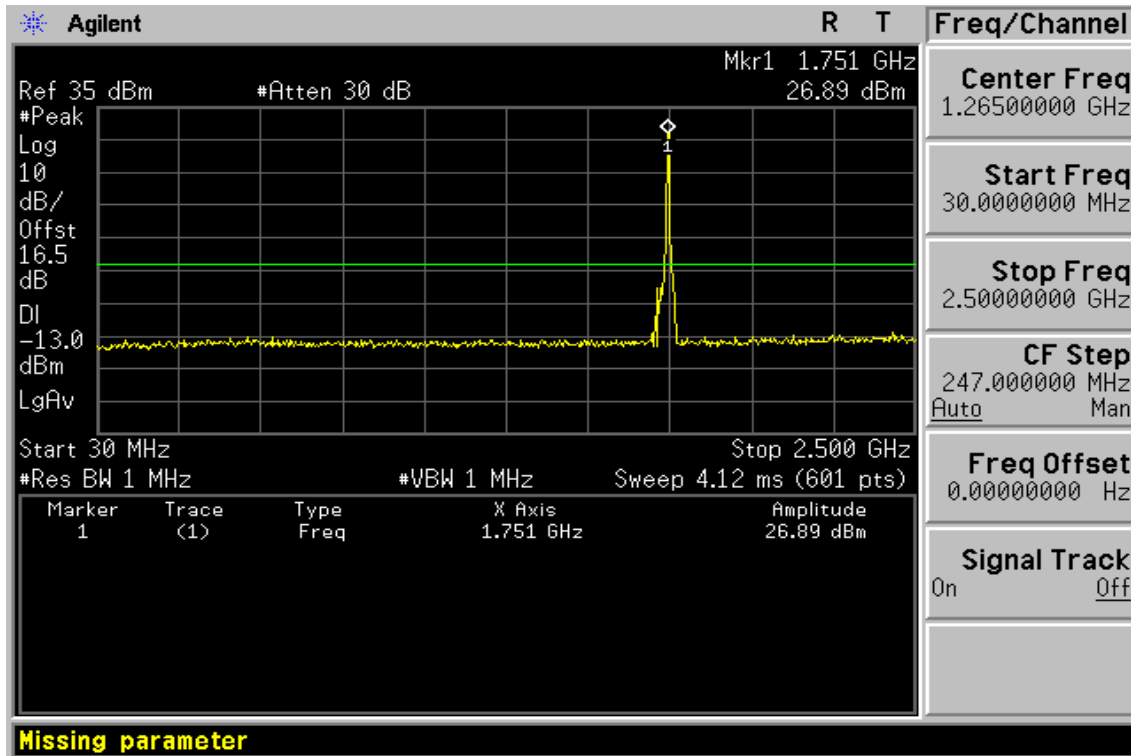

Unless otherwise stated the results shown in this test report refer only to the sample(s) tested and such sample(s) are retained for 90 days only.

除非另有說明，此報告結果僅對測試之樣品負責，同時此樣品僅保留90天。本報告未經本公司書面許可，不可部份複製。

This document is issued by the Company subject to its General Conditions of Service printed overleaf, available on request or accessible at www.sgs.com/terms_and_conditions.htm and for electronic format documents, subject to Terms and Conditions for Electronic Documents at www.sgs.com/terms_e-document.htm. Attention is drawn to the limitation of liability, indemnification and jurisdiction issues defined therein. Any holder of this document is advised that information contained hereon reflects the Company's findings at the time of its intervention only and within the limits of Client's instructions, if any. The Company's sole responsibility is to its Client and this document does not exonerate parties to a transaction from exercising all their rights and obligations under the transaction documents. This document cannot be reproduced except in full, without prior written approval of the Company. Any unauthorized alteration, forgery or falsification of the content or appearance of this document is unlawful and offenders may be prosecuted to the fullest extent of the law.

Figure 9-44: Bad edge emission at antenna terminals – HSDPA IV Channel Lowest

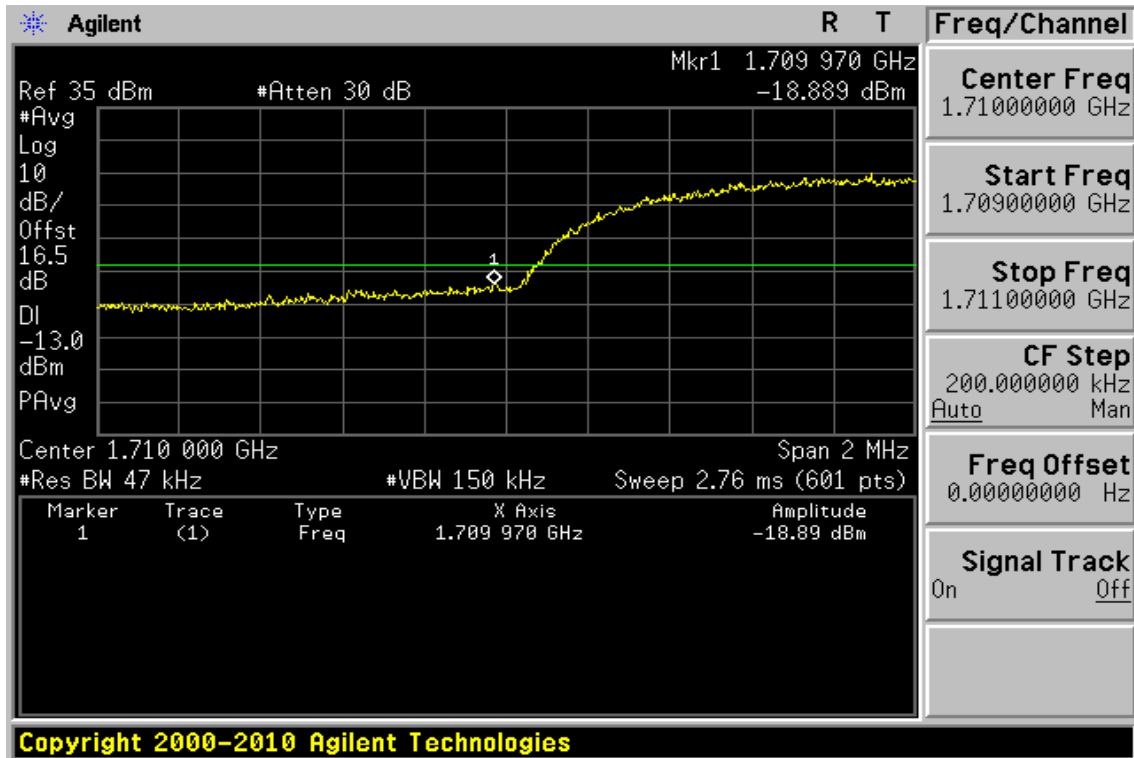
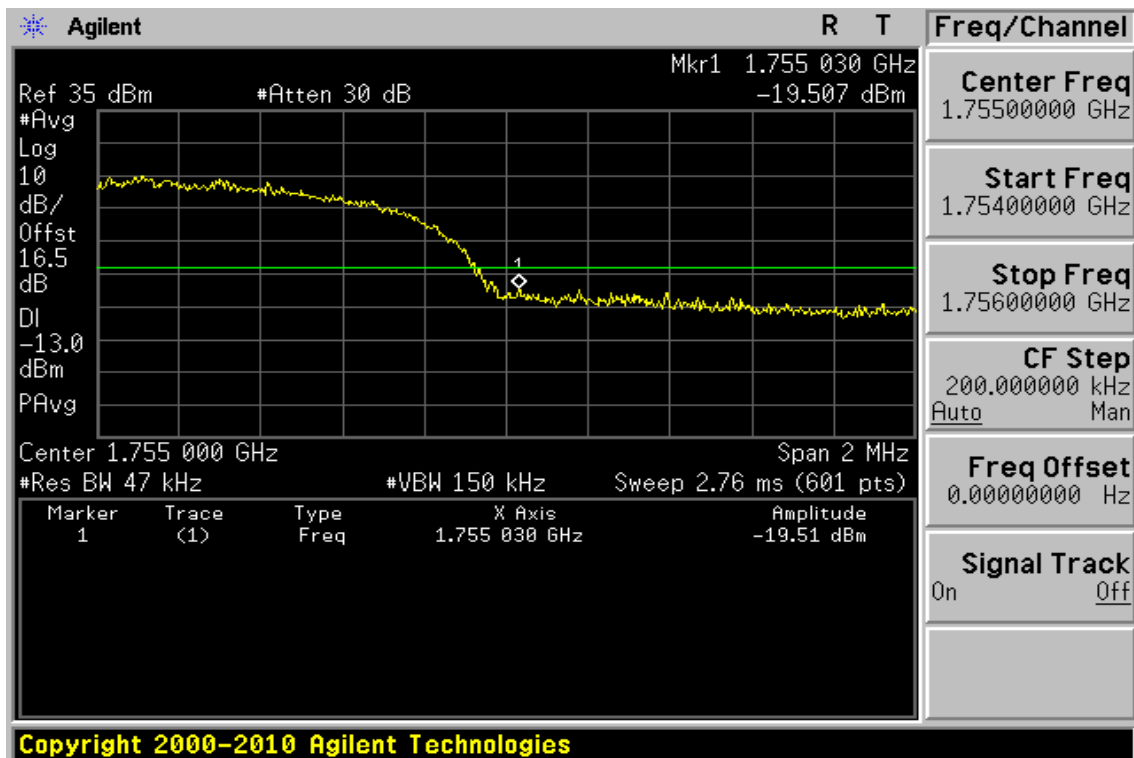

Figure 9-45: Band edge emission at antenna terminals – HSDPA IV Channel Highest



Unless otherwise stated the results shown in this test report refer only to the sample(s) tested and such sample(s) are retained for 90 days only.

除非另有說明，此報告結果僅對測試之樣品負責，同時此樣品僅保留90天。本報告未經本公司書面許可，不可部份複製。

This document is issued by the Company subject to its General Conditions of Service printed overleaf, available on request or accessible at www.sgs.com/terms_and_conditions.htm and for electronic format documents, subject to Terms and Conditions for Electronic Documents at www.sgs.com/terms_e-document.htm. Attention is drawn to the limitation of liability, indemnification and jurisdiction issues defined therein. Any holder of this document is advised that information contained hereon reflects the Company's findings at the time of its intervention only and within the limits of Client's instructions, if any. The Company's sole responsibility is to its Client and this document does not exonerate parties to a transaction from exercising all their rights and obligations under the transaction documents. This document cannot be reproduced except in full, without prior written approval of the Company. Any unauthorized alteration, forgery or falsification of the content or appearance of this document is unlawful and offenders may be prosecuted to the fullest extent of the law.

SGS Taiwan Ltd. No.134, Wu Kung Road, Wuku Industrial Zone, Taipei County, Taiwan / 台北縣五股工業區五工路 134 號

台灣檢驗科技股份有限公司

t (886-2) 2299-3279

f (886-2) 2298-0488

www.tw.sgs.com

Member of SGS Group

10. FIELD STRENGTH OF SPURIOUS RADIATION MEASUREMENT

10.1. Standard Applicable:

According to FCC §2.1053,

FCC §22.917(a), §24.238(a), §27.53(g) the magnitude of each spurious and harmonic emission that can be detected when the equipment is operated under the conditions specified in the instruction manual and/ or alignment procedure, shall not be less than $43 + 10 \log$ (mean output power in watts) dBc below the mean power output outside a license's frequency block (-13dBm)

10.2. EUT Setup (Block Diagram of Configuration):

Refer to section 6.2 in this report

10.3. Measurement Procedure:

The EUT was placed on a non-conductive, The measurement antenna was placed at a distance of 3 meters from the EUT. During the tests, the antenna height and the EUT azimuth were varied in order to identify the maximum level of emissions from the EUT. This maximization process was repeated with the EUT positioned in each of its three orthogonal orientations.

The frequency range up to tenth harmonic was investigated for each of three fundamental frequency (low, middle and high channels). Once spurious emission were identified, the power of the emission was determined using the substitution method.

The spurious emissions attenuation was calculated as the difference between radiated power at the fundamental frequency and the spurious emissions frequency.

$ERP = S.G. \text{ output (dBm)} + \text{Antenna Gain (dBd)} - \text{Cable Loss (dB)}$

$EIRP = S.G. \text{ output (dBm)} + \text{Antenna Gain (dBi)} - \text{Cable Loss (dB)}$

10.4. Measurement Equipment Used:

Refer to section 2.4 in this report

10.5. Measurement Result:

Refer to attach tabular data sheets.

Unless otherwise stated the results shown in this test report refer only to the sample(s) tested and such sample(s) are retained for 90 days only.

除非另有說明，此報告結果僅對測試之樣品負責，同時此樣品僅保留90天。本報告未經本公司書面許可，不可部份複製。

This document is issued by the Company subject to its General Conditions of Service printed overleaf, available on request or accessible at www.sgs.com/terms_and_conditions.htm and for electronic format documents, subject to Terms and Conditions for Electronic Documents at www.sgs.com/terms_e-document.htm. Attention is drawn to the limitation of liability, indemnification and jurisdiction issues defined therein. Any holder of this document is advised that information contained hereon reflects the Company's findings at the time of its intervention only and within the limits of Client's instructions, if any. The Company's sole responsibility is to its Client and this document does not exonerate parties to a transaction from exercising all their rights and obligations under the transaction documents. This document cannot be reproduced except in full, without prior written approval of the Company. Any unauthorized alteration, forgery or falsification of the content or appearance of this document is unlawful and offenders may be prosecuted to the fullest extent of the law.

SGS Taiwan Ltd. No.134, Wu Kung Road, Wuku Industrial Zone, Taipei County, Taiwan / 台北縣五股工業區五工路 134 號

台灣檢驗科技股份有限公司 t (886-2) 2299-3279

f (886-2) 2298-0488

www.tw.sgs.com

Member of SGS Group

Radiated Spurious Emission Measurement Result: GSM 850 Mode

Operation Band	:GSM 850	Test Date	:2011-10-28
ARFCN	:128	Temp./Humi.	:27 deg_C / 66 RH
Fundamental Frequency	:824.2	Engineer	:Lion
Operation Mode	:CH LOW		
EUT Pol.	:E2 PLAN	Pol:	:VERTICAL

Freq. (MHz)	Note F/H/E/S	EIRP dBm	S.G Output Level (dBm)	Antenna Gain (dBi)	Cable Loss (dB)	Limit (dBm)	Safe Margin (dB)
78.50	S	-54.40	-49.22	-2.54	-2.67	-13.00	-41.40
160.95	S	-54.81	-51.47	-0.43	-2.93	-13.00	-41.81
253.10	S	-57.92	-59.34	4.60	-3.23	-13.00	-44.92
352.04	S	-53.26	-54.71	4.77	-3.43	-13.00	-40.26
449.04	S	-53.62	-54.52	4.47	-3.70	-13.00	-40.62
539.25	S	-59.56	-60.57	4.61	-3.77	-13.00	-46.56
1648.40	H	-50.24	-47.51	2.39	-5.36	-13.00	-37.24
2472.60	H	-52.87	-50.29	3.14	-6.15	-13.00	-39.87
3296.80	H	-49.67	-47.71	4.70	-6.83	-13.00	-36.67
4121.00	H	-50.56	-49.09	5.80	-7.31	-13.00	-37.56
4945.20	---						
5769.40	---						
6593.60	---						
7417.80	---						
8242.00	---						

ERP(dBm) = SG Level(dBm) + Antenna Gain(dBd) + Cable Loss(dB)

Note : “F” : denotes Fundamental Frequency. ; “H” : denotes Harmonic Frequency.

“E” : denotes Band Edge Frequency. ; “S” : denotes Spurious Frequency.

“---“ : denotes Noise Floor.

Unless otherwise stated the results shown in this test report refer only to the sample(s) tested and such sample(s) are retained for 90 days only.

除非另有說明，此報告結果僅對測試之樣品負責，同時此樣品僅保留90天。本報告未經本公司書面許可，不可部份複製。

This document is issued by the Company subject to its General Conditions of Service printed overleaf, available on request or accessible at www.sgs.com/terms_and_conditions.htm and for electronic format documents, subject to Terms and Conditions for Electronic Documents at www.sgs.com/terms_e-document.htm. Attention is drawn to the limitation of liability, indemnification and jurisdiction issues defined therein. Any holder of this document is advised that information contained hereon reflects the Company's findings at the time of its intervention only and within the limits of Client's instructions, if any. The Company's sole responsibility is to its Client and this document does not exonerate parties to a transaction from exercising all their rights and obligations under the transaction documents. This document cannot be reproduced except in full, without prior written approval of the Company. Any unauthorized alteration, forgery or falsification of the content or appearance of this document is unlawful and offenders may be prosecuted to the fullest extent of the law.

Operation Band	:GSM 850	Test Date	:2011-10-28
ARFCN	:128	Temp./Humi.	:27 deg_C / 66 RH
Fundamental Frequency	: 824.2	Engineer	:Lion
Operation Mode	: CH LOW		
EUT Pol.	:E2 PLAN	Pol:	:HORIZONTAL

Freq. (MHz)	Note F/H/E/S	EIRP dBm	S.G Output Level (dBm)	Antenna Gain (dBi)	Cable Loss (dB)	Limit (dBm)	Safe Margin (dB)
81.41	S	-60.30	-55.78	-1.87	-2.67	-13.00	-47.30
165.80	S	-58.45	-55.81	0.27	-2.93	-13.00	-45.45
253.10	S	-56.40	-57.82	4.60	-3.23	-13.00	-43.40
354.95	S	-48.82	-50.24	4.75	-3.43	-13.00	-35.82
444.19	S	-54.06	-54.98	4.50	-3.70	-13.00	-41.06
626.55	S	-64.06	-64.54	4.08	-3.97	-13.00	-51.06
1648.40	H	-45.37	-42.91	2.68	-5.36	-13.00	-32.37
2472.60	H	-51.98	-49.78	3.52	-6.15	-13.00	-38.98
3296.80	---						
4121.00	---						
4945.20	---						
5769.40	---						
6593.60	---						
7417.80	---						
8242.00	---						

ERP(dBm) = SG Level(dBm) + Antenna Gain(dBd) + Cable Loss(dB)

Note : “F” : denotes Fundamental Frequency. ; “H” : denotes Harmonic Frequency.

“E” : denotes Band Edge Frequency. ; “S” : denotes Spurious Frequency.

“---“ : denotes Noise Floor.

Unless otherwise stated the results shown in this test report refer only to the sample(s) tested and such sample(s) are retained for 90 days only.

除非另有說明，此報告結果僅對測試之樣品負責，同時此樣品僅保留90天。本報告未經本公司書面許可，不可部份複製。

This document is issued by the Company subject to its General Conditions of Service printed overleaf, available on request or accessible at www.sgs.com/terms_and_conditions.htm and for electronic format documents, subject to Terms and Conditions for Electronic Documents at www.sgs.com/terms_e-document.htm. Attention is drawn to the limitation of liability, indemnification and jurisdiction issues defined therein. Any holder of this document is advised that information contained hereon reflects the Company's findings at the time of its intervention only and within the limits of Client's instructions, if any. The Company's sole responsibility is to its Client and this document does not exonerate parties to a transaction from exercising all their rights and obligations under the transaction documents. This document cannot be reproduced except in full, without prior written approval of the Company. Any unauthorized alteration, forgery or falsification of the content or appearance of this document is unlawful and offenders may be prosecuted to the fullest extent of the law.

Operation Band	:GSM 850	Test Date	:2011-10-28
ARFCN	:190	Temp./Humi.	:27 deg_C / 66 RH
Fundamental Frequency	:836.6	Engineer	:Lion
Operation Mode	:CH MID		
EUT Pol.	:E2 PLAN	Pol:	:VERTICAL

Freq. (MHz)	Note F/H/E/S	EIRP dBm	S.G Output Level (dBm)	Antenna Gain (dBi)	Cable Loss (dB)	Limit (dBm)	Safe Margin (dB)
79.47	S	-57.55	-52.71	-2.19	-2.67	-13.00	-44.55
163.86	S	-56.09	-53.17	-0.01	-2.93	-13.00	-43.09
250.19	S	-57.79	-59.17	4.55	-3.23	-13.00	-44.79
352.04	S	-53.17	-54.62	4.77	-3.43	-13.00	-40.17
445.16	S	-53.78	-54.69	4.49	-3.70	-13.00	-40.78
539.25	S	-59.71	-60.71	4.61	-3.77	-13.00	-46.71
1673.20	H	-51.01	-48.34	2.35	-5.29	-13.00	-38.01
2509.80	H	-51.16	-48.54	3.19	-6.13	-13.00	-38.16
3346.40	---						
4183.00	---						
5019.60	---						
5856.20	---						
6692.80	---						
7529.40	---						
8366.00	---						

ERP(dBm) = SG Level(dBm) + Antenna Gain(dBd) + Cable Loss(dB)

Note : “F” : denotes Fundamental Frequency. ; “H” : denotes Harmonic Frequency.

“E” : denotes Band Edge Frequency. ; “S” : denotes Spurious Frequency.

“---“ : denotes Noise Floor.

Unless otherwise stated the results shown in this test report refer only to the sample(s) tested and such sample(s) are retained for 90 days only.

除非另有說明，此報告結果僅對測試之樣品負責，同時此樣品僅保留90天。本報告未經本公司書面許可，不可部份複製。

This document is issued by the Company subject to its General Conditions of Service printed overleaf, available on request or accessible at www.sgs.com/terms_and_conditions.htm and for electronic format documents, subject to Terms and Conditions for Electronic Documents at www.sgs.com/terms_e-document.htm. Attention is drawn to the limitation of liability, indemnification and jurisdiction issues defined therein. Any holder of this document is advised that information contained hereon reflects the Company's findings at the time of its intervention only and within the limits of Client's instructions, if any. The Company's sole responsibility is to its Client and this document does not exonerate parties to a transaction from exercising all their rights and obligations under the transaction documents. This document cannot be reproduced except in full, without prior written approval of the Company. Any unauthorized alteration, forgery or falsification of the content or appearance of this document is unlawful and offenders may be prosecuted to the fullest extent of the law.

Operation Band	:GSM 850	Test Date	:2011-10-28
ARFCN	:190	Temp./Humi.	:27 deg_C / 66 RH
Fundamental Frequency	:836.6	Engineer	:Lion
Operation Mode	:CH MID		
EUT Pol.	:E2 PLAN	Pol.	:HORIZONTAL

Freq. (MHz)	Note F/H/E/S	EIRP dBm	S.G Output Level (dBm)	Antenna Gain (dBi)	Cable Loss (dB)	Limit (dBm)	Safe Margin (dB)
81.41	S	-64.59	-60.07	-1.87	-2.67	-13.00	-51.59
165.80	S	-58.94	-56.29	0.27	-2.93	-13.00	-45.94
251.16	S	-56.96	-58.35	4.57	-3.23	-13.00	-43.96
352.04	S	-48.94	-50.39	4.77	-3.43	-13.00	-35.94
450.01	S	-54.22	-55.12	4.47	-3.70	-13.00	-41.22
633.34	S	-63.57	-64.08	4.09	-3.98	-13.00	-50.57
1673.20	H	-46.14	-43.79	2.66	-5.29	-13.00	-33.14
2509.80	H	-52.16	-49.89	3.55	-6.13	-13.00	-39.16
3346.40	---						
4183.00	---						
5019.60	---						
5856.20	---						
6692.80	---						
7529.40	---						
8366.00	---						

ERP(dBm) = SG Level(dBm) + Antenna Gain(dBd) + Cable Loss(dB)

Note : “F” : denotes Fundamental Frequency. ; “H” : denotes Harmonic Frequency.

“E” : denotes Band Edge Frequency. ; “S” : denotes Spurious Frequency.

“---“ : denotes Noise Floor.

Unless otherwise stated the results shown in this test report refer only to the sample(s) tested and such sample(s) are retained for 90 days only.

除非另有說明，此報告結果僅對測試之樣品負責，同時此樣品僅保留90天。本報告未經本公司書面許可，不可部份複製。

This document is issued by the Company subject to its General Conditions of Service printed overleaf, available on request or accessible at www.sgs.com/terms_and_conditions.htm and for electronic format documents, subject to Terms and Conditions for Electronic Documents at www.sgs.com/terms_e-document.htm. Attention is drawn to the limitation of liability, indemnification and jurisdiction issues defined therein. Any holder of this document is advised that information contained hereon reflects the Company's findings at the time of its intervention only and within the limits of Client's instructions, if any. The Company's sole responsibility is to its Client and this document does not exonerate parties to a transaction from exercising all their rights and obligations under the transaction documents. This document cannot be reproduced except in full, without prior written approval of the Company. Any unauthorized alteration, forgery or falsification of the content or appearance of this document is unlawful and offenders may be prosecuted to the fullest extent of the law.

Operation Band	:GSM 850	Test Date	:2011-10-28
ARFCN	:251	Temp./Humi.	:27 deg_C / 66 RH
Fundamental Frequency	:848.8	Engineer	:Lion
Operation Mode	:CH HIGH		
EUT Pol.	:E2 PLAN	Pol.	:VERTICAL

Freq. (MHz)	Note F/H/E/S	EIRP dBm	S.G Output Level (dBm)	Antenna Gain (dBi)	Cable Loss (dB)	Limit (dBm)	Safe Margin (dB)
78.50	S	-56.17	-50.99	-2.54	-2.67	-13.00	-43.17
163.86	S	-55.17	-52.25	-0.01	-2.93	-13.00	-42.17
253.10	S	-57.99	-59.41	4.60	-3.23	-13.00	-44.99
352.04	S	-54.70	-56.15	4.77	-3.43	-13.00	-41.70
450.01	S	-52.59	-53.49	4.47	-3.70	-13.00	-39.59
542.16	S	-60.09	-61.01	4.60	-3.85	-13.00	-47.09
1697.60	H	-45.12	-42.27	2.29	-5.40	-13.00	-32.12
2546.40	H	-49.26	-46.55	3.30	-6.24	-13.00	-36.26
3395.20	---						
4244.00	---						
5092.80	---						
5941.60	---						
6790.40	---						
7639.20	---						
8488.00	---						

ERP(dBm) = SG Level(dBm) + Antenna Gain(dBd) + Cable Loss(dB)

Note : “F” : denotes Fundamental Frequency. ; “H” : denotes Harmonic Frequency.

“E” : denotes Band Edge Frequency. ; “S” : denotes Spurious Frequency.

“---“ : denotes Noise Floor.

Unless otherwise stated the results shown in this test report refer only to the sample(s) tested and such sample(s) are retained for 90 days only.

除非另有說明，此報告結果僅對測試之樣品負責，同時此樣品僅保留90天。本報告未經本公司書面許可，不可部份複製。

This document is issued by the Company subject to its General Conditions of Service printed overleaf, available on request or accessible at www.sgs.com/terms_and_conditions.htm and for electronic format documents, subject to Terms and Conditions for Electronic Documents at www.sgs.com/terms_e-document.htm. Attention is drawn to the limitation of liability, indemnification and jurisdiction issues defined therein. Any holder of this document is advised that information contained hereon reflects the Company's findings at the time of its intervention only and within the limits of Client's instructions, if any. The Company's sole responsibility is to its Client and this document does not exonerate parties to a transaction from exercising all their rights and obligations under the transaction documents. This document cannot be reproduced except in full, without prior written approval of the Company. Any unauthorized alteration, forgery or falsification of the content or appearance of this document is unlawful and offenders may be prosecuted to the fullest extent of the law.

Operation Band	:GSM 850	Test Date	:2011-10-28
ARFCN	:251	Temp./Humi.	:27 deg_C / 66 RH
Fundamental Frequency	:848.8	Engineer	:Lion
Operation Mode	:CH HIGH		
EUT Pol.	:E2 PLAN	Pol.	:HORIZONTAL

Freq. (MHz)	Note F/H/E/S	EIRP dBm	S.G Output Level (dBm)	Antenna Gain (dBi)	Cable Loss (dB)	Limit (dBm)	Safe Margin (dB)
80.44	S	-64.54	-59.94	-1.96	-2.67	-13.00	-51.54
163.86	S	-58.87	-55.95	-0.01	-2.93	-13.00	-45.87
253.10	S	-56.45	-57.87	4.60	-3.23	-13.00	-43.45
354.95	S	-49.14	-50.56	4.75	-3.43	-13.00	-36.14
447.10	S	-53.64	-54.55	4.48	-3.70	-13.00	-40.64
648.86	S	-63.43	-64.05	4.12	-3.98	-13.00	-50.43
1697.60	H	-41.22	-38.74	2.65	-5.40	-13.00	-28.22
2546.40	H	-51.54	-49.19	3.66	-6.24	-13.00	-38.54
3395.20	---						
4244.00	---						
5092.80	---						
5941.60	---						
6790.40	---						
7639.20	---						
8488.00	---						

ERP(dBm) = SG Level(dBm) + Antenna Gain(dBd) + Cable Loss(dB)

Note : “F” : denotes Fundamental Frequency. ; “H” : denotes Harmonic Frequency.

“E” : denotes Band Edge Frequency. ; “S” : denotes Spurious Frequency.

“---“ : denotes Noise Floor.

Unless otherwise stated the results shown in this test report refer only to the sample(s) tested and such sample(s) are retained for 90 days only.

除非另有說明，此報告結果僅對測試之樣品負責，同時此樣品僅保留90天。本報告未經本公司書面許可，不可部份複製。

This document is issued by the Company subject to its General Conditions of Service printed overleaf, available on request or accessible at www.sgs.com/terms_and_conditions.htm and for electronic format documents, subject to Terms and Conditions for Electronic Documents at www.sgs.com/terms_e-document.htm. Attention is drawn to the limitation of liability, indemnification and jurisdiction issues defined therein. Any holder of this document is advised that information contained hereon reflects the Company's findings at the time of its intervention only and within the limits of Client's instructions, if any. The Company's sole responsibility is to its Client and this document does not exonerate parties to a transaction from exercising all their rights and obligations under the transaction documents. This document cannot be reproduced except in full, without prior written approval of the Company. Any unauthorized alteration, forgery or falsification of the content or appearance of this document is unlawful and offenders may be prosecuted to the fullest extent of the law.

Radiated Spurious Emission Measurement Result: GPRS 1900 Mode

Operation Band	:GPRS 1900	Test Date	:2011-10-28
ARFCN	:512	Temp./Humi.	:27 deg_C / 66 RH
Fundamental Frequency	:1850.2	Engineer	:Lion
Operation Mode	:CH LOW		
EUT Pol.	:H PLAN	Pol.	:VERTICAL

Freq. (MHz)	Note F/H/E/S	EIRP dBm	S.G Output Level (dBm)	Antenna Gain (dBi)	Cable Loss (dB)	Limit (dBm)	Safe Margin (dB)
78.50	S	-56.07	-50.89	-2.54	-2.67	-13.00	-43.07
163.86	S	-56.15	-53.23	-0.01	-2.93	-13.00	-43.15
251.16	S	-59.86	-61.25	4.57	-3.23	-13.00	-46.86
352.04	S	-55.04	-56.49	4.77	-3.43	-13.00	-42.04
450.01	S	-54.15	-55.05	4.47	-3.70	-13.00	-41.15
641.10	S	-60.61	-61.16	4.10	-3.98	-13.00	-47.61
3700.40	H	-38.56	-39.10	7.40	-6.98	-13.00	-25.56
5550.60	H	-38.65	-39.57	8.99	-8.37	-13.00	-25.65
7400.80	---						
9251.00	---						
11101.20	---						
12951.40	---						
14801.60	---						
16651.80	---						
18502.00	---						

$EIRP(dBm) = SG\ Level(dBm) + Antenna\ Gain(dBi) + Cable\ Loss(dB)$

Note : “F” : denotes Fundamental Frequency. ; “H” : denotes Harmonic Frequency.

“E” : denotes Band Edge Frequency. ; “S” : denotes Spurious Frequency.

“---“ : denotes Noise Floor.

Unless otherwise stated the results shown in this test report refer only to the sample(s) tested and such sample(s) are retained for 90 days only.

除非另有說明，此報告結果僅對測試之樣品負責，同時此樣品僅保留90天。本報告未經本公司書面許可，不可部份複製。

This document is issued by the Company subject to its General Conditions of Service printed overleaf, available on request or accessible at www.sgs.com/terms_and_conditions.htm and for electronic format documents, subject to Terms and Conditions for Electronic Documents at www.sgs.com/terms_e-document.htm. Attention is drawn to the limitation of liability, indemnification and jurisdiction issues defined therein. Any holder of this document is advised that information contained hereon reflects the Company's findings at the time of its intervention only and within the limits of Client's instructions, if any. The Company's sole responsibility is to its Client and this document does not exonerate parties to a transaction from exercising all their rights and obligations under the transaction documents. This document cannot be reproduced except in full, without prior written approval of the Company. Any unauthorized alteration, forgery or falsification of the content or appearance of this document is unlawful and offenders may be prosecuted to the fullest extent of the law.

Operation Band	:GPRS 1900	Test Date	:2011-10-28
ARFCN	:512	Temp./Humi.	:27 deg_C / 66 RH
Fundamental Frequency	:1850.2	Engineer	:Lion
Operation Mode	:CH LOW		
EUT Pol.	:H PLAN	Pol.	:HORIZONTAL

Freq. (MHz)	Note F/H/E/S	EIRP dBm	S.G Output Level (dBm)	Antenna Gain (dBi)	Cable Loss (dB)	Limit (dBm)	Safe Margin (dB)
80.44	S	-62.62	-58.02	-1.96	-2.67	-13.00	-49.62
163.86	S	-58.08	-55.16	-0.01	-2.93	-13.00	-45.08
251.16	S	-55.80	-57.19	4.57	-3.23	-13.00	-42.80
353.01	S	-49.50	-50.95	4.77	-3.43	-13.00	-36.50
449.04	S	-54.05	-54.95	4.47	-3.70	-13.00	-41.05
638.19	S	-63.40	-63.93	4.10	-3.98	-13.00	-50.40
3700.40	H	-45.92	-45.97	6.92	-6.98	-13.00	-32.92
5550.60	H	-44.61	-44.82	8.27	-8.37	-13.00	-31.61
7400.80	---						
9251.00	---						
11101.20	---						
12951.40	---						
14801.60	---						
16651.80	---						
18502.00	---						

EIRP(dBm) = SG Level(dBm) + Antenna Gain(dBi) + Cable Loss(dB)

Note : “F” : denotes Fundamental Frequency. ; “H” : denotes Harmonic Frequency.

“E” : denotes Band Edge Frequency. ; “S” : denotes Spurious Frequency.

“---“ : denotes Noise Floor.

Unless otherwise stated the results shown in this test report refer only to the sample(s) tested and such sample(s) are retained for 90 days only.

除非另有說明，此報告結果僅對測試之樣品負責，同時此樣品僅保留90天。本報告未經本公司書面許可，不可部份複製。

This document is issued by the Company subject to its General Conditions of Service printed overleaf, available on request or accessible at www.sgs.com/terms_and_conditions.htm and for electronic format documents, subject to Terms and Conditions for Electronic Documents at www.sgs.com/terms_e-document.htm. Attention is drawn to the limitation of liability, indemnification and jurisdiction issues defined therein. Any holder of this document is advised that information contained hereon reflects the Company's findings at the time of its intervention only and within the limits of Client's instructions, if any. The Company's sole responsibility is to its Client and this document does not exonerate parties to a transaction from exercising all their rights and obligations under the transaction documents. This document cannot be reproduced except in full, without prior written approval of the Company. Any unauthorized alteration, forgery or falsification of the content or appearance of this document is unlawful and offenders may be prosecuted to the fullest extent of the law.

Operation Band	:GPRS 1900	Test Date	:2011-10-28
ARFCN	:661	Temp./Humi.	:27 deg_C / 66 RH
Fundamental Frequency	:1880	Engineer	:Lion
Operation Mode	:CH MID		
EUT Pol.	:H PLAN	Pol.	:VERTICAL

Freq. (MHz)	Note F/H/E/S	EIRP dBm	S.G Output Level (dBm)	Antenna Gain (dBi)	Cable Loss (dB)	Limit (dBm)	Safe Margin (dB)
80.44	S	-56.01	-51.41	-1.96	-2.67	-13.00	-43.01
160.95	S	-54.73	-51.39	-0.43	-2.93	-13.00	-41.73
251.16	S	-58.78	-60.17	4.57	-3.23	-13.00	-45.78
350.10	S	-54.59	-56.06	4.79	-3.43	-13.00	-41.59
447.10	S	-53.32	-54.22	4.48	-3.70	-13.00	-40.32
731.31	S	-59.39	-60.06	3.76	-4.14	-13.00	-46.39
3760.00	H	-39.03	-39.63	7.42	-7.12	-13.00	-26.03
5640.00	H	-42.21	-43.06	9.01	-8.26	-13.00	-29.21
7520.00	---						
9400.00	---						
11280.00	---						
13160.00	---						
15040.00	---						
16920.00	---						
18800.00	---						

EIRP(dBm) = SG Level(dBm) + Antenna Gain(dBi) + Cable Loss(dB)

Note : “F” : denotes Fundamental Frequency. ; “H” : denotes Harmonic Frequency.

“E” : denotes Band Edge Frequency. ; “S” : denotes Spurious Frequency.

“---“ : denotes Noise Floor.

Unless otherwise stated the results shown in this test report refer only to the sample(s) tested and such sample(s) are retained for 90 days only.

除非另有說明，此報告結果僅對測試之樣品負責，同時此樣品僅保留90天。本報告未經本公司書面許可，不可部份複製。

This document is issued by the Company subject to its General Conditions of Service printed overleaf, available on request or accessible at www.sgs.com/terms_and_conditions.htm and for electronic format documents, subject to Terms and Conditions for Electronic Documents at www.sgs.com/terms_e-document.htm. Attention is drawn to the limitation of liability, indemnification and jurisdiction issues defined therein. Any holder of this document is advised that information contained hereon reflects the Company's findings at the time of its intervention only and within the limits of Client's instructions, if any. The Company's sole responsibility is to its Client and this document does not exonerate parties to a transaction from exercising all their rights and obligations under the transaction documents. This document cannot be reproduced except in full, without prior written approval of the Company. Any unauthorized alteration, forgery or falsification of the content or appearance of this document is unlawful and offenders may be prosecuted to the fullest extent of the law.

Operation Band	:GPRS 1900	Test Date	:2011-10-28
ARFCN	:661	Temp./Humi.	:27 deg_C / 66 RH
Fundamental Frequency	:1880	Engineer	:Lion
Operation Mode	:CH MID		
EUT Pol.	:H PLAN	Pol.	:HORIZONTAL

Freq. (MHz)	Note F/H/E/S	EIRP dBm	S.G Output Level (dBm)	Antenna Gain (dBi)	Cable Loss (dB)	Limit (dBm)	Safe Margin (dB)
80.44	S	-62.92	-58.31	-1.96	-2.67	-13.00	-49.92
163.86	S	-58.24	-55.33	-0.01	-2.93	-13.00	-45.24
255.04	S	-55.91	-57.32	4.63	-3.27	-13.00	-42.91
353.01	S	-49.27	-50.71	4.77	-3.43	-13.00	-36.27
447.10	S	-53.78	-54.69	4.48	-3.70	-13.00	-40.78
643.04	S	-63.83	-64.40	4.11	-3.98	-13.00	-50.83
3760.00	H	-46.90	-46.94	6.85	-7.12	-13.00	-33.90
5640.00	---						
7520.00	---						
9400.00	---						
11280.00	---						
13160.00	---						
15040.00	---						
16920.00	---						
18800.00	---						

EIRP(dBm) = SG Level(dBm) + Antenna Gain(dBi) + Cable Loss(dB)

Note : “F” : denotes Fundamental Frequency. ; “H” : denotes Harmonic Frequency.

“E” : denotes Band Edge Frequency. ; “S” : denotes Spurious Frequency.

“---“ : denotes Noise Floor.

Unless otherwise stated the results shown in this test report refer only to the sample(s) tested and such sample(s) are retained for 90 days only.

除非另有說明，此報告結果僅對測試之樣品負責，同時此樣品僅保留90天。本報告未經本公司書面許可，不可部份複製。

This document is issued by the Company subject to its General Conditions of Service printed overleaf, available on request or accessible at www.sgs.com/terms_and_conditions.htm and for electronic format documents, subject to Terms and Conditions for Electronic Documents at www.sgs.com/terms_e-document.htm. Attention is drawn to the limitation of liability, indemnification and jurisdiction issues defined therein. Any holder of this document is advised that information contained hereon reflects the Company's findings at the time of its intervention only and within the limits of Client's instructions, if any. The Company's sole responsibility is to its Client and this document does not exonerate parties to a transaction from exercising all their rights and obligations under the transaction documents. This document cannot be reproduced except in full, without prior written approval of the Company. Any unauthorized alteration, forgery or falsification of the content or appearance of this document is unlawful and offenders may be prosecuted to the fullest extent of the law.

Operation Band	:GPRS 1900	Test Date	:2011-10-28
ARFCN	:810	Temp./Humi.	:27 deg_C / 66 RH
Fundamental Frequency	:1909.8	Engineer	:Lion
Operation Mode	:CH HIGH		
EUT Pol.	:H PLAN	Pol.	:VERTICAL

Freq. (MHz)	Note F/H/E/S	EIRP dBm	S.G Output Level (dBm)	Antenna Gain (dBi)	Cable Loss (dB)	Limit (dBm)	Safe Margin (dB)
78.50	S	-60.47	-55.29	-2.54	-2.67	-13.00	-47.47
163.86	S	-56.67	-53.76	-0.01	-2.93	-13.00	-43.67
250.19	S	-62.82	-64.19	4.55	-3.23	-13.00	-49.82
352.04	S	-56.46	-57.91	4.77	-3.43	-13.00	-43.46
447.10	S	-55.70	-56.61	4.48	-3.70	-13.00	-42.70
536.34	S	-57.52	-58.53	4.62	-3.77	-13.00	-44.52
3819.60	H	-39.79	-40.31	7.50	-7.20	-13.00	-26.79
5729.40	H	-45.27	-45.98	9.03	-8.44	-13.00	-32.27
7639.20	---						
9549.00	---						
11458.80	---						
13368.60	---						
15278.40	---						
17188.20	---						
19098.00	---						

EIRP(dBm) = SG Level(dBm) + Antenna Gain(dBi) + Cable Loss(dB)

Note : “F” : denotes Fundamental Frequency. ; “H” : denotes Harmonic Frequency.

“E” : denotes Band Edge Frequency. ; “S” : denotes Spurious Frequency.

“---“ : denotes Noise Floor.

Unless otherwise stated the results shown in this test report refer only to the sample(s) tested and such sample(s) are retained for 90 days only.

除非另有說明，此報告結果僅對測試之樣品負責，同時此樣品僅保留90天。本報告未經本公司書面許可，不可部份複製。

This document is issued by the Company subject to its General Conditions of Service printed overleaf, available on request or accessible at www.sgs.com/terms_and_conditions.htm and for electronic format documents, subject to Terms and Conditions for Electronic Documents at www.sgs.com/terms_e-document.htm. Attention is drawn to the limitation of liability, indemnification and jurisdiction issues defined therein. Any holder of this document is advised that information contained hereon reflects the Company's findings at the time of its intervention only and within the limits of Client's instructions, if any. The Company's sole responsibility is to its Client and this document does not exonerate parties to a transaction from exercising all their rights and obligations under the transaction documents. This document cannot be reproduced except in full, without prior written approval of the Company. Any unauthorized alteration, forgery or falsification of the content or appearance of this document is unlawful and offenders may be prosecuted to the fullest extent of the law.

Operation Band	:GPRS 1900	Test Date	:2011-10-28
ARFCN	:810	Temp./Humi.	:27 deg_C / 66 RH
Fundamental Frequency	:1909.8	Engineer	:Lion
Operation Mode	:CH HIGH		
EUT Pol.	:H PLAN	Pol.	:HORIZONTAL

Freq. (MHz)	Note F/H/E/S	EIRP dBm	S.G Output Level (dBm)	Antenna Gain (dBi)	Cable Loss (dB)	Limit (dBm)	Safe Margin (dB)
80.44	S	-63.89	-59.29	-1.96	-2.67	-13.00	-50.89
163.86	S	-56.62	-53.70	-0.01	-2.93	-13.00	-43.62
255.04	S	-57.20	-58.61	4.63	-3.27	-13.00	-44.20
353.01	S	-49.58	-51.02	4.77	-3.43	-13.00	-36.58
445.16	S	-54.92	-55.83	4.49	-3.70	-13.00	-41.92
644.01	S	-62.56	-63.14	4.11	-3.98	-13.00	-49.56
3819.60	H	-44.21	-44.26	7.03	-7.20	-13.00	-31.21
5729.40	---						
7639.20	---						
9549.00	---						
11458.80	---						
13368.60	---						
15278.40	---						
17188.20	---						
19098.00	---						

EIRP(dBm) = SG Level(dBm) + Antenna Gain(dBi) + Cable Loss(dB)

Note : “F” : denotes Fundamental Frequency. ; “H” : denotes Harmonic Frequency.

“E” : denotes Band Edge Frequency. ; “S” : denotes Spurious Frequency.

“---“ : denotes Noise Floor.

Unless otherwise stated the results shown in this test report refer only to the sample(s) tested and such sample(s) are retained for 90 days only.

除非另有說明，此報告結果僅對測試之樣品負責，同時此樣品僅保留90天。本報告未經本公司書面許可，不可部份複製。

This document is issued by the Company subject to its General Conditions of Service printed overleaf, available on request or accessible at www.sgs.com/terms_and_conditions.htm and for electronic format documents, subject to Terms and Conditions for Electronic Documents at www.sgs.com/terms_e-document.htm. Attention is drawn to the limitation of liability, indemnification and jurisdiction issues defined therein. Any holder of this document is advised that information contained hereon reflects the Company's findings at the time of its intervention only and within the limits of Client's instructions, if any. The Company's sole responsibility is to its Client and this document does not exonerate parties to a transaction from exercising all their rights and obligations under the transaction documents. This document cannot be reproduced except in full, without prior written approval of the Company. Any unauthorized alteration, forgery or falsification of the content or appearance of this document is unlawful and offenders may be prosecuted to the fullest extent of the law.

Radiated Spurious Emission Measurement Result: HSUPA IV Mode

Operation Band	:HSUPA B4	Test Date	:2011-10-28
ARFCN	:1312	Temp./Humi.	:27 deg_C / 66 RH
Fundamental Frequency	:1712.4	Engineer	:Lion
Operation Mode	:CH LOW		
EUT Pol.	:E2 PLAN	Pol.	:VERTICAL

Freq. (MHz)	Note F/H/E/S	EIRP dBm	S.G Output Level (dBm)	Antenna Gain (dBi)	Cable Loss (dB)	Limit (dBm)	Safe Margin (dB)
78.50	S	-57.87	-54.84	-0.39	-2.67	-13.00	-44.87
163.86	S	-53.65	-52.86	2.14	-2.93	-13.00	-40.65
251.16	S	-59.76	-63.27	6.72	-3.23	-13.00	-46.76
350.10	S	-53.68	-57.22	6.94	-3.43	-13.00	-40.68
447.10	S	-53.92	-56.88	6.63	-3.70	-13.00	-40.92
541.19	S	-55.84	-58.87	6.75	-3.77	-13.00	-42.84
3424.80	H	-39.08	-39.73	7.20	-6.89	-13.00	-26.08
5137.20	H	-46.75	-47.73	8.81	-8.11	-13.00	-33.75
6849.60	H	-42.13	-42.99	9.84	-9.07	-13.00	-29.13
8562.00	---						
10274.40	---						
11986.80	---						
13699.20	---						
15411.60	---						
17124.00	---						

$EIRP(dBm) = SG\ Level(dBm) + Antenna\ Gain(dBi) + Cable\ Loss(dB)$

Note : “F” : denotes Fundamental Frequency. ; “H” : denotes Harmonic Frequency.
 “E” : denotes Band Edge Frequency. ; “S” : denotes Spurious Frequency.
 “---“ : denotes Noise Floor.

Unless otherwise stated the results shown in this test report refer only to the sample(s) tested and such sample(s) are retained for 90 days only.

除非另有說明，此報告結果僅對測試之樣品負責，同時此樣品僅保留90天。本報告未經本公司書面許可，不可部份複製。

This document is issued by the Company subject to its General Conditions of Service printed overleaf, available on request or accessible at www.sgs.com/terms_and_conditions.htm and for electronic format documents, subject to Terms and Conditions for Electronic Documents at www.sgs.com/terms_e-document.htm. Attention is drawn to the limitation of liability, indemnification and jurisdiction issues defined therein. Any holder of this document is advised that information contained hereon reflects the Company's findings at the time of its intervention only and within the limits of Client's instructions, if any. The Company's sole responsibility is to its Client and this document does not exonerate parties to a transaction from exercising all their rights and obligations under the transaction documents. This document cannot be reproduced except in full, without prior written approval of the Company. Any unauthorized alteration, forgery or falsification of the content or appearance of this document is unlawful and offenders may be prosecuted to the fullest extent of the law.

Operation Band	:HSUPA B4	Test Date	:2011-10-28
ARFCN	:1312	Temp./Humi.	:27 deg_C / 66 RH
Fundamental Frequency	:1712.4	Engineer	:Lion
Operation Mode	:CH LOW		
EUT Pol.	:E2 PLAN	Pol.	:HORIZONTAL

Freq. (MHz)	Note F/H/E/S	EIRP dBm	S.G Output Level (dBm)	Antenna Gain (dBi)	Cable Loss (dB)	Limit (dBm)	Safe Margin (dB)
78.50	S	-62.35	-59.32	-0.39	-2.67	-13.00	-49.35
162.89	S	-59.79	-58.86	2.00	-2.93	-13.00	-46.79
250.19	S	-56.14	-59.64	6.70	-3.23	-13.00	-43.14
353.01	S	-50.99	-54.50	6.92	-3.43	-13.00	-37.99
444.19	S	-55.64	-58.62	6.65	-3.70	-13.00	-42.64
733.25	S	-62.92	-64.72	5.88	-4.14	-13.00	-49.92
3424.80	H	-41.73	-42.33	7.15	-6.89	-13.00	-28.73
5137.20	---						
6849.60	---						
8562.00	---						
10274.40	---						
11986.80	---						
13699.20	---						
15411.60	---						
17124.00	---						

EIRP(dBm) = SG Level(dBm) + Antenna Gain(dBi) + Cable Loss(dB)

Note : “F” : denotes Fundamental Frequency. ; “H” : denotes Harmonic Frequency.

“E” : denotes Band Edge Frequency. ; “S” : denotes Spurious Frequency.

“---“ : denotes Noise Floor.

Unless otherwise stated the results shown in this test report refer only to the sample(s) tested and such sample(s) are retained for 90 days only.

除非另有說明，此報告結果僅對測試之樣品負責，同時此樣品僅保留90天。本報告未經本公司書面許可，不可部份複製。

This document is issued by the Company subject to its General Conditions of Service printed overleaf, available on request or accessible at www.sgs.com/terms_and_conditions.htm and for electronic format documents, subject to Terms and Conditions for Electronic Documents at www.sgs.com/terms_e-document.htm. Attention is drawn to the limitation of liability, indemnification and jurisdiction issues defined therein. Any holder of this document is advised that information contained hereon reflects the Company's findings at the time of its intervention only and within the limits of Client's instructions, if any. The Company's sole responsibility is to its Client and this document does not exonerate parties to a transaction from exercising all their rights and obligations under the transaction documents. This document cannot be reproduced except in full, without prior written approval of the Company. Any unauthorized alteration, forgery or falsification of the content or appearance of this document is unlawful and offenders may be prosecuted to the fullest extent of the law.

Operation Band	:HSUPA B4	Test Date	:2011-10-28
ARFCN	:1413	Temp./Humi.	:27 deg_C / 66 RH
Fundamental Frequency	:1732.6	Engineer	:Lion
Operation Mode	:CH MID		
EUT Pol.	:E2 PLAN	Pol.	:VERTICAL

Freq. (MHz)	Note F/H/E/S	EIRP dBm	S.G Output Level (dBm)	Antenna Gain (dBi)	Cable Loss (dB)	Limit (dBm)	Safe Margin (dB)
78.50	S	-57.70	-54.68	-0.39	-2.67	-13.00	-44.70
163.86	S	-55.07	-54.28	2.14	-2.93	-13.00	-42.07
250.19	S	-60.25	-63.75	6.70	-3.23	-13.00	-47.25
352.04	S	-54.91	-58.44	6.92	-3.43	-13.00	-41.91
449.04	S	-54.29	-57.24	6.62	-3.70	-13.00	-41.29
537.31	S	-55.04	-58.09	6.76	-3.77	-13.00	-42.04
3465.20	H	-42.07	-42.58	7.29	-6.99	-13.00	-29.07
5197.80	---						
6930.40	---						
8663.00	---						
10395.60	---						
12128.20	---						
13860.80	---						
15593.40	---						
17326.00	---						

EIRP(dBm) = SG Level(dBm) + Antenna Gain(dBi) + Cable Loss(dB)

Note : “F” : denotes Fundamental Frequency. ; “H” : denotes Harmonic Frequency.

“E” : denotes Band Edge Frequency. ; “S” : denotes Spurious Frequency.

“---“ : denotes Noise Floor.

Unless otherwise stated the results shown in this test report refer only to the sample(s) tested and such sample(s) are retained for 90 days only.

除非另有說明，此報告結果僅對測試之樣品負責，同時此樣品僅保留90天。本報告未經本公司書面許可，不可部份複製。

This document is issued by the Company subject to its General Conditions of Service printed overleaf, available on request or accessible at www.sgs.com/terms_and_conditions.htm and for electronic format documents, subject to Terms and Conditions for Electronic Documents at www.sgs.com/terms_e-document.htm. Attention is drawn to the limitation of liability, indemnification and jurisdiction issues defined therein. Any holder of this document is advised that information contained hereon reflects the Company's findings at the time of its intervention only and within the limits of Client's instructions, if any. The Company's sole responsibility is to its Client and this document does not exonerate parties to a transaction from exercising all their rights and obligations under the transaction documents. This document cannot be reproduced except in full, without prior written approval of the Company. Any unauthorized alteration, forgery or falsification of the content or appearance of this document is unlawful and offenders may be prosecuted to the fullest extent of the law.

Operation Band	:HSUPA B4	Test Date	:2011-10-28
ARFCN	:1413	Temp./Humi.	:27 deg_C / 66 RH
Fundamental Frequency	:1732.6	Engineer	:Lion
Operation Mode	:CH MID		
EUT Pol.	:E2 PLAN	Pol.	:HORIZONTAL

Freq. (MHz)	Note F/H/E/S	EIRP dBm	S.G Output Level (dBm)	Antenna Gain (dBi)	Cable Loss (dB)	Limit (dBm)	Safe Margin (dB)
78.50	S	-61.53	-58.51	-0.39	-2.67	-13.00	-48.53
163.86	S	-60.60	-59.81	2.14	-2.93	-13.00	-47.60
251.16	S	-56.18	-59.69	6.72	-3.23	-13.00	-43.18
352.04	S	-50.18	-53.70	6.92	-3.43	-13.00	-37.18
445.16	S	-56.39	-59.36	6.64	-3.70	-13.00	-43.39
730.34	S	-61.87	-63.70	5.92	-4.14	-13.00	-48.87
3465.20	H	-46.63	-47.10	7.24	-6.99	-13.00	-33.63
5197.80	---						
6930.40	---						
8663.00	---						
10395.60	---						
12128.20	---						
13860.80	---						
15593.40	---						
17326.00	---						

EIRP(dBm) = SG Level(dBm) + Antenna Gain(dBi) + Cable Loss(dB)

Note : “F” : denotes Fundamental Frequency. ; “H” : denotes Harmonic Frequency.

“E” : denotes Band Edge Frequency. ; “S” : denotes Spurious Frequency.

“---“ : denotes Noise Floor.

Unless otherwise stated the results shown in this test report refer only to the sample(s) tested and such sample(s) are retained for 90 days only.

除非另有說明，此報告結果僅對測試之樣品負責，同時此樣品僅保留90天。本報告未經本公司書面許可，不可部份複製。

This document is issued by the Company subject to its General Conditions of Service printed overleaf, available on request or accessible at www.sgs.com/terms_and_conditions.htm and for electronic format documents, subject to Terms and Conditions for Electronic Documents at www.sgs.com/terms_e-document.htm. Attention is drawn to the limitation of liability, indemnification and jurisdiction issues defined therein. Any holder of this document is advised that information contained hereon reflects the Company's findings at the time of its intervention only and within the limits of Client's instructions, if any. The Company's sole responsibility is to its Client and this document does not exonerate parties to a transaction from exercising all their rights and obligations under the transaction documents. This document cannot be reproduced except in full, without prior written approval of the Company. Any unauthorized alteration, forgery or falsification of the content or appearance of this document is unlawful and offenders may be prosecuted to the fullest extent of the law.

Operation Band	:HSUPA B4	Test Date	:2011-10-28
ARFCN	:1513	Temp./Humi.	:27 deg_C / 66 RH
Fundamental Frequency	:1752.6	Engineer	:Lion
Operation Mode	:CH HIGH		
EUT Pol.	:E2 PLAN	Pol.	:VERTICAL

Freq. (MHz)	Note F/H/E/S	EIRP dBm	S.G Output Level (dBm)	Antenna Gain (dBi)	Cable Loss (dB)	Limit (dBm)	Safe Margin (dB)
78.50	S	-57.73	-54.70	-0.39	-2.67	-13.00	-44.73
163.86	S	-54.26	-53.47	2.14	-2.93	-13.00	-41.26
251.16	S	-59.90	-63.41	6.72	-3.23	-13.00	-46.90
353.01	S	-54.89	-58.41	6.92	-3.43	-13.00	-41.89
447.10	S	-53.44	-56.40	6.63	-3.70	-13.00	-40.44
536.34	S	-55.41	-58.45	6.77	-3.77	-13.00	-42.41
3505.20	H	-38.56	-39.31	7.40	-7.01	-13.00	-25.56
5257.80	---						
7010.40	---						
8763.00	---						
10515.60	---						
12268.20	---						
14020.80	---						
15773.40	---						
17526.00	---						

EIRP(dBm) = SG Level(dBm) + Antenna Gain(dBi) + Cable Loss(dB)

Note : “F” : denotes Fundamental Frequency. ; “H” : denotes Harmonic Frequency.

“E” : denotes Band Edge Frequency. ; “S” : denotes Spurious Frequency.

“---“ : denotes Noise Floor.

Unless otherwise stated the results shown in this test report refer only to the sample(s) tested and such sample(s) are retained for 90 days only.

除非另有說明，此報告結果僅對測試之樣品負責，同時此樣品僅保留90天。本報告未經本公司書面許可，不可部份複製。

This document is issued by the Company subject to its General Conditions of Service printed overleaf, available on request or accessible at www.sgs.com/terms_and_conditions.htm and for electronic format documents, subject to Terms and Conditions for Electronic Documents at www.sgs.com/terms_e-document.htm. Attention is drawn to the limitation of liability, indemnification and jurisdiction issues defined therein. Any holder of this document is advised that information contained hereon reflects the Company's findings at the time of its intervention only and within the limits of Client's instructions, if any. The Company's sole responsibility is to its Client and this document does not exonerate parties to a transaction from exercising all their rights and obligations under the transaction documents. This document cannot be reproduced except in full, without prior written approval of the Company. Any unauthorized alteration, forgery or falsification of the content or appearance of this document is unlawful and offenders may be prosecuted to the fullest extent of the law.

Operation Band	:HSUPA B4	Test Date	:2011-10-28
ARFCN	:1513	Temp./Humi.	:27 deg_C / 66 RH
Fundamental Frequency	:1752.6	Engineer	:Lion
Operation Mode	:CH HIGH		
EUT Pol.	:E2 PLAN	Pol.	:HORIZONTAL

Freq. (MHz)	Note F/H/E/S	EIRP dBm	S.G Output Level (dBm)	Antenna Gain (dBi)	Cable Loss (dB)	Limit (dBm)	Safe Margin (dB)
81.41	S	-61.94	-59.57	0.28	-2.67	-13.00	-48.94
162.89	S	-60.53	-59.60	2.00	-2.93	-13.00	-47.53
251.16	S	-56.41	-59.92	6.72	-3.23	-13.00	-43.41
353.01	S	-50.74	-54.26	6.92	-3.43	-13.00	-37.74
451.95	S	-56.97	-59.93	6.63	-3.70	-13.00	-43.97
728.40	S	-60.18	-62.04	5.94	-4.14	-13.00	-47.18
3505.20	H	-43.00	-43.67	7.32	-7.01	-13.00	-30.00
5257.80	---						
7010.40	---						
8763.00	---						
10515.60	---						
12268.20	---						
14020.80	---						
15773.40	---						
17526.00	---						

EIRP(dBm) = SG Level(dBm) + Antenna Gain(dBi) + Cable Loss(dB)

Note : “F” : denotes Fundamental Frequency. ; “H” : denotes Harmonic Frequency.

“E” : denotes Band Edge Frequency. ; “S” : denotes Spurious Frequency.

“---“ : denotes Noise Floor.

Unless otherwise stated the results shown in this test report refer only to the sample(s) tested and such sample(s) are retained for 90 days only.

除非另有說明，此報告結果僅對測試之樣品負責，同時此樣品僅保留90天。本報告未經本公司書面許可，不可部份複製。

This document is issued by the Company subject to its General Conditions of Service printed overleaf, available on request or accessible at www.sgs.com/terms_and_conditions.htm and for electronic format documents, subject to Terms and Conditions for Electronic Documents at www.sgs.com/terms_e-document.htm. Attention is drawn to the limitation of liability, indemnification and jurisdiction issues defined therein. Any holder of this document is advised that information contained hereon reflects the Company's findings at the time of its intervention only and within the limits of Client's instructions, if any. The Company's sole responsibility is to its Client and this document does not exonerate parties to a transaction from exercising all their rights and obligations under the transaction documents. This document cannot be reproduced except in full, without prior written approval of the Company. Any unauthorized alteration, forgery or falsification of the content or appearance of this document is unlawful and offenders may be prosecuted to the fullest extent of the law.

11. FREQUENCY STABILITY V.S. TEMPERATURE MEASUREMENT

11.1. Standard Applicable:

According to FCC §2.1055(a) (1)

Frequency Tolerance: +/-2.5ppm for 850MHz band

+/-2.5ppm for 1900MHz band

§27.54: The frequency stability shall be sufficient to ensure that the fundamental emissions stay within the authorized bands of operation.

11.2. Test Set-up:

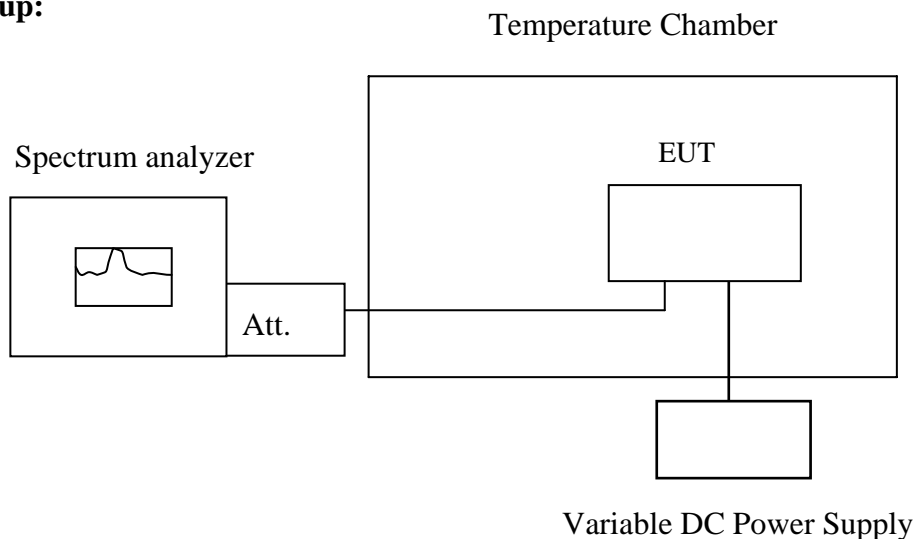

Note : Measurement setup for testing on Antenna connector

11.3. Measurement Procedure:

The equipment under test was connected to an external AC or DC power supply and input rated voltage. RF output was connected to a frequency counter or spectrum analyzer via feed through attenuators. The EUT was placed inside the temperature chamber. Set the spectrum analyzer RBW low enough to obtain the desired frequency resolution and measure EUT 25°C operating frequency as reference frequency. Turn EUT off and set the chamber temperature to -30°C. After the temperature stabilized for approximately 30 minutes recorded the frequency. Repeat step measure with 10°C increased per stage until the highest temperature of +50°C reached.

11.4. Measurement Equipment Used:

Refer to section 2.4 in this report

Unless otherwise stated the results shown in this test report refer only to the sample(s) tested and such sample(s) are retained for 90 days only.

除非另有說明，此報告結果僅對測試之樣品負責，同時此樣品僅保留90天。本報告未經本公司書面許可，不可部份複製。

This document is issued by the Company subject to its General Conditions of Service printed overleaf, available on request or accessible at www.sgs.com/terms_and_conditions.htm and for electronic format documents, subject to Terms and Conditions for Electronic Documents at www.sgs.com/terms_e-document.htm. Attention is drawn to the limitation of liability, indemnification and jurisdiction issues defined therein. Any holder of this document is advised that information contained hereon reflects the Company's findings at the time of its intervention only and within the limits of Client's instructions, if any. The Company's sole responsibility is to its Client and this document does not exonerate parties to a transaction from exercising all their rights and obligations under the transaction documents. This document cannot be reproduced except in full, without prior written approval of the Company. Any unauthorized alteration, forgery or falsification of the content or appearance of this document is unlawful and offenders may be prosecuted to the fullest extent of the law.

11.5. Measurement Result:

Reference Frequency: GSM 850 Mid Channel 836.6 MHz @ 25°C				
Limit: +/- 2.5 ppm = 2091 Hz				
Power Supply	Environment	Frequency	Delta (Hz)	Limit (Hz)
Vdc	Temperature (°C)	(MHz)		
3.7	-30	836.599990	15.00	2091
3.7	-20	836.599991	14.00	2091
3.7	-10	836.599993	12.00	2091
3.7	0	836.599998	7.00	2091
3.7	10	836.599998	7.00	2091
3.7	20	836.600010	-5.00	2091
3.7	30	836.600005	0.00	2091
3.7	40	836.600011	-6.00	2091
3.7	50	836.600015	-10.00	2091

Reference Frequency: GSM 1900 Mid Channel 1880 MHz @ 25°C				
Limit: +/- 2.5 ppm = 4700 Hz				
Power Supply	Environment	Frequency	Delta (Hz)	Limit (Hz)
Vdc	Temperature (°C)	(MHz)		
3.7	-30	1880.000011	-16.00	4700
3.7	-20	1880.000001	-15.00	4700
3.7	-10	1880.000009	-14.00	4700
3.7	0	1880.000005	-10.00	4700
3.7	10	1880.000001	-15.00	4700
3.7	20	1879.999990	5.00	4700
3.7	30	1879.999995	0.00	4700
3.7	40	1879.999998	-3.00	4700
3.7	50	1879.999999	-4.00	4700

Note: The battery is rated 3.7V dc.

Unless otherwise stated the results shown in this test report refer only to the sample(s) tested and such sample(s) are retained for 90 days only.

除非另有說明，此報告結果僅對測試之樣品負責，同時此樣品僅保留90天。本報告未經本公司書面許可，不可部份複製。

This document is issued by the Company subject to its General Conditions of Service printed overleaf, available on request or accessible at www.sgs.com/terms_and_conditions.htm and for electronic format documents, subject to Terms and Conditions for Electronic Documents at www.sgs.com/terms_e-document.htm. Attention is drawn to the limitation of liability, indemnification and jurisdiction issues defined therein. Any holder of this document is advised that information contained hereon reflects the Company's findings at the time of its intervention only and within the limits of Client's instructions, if any. The Company's sole responsibility is to its Client and this document does not exonerate parties to a transaction from exercising all their rights and obligations under the transaction documents. This document cannot be reproduced except in full, without prior written approval of the Company. Any unauthorized alteration, forgery or falsification of the content or appearance of this document is unlawful and offenders may be prosecuted to the fullest extent of the law.

SGS Taiwan Ltd. No.134, Wu Kung Road, Wuku Industrial Zone, Taipei County, Taiwan / 台北縣五股工業區五工路 134 號

台灣檢驗科技股份有限公司 t (886-2) 2299-3279

f (886-2) 2298-0488

www.tw.sgs.com

Member of SGS Group

Reference Frequency: WCDMA IV Mid Channel 1732.6(ARFCN1413) MHz @ 25°C				
Limit: +/- 2.5 ppm = 4331 Hz				
Power Supply	Environment	Frequency	Delta (Hz)	Limit (Hz)
Vdc	Temperature (°C)	(MHz)		
3.7	-30	1732.600010	-6.00	4331
3.7	-20	1732.600005	-1.00	4331
3.7	-10	1732.600003	1.00	4331
3.7	0	1732.600001	3.00	4331
3.7	10	1732.600000	4.00	4331
3.7	20	1732.600004	0.00	4331
3.7	30	1732.600002	2.00	4331
3.7	40	1732.600003	1.00	4331
3.7	50	1732.600005	-1.00	4331

Note: The battery is rated 3.7V dc.

Unless otherwise stated the results shown in this test report refer only to the sample(s) tested and such sample(s) are retained for 90 days only.

除非另有說明，此報告結果僅對測試之樣品負責，同時此樣品僅保留90天。本報告未經本公司書面許可，不可部份複製。

This document is issued by the Company subject to its General Conditions of Service printed overleaf, available on request or accessible at www.sgs.com/terms_and_conditions.htm and for electronic format documents, subject to Terms and Conditions for Electronic Documents at www.sgs.com/terms_e-document.htm. Attention is drawn to the limitation of liability, indemnification and jurisdiction issues defined therein. Any holder of this document is advised that information contained hereon reflects the Company's findings at the time of its intervention only and within the limits of Client's instructions, if any. The Company's sole responsibility is to its Client and this document does not exonerate parties to a transaction from exercising all their rights and obligations under the transaction documents. This document cannot be reproduced except in full, without prior written approval of the Company. Any unauthorized alteration, forgery or falsification of the content or appearance of this document is unlawful and offenders may be prosecuted to the fullest extent of the law.

12. FREQUENCY STABILITY V.S. VOLTAGE MEASUREMENT

12.1. Standard Applicable:

According to FCC §2.1055(a) (1)

Frequency Tolerance: +/-2.5ppm for 850MHz band

+/-2.5ppm for 1900MHz band

§27.54: The frequency stability shall be sufficient to ensure that the fundamental emissions stay within the authorized bands of operation.

12.2. Test Set-up:

Refer to section 10.2 in this report

12.3. Measurement Procedure:

Set chamber temperature to 25°C. Use a variable AC power supply / DC power source to power the EUT and set the voltage to rated voltage. Set the spectrum analyzer RBW low enough to obtain the desired frequency resolution and recorded the frequency.

Reduce the input voltage to specified extreme voltage variation (+/- 15%) and endpoint, record the maximum frequency change.

12.4. Measurement Equipment Used:

Refer to section 2.4 in this report

Unless otherwise stated the results shown in this test report refer only to the sample(s) tested and such sample(s) are retained for 90 days only.

除非另有說明，此報告結果僅對測試之樣品負責，同時此樣品僅保留90天。本報告未經本公司書面許可，不可部份複製。

This document is issued by the Company subject to its General Conditions of Service printed overleaf, available on request or accessible at www.sgs.com/terms_and_conditions.htm and for electronic format documents, subject to Terms and Conditions for Electronic Documents at www.sgs.com/terms_e-document.htm. Attention is drawn to the limitation of liability, indemnification and jurisdiction issues defined therein. Any holder of this document is advised that information contained hereon reflects the Company's findings at the time of its intervention only and within the limits of Client's instructions, if any. The Company's sole responsibility is to its Client and this document does not exonerate parties to a transaction from exercising all their rights and obligations under the transaction documents. This document cannot be reproduced except in full, without prior written approval of the Company. Any unauthorized alteration, forgery or falsification of the content or appearance of this document is unlawful and offenders may be prosecuted to the fullest extent of the law.

12.5. Measurement Result:

Reference Frequency: GSM 850 Mid Channel 836.6 MHz @ 25°C				
Limit: +/- 2.5 ppm = 2091 Hz				
Power Supply	Environment	Frequency	Delta (Hz)	Limit (Hz)
Vdc	Temperature (°C)	(MHz)		
4.26	25.00	836.600008	2.00	2091.00
3.7	25.00	836.600010	0.00	2091.00
3.15	25.00	836.600004	6.00	2091.00
3.0 (End Point)	25.00	836.599998	12.00	2091.00

Reference Frequency: GSM 1900 Mid Channel 1880 MHz @ 25°C				
Limit: +/- 2.5 ppm = 4700 Hz				
Power Supply	Environment	Frequency	Delta (Hz)	Limit (Hz)
Vdc	Temperature (°C)	(MHz)		
4.26	25.00	1879.999994	-4.00	4700
3.7	25.00	1879.999990	0.00	4700
3.15	25.00	1879.999986	4.00	4700
3.0 (End Point)	25.00	1879.999980	10.00	4700

Reference Frequency: WCDMA IV Mid Channel 1732.6 MHz(ARFCN1413) @ 25°C				
Limit: +/- 2.5 ppm = 4331 Hz				
Power Supply	Environment	Frequency	Delta (Hz)	Limit (Hz)
Vdc	Temperature (°C)	(MHz)		
4.26	25.00	1732.6000010	3.00	4331
3.7	25.00	1732.6000040	0.00	4331
3.15	25.00	1732.6000020	2.00	4331
3.0 (End Point)	25.00	1732.6000050	-1.00	4331

Note: The battery is rated 3.7V dc.

Unless otherwise stated the results shown in this test report refer only to the sample(s) tested and such sample(s) are retained for 90 days only.

除非另有說明，此報告結果僅對測試之樣品負責，同時此樣品僅保留90天。本報告未經本公司書面許可，不可部份複製。

This document is issued by the Company subject to its General Conditions of Service printed overleaf, available on request or accessible at www.sgs.com/terms_and_conditions.htm and for electronic format documents, subject to Terms and Conditions for Electronic Documents at www.sgs.com/terms_e-document.htm. Attention is drawn to the limitation of liability, indemnification and jurisdiction issues defined therein. Any holder of this document is advised that information contained hereon reflects the Company's findings at the time of its intervention only and within the limits of Client's instructions, if any. The Company's sole responsibility is to its Client and this document does not exonerate parties to a transaction from exercising all their rights and obligations under the transaction documents. This document cannot be reproduced except in full, without prior written approval of the Company. Any unauthorized alteration, forgery or falsification of the content or appearance of this document is unlawful and offenders may be prosecuted to the fullest extent of the law.

SGS Taiwan Ltd. No.134, Wu Kung Road, Wuku Industrial Zone, Taipei County, Taiwan / 台北縣五股工業區五工路 134 號

台灣檢驗科技股份有限公司 t (886-2) 2299-3279

f (886-2) 2298-0488

www.tw.sgs.com

Member of SGS Group