

# Regulatory WLAN Antenna Information (Template)

*English Language Required for Intel Regulatory Review / Approval*

**(OEM/ODM or antenna vendor is required to complete this document with platform antenna information.**

**Remove Intel references and make this your own document)**

Platform information										
Brand	ODM	****End product model name	Intel platform (ex: Yes, No or NA)	Platform type (ex: regular NB, convertible PC, AIO...etc)	*SAR minimum separation (mm)					
DELL	Compal	T06H	Yes	Tablet Computer	10.9					
****Please fill in exact product model name and make sure the model name is visible on product cover or any parts for end users recognize for authority inspection.										
Antenna information										
Vendor		Type	Antenna Part number (Main)			Antenna Part number (Aux)				
Hong-BO Co., Ltd.		PIFA	350-24020 (DC33002PC7L)			350-24019 (DC33002PC8L)				
Peak gain w/ cable loss (dBi)*										
	2.4GHz 2400-2483.5 MHz	5.2GHz 5150-5250MHz	5.3GHz 5250-5350MHz	5.6GHz 5470-5725MHz	5.8GHz 5725-5850MHz	6.2GHz 5925-6425MHz	6.5GHz 6425-6525MHz	6.7GHz 6525-6875MHz	7.0 GHz 6875-7125MHz	
Main	0.48	1.43	1.81	1.52	1.56	1.70	1.11	0.11	1.45	
Aux	0.89	2.21	2.04	1.58	2.04	2.19	1.69	1.28	0.50	
Intel Reference Gain/Type/ Separation distance										
Antenna Type	Antenna Peak gain (In dBi)*									Distance to the end user (mm)
	2.4GHz 2400-2483.5 MHz	5.2GHz 5150-5250MHz	5.3GHz 5250-5350MHz	5.6GHz 5470-5725MHz	5.8GHz 5725-5850MHz	6.2GHz 5925-6425MHz	6.5GHz 6425-6525MHz	6.7GHz 6525-6875MHz	7.0GHz 6875-7125MHz	
Design	3.00	5.00	5.00	5.00	5.00	5.00	5.00	5.00	5.00	Generic: refer to modular FCC SAR report Mid-power: ≥ 8 mm Low power: ≥ 5 mm
PIFA	3.24	3.64	3.73	4.77	4.97	4.83	4.30	5.37	5.59	
Dipole	2.89	2.92	3.19	4.41	4.22	4.83	4.30	4.49	5.34	
Notes (marked with *)										
* SAR minimum separation (mm)										
- Regular NB: Minimum antenna-to-body (from antenna bottom to the bottom of the device)										
- Tablet / Convertible PC: Minimum antenna-to-edge (5 sides of the device)										
- Mini-tablet: Minimum antenna-to-edge (6 sides of the device)										
* 3D Peak Antenna gain should be equal or greater than -2 dBi										
- If a host integrator plans to use a lower gain antenna of the same type, additional CBP(FCC)/EDT(EU) testing need to be performed while the module is installed in the host.										

# Table of contents

1. Applicable test method
2. Test & System Description
  - a. Test setup
  - b. Equipment list
3. Setup photo

[Section 1. Antenna Assembly Specifications](#)

[Section 2. Dimensioned Photos or Drawings of Antennas](#)

[Section 3. Radiation characteristics of antenna loaded in Host Platform](#)

[Section 4. Antenna Host Platform Location Information](#)

[Section 5. Antenna dimensional information for SAR evaluation](#)

[Section 6. Diagram Example of Co-Location Antenna Separation](#)

1. **Applicable test methods**

<insert test description here for test method>

This test report is prepared for host antenna testing under a Full Anechoic Chamber.

2. **Test & System Description**

a. Test setup

<insert test diagram here for test site utilized>

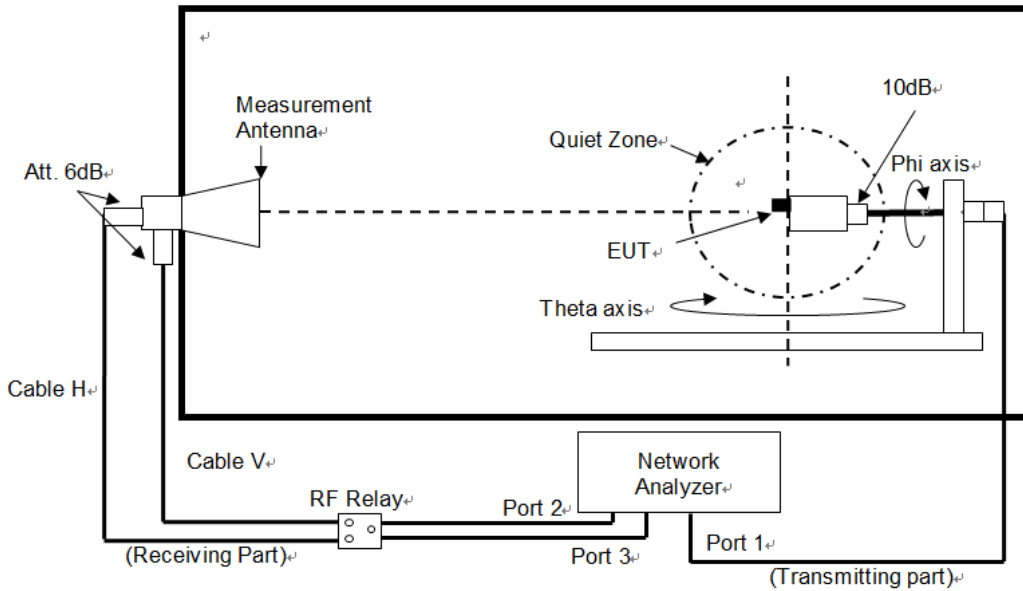

## b. Equipment list

<insert test diagram here for test site utilized>

Device	Type/Model	Serial #	Manufacturer	Cal. Date	Cal. Due Date
Anechoic Chamber	AMS8500	-	ETS-Lindgren	22-Jun-22	10-Jul-24
Turn Table	2117-7200	SN00231447	ETS-Lindgren	22-Jun-22	10-Jul-24
Switch & Positioning systems	EMCenter	SN00242606	ETS-Lindgren	22-Jun-22	10-Jul-24
Measurement SW	EMQuest V1.15 build 27347	SN1802	ETS-Lindgren	22-Jun-22	10-Jul-24
Horn antenna	3164-10	SN00246202	ETS-Lindgren	22-Jun-22	10-Jul-24
Vector Network Analyzer	E5071C	PN5188-4462	Keysight	30-May-22	30-Nov-23
Cable 7.5m 400MHz to 18GHz(H-pol)	SS402	00100A1F5A1XXS	WOKEN	22-Jun-22	10-Nov-24
Cable 7.5m 400MHz to 18GHz(V-pol)	SS402	00100A1F5A1XXS	WOKEN	22-Jun-22	10-Nov-24
Cable 14m 400MHz to 18GHz	SS402	00100A1F5A1XXS	WOKEN	22-Jun-22	10-Nov-24
Temp & Humidity Logger	830	SN84972	PROVA	16-Jul-22	10-Jul-23

**3. Setup photo**



# Antenna Information

## Section 1. Antenna Assembly Specifications

1A Antenna Part Number	1B Manufacturer	1C Antenna Type	1D Cable Assembly Part Number and Information	Freq Range MHz	1E * Peak Gain W/ Cable loss (dBi)	1F Peak Gain w/o Cable Loss (dBi)	1G Max VSWR	1H Cable Loss (dB)
<b>P/N:</b> <b>350-24020</b> <b>(DC33002PC7L)</b> <b>Main Antenna</b>	<b>Hong-BO Co., Ltd</b>	<b>PIFA</b>	<b>50 ohm Coaxial length: 121mm diameter: 1.13SLLS</b>	2400-2483.5	0.48	0.75	2.5	0.27
				5150-5250	1.43	1.85	2.5	0.42
				5250-5350	1.81	2.24	2.5	0.43
				5470-5725	1.52	1.96	2.5	0.44
				5725-5850	1.56	2.00	2.5	0.44
				5925-6425	1.70	2.16	2.5	0.46
				6425-6525	1.11	1.58	2.5	0.47
				6525-6875	0.11	0.59	2.5	0.48
				6875-7125	1.45	1.94	2.5	0.49
<b>P/N:</b> <b>350-24019</b> <b>(DC33002PC8L)</b> <b>Aux Antenna</b>	<b>Hong-BO Co., Ltd</b>	<b>PIFA</b>	<b>50 ohm Coaxial length: 236mm diameter: 1.13SLLS</b>	2400-2483.5	0.89	1.41	2.5	0.52
				5150-5250	2.21	3.00	2.5	0.79
				5250-5350	2.04	2.84	2.5	0.80
				5470-5725	1.58	2.40	2.5	0.82
				5725-5850	2.04	2.88	2.5	0.84
				5925-6425	2.19	3.06	2.5	0.87
				6425-6525	1.69	2.57	2.5	0.88
				6525-6875	1.28	2.19	2.5	0.91
				6875-7125	0.50	1.42	2.5	0.92

- 3D Antenna Peak Gain required being test in system basis.

## Section 2. Dimensioned Photos and Drawings of Antennas

Include the dimensioned photo and drawing of Main antenna here.

Main Antenna Dimensioned Drawing:

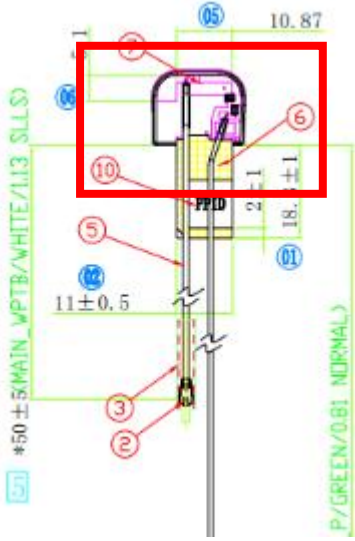

5

Main Antenna Photo (Front/Back):

Antenna Manufacturer: Hong-BO Co., Ltd.

Antenna Part Number: 350-24020 (DC32002PC7L) (Main), 350-24019 (DC32002PC8L) (Aux)

Include the dimensioned photo and drawing of Aux antenna here.

Aux Antenna Dimensioned Drawing:

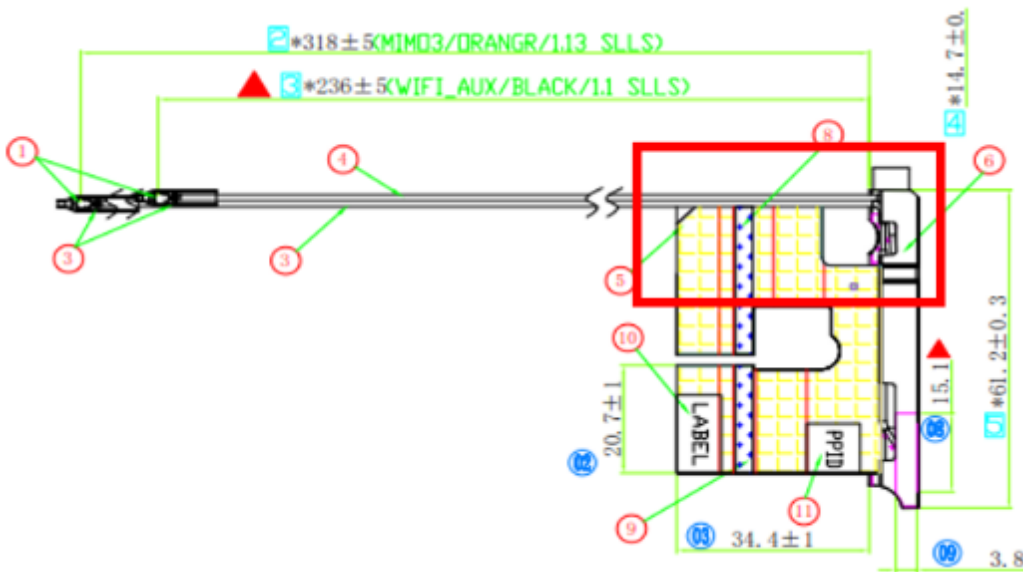

## Section 3. Radiation characteristics of antenna loaded in Host Platform

### Main Antenna

#### Max Antenna 3D Radiation Pattern 2400 – 2483.5 MHz

Frequency (MHz)	Peak Gain w/ Cable Loss (dBi)
2400-2483.5	0.48

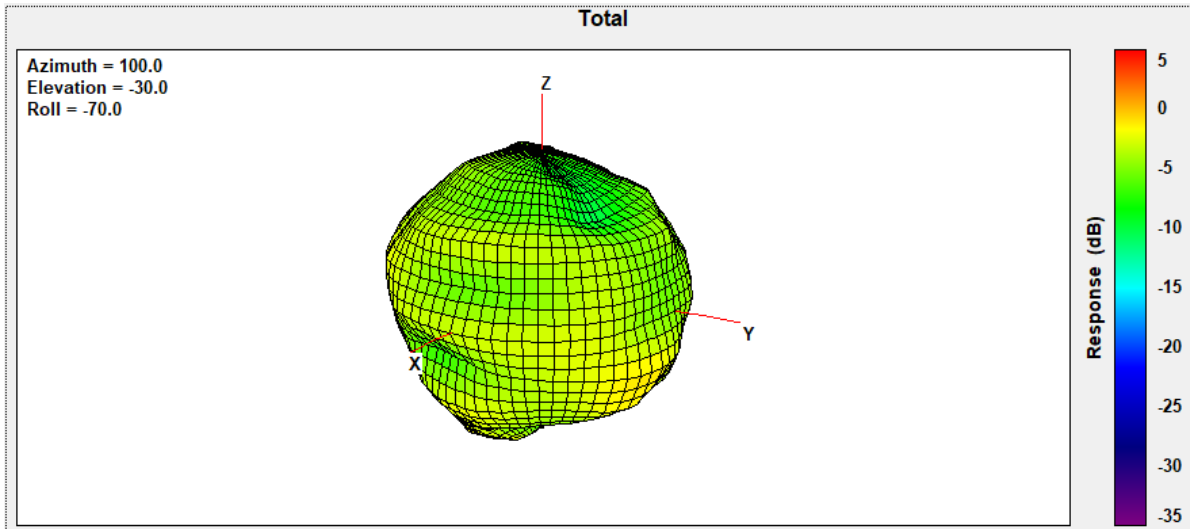

#### Max Antenna 3D Radiation Pattern 5150-5250 MHz

Frequency (MHz)	Peak Gain w/ Cable Loss (dBi)
5150-5250	1.43

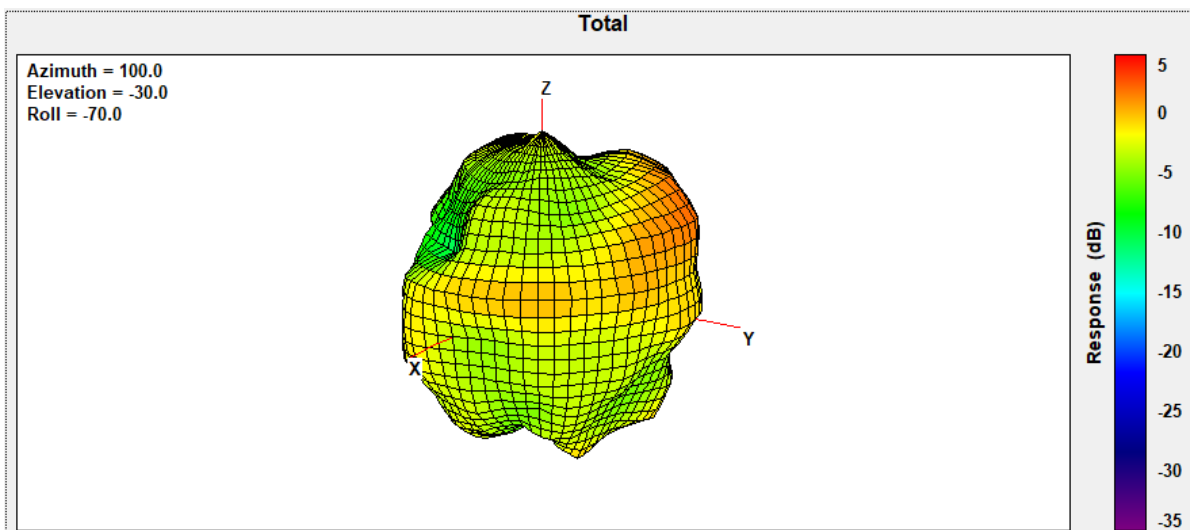



### Max Antenna 3D Radiation Pattern 5250-5350 MHz

Frequency (MHz)	Peak Gain w/ Cable Loss (dBi)
5250-5350	1.81

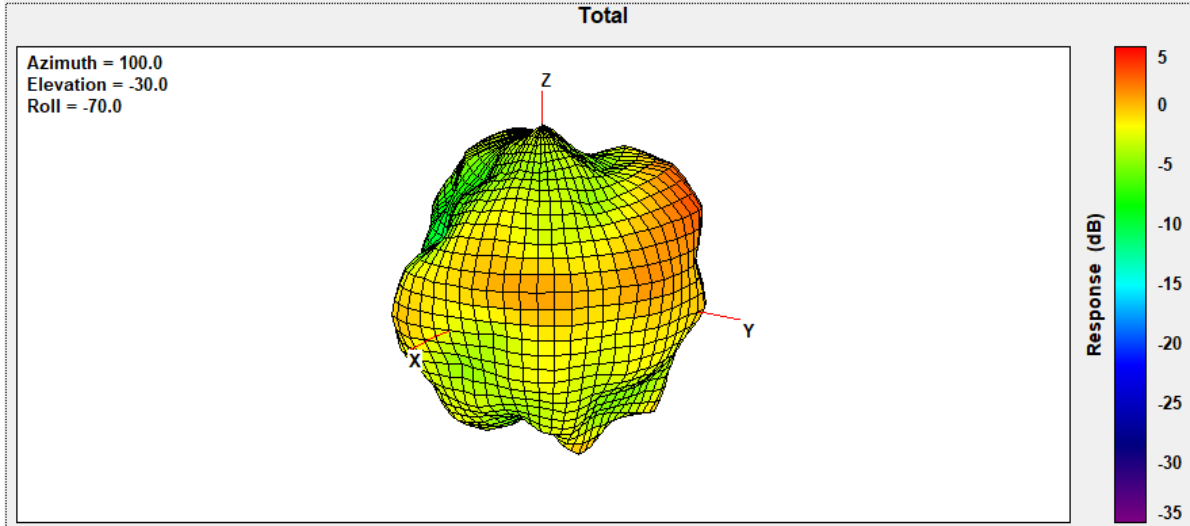

### Max Antenna 3D Radiation Pattern 5470-5725 MHz

Frequency (MHz)	Peak Gain w/ Cable Loss (dBi)
5470-5725	1.52

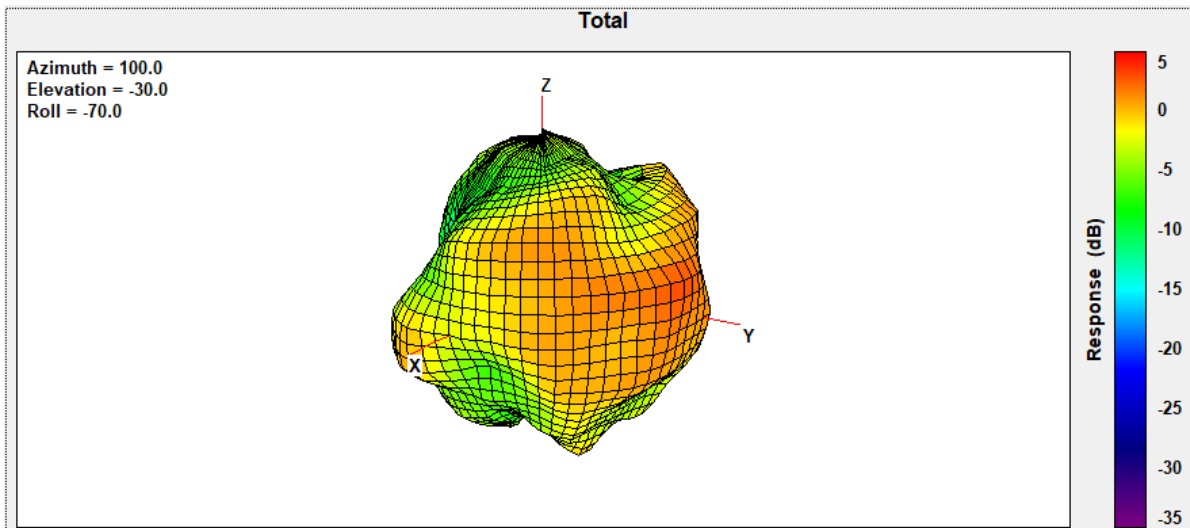

### Max Antenna 3D Radiation Pattern 5725-5850 MHz

Frequency (MHz)	Peak Gain w/ Cable Loss (dBi)
5725-5850	1.56

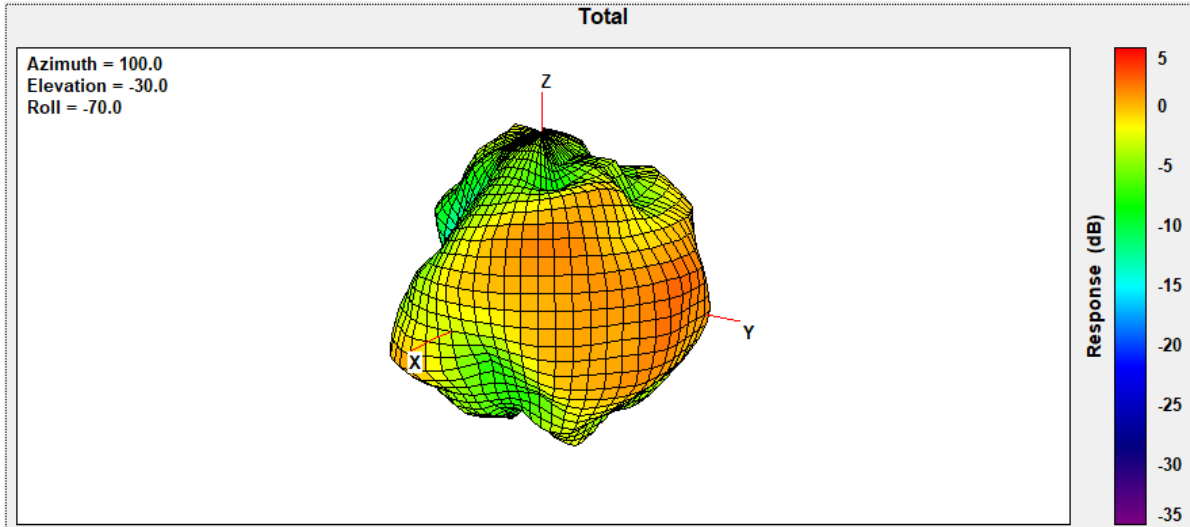

### Max Antenna 3D Radiation Pattern 5925-6425 MHz

Frequency (MHz)	Peak Gain w/ Cable Loss (dBi)
5925-6425	1.70

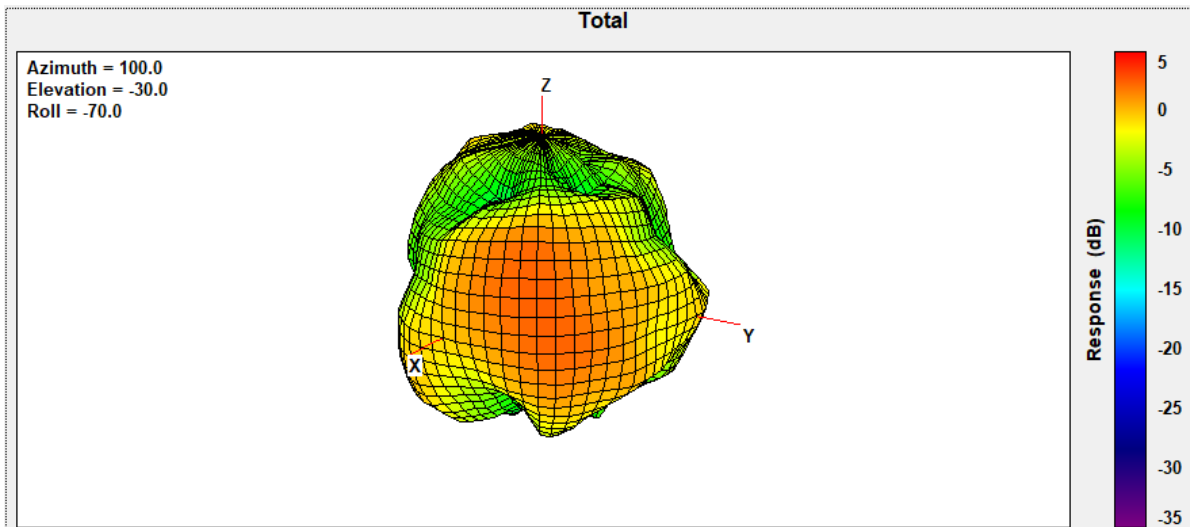

### Max Antenna 3D Radiation Pattern 6425-6525 MHz

Frequency (MHz)	Peak Gain w/ Cable Loss (dBi)
6425-6525	1.11

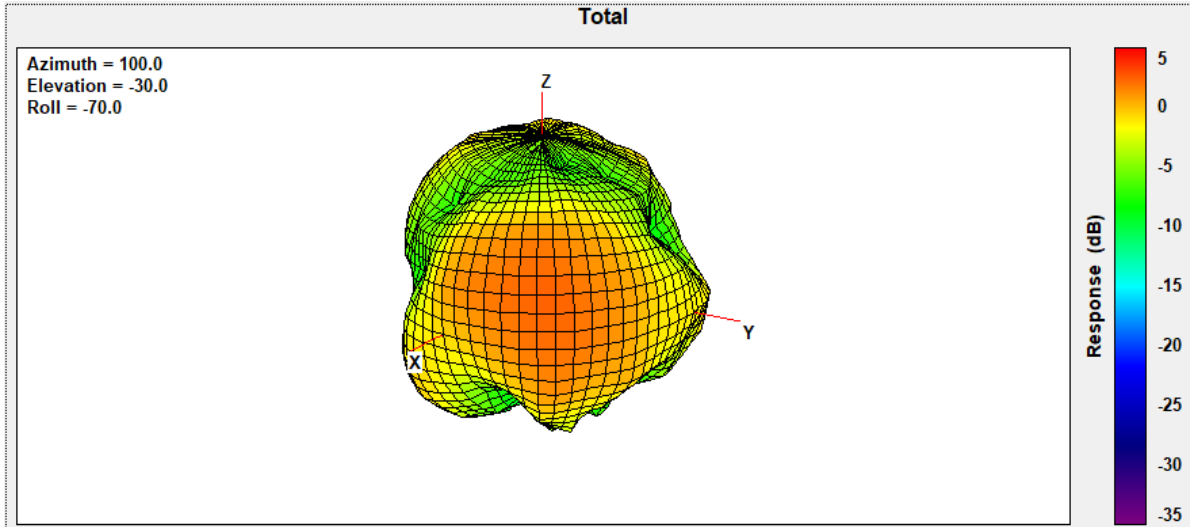

### Max Antenna 3D Radiation Pattern 6525-6875 MHz

Frequency (MHz)	Peak Gain w/ Cable Loss (dBi)
6525-6875	0.11

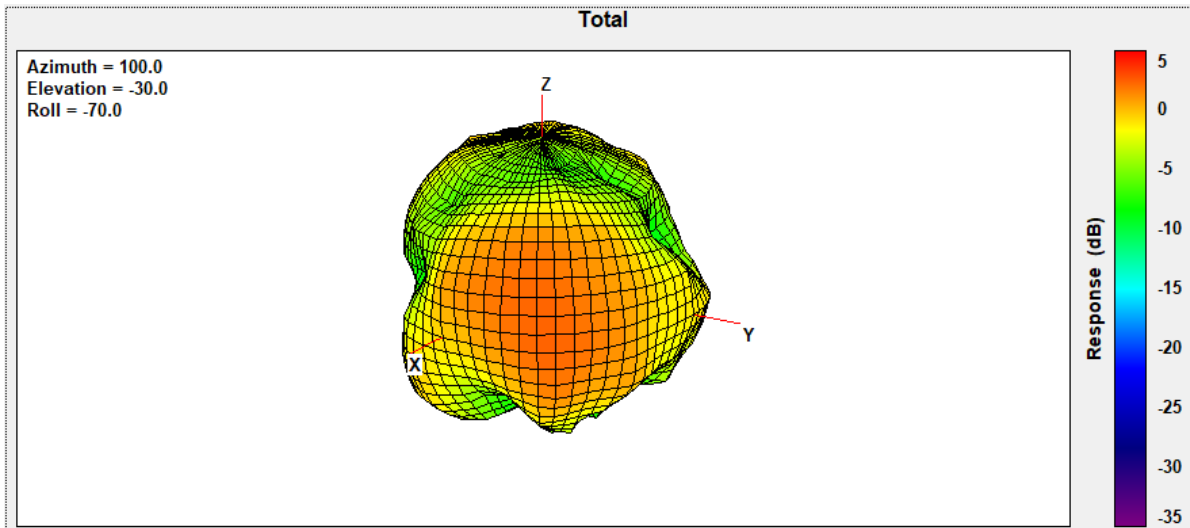

## Max Antenna 3D Radiation Pattern 6875-7125 MHz

Frequency (MHz)	Peak Gain w/ Cable Loss (dBi)
6875-7125	1.45

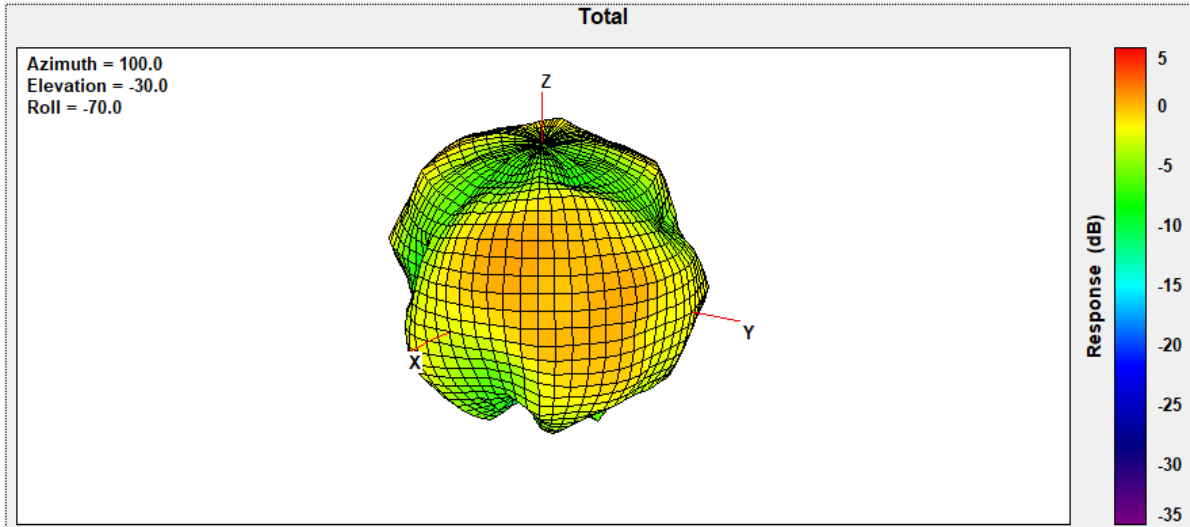

## Auxiliary Antenna

### Max Antenna 3D Radiation Pattern 2400 – 2483.5 MHz

Frequency (MHz)	Peak Gain w/ Cable Loss (dBi)
2400-2483.5	0.89

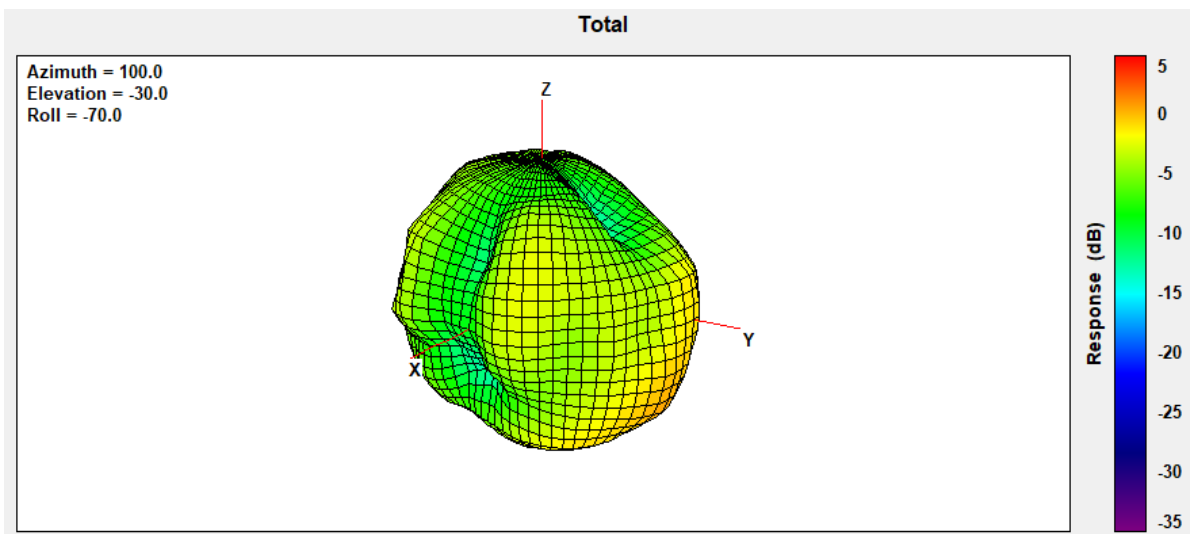

### Max Antenna 3D Radiation Pattern 5150-5250 MHz

Frequency (MHz)	Peak Gain w/ Cable Loss (dBi)
5150-5250	2.21

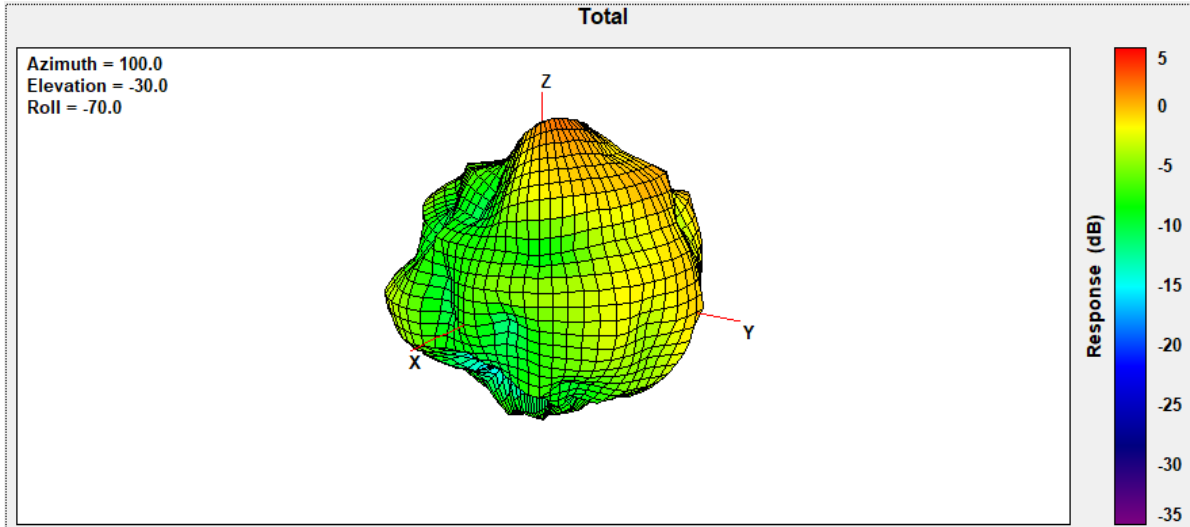

### Max Antenna 3D Radiation Pattern 5250-5350 MHz

Frequency (MHz)	Peak Gain w/ Cable Loss (dBi)
5250-5350	2.04

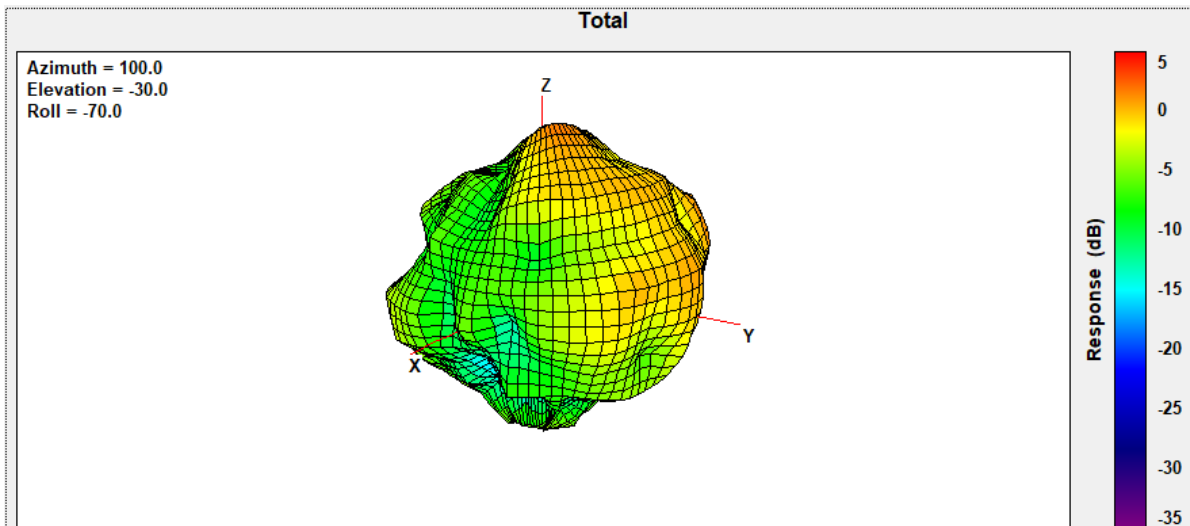

### Max Antenna 3D Radiation Pattern 5470-5725 MHz

Frequency (MHz)	Peak Gain w/ Cable Loss (dBi)
5470-5725	1.58

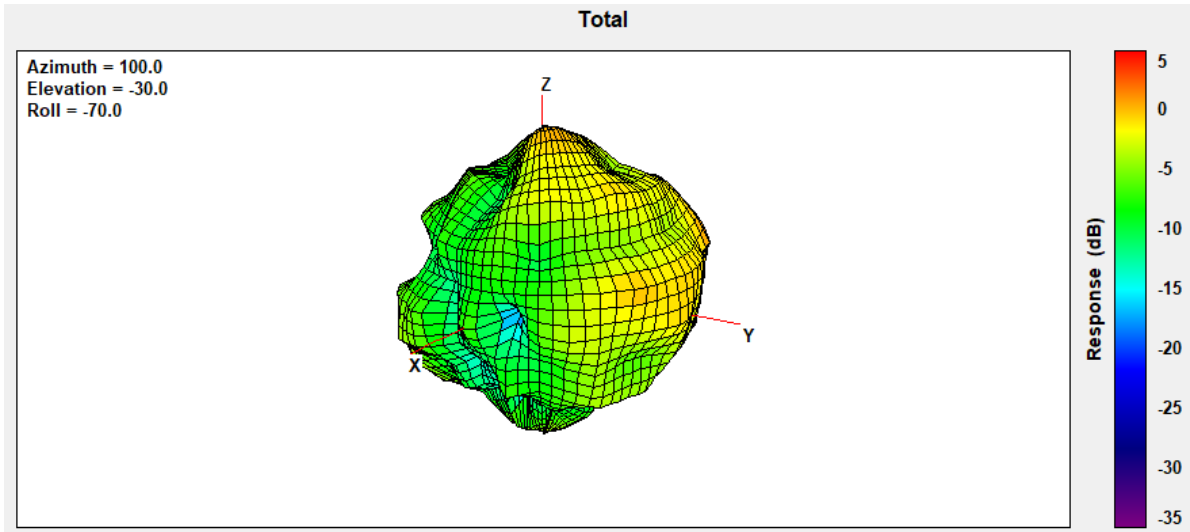

### Max Antenna 3D Radiation Pattern 5725-5850 MHz

Frequency (MHz)	Peak Gain w/ Cable Loss (dBi)
5725-5850	2.04

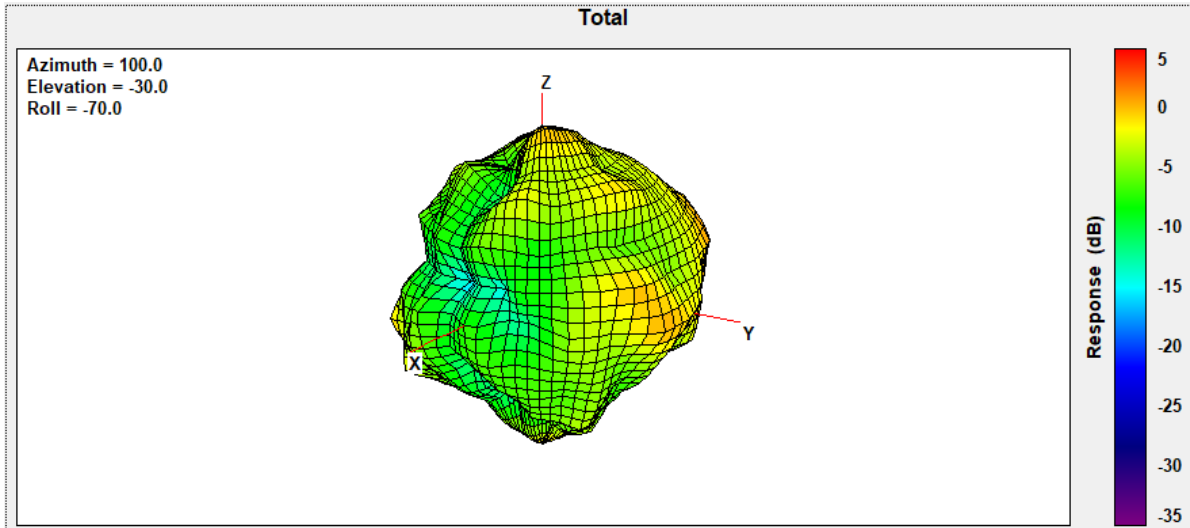

### Max Antenna 3D Radiation Pattern 5925-6425 MHz

Frequency (MHz)	Peak Gain w/ Cable Loss (dBi)
5925-6425	2.19

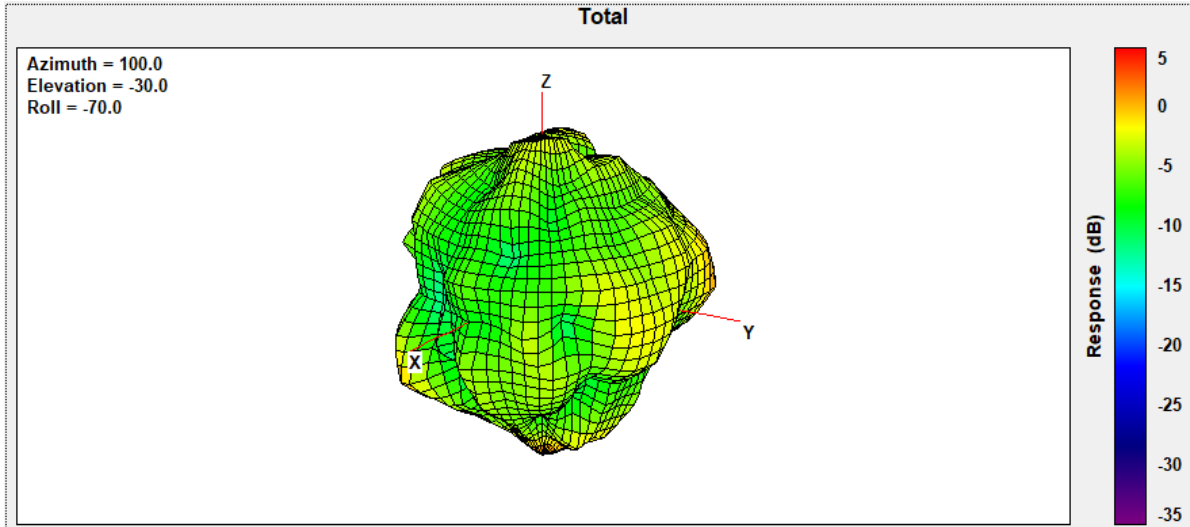

### Max Antenna 3D Radiation Pattern 6425-6525 MHz

Frequency (MHz)	Peak Gain w/ Cable Loss (dBi)
6425-6525	1.69

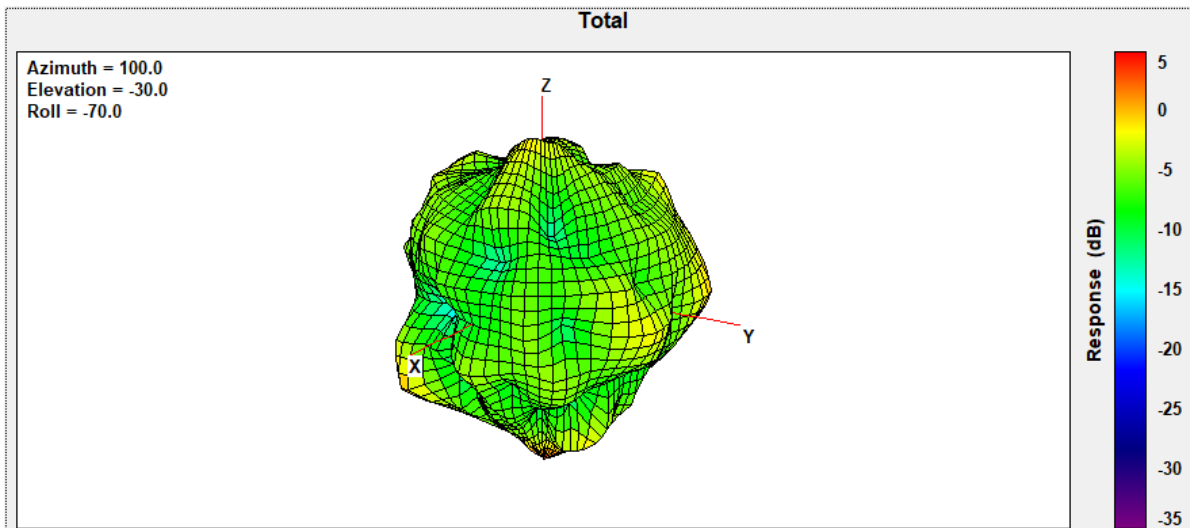

### Max Antenna 3D Radiation Pattern 6525-6875 MHz

Frequency (MHz)	Peak Gain w/ Cable Loss (dBi)
6525-6875	1.28

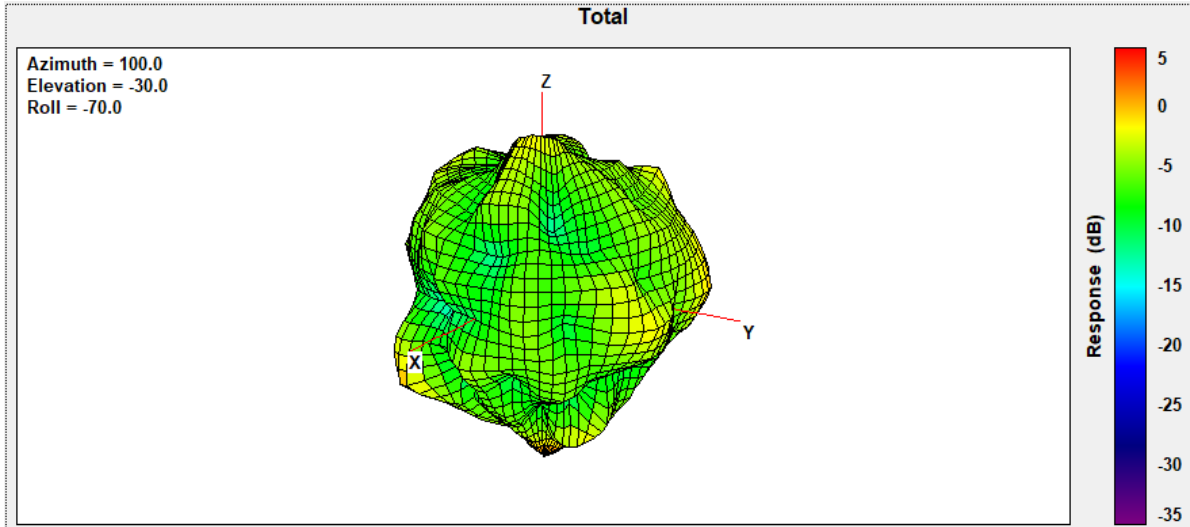

### Max Antenna 3D Radiation Pattern 6875-7125 MHz

Frequency (MHz)	Peak Gain w/ Cable Loss (dBi)
6875-7125	0.50

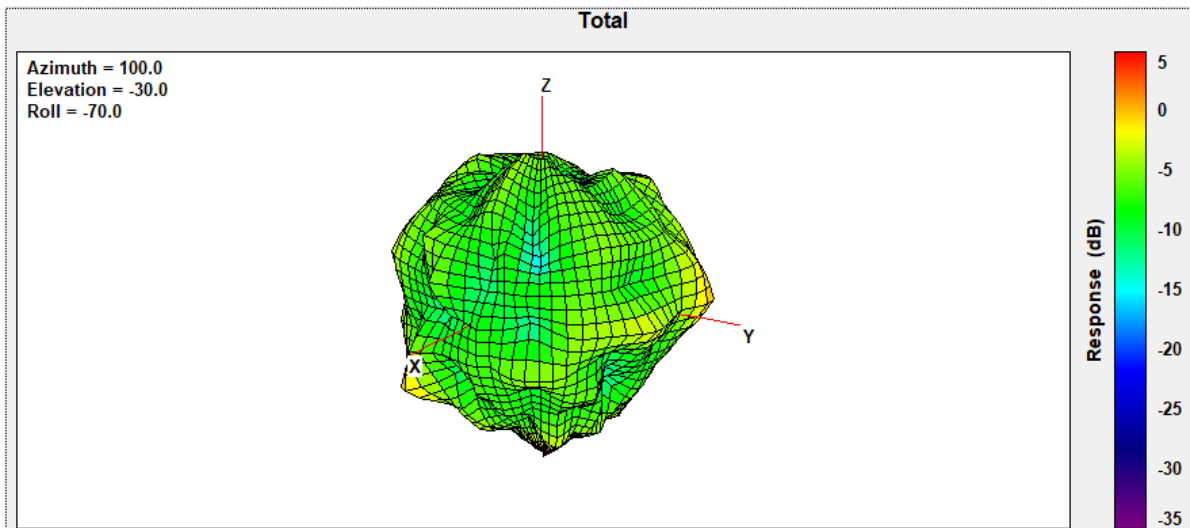



## Section 4. Antenna Host Platform Location Information

Include a **dimensioned photo(s) or dimensioned drawing(s)** of Main and Aux antenna placements (measurements are not required for receive-only antenna).

Any antenna that transmits must show dimensions to bottom of laptop. Provide a description of the materials that are used for supporting or surrounding transmit antennas; for example, non-conductive plastics vs. conductive coated plastic or metallic materials.

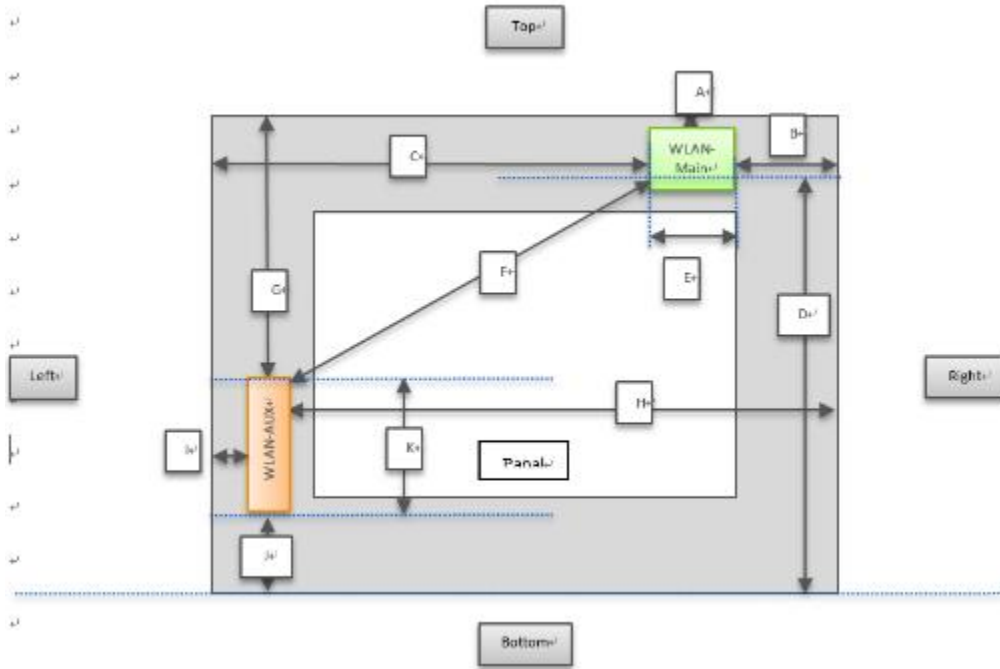

Minimum Separation Distance			
Item	Antenna	Position	Distance (mm)
A	WLAN-Main	to Top	15
B	WLAN-Main	to Right	26
C	WLAN-Main	to Left	256
D	WLAN-Main	to Bottom	186
E	WLAN-Main	Main Antenna Length	18
F	Main-Aux	Main to Aux	267
G	WLAN-Aux	to Top	130
H	WLAN-Aux	to Right	284.5
I	WLAN-Aux	to Left	4.1
J	WLAN-Aux	to Bottom	16.8
K	WLAN-Aux	Aux Antenna Length	61.2

<Tablet Mode(view from bottom)>

\*\*only Tablet/Detachable PC required to fill-in

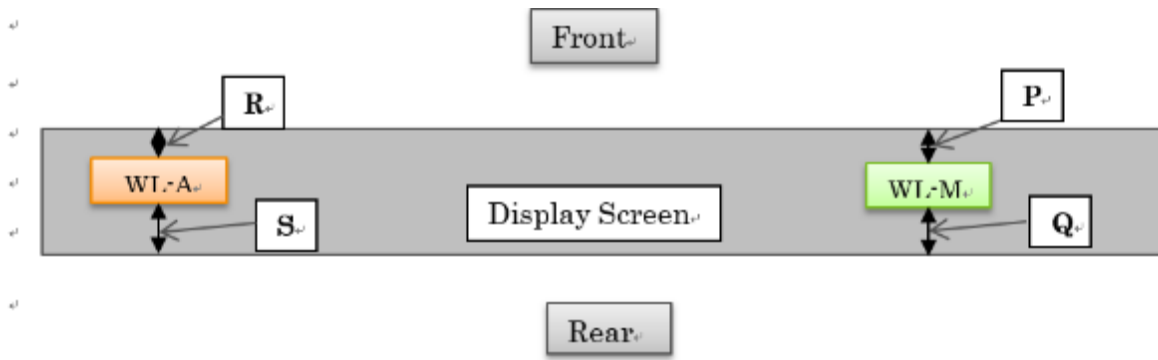

Minimum Separation Distance			
Item	Antenna	Position	Distance (mm)
P	WLAN-Main	to Front	2.5
Q	WLAN-Main	to Rear	10.9
R	WLAN-Aux	to Front	2.55
S	WLAN-Aux	to Rear	6.9

Section 5. Antenna dimensional information for SAR evaluation

Include a **dimensioned photo(s) or dimensioned drawing(s)** showing the distance (mm) between the transmit antennas and the user. For notebook/laptop hosts show lapheld position (example below). For tablet hosts show all orientations including lapheld, primary & secondary portrait, primary & secondary landscape positions. Include a description of any proximity sensors or power throttling implementations that limit or exclude use of any host orientation.

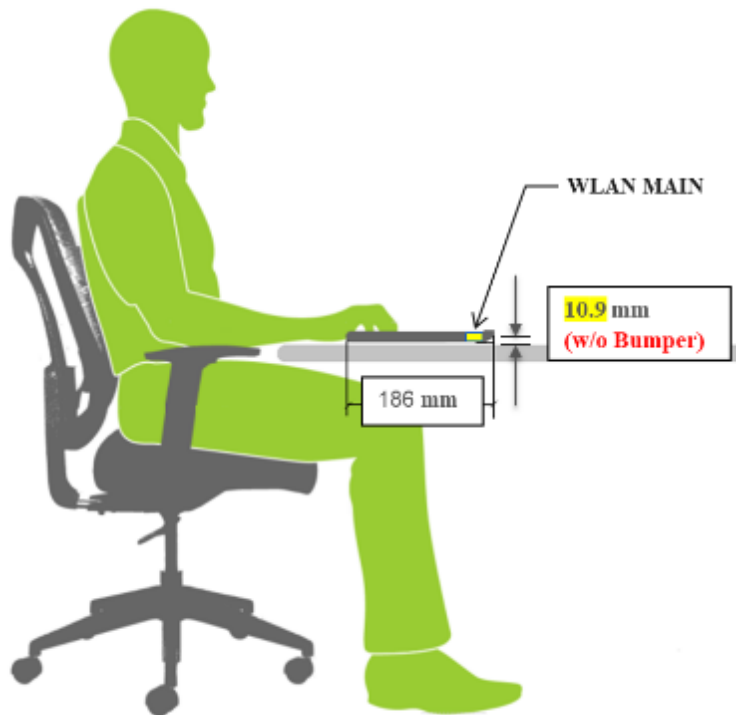

## Section 6. Diagram Example of Co-Location Antenna Separation

Include a **dimensioned photo or dimensioned drawing** showing the distance (mm) between **all WLAN transmit antennas** and other co-located radiator transmit antenna such as Bluetooth, WWAN,..

(Note: Due to the evolving rules regarding co-location, each platform will need to be reviewed on a case by case basis)

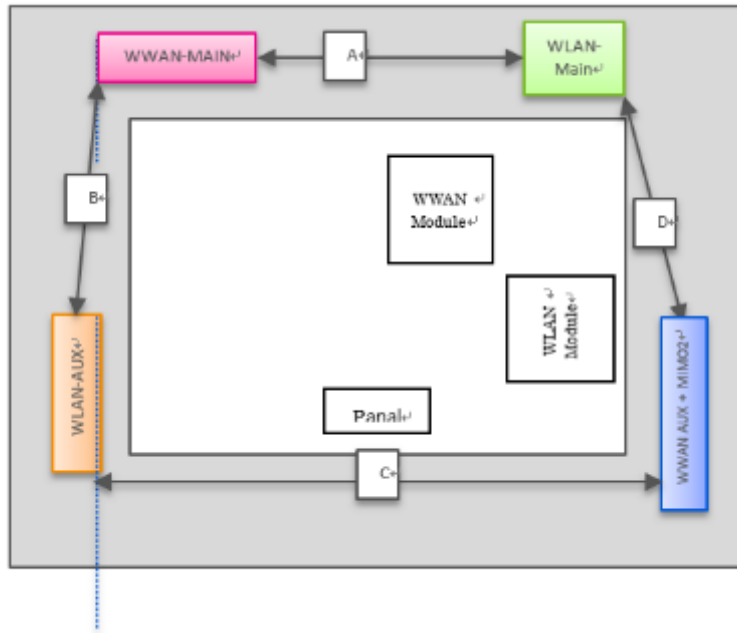

Minimum Separation Distance			
Item	Antenna	between	Distance (mm)
A	WLAN-Main	WWAN MAIN	147
B	WWAN-Main	WLAN -AUX	116
C	WLAN-Aux	MIMO2	268
D	MIMO2	WLAN-Main	92