

Regulatory WLAN Antenna Information (Template)

English Language Required for Intel Regulatory Review / Approval

(OEM/ODM or antenna vendor is required to complete this document with platform antenna information.)

Remove Intel references and make this your own document)

Platform information										
Brand	ODM	****End product model name	Intel platform (ex: Yes, No or NA)	Platform type (ex: regular NB, convertible PC, AIO...etc)	*SAR minimum separation (mm)					
DELL	Compal	P33T	Yes	Convertible PC	5.7					
****Please fill in exact product model name and make sure the model name is visible on product cover or any parts for end users recognize for authority inspection.										
Antenna information										
Vendor		Type	Antenna Part number (Main)			Antenna Part number (Aux)				
Hong-BO Wireless Communication Technology Co., LTD.		PIFA(TB Mode)	260-24415 DC33002R02L			260-24415 DC33002R02L				
Peak gain w/ cable loss (dBi)*										
	2.4GHz 2400-2483.5 MHz	5.2GHz 5150-5250MHz	5.3GHz 5250-5350MHz	5.6GHz 5470-5725MHz	5.8GHz 5725-5850MHz	6.2GHz 5925-6425MHz	6.5GHz 6425-6525MHz	6.7GHz 6525-6875MHz	7.0 GHz 6875-7125MHz	
Main	0.72	2.86	2.55	3.24	3.29	N/A	N/A	N/A	N/A	
Aux	-1.07	1.21	1.15	1.70	1.77	N/A	N/A	N/A	N/A	
Intel Reference Gain/Type/ Separation distance										
Antenna Type	Antenna Peak gain (In dBi)*									Distance to the end user (mm)
	2.4GHz 2400-2483.5 MHz	5.2GHz 5150-5250MHz	5.3GHz 5250-5350MHz	5.6GHz 5470-5725MHz	5.8GHz 5725-5850MHz	6.2GHz 5925-6425MHz	6.5GHz 6425-6525MHz	6.7GHz 6525-6875MHz	7.0GHz 6875-7125MHz	
Design	3.00	5.00	5.00	5.00	5.00	5.00	5.00	5.00	5.00	Generic: refer to modular FCC SAR report Mid-power: ≥ 8 mm Low power: ≥ 5 mm
PIFA	3.24	3.64	3.73	4.77	4.97	4.83	4.30	5.37	5.59	
Dipole	2.89	2.92	3.19	4.41	4.22	4.83	4.30	4.49	5.34	
Notes (marked with *)										
* SAR minimum separation (mm)										
- Regular NB: Minimum antenna-to-body (from antenna bottom to the bottom of the device)										
- Tablet / Convertible PC: Minimum antenna-to-edge (5 sides of the device)										
- Mini-tablet: Minimum antenna-to-edge (6 sides of the device)										
* 3D Peak Antenna gain should be equal or greater than -2 dBi										
- If a host integrator plans to use a lower gain antenna of the same type, additional CBP(FCC)/EDT(EU) testing need to be performed while the module is installed in the host.										

Table of contents

1. Applicable test method
2. Test & System Description
 - a. Test setup
 - b. Equipment list
3. Setup photo

Section 1. Antenna Assembly Specifications

Section 2. Dimensioned Photos or Drawings of Antennas

Section 3. Radiation characteristics of antenna loaded in Host Platform

Section 4. Antenna Host Platform Location Information

Section 5. Antenna dimensional information for SAR evaluation

Section 6. Diagram Example of Co-Location Antenna Separation

1. **Applicable test methods**

This test report is prepared for host antenna testing under a Full Anechoic Chamber.

2. **Test & System Description**

a. Test setup

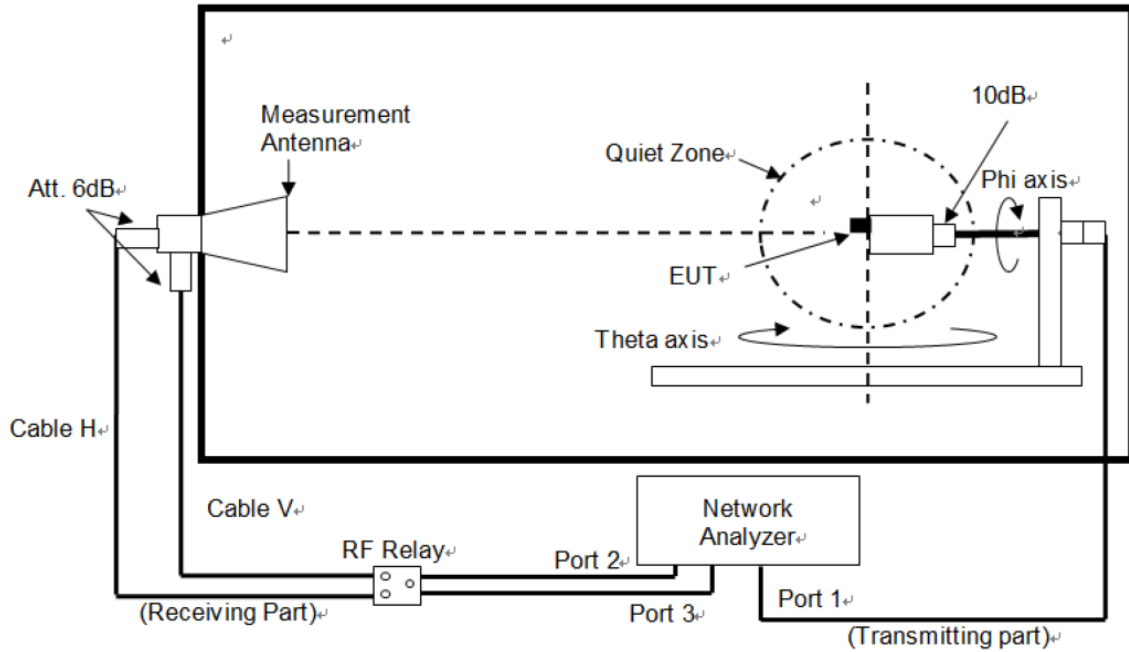

b. Equipment list

OTA03-HY					
Name	Manufacturer	Type/Model	Serial Number	Calibration	
				Last Cal.	Due Date
ENA Series Network Analyzer	Keysight	E5080B	MY59101211	2022/5/23	2023/5/22
RF Switch	Keysight	3499A	N/A	NCR	NCR
Multi-Axis Positioner Controller	ETS-Lindgren	2090	N/A	NCR	NCR
Medium-Duty Positioner	ETS-Lindgren	2015	N/A	NCR	NCR
Measurement Horn Antenna	EMCO	Aug-64	86722	NCR	NCR

3. Setup photo

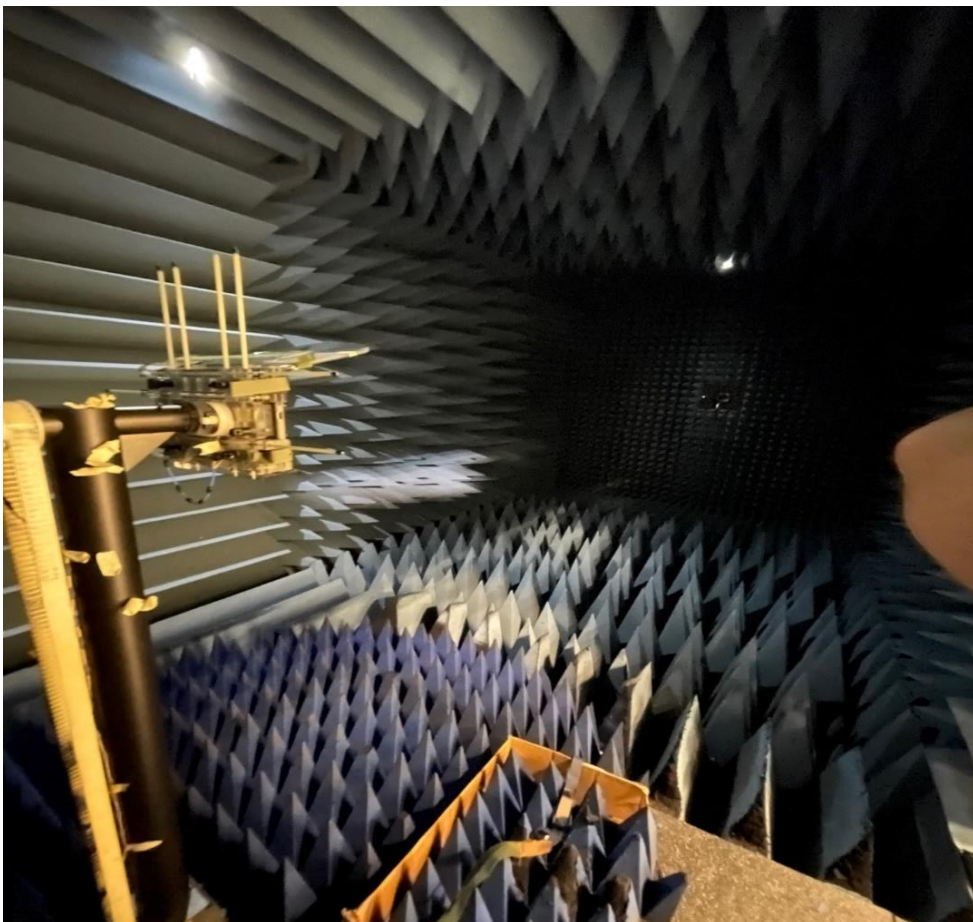
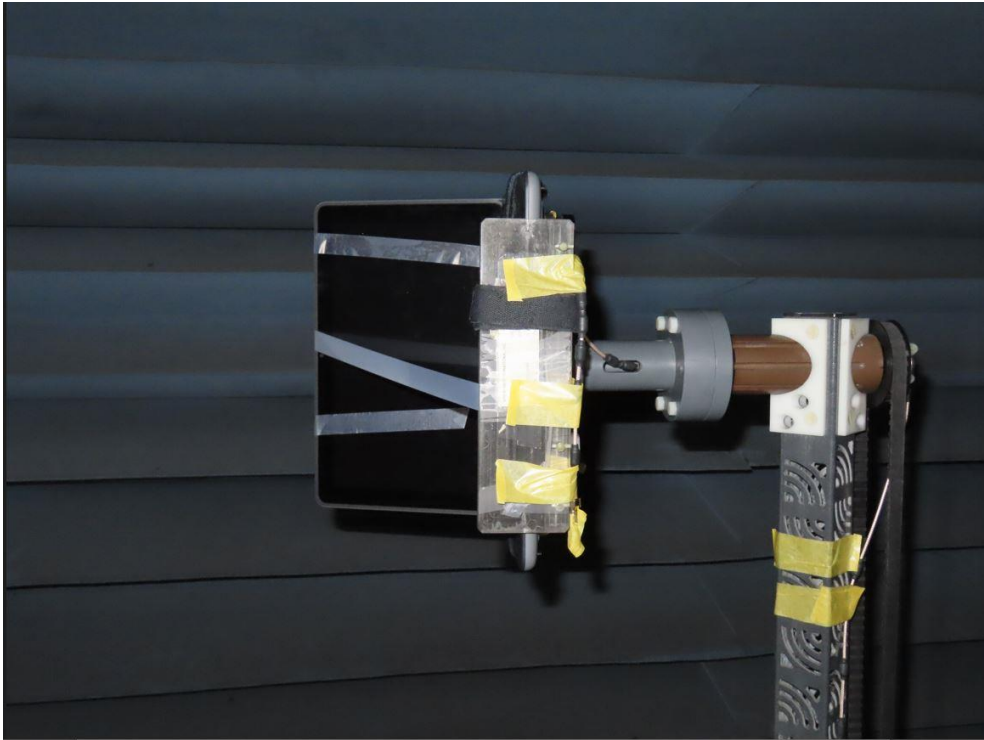

Antenna Information

Section 1. Antenna Assembly Specifications

1A	1B	1C	1D	1E	1F	1G	1H	
Antenna Part Number	Manufacturer	Antenna Type	Cable Assembly Part Number and Information	Freq Range MHz	* Peak Gain W/ Cable loss (dBi)	Peak Gain w/o Cable Loss (dBi)	Max VSWR	Cable Loss (dB)
Main Antenna Compal P/N DC33002R02L Hong-Bo P/N 260-24415	Hong-Bo Corporation	PIFA	Connector P/N: 20565-001R-13 50 ohm Coaxial length:233mm Diameter: 1.13mm	2400-2483.5	0.72	1.25	2.5	0.53
				5150-5250	2.86	3.66	2.5	0.80
				5250-5350	2.55	3.37	2.5	0.82
				5470-5725	3.24	4.08	2.5	0.84
				5725-5850	3.29	4.15	2.5	0.86
				5925-6425	N/A	N/A	N/A	N/A
				6425-6525	N/A	N/A	N/A	N/A
				6525-6875	N/A	N/A	N/A	N/A
Aux Antenna Compal P/N DC33002R02L Hong-Bo P/N 260-24415	Hong-Bo Corporation	PIFA	Connector P/N: 20565-001R-13 50 ohm Coaxial length: 475mm Diameter: 1.13mm	2400-2483.5	-1.07	0.01	2.5	1.08
				5150-5250	1.21	2.85	2.5	1.64
				5250-5350	1.15	2.82	2.5	1.67
				5470-5725	1.70	3.41	2.5	1.71
				5725-5850	1.77	3.51	2.5	1.74
				5925-6425	N/A	N/A	N/A	N/A
				6425-6525	N/A	N/A	N/A	N/A
				6525-6875	N/A	N/A	N/A	N/A
6875-7125	N/A	N/A	N/A	N/A				

- 3D Antenna Peak Gain required being test in system basis.

Section 2. Dimensioned Photos and Drawings of Antennas

Include the dimensioned photo and drawing of Main antenna here.

Main Antenna Drawing:

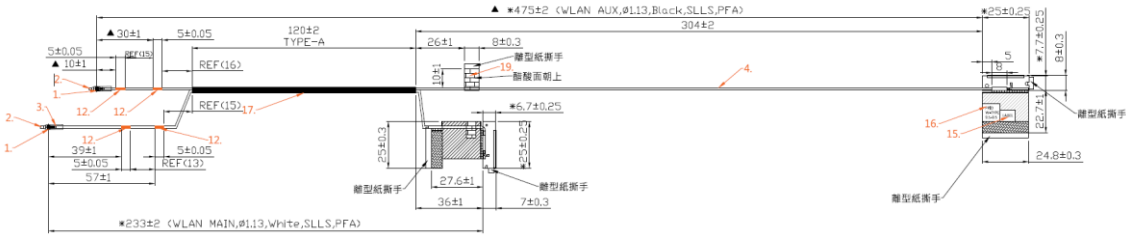

Include the dimensioned photo and drawing of Aux antenna here.

Aux Antenna Drawing:

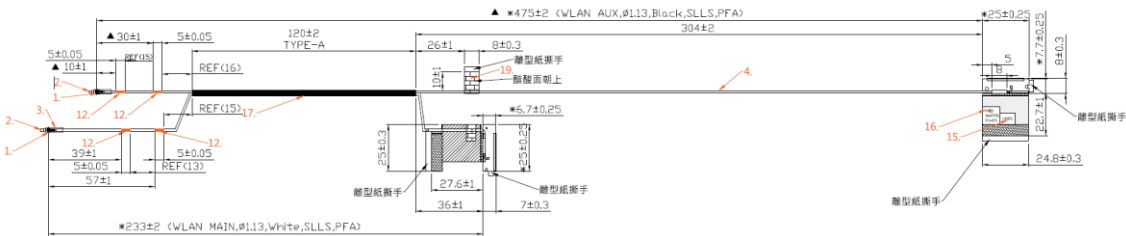

Section 3. Radiation characteristics of antenna loaded in Host Platform

Main Antenna

Max Antenna 3D Radiation Pattern 2400 – 2483.5 MHz

Frequency (MHz)	Peak Gain w/ Cable Loss (dBi)
2400-2483.5	0.72

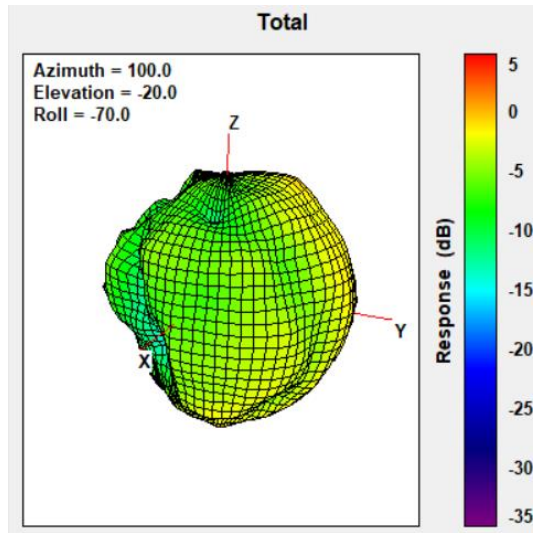

Max Antenna 3D Radiation Pattern 5150-5250 MHz

Frequency (MHz)	Peak Gain w/ Cable Loss (dBi)
5150-5250	2.86

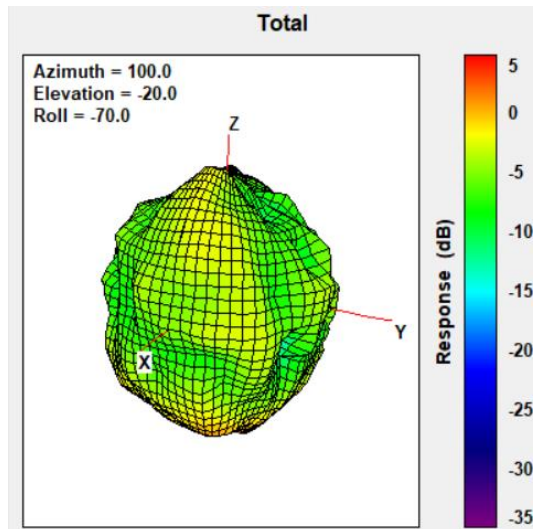

Max Antenna 3D Radiation Pattern 5250-5350 MHz

Frequency (MHz)	Peak Gain w/ Cable Loss (dBi)
5250-5350	2.55

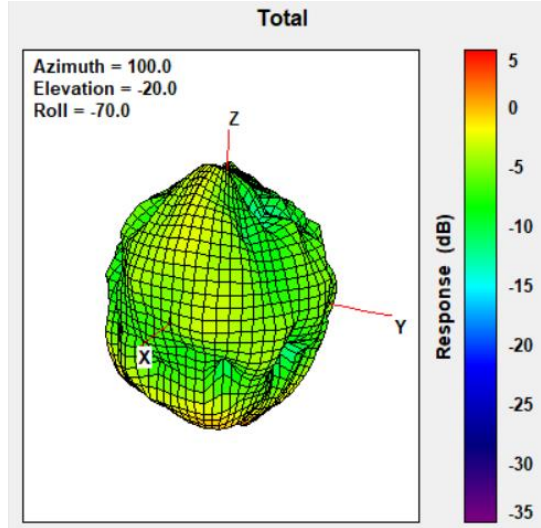

Max Antenna 3D Radiation Pattern 5470-5725 MHz

Frequency (MHz)	Peak Gain w/ Cable Loss (dBi)
5470-5725	3.24

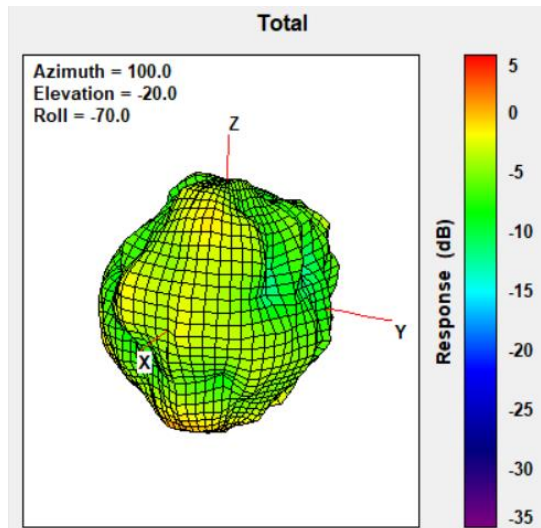

Max Antenna 3D Radiation Pattern 5725-5850 MHz

Frequency (MHz)	Peak Gain w/ Cable Loss (dBi)
5725-5850	3.29

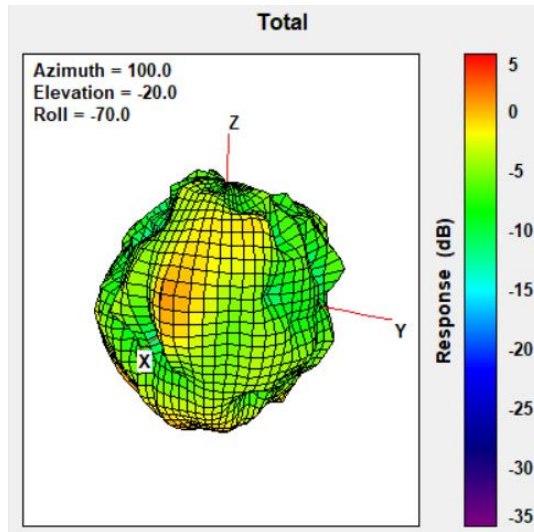

Auxiliary Antenna

Max Antenna 3D Radiation Pattern 2400 – 2483.5 MHz

Frequency (MHz)	Peak Gain w/ Cable Loss (dBi)
2400-2483.5	-1.07

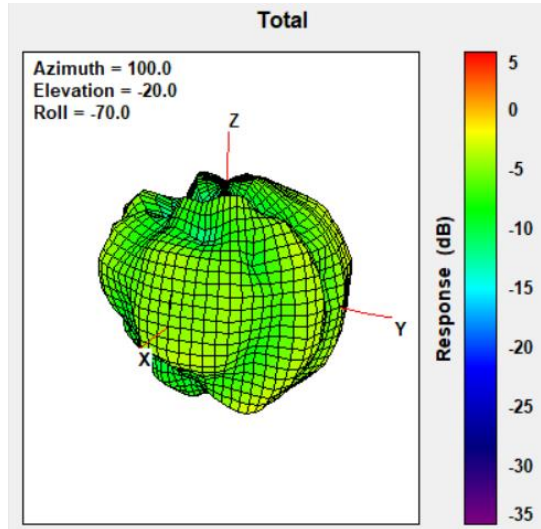

Max Antenna 3D Radiation Pattern 5150-5250 MHz

Frequency (MHz)	Peak Gain w/ Cable Loss (dBi)
5150-5250	1.21

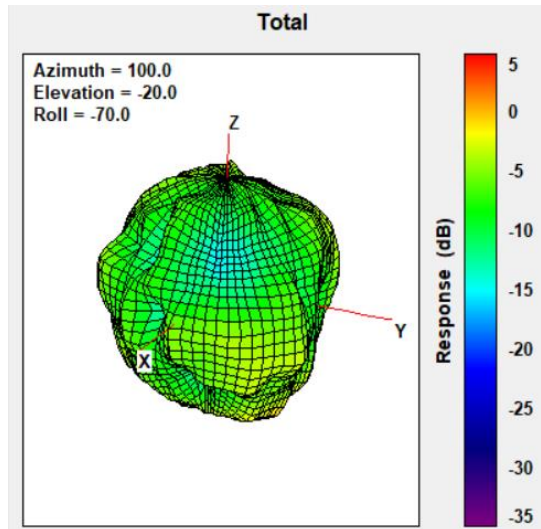

Max Antenna 3D Radiation Pattern 5250-5350 MHz

Frequency (MHz)	Peak Gain w/ Cable Loss (dBi)
5250-5350	1.15

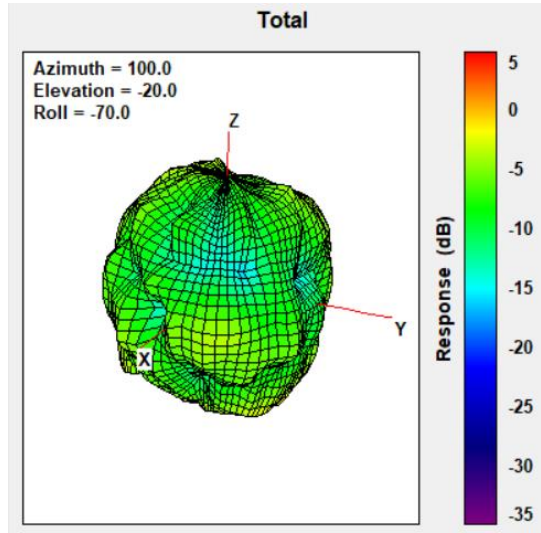

Max Antenna 3D Radiation Pattern 5470-5725 MHz

Frequency (MHz)	Peak Gain w/ Cable Loss (dBi)
5470-5725	1.70

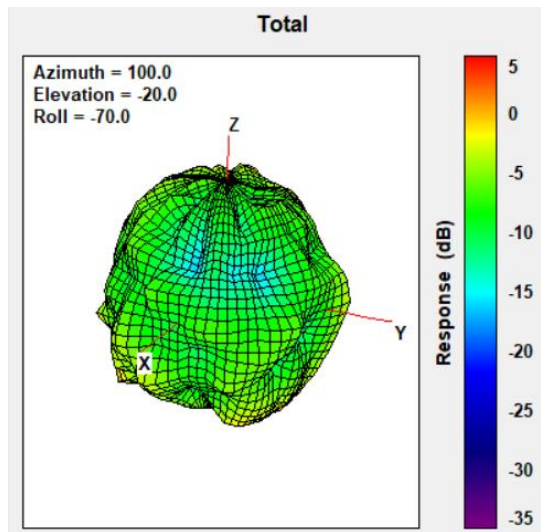

Max Antenna 3D Radiation Pattern 5725-5850 MHz

Frequency (MHz)	Peak Gain w/ Cable Loss (dBi)
5725-5850	1.77

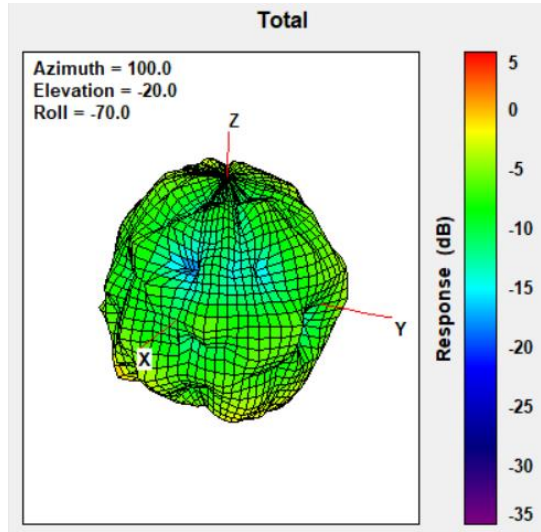

Section 4. Antenna Host Platform Location Information

Include a **dimensioned photo(s) or dimensioned drawing(s)** of Main and Aux antenna placements (measurements are not required for receive-only antenna).

Any antenna that transmits must show dimensions to bottom of laptop. Provide a description of the materials that are used for supporting or surrounding transmit antennas; for example, non-conductive plastics vs. conductive coated plastic or metallic materials.

Minimum Separation Distance

Item	Antenna	Position	Distance (mm)
A	WLAN-Aux	to Top	199.1
B	WLAN-Aux	to Right	287.6
C	WLAN-Aux	to Left	5.9
D	WLAN-Aux	to Bottom	5.7
E	WLAN-Aux	Aux Antenna Length	8
F	Main-Aux	Main to Aux	275
G	WLAN-Main	to Top	199.1
H	WLAN-Main	to Right	5.9
I	WLAN-Main	to Left	287.6
J	WLAN-Main	to Bottom	5.7
K	WLAN-Main	Main Antenna Length	7
L	NB	Bumper thickness	2.1
X	WLAN-Main	to User	27.5
Y	WLAN-Aux	to User	27.6
Z	NB	Keyboard depth	204

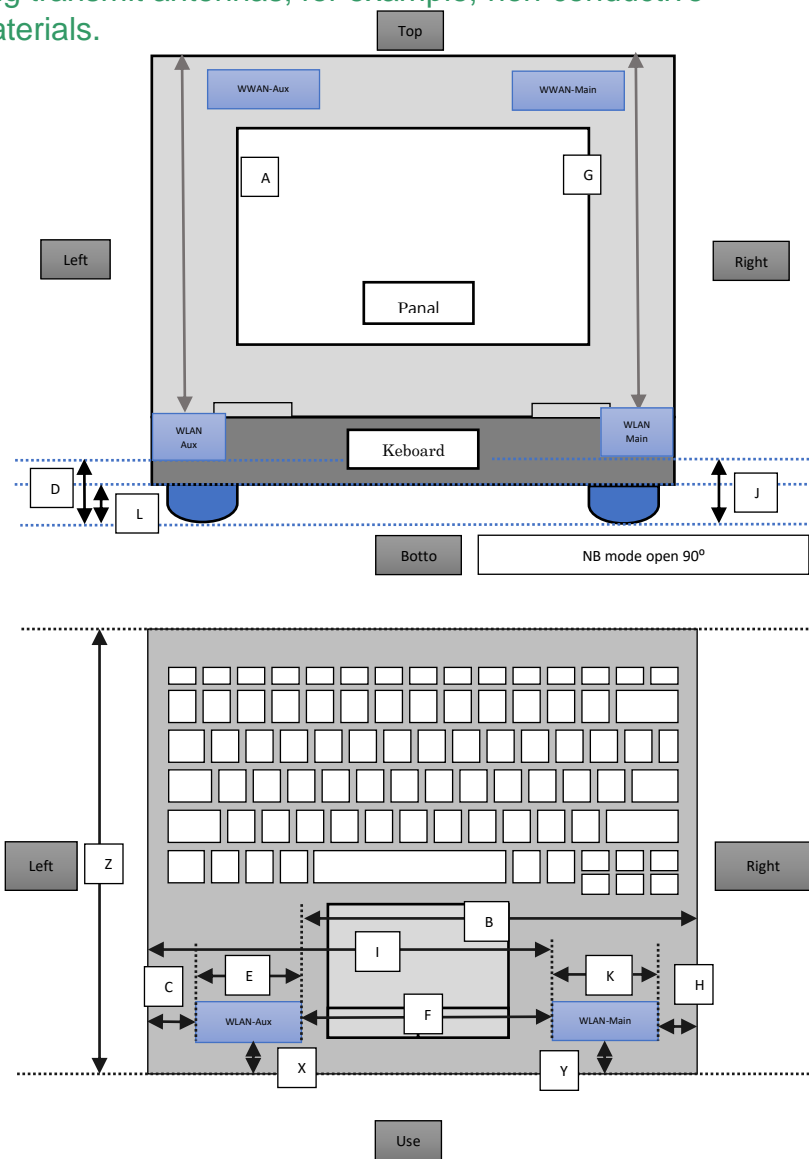

Minimum Separation Distance

Item	Antenna	Position	Distance (mm)
P	WLAN-Aux	to Front	5.9
Q	WLAN-Aux	to Rear	17.1
R	WLAN-Main	to Front	17.1
S	WLAN-Main	to Rear	5.7

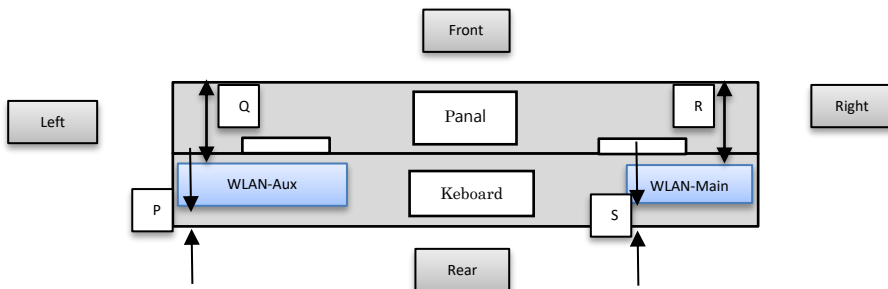

Section 5. Antenna dimensional information for SAR evaluation

Include a **dimensioned photo(s) or dimensioned drawing(s)** showing the distance (mm) between the transmit antennas and the user. For notebook/laptop hosts show lapheld position (example below). For tablet hosts show all orientations including lapheld, primary & secondary portrait, primary & secondary landscape positions. Include a description of any proximity sensors or power throttling implementations that limit or exclude use of any host orientation.

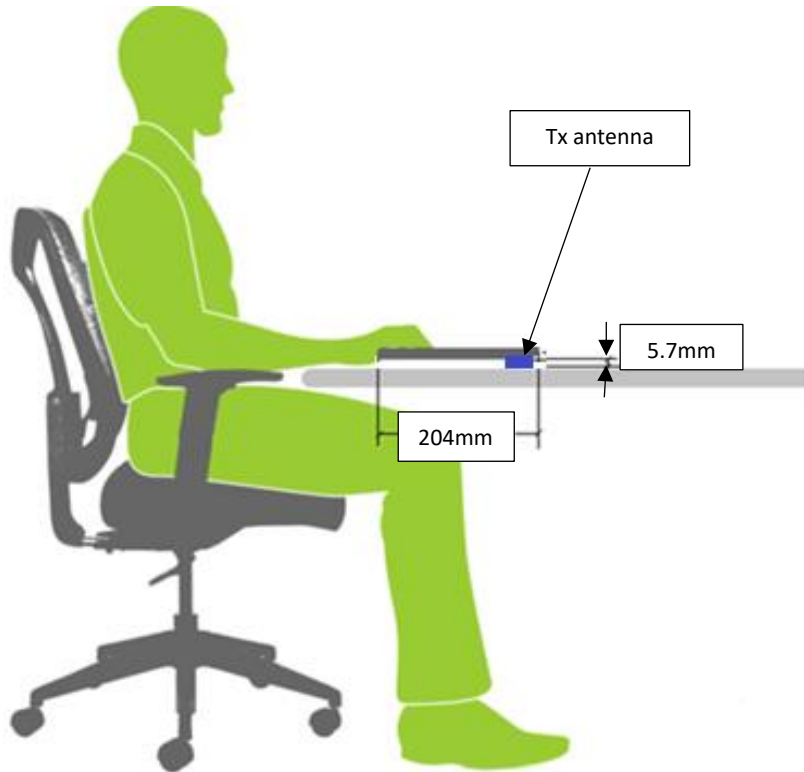
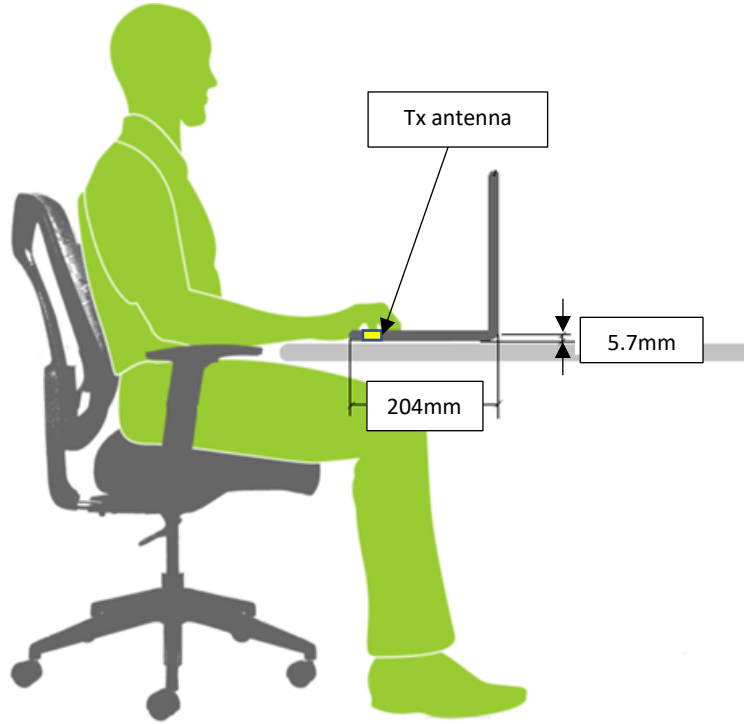

Section 6. Diagram Example of Co-Location Antenna Separation

Include a **dimensioned photo or dimensioned drawing** showing the distance (mm) between **all WLAN transmit antennas** and other co-located radiator transmit antenna such as Bluetooth, WWAN,..

(Note: Due to the evolving rules regarding co-location, each platform will need to be reviewed on a case by case basis)

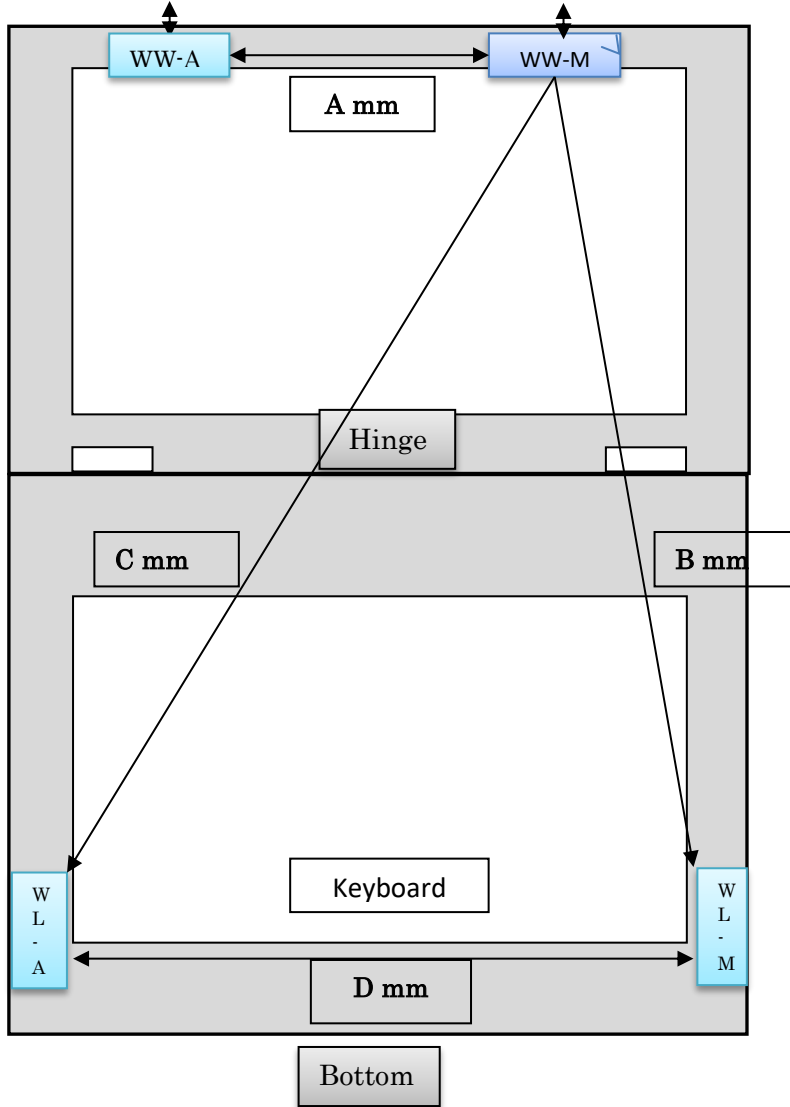

Minimum Separation Distance			
Item	Antenna	Position	Distance
			(mm)
A	WWAN	Main to Aux	60
B	WWAN-Main	To WLAN Main	247.2
C	WWAN-Aux	To WLAN Aux	318.6
D	WLAN-Main	To WLAN Aux	275