

System Check_Head_2450MHz

DUT: D2450V2-736

Communication System: CW; Frequency: 2450 MHz; Duty Cycle: 1:1

Medium: HSL_2450_210127 Medium parameters used : $f = 2450$ MHz; $\sigma = 1.81$ S/m; $\epsilon_r = 38.794$; $\rho = 1000$ kg/m³

Ambient Temperature : 23.5 °C ; Liquid Temperature : 22.5 °C

DASY5 Configuration:

- Probe: EX3DV4 - SN7346; ConvF(7.66, 7.66, 7.66) @ 2450 MHz; Calibrated: 2020/5/20
- Sensor-Surface: 1.4mm (Mechanical Surface Detection)
- Electronics: DAE4 Sn853; Calibrated: 2020/7/23
- Phantom: ELI v4.0_Mid; Type: QDOVA001AA; Serial: TP:1131
- Measurement SW: DASY52, Version 52.10 (4); SEMCAD X Version 14.6.14 (7483)

Pin=250mW/Area Scan (71x71x1): Interpolated grid: dx=1.200 mm, dy=1.200 mm
Maximum value of SAR (interpolated) = 20.7 W/kg

Pin=250mW/Zoom Scan (7x7x7)/Cube 0: Measurement grid: dx=5mm, dy=5mm, dz=5mm
Reference Value = 110.6 V/m; Power Drift = -0.09 dB
Peak SAR (extrapolated) = 24.7 W/kg
SAR(1 g) = 12.5 W/kg; SAR(10 g) = 5.88 W/kg
Maximum value of SAR (measured) = 20.3 W/kg

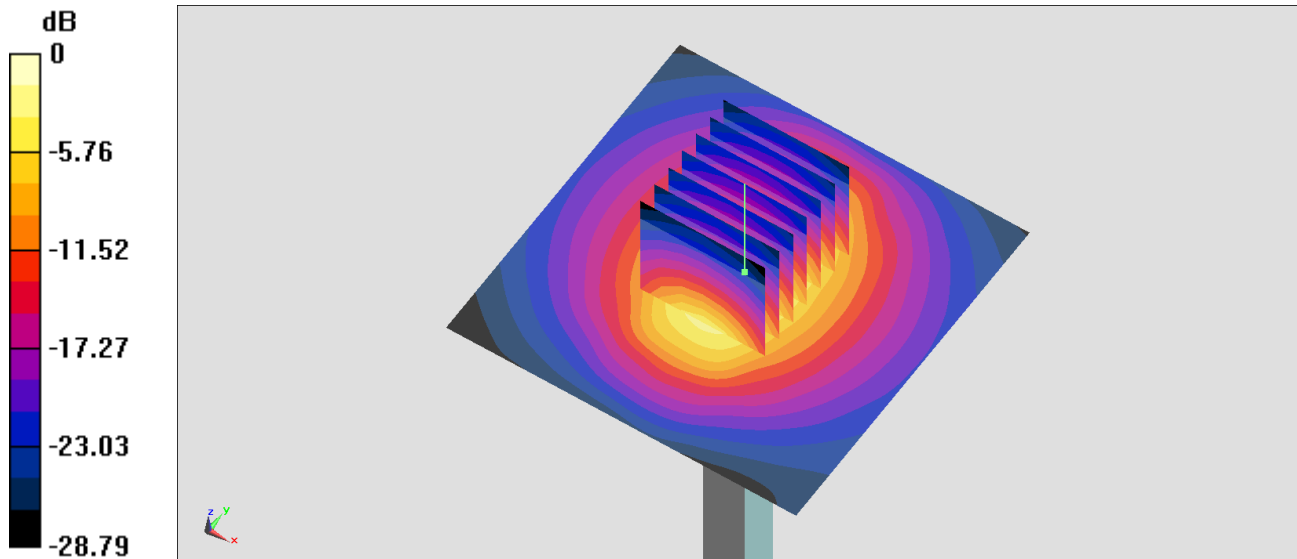

0 dB = 20.7 W/kg = 13.16 dBW/kg

System Check_Head_5250MHz

DUT: D5GHzV2-1006

Communication System: CW; Frequency: 5250 MHz; Duty Cycle: 1:1

Medium: HSL_5G_210127 Medium parameters used : $f = 5250$ MHz; $\sigma = 4.721$ S/m; $\epsilon_r = 35.714$; $\rho = 1000$ kg/m³

Ambient Temperature : 23.5 °C; Liquid Temperature : 22.5 °C

DASY5 Configuration:

- Probe: EX3DV4 - SN7346; ConvF(5.38, 5.38, 5.38) @ 5250 MHz; Calibrated: 2020/5/20
- Sensor-Surface: 1.4mm (Mechanical Surface Detection)
- Electronics: DAE4 Sn853; Calibrated: 2020/7/23
- Phantom: ELI v5.0_Left; Type: QDOVA002AA; Serial: TP:1238
- Measurement SW: DASY52, Version 52.10 (4); SEMCAD X Version 14.6.14 (7483)

Pin=100mW/Area Scan (71x71x1): Interpolated grid: dx=1.000 mm, dy=1.000 mm
Maximum value of SAR (interpolated) = 19.7 W/kg

Pin=100mW/Zoom Scan (7x7x7)/Cube 0: Measurement grid: dx=4mm, dy=4mm, dz=1.4mm
Reference Value = 70.60 V/m; Power Drift = 0.02 dB
Peak SAR (extrapolated) = 34.2 W/kg
SAR(1 g) = 8.07 W/kg; SAR(10 g) = 2.24 W/kg
Maximum value of SAR (measured) = 20.0 W/kg

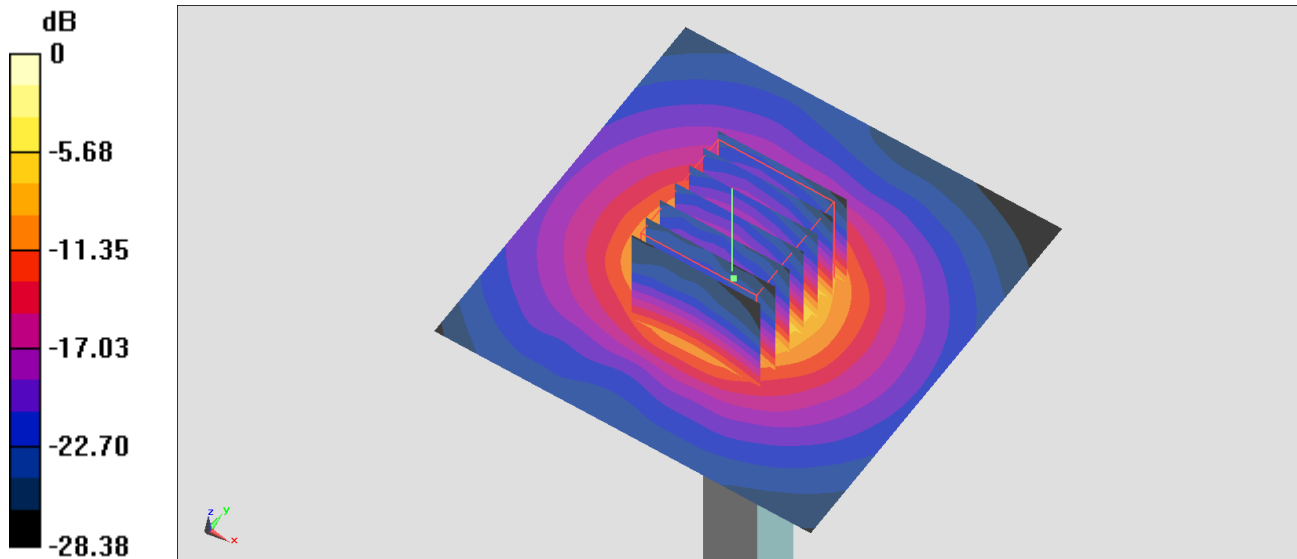

0 dB = 19.7 W/kg = 12.94 dBW/kg

System Check_Head_5600MHz

DUT: D5GHzV2-1006

Communication System: CW; Frequency: 5600 MHz; Duty Cycle: 1:1

Medium: HSL_5G_210127 Medium parameters used: $f = 5600$ MHz; $\sigma = 5.055$ S/m; $\epsilon_r = 35.249$; $\rho = 1000$ kg/m³

Ambient Temperature : 23.5 °C; Liquid Temperature : 22.5 °C

DASY5 Configuration:

- Probe: EX3DV4 - SN7346; ConvF(4.79, 4.79, 4.79) @ 5600 MHz; Calibrated: 2020/5/20
- Sensor-Surface: 1.4mm (Mechanical Surface Detection)
- Electronics: DAE4 Sn853; Calibrated: 2020/7/23
- Phantom: ELI v5.0_Left; Type: QDOVA002AA; Serial: TP:1238
- Measurement SW: DASY52, Version 52.10 (4); SEMCAD X Version 14.6.14 (7483)

Pin=100mW/Area Scan (71x71x1): Interpolated grid: dx=1.000 mm, dy=1.000 mm

Maximum value of SAR (interpolated) = 21.2 W/kg

Pin=100mW/Zoom Scan (7x7x7)/Cube 0: Measurement grid: dx=4mm, dy=4mm, dz=1.4mm

Reference Value = 72.20 V/m; Power Drift = 0.08 dB

Peak SAR (extrapolated) = 36.5 W/kg

SAR(1 g) = 8.46 W/kg; SAR(10 g) = 2.35 W/kg

Maximum value of SAR (measured) = 21.3 W/kg

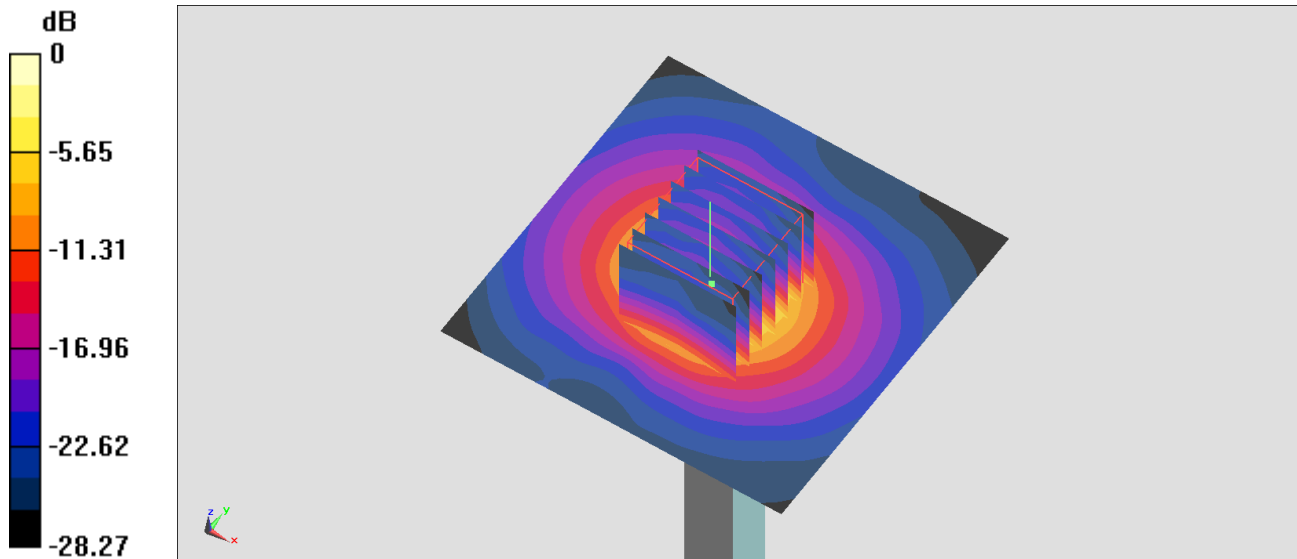

0 dB = 21.2 W/kg = 13.26 dBW/kg

System Check_Head_5750MHz

DUT: D5GHzV2-1006

Communication System: CW; Frequency: 5750 MHz; Duty Cycle: 1:1

Medium: HSL_5G_210127 Medium parameters used: $f = 5750$ MHz; $\sigma = 5.212$ S/m; $\epsilon_r = 35.052$; $\rho = 1000$ kg/m³

Ambient Temperature : 23.5 °C; Liquid Temperature : 22.5 °C

DASY5 Configuration:

- Probe: EX3DV4 - SN7346; ConvF(4.84, 4.84, 4.84) @ 5750 MHz; Calibrated: 2020/5/20
- Sensor-Surface: 1.4mm (Mechanical Surface Detection)
- Electronics: DAE4 Sn853; Calibrated: 2020/7/23
- Phantom: ELI v5.0_Left; Type: QDOVA002AA; Serial: TP:1238
- Measurement SW: DASY52, Version 52.10 (4); SEMCAD X Version 14.6.14 (7483)

Pin=100mW/Area Scan (71x71x1): Interpolated grid: dx=1.000 mm, dy=1.000 mm
Maximum value of SAR (interpolated) = 19.7 W/kg

Pin=100mW/Zoom Scan (7x7x7)/Cube 0: Measurement grid: dx=4mm, dy=4mm, dz=1.4mm
Reference Value = 70.19 V/m; Power Drift = -0.02 dB
Peak SAR (extrapolated) = 37.1 W/kg
SAR(1 g) = 7.93 W/kg; SAR(10 g) = 2.27 W/kg
Maximum value of SAR (measured) = 21.1 W/kg

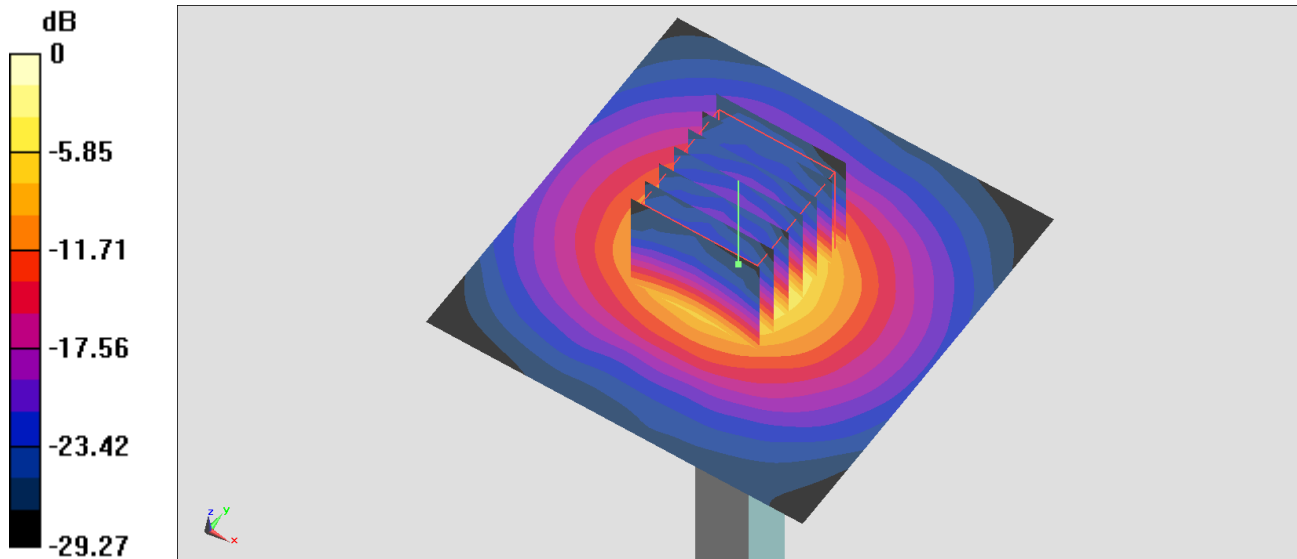

0 dB = 19.7 W/kg = 12.94 dBW/kg