



AT4 wireless, S.A.
 Parque Tecnológico de Andalucía,
 c/ Severo Ochoa nº 2
 29590 Campanillas/ Málaga/ España
 Tel. 952 61 91 00 - Fax 952 61 91 13
 MÁLAGA, C.I.F. A29 507 456
 Registro Mercantil de Málaga, Tomo 1169,
 Libro 82, Folio 133, Hoja MA3729

TEST REPORT

REFERENCE STANDARDS:

FCC 47CFR Part 2.1093 (10-1-09 Edition)

FCC OET Bulletin 65, Supplement C (Edition 01-01)

IC RSS-102 Issue 4 (2010-03)

NIE :	33436RRF.003
Approved by (name / position & signature)	A. Llamas / RF Lab Manager
Elaboration date	2011-07-13
Identification of item tested	Intel® Centrino® Ultimate-N 6300 inside a host device
Trademark	Intel
Model and/or type reference	633ANHMW
Serial number	MAC: 0024D76433A4
Other identification of the product	FCC ID: E2K633ANH / IC: 1514B-633ANH
Features	802.11 a/b/g/n
Description	Wireless Module: Intel® Centrino® Ultimate-N 6300 Antenna Type: Yageo 6036B0091604 and 6036B0091504 Host platform: Dell P17G
Applicant	Intel Corporation
Address..... :	100 Center Point Circle, Suite 200, Columbia, SC 29210, USA
CIF/NIF/Passport..... :	---
Contact person:	Steven C. Hackett (Wireless Regulatory Engineer)
Telephone / Fax	803-216-2344
e-mail:	steven.c.hackett@intel.com
Test samples supplier	Same as applicant
Manufacturer	Same as applicant

Test method requested	See Standard
Standard	<ol style="list-style-type: none"> 1. FCC 47 CFR Part 2.1093 (10-1-09 Edition). Radiofrequency radiation exposure evaluation: portable devices. 2. FCC OET Bulletin 65, Supplement C (Edition 01-01), “Evaluating Compliance with FCC Guidelines for Human Exposure to Radio Frequency Electromagnetic Fields”. 3. IC RSS-102 Issue 4 (2010-03). Radio Frequency (RF) Exposure Compliance of Radiocommunication Apparatus (All Frequency Bands)
Application Notes	<ol style="list-style-type: none"> 1. FCC OET KDB 248227 – SAR Measurements Procedures 802.11a/b/g Transmitters (May 2007 – Revised). 2. FCC OET KDB 447498 – Mobile and Portable Device, RF Exposure Procedures and Equipment Authorization Policies (November 2009). 3. FCC OET KDB 450824 – SAR Probe Calibration and System Verification Considerations for measurements at 150 MHz – 3 GHz (January 2007). 4. FCC OET KDB 616217 D03 – SAR Evaluation Considerations for Laptop/Notebook/Netbook and Tablet Computers – Supplement to KDB 616217 (November 2009) 5. FCC OET KDB 865664 – SAR Measurements Requirements for 3-6 GHz (October 2006). 6. IC RSS-102 Supplementary Procedures (SPR)-001 (2011-01). SAR testing requirements with regard to bystanders for laptop type computers with antennas built-in on display screen (laptop mode/tablet mode).
Test procedure	PERF062
Non-standardized test method	N/A
Used instrumentation	<ol style="list-style-type: none"> 1. Dosimetric E-field probe SPEAG ES3DV3 2. Dosimetric E-field probe SPEAG EX3DV4 3. Data acquisition device SPEAG DAE4 4. Electro-optical converter SPEAG EOC3 5. 2450 MHz dipole validation kit SPEAG D2450V2 6. 5GHz dipole validation kit SPEAG D5GHzV2 7. Robot STÄUBLI RX60BL 8. Robot controller STÄUBLI CM7MB 9. Oval flat phantom SPEAG ELI 4 10. SAR measurement software SPEAG DASY4 V4.7 Build 80 11. Measurement server SPEAG DASY4 SE UMS 001 DC 12. Body Tissue Equivalent Liquids for 2450MHz and 5GHz bands 13. Vector network analyzer Agilent E5071C 14. Dielectric probe kit Agilent 85070C 15. Power meter R&S NRVD 16. Power Sensor R&S NRV-Z51 17. Power Sensor R&S NRV-Z1 18. RF Generator Agilent ESG E4438C 19. Dual directional coupler NARDA FSCM 99899 20. Power amplifier MITEQ AMF-4D-00400600-50-30P 21. Laptop positioning extension SPEAG Laptop Holder
Report template No.	FDT08_12
<p>IMPORTANT: No parts of this report may be reproduced or quoted out of context, in any form or by any means, except in full, without the previous written permission of AT4 wireless.</p>	

INDEX

Competences and guarantees	4
General conditions	4
Uncertainty	4
Usage of samples.....	5
Testing period	5
Environmental conditions	5
Summary	5
Remarks and comments	5
Testing verdicts.....	6
APPENDIX A: Test Configuration.....	7
APPENDIX B: Test results.....	15
APPENDIX C: Measurements Reports	30
APPENDIX D: Calibration Data	75
APPENDIX E: Photographs	94

Competences and guarantees

AT4 wireless is a testing laboratory accredited by the National Accreditation Body (ENAC -Entidad Nacional de Acreditación), to perform the tests indicated in the Certificate No. 51/LE 342.

In order to assure the traceability to other national and international laboratories, AT4 wireless has a calibration and maintenance programme for its measurement equipment.

AT4 wireless guarantees the reliability of the data presented in this report, which is the result of the measurements and the tests performed to the item under test on the date and under the conditions stated on the report and, it is based on the knowledge and technical facilities available at AT4 wireless at the time of performance of the test.

AT4 wireless is liable to the client for the maintenance of the confidentiality of all information related to the item under test and the results of the test.

General conditions

1. This report is only referred to the item that has undergone the test.
2. This report does not constitute or imply on its own an approval of the product by the Certification Bodies or competent Authorities.
3. This document is only valid if complete; no partial reproduction can be made without previous written permission of AT4 wireless.
4. This test report cannot be used partially or in full for publicity and/or promotional purposes without previous written permission of AT4 wireless and the Accreditation Bodies.

Uncertainty

Uncertainty (factor $k=2$) was calculated according to the following documents:

1. FCC OET Bulletin 65, Supplement C (Edition 01-01), "Evaluating Compliance with FCC Guidelines for Human Exposure to Radio Frequency Electromagnetic Fields".
2. FCC OET KDB 865664 – SAR Measurements Requirements for 3-6 GHz (October 2006).

Usage of samples

Samples undergoing test have been selected by: **the client**.

Sample M/01 is composed of the following elements:

<u>Control N°</u>	<u>Description</u>	<u>Model</u>	<u>Serial N°</u>	<u>Date of reception</u>
33436/05	WiFi module inside a host device	Intel® Centrino® Ultimate- N 6300 / Dell P17G / Yageo Antennas	MAC: 0024D76433A4	2011-06-10

1. Sample M/01 has undergone the test(s) specified in subclause “Test method requested”.

Testing period

The performed test started on 2011-06-16 and finished on 2011-06-27.

The tests have been performed at AT4 wireless.

Environmental conditions

In the laboratory for measurements, the following limits were not exceeded during the test:

Temperature	Min. = 21.64 °C Max. = 25.20 °C
Relative humidity	Min. = 48.62 % Max. = 69.95 %

Summary

Considering the results of the performed test according to FCC 47CFR Part 2.1093, the item under test is **IN COMPLIANCE** with the requested specifications specified in the standard.

The maximum 1g volume averaged SAR found during this test has been 1.130 W/kg, for the Chain A at the 5800 MHz band and 802.11n with 40 MHz bandwidth mode.

NOTE: The results presented in this Test Report apply only to the particular item under test established in page 1 of this document, as presented for test on the date(s) shown in section, “USAGE OF SAMPLES, TESTING PERIOD AND ENVIRONMENTAL CONDITIONS”.

Remarks and comments

1: 802.11n = 20MHz BW / 802.11n* = 40MHz BW.

2: Testing of 802.11b, 802.11g and 802.11n with 20MHz BW is not required due to the testing reductions mentioned in FCC OET KDB 248227 – SAR Measurements Procedures 802.11a/b/g Transmitters (May 2007 – Revised), paragraph “Frequency Channel Configurations”.

3: Testing of other channels in each band is optional when the maximum output channel SAR fulfills the testing reductions mentioned in FCC OET KDB 248227 – SAR Measurements Procedures 802.11a/b/g Transmitters (May 2007 – Revised), paragraph “Frequency Channel Configurations”.

4: All the test positions of device relative to body were measured placing the device in direct contact with the phantom surface, so the requirements mentioned at RSS-102 Supplementary Procedures (SPR)-001 - SAR TESTING REQUIREMENTS WITH REGARD TO BYSTANDERS FOR LAPTOP TYPE COMPUTERS WITH ANTENNAS BUILT-IN ON DISPLAY SCREEN (LAPTOP MODE/TABLET MODE) are covered.

Testing verdicts

Not applicable: NA
 Pass.....: P
 Fail: F
 Not measured.....: NM

2450 MHz band

FCC 47CFR Part 2.1093 Paragraph	VERDICT			
	NA	P	F	NM
(d)(2) 802.11b				NM ²
(d)(2) 802.11g				NM ²
(d)(2) 802.11n ¹				NM ²
(d)(2) 802.11n* ¹		P		

1 and 2: See Remarks and Comments.

5.2 – 5.8 GHz band

FCC 47CFR Part 2.1093 Paragraph	VERDICT			
	NA	P	F	NM
Lower Band (5.18 – 5.32 GHz)				
(d)(2) 802.11a				NM ²
(d)(2) 802.11n ¹				NM ²
(d)(2) 802.11n* ¹		P		
Middle Band (5.5 – 5.7 GHz)				
(d)(2) 802.11a				NM ²
(d)(2) 802.11n ¹				NM ²
(d)(2) 802.11n* ¹		P		
Higher Band (5.745 – 5.825 GHz)				
(d)(2) 802.11a				NM ²
(d)(2) 802.11n ¹				NM ²
(d)(2) 802.11n* ¹		P		

1 and 2: See Remarks and Comments.

APPENDIX A: Test Configuration

INDEX

1. GENERAL INTRODUCTION	9
1.1. Application Standard.....	9
1.2. General requirements	9
1.3. Measurement system and phantom requirements	9
1.4. Measurement Liquids requirements.	9
2. MEASUREMENT SYSTEM.....	10
2.1. Measurement System.....	10
2.2. Test Positions of device relative to body ⁴	11
2.3. Test to be performed	11
2.4. Description of interpolation/extrapolation scheme.....	11
2.5. Determination of the largest peak spatial-average SAR.....	12
2.6. System Validation	12
3. UNCERTAINTY	13
4. SAR LIMIT	14

1. GENERAL INTRODUCTION

1.1. Application Standard

The Federal Communications Commission (FCC) sets the limits for General Population / Uncontrolled exposure to radio frequency electromagnetic fields for transmitting devices designed to be used within 20 centimetres of the user body under FCC 47 CFR Part 2.1093 - "Radiofrequency radiation exposure evaluation: portable devices", paragraph (d)(2).

Specific requirements and procedure for SAR assessment are describe under FCC OET Bulletin 65, Supplement C (Edition 01-01), "Evaluating Compliance with FCC Guidelines for Human Exposure to Radio Frequency Electromagnetic Fields", and all the FCC OET Knowledge Database documents referred at the beginning of this document.

1.2. General requirements

The SAR measurement has been performed continuing the following considerations and environment conditions:

- The ambient temperature shall be in the range of 18°C to 25°C and the variation shall not exceed +/-2°C during the test.
- The ambient humidity shall be in the range of and 30% - 70%.
- The device battery shall be fully charged before each measurement.

1.3. Measurement system and phantom requirements

The measurement system used for SAR tests fulfils the procedural and technical requirements described at the reference standards used.

The phantom is a simplified representation of the human anatomy and comprised of material with electrical properties similar to the corresponding tissues in human body.

1.4. Measurement Liquids requirements.

The liquids used to simulate the human tissues, must fulfils the requirements of the dielectric properties required. These target dielectric properties per FCC OET KDB 450824 instructions come from the dipole and probe calibration data which are included in Appendix B, Section 2, of this document (the values for 5200 and 5600 MHz are linearly interpolated between the specified values for 3000 and 5800 MHz indicated in FCC OET Bulletin 65 – Supplement C, Appendix C, 'Tissue Dielectric Parameters').

As indicated in FCC OET KDB 450824, it is allowed a 5% variation of the above mentioned level at the 2450 MHz band. As indicated in FCC OET KDB 865664 – 'Measurements Requirements for 3-6 GHz', it is allowed a 10% and a 5% variation of permittivity and conductivity respectively at the 5200-5800 GHz band.

2. MEASUREMENT SYSTEM

2.1. Measurement System

Manufacturer	Device	Type
Schmid & Partner Engineering AG	Dosimetric E-Fiel Probe	ES3DV3
Schmid & Partner Engineering AG	Dosimetric E-Fiel Probe	EX3DV4
Schmid & Partner Engineering AG	Data Acquisition Electronics	DAE4
Schmid & Partner Engineering AG	Electro-Optical Converter	EOC5
Schmid & Partner Engineering AG	2450 MHz System Validation Dipole	D2450V2
Schmid & Partner Engineering AG	5GHz System Validation Dipole	D5GHzV2
Stäubli	Robot	RX60BL
Stäubli	Robot controller	CM7MB
Schmid & Partner Engineering AG	Oval flat phantom	ELI 4
Schmid & Partner Engineering AG	Measurement Software	DASY V4.7 Build 80
Schmid & Partner Engineering AG	Measurement Server	DASY4 SE UMS 001 DC
Agilent	Vector Network Analyser	E5071C
Agilent	Dielectric Probe Kit	85070C
Rohde & Schwarz	Power Meter	NRVD
Rohde & Schwarz	Power Sensor	NRV-Z51
Rohde & Schwarz	Power Sensor	NRV-Z1
Agilent	RF Generator	ESG E4438C
NARDA	Dual directional coupler	FSCM 99899
MITEQ	Power amplifier	AMF-4D-00400600-50-30P
Schmid & Partner Engineering AG	Laptop Holder	SM LH1 001 AC

Table 1: Measurement Equipment

2.2. Test Positions of device relative to body ⁴

The laptop device was tested in three different positions, as stated at FCC OET KDB 447498 – Mobile and Portable Device, RF Exposure Procedures and Equipment Authorization Policies (November 2009) paragraph 4) b):

- Lapheld: with the base in direct contact with the phantom, with the display folded on top of the keyboard section.
- Secondary Portrait: edge with the most conservative exposure condition for the main and mimo antennas at portrait configuration.
- Secondary Landscape: edge with the most conservative exposure condition for main, aux and mimo antennas at landscape configuration.

Further analysis was performed to determine the location which showed the highest SAR.

2.3. Test to be performed

In all operating modes and bands the measurements have to be performed on the “default test channels” defined at FCC OET KDB 248227 – SAR Measurements Procedures 802.11a/b/g Transmitters (May 2007 – Revised), except those channels defined as “required test channels” at the same document.

2.4. Description of interpolation/extrapolation scheme

The local SAR inside the Phantom is measured using small dipole sensing elements inside a probe element. The probe tip must not be in contact with the Phantom’s surface in order to minimise measurement errors, but the highest local SAR is obtained from measurements at a certain distances from the shell trough extrapolation. The accurate assessment of the maximum SAR averaged over 1 gr. and 10 gr. requires a very fine resolution in the three dimensional scanned data array. Since the measurements have to be performed over a limited time, the measured data have to be interpolated to provide an array of sufficient resolution.

The interpolation of 2D area scan is used after the initial area scan, at a fixed distance from the Phantom shell wall. The initial scan data is collected with a proper spatial resolution and this interpolation is used to find the location of the local maximum for positioning the subsequent 3D scanning to within a 1mm resolution.

For the 3D scan, data is collected on a spatially regular 3D grid having 5mm steps in both lateral directions, and 5mm in depth direction for the 2450MHz band. Over the 5GHz band, a 4mm lateral resolution is required, and 2.5mm in depth direction. After the data collection by the SAR probe, the data are extrapolated in the depth direction to assign values to points in the 3D array closer to the shell wall. A notional extrapolation value is also assigned to the first point outside the shell wall so that subsequent interpolation schemes will be applicable right up to the shell wall boundary.

2.5. Determination of the largest peak spatial-average SAR

To determine the maximum value of the peak spatial-average SAR of a EUT, all device positions, configurations and operational modes should be tested for each frequency band.

According to FCC 47 CFR Part 2.1093, the averaging volume shall be chosen as 1 g of contiguous tissue. The cubic volumes, over which the SAR measurements are averaged after extrapolation and interpolation, are chosen in order to include the highest values of local SAR.

The maximum SAR level for the EUT will be the maximum level obtained of the performed measurements, and indicated in the previous points.

2.6. System Validation

Prior to the SAR measurements, system verification is done daily to verify the system accuracy. As FCC OET Bulletin 65 – Supplement C, Appendix D “SAR measurement procedures” Paragraph “System Verification” specifies, a complete SAR evaluation is done using a half-wavelength dipole as source with the frequency of the mid-band channel of the operating band, or within 100MHz of this channel.

The measured 1 gr. and 10 gr. SAR should be within 10% of the expected target values specified in the calibration certificate of the dipole, for the specific tissue and frequency used.

3. UNCERTAINTY

Uncertainty for 300 MHz – 6 GHz

ERROR SOURCES	Uncertainty value (%)	Probability distribution	Divisor	(c _i) 1g	(c _i) 10g	Standard uncertainty (1g) (%)	Standard uncertainty (10g) (%)	v _i v _{eff}
Measurement Equipment								
Probe Calibration	±4.480	Normal	1	1	1	±4.480	±4.480	∞
Axial Isotropy	±7.558	Rectangular	√3	1	1	±4.364	±4.364	∞
Hemispherical Isotropy	±2.000	Rectangular	√3	1	1	±1.155	±1.155	∞
Boundary effect	±4.700	Rectangular	√3	1	1	±2.714	±2.714	∞
Linearity	±1.000	Rectangular	√3	1	1	±0.577	±0.577	∞
System detection limits	±0.300	Rectangular	√3	1	1	±0.300	±0.300	∞
Readout electronics	±1.010	Normal	1	1	1	±0.583	±0.583	∞
Response time	±2.600	Rectangular	√3	1	1	±1.501	±1.501	∞
Integration time	±3.000	Rectangular	√3	1	1	±1.732	±1.732	∞
RF Ambien conditions	±3.000	Rectangular	√3	1	1	±1.732	±1.732	∞
Probe positioner	±0.800	Rectangular	√3	1	1	±0.462	±0.462	∞
Probe positioning	±9.900	Rectangular	√3	1	1	±5.716	±5.716	∞
Maximum SAR evaluation	±1.000	Rectangular	√3	1	1	±0.577	±0.577	∞
Test Sample Related								
Device positioning	±2.900	Normal	1	1	1	±2.900	±2.900	145
Device Holder	±3.600	Normal	1	1	1	±3.600	±3.600	5
Power Drift	±5.000	Rectangular	√3	1	1	±2.887	±2.887	∞
Phantom and Setup								
Phantom uncertainty	±4.000	Rectangular	√3	1	1	±2.309	±2.309	∞
Liquid conductivity (deviation from target)	±5.000	Rectangular	√3	0.64	0.43	±1.848	±1.241	∞
Liquid conductivity (measurement error)	±3.100	Normal	1	0.64	0.43	±1.984	±1.333	∞
Liquid permittivity (deviation from target)	±5.000	Rectangular	√3	0.64	0.43	±1.848	±1.241	∞
Liquid permittivity (measurement error)	±4.410	Normal	1	0.64	0.43	±2.822	±1.896	∞
Combined standard uncertainty	$u_c = \sqrt{\sum_{i=1}^m c_i^2 \cdot u_i^2}$					±11.99	±11.56	330
Expanded uncertainty (confidence interval of 95%)	$ue = 2.00 u_c$					±23.98	±23.11	

Table 2: Uncertainty Assessment for 300 MHz - 6 GHz

4. SAR LIMIT

Having a worst case measurement, the SAR limit is valid for general population/uncontrolled exposure.

The SAR values have to be averaged over a mass of 1g (SAR_{1 gr.}) with the shape of a cube. This level couldn't exceed the values indicated in the application Standard:

Standard	SAR	SAR Limit (W/Kg)
FCC 47 CFR Part 2.1093 Paragraph (d)(2)	SAR _{1 gr.}	1.6

Table 3: SAR limit

APPENDIX B: Test results

INDEX

1.	TEST CONDITIONS	17
1.1.	Temperature (°C):	17
1.2.	Test signal, Output Power and Frequencies	17
1.3.	DUT information	17
2.	TISSUE PARAMETERS MEASUREMENTS	18
3.	SYSTEM VALIDATION MEASUREMENTS	18
3.1.	Validation results in 2450 MHz Band for Body TSL	18
3.2.	Validation results in 5200 MHz Band for Body TSL	18
3.3.	Validation results in 5500 MHz Band for Body TSL	18
3.4.	Validation results in 5800 MHz Band for Body TSL	18
4.	CONDUCTED AVERAGE POWER MEASUREMENTS	19
5.	MEASUREMENT RESULTS FOR SAR (SPECIFIC ABSORPTION RATE)	21
5.1.	Summary maximum results	21
5.2.	Results for 2450 MHz Band	22
5.2.1.	Lapheld Mode	22
5.2.2.	Secondary Portrait Mode	22
5.2.3.	Secondary Landscape Mode	23
5.3.	Results for 5200 MHz Band	24
5.3.1.	Lapheld Mode	24
5.3.2.	Secondary Portrait Mode	24
5.3.3.	Secondary Landscape Mode	25
5.4.	Results for 5600 MHz Band	26
5.4.1.	Lapheld Mode	26
5.4.2.	Secondary Portrait Mode	26
5.4.3.	Secondary Landscape Mode	27
5.5.	Results for 5800 MHz Band	28
5.5.1.	Lapheld Mode	28
5.5.2.	Secondary Portrait Mode	28
5.5.3.	Secondary Landscape Mode	28
5.6.	Simultaneous transmission considerations	29

1. TEST CONDITIONS

1.1. Temperature (°C):

$T_n = +21.64$ to $+25.02$

The subscript n indicates normal test conditions.

1.2. Test signal, Output Power and Frequencies

The device was put into operation by using an own control software to program the test mode required for select the continuous transmission with 100% duty cycle.

In all operating bands the measurements were performed on the “default test channels” defined at FCC OET KDB 248227 – SAR Measurements Procedures 802.11a/b/g Transmitters (May 2007 – Revised), except those that fulfil the frequency channel selection criteria mentioned on paragraph “Frequency Channel Configuration” at the same document.

The output power of the device was set to maximum power level for all tests; a fully charged battery was used for every test sequence.

The maximum average conducted power of the device was measured with a Power meter R&S NRVD and a thermocoupled Power sensor NRV-Z51.

1.3. DUT information

The device under test was the Intel® Centrino® Ultimate-N 6300 card located inside a host device (Dell P17G) computer which utilises a set of Yageo antennas (6036B0091604 and 6036B0091504). The card was operated utilizing proprietary software (DRTU Version 1.3.9-0235) and each channel was measured using a broadband power meter to determine the maximum average power.

The output power of Bluetooth device is 3.06mW ($\leq 60/f(\text{GHz})$) and the antenna-to-antenna distance between the Bluetooth antenna and the WLAN main antenna is ≥ 5 cm. Therefore, no SAR testing is required for the Bluetooth transmitter.

Collocation with WWAN transmitter has not been considered following grantee request because this collocation will be considered in the WWAN transmitter SAR testing.

2. TISSUE PARAMETERS MEASUREMENTS

Frequency (MHz)	Target Body Tissue: Parameters used in Probe Calibration		Target Body Tissue: Parameters used in Dipole Calibration		Measured Body Tissue		Measured Date
	Permittivity	Conductivity [S/m]	Permittivity	Conductivity [S/m]	Permittivity	Conductivity [S/m]	
2450	52.7 ± 5%	1.95 ± 5%	53.2 ± 6%	2.00 ± 6%	51.62	2.02	2011-06-27
5200	49.0 ± 10%	5.30 ± 5%	47.7 ± 6%	5.30 ± 6%	49.41	5.09	2011-06-17
5500	48.6 ± 10%	5.65 ± 5%	46.8 ± 6%	5.74 ± 6%	48.70	5.49	2011-06-17
5800	48.2 ± 10%	6.00 ± 5%	46.3 ± 6%	6.05 ± 6%	47.97	5.90	2011-06-17

Note: The dielectric properties have been measured by the contact probe method at 23.5° C.

3. SYSTEM VALIDATION MEASUREMENTS

3.1. Validation results in 2450 MHz Band for Body TSL

SAR	Target SAR (W/kg)	Measured SAR (W/kg)	Drift (%)	Limit (%)
1 gr.	53,00	50,58	-4,57	± 10
10 gr.	25,00	23,13	-7,49	± 10

3.2. Validation results in 5200 MHz Band for Body TSL

SAR	Target SAR (W/kg)	Measured SAR (W/kg)	Drift (%)	Limit (%)
1 gr.	75,70	79,25	4,70	± 10
10 gr.	21,10	21,98	4,15	± 10

3.3. Validation results in 5500 MHz Band for Body TSL

SAR	Target SAR (W/kg)	Measured SAR (W/kg)	Drift (%)	Limit (%)
1 gr.	81,10	88,08	8,61	± 10
10 gr.	22,40	24,01	7,20	± 10

3.4. Validation results in 5800 MHz Band for Body TSL

SAR	Target SAR (W/kg)	Measured SAR (W/kg)	Drift (%)	Limit (%)
1 gr.	71,90	78,04	8,54	± 10
10 gr.	19,70	21,20	7,63	± 10

4. CONDUCTED AVERAGE POWER MEASUREMENTS

Band	Mode	Channel	Frequency (MHz)	Conducted Power (dBm)		
				Chain A	Chain B	Chain C
2450 MHz	802.11b	1	2412	16,43	16,53	16,4
		6	2437	16,34	16,31	16,30
		11	2462	16,51	16,44	16,28
	802.11g	1	2412	15,63	14,47	15,35
		6	2437	16,30	16,52	16,47
		11	2462	14,62	14,75	14,41
	802.11n ¹	1	2417	14,64	14,65	15,47
		6	2437	16,43	16,30	16,24
		11	2457	14,41	14,48	15,38
	802.11n* ¹	3	2422	12,13	12,10	11,85
		4	2427	13,50	13,44	13,18
		6	2437	16,50	16,44	16,36
		8	2447	13,34	13,51	13,59
		9	2452	11,93	12,22	11,90
	5200 MHz	802.11a	36	5180	16,54	16,40
48			5240	16,51	16,46	16,66
52			5260	16,39	16,55	16,54
64			5320	16,36	16,32	16,28
802.11n ¹		36	5180	16,51	16,36	16,59
		48	5240	16,45	16,74	16,64
		52	5260	16,39	16,47	16,47
		64	5320	16,75	16,30	16,58
802.11n* ¹		38	5190	16,82	16,49	16,51
		46	5230	16,60	16,80	16,64
		54	5270	16,70	16,59	16,68
		62	5310	16,64	16,67	16,72

1: See Remarks and Comments.

Band	Mode	Channel	Frequency (MHz)	Conducted Power (dBm)		
				Chain A	Chain B	Chain C
5600 MHz	802.11a	100	5500	16,67	16,42	16,35
		116	5580	16,48	16,30	16,28
		140	5700	16,60	16,46	16,66
	802.11n ¹	100	5500	16,62	16,30	16,63
		116	5580	16,38	16,57	16,48
		140	5700	16,49	16,65	16,54
	802.11n* ¹	102	5510	16,36	16,79	16,73
		118	5590	16,56	16,51	16,40
		134	5670	16,67	16,45	16,36
5800 MHz	802.11a	149	5745	16,56	16,64	16,65
		157	5785	16,80	16,67	16,58
		165	5825	16,54	16,71	16,50
	802.11n ¹	149	5745	16,44	16,53	16,61
		157	5785	16,70	16,53	16,48
		165	5825	16,66	16,67	16,38
	802.11n* ¹	151	5755	16,35	16,55	16,38
		159	5795	16,61	16,60	16,63

1: See Remarks and Comments.

For the simultaneous transmission operation, the individual output power for each chain is reduced when more than one chain are transmitting at the same time. Therefore, the simultaneous transmission evaluation was calculated using the SAR results obtained with the reduced power presented in the table below:

Band	Mode	Channel	Frequency (MHz)	Conducted Power (dBm)			
				Chain A	Chain B	Chain C	Combined
5800 MHz	802.11n* ¹	159	5795	13.57	13.50	-	16.55
				13.59	-	13.43	16.52

5. MEASUREMENT RESULTS FOR SAR (SPECIFIC ABSORPTION RATE)

5.1. Summary maximum results

Band	Chain	Mode	Channel	Frequency (MHz)	Measured SAR 1g (W/Kg)	SAR limit 1g (W/Kg)
2450 MHz	A	802.11n* ¹	6	2437	0.306	1.6
	B	802.11n* ¹	6	2437	0.462	1.6
	C	802.11n* ¹	6	2437	0.357	1.6
5200 MHz	A	802.11n* ¹	38	5190	0.435	1.6
	B	802.11n* ¹	62	5310	0.889	1.6
	C	802.11n* ¹	62	5310	0.444	1.6
5600 MHz	A	802.11n* ¹	134	5670	0.845	1.6
	B	802.11n* ¹	102	5510	0.567	1.6
	C	802.11n* ¹	102	5510	0.467	1.6
5800 MHz	A	802.11n* ¹	159	5795	1.130	1.6
	B	802.11n* ¹	159	5795	0.582	1.6
	C	802.11n* ¹	159	5795	0.529	1.6

1: See Remarks and Comments.

5.2. Results for 2450 MHz Band

5.2.1. Lapheld Mode

Mode	Chain	Channel	Frequency (MHz)	SAR averaged over 1g (W/Kg)	Power Drift (%)
802.11n* ¹	A	3	2422	NM ³	-
		6	2437	0.100	1.39
		9	2452	NM ³	-
	B	3	2422	NM ³	-
		6	2437	0.034	-0.46
		9	2452	NM ³	-
	C	3	2422	NM ³	-
		6	2437	0.014	0.58
		9	2452	NM ³	-

1 and 3: See Remarks and Comments.

5.2.2. Secondary Portrait Mode

Mode	Chain	Channel	Frequency (MHz)	SAR averaged over 1g (W/Kg)	Power Drift (%)
802.11n* ¹	A	3	2422	NM ³	-
		6	2437	0.010	3.40
		9	2452	NM ³	-
	B	3	2422	NM ³	-
		6	2437	0.087	2.57
		9	2452	NM ³	-
	C	3	2422	NM ³	-
		6	2437	0.015	2.33
		9	2452	NM ³	-

1 and 3: See Remarks and Comments.

5.2.3. Secondary Landscape Mode

Mode	Chain	Channel	Frequency (MHz)	SAR averaged over 1g (W/Kg)	Power Drift (%)
802.11n* ¹	A	3	2422	NM ³	-
		6	2437	0.306	-1.37
		9	2452	NM ³	-
	B	3	2422	NM ³	-
		6	2437	0.462	-1.14
		9	2452	NM ³	-
	C	3	2422	NM ³	-
		6	2437	0.357	-0.34
		9	2452	NM ³	-

1 and 3: See Remarks and Comments.

5.3. Results for 5200 MHz Band

5.3.1. Lapheld Mode

Mode	Chain	Channel	Frequency (MHz)	SAR averaged over 1g (W/Kg)	Power Drift (%)
802.11n* ¹	A	38	5190	0.333	0.69
		46	5230	NM ³	-
		54	5270	NM ³	-
		62	5310	NM ³	-
	B	38	5190	NM ³	-
		46	5230	0.391	-0.69
		54	5270	NM ³	-
		62	5310	NM ³	-
	C	38	5190	NM ³	-
		46	5230	NM ³	-
		54	5270	NM ³	-
		62	5310	0.058	3.04

1 and 3: See Remarks and Comments.

5.3.2. Secondary Portrait Mode

Mode	Chain	Channel	Frequency (MHz)	SAR averaged over 1g (W/Kg)	Power Drift (%)
802.11n* ¹	A	38	5190	0.017	2.70
		46	5230	NM ³	-
		54	5270	NM ³	-
		62	5310	NM ³	-
	B	38	5190	NM ³	-
		46	5230	0.038	3.40
		54	5270	NM ³	-
		62	5310	NM ³	-
	C	38	5190	NM ³	-
		46	5230	NM ³	-
		54	5270	NM ³	-
		62	5310	0.010	-0.46

1 and 3: See Remarks and Comments.

5.3.3. Secondary Landscape Mode

Mode	Chain	Channel	Frequency (MHz)	SAR averaged over 1g (W/Kg)	Power Drift (%)
802.11n* ¹	A	38	5190	0.435	3.40
		46	5230	NM ³	-
		54	5270	NM ³	-
		62	5310	NM ³	-
	B	38	5190	0.878	-1.60
		46	5230	0.857	-3.95
		54	5270	0.735	-1.71
		62	5310	0.889	-3.51
	C	38	5190	NM ³	-
		46	5230	NM ³	-
		54	5270	NM ³	-
		62	5310	0.444	-0.30

1 and 3: See Remarks and Comments.

5.4. Results for 5600 MHz Band

5.4.1. Lapheld Mode

Mode	Chain	Channel	Frequency (MHz)	SAR averaged over 1g (W/Kg)	Power Drift (%)
802.11n* ¹	A	102	5510	NM ³	-
		118	5590	NM ³	-
		134	5670	0.082	0.58
	B	102	5510	0.450	0.81
		118	5590	NM ³	-
		134	5670	NM ³	-
	C	102	5510	0.035	2.68
		118	5590	NM ³	-
		134	5670	NM ³	-

1 and 3: See Remarks and Comments.

5.4.2. Secondary Portrait Mode

Mode	Chain	Channel	Frequency (MHz)	SAR averaged over 1g (W/Kg)	Power Drift (%)
802.11n* ¹	A	102	5510	NM ³	-
		118	5590	NM ³	-
		134	5670	0.024	-1.94
	B	102	5510	0.001	3.16
		118	5590	NM ³	-
		134	5670	NM ³	-
	C	102	5510	0.016	1.51
		118	5590	NM ³	-
		134	5670	NM ³	-

1 and 3: See Remarks and Comments.

5.4.3. Secondary Landscape Mode

Mode	Chain	Channel	Frequency (MHz)	SAR averaged over 1g (W/Kg)	Power Drift (%)
802.11n* ¹	A	102	5510	0.593	1.16
		118	5590	0.657	-3.28
		134	5670	0.845	-3.28
	B	102	5510	0.567	-2.16
		118	5590	NM ³	-
		134	5670	NM ³	-
	C	102	5510	0.467	-1.37
		118	5590	NM ³	-
		134	5670	NM ³	-

1 and 3: See Remarks and Comments.

5.5. Results for 5800 MHz Band

5.5.1. Lapheld Mode

Mode	Chain	Channel	Frequency (MHz)	SAR averaged over 1g (W/Kg)	Power Drift (%)
802.11n* ¹	A	151	5755	NM ³	-
		159	5795	0.118	-2.50
	B	151	5755	NM ³	-
		159	5795	0.421	-2.28
	C	151	5755	NM ³	-
		159	5795	0.053	-0.34

1 and 3: See Remarks and Comments.

5.5.2. Secondary Portrait Mode

Mode	Chain	Channel	Frequency (MHz)	SAR averaged over 1g (W/Kg)	Power Drift (%)
802.11n* ¹	A	151	5755	NM ³	-
		159	5795	0.036	-1.03
	B	151	5755	NM ³	-
		159	5795	0.025	2.27
	C	151	5755	NM ³	-
		159	5795	0.040	-0.81

1 and 3: See Remarks and Comments.

5.5.3. Secondary Landscape Mode

Mode	Chain	Channel	Frequency (MHz)	SAR averaged over 1g (W/Kg)	Power Drift (%)
802.11n* ¹	A	151	5755	0.742	0.93
		159	5795	1.130	-0.31
	B	151	5755	NM ³	-
		159	5795	0.582	-2.84
	C	151	5755	NM ³	-
		159	5795	0.529	2.57

1 and 3: See Remarks and Comments.

5.6. Simultaneous transmission considerations

As stated at FCC OET KDB 447498 – Mobile and Portable Device, RF Exposure Procedures and Equipment Authorization Policies (November 2009), paragraph 4) b) iii) (1), the simultaneous SAR transmission evaluation is not required when the sum of stand-alone 1-g SAR is < SAR limit, or the SAR to peak location separation ratios are < 0.3 for all antenna pairs.

The WLAN operation only admits the simultaneous transmission between antennas when both of them uses the same channel, so the SAR to peak location separation ratio was evaluated for the highest result measured with the corresponding value of the other one with the same channel. All the remaining combinations meet the limit when summing the stand-alone 1-g SAR.

For the simultaneous transmission operation, the individual output power for each chain is reduced when more than one chain are transmitting at the same time. Therefore, the simultaneous transmission evaluation was calculated using the SAR results obtained with the reduced power presented at paragraph 4 above.

Transmission Mode	Band	Channel	Frequency	Chain	Max. SAR averaged over 1g (W/kg)	Peak location separation (cm)	SAR to peak location separation ratio
802.11n* ¹	5.8 GHz	159	5795 MHz	A	0.723	3.42	0.28
				C	0.250		
802.11n* ¹	5.8 GHz	159	5795 MHz	A	0.609	11.40	0.08
				B	0.314		

The output power of Bluetooth device is 3.06mW ($\leq 60/f(\text{GHz})$) and the antenna-to-antenna distance between the Bluetooth antenna and the WLAN main antenna is ≥ 5 cm. Therefore, no SAR testing is required for the Bluetooth transmitter.

Collocation with WWAN transmitter has not been considered following grantee request because this collocation will be considered in the WWAN transmitter SAR testing.

APPENDIX C: Measurements Reports

2450 MHz Band – Lapheld Mode, Chain A – 802.11n* Channel 6

DUT: Dell Patron + Intel 633ANHMW + Yageo; Type: Tablet; Serial: -

Communication System: 802.11; Frequency: 2437 MHz; Duty Cycle: 1:1
 Medium parameters used (interpolated): $f = 2437$ MHz; $\sigma = 2.017$ mho/m; $\epsilon_r = 51.744$; $\rho = 1000$ kg/m³
 Phantom section: Flat Section

DASY5 Configuration:

- Probe: ES3DV3 - SN3052; ConvF(4.14, 4.14, 4.14); Calibrated: 22/10/2010
- Sensor-Surface: 4mm (Mechanical Surface Detection (Locations From Previous Scan Used)), Sensor-Surface: 4mm (Mechanical Surface Detection)
- Electronics: DAE4 Sn669; Calibrated: 03/02/2011
- Phantom: Flat Phantom ELI4.0; Type: QDOVA001BA; Serial: SN:1060
- Measurement SW: DASY52, Version 52.6 (2); SEMCAD X Version 14.4.4 (2829)

2450 MHz - Lapheld/Chain A, 802.11n*, Channel 6/Area Scan (71x221x1): Measurement grid: dx=15mm, dy=15mm

[Info: Interpolated medium parameters used for SAR evaluation.](#)

Maximum value of SAR (interpolated) = 0.079 mW/g

2450 MHz - Lapheld/Chain A, 802.11n*, Channel 6/Zoom Scan (7x7x7)/Cube 0: Measurement grid: dx=5mm, dy=5mm, dz=5mm

Reference Value = 6.269 V/m; Power Drift = 0.12 dB

Peak SAR (extrapolated) = 0.177 W/kg

SAR(1 g) = 0.100 mW/g; SAR(10 g) = 0.062 mW/g

[Info: Interpolated medium parameters used for SAR evaluation.](#)

Maximum value of SAR (measured) = 0.110 mW/g

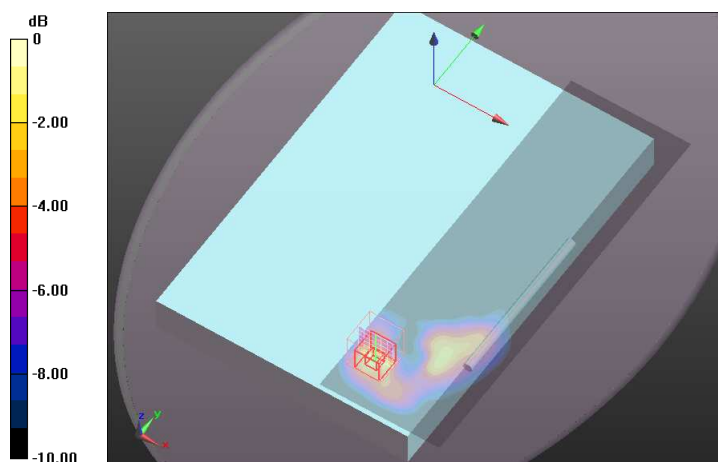

0 dB = 0.110mW/g

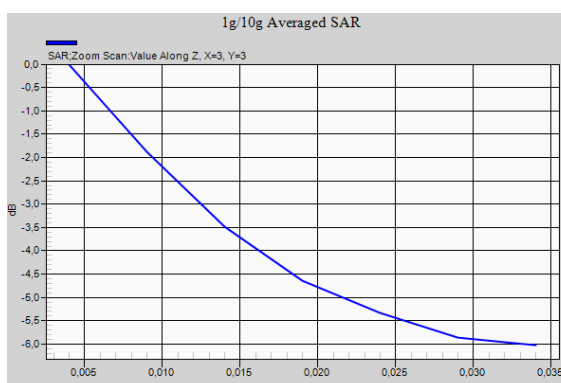

2450 MHz Band – Lapheld Mode, Chain B – 802.11n* Channel 6

DUT: Dell Patron + Intel 633ANHMW + Yageo; Type: Tablet; Serial: -

Communication System: 802.11; Frequency: 2437 MHz; Duty Cycle: 1:1
 Medium parameters used (interpolated): $f = 2437$ MHz; $\sigma = 2.017$ mho/m; $\epsilon_r = 51.744$; $\rho = 1000$ kg/m³
 Phantom section: Flat Section

DASY5 Configuration:

- Probe: ES3DV3 - SN3052; ConvF(4.14, 4.14, 4.14); Calibrated: 22/10/2010
- Sensor-Surface: 4mm (Mechanical Surface Detection (Locations From Previous Scan Used)), Sensor-Surface: 4mm (Mechanical Surface Detection)
- Electronics: DAE4 Sn669; Calibrated: 03/02/2011
- Phantom: Flat Phantom ELI4.0; Type: QDOVA001BA; Serial: SN:1060
- Measurement SW: DASY52, Version 52.6 (2); SEMCAD X Version 14.4.4 (2829)

2450 MHz - Lapheld/Chain B, 802.11n*, Channel 6/Area Scan (71x221x1): Measurement grid: dx=15mm, dy=15mm

[Info: Interpolated medium parameters used for SAR evaluation.](#)

Maximum value of SAR (interpolated) = 0.041 mW/g

2450 MHz - Lapheld/Chain B, 802.11n*, Channel 6/Zoom Scan 2 (7x8x7)/Cube 0: Measurement grid: dx=5mm, dy=5mm, dz=5mm

Reference Value = 4.466 V/m; Power Drift = -0.04 dB

Peak SAR (extrapolated) = 0.064 W/kg

SAR(1 g) = 0.034 mW/g; SAR(10 g) = 0.015 mW/g

[Info: Interpolated medium parameters used for SAR evaluation.](#)

Maximum value of SAR (measured) = 0.039 mW/g

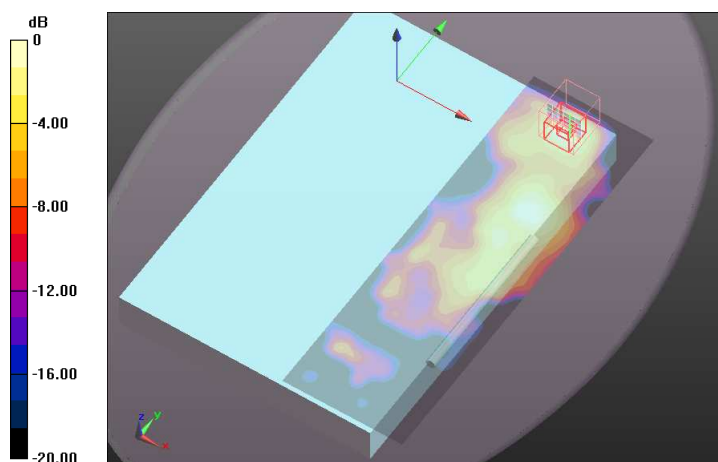

0 dB = 0.040mW/g

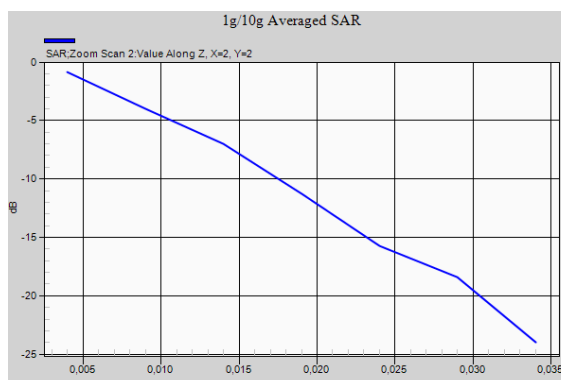

2450 MHz Band – Lapheld Mode, Chain C – 802.11n* Channel 6

DUT: Dell Patron + Intel 633ANHMW + Yageo; Type: Tablet; Serial: -

Communication System: 802.11; Frequency: 2437 MHz; Duty Cycle: 1:1
 Medium parameters used (interpolated): $f = 2437$ MHz; $\sigma = 2.017$ mho/m; $\epsilon_r = 51.744$; $\rho = 1000$ kg/m³
 Phantom section: Flat Section

DASY5 Configuration:

- Probe: ES3DV3 - SN3052; ConvF(4.14, 4.14, 4.14); Calibrated: 22/10/2010
- Sensor-Surface: 4mm (Mechanical Surface Detection (Locations From Previous Scan Used)), Sensor-Surface: 4mm (Mechanical Surface Detection)
- Electronics: DAE4 Sn669; Calibrated: 03/02/2011
- Phantom: Flat Phantom ELI4.0; Type: QDOVA001BA; Serial: SN:1060
- Measurement SW: DASY52, Version 52.6 (2); SEMCAD X Version 14.4.4 (2829)

2450 MHz - Lapheld/Chain C, 802.11n*, Channel 6/Area Scan (71x221x1): Measurement grid: dx=15mm, dy=15mm

[Info: Interpolated medium parameters used for SAR evaluation.](#)

Maximum value of SAR (interpolated) = 0.019 mW/g

2450 MHz - Lapheld/Chain C, 802.11n*, Channel 6/Zoom Scan (7x7x7)/Cube 0: Measurement grid: dx=5mm, dy=5mm, dz=5mm

Reference Value = 2.725 V/m; Power Drift = 0.05 dB

Peak SAR (extrapolated) = 0.029 W/kg

SAR(1 g) = 0.014 mW/g; SAR(10 g) = 0.00752 mW/g

[Info: Interpolated medium parameters used for SAR evaluation.](#)

Maximum value of SAR (measured) = 0.016 mW/g

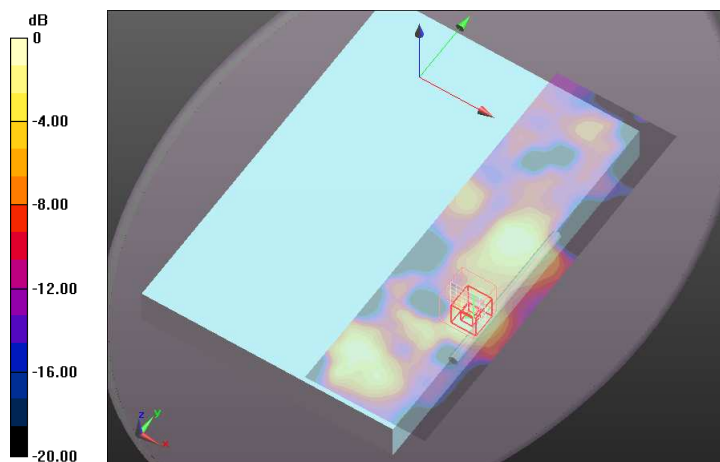

0 dB = 0.020mW/g

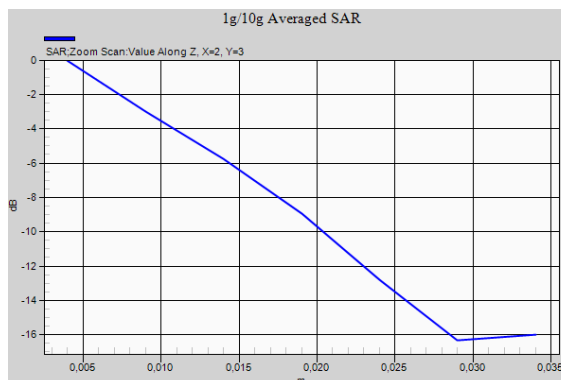

2450 MHz Band – Secondary Portrait Mode, Chain A – 802.11n* Channel 6

DUT: Dell Patron + Intel 633ANHMW + Yageo; Type: Tablet; Serial: -

Communication System: 802.11; Frequency: 2437 MHz; Duty Cycle: 1:1
 Medium parameters used (interpolated): $f = 2437$ MHz; $\sigma = 2.017$ mho/m; $\epsilon_r = 51.744$; $\rho = 1000$ kg/m³
 Phantom section: Flat Section

DASY5 Configuration:

- Probe: ES3DV3 - SN3052; ConvF(4.14, 4.14, 4.14); Calibrated: 22/10/2010
- Sensor-Surface: 4mm (Mechanical Surface Detection (Locations From Previous Scan Used)), Sensor-Surface: 4mm (Mechanical Surface Detection)
- Electronics: DAE4 Sn669; Calibrated: 03/02/2011
- Phantom: Flat Phantom ELI4.0; Type: QDOVA001BA; Serial: SN:1060
- Measurement SW: DASY52, Version 52.6 (2); SEMCAD X Version 14.4.4 (2829)

2450 MHz - Secondary Portrait/Chain A, 802.11n*, Channel 6/Area Scan (51x171x1): Measurement grid:
 dx=15mm, dy=15mm

[Info: Interpolated medium parameters used for SAR evaluation.](#)

Maximum value of SAR (interpolated) = 0.012 mW/g

2450 MHz - Secondary Portrait/Chain A, 802.11n*, Channel 6/Zoom Scan (7x7x7)/Cube 0: Measurement grid:
 dx=5mm, dy=5mm, dz=5mm

Reference Value = 2.347 V/m; Power Drift = 0.29 dB

Peak SAR (extrapolated) = 0.038 W/kg

SAR(1 g) = 0.00967 mW/g; SAR(10 g) = 0.00405 mW/g

[Info: Interpolated medium parameters used for SAR evaluation.](#)

Maximum value of SAR (measured) = 0.011 mW/g

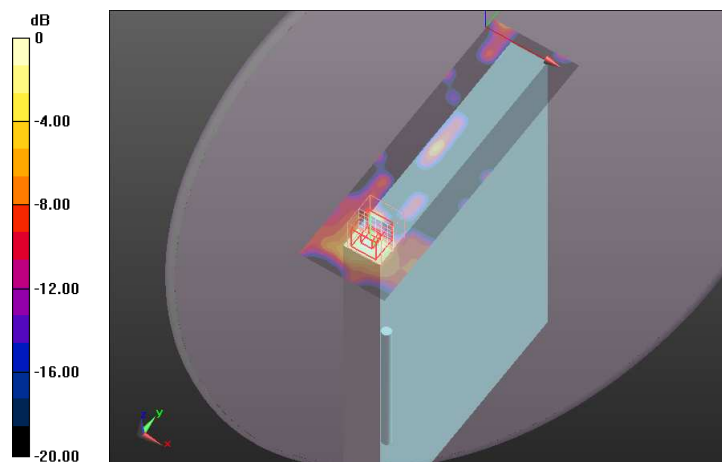

0 dB = 0.010mW/g

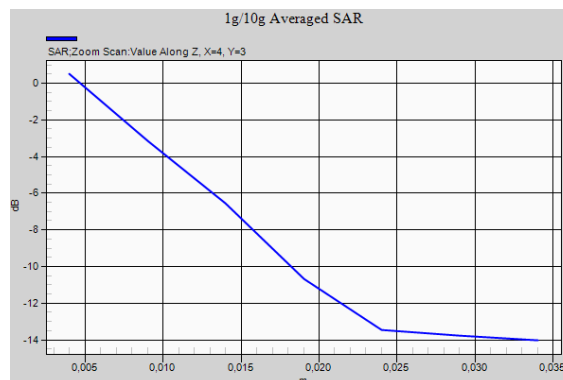

2450 MHz Band – Secondary Portrait Mode, Chain B – 802.11n* Channel 6

DUT: Dell Patron + Intel 633ANHMW + Yageo; Type: Tablet; Serial: -

Communication System: 802.11; Frequency: 2437 MHz; Duty Cycle: 1:1
 Medium parameters used (interpolated): $f = 2437$ MHz; $\sigma = 2.017$ mho/m; $\epsilon_r = 51.744$; $\rho = 1000$ kg/m³
 Phantom section: Flat Section

DASY5 Configuration:

- Probe: ES3DV3 - SN3052; ConvF(4.14, 4.14, 4.14); Calibrated: 22/10/2010
- Sensor-Surface: 4mm (Mechanical Surface Detection (Locations From Previous Scan Used)), Sensor-Surface: 4mm (Mechanical Surface Detection)
- Electronics: DAE4 Sn669; Calibrated: 03/02/2011
- Phantom: Flat Phantom ELI4.0; Type: QDOVA001BA; Serial: SN:1060
- Measurement SW: DASY52, Version 52.6 (2); SEMCAD X Version 14.4.4 (2829)

2450 MHz - Secondary Portrait/Chain B, 802.11n*, Channel 6/Area Scan (51x171x1): Measurement grid:
 $dx=15$ mm, $dy=15$ mm

[Info: Interpolated medium parameters used for SAR evaluation.](#)

Maximum value of SAR (interpolated) = 0.097 mW/g

2450 MHz - Secondary Portrait/Chain B, 802.11n*, Channel 6/Zoom Scan (7x7x7)/Cube 0: Measurement grid:
 $dx=5$ mm, $dy=5$ mm, $dz=5$ mm

Reference Value = 7.041 V/m; Power Drift = 0.22 dB

Peak SAR (extrapolated) = 0.178 W/kg

SAR(1 g) = 0.087 mW/g; SAR(10 g) = 0.042 mW/g

[Info: Interpolated medium parameters used for SAR evaluation.](#)

Maximum value of SAR (measured) = 0.099 mW/g

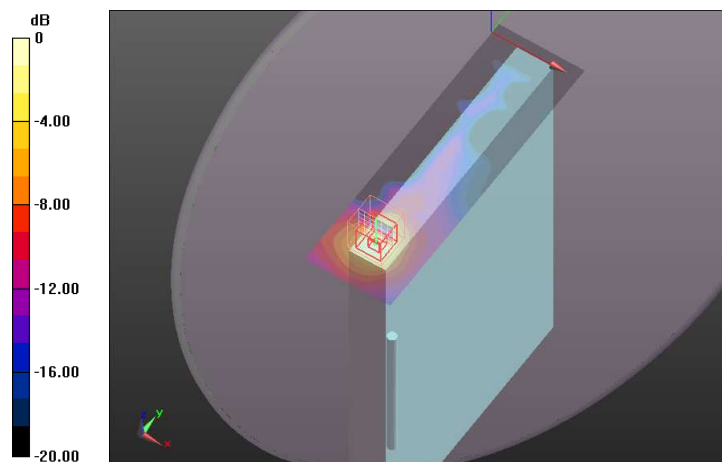

0 dB = 0.100mW/g

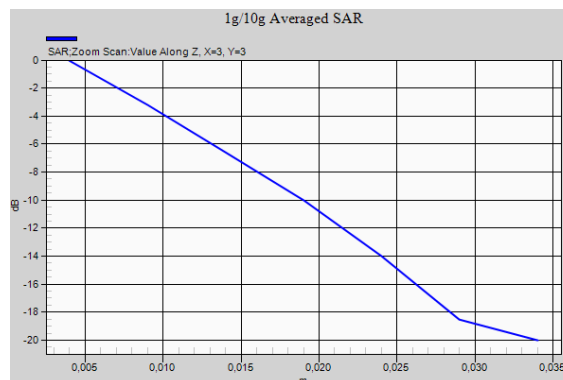

2450 MHz Band – Secondary Portrait Mode, Chain C – 802.11n* Channel 6

DUT: Dell Patron + Intel 633ANHMW + Yageo; Type: Tablet; Serial: -

Communication System: 802.11; Frequency: 2437 MHz; Duty Cycle: 1:1
 Medium parameters used (interpolated): $f = 2437$ MHz; $\sigma = 2.017$ mho/m; $\epsilon_r = 51.744$; $\rho = 1000$ kg/m³
 Phantom section: Flat Section

DASY5 Configuration:

- Probe: ES3DV3 - SN3052; ConvF(4.14, 4.14, 4.14); Calibrated: 22/10/2010
- Sensor-Surface: 4mm (Mechanical Surface Detection (Locations From Previous Scan Used)), Sensor-Surface: 4mm (Mechanical Surface Detection)
- Electronics: DAE4 Sn669; Calibrated: 03/02/2011
- Phantom: Flat Phantom ELI4.0; Type: QDOVA001BA; Serial: SN:1060
- Measurement SW: DASY52, Version 52.6 (2); SEMCAD X Version 14.4.4 (2829)

2450 MHz - Secondary Portrait/Chain C, 802.11n*, Channel 6/Area Scan (51x171x1): Measurement grid:
 dx=15mm, dy=15mm

[Info: Interpolated medium parameters used for SAR evaluation.](#)

Maximum value of SAR (interpolated) = 0.016 mW/g

2450 MHz - Secondary Portrait/Chain C, 802.11n*, Channel 6/Zoom Scan (7x7x7)/Cube 0: Measurement grid:
 dx=5mm, dy=5mm, dz=5mm

Reference Value = 2.604 V/m; Power Drift = 0.20 dB

Peak SAR (extrapolated) = 0.030 W/kg

SAR(1 g) = 0.015 mW/g; SAR(10 g) = 0.0061 mW/g

[Info: Interpolated medium parameters used for SAR evaluation.](#)

Maximum value of SAR (measured) = 0.017 mW/g

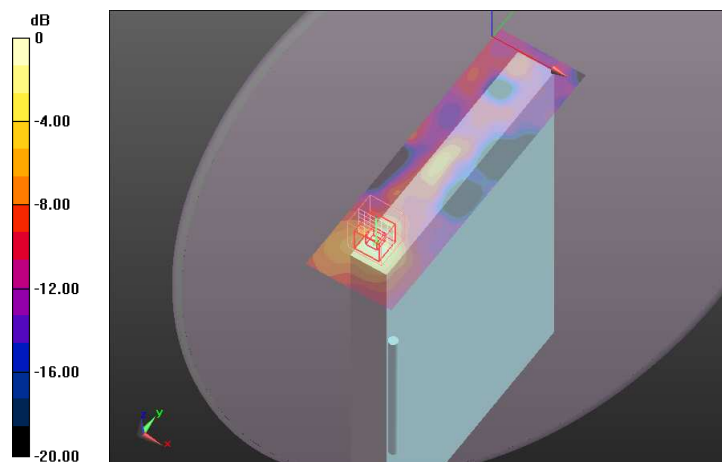

0 dB = 0.020mW/g

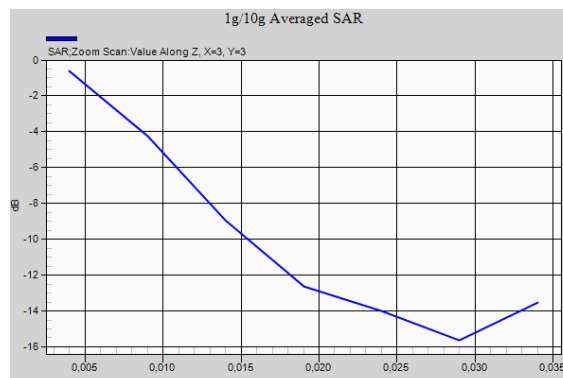

2450 MHz Band – Secondary Landscape Mode, Chain A – 802.11n* Channel 6

DUT: Dell Patron + Intel 633ANHMW + Yageo; Type: Tablet; Serial: -

Communication System: 802.11; Frequency: 2437 MHz; Duty Cycle: 1:1
 Medium parameters used (interpolated): $f = 2437$ MHz; $\sigma = 2.017$ mho/m; $\epsilon_r = 51.744$; $\rho = 1000$ kg/m³
 Phantom section: Flat Section

DASY5 Configuration:

- Probe: ES3DV3 - SN3052; ConvF(4.14, 4.14, 4.14); Calibrated: 22/10/2010
- Sensor-Surface: 4mm (Mechanical Surface Detection (Locations From Previous Scan Used)), Sensor-Surface: 4mm (Mechanical Surface Detection)
- Electronics: DAE4 Sn669; Calibrated: 03/02/2011
- Phantom: Flat Phantom ELI4.0; Type: QDOVA001BA; Serial: SN:1060
- Measurement SW: DASY52, Version 52.6 (2); SEMCAD X Version 14.4.4 (2829)

2450 MHz - Secondary Landscape/Chain A, 802.11n*, Channel 6/Area Scan (51x231x1): Measurement grid: dx=15mm, dy=15mm

[Info: Interpolated medium parameters used for SAR evaluation.](#)

Maximum value of SAR (interpolated) = 0.327 mW/g

2450 MHz - Secondary Landscape/Chain A, 802.11n*, Channel 6/Zoom Scan (7x7x7)/Cube 0: Measurement grid: dx=5mm, dy=5mm, dz=5mm

Reference Value = 12.268 V/m; Power Drift = -0.12 dB

Peak SAR (extrapolated) = 0.580 W/kg

SAR(1 g) = 0.306 mW/g; SAR(10 g) = 0.162 mW/g

[Info: Interpolated medium parameters used for SAR evaluation.](#)

Maximum value of SAR (measured) = 0.334 mW/g

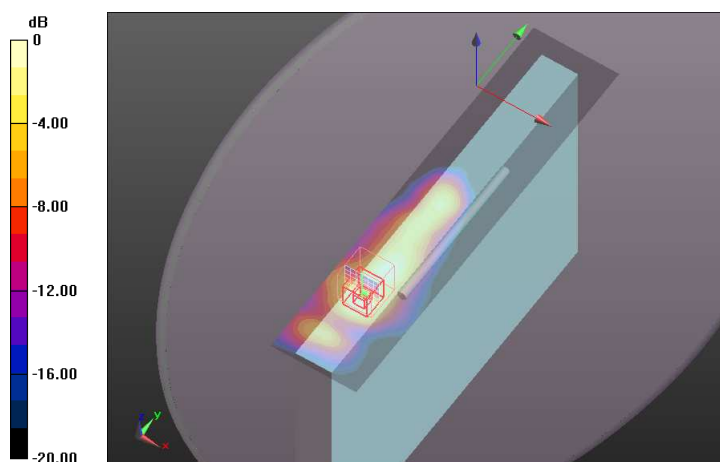

0 dB = 0.330mW/g

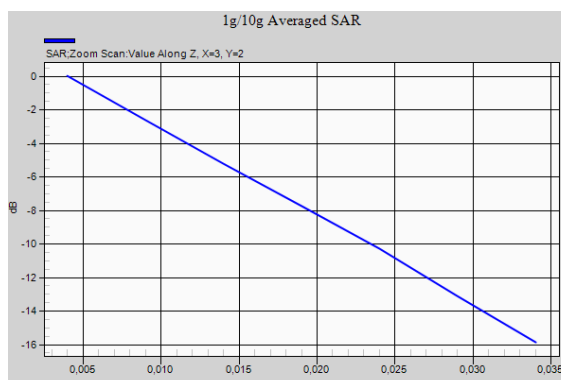

2450 MHz Band – Secondary Landscape Mode, Chain B – 802.11n* Channel 6

DUT: Dell Patron + Intel 633ANHMW + Yageo; Type: Tablet; Serial: -

Communication System: 802.11; Frequency: 2437 MHz; Duty Cycle: 1:1
 Medium parameters used (interpolated): $f = 2437$ MHz; $\sigma = 2.017$ mho/m; $\epsilon_r = 51.744$; $\rho = 1000$ kg/m³
 Phantom section: Flat Section

DASY5 Configuration:

- Probe: ES3DV3 - SN3052; ConvF(4.14, 4.14, 4.14); Calibrated: 22/10/2010
- Sensor-Surface: 4mm (Mechanical Surface Detection (Locations From Previous Scan Used)), Sensor-Surface: 4mm (Mechanical Surface Detection)
- Electronics: DAE4 Sn669; Calibrated: 03/02/2011
- Phantom: Flat Phantom ELI4.0; Type: QDOVA001BA; Serial: SN:1060
- Measurement SW: DASY52, Version 52.6 (2); SEMCAD X Version 14.4.4 (2829)

2450 MHz - Secondary Landscape/Chain B, 802.11n*, Channel 6/Area Scan (51x231x1): Measurement grid: dx=15mm, dy=15mm

[Info: Interpolated medium parameters used for SAR evaluation.](#)

Maximum value of SAR (interpolated) = 0.511 mW/g

2450 MHz - Secondary Landscape/Chain B, 802.11n*, Channel 6/Zoom Scan (7x7x7)/Cube 0: Measurement grid: dx=5mm, dy=5mm, dz=5mm

Reference Value = 15.746 V/m; Power Drift = -0.10 dB

Peak SAR (extrapolated) = 0.936 W/kg

SAR(1 g) = 0.462 mW/g; SAR(10 g) = 0.214 mW/g

[Info: Interpolated medium parameters used for SAR evaluation.](#)

Maximum value of SAR (measured) = 0.517 mW/g

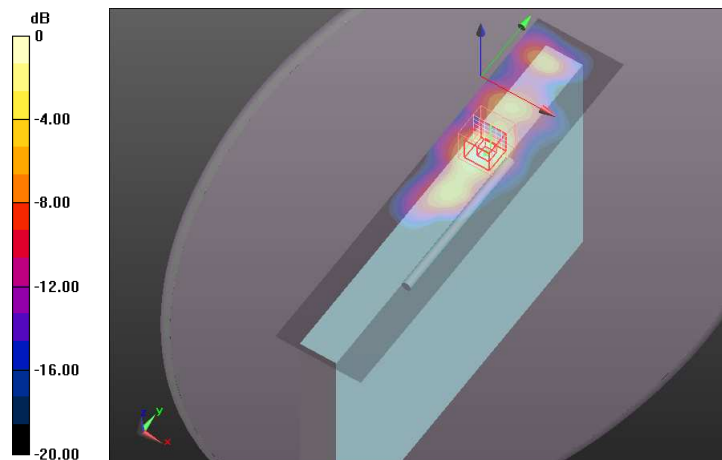

0 dB = 0.520mW/g

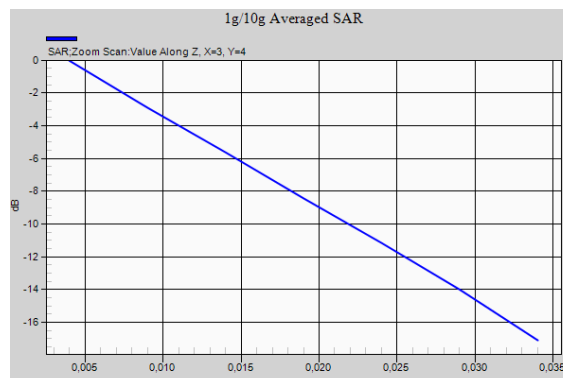

2450 MHz Band – Secondary Landscape Mode, Chain C – 802.11n* Channel 6

DUT: Dell Patron + Intel 633ANHMW + Yageo; Type: Tablet; Serial: -

Communication System: 802.11; Frequency: 2437 MHz; Duty Cycle: 1:1
 Medium parameters used (interpolated): $f = 2437$ MHz; $\sigma = 2.017$ mho/m; $\epsilon_r = 51.744$; $\rho = 1000$ kg/m³
 Phantom section: Flat Section

DASY5 Configuration:

- Probe: ES3DV3 - SN3052; ConvF(4.14, 4.14, 4.14); Calibrated: 22/10/2010
- Sensor-Surface: 4mm (Mechanical Surface Detection (Locations From Previous Scan Used)), Sensor-Surface: 4mm (Mechanical Surface Detection)
- Electronics: DAE4 Sn669; Calibrated: 03/02/2011
- Phantom: Flat Phantom ELI4.0; Type: QDOVA001BA; Serial: SN:1060
- Measurement SW: DASY52, Version 52.6 (2); SEMCAD X Version 14.4.4 (2829)

2450 MHz - Secondary Landscape/Chain C, 802.11n*, Channel 6/Area Scan (51x231x1): Measurement grid: dx=15mm, dy=15mm

[Info: Interpolated medium parameters used for SAR evaluation.](#)

Maximum value of SAR (interpolated) = 0.403 mW/g

2450 MHz - Secondary Landscape/Chain C, 802.11n*, Channel 6/Zoom Scan (7x8x7)/Cube 0: Measurement grid: dx=5mm, dy=5mm, dz=5mm

Reference Value = 14.114 V/m; Power Drift = -0.03 dB

Peak SAR (extrapolated) = 0.750 W/kg

SAR(1 g) = 0.357 mW/g; SAR(10 g) = 0.160 mW/g

[Info: Interpolated medium parameters used for SAR evaluation.](#)

Maximum value of SAR (measured) = 0.421 mW/g

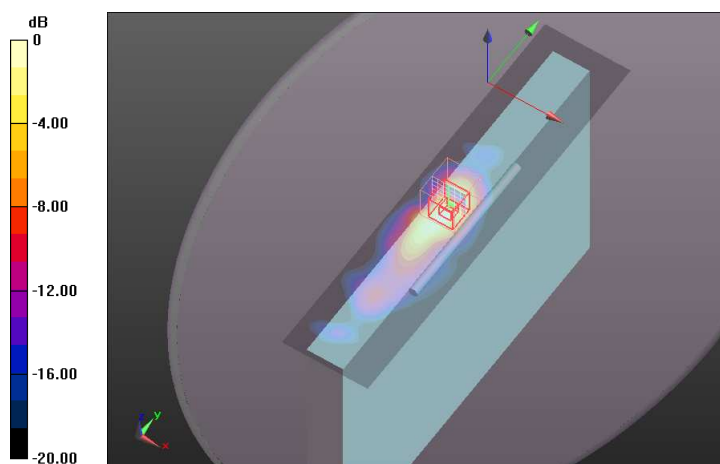

0 dB = 0.420mW/g

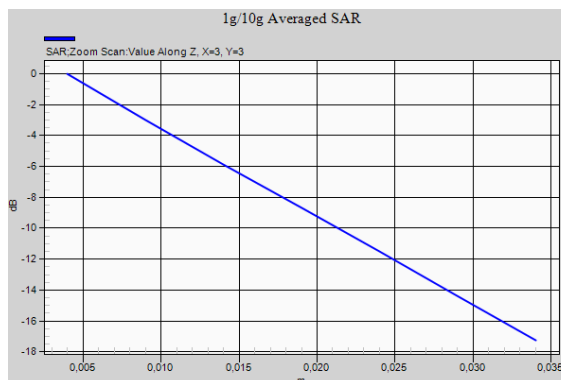

5200 MHz Band – Lapheld Mode, Chain A – 802.11n* Channel 38

DUT: Dell Patron + Intel 633ANHMW + Yageo; Type: Tablet; Serial: -

Communication System: 802.11; Frequency: 5190 MHz; Duty Cycle: 1:1
 Medium parameters used (interpolated): $f = 5190$ MHz; $\sigma = 5.08$ mho/m; $\epsilon_r = 49.43$; $\rho = 1000$ kg/m³
 Phantom section: Flat Section

DASY5 Configuration:

- Probe: EX3DV4 - SN3687; ConvF(4.08, 4.08, 4.08); Calibrated: 16/03/2009
- Sensor-Surface: 2mm (Mechanical Surface Detection (Locations From Previous Scan Used)), Sensor-Surface: 2mm (Mechanical Surface Detection)
- Electronics: DAE4 Sn669; Calibrated: 03/02/2011
- Phantom: Flat Phantom ELI4.0; Type: QDOVA001BA; Serial: SN:1060
- Measurement SW: DASY52, Version 52.6 (2); SEMCAD X Version 14.4.4 (2829)

Lapheld/Chain A, 802.11n*, Channel 38/Area Scan (81x301x1): Measurement grid: dx=10mm, dy=10mm

[Info: Interpolated medium parameters used for SAR evaluation.](#)

Maximum value of SAR (interpolated) = 0.475 mW/g

Lapheld/Chain A, 802.11n*, Channel 38/Zoom Scan (9x9x11)/Cube 0: Measurement grid: dx=4mm, dy=4mm, dz=2mm

Reference Value = 7.707 V/m; Power Drift = 0.06 dB

Peak SAR (extrapolated) = 0.990 W/kg

SAR(1 g) = 0.333 mW/g; SAR(10 g) = 0.174 mW/g

[Info: Interpolated medium parameters used for SAR evaluation.](#)

Maximum value of SAR (measured) = 0.419 mW/g

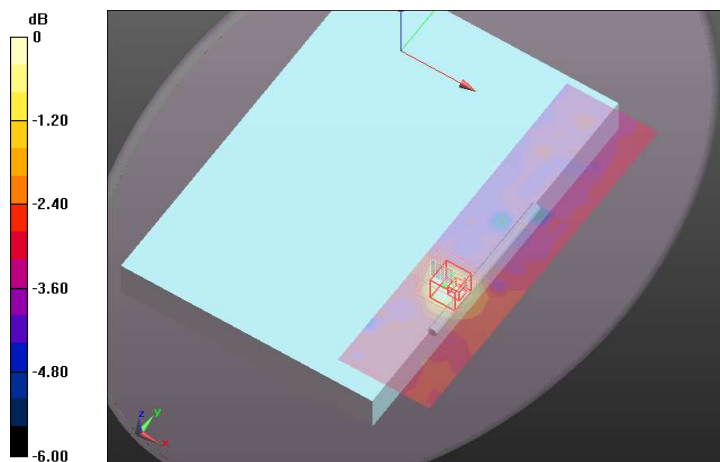

0 dB = 0.420mW/g

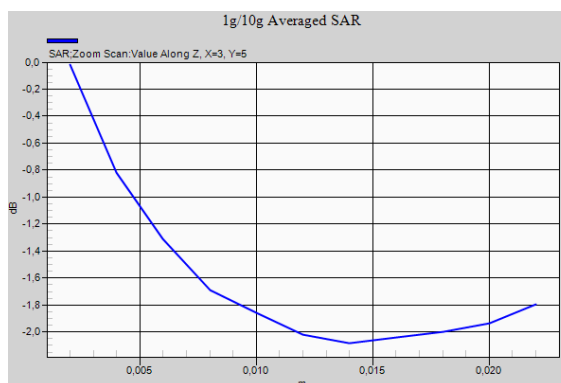

5200 MHz Band – Lapheld Mode, Chain B – 802.11n* Channel 46

DUT: Dell Patron + Intel 633ANHMW + Yageo; Type: Tablet; Serial: -

Communication System: 802.11; Frequency: 5230 MHz; Duty Cycle: 1:1
 Medium parameters used (interpolated): $f = 5230$ MHz; $\sigma = 5.13$ mho/m; $\epsilon_r = 49.31$; $\rho = 1000$ kg/m³
 Phantom section: Flat Section

DASY5 Configuration:

- Probe: EX3DV4 - SN3687; ConvF(4.08, 4.08, 4.08); Calibrated: 16/03/2009
- Sensor-Surface: 2mm (Mechanical Surface Detection (Locations From Previous Scan Used)), Sensor-Surface: 2mm (Mechanical Surface Detection)
- Electronics: DAE4 Sn669; Calibrated: 03/02/2011
- Phantom: Flat Phantom ELI4.0; Type: QDOVA001BA; Serial: SN:1060
- Measurement SW: DASY52, Version 52.6 (2); SEMCAD X Version 14.4.4 (2829)

Lapheld/Chain B, 802.11n*, Channel 46/Area Scan (81x301x1): Measurement grid: dx=10mm, dy=10mm

[Info: Interpolated medium parameters used for SAR evaluation.](#)

Maximum value of SAR (interpolated) = 0.532 mW/g

Lapheld/Chain B, 802.11n*, Channel 46/Zoom Scan (9x9x11)/Cube 0: Measurement grid: dx=4mm, dy=4mm, dz=2mm

Reference Value = 11.076 V/m; Power Drift = -0.06 dB

Peak SAR (extrapolated) = 0.992 W/kg

SAR(1 g) = 0.391 mW/g; SAR(10 g) = 0.303 mW/g

[Info: Interpolated medium parameters used for SAR evaluation.](#)

Maximum value of SAR (measured) = 0.869 mW/g

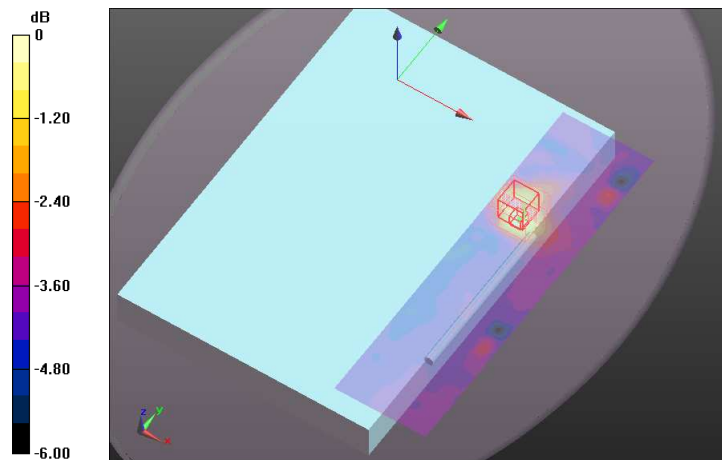

0 dB = 0.530mW/g

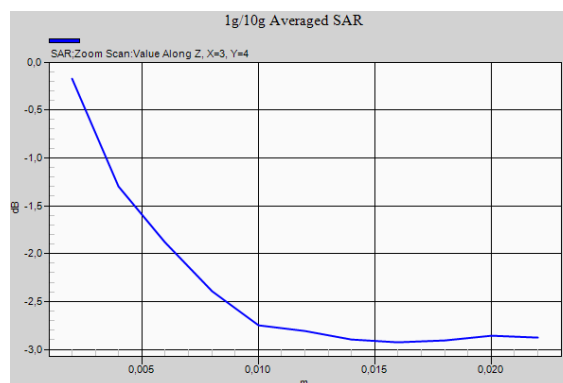

5200 MHz Band – Lapheld Mode, Chain C – 802.11n* Channel 62

DUT: Dell Patron + Intel 633ANHMW + Yageo; Type: Tablet; Serial: -

Communication System: 802.11; Frequency: 5310 MHz; Duty Cycle: 1:1
 Medium parameters used (interpolated): $f = 5310$ MHz; $\sigma = 5.235$ mho/m; $\epsilon_r = 49.13$; $\rho = 1000$ kg/m³
 Phantom section: Flat Section

DASY5 Configuration:

- Probe: EX3DV4 - SN3687; ConvF(4.08, 4.08, 4.08); Calibrated: 16/03/2009
- Sensor-Surface: 2mm (Mechanical Surface Detection (Locations From Previous Scan Used)), Sensor-Surface: 2mm (Mechanical Surface Detection)
- Electronics: DAE4 Sn669; Calibrated: 03/02/2011
- Phantom: Flat Phantom ELI4.0; Type: QDOVA001BA; Serial: SN:1060
- Measurement SW: DASY52, Version 52.6 (2); SEMCAD X Version 14.4.4 (2829)

Lapheld/Chain C, 802.11n*, Channel 62/Area Scan (81x301x1): Measurement grid: dx=10mm, dy=10mm

[Info: Interpolated medium parameters used for SAR evaluation.](#)

Maximum value of SAR (interpolated) = 0.175 mW/g

Lapheld/Chain C, 802.11n*, Channel 62/Zoom Scan (9x9x11)/Cube 0: Measurement grid: dx=4mm, dy=4mm, dz=2mm

Reference Value = 5.009 V/m; Power Drift = 0.26 dB

Peak SAR (extrapolated) = 0.393 W/kg

SAR(1 g) = 0.058 mW/g; SAR(10 g) = 0.020 mW/g

[Info: Interpolated medium parameters used for SAR evaluation.](#)

Maximum value of SAR (measured) = 0.129 mW/g

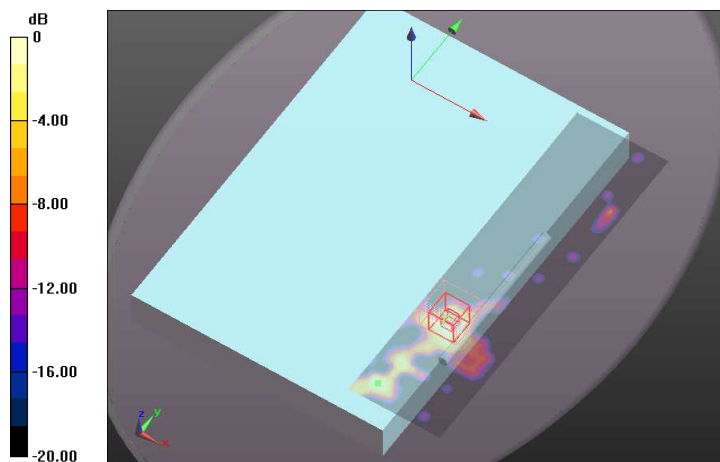

0 dB = 0.130mW/g

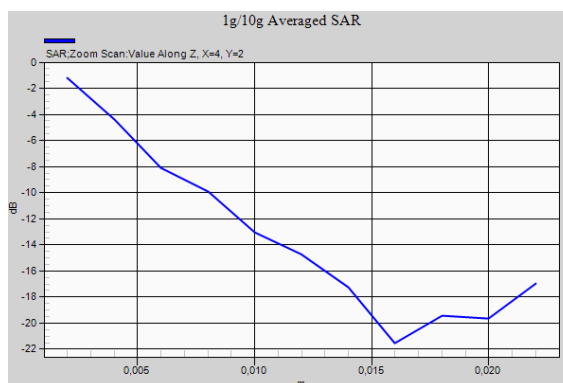

5200 MHz Band – Secondary Portrait Mode, Chain A – 802.11n* Channel 38

DUT: Dell Patron + Intel 633ANHMW + Yageo; Type: Tablet; Serial: -

Communication System: 802.11; Frequency: 5190 MHz; Duty Cycle: 1:1
 Medium parameters used (interpolated): $f = 5190$ MHz; $\sigma = 5.08$ mho/m; $\epsilon_r = 49.43$; $\rho = 1000$ kg/m³
 Phantom section: Flat Section

DASY5 Configuration:

- Probe: EX3DV4 - SN3687; ConvF(4.08, 4.08, 4.08); Calibrated: 16/03/2009
- Sensor-Surface: 2mm (Mechanical Surface Detection (Locations From Previous Scan Used)), Sensor-Surface: 2mm (Mechanical Surface Detection)
- Electronics: DAE4 Sn669; Calibrated: 03/02/2011
- Phantom: Flat Phantom ELI4.0; Type: QDOVA001BA; Serial: SN:1060
- Measurement SW: DASY52, Version 52.6 (2); SEMCAD X Version 14.4.4 (2829)

Secondary Portrait/Chain A, 802.11n*, Channel 38/Area Scan (61x251x1): Measurement grid: dx=10mm, dy=10mm

[Info: Interpolated medium parameters used for SAR evaluation.](#)

Maximum value of SAR (interpolated) = 0.052 mW/g

Secondary Portrait/Chain A, 802.11n*, Channel 38/Zoom Scan (9x8x11)/Cube 0: Measurement grid: dx=4mm, dy=4mm, dz=2mm

Reference Value = 1.743 V/m; Power Drift = 0.231 dB

Peak SAR (extrapolated) = 0.207 W/kg

SAR(1 g) = 0.017 mW/g; SAR(10 g) = 0.00507 mW/g

[Info: Interpolated medium parameters used for SAR evaluation.](#)

Maximum value of SAR (measured) = 0.032 mW/g

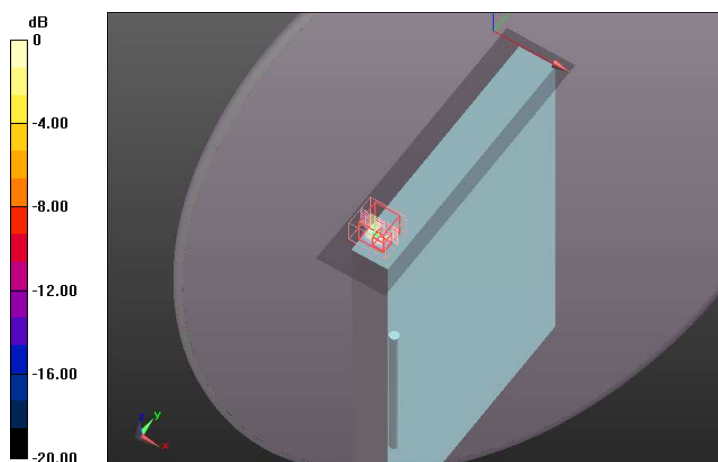

0 dB = 0.030mW/g

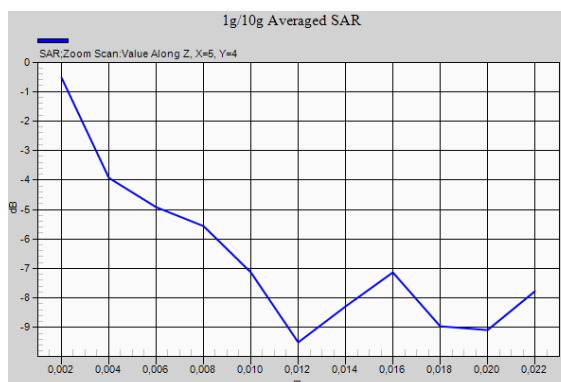

5200 MHz Band – Secondary Portrait Mode, Chain B – 802.11n* Channel 46

DUT: Dell Patron + Intel 633ANHMW + Yageo; Type: Tablet; Serial: -

Communication System: 802.11; Frequency: 5230 MHz; Duty Cycle: 1:1
 Medium parameters used (interpolated): $f = 5230$ MHz; $\sigma = 5.13$ mho/m; $\epsilon_r = 49.31$; $\rho = 1000$ kg/m³
 Phantom section: Flat Section

DASY5 Configuration:

- Probe: EX3DV4 - SN3687; ConvF(4.08, 4.08, 4.08); Calibrated: 16/03/2009
- Sensor-Surface: 2mm (Mechanical Surface Detection (Locations From Previous Scan Used)), Sensor-Surface: 2mm (Mechanical Surface Detection)
- Electronics: DAE4 Sn669; Calibrated: 03/02/2011
- Phantom: Flat Phantom ELI4.0; Type: QDOVA001BA; Serial: SN:1060
- Measurement SW: DASY52, Version 52.6 (2); SEMCAD X Version 14.4.4 (2829)

Secondary Portrait/Chain B, 802.11n*, Channel 46/Area Scan (61x251x1): Measurement grid: dx=10mm, dy=10mm

[Info: Interpolated medium parameters used for SAR evaluation.](#)

Maximum value of SAR (interpolated) = 0.304 mW/g

Secondary Portrait/Chain B, 802.11n*, Channel 46/Zoom Scan (9x11x11)/Cube 0: Measurement grid: dx=4mm, dy=4mm, dz=2mm

Reference Value = 3.955 V/m; Power Drift = 0.29 dB

Peak SAR (extrapolated) = 0.757 W/kg

SAR(1 g) = 0.038 mW/g; SAR(10 g) = 0.00561 mW/g

[Info: Interpolated medium parameters used for SAR evaluation.](#)

Maximum value of SAR (measured) = 0.130 mW/g

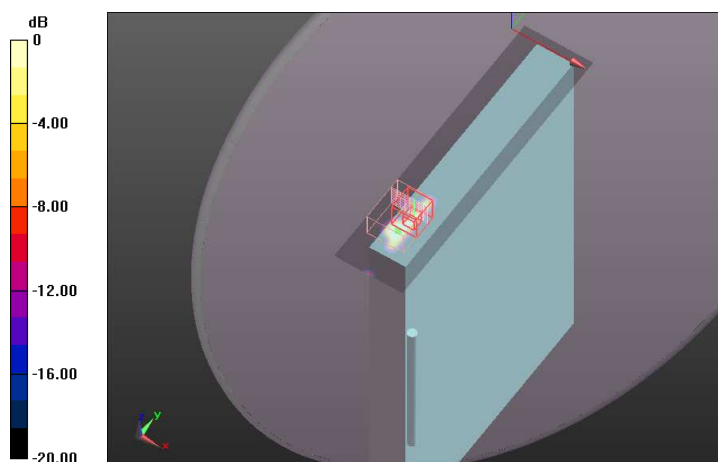

0 dB = 0.130mW/g

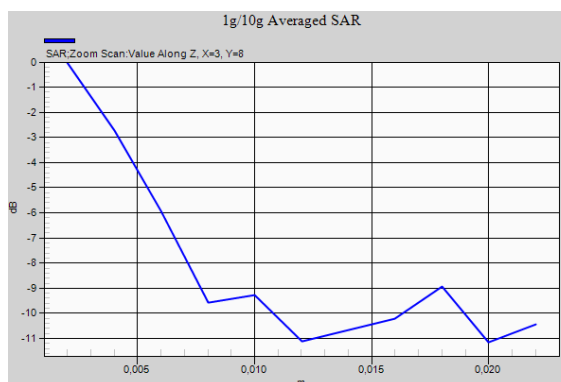

5200 MHz Band – Secondary Portrait Mode, Chain C – 802.11n* Channel 62

DUT: Dell Patron + Intel 633ANHMW + Yageo; Type: Tablet; Serial: -

Communication System: 802.11; Frequency: 5310 MHz; Duty Cycle: 1:1
 Medium parameters used (interpolated): $f = 5310$ MHz; $\sigma = 5.235$ mho/m; $\epsilon_r = 49.13$; $\rho = 1000$ kg/m³
 Phantom section: Flat Section

DASY5 Configuration:

- Probe: EX3DV4 - SN3687; ConvF(4.08, 4.08, 4.08); Calibrated: 16/03/2009
- Sensor-Surface: 2mm (Mechanical Surface Detection (Locations From Previous Scan Used)), Sensor-Surface: 2mm (Mechanical Surface Detection)
- Electronics: DAE4 Sn669; Calibrated: 03/02/2011
- Phantom: Flat Phantom ELI4.0; Type: QDOVA001BA; Serial: SN:1060
- Measurement SW: DASY52, Version 52.6 (2); SEMCAD X Version 14.4.4 (2829)

Secondary Portrait/Chain C, 802.11n*, Channel 62/Area Scan (61x251x1): Measurement grid: dx=10mm, dy=10mm

[Info: Interpolated medium parameters used for SAR evaluation.](#)

Maximum value of SAR (interpolated) = 0.052 mW/g

Secondary Portrait/Chain C, 802.11n*, Channel 62/Zoom Scan (8x8x11)/Cube 0: Measurement grid: dx=4mm, dy=4mm, dz=2mm

Reference Value = 2.361 V/m; Power Drift = -0.04 dB

Peak SAR (extrapolated) = 0.157 W/kg

SAR(1 g) = 0.010 mW/g; SAR(10 g) = 0.00241 mW/g

[Info: Interpolated medium parameters used for SAR evaluation.](#)

Maximum value of SAR (measured) = 0.024 mW/g

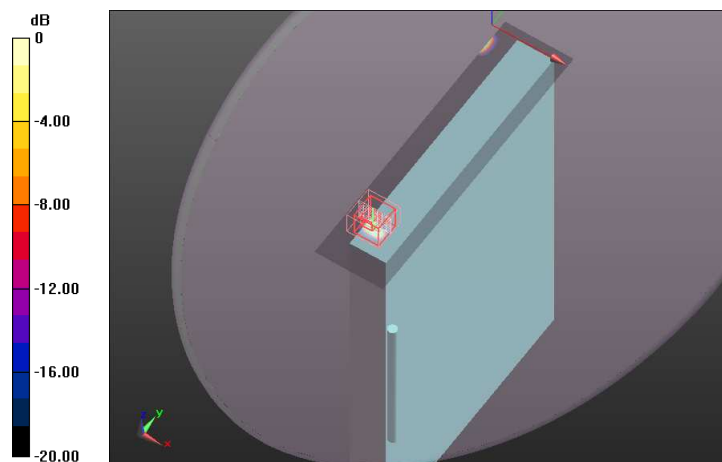

0 dB = 0.020mW/g

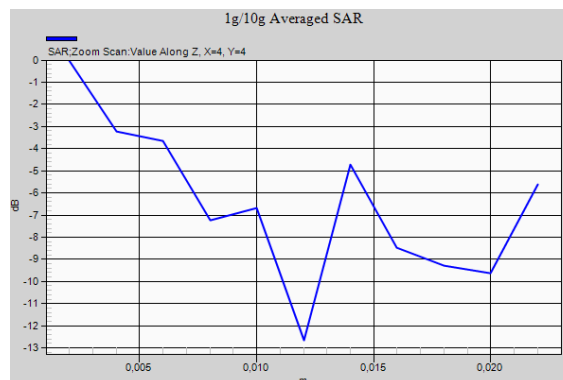

5200 MHz Band – Secondary Landscape Mode, Chain A – 802.11n* Channel 38

DUT: Dell Patron + Intel 633ANHMW + Yageo; Type: Tablet; Serial: -

Communication System: 802.11; Frequency: 5190 MHz; Duty Cycle: 1:1
 Medium parameters used (interpolated): $f = 5190$ MHz; $\sigma = 5.08$ mho/m; $\epsilon_r = 49.43$; $\rho = 1000$ kg/m³
 Phantom section: Flat Section

DASY5 Configuration:

- Probe: EX3DV4 - SN3687; ConvF(4.08, 4.08, 4.08); Calibrated: 16/03/2009
- Sensor-Surface: 2mm (Mechanical Surface Detection (Locations From Previous Scan Used)), Sensor-Surface: 2mm (Mechanical Surface Detection)
- Electronics: DAE4 Sn669; Calibrated: 03/02/2011
- Phantom: Flat Phantom ELI4.0; Type: QDOVA001BA; Serial: SN:1060
- Measurement SW: DASY52, Version 52.6 (2); SEMCAD X Version 14.4.4 (2829)

Secondary Landscape/Chain A, 802.11n*, Channel 38/Area Scan (71x341x1): Measurement grid: dx=10mm, dy=10mm

[Info: Interpolated medium parameters used for SAR evaluation.](#)

Maximum value of SAR (interpolated) = 0.891 mW/g

Secondary Landscape/Chain A, 802.11n*, Channel 38/Zoom Scan (9x9x11)/Cube 0: Measurement grid:

dx=4mm, dy=4mm, dz=2mm

Reference Value = 13.825 V/m; Power Drift = 0.29 dB

Peak SAR (extrapolated) = 1.509 W/kg

SAR(1 g) = 0.435 mW/g; SAR(10 g) = 0.143 mW/g

[Info: Interpolated medium parameters used for SAR evaluation.](#)

Maximum value of SAR (measured) = 0.820 mW/g

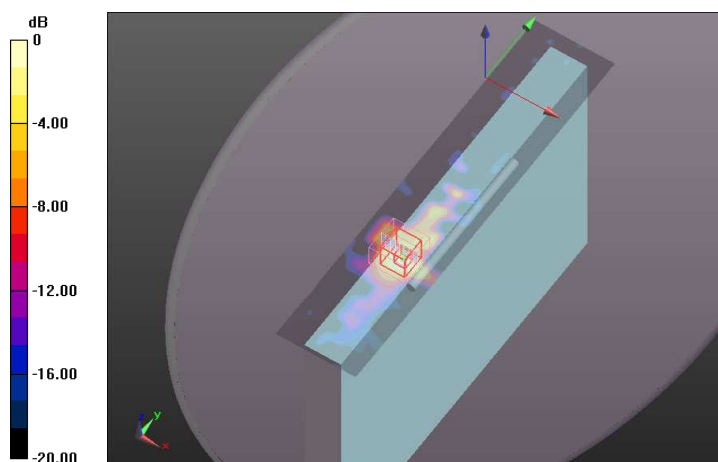

0 dB = 0.820mW/g

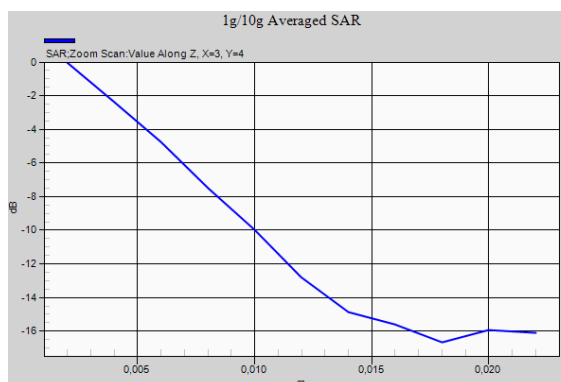

5200 MHz Band – Secondary Landscape Mode, Chain B – 802.11n* Channel 38

DUT: Dell Patron + Intel 633ANHMW + Yageo; Type: Tablet; Serial: -

Communication System: 802.11; Frequency: 5190 MHz; Duty Cycle: 1:1
 Medium parameters used (interpolated): $f = 5190$ MHz; $\sigma = 5.08$ mho/m; $\epsilon_r = 49.43$; $\rho = 1000$ kg/m³
 Phantom section: Flat Section

DASY5 Configuration:

- Probe: EX3DV4 - SN3687; ConvF(4.08, 4.08, 4.08); Calibrated: 16/03/2009
- Sensor-Surface: 2mm (Mechanical Surface Detection (Locations From Previous Scan Used)), Sensor-Surface: 2mm (Mechanical Surface Detection)
- Electronics: DAE4 Sn669; Calibrated: 03/02/2011
- Phantom: Flat Phantom ELI4.0; Type: QDOVA001BA; Serial: SN:1060
- Measurement SW: DASY52, Version 52.6 (2); SEMCAD X Version 14.4.4 (2829)

Secondary Landscape/Chain B, 802.11n*, Channel 38/Area Scan (71x341x1): Measurement grid: dx=10mm, dy=10mm

[Info: Interpolated medium parameters used for SAR evaluation.](#)

Maximum value of SAR (interpolated) = 1.792 mW/g

Secondary Landscape/Chain B, 802.11n*, Channel 38/Zoom Scan (8x8x11)/Cube 0: Measurement grid:

dx=4mm, dy=4mm, dz=2mm

Reference Value = 20.089 V/m; Power Drift = -0.14 dB

Peak SAR (extrapolated) = 3.145 W/kg

SAR(1 g) = 0.878 mW/g; SAR(10 g) = 0.317 mW/g

[Info: Interpolated medium parameters used for SAR evaluation.](#)

Maximum value of SAR (measured) = 1.659 mW/g

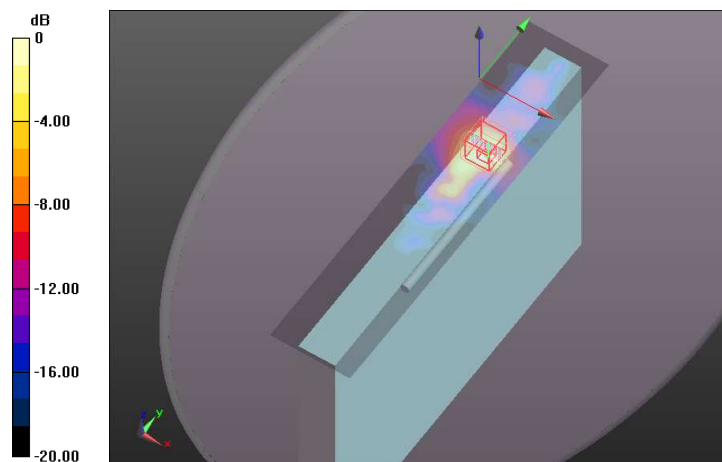

0 dB = 1.660mW/g

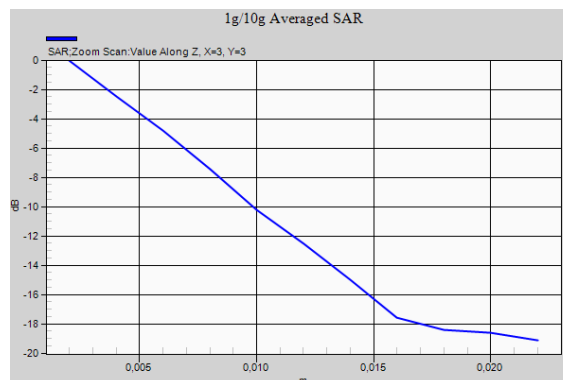

5200 MHz Band – Secondary Landscape Mode, Chain B – 802.11n* Channel 46

DUT: Dell Patron + Intel 633ANHMW + Yageo; Type: Tablet; Serial: -

Communication System: 802.11; Frequency: 5230 MHz; Duty Cycle: 1:1
 Medium parameters used (interpolated): $f = 5230$ MHz; $\sigma = 5.13$ mho/m; $\epsilon_r = 49.31$; $\rho = 1000$ kg/m³
 Phantom section: Flat Section

DASY5 Configuration:

- Probe: EX3DV4 - SN3687; ConvF(4.08, 4.08, 4.08); Calibrated: 16/03/2009
- Sensor-Surface: 2mm (Mechanical Surface Detection (Locations From Previous Scan Used)), Sensor-Surface: 2mm (Mechanical Surface Detection)
- Electronics: DAE4 Sn669; Calibrated: 03/02/2011
- Phantom: Flat Phantom ELI4.0; Type: QDOVA001BA; Serial: SN:1060
- Measurement SW: DASY52, Version 52.6 (2); SEMCAD X Version 14.4.4 (2829)

Secondary Landscape/Chain B, 802.11n*, Channel 46/Area Scan (71x341x1): Measurement grid: dx=10mm, dy=10mm

[Info: Interpolated medium parameters used for SAR evaluation.](#)

Maximum value of SAR (interpolated) = 1.582 mW/g

Secondary Landscape/Chain B, 802.11n*, Channel 46/Zoom Scan (8x8x11)/Cube 0: Measurement grid:

dx=4mm, dy=4mm, dz=2mm

Reference Value = 19.981 V/m; Power Drift = -0.35 dB

Peak SAR (extrapolated) = 3.092 W/kg

SAR(1 g) = 0.857 mW/g; SAR(10 g) = 0.308 mW/g

[Info: Interpolated medium parameters used for SAR evaluation.](#)

Maximum value of SAR (measured) = 1.601 mW/g

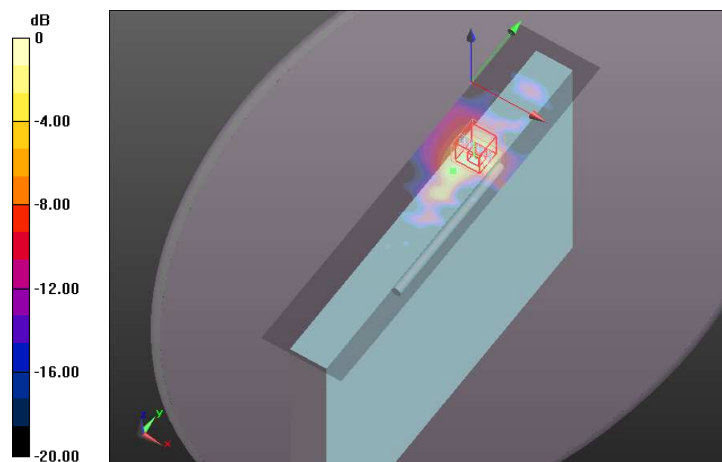

0 dB = 1.600mW/g

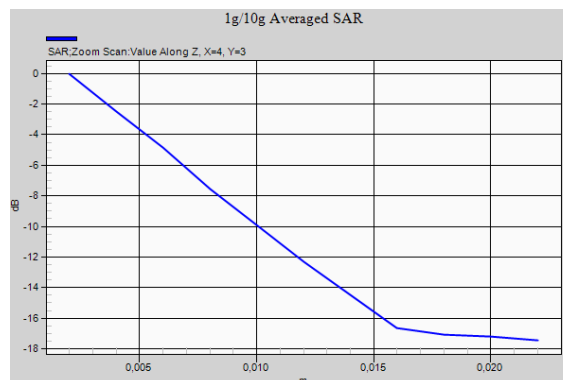

5200 MHz Band – Secondary Landscape Mode, Chain B – 802.11n* Channel 54

DUT: Dell Patron + Intel 633ANHMW + Yageo; Type: Tablet; Serial: -

Communication System: 802.11; Frequency: 5270 MHz; Duty Cycle: 1:1
 Medium parameters used (interpolated): $f = 5270$ MHz; $\sigma = 5.185$ mho/m; $\epsilon_r = 49.21$; $\rho = 1000$ kg/m³
 Phantom section: Flat Section

DASY5 Configuration:

- Probe: EX3DV4 - SN3687; ConvF(4.08, 4.08, 4.08); Calibrated: 16/03/2009
- Sensor-Surface: 2mm (Mechanical Surface Detection (Locations From Previous Scan Used)), Sensor-Surface: 2mm (Mechanical Surface Detection)
- Electronics: DAE4 Sn669; Calibrated: 03/02/2011
- Phantom: Flat Phantom ELI4.0; Type: QDOVA001BA; Serial: SN:1060
- Measurement SW: DASY52, Version 52.6 (2); SEMCAD X Version 14.4.4 (2829)

Secondary Landscape/Chain B, 802.11n*, Channel 54/Area Scan (71x341x1): Measurement grid: dx=10mm, dy=10mm

[Info: Interpolated medium parameters used for SAR evaluation.](#)

Maximum value of SAR (interpolated) = 1.455 mW/g

Secondary Landscape/Chain B, 802.11n*, Channel 54/Zoom Scan (8x8x11)/Cube 0: Measurement grid:

dx=4mm, dy=4mm, dz=2mm

Reference Value = 17.947 V/m; Power Drift = -0.15 dB

Peak SAR (extrapolated) = 2.647 W/kg

SAR(1 g) = 0.735 mW/g; SAR(10 g) = 0.270 mW/g

[Info: Interpolated medium parameters used for SAR evaluation.](#)

Maximum value of SAR (measured) = 1.341 mW/g

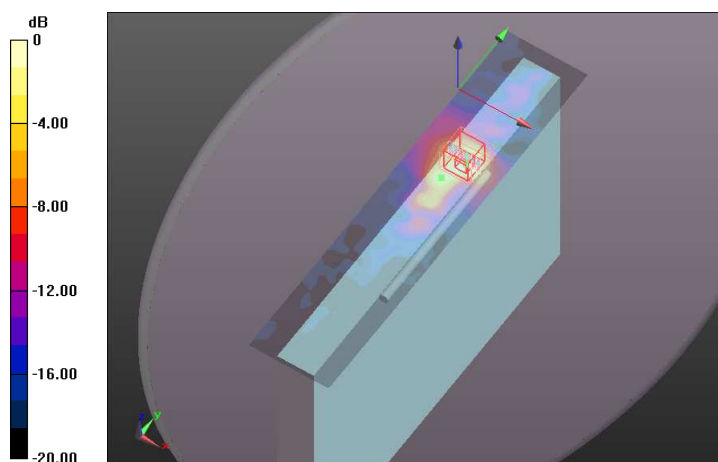

0 dB = 1.340mW/g

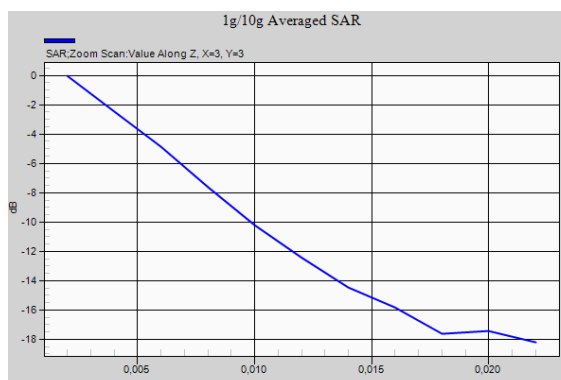

5200 MHz Band – Secondary Landscape Mode, Chain B – 802.11n* Channel 62

DUT: Dell Patron + Intel 633ANHMW + Yageo; Type: Tablet; Serial: -

Communication System: 802.11; Frequency: 5310 MHz; Duty Cycle: 1:1
 Medium parameters used (interpolated): $f = 5310$ MHz; $\sigma = 5.235$ mho/m; $\epsilon_r = 49.13$; $\rho = 1000$ kg/m³
 Phantom section: Flat Section

DASY5 Configuration:

- Probe: EX3DV4 - SN3687; ConvF(4.08, 4.08, 4.08); Calibrated: 16/03/2009
- Sensor-Surface: 2mm (Mechanical Surface Detection (Locations From Previous Scan Used)), Sensor-Surface: 2mm (Mechanical Surface Detection)
- Electronics: DAE4 Sn669; Calibrated: 03/02/2011
- Phantom: Flat Phantom ELI4.0; Type: QDOVA001BA; Serial: SN:1060
- Measurement SW: DASY52, Version 52.6 (2); SEMCAD X Version 14.4.4 (2829)

Secondary Landscape/Chain B, 802.11n*, Channel 62/Area Scan (71x341x1): Measurement grid: dx=10mm, dy=10mm

[Info: Interpolated medium parameters used for SAR evaluation.](#)

Maximum value of SAR (interpolated) = 1.835 mW/g

Secondary Landscape/Chain B, 802.11n*, Channel 62/Zoom Scan (8x8x11)/Cube 0: Measurement grid:

dx=4mm, dy=4mm, dz=2mm

Reference Value = 20.326 V/m; Power Drift = -0.31 dB

Peak SAR (extrapolated) = 3.236 W/kg

SAR(1 g) = 0.889 mW/g; SAR(10 g) = 0.329 mW/g

[Info: Interpolated medium parameters used for SAR evaluation.](#)

Maximum value of SAR (measured) = 1.644 mW/g

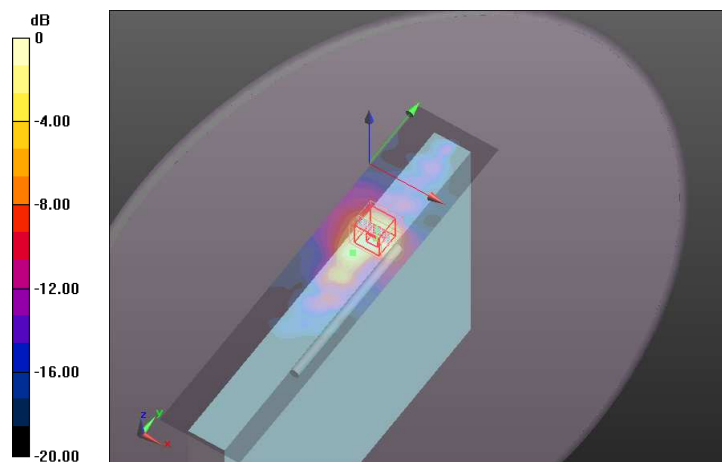

0 dB = 1.640mW/g

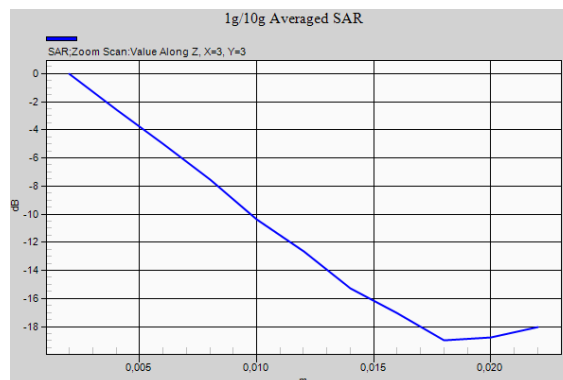

5200 MHz Band – Secondary Landscape Mode, Chain C – 802.11n* Channel 62

DUT: Dell Patron + Intel 633ANHMW + Yageo; Type: Tablet; Serial: -

Communication System: 802.11; Frequency: 5310 MHz; Duty Cycle: 1:1
 Medium parameters used (interpolated): $f = 5310$ MHz; $\sigma = 5.235$ mho/m; $\epsilon_r = 49.13$; $\rho = 1000$ kg/m³
 Phantom section: Flat Section

DASY5 Configuration:

- Probe: EX3DV4 - SN3687; ConvF(4.08, 4.08, 4.08); Calibrated: 16/03/2009
- Sensor-Surface: 2mm (Mechanical Surface Detection (Locations From Previous Scan Used)), Sensor-Surface: 2mm (Mechanical Surface Detection)
- Electronics: DAE4 Sn669; Calibrated: 03/02/2011
- Phantom: Flat Phantom ELI4.0; Type: QDOVA001BA; Serial: SN:1060
- Measurement SW: DASY52, Version 52.6 (2); SEMCAD X Version 14.4.4 (2829)

Secondary Landscape/Chain C, 802.11n*, Channel 62/Area Scan (71x341x1): Measurement grid: dx=10mm, dy=10mm

[Info: Interpolated medium parameters used for SAR evaluation.](#)

Maximum value of SAR (interpolated) = 0.907 mW/g

Secondary Landscape/Chain C, 802.11n*, Channel 62/Zoom Scan (8x8x11)/Cube 0: Measurement grid:

dx=4mm, dy=4mm, dz=2mm

Reference Value = 13.846 V/m; Power Drift = -0.03 dB

Peak SAR (extrapolated) = 1.604 W/kg

SAR(1 g) = 0.444 mW/g; SAR(10 g) = 0.145 mW/g

[Info: Interpolated medium parameters used for SAR evaluation.](#)

Maximum value of SAR (measured) = 0.833 mW/g

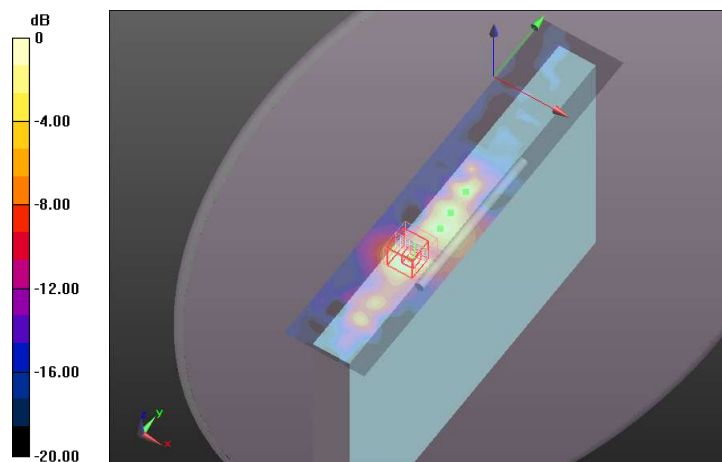

0 dB = 0.830mW/g

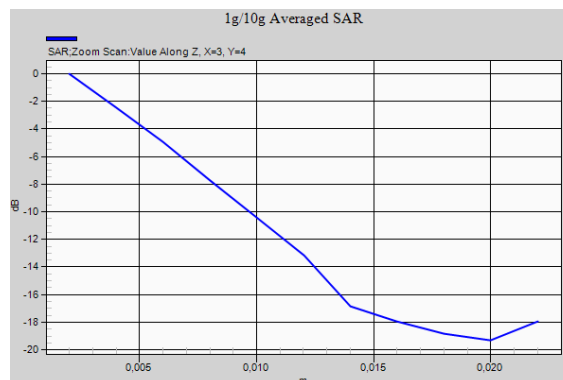

5600 MHz Band – Lapheld Mode, Chain A – 802.11n* Channel 134

DUT: Dell Patron + Intel 633ANHMW + Yageo; Type: Tablet; Serial: -

Communication System: 802.11; Frequency: 5670 MHz; Duty Cycle: 1:1
 Medium parameters used (interpolated): $f = 5670$ MHz; $\sigma = 5.725$ mho/m; $\epsilon_r = 48.29$; $\rho = 1000$ kg/m³
 Phantom section: Flat Section

DASY5 Configuration:

- Probe: EX3DV4 - SN3687; ConvF(3.43, 3.43, 3.43); Calibrated: 16/03/2009
- Sensor-Surface: 2mm (Mechanical Surface Detection (Locations From Previous Scan Used)), Sensor-Surface: 2mm (Mechanical Surface Detection)
- Electronics: DAE4 Sn669; Calibrated: 03/02/2011
- Phantom: Flat Phantom ELI4.0; Type: QDOVA001BA; Serial: SN:1060
- Measurement SW: DASY52, Version 52.6 (2); SEMCAD X Version 14.4.4 (2829)

Lapheld/Chain A, 802.11n*, Channel 134/Area Scan (81x301x1): Measurement grid: dx=10mm, dy=10mm

[Info: Interpolated medium parameters used for SAR evaluation.](#)

Maximum value of SAR (interpolated) = 0.975 mW/g

Lapheld/Chain A, 802.11n*, Channel 134/Zoom Scan (8x8x11)/Cube 0: Measurement grid: dx=4mm, dy=4mm, dz=2mm

Reference Value = 6.486 V/m; Power Drift = 0.05 dB

Peak SAR (extrapolated) = 0.869 W/kg

SAR(1 g) = 0.082 mW/g; SAR(10 g) = 0.034 mW/g

[Info: Interpolated medium parameters used for SAR evaluation.](#)

Maximum value of SAR (measured) = 0.201 mW/g

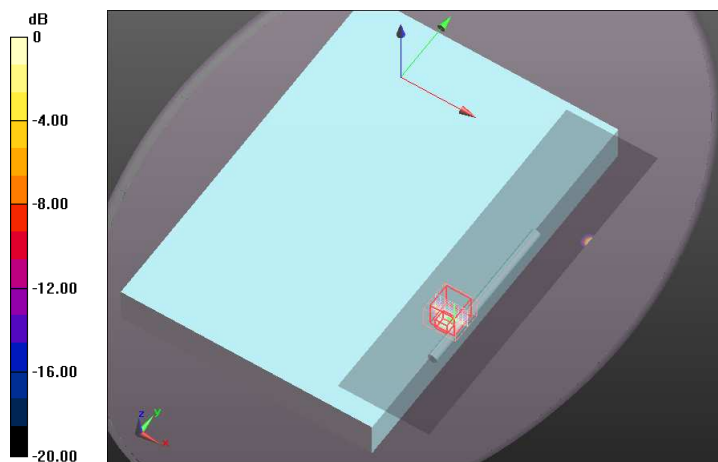

0 dB = 0.200mW/g

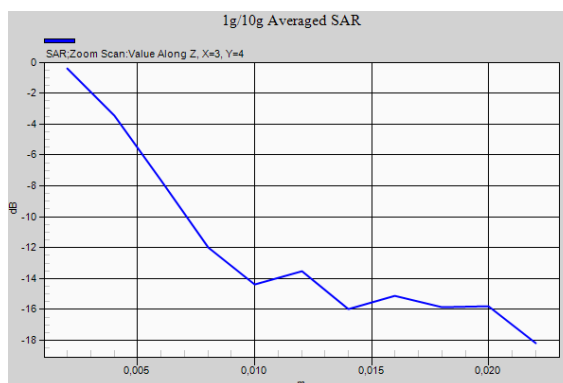

5600 MHz Band – Lapheld Mode, Chain B – 802.11n* Channel 102

DUT: Dell Patron + Intel 633ANHMW + Yageo; Type: Tablet; Serial: -

Communication System: 802.11; Frequency: 5510 MHz; Duty Cycle: 1:1
 Medium parameters used (interpolated): $f = 5510$ MHz; $\sigma = 5.5$ mho/m; $\epsilon_r = 48.665$; $\rho = 1000$ kg/m³
 Phantom section: Flat Section

DASY5 Configuration:
 - Probe: EX3DV4 - SN3687; ConvF(3.43, 3.43, 3.43); Calibrated: 16/03/2009
 - Sensor-Surface: 2mm (Mechanical Surface Detection (Locations From Previous Scan Used)), Sensor-Surface: 2mm (Mechanical Surface Detection)
 - Electronics: DAE4 Sn669; Calibrated: 03/02/2011
 - Phantom: Flat Phantom ELI4.0; Type: QDOVA001BA; Serial: SN:1060
 - Measurement SW: DASY52, Version 52.6 (2); SEMCAD X Version 14.4.4 (2829)

Lapheld/Chain B, 802.11n*, Channel 102/Area Scan (81x301x1): Measurement grid: dx=10mm, dy=10mm

[Info: Interpolated medium parameters used for SAR evaluation.](#)

Maximum value of SAR (interpolated) = 0.525 mW/g

Lapheld/Chain B, 802.11n*, Channel 102/Zoom Scan (9x8x11)/Cube 0: Measurement grid: dx=4mm, dy=4mm, dz=2mm

Reference Value = 11.073 V/m; Power Drift = 0.07 dB

Peak SAR (extrapolated) = 0.929 W/kg

SAR(1 g) = 0.450 mW/g; SAR(10 g) = 0.367 mW/g

[Info: Interpolated medium parameters used for SAR evaluation.](#)

Maximum value of SAR (measured) = 0.577 mW/g

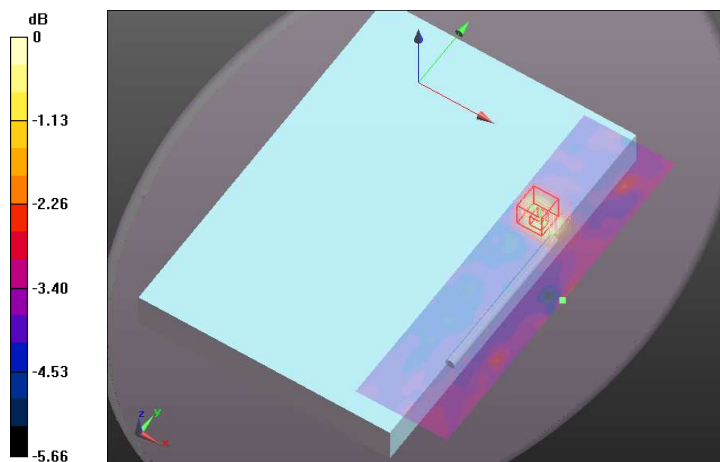

0 dB = 0.580mW/g

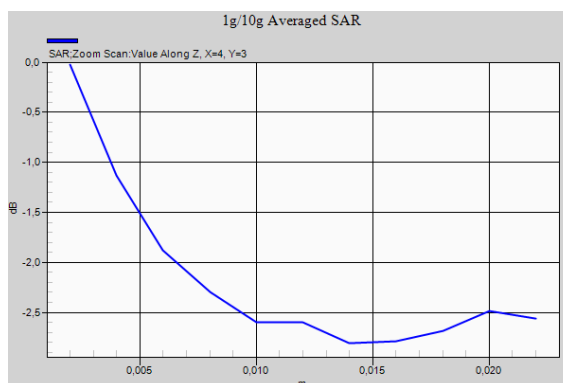

5600 MHz Band – Lapheld Mode, Chain C – 802.11n* Channel 102

DUT: Dell Patron + Intel 633ANHMW + Yageo; Type: Tablet; Serial: -

Communication System: 802.11; Frequency: 5510 MHz; Duty Cycle: 1:1
 Medium parameters used (interpolated): $f = 5510$ MHz; $\sigma = 5.5$ mho/m; $\epsilon_r = 48.665$; $\rho = 1000$ kg/m³
 Phantom section: Flat Section

DASY5 Configuration:

- Probe: EX3DV4 - SN3687; ConvF(3.43, 3.43, 3.43); Calibrated: 16/03/2009
- Sensor-Surface: 2mm (Mechanical Surface Detection (Locations From Previous Scan Used)), Sensor-Surface: 2mm (Mechanical Surface Detection)
- Electronics: DAE4 Sn669; Calibrated: 03/02/2011
- Phantom: Flat Phantom ELI4.0; Type: QDOVA001BA; Serial: SN:1060
- Measurement SW: DASY52, Version 52.6 (2); SEMCAD X Version 14.4.4 (2829)

Lapheld/Chain C, 802.11n*, Channel 102/Area Scan (81x301x1): Measurement grid: dx=10mm, dy=10mm

[Info: Interpolated medium parameters used for SAR evaluation.](#)

Maximum value of SAR (interpolated) = 0.069 mW/g

Lapheld/Chain C, 802.11n*, Channel 102/Zoom Scan 2 (9x10x11)/Cube 0: Measurement grid: dx=4mm, dy=4mm, dz=2mm

Reference Value = 2.689 V/m; Power Drift = 0.23 dB

Peak SAR (extrapolated) = 0.295 W/kg

SAR(1 g) = 0.035 mW/g; SAR(10 g) = 0.011 mW/g

[Info: Interpolated medium parameters used for SAR evaluation.](#)

Maximum value of SAR (measured) = 0.075 mW/g

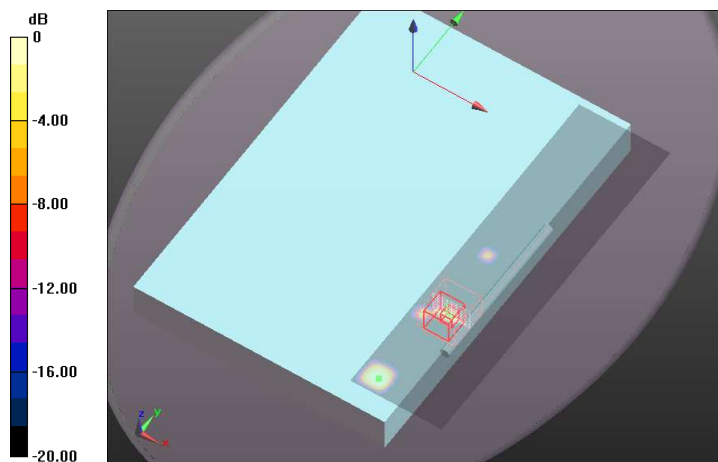

0 dB = 0.070mW/g

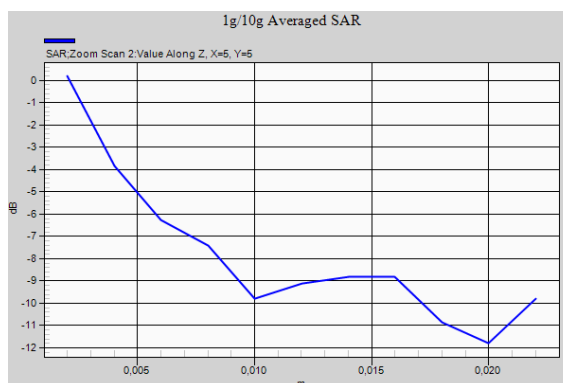

5600 MHz Band – Secondary Portrait Mode, Chain A – 802.11n* Channel 134

DUT: Dell Patron + Intel 633ANHMW + Yageo; Type: Tablet; Serial: -

Communication System: 802.11; Frequency: 5670 MHz; Duty Cycle: 1:1
 Medium parameters used (interpolated): $f = 5670$ MHz; $\sigma = 5.725$ mho/m; $\epsilon_r = 48.29$; $\rho = 1000$ kg/m³
 Phantom section: Flat Section

DASY5 Configuration:

- Probe: EX3DV4 - SN3687; ConvF(3.43, 3.43, 3.43); Calibrated: 16/03/2009
- Sensor-Surface: 2mm (Mechanical Surface Detection (Locations From Previous Scan Used)), Sensor-Surface: 2mm (Mechanical Surface Detection)
- Electronics: DAE4 Sn669; Calibrated: 03/02/2011
- Phantom: Flat Phantom ELI4.0; Type: QDOVA001BA; Serial: SN:1060
- Measurement SW: DASY52, Version 52.6 (2); SEMCAD X Version 14.4.4 (2829)

Secondary Portrait/Chain A, 802.11n*, Channel 134/Area Scan (61x251x1): Measurement grid: dx=10mm, dy=10mm

[Info: Interpolated medium parameters used for SAR evaluation.](#)

Maximum value of SAR (interpolated) = 0.091 mW/g

Secondary Portrait/Chain A, 802.11n*, Channel 134/Zoom Scan (9x9x11)/Cube 0: Measurement grid: dx=4mm, dy=4mm, dz=2mm

Reference Value = 3.746 V/m; Power Drift = -0.17 dB

Peak SAR (extrapolated) = 0.373 W/kg

SAR(1 g) = 0.024 mW/g; SAR(10 g) = 0.00427 mW/g

[Info: Interpolated medium parameters used for SAR evaluation.](#)

Maximum value of SAR (measured) = 0.045 mW/g

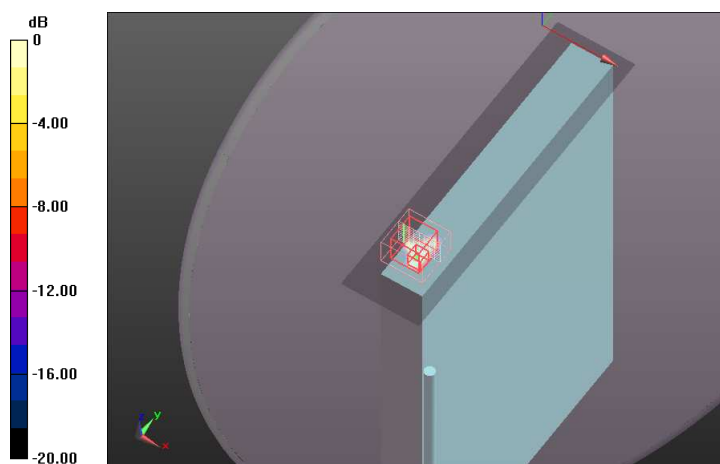

0 dB = 0.030mW/g

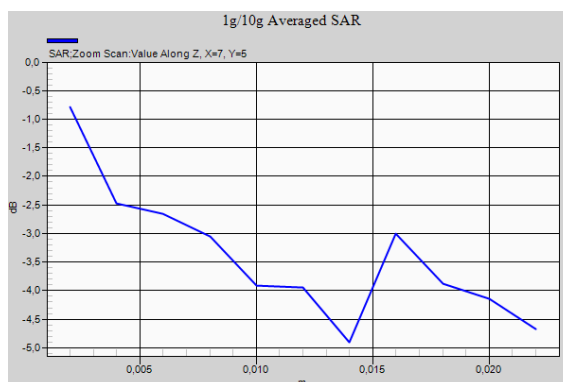

5600 MHz Band – Secondary Portrait Mode, Chain B – 802.11n* Channel 102

DUT: Dell Patron + Intel 633ANHMW + Yageo; Type: Tablet; Serial: -

Communication System: 802.11; Frequency: 5510 MHz; Duty Cycle: 1:1
 Medium parameters used (interpolated): $f = 5510$ MHz; $\sigma = 5.5$ mho/m; $\epsilon_r = 48.665$; $\rho = 1000$ kg/m³
 Phantom section: Flat Section

DASY5 Configuration:

- Probe: EX3DV4 - SN3687; ConvF(3.43, 3.43, 3.43); Calibrated: 16/03/2009
- Sensor-Surface: 2mm (Mechanical Surface Detection (Locations From Previous Scan Used)), Sensor-Surface: 2mm (Mechanical Surface Detection)
- Electronics: DAE4 Sn669; Calibrated: 03/02/2011
- Phantom: Flat Phantom ELI4.0; Type: QDOVA001BA; Serial: SN:1060
- Measurement SW: DASY52, Version 52.6 (2); SEMCAD X Version 14.4.4 (2829)

Secondary Portrait/Chain B, 802.11n*, Channel 102 2/Area Scan (61x251x1): Measurement grid: dx=10mm, dy=10mm

[Info: Interpolated medium parameters used for SAR evaluation.](#)

Maximum value of SAR (interpolated) = 0.145 mW/g

Secondary Portrait/Chain B, 802.11n*, Channel 102 2/Zoom Scan 3 (8x8x11)/Cube 0: Measurement grid:

dx=4mm, dy=4mm, dz=2mm

Reference Value = 3.280 V/m; Power Drift = 0.27 dB

Peak SAR (extrapolated) = 0.273 W/kg

SAR(1 g) = 0.00104 mW/g; SAR(10 g) = 0.000113 mW/g

[Info: Interpolated medium parameters used for SAR evaluation.](#)

Maximum value of SAR (measured) = 0.273 mW/g

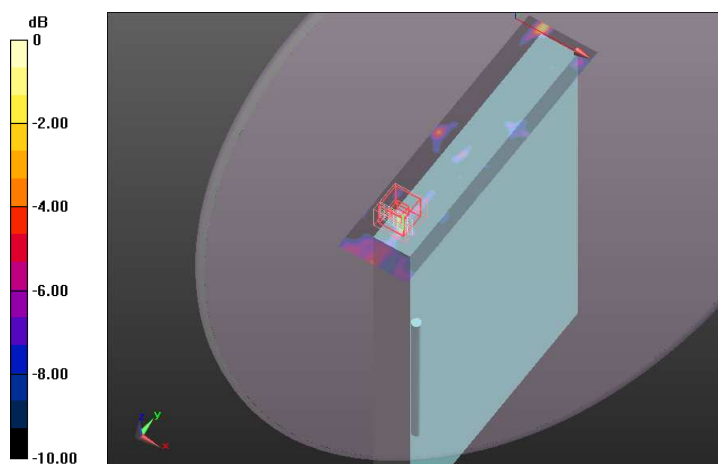

0 dB = 0.150mW/g

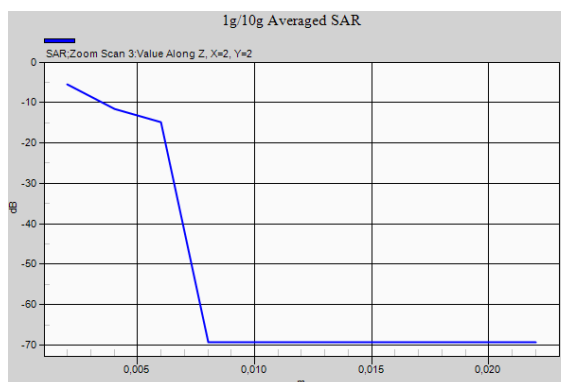

5600 MHz Band – Secondary Portrait Mode, Chain C – 802.11n* Channel 102

DUT: Dell Patron + Intel 633ANHMW + Yageo; Type: Tablet; Serial: -

Communication System: 802.11; Frequency: 5510 MHz; Duty Cycle: 1:1
 Medium parameters used (interpolated): $f = 5510$ MHz; $\sigma = 5.5$ mho/m; $\epsilon_r = 48.665$; $\rho = 1000$ kg/m³
 Phantom section: Flat Section

DASY5 Configuration:

- Probe: EX3DV4 - SN3687; ConvF(3.43, 3.43, 3.43); Calibrated: 16/03/2009
- Sensor-Surface: 2mm (Mechanical Surface Detection (Locations From Previous Scan Used)), Sensor-Surface: 2mm (Mechanical Surface Detection)
- Electronics: DAE4 Sn669; Calibrated: 03/02/2011
- Phantom: Flat Phantom ELI4.0; Type: QDOVA001BA; Serial: SN:1060
- Measurement SW: DASY52, Version 52.6 (2); SEMCAD X Version 14.4.4 (2829)

Secondary Portrait/Chain C, 802.11n*, Channel 102/Area Scan (61x251x1): Measurement grid: dx=10mm, dy=10mm

[Info: Interpolated medium parameters used for SAR evaluation.](#)

Maximum value of SAR (interpolated) = 0.055 mW/g

Secondary Portrait/Chain C, 802.11n*, Channel 102/Zoom Scan (8x8x11)/Cube 0: Measurement grid: dx=4mm, dy=4mm, dz=2mm

Reference Value = 3.265 V/m; Power Drift = 0.13 dB

Peak SAR (extrapolated) = 0.257 W/kg

SAR(1 g) = 0.016 mW/g; SAR(10 g) = 0.00384 mW/g

[Info: Interpolated medium parameters used for SAR evaluation.](#)

Maximum value of SAR (measured) = 0.038 mW/g

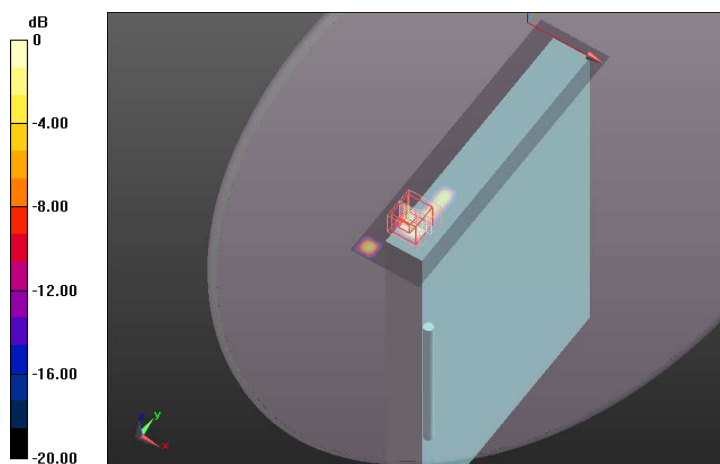

0 dB = 0.040mW/g

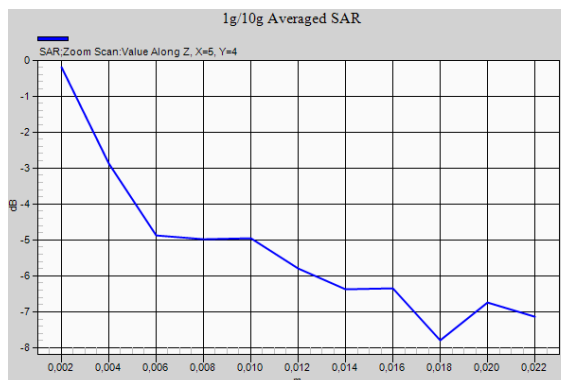

5600 MHz Band – Secondary Landscape Mode, Chain A – 802.11n* Channel 102

DUT: Dell Patron + Intel 633ANHMW + Yageo; Type: Tablet; Serial: -

Communication System: 802.11; Frequency: 5510 MHz; Duty Cycle: 1:1
 Medium parameters used (interpolated): $f = 5510$ MHz; $\sigma = 5.5$ mho/m; $\epsilon_r = 48.665$; $\rho = 1000$ kg/m³
 Phantom section: Flat Section

DASY5 Configuration:

- Probe: EX3DV4 - SN3687; ConvF(3.43, 3.43, 3.43); Calibrated: 16/03/2009
- Sensor-Surface: 2mm (Mechanical Surface Detection (Locations From Previous Scan Used)), Sensor-Surface: 2mm (Mechanical Surface Detection)
- Electronics: DAE4 Sn669; Calibrated: 03/02/2011
- Phantom: Flat Phantom ELI4.0; Type: QDOVA001BA; Serial: SN:1060
- Measurement SW: DASY52, Version 52.6 (2); SEMCAD X Version 14.4.4 (2829)

Secondary Landscape/Chain A, 802.11n*, Channel 102/Area Scan (71x341x1): Measurement grid: dx=10mm, dy=10mm

[Info: Interpolated medium parameters used for SAR evaluation.](#)

Maximum value of SAR (interpolated) = 1.056 mW/g

Secondary Landscape/Chain A, 802.11n*, Channel 102/Zoom Scan (8x8x11)/Cube 0: Measurement grid:

dx=4mm, dy=4mm, dz=2mm

Reference Value = 15.742 V/m; Power Drift = 0.10 dB

Peak SAR (extrapolated) = 2.265 W/kg

SAR(1 g) = 0.593 mW/g; SAR(10 g) = 0.206 mW/g

[Info: Interpolated medium parameters used for SAR evaluation.](#)

Maximum value of SAR (measured) = 1.118 mW/g

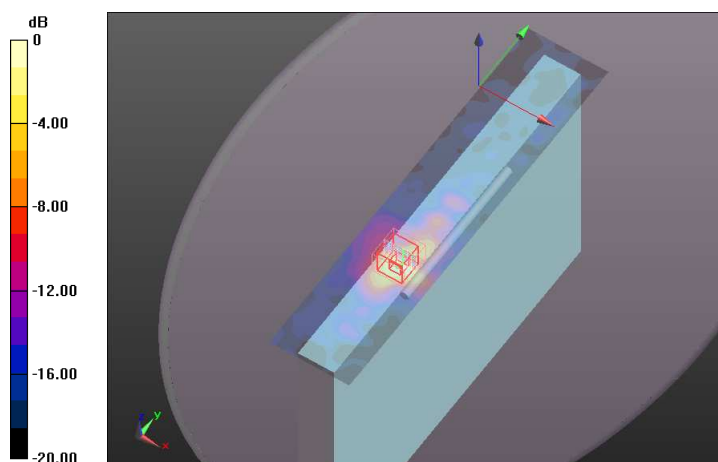

0 dB = 1.120mW/g

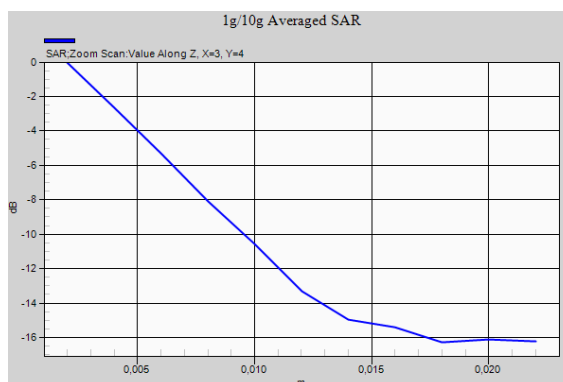

5600 MHz Band – Secondary Landscape Mode, Chain A – 802.11n* Channel 118

DUT: Dell Patron + Intel 633ANHMW + Yageo; Type: Tablet; Serial: -

Communication System: 802.11; Frequency: 5590 MHz; Duty Cycle: 1:1
 Medium parameters used (interpolated): $f = 5590$ MHz; $\sigma = 5.615$ mho/m; $\epsilon_r = 48.48$; $\rho = 1000$ kg/m³
 Phantom section: Flat Section

DASY5 Configuration:

- Probe: EX3DV4 - SN3687; ConvF(3.43, 3.43, 3.43); Calibrated: 16/03/2009
- Sensor-Surface: 2mm (Mechanical Surface Detection (Locations From Previous Scan Used)), Sensor-Surface: 2mm (Mechanical Surface Detection)
- Electronics: DAE4 Sn669; Calibrated: 03/02/2011
- Phantom: Flat Phantom ELI4.0; Type: QDOVA001BA; Serial: SN:1060
- Measurement SW: DASY52, Version 52.6 (2); SEMCAD X Version 14.4.4 (2829)

Secondary Landscape/Chain A, 802.11n*, Channel 118/Area Scan (71x341x1): Measurement grid: dx=10mm, dy=10mm

[Info: Interpolated medium parameters used for SAR evaluation.](#)

Maximum value of SAR (interpolated) = 1.131 mW/g

Secondary Landscape/Chain A, 802.11n*, Channel 118/Zoom Scan (8x8x11)/Cube 0: Measurement grid:

dx=4mm, dy=4mm, dz=2mm

Reference Value = 17.379 V/m; Power Drift = -0.29 dB

Peak SAR (extrapolated) = 2.376 W/kg

SAR(1 g) = 0.657 mW/g; SAR(10 g) = 0.225 mW/g

[Info: Interpolated medium parameters used for SAR evaluation.](#)

Maximum value of SAR (measured) = 1.313 mW/g

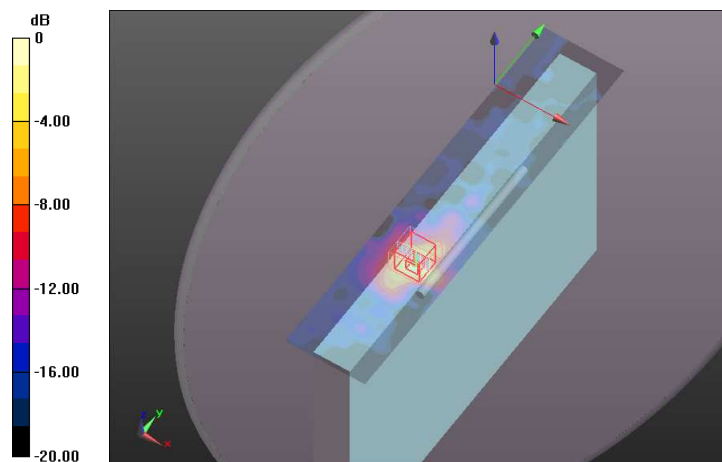

0 dB = 1.310mW/g

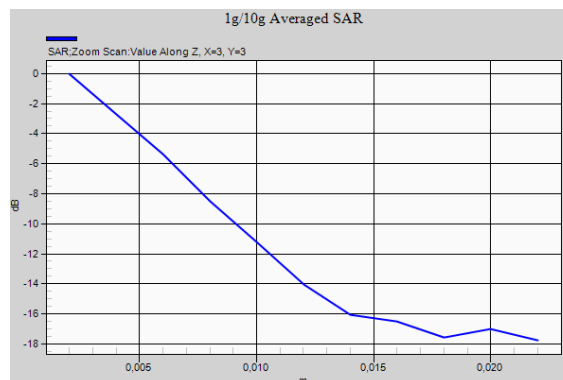

5600 MHz Band – Secondary Landscape Mode, Chain A – 802.11n* Channel 134

DUT: Dell Patron + Intel 633ANHMW + Yageo; Type: Tablet; Serial: -

Communication System: 802.11; Frequency: 5670 MHz; Duty Cycle: 1:1
 Medium parameters used (interpolated): $f = 5670$ MHz; $\sigma = 5.725$ mho/m; $\epsilon_r = 48.29$; $\rho = 1000$ kg/m³
 Phantom section: Flat Section

DASY5 Configuration:

- Probe: EX3DV4 - SN3687; ConvF(3.43, 3.43, 3.43); Calibrated: 16/03/2009
- Sensor-Surface: 2mm (Mechanical Surface Detection (Locations From Previous Scan Used)), Sensor-Surface: 2mm (Mechanical Surface Detection)
- Electronics: DAE4 Sn669; Calibrated: 03/02/2011
- Phantom: Flat Phantom ELI4.0; Type: QDOVA001BA; Serial: SN:1060
- Measurement SW: DASY52, Version 52.6 (2); SEMCAD X Version 14.4.4 (2829)

Secondary Landscape/Chain A, 802.11n*, Channel 134 2/Area Scan (71x341x1): Measurement grid: dx=10mm, dy=10mm

[Info: Interpolated medium parameters used for SAR evaluation.](#)

Maximum value of SAR (interpolated) = 2.334 mW/g

Secondary Landscape/Chain A, 802.11n*, Channel 134 2/Zoom Scan (8x8x11)/Cube 0: Measurement grid:

dx=4mm, dy=4mm, dz=2mm

Reference Value = 19.239 V/m; Power Drift = -0.29 dB

Peak SAR (extrapolated) = 3.648 W/kg

SAR(1 g) = 0.845 mW/g; SAR(10 g) = 0.274 mW/g

[Info: Interpolated medium parameters used for SAR evaluation.](#)

Maximum value of SAR (measured) = 1.744 mW/g

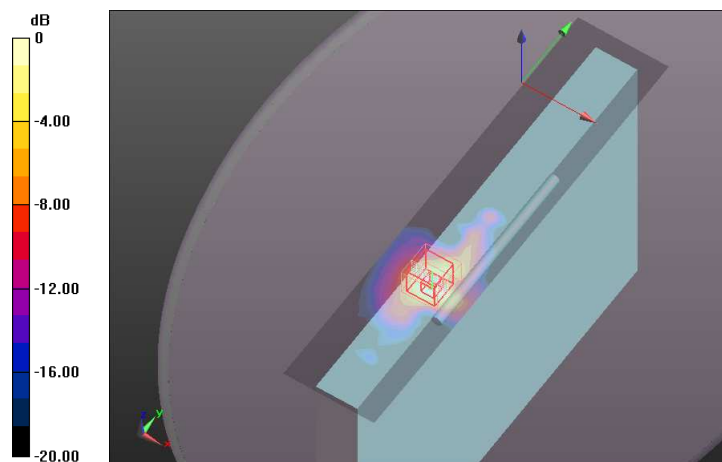

0 dB = 1.740mW/g

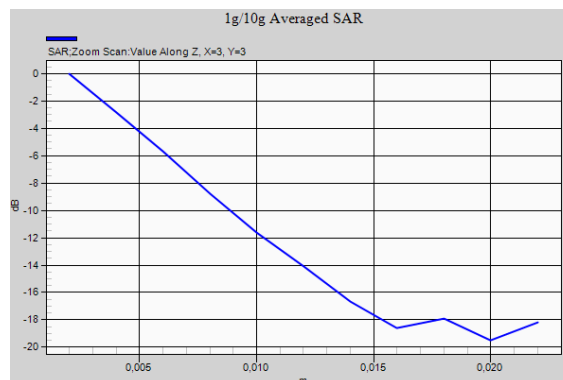

5600 MHz Band – Secondary Landscape Mode, Chain B – 802.11n* Channel 102

DUT: Dell Patron + Intel 633ANHMW + Yageo; Type: Tablet; Serial: -

Communication System: 802.11; Frequency: 5510 MHz; Duty Cycle: 1:1
 Medium parameters used (interpolated): $f = 5510$ MHz; $\sigma = 5.5$ mho/m; $\epsilon_r = 48.665$; $\rho = 1000$ kg/m³
 Phantom section: Flat Section

DASY5 Configuration:

- Probe: EX3DV4 - SN3687; ConvF(3.43, 3.43, 3.43); Calibrated: 16/03/2009
- Sensor-Surface: 2mm (Mechanical Surface Detection (Locations From Previous Scan Used)), Sensor-Surface: 2mm (Mechanical Surface Detection)
- Electronics: DAE4 Sn669; Calibrated: 03/02/2011
- Phantom: Flat Phantom ELI4.0; Type: QDOVA001BA; Serial: SN:1060
- Measurement SW: DASY52, Version 52.6 (2); SEMCAD X Version 14.4.4 (2829)

Secondary Landscape/Chain B, 802.11n*, Channel 102/Area Scan (71x341x1): Measurement grid: dx=10mm, dy=10mm

[Info: Interpolated medium parameters used for SAR evaluation.](#)

Maximum value of SAR (interpolated) = 1.170 mW/g

Secondary Landscape/Chain B, 802.11n*, Channel 102/Zoom Scan (9x9x11)/Cube 0: Measurement grid:

dx=4mm, dy=4mm, dz=2mm

Reference Value = 15.359 V/m; Power Drift = -0.19 dB

Peak SAR (extrapolated) = 2.178 W/kg

SAR(1 g) = 0.567 mW/g; SAR(10 g) = 0.210 mW/g

[Info: Interpolated medium parameters used for SAR evaluation.](#)

Maximum value of SAR (measured) = 1.072 mW/g

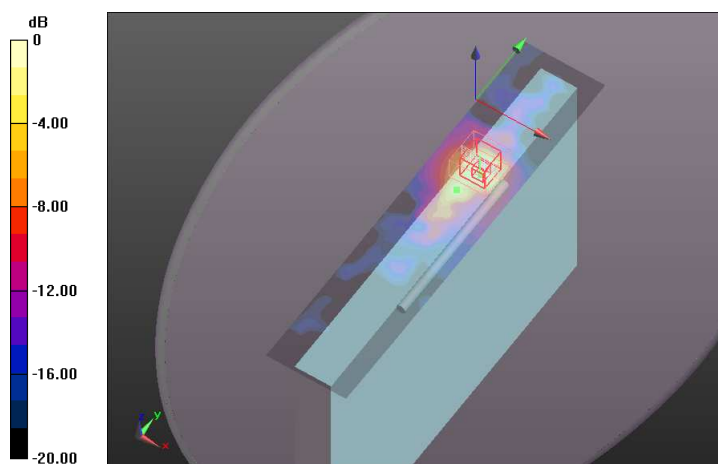

0 dB = 1.070mW/g

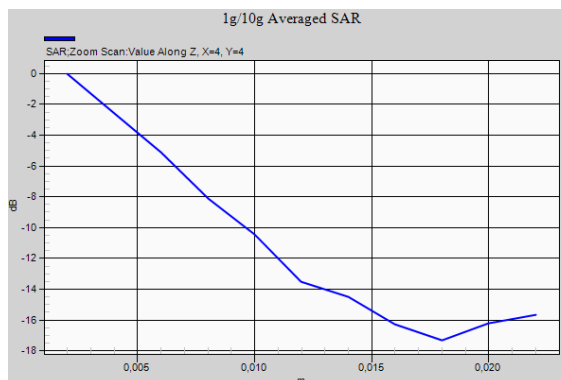

5600 MHz Band – Secondary Landscape Mode, Chain C – 802.11n* Channel 102

DUT: Dell Patron + Intel 633ANHMW + Yageo; Type: Tablet; Serial: -

Communication System: 802.11; Frequency: 5510 MHz; Duty Cycle: 1:1
 Medium parameters used (interpolated): $f = 5510$ MHz; $\sigma = 5.5$ mho/m; $\epsilon_r = 48.665$; $\rho = 1000$ kg/m³
 Phantom section: Flat Section

DASY5 Configuration:

- Probe: EX3DV4 - SN3687; ConvF(3.43, 3.43, 3.43); Calibrated: 16/03/2009
- Sensor-Surface: 2mm (Mechanical Surface Detection (Locations From Previous Scan Used)), Sensor-Surface: 2mm (Mechanical Surface Detection)
- Electronics: DAE4 Sn669; Calibrated: 03/02/2011
- Phantom: Flat Phantom ELI4.0; Type: QDOVA001BA; Serial: SN:1060
- Measurement SW: DASY52, Version 52.6 (2); SEMCAD X Version 14.4.4 (2829)

Secondary Landscape/Chain C, 802.11n*, Channel 102/Area Scan (71x341x1): Measurement grid: dx=10mm, dy=10mm

[Info: Interpolated medium parameters used for SAR evaluation.](#)

Maximum value of SAR (interpolated) = 0.838 mW/g

Secondary Landscape/Chain C, 802.11n*, Channel 102/Zoom Scan (9x9x11)/Cube 0: Measurement grid:

dx=4mm, dy=4mm, dz=2mm

Reference Value = 14.496 V/m; Power Drift = -0.12 dB

Peak SAR (extrapolated) = 1.917 W/kg

SAR(1 g) = 0.467 mW/g; SAR(10 g) = 0.162 mW/g

[Info: Interpolated medium parameters used for SAR evaluation.](#)

Maximum value of SAR (measured) = 0.934 mW/g

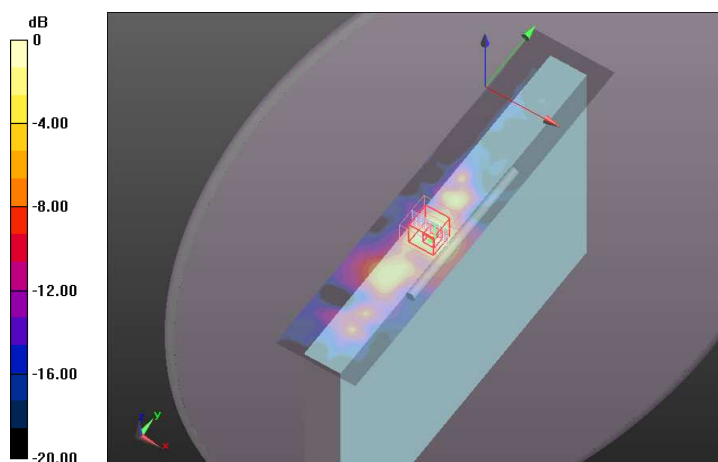

0 dB = 0.930mW/g

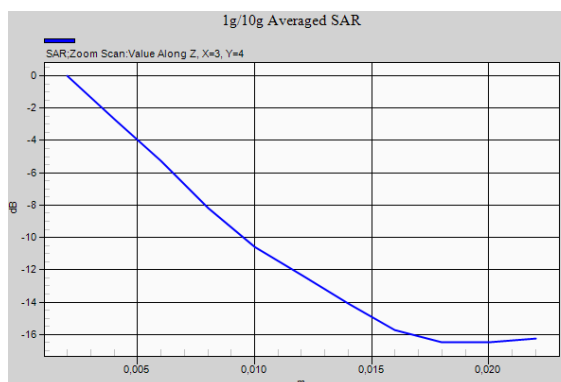

5800 MHz Band – Lapheld Mode, Chain A – 802.11n* Channel 159

DUT: Dell Patron + Intel 633ANHMW + Yageo; Type: Tablet; Serial: -

Communication System: 802.11; Frequency: 5795 MHz; Duty Cycle: 1:1
 Medium parameters used (interpolated): $f = 5795$ MHz; $\sigma = 5.893$ mho/m; $\epsilon_r = 47.987$; $\rho = 1000$ kg/m³
 Phantom section: Flat Section

DASY5 Configuration:

- Probe: EX3DV4 - SN3687; ConvF(3.74, 3.74, 3.74); Calibrated: 16/03/2009
- Sensor-Surface: 2mm (Mechanical Surface Detection (Locations From Previous Scan Used)), Sensor-Surface: 2mm (Mechanical Surface Detection)
- Electronics: DAE4 Sn669; Calibrated: 03/02/2011
- Phantom: Flat Phantom ELI4.0; Type: QDOVA001BA; Serial: SN:1060
- Measurement SW: DASY52, Version 52.6 (2); SEMCAD X Version 14.4.4 (2829)

Lapheld/Chain A, 802.11n*, Channel 159/Area Scan (81x301x1): Measurement grid: dx=10mm, dy=10mm

[Info: Interpolated medium parameters used for SAR evaluation.](#)

Maximum value of SAR (interpolated) = 0.341 mW/g

Lapheld/Chain A, 802.11n*, Channel 159/Zoom Scan (8x8x11)/Cube 0: Measurement grid: dx=4mm, dy=4mm, dz=2mm

Reference Value = 7.496 V/m; Power Drift = -0.22 dB

Peak SAR (extrapolated) = 0.725 W/kg

SAR(1 g) = 0.118 mW/g; SAR(10 g) = 0.045 mW/g

[Info: Interpolated medium parameters used for SAR evaluation.](#)

Maximum value of SAR (measured) = 0.313 mW/g

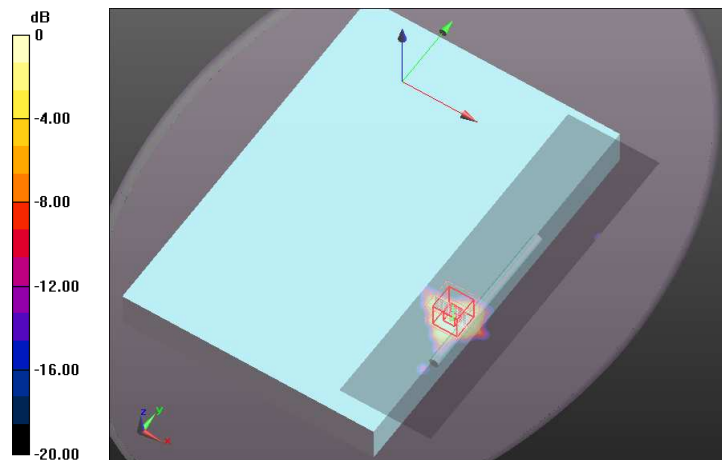

0 dB = 0.310mW/g

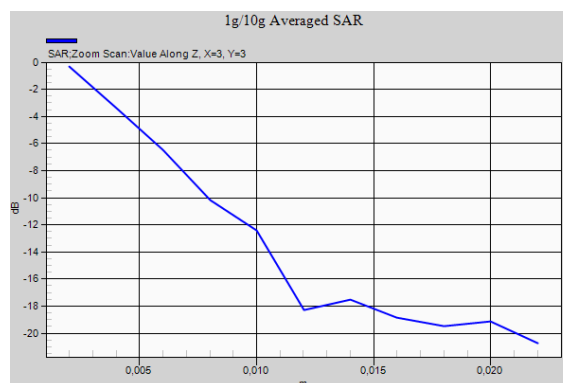

5800 MHz Band – Lapheld Mode, Chain B – 802.11n* Channel 159

DUT: Dell Patron + Intel 633ANHMW + Yageo; Type: Tablet; Serial: -

Communication System: 802.11; Frequency: 5795 MHz; Duty Cycle: 1:1
 Medium parameters used (interpolated): $f = 5795$ MHz; $\sigma = 5.893$ mho/m; $\epsilon_r = 47.987$; $\rho = 1000$ kg/m³
 Phantom section: Flat Section

DASY5 Configuration:

- Probe: EX3DV4 - SN3687; ConvF(3.74, 3.74, 3.74); Calibrated: 16/03/2009
- Sensor-Surface: 2mm (Mechanical Surface Detection (Locations From Previous Scan Used)), Sensor-Surface: 2mm (Mechanical Surface Detection)
- Electronics: DAE4 Sn669; Calibrated: 03/02/2011
- Phantom: Flat Phantom ELI4.0; Type: QDOVA001BA; Serial: SN:1060
- Measurement SW: DASY52, Version 52.6 (2); SEMCAD X Version 14.4.4 (2829)

Lapheld/Chain B, 802.11n*, Channel 159/Area Scan (81x301x1): Measurement grid: dx=10mm, dy=10mm

[Info: Interpolated medium parameters used for SAR evaluation.](#)

Maximum value of SAR (interpolated) = 0.521 mW/g

Lapheld/Chain B, 802.11n*, Channel 159/Zoom Scan (9x8x11)/Cube 0: Measurement grid: dx=4mm, dy=4mm, dz=2mm

Reference Value = 10.278 V/m; Power Drift = -0.20 dB

Peak SAR (extrapolated) = 0.801 W/kg

SAR(1 g) = 0.421 mW/g; SAR(10 g) = 0.352 mW/g

[Info: Interpolated medium parameters used for SAR evaluation.](#)

Maximum value of SAR (measured) = 0.551 mW/g

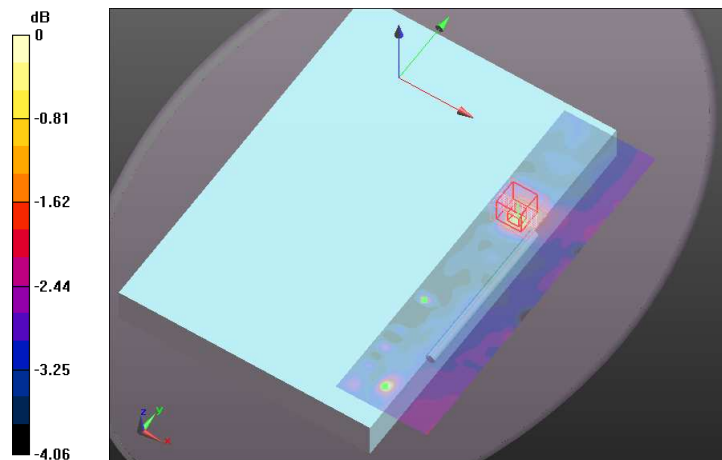

0 dB = 0.550mW/g

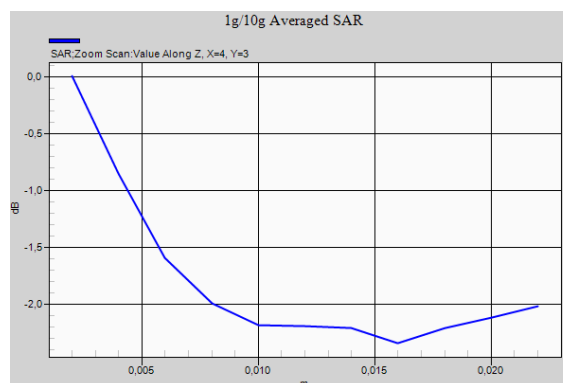

5800 MHz Band – Lapheld Mode, Chain C – 802.11n* Channel 159

DUT: Dell Patron + Intel 633ANHMW + Yageo; Type: Tablet; Serial: -

Communication System: 802.11; Frequency: 5795 MHz; Duty Cycle: 1:1
 Medium parameters used (interpolated): $f = 5795$ MHz; $\sigma = 5.893$ mho/m; $\epsilon_r = 47.987$; $\rho = 1000$ kg/m³
 Phantom section: Flat Section

DASY5 Configuration:

- Probe: EX3DV4 - SN3687; ConvF(3.74, 3.74, 3.74); Calibrated: 16/03/2009
- Sensor-Surface: 2mm (Mechanical Surface Detection (Locations From Previous Scan Used)), Sensor-Surface: 2mm (Mechanical Surface Detection)
- Electronics: DAE4 Sn669; Calibrated: 03/02/2011
- Phantom: Flat Phantom ELI4.0; Type: QDOVA001BA; Serial: SN:1060
- Measurement SW: DASY52, Version 52.6 (2); SEMCAD X Version 14.4.4 (2829)

Lapheld/Chain C, 802.11n*, Channel 159/Area Scan (81x301x1): Measurement grid: dx=10mm, dy=10mm

[Info: Interpolated medium parameters used for SAR evaluation.](#)

Maximum value of SAR (interpolated) = 0.296 mW/g

Lapheld/Chain C, 802.11n*, Channel 159/Zoom Scan (8x8x11)/Cube 0: Measurement grid: dx=4mm, dy=4mm, dz=2mm

Reference Value = 2.027 V/m; Power Drift = -0.03 dB

Peak SAR (extrapolated) = 0.792 W/kg

SAR(1 g) = 0.053 mW/g; SAR(10 g) = 0.00911 mW/g

[Info: Interpolated medium parameters used for SAR evaluation.](#)

Maximum value of SAR (measured) = 0.091 mW/g

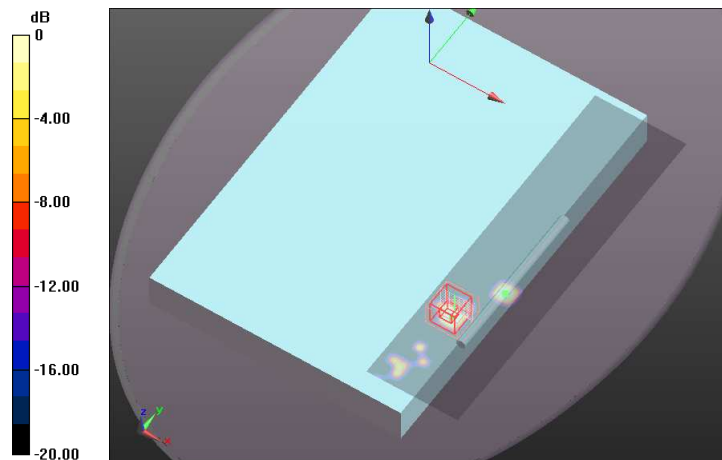

0 dB = 0.090mW/g

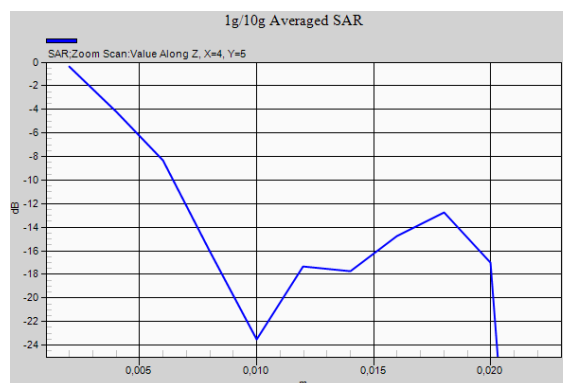

5800 MHz Band – Secondary Portrait Mode, Chain A – 802.11n* Channel 159

DUT: Dell Patron + Intel 633ANHMW + Yageo; Type: Tablet; Serial: -

Communication System: 802.11; Frequency: 5795 MHz; Duty Cycle: 1:1
 Medium parameters used (interpolated): $f = 5795$ MHz; $\sigma = 5.893$ mho/m; $\epsilon_r = 47.987$; $\rho = 1000$ kg/m³
 Phantom section: Flat Section

DASY5 Configuration:

- Probe: EX3DV4 - SN3687; ConvF(3.74, 3.74, 3.74); Calibrated: 16/03/2009
- Sensor-Surface: 2mm (Mechanical Surface Detection (Locations From Previous Scan Used)), Sensor-Surface: 2mm (Mechanical Surface Detection)
- Electronics: DAE4 Sn669; Calibrated: 03/02/2011
- Phantom: Flat Phantom ELI4.0; Type: QDOVA001BA; Serial: SN:1060
- Measurement SW: DASY52, Version 52.6 (2); SEMCAD X Version 14.4.4 (2829)

Secondary Portrait/Chain A, 802.11n*, Channel 159/Area Scan (61x251x1): Measurement grid: dx=10mm, dy=10mm

[Info: Interpolated medium parameters used for SAR evaluation.](#)

Maximum value of SAR (interpolated) = 0.223 mW/g

Secondary Portrait/Chain A, 802.11n*, Channel 159/Zoom Scan (8x8x11)/Cube 0: Measurement grid: dx=4mm, dy=4mm, dz=2mm

Reference Value = 3.441 V/m; Power Drift = -0.09 dB

Peak SAR (extrapolated) = 0.247 W/kg

SAR(1 g) = 0.036 mW/g; SAR(10 g) = 0.00994 mW/g

[Info: Interpolated medium parameters used for SAR evaluation.](#)

Maximum value of SAR (measured) = 0.088 mW/g

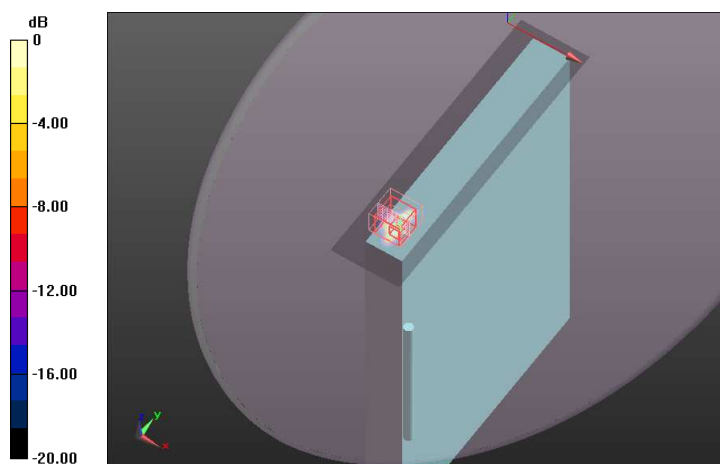

0 dB = 0.090mW/g

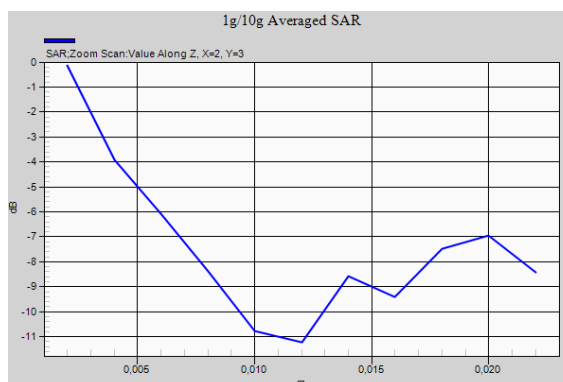

5800 MHz Band – Secondary Portrait Mode, Chain B – 802.11n* Channel 159

DUT: Dell Patron + Intel 633ANHMW + Yageo; Type: Tablet; Serial: -

Communication System: 802.11; Frequency: 5795 MHz; Duty Cycle: 1:1
 Medium parameters used (interpolated): $f = 5795$ MHz; $\sigma = 5.893$ mho/m; $\epsilon_r = 47.987$; $\rho = 1000$ kg/m³
 Phantom section: Flat Section

DASY5 Configuration:

- Probe: EX3DV4 - SN3687; ConvF(3.74, 3.74, 3.74); Calibrated: 16/03/2009
- Sensor-Surface: 2mm (Mechanical Surface Detection (Locations From Previous Scan Used)), Sensor-Surface: 2mm (Mechanical Surface Detection)
- Electronics: DAE4 Sn669; Calibrated: 03/02/2011
- Phantom: Flat Phantom ELI4.0; Type: QDOVA001BA; Serial: SN:1060
- Measurement SW: DASY52, Version 52.6 (2); SEMCAD X Version 14.4.4 (2829)

Secondary Portrait/Chain B, 802.11n*, Channel 159/Area Scan (61x251x1): Measurement grid: dx=10mm, dy=10mm

[Info: Interpolated medium parameters used for SAR evaluation.](#)

Maximum value of SAR (interpolated) = 0.064 mW/g

Secondary Portrait/Chain B, 802.11n*, Channel 159/Zoom Scan (8x8x11)/Cube 0: Measurement grid: dx=4mm, dy=4mm, dz=2mm

Reference Value = 1.908 V/m; Power Drift = 0.195 dB

Peak SAR (extrapolated) = 0.500 W/kg

SAR(1 g) = 0.025 mW/g; SAR(10 g) = 0.00323 mW/g

[Info: Interpolated medium parameters used for SAR evaluation.](#)

Maximum value of SAR (measured) = 0.064 mW/g

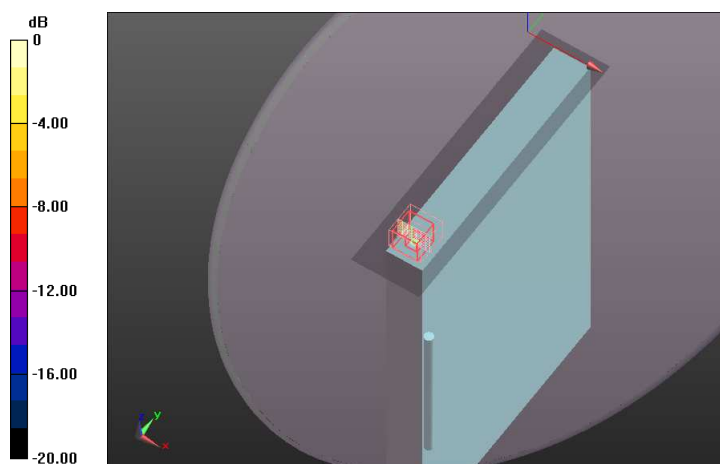

0 dB = 0.060mW/g

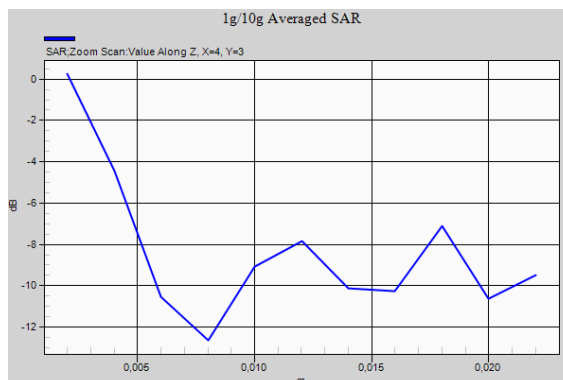

5800 MHz Band – Secondary Portrait Mode, Chain C – 802.11n* Channel 159

DUT: Dell Patron + Intel 633ANHMW + Yageo; Type: Tablet; Serial: -

Communication System: 802.11; Frequency: 5795 MHz; Duty Cycle: 1:1
 Medium parameters used (interpolated): $f = 5795$ MHz; $\sigma = 5.893$ mho/m; $\epsilon_r = 47.987$; $\rho = 1000$ kg/m³
 Phantom section: Flat Section

DASY5 Configuration:

- Probe: EX3DV4 - SN3687; ConvF(3.74, 3.74, 3.74); Calibrated: 16/03/2009
- Sensor-Surface: 2mm (Mechanical Surface Detection (Locations From Previous Scan Used)), Sensor-Surface: 2mm (Mechanical Surface Detection)
- Electronics: DAE4 Sn669; Calibrated: 03/02/2011
- Phantom: Flat Phantom ELI4.0; Type: QDOVA001BA; Serial: SN:1060
- Measurement SW: DASY52, Version 52.6 (2); SEMCAD X Version 14.4.4 (2829)

Secondary Portrait/Chain C, 802.11n*, Channel 159/Area Scan (61x251x1): Measurement grid: dx=10mm, dy=10mm

[Info: Interpolated medium parameters used for SAR evaluation.](#)

Maximum value of SAR (interpolated) = 0.087 mW/g

Secondary Portrait/Chain C, 802.11n*, Channel 159/Zoom Scan (9x9x11)/Cube 0: Measurement grid: dx=4mm, dy=4mm, dz=2mm

Reference Value = 1.069 V/m; Power Drift = -0.071 dB

Peak SAR (extrapolated) = 0.413 W/kg

SAR(1 g) = 0.040 mW/g; SAR(10 g) = 0.011 mW/g

[Info: Interpolated medium parameters used for SAR evaluation.](#)

Maximum value of SAR (measured) = 0.104 mW/g

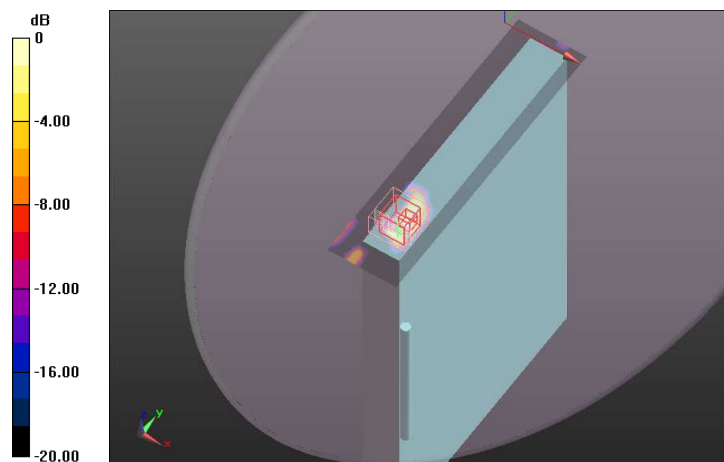

0 dB = 0.090mW/g

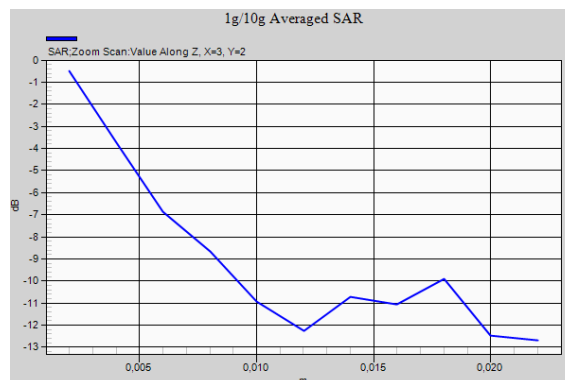

5800 MHz Band – Secondary Landscape Mode, Chain A – 802.11n* Channel 151

DUT: Dell Patron + Intel 633ANHMW + Yageo; Type: Tablet; Serial: -

Communication System: 802.11; Frequency: 5755 MHz; Duty Cycle: 1:1
 Medium parameters used (interpolated): $f = 5755$ MHz; $\sigma = 5.842$ mho/m; $\epsilon_r = 48.087$; $\rho = 1000$ kg/m³
 Phantom section: Flat Section

DASY5 Configuration:

- Probe: EX3DV4 - SN3687; ConvF(3.74, 3.74, 3.74); Calibrated: 16/03/2009
- Sensor-Surface: 2mm (Mechanical Surface Detection (Locations From Previous Scan Used)), Sensor-Surface: 2mm (Mechanical Surface Detection)
- Electronics: DAE4 Sn669; Calibrated: 03/02/2011
- Phantom: Flat Phantom ELI4.0; Type: QDOVA001BA; Serial: SN:1060
- Measurement SW: DASY52, Version 52.6 (2); SEMCAD X Version 14.4.4 (2829)

Secondary Landscape/Chain A, 802.11n*, Channel 151/Area Scan (71x341x1): Measurement grid: dx=10mm, dy=10mm

[Info: Interpolated medium parameters used for SAR evaluation.](#)

Maximum value of SAR (interpolated) = 1.339 mW/g

Secondary Landscape/Chain A, 802.11n*, Channel 151/Zoom Scan (8x8x11)/Cube 0: Measurement grid:

dx=4mm, dy=4mm, dz=2mm

Reference Value = 17.467 V/m; Power Drift = 0.08 dB

Peak SAR (extrapolated) = 7.862 W/kg

SAR(1 g) = 0.742 mW/g; SAR(10 g) = 0.246 mW/g

[Info: Interpolated medium parameters used for SAR evaluation.](#)

Maximum value of SAR (measured) = 1.482 mW/g

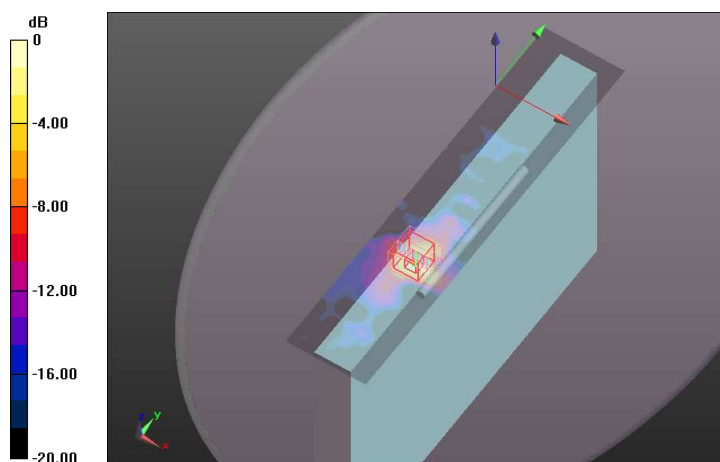

0 dB = 1.480mW/g

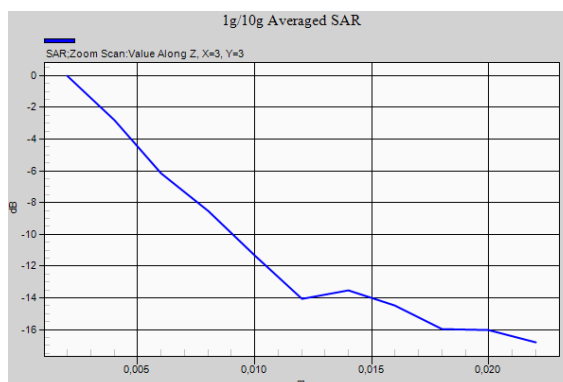

5800 MHz Band – Secondary Landscape Mode, Chain A – 802.11n* Channel 159

DUT: Dell Patron + Intel 633ANHMW + Yageo; Type: Tablet; Serial: -

Communication System: 802.11; Frequency: 5795 MHz; Duty Cycle: 1:1
 Medium parameters used (interpolated): $f = 5795$ MHz; $\sigma = 5.893$ mho/m; $\epsilon_r = 47.987$; $\rho = 1000$ kg/m³
 Phantom section: Flat Section

DASY5 Configuration:

- Probe: EX3DV4 - SN3687; ConvF(3.74, 3.74, 3.74); Calibrated: 16/03/2009
- Sensor-Surface: 2mm (Mechanical Surface Detection (Locations From Previous Scan Used)), Sensor-Surface: 2mm (Mechanical Surface Detection)
- Electronics: DAE4 Sn669; Calibrated: 03/02/2011
- Phantom: Flat Phantom ELI4.0; Type: QDOVA001BA; Serial: SN:1060
- Measurement SW: DASY52, Version 52.6 (2); SEMCAD X Version 14.4.4 (2829)

Secondary Landscape/Chain A, 802.11n*, Channel 159/Area Scan (71x341x1): Measurement grid: dx=10mm, dy=10mm

[Info: Interpolated medium parameters used for SAR evaluation.](#)

Maximum value of SAR (interpolated) = 3.869 mW/g

Secondary Landscape/Chain A, 802.11n*, Channel 159/Zoom Scan (8x8x11)/Cube 0: Measurement grid:

dx=4mm, dy=4mm, dz=2mm

Reference Value = 22.093 V/m; Power Drift = -0.03 dB

Peak SAR (extrapolated) = 4.850 W/kg

SAR(1 g) = 1.13 mW/g; SAR(10 g) = 0.360 mW/g

[Info: Interpolated medium parameters used for SAR evaluation.](#)

Maximum value of SAR (measured) = 2.279 mW/g

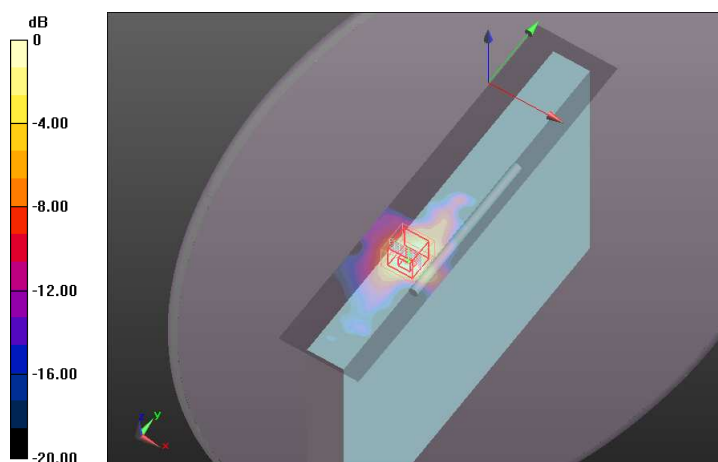

0 dB = 2.280mW/g

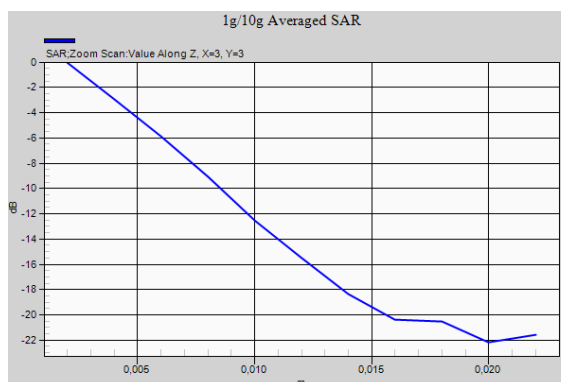

5800 MHz Band – Secondary Landscape Mode, Chain B – 802.11n* Channel 159

DUT: Dell Patron + Intel 633ANHMW + Yageo; Type: Tablet; Serial: -

Communication System: 802.11; Frequency: 5795 MHz; Duty Cycle: 1:1
 Medium parameters used (interpolated): $f = 5795$ MHz; $\sigma = 5.893$ mho/m; $\epsilon_r = 47.987$; $\rho = 1000$ kg/m³
 Phantom section: Flat Section

DASY5 Configuration:

- Probe: EX3DV4 - SN3687; ConvF(3.74, 3.74, 3.74); Calibrated: 16/03/2009
- Sensor-Surface: 2mm (Mechanical Surface Detection (Locations From Previous Scan Used)), Sensor-Surface: 2mm (Mechanical Surface Detection)
- Electronics: DAE4 Sn669; Calibrated: 03/02/2011
- Phantom: Flat Phantom ELI4.0; Type: QDOVA001BA; Serial: SN:1060
- Measurement SW: DASY52, Version 52.6 (2); SEMCAD X Version 14.4.4 (2829)

Secondary Landscape/Chain B, 802.11n*, Channel 159/Area Scan (71x341x1): Measurement grid: dx=10mm, dy=10mm

[Info: Interpolated medium parameters used for SAR evaluation.](#)

Maximum value of SAR (interpolated) = 1.760 mW/g

Secondary Landscape/Chain B, 802.11n*, Channel 159/Zoom Scan (8x9x11)/Cube 0: Measurement grid:

dx=4mm, dy=4mm, dz=2mm

Reference Value = 15.281 V/m; Power Drift = -0.25 dB

Peak SAR (extrapolated) = 2.445 W/kg

SAR(1 g) = 0.582 mW/g; SAR(10 g) = 0.210 mW/g

[Info: Interpolated medium parameters used for SAR evaluation.](#)

Maximum value of SAR (measured) = 1.101 mW/g

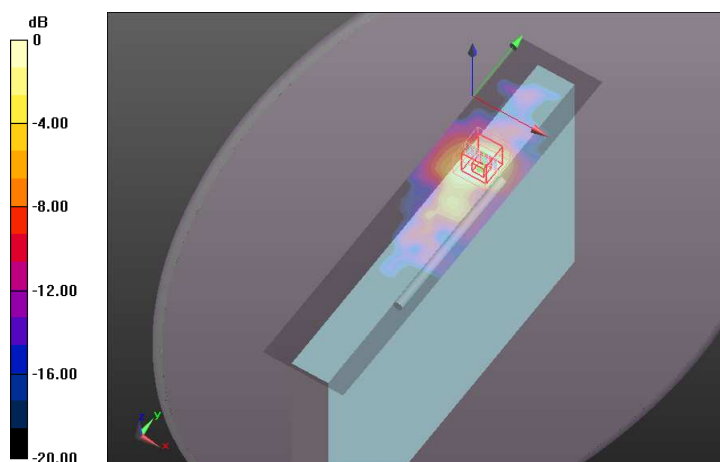

0 dB = 1.100mW/g

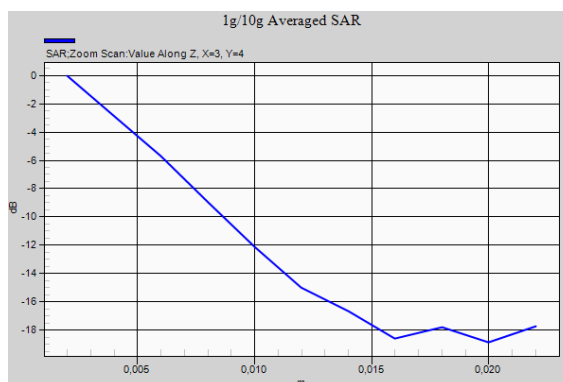

5800 MHz Band – Secondary Landscape Mode, Chain C – 802.11n* Channel 159

DUT: Dell Patron + Intel 633ANHMW + Yageo; Type: Tablet; Serial: -

Communication System: 802.11; Frequency: 5795 MHz; Duty Cycle: 1:1
 Medium parameters used (interpolated): $f = 5795$ MHz; $\sigma = 5.893$ mho/m; $\epsilon_r = 47.987$; $\rho = 1000$ kg/m³
 Phantom section: Flat Section

DASY5 Configuration:

- Probe: EX3DV4 - SN3687; ConvF(3.74, 3.74, 3.74); Calibrated: 16/03/2009
- Sensor-Surface: 2mm (Mechanical Surface Detection (Locations From Previous Scan Used)), Sensor-Surface: 2mm (Mechanical Surface Detection)
- Electronics: DAE4 Sn669; Calibrated: 03/02/2011
- Phantom: Flat Phantom ELI4.0; Type: QDOVA001BA; Serial: SN:1060
- Measurement SW: DASY52, Version 52.6 (2); SEMCAD X Version 14.4.4 (2829)

Secondary Landscape/Chain C, 802.11n*, Channel 159/Area Scan (71x341x1): Measurement grid: dx=10mm, dy=10mm

[Info: Interpolated medium parameters used for SAR evaluation.](#)

Maximum value of SAR (interpolated) = 1.522 mW/g

Secondary Landscape/Chain C, 802.11n*, Channel 159/Zoom Scan (8x8x11)/Cube 0: Measurement grid:

dx=4mm, dy=4mm, dz=2mm

Reference Value = 14.142 V/m; Power Drift = 0.22 dB

Peak SAR (extrapolated) = 2.236 W/kg

SAR(1 g) = 0.529 mW/g; SAR(10 g) = 0.153 mW/g

[Info: Interpolated medium parameters used for SAR evaluation.](#)

Maximum value of SAR (measured) = 1.177 mW/g

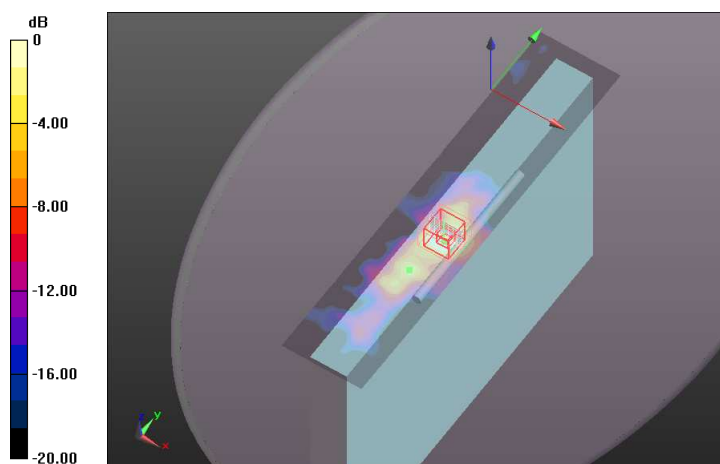

0 dB = 1.180mW/g

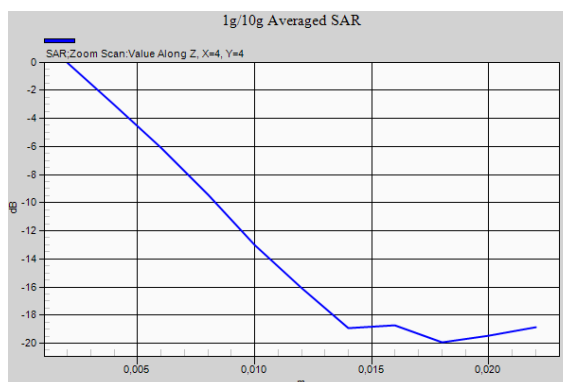

5800 MHz Band – Secondary Landscape Mode, Chain A+C – 802.11n* Channel 159

DUT: Dell Patron + Intel 633ANHMW + Yageo; Type: Tablet; Serial: -

Communication System: 802.11; Frequency: 5795 MHz; Duty Cycle: 1:1
 Medium parameters used (interpolated): $f = 5795$ MHz; $\sigma = 5.893$ mho/m; $\epsilon_r = 47.987$; $\rho = 1000$ kg/m³
 Phantom section: Flat Section

DASY5 Configuration:

- Probe: EX3DV4 - SN3687; ConvF(3.74, 3.74, 3.74); Calibrated: 16/03/2009
- Sensor-Surface: 2mm (Mechanical Surface Detection)
- Electronics: DAE4 Sn669; Calibrated: 03/02/2011
- Phantom: Flat Phantom ELI4.0; Type: QDOVA001BA; Serial: SN:1060
- Measurement SW: DASY52, Version 52.6 (2); SEMCAD X Version 14.4.4 (2829)

Secondary Landscape/Chain A+C, 802.11n*, Channel 159/Zoom Scan Chain A (8x8x11)/Cube 0: Measurement grid: dx=4mm, dy=4mm, dz=2mm

Reference Value = 16.715 V/m; Power Drift = -0.22 dB

Peak SAR (extrapolated) = 3.097 W/kg

SAR(1 g) = 0.723 mW/g; SAR(10 g) = 0.235 mW/g

[Info: Interpolated medium parameters used for SAR evaluation.](#)

Maximum value of SAR (measured) = 1.434 mW/g

Secondary Landscape/Chain A+C, 802.11n*, Channel 159/Zoom Scan Chain C (8x8x11)/Cube 0: Measurement grid: dx=4mm, dy=4mm, dz=2mm

Reference Value = 16.715 V/m; Power Drift = -0.22 dB

Peak SAR (extrapolated) = 1.213 W/kg

SAR(1 g) = 0.250 mW/g; SAR(10 g) = 0.101 mW/g

[Info: Interpolated medium parameters used for SAR evaluation.](#)

Maximum value of SAR (measured) = 0.500 mW/g

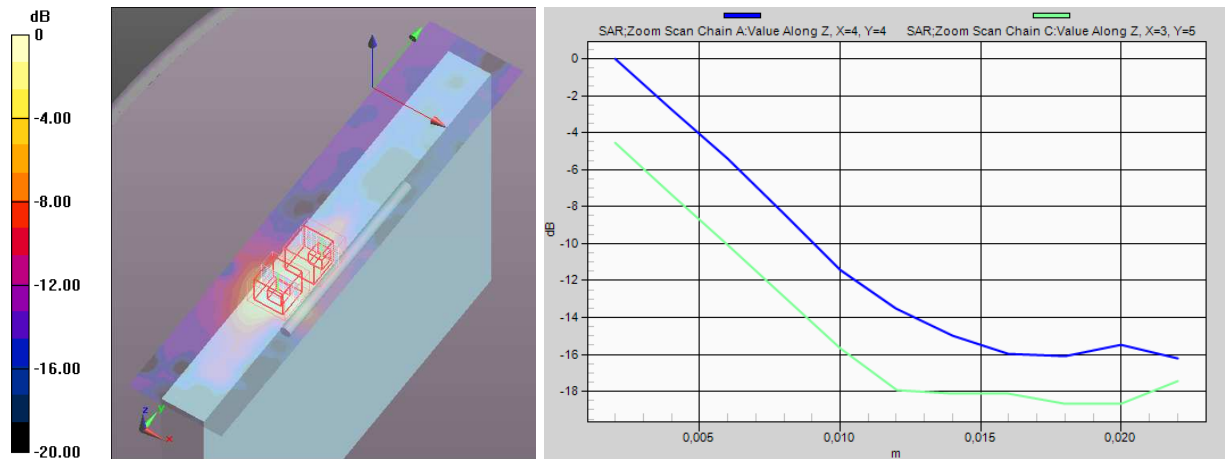

0 dB = 1.430mW/g

5800 MHz Band – Secondary Landscape Mode, Chain A+B – 802.11n* Channel 159

DUT: Dell Patron + Intel 633ANHMW + Yageo; Type: Tablet; Serial: -

Communication System: 802.11; Frequency: 5795 MHz; Duty Cycle: 1:1

Medium parameters used (interpolated): $f = 5795$ MHz; $\sigma = 5.893$ mho/m; $\epsilon_r = 47.987$; $\rho = 1000$ kg/m³

Phantom section: Flat Section

DASY5 Configuration:

- Probe: EX3DV4 - SN3687; ConvF(3.74, 3.74, 3.74); Calibrated: 16/03/2009

- Sensor-Surface: 2mm (Mechanical Surface Detection)

- Electronics: DAE4 Sn669; Calibrated: 03/02/2011

- Phantom: Flat Phantom ELI4.0; Type: QDOVA001BA; Serial: SN:1060

- Measurement SW: DASY52, Version 52.6 (2); SEMCAD X Version 14.4.4 (2829)

Secondary Landscape/Chain A+B, 802.11n*, Channel 159 2/Zoom Scan Chain A (8x8x11)/Cube 0:

Measurement grid: dx=4mm, dy=4mm, dz=2mm

Reference Value = 10.566 V/m; Power Drift = 0.17 dB

Peak SAR (extrapolated) = 2.592 W/kg

SAR(1 g) = 0.609 mW/g; SAR(10 g) = 0.205 mW/g

[Info: Interpolated medium parameters used for SAR evaluation.](#)

Maximum value of SAR (measured) = 1.206 mW/g

Secondary Landscape/Chain A+B, 802.11n*, Channel 159 2/Zoom Scan Chain B (8x9x11)/Cube 0:

Measurement grid: dx=4mm, dy=4mm, dz=2mm

Reference Value = 10.566 V/m; Power Drift = 0.17 dB

Peak SAR (extrapolated) = 1.211 W/kg

SAR(1 g) = 0.314 mW/g; SAR(10 g) = 0.128 mW/g

[Info: Interpolated medium parameters used for SAR evaluation.](#)

Maximum value of SAR (measured) = 0.584 mW/g

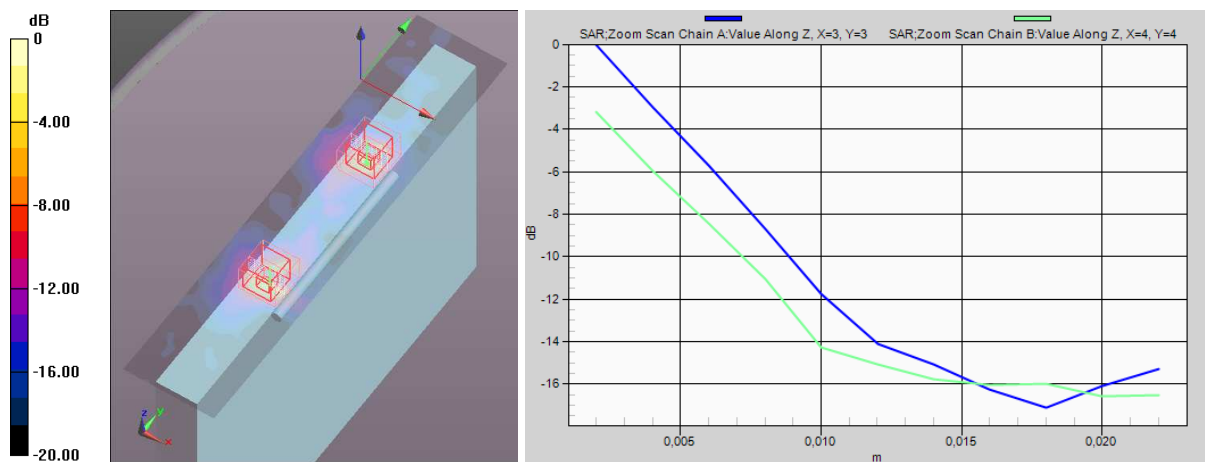

0 dB = 1.210mW/g

APPENDIX D: Calibration Data

**Calibration Laboratory of
Schmid & Partner
Engineering AG**
Zeughausstrasse 43, 8004 Zurich, Switzerland



S Schweizerischer Kalibrierdienst
S Service suisse d'étalonnage
C Servizio svizzero di taratura
S Swiss Calibration Service

Accredited by the Swiss Accreditation Service (SAS)
The Swiss Accreditation Service is one of the signatories to the EA
Multilateral Agreement for the recognition of calibration certificates

Accreditation No.: **SCS 108**

Client **AT4wireless**

Certificate No: **ES3-3052_Oct10**

CALIBRATION CERTIFICATE

Object: **ES3DV3 - SN:3052**

Calibration procedure(s): **QA CAL-01.v6, QA CAL-23.v3 and QA CAL-25 v2
Calibration procedure for dosimetric E-field probes**

Calibration date: **October 22, 2010**



This calibration certificate documents the traceability to national standards, which realize the physical units of measurements (SI).
The measurements and the uncertainties with confidence probability are given on the following pages and are part of the certificate.

All calibrations have been conducted in the closed laboratory facility, environment temperature (22 ± 3)°C and humidity < 70%.

Calibration Equipment used (M&TE critical for calibration):

Primary Standards	ID #	Cal Date (Certificate No.)	Scheduled Calibration
Power meter E4419B	GB41293874	1-Apr-10 (No. 217-01136)	Apr-11
Power sensor E4412A	MY41495277	1-Apr-10 (No. 217-01136)	Apr-11
Power sensor E4412A	MY41498087	1-Apr-10 (No. 217-01136)	Apr-11
Reference 3 dB Attenuator	SN: S5054 (3c)	30-Mar-10 (No. 217-01159)	Mar-11
Reference 20 dB Attenuator	SN: S5086 (20b)	30-Mar-10 (No. 217-01161)	Mar-11
Reference 30 dB Attenuator	SN: S5129 (30b)	30-Mar-10 (No. 217-01160)	Mar-11
Reference Probe ES3DV2	SN: 3013	30-Dec-09 (No. ES3-3013_Dec09)	Dec-10
DAE4	SN: 660	20-Apr-10 (No. DAE4-660_Apr10)	Apr-11

Secondary Standards	ID #	Check Date (in house)	Scheduled Check
RF generator HP 6648C	US3642U01700	4-Aug-99 (in house check Oct-09)	In house check: Oct-11
Network Analyzer HP 8753E	US37390585	18-Oct-01 (in house check Oct-10)	In house check: Oct-11

	Name	Function	Signature
Calibrated by:	Jeton Kastrati	Laboratory Technician	
Approved by:	Katja Pokovic	Technical Manager	

Issued: October 23, 2010

This calibration certificate shall not be reproduced except in full without written approval of the laboratory

ES3DV3 SN:3052

October 22, 2010

DASY/EASY - Parameters of Probe: ES3DV3 SN:3052

Basic Calibration Parameters

	Sensor X	Sensor Y	Sensor Z	Unc (k=2)
Norm ($\mu\text{V}/(\text{V}/\text{m})^2$) ^A	1.10	1.23	1.13	$\pm 10.1\%$
DCP (mV) ^B	97.9	96.1	97.0	

Modulation Calibration Parameters

UID	Communication System Name	PAR		A dB	B dBuV	C	VR mV	Unc ^E (k=2)
10000	CW	0.00	X	0.00	0.00	1.00	300.0	$\pm 1.5\%$
			Y	0.00	0.00	1.00	300.0	
			Z	0.00	0.00	1.00	300.0	

The reported uncertainty of measurement is stated as the standard uncertainty of measurement multiplied by the coverage factor k=2, which for a normal distribution corresponds to a coverage probability of approximately 95%.

^A The uncertainties of NormX, Y, Z do not affect the E²-field uncertainty inside TSL (see Pages 5 and 6).

^B Numerical linearization parameter; uncertainty not required.

^E Uncertainty is determined using the maximum deviation from linear response applying recatangular distribution and is expressed for the square of the field value.

ES3DV3 SN:3052

October 22, 2010

DASY/EASY - Parameters of Probe: ES3DV3 SN:3052

Calibration Parameter Determined in Head Tissue Simulating Media

f [MHz]	Validity [MHz] ^c	Permittivity	Conductivity	ConvF X	ConvF Y	ConvF Z	Alpha	Depth Unc (k=2)
750	± 50 / ± 100	43.5 ± 5%	0.87 ± 5%	6.25	6.25	6.25	0.88	1.02 ± 11.0%
835	± 50 / ± 100	41.5 ± 5%	0.90 ± 5%	5.97	5.97	5.97	0.66	1.15 ± 11.0%
900	± 50 / ± 100	41.5 ± 5%	0.97 ± 5%	5.82	5.82	5.82	0.55	1.32 ± 11.0%
1750	± 50 / ± 100	40.1 ± 5%	1.37 ± 5%	5.16	5.16	5.16	0.41	1.53 ± 11.0%
1900	± 50 / ± 100	40.0 ± 5%	1.40 ± 5%	4.95	4.95	4.95	0.35	1.80 ± 11.0%
2000	± 50 / ± 100	40.0 ± 5%	1.40 ± 5%	4.85	4.85	4.85	0.36	1.70 ± 11.0%
2450	± 50 / ± 100	39.2 ± 5%	1.80 ± 5%	4.33	4.33	4.33	0.32	2.21 ± 11.0%
2600	± 50 / ± 100	39.0 ± 5%	1.96 ± 5%	4.22	4.22	4.22	0.34	2.06 ± 11.0%

^c The validity of ± 100 MHz only applies for DASY v4.4 and higher (see Page 2). The uncertainty is the RSS of the ConvF uncertainty at calibration frequency and the uncertainty for the indicated frequency band.

ES3DV3 SN:3052

October 22, 2010

DASY/EASY - Parameters of Probe: ES3DV3 SN:3052

Calibration Parameter Determined in Body Tissue Simulating Media

f [MHz]	Validity [MHz] ^c	Permittivity	Conductivity	ConvF X	ConvF Y	ConvF Z	Alpha	Depth Unc (k=2)
750	± 50 / ± 100	56.7 ± 5%	0.94 ± 5%	6.02	6.02	6.02	0.61	1.24 ± 11.0%
835	± 50 / ± 100	55.2 ± 5%	0.97 ± 5%	5.93	5.93	5.93	0.72	1.19 ± 11.0%
900	± 50 / ± 100	55.0 ± 5%	1.05 ± 5%	5.81	5.81	5.81	0.63	1.22 ± 11.0%
1750	± 50 / ± 100	53.4 ± 5%	1.49 ± 5%	4.70	4.70	4.70	0.32	2.19 ± 11.0%
1900	± 50 / ± 100	53.3 ± 5%	1.52 ± 5%	4.51	4.51	4.51	0.34	2.26 ± 11.0%
2000	± 50 / ± 100	53.3 ± 5%	1.52 ± 5%	4.54	4.54	4.54	0.33	2.28 ± 11.0%
2450	± 50 / ± 100	52.7 ± 5%	1.95 ± 5%	4.14	4.14	4.14	0.72	1.19 ± 11.0%
2600	± 50 / ± 100	52.5 ± 5%	2.16 ± 5%	4.01	4.01	4.01	0.99	0.99 ± 11.0%

^c The validity of ± 100 MHz only applies for DASY v4.4 and higher (see Page 2). The uncertainty is the RSS of the ConvF uncertainty at calibration frequency and the uncertainty for the indicated frequency band.

Calibration Laboratory of
Schmid & Partner
Engineering AG
Zeughausstrasse 43, 8004 Zurich, Switzerland



S Schweizerischer Kalibrierdienst
C Service suisse d'étalonnage
S Servizio svizzero di taratura
S Swiss Calibration Service

Accredited by the Swiss Accreditation Service (SAS)
The Swiss Accreditation Service is one of the signatories to the EA
Multilateral Agreement for the recognition of calibration certificates

Accreditation No.: SCS 108

Client: **AT4Wireless**

Certificate No: **EX3-3687_May10**

CALIBRATION CERTIFICATE

Object: **EX3DV4 - SN:3687**

Calibration procedure(s): **QA CAL-01.v6, QA CAL-14.v3, QA CAL-23.v3 and QA CAL-25.v2
Calibration procedure for dosimetric E-field probes**

Calibration date: **May 19, 2010**



This calibration certificate documents the traceability to national standards, which realize the physical units of measurements (SI).
The measurements and the uncertainties with confidence probability are given on the following pages and are part of the certificate.

All calibrations have been conducted in the closed laboratory facility: environment temperature (22 ± 3)°C and humidity < 70%.

Calibration Equipment used (M&TE critical for calibration)

Primary Standards	ID #	Cal Date (Certificate No.)	Scheduled Calibration
Power meter E4419B	GB41293874	1-Apr-10 (No. 217-01136)	Apr-11
Power sensor E4412A	MY41495277	1-Apr-10 (No. 217-01136)	Apr-11
Power sensor E4412A	MY41498087	1-Apr-10 (No. 217-01136)	Apr-11
Reference 3 dB Attenuator	SN: S5054 (3c)	30-Mar-10 (No. 217-01159)	Mar-11
Reference 20 dB Attenuator	SN: S5085 (20b)	30-Mar-10 (No. 217-01161)	Mar-11
Reference 30 dB Attenuator	SN: S5129 (30b)	30-Mar-10 (No. 217-01160)	Mar-11
Reference Probe ES3DV2	SN: 3013	30-Dec-09 (No. ES3-3013_Dec09)	Dec-10
DAE4	SN: 660	20-Apr-10 (No. DAE4-660_Apr10)	Apr-11

Secondary Standards	ID #	Check Date (in house)	Scheduled Check
RF generator HP 8648C	US3642U01700	4-Aug-99 (in house check Oct-09)	In house check Oct-11
Network Analyzer HP 8753E	US37390585	18-Oct-01 (in house check Oct-09)	In house check Oct10

Calibrated by:	Name	Function	Signature
	Katja Pokovic	Technical Manager	
Approved by:	Niels Kuster	Quality Manager	

issued: May 19, 2010

This calibration certificate shall not be reproduced except in full without written approval of the laboratory.

Certificate No: EX3-3687_May10

Page 1 of 11

EX3DV4 SN:3687

May 19, 2010

DASY/EASY - Parameters of Probe: EX3DV4 SN:3687

Basic Calibration Parameters

	Sensor X	Sensor Y	Sensor Z	Unc (k=2)
Norm ($\mu\text{V}/(\text{V}/\text{m})^2$) ^A	0.54	0.44	0.48	± 10.1%
DCP (mV) ^B	90.7	90.0	91.0	

Modulation Calibration Parameters

UID	Communication System Name	PAR		A dB	B dBuV	C	VR mV	Unc ^E (k=2)
10000	CW	0.00	X	0.00	0.00	1.00	300	± 1.5%
			Y	0.00	0.00	1.00	300	
			Z	0.00	0.00	1.00	300	

The reported uncertainty of measurement is stated as the standard uncertainty of measurement multiplied by the coverage factor k=2, which for a normal distribution corresponds to a coverage probability of approximately 95%.

^A The uncertainties of NormX, Y, Z do not affect the E² field uncertainty inside TSL (see Pages 5 and 6).

^B Numerical linearization parameter: uncertainty not required.

^E Uncertainty is determined using the maximum deviation from linear response applying rectangular distribution and is expressed for the square of the field value.

EX3DV4 SN:3687

May 19, 2010

DASY/EASY - Parameters of Probe: EX3DV4 SN:3687

Calibration Parameter Determined in Head Tissue Simulating Media

f [MHz]	Validity [MHz] ^c	Permittivity	Conductivity	ConvF X	ConvF Y	ConvF Z	Alpha	Depth Unc (k=2)
5200	± 50 / ± 100	36.0 ± 5%	4.66 ± 5%	4.40	4.40	4.40	0.50	1.95 ± 13.1%
5600	± 50 / ± 100	35.5 ± 5%	5.07 ± 5%	4.00	4.00	4.00	0.50	1.95 ± 13.1%
5800	± 50 / ± 100	35.3 ± 5%	5.27 ± 5%	3.94	3.94	3.94	0.50	1.95 ± 13.1%

^c The validity of ± 100 MHz only applies for DASY v4.4 and higher (see Page 2). The uncertainty is the RSS of the ConvF uncertainty at calibration frequency and the uncertainty for the indicated frequency band.

EX3DV4 SN:3687

May 19, 2010

DASY/EASY - Parameters of Probe: EX3DV4 SN:3687

Calibration Parameter Determined in Body Tissue Simulating Media

f [MHz]	Validity [MHz] ^c	Permittivity	Conductivity	ConvF X	ConvF Y	ConvF Z	Alpha	Depth Unc (k=2)
5200	± 50 / ± 100	49.0 ± 5%	5.30 ± 5%	3.95	3.95	3.95	0.58	1.95 ± 13.1%
5600	± 50 / ± 100	48.5 ± 5%	5.77 ± 5%	3.12	3.12	3.12	0.65	1.95 ± 13.1%
5800	± 50 / ± 100	48.2 ± 5%	6.00 ± 5%	3.57	3.57	3.57	0.63	1.95 ± 13.1%

^c The validity of ± 100 MHz only applies for DASY v4.4 and higher (see Page 2). The uncertainty is the RSS of the ConvF uncertainty at calibration frequency and the uncertainty for the indicated frequency band.

**Calibration Laboratory of
Schmid & Partner
Engineering AG**
Zeughausstrasse 43, 8004 Zurich, Switzerland



S Schweizerischer Kalibrierdienst
C Service suisse d'étalonnage
S Servizio svizzero di taratura
S Swiss Calibration Service

Accredited by the Swiss Accreditation Service (SAS)
The Swiss Accreditation Service is one of the signatories to the EA
Multilateral Agreement for the recognition of calibration certificates

Accreditation No.: **SCS 108**

Client **AT4wireless**

Certificate No: **D2450V2-756_Jun09**

CALIBRATION CERTIFICATE

Object **D2450V2 - SN: 756**

Calibration procedure(s) **QA CAL-05.v7
Calibration procedure for dipole validation kits**

Calibration date: **June 19, 2009**



Condition of the calibrated item **In Tolerance**

This calibration certificate documents the traceability to national standards, which realize the physical units of measurements (SI).
The measurements and the uncertainties with confidence probability are given on the following pages and are part of the certificate.

All calibrations have been conducted in the closed laboratory facility: environment temperature (22 ± 3)°C and humidity < 70%.

Calibration Equipment used (M&TE critical for calibration)

Primary Standards	ID #	Cal Date (Calibrated by, Certificate No.)	Scheduled Calibration
Power meter EPM-442A	GB37480704	08-Oct-08 (No. 217-00898)	Oct-09
Power sensor HP 8481A	US37292783	08-Oct-08 (No. 217-00898)	Oct-09
Reference 20 dB Attenuator	SN: 5086 (20g)	31-Mar-09 (No. 217-01025)	Mar-10
Type-N mismatch combination	SN: 5047.2 / 06327	31-Mar-09 (No. 217-01029)	Mar-10
Reference Probe ES3DV2	SN: 3025	28-Apr-08 (No. ES3-3025_Apr08)	Apr-09
Reference Probe ES3DV2	SN: 3025	30-Apr-09 (No. ES3-3025_Apr09)	Apr-10
DAE4	SN: 601	07-Mar-09 (No. DAE4-601_Mar09)	Mar-10
Secondary Standards	ID #	Check Date (in house)	Scheduled Check
Power sensor HP 8481A	MY41092317	18-Oct-02 (in house check Oct-07)	In house check: Oct-09
RF generator R&S SMT-06	100005	4-Aug-99 (in house check Oct-07)	In house check: Oct-09
Network Analyzer HP 8753E	US37390585 S4206	18-Oct-01 (in house check Oct-08)	In house check: Oct-09

	Name	Function	Signature
Calibrated by:	Mike Meili	Laboratory Technician	
Approved by:	Katja Pokovic	Technical Manager	

Issued: June 19, 2009

This calibration certificate shall not be reproduced except in full without written approval of the laboratory.

Measurement Conditions

DASY system configuration, as far as not given on page 1.

DASY Version	DASY5	V5.0
Extrapolation	Advanced Extrapolation	
Phantom	Modular Flat Phantom V5.0	
Distance Dipole Center - TSL	10 mm	with Spacer
Zoom Scan Resolution	dx, dy, dz = 5 mm	
Frequency	2450 MHz \pm 1 MHz	

Head TSL parameters

The following parameters and calculations were applied.

	Temperature	Permittivity	Conductivity
Nominal Head TSL parameters	22.0 °C	39.2	1.80 mho/m
Measured Head TSL parameters	(22.0 \pm 0.2) °C	40.4 \pm 6 %	1.78 mho/m \pm 6 %
Head TSL temperature during test	(22.4 \pm 0.2) °C	----	----

SAR result with Head TSL

SAR averaged over 1 cm ³ (1 g) of Head TSL	Condition	
SAR measured	250 mW input power	13.3 mW / g
SAR normalized	normalized to 1W	53.2 mW / g
SAR for nominal Head TSL parameters ¹	normalized to 1W	53.9 mW /g \pm 17.0 % (k=2)

SAR averaged over 10 cm ³ (10 g) of Head TSL	condition	
SAR measured	250 mW input power	6.29 mW / g
SAR normalized	normalized to 1W	25.2 mW / g
SAR for nominal Head TSL parameters ¹	normalized to 1W	25.3 mW /g \pm 16.5 % (k=2)

¹ Correction to nominal TSL parameters according to d), chapter "SAR Sensitivities"

Body TSL parameters

The following parameters and calculations were applied.

	Temperature	Permittivity	Conductivity
Nominal Body TSL parameters	22.0 °C	52.7	1.95 mho/m
Measured Body TSL parameters	(22.0 ± 0.2) °C	53.2 ± 6 %	2.00 mho/m ± 6 %
Body TSL temperature during test	(21.5 ± 0.2) °C	----	----

SAR result with Body TSL

SAR averaged over 1 cm ³ (1 g) of Body TSL	Condition	
SAR measured	250 mW input power	13.4 mW / g
SAR normalized	normalized to 1W	53.6 mW / g
SAR for nominal Body TSL parameters ²	normalized to 1W	53.0 mW /g ± 17.0 % (k=2)

SAR averaged over 10 cm ³ (10 g) of Body TSL	condition	
SAR measured	250 mW input power	6.27 mW / g
SAR normalized	normalized to 1W	25.1 mW / g
SAR for nominal Body TSL parameters ²	normalized to 1W	25.0 mW /g ± 16.5 % (k=2)

² Correction to nominal TSL parameters according to d), chapter "SAR Sensitivities"

**Calibration Laboratory of
Schmid & Partner
Engineering AG**
Zeughausstrasse 43, 8004 Zurich, Switzerland



S Schweizerischer Kalibrierdienst
C Service suisse d'étalonnage
S Servizio svizzero di taratura
S Swiss Calibration Service

Accredited by the Swiss Accreditation Service (SAS)
The Swiss Accreditation Service is one of the signatories to the EA
Multilateral Agreement for the recognition of calibration certificates

Accreditation No.: **SCS 108**

Client **AT4 Wireless**

Certificate No: **D5GHzV2-1071_Mar09**

CALIBRATION CERTIFICATE

Object: **D5GHzV2 - SN: 1071**

Calibration procedure(s): **QA CAL-22.v1
Calibration procedure for dipole validation kits between 3-6 GHz**

Calibration date: **March 13, 2009**



Condition of the calibrated item: **In Tolerance**

This calibration certificate documents the traceability to national standards, which realize the physical units of measurements (SI).
The measurements and the uncertainties with confidence probability are given on the following pages and are part of the certificate.

All calibrations have been conducted in the closed laboratory facility: environment temperature (22 ± 3)°C and humidity < 70%.

Calibration Equipment used (M&TE critical for calibration)

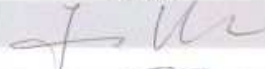
Primary Standards	ID #	Cal Date (Certificate No.)	Scheduled Calibration
Power meter EPM-442A	GB37480704	08-Oct-08 (No. 217-00898)	Oct-09
Power sensor HP 8481A	US37292783	08-Oct-08 (No. 217-00898)	Oct-09
Reference 20 dB Attenuator	SN: 5086 (20g)	01-Jul-08 (No. 217-00864)	Jul-09
Type-N mismatch combination	SN: 5047.2 / 06327	01-Jul-08 (No. 217-00867)	Jul-09
Reference Probe EX3DV4	SN: 3503	11-Mar-09 (No. EX3-3503_Mar09)	Mar-10
DAE4	SN: 601	07-Mar-09 (No. DAE4-601_Mar09)	Mar-10
Secondary Standards	ID #	Check Date (in house)	Scheduled Check
Power sensor HP 8481A	MY41092317	18-Oct-02 (in house check Oct-07)	In house check: Oct-09
RF generator R&S SMT-06	100005	4-Aug-99 (in house check Oct-07)	In house check: Oct-09
Network Analyzer HP 8753E	US37390585 S4206	18-Oct-01 (in house check Oct-08)	In house check: Oct-09

	Name	Function	Signature
Calibrated by:	Jeton Kastrati	Laboratory Technician	
Approved by:	Katja Pokovic	Technical Manager	

Issued: March 17, 2009

This calibration certificate shall not be reproduced except in full without written approval of the laboratory.

Measurement Conditions

DASY system configuration, as far as not given on page 1.

DASY Version	DASY5	V5.0
Extrapolation	Advanced Extrapolation	
Phantom	Modular Flat Phantom V5.0	
Distance Dipole Center - TSL	10 mm	with Spacer
Area Scan resolution	dx, dy = 10 mm	
Zoom Scan Resolution	dx, dy = 4.0 mm, dz = 2.5 mm	
Frequency	5200 MHz \pm 1 MHz 5800 MHz \pm 1 MHz	

Head TSL parameters at 5200 MHz

The following parameters and calculations were applied.

	Temperature	Permittivity	Conductivity
Nominal Head TSL parameters	22.0 °C	36.0	4.66 mho/m
Measured Head TSL parameters	(22.0 \pm 0.2) °C	35.4 \pm 6 %	4.53 mho/m \pm 6 %
Head TSL temperature during test	(22.0 \pm 0.2) °C	---	---

SAR result with Head TSL at 5200 MHz

SAR averaged over 1 cm ³ (1 g) of Head TSL	condition	
SAR measured	100 mW input power	7.69 mW / g
SAR normalized	normalized to 1W	76.9 mW / g
SAR for nominal Head TSL parameters ¹	normalized to 1W	76.6 mW / g \pm 19.9 % (k=2)

SAR averaged over 10 cm ³ (10 g) of Head TSL	condition	
SAR measured	100 mW input power	2.16 mW / g
SAR normalized	normalized to 1W	21.6 mW / g
SAR for nominal Head TSL parameters ¹	normalized to 1W	21.5 mW / g \pm 19.5 % (k=2)

¹ Correction to nominal TSL parameters according to c), chapter "SAR Sensitivities"

Head TSL parameters at 5800 MHz

The following parameters and calculations were applied.

	Temperature	Permittivity	Conductivity
Nominal Head TSL parameters	22.0 °C	35.3	5.27 mho/m
Measured Head TSL parameters	(22.0 ± 0.2) °C	34.3 ± 6 %	5.08 mho/m ± 6 %
Head TSL temperature during test	(22.0 ± 0.2) °C	---	---

SAR result with Head TSL at 5800 MHz

SAR averaged over 1 cm ³ (1 g) of Head TSL	condition	
SAR measured	100 mW input power	7.66 mW / g
SAR normalized	normalized to 1W	76.6 mW / g
SAR for nominal Head TSL parameters ¹	normalized to 1W	76.1 mW / g ± 19.9 % (k=2)

SAR averaged over 10 cm ³ (10 g) of Head TSL	condition	
SAR measured	100 mW input power	2.14 mW / g
SAR normalized	normalized to 1W	21.4 mW / g
SAR for nominal Head TSL parameters ¹	normalized to 1W	21.2 mW / g ± 19.5 % (k=2)

¹ Correction to nominal TSL parameters according to c), chapter "SAR Sensitivities"

Body TSL parameters at 5200 MHz

The following parameters and calculations were applied.

	Temperature	Permittivity	Conductivity
Nominal Body TSL parameters	22.0 °C	49.0	5.30 mho/m
Measured Body TSL parameters	(22.0 ± 0.2) °C	47.7 ± 6 %	5.30 mho/m ± 6 %
Body TSL temperature during test	(21.2 ± 0.2) °C	---	---

SAR result with Body TSL at 5200 MHz

SAR averaged over 1 cm ³ (1 g) of Body TSL	condition	
SAR measured	100 mW input power	7.61 mW / g
SAR normalized	normalized to 1W	76.1 mW / g
SAR for nominal Body TSL parameters ²	normalized to 1W	75.7 mW / g ± 19.9 % (k=2)

SAR averaged over 10 cm ³ (10 g) of Body TSL	condition	
SAR measured	100 mW input power	2.12 mW / g
SAR normalized	normalized to 1W	21.2 mW / g
SAR for nominal Body TSL parameters ²	normalized to 1W	21.1 mW / g ± 19.5 % (k=2)

Body TSL parameters at 5800 MHz

The following parameters and calculations were applied.

	Temperature	Permittivity	Conductivity
Nominal Body TSL parameters	22.0 °C	48.2	6.00 mho/m
Measured Body TSL parameters	(22.0 ± 0.2) °C	46.3 ± 6 %	6.05 mho/m ± 6 %
Body TSL temperature during test	(21.0 ± 0.2) °C	---	---

SAR result with Body TSL at 5800 MHz

SAR averaged over 1 cm ³ (1 g) of Body TSL	condition	
SAR measured	100 mW input power	7.25 mW / g
SAR normalized	normalized to 1W	72.5 mW / g
SAR for nominal Body TSL parameters ²	normalized to 1W	71.9 mW / g ± 19.9 % (k=2)

SAR averaged over 10 cm ³ (10 g) of Body TSL	condition	
SAR measured	100 mW input power	1.99 mW / g
SAR normalized	normalized to 1W	19.9 mW / g
SAR for nominal Body TSL parameters ²	normalized to 1W	19.7 mW / g ± 19.5 % (k=2)

² Correction to nominal TSL parameters according to c), chapter "SAR Sensitivities"

**Calibration Laboratory of
Schmid & Partner
Engineering AG**
Zeughausstrasse 43, 8004 Zurich, Switzerland



S Schweizerischer Kalibrierdienst
C Service suisse d'étalonnage
S Servizio svizzero di taratura
S Swiss Calibration Service

Accredited by the Swiss Accreditation Service (SAS)
The Swiss Accreditation Service is one of the signatories to the EA
Multilateral Agreement for the recognition of calibration certificates

Accreditation No.: **SCS 108**

Client **AT4 Wireless**

Certificate No: **D5GHzV2-1071_Apr09**

CALIBRATION CERTIFICATE

Object **D5GHzV2 - SN: 1071**

Calibration procedure(s) **QA CAL-22.v1
Calibration procedure for dipole validation kits between 3-6 GHz**

Calibration date: **April 28, 2009**



Condition of the calibrated item **In Tolerance**

This calibration certificate documents the traceability to national standards, which realize the physical units of measurements (SI).
The measurements and the uncertainties with confidence probability are given on the following pages and are part of the certificate.

All calibrations have been conducted in the closed laboratory facility: environment temperature (22 ± 3)°C and humidity < 70%.

Calibration Equipment used (M&TE critical for calibration)

Primary Standards	ID #	Cal Date (Certificate No.)	Scheduled Calibration
Power meter EPM-442A	GB37480704	08-Oct-08 (No. 217-00898)	Oct-09
Power sensor HP 8481A	US37292783	08-Oct-08 (No. 217-00898)	Oct-09
Reference 20 dB Attenuator	SN: 5086 (20g)	01-Jul-08 (No. 217-00864)	Jul-09
Type-N mismatch combination	SN: 5047.2 / 06327	01-Jul-08 (No. 217-00867)	Jul-09
Reference Probe EX3DV4	SN: 3503	11-Mar-09 (No. EX3-3503_Mar09)	Mar-10
DAE4	SN: 601	07-Mar-09 (No. DAE4-601_Mar09)	Mar-10
Secondary Standards	ID #	Check Date (in house)	Scheduled Check
Power sensor HP 8481A	MY41092317	18-Oct-02 (in house check Oct-07)	In house check: Oct-09
RF generator R&S SMT-06	100005	4-Aug-99 (in house check Oct-07)	In house check: Oct-09
Network Analyzer HP 8753E	US37390585 S4206	18-Oct-01 (in house check Oct-08)	In house check: Oct-09

	Name	Function	Signature
Calibrated by:	Mike Meili	Laboratory Technician	
Approved by:	Katja Pokovic	Technical Manager	

Issued: April 30, 2009

This calibration certificate shall not be reproduced except in full without written approval of the laboratory.

Measurement Conditions

DASY system configuration, as far as not given on page 1.

DASY Version	DASY5	V5.0
Extrapolation	Advanced Extrapolation	
Phantom	Modular Flat Phantom V5.0	
Distance Dipole Center - TSL	10 mm	with Spacer
Area Scan resolution	dx, dy = 10 mm	
Zoom Scan Resolution	dx, dy = 4.0 mm, dz = 2.5 mm	
Frequency	5500 MHz \pm 1 MHz	

Head TSL parameters at 5500 MHz

The following parameters and calculations were applied.

	Temperature	Permittivity	Conductivity
Nominal Head TSL parameters	22.0 °C	35.6	4.96 mho/m
Measured Head TSL parameters	(22.0 \pm 0.2) °C	35.1 \pm 6 %	4.83 mho/m \pm 6 %
Head TSL temperature during test	(22.5 \pm 0.2) °C	----	----

SAR result with Head TSL at 5500 MHz

SAR averaged over 1 cm³ (1 g) of Head TSL	condition	
SAR measured	100 mW input power	8.17 mW / g
SAR normalized	normalized to 1W	81.7 mW / g
SAR for nominal Head TSL parameters ¹	normalized to 1W	81.4 mW / g \pm 19.9 % (k=2)

SAR averaged over 10 cm³ (10 g) of Head TSL	condition	
SAR measured	100 mW input power	2.29 mW / g
SAR normalized	normalized to 1W	22.9 mW / g
SAR for nominal Head TSL parameters ¹	normalized to 1W	22.8 mW / g \pm 19.5 % (k=2)

¹ Correction to nominal TSL parameters according to c), chapter "SAR Sensitivities"

Body TSL parameters at 5500 MHz

The following parameters and calculations were applied.

	Temperature	Permittivity	Conductivity
Nominal Body TSL parameters	22.0 °C	48.6	5.65 mho/m
Measured Body TSL parameters	(22.0 ± 0.2) °C	46.8 ± 6 %	5.74 mho/m ± 6 %
Body TSL temperature during test	(21.8 ± 0.2) °C	----	----

SAR result with Body TSL at 5500 MHz

SAR averaged over 1 cm ³ (1 g) of Body TSL	condition	
SAR measured	100 mW input power	8.17 mW / g
SAR normalized	normalized to 1W	81.7 mW / g
SAR for nominal Body TSL parameters ²	normalized to 1W	81.1 mW / g ± 19.9 % (k=2)

SAR averaged over 10 cm ³ (10 g) of Body TSL	condition	
SAR measured	100 mW input power	2.26 mW / g
SAR normalized	normalized to 1W	22.6 mW / g
SAR for nominal Body TSL parameters ²	normalized to 1W	22.4 mW / g ± 19.5 % (k=2)

² Correction to nominal TSL parameters according to c), chapter "SAR Sensitivities"