



SAR & HAC Instruments for Wireless • Consulting • Research • Standards • Compliance • Training

Applicant Name: Intel Corporation
Applicant Address: Intel Corporation
 2111 Ne 25th Avenue JF3-3-G14,
 Hillsboro, OR 97124
Project Number: ITLB-Dell-Mott-AUDEN-5508
Test/Analysis Date: March/April 2010

DUT Type	Intel WiFi-Link 6250
Antenna Type	AUDEN
Project Name	MOTT
Received Status	Pre Production Model
DUT Serial Number	Syestem1
Experimental/Compliance	Compliance-FCC Class 2 Permissive Change M/P
Tx Frequency	2412MHz to 2462MHz 802.11bg(n) 2501MHz to 2685MHz WiMAX 5180MHz to 5320MHz 802.11a(n) 5500MHz to 5700MHz 802.11a(n) 5745MHz to 5825MHz 802.11a(n)
Max Tx Power	802.11bg = 16.64dBm 2450n = 14.81dBm WiMAX = 24.1dBm Average 802.11a = 14.55dBm 802.11an = 14.68dBm
Conservative Averaged SAR (RF Exposure) NOTE: Chain A provided conservative SAR. Maximum measured SAR for chain B = 0.122 @ 5760MHz.	802.11b 2462MHz = 0.027 802.11g 2437MHz = 0.061 802.11n 2462MHz = 0.074 802.11n* 2462MHz = 0.056 WiMAX 10MHz 2501MHz 16QAM= 0.024 corrected = 0.037 WiMAX 5MHz 2593MHz 16QAM = 0.032 corrected = 0.030 802.11a 5320MHz = 0.103 802.11n 5320MHz = 0.095 802.11n* 5310MHz = 0.097 802.11a 5700MHz = 0.117 802.11n 5700MHz = 0.134 802.11n* 5670MHz = 0.085 802.11a 5785MHz = 0.124 802.11n 5785MHz = 0.122 802.11n* 5795MHz = 0.116 NOTE: 802.11n = 20MHz / 802.11n* = 40MHz

We the undersigned of APREL Laboratories, located at 17 Bentley Ave, Ottawa, Ontario, Canada, K2E 6T7, on the date indicated attest that the Device Under Test as detailed within this test report has been tested and found to be compliant with the Uncontrolled Environment RF exposure rules and regulations as defined by the methodologies, procedures, and standards as described in this document. Signed this day April 8th 2010.



 Maryna Nestrovna, Test Engineer

 Art Brennan, Document Control

 Released by:
 Stuart Nicol, Director Product Development





SAR & HAC Instruments for Wireless • Consulting • Research • Standards • Compliance • Training

Table of Contents

1.0 Introduction 3

2.0 Applicable Documents 18

3.0 ALSAS-10U System Description 19

3.1 Applications 20

3.2 Visualisation and reporting 20

3.3 Field scans 20

3.3.1 Area Scans 20

3.3.2 Zoom Scan (Cube Scan Averaging) 21

3.4 Operator settings 21

3.5 ALSAS-10U Interpolation and Extrapolation Uncertainty 21

4.0 ALSAS-10U Hardware 22

4.1 Isotropic E-Field Probe 22

4.2 Isotropic E-Field Probe Specification 23

4.3 Boundary Detection Unit and Probe Mounting Device 25

4.4 Daq-Paq (Analog to Digital Electronics) 25

4.5 Axis Articulated Robot 26

4.6 ALSAS Universal Workstation 26

4.7 Universal Device Positioner 27

4.8 Phantom Types 28

4.8.1 APREL SAM Phantoms 28

4.8.2 APREL Laboratories Universal Phantom 29

4.9 Validation Dipoles 30

5.0 Tissue Simulation Fluid 31

5.1 Tissue Calibration Procedure Using a Coaxial Probe 32

5.2 Tissue Calibration Results 32

6.0 System Validation 33

6.1 Experimental Results Summary 40

6.2 SAR Measurement Procedure 40

6.3 SAR Exposure Limits 40

6.4 Equipment List 41

6.5 SAR Measurement Results 42

- Appendix a SAR Plots
- Appendix b Calibration
- Appendix c PbA
- Appendix d Acquisition Methodology



1.0 Introduction

Tests were conducted at APREL Laboratories within the SAR facility to establish the conservative exposure value associated with the Device Under Test as detailed within this test report. Assessments were made in line with the guidelines contained in the reference documents. The method used for assessment was the ALSAS-10U (APREL Laboratories SAR Assessment System-10 Universal). All practices along with standards and scientific methodologies which have been utilized during the assessment of the Device Under Test (DUT) are detailed within this test report.

APREL Laboratories employees currently hold senior and executive positions in multiple international standards organizations, including IEC, IEEE, among others, and work closely with several national regulators, including the FCC and IC. APREL Laboratories currently hold the chair for the Canadian National committee to IEC to which we have a liaison with CENELEC, and informal links to other national and international standards organizations.

1.2 Device Description

The tests conducted on a Dell laptop computer which utilises a set of AUDEN antennas running the Intel Wireless link 6250 network card which runs on both WiFi and WiMAX systems. The card was connected to the antennas with the DUT set to transmit at the maximum power as defined by the manufacturer and analysis was ran on the antenna and position which showed the highest SAR. A predefined waveform which was provided by Intel was used to set the 6250 card to transmit and both average and peak power measurements were made to determine the maximum transmitting power. The card was operated utilizing proprietary software and each channel was measured using a broadband power meter to determine the maximum average power on the antenna port of the wireless card for WiFi assessments. Both antenna chains (A & B) were assessed independently and it was found that Chain A provided the conservative SAR.

WiMAX Zone Types: (DL/UL symbol ratio supported by EUT)

The device and its system are both transmitting using only PUSC zone type. This enables multiple users to transmit simultaneously within the system. FUSC, AMC and other zone types are not used by The Intel WiMAX/Wi-Fi Link 6250 for uplink transmission. The maximum DL:UL symbol ratio can be determined according to the PUSC requirements. The system transmits an odd number of symbols using DL-PUSC consisting of even multiples of traffic and control symbols plus one symbol for the preamble. Multiples of three symbols are transmitted by the device using UL- PUSC. The OFDMA symbol time allows up to 48 downlink and uplink symbols in each 5 ms frame. TTG and RTG are also included in each frame as DL/UL transmission gaps; therefore, the system can only allow 47 or less symbols per frame. The maximum DL:UL symbol ratio is determined according to these PUSC parameters for evaluating SAR compliance.

Description	Down Link	Up Link
Number of OFDM Symbols in Down Link and Up Link for 5 MHz and 10 MHz Bandwidth	35	12
	34	13
	32	15
	31	16
	30	17
	29	18
	28	19
	27	20
	26	21

- a. All test vectors are performing with all UL symbols at maximum power.
- b. Although the Intel WIMAX/WiFi Link 6250 can supply higher downlink to uplink (DL/UL) symbol ratios, the chipset is limited by firmware and the corresponding WIMAX system to operate at or below the maximum DL/UL 29:18 symbol ratio actually deployed by BRS/EBS WIMAX service providers. Therefore, the maximum transmission duty factor supported by the chipset is not applicable for this device. The system can transmit up to 48 OFDMA symbols in each 5 ms frame including 1.6 symbols for TTG and RTG.
- c. UL Burst Maximum Average Power was measured using a spectrum analyzer gated to measure the power only during TX “on”.

10MHz/16QAM: 23.1dBm / 204.2mW
 10MHz/QPSK: 22.9dBm / 195mW
 5MHz/16QAM: 24dBm / 251.2mW
 5MHz/QPSK: 24dBm / 251.2mW

- d. The control channels may occupy up to 5 slots during normal operation. A slot is a sub-channel with the duration of 3 symbols. There are a total of 35 slots in the 10MHz channel configuration.
- e. The control channels may occupy up to 5 slots during normal operation. A slot is a sub-channel with the duration of 3 symbols. There are a total of 17 slots in the 5MHz channel configuration.



f. Maximum Rated / Certified Output Power:

Modulation	Channel Bandwidth	Max. Rated Power
16QAM	10MHz	229mW
QPSK	10MHz	229mW
16QAM	5MHz	269mW
QPSK	5MHz	269mW

g. Duty Factor

For test vector name,

DQ4_12_UQ16_12_10M the duty factor is calculated as,

$$(12 \text{ UL symbols} * 102.9\mu\text{s}/5000\mu\text{s}) * 100 = 24.7\%$$

For test vector name,

DQ64_UQ4_12_21s_10M the duty factor is calculated as,

$$(21 \text{ UL symbols} * 102.9\mu\text{s}/5000\mu\text{s}) * 100 = 43.2\%$$

For test vector name,

DQ4_12_UQ16_34_5M_10M the duty factor is calculated as,

$$(18 \text{ UL symbols} * 102.9\mu\text{s}/5000\mu\text{s}) * 100 = 37\%$$

For test vector name,

DQ64_56_UQ4_12_5M the duty factor is calculated as,

$$(18 \text{ UL symbols} * 102.9\mu\text{s}/5000\mu\text{s}) * 100 = 37\%$$

Modulation	BW	Calculated Duty Factor	DL/UL	UL Duty Cycle Measured (for reference comparison only)	Crest Factor Used in SAR Measurement
16QAM	10MHz	24.7%	32/15	23.9%	4.05
QPSK	10 MHz	43.2%	23/24	41.8%	2.3
16QAM	5 MHz	37%	26/21	35.9%	2.7
QPSK	5 MHz	37%	26/21	36.4%	2.7



1.4 Antenna Locations

The antennas on the Dell laptop with the Intel® WiFi-Link 6250 Series card installed are located within the LCD chassis as identified in the image below. The antennas are located at the top of the LCD. All tests were conducted in the normal use position.

Antenna Location Information

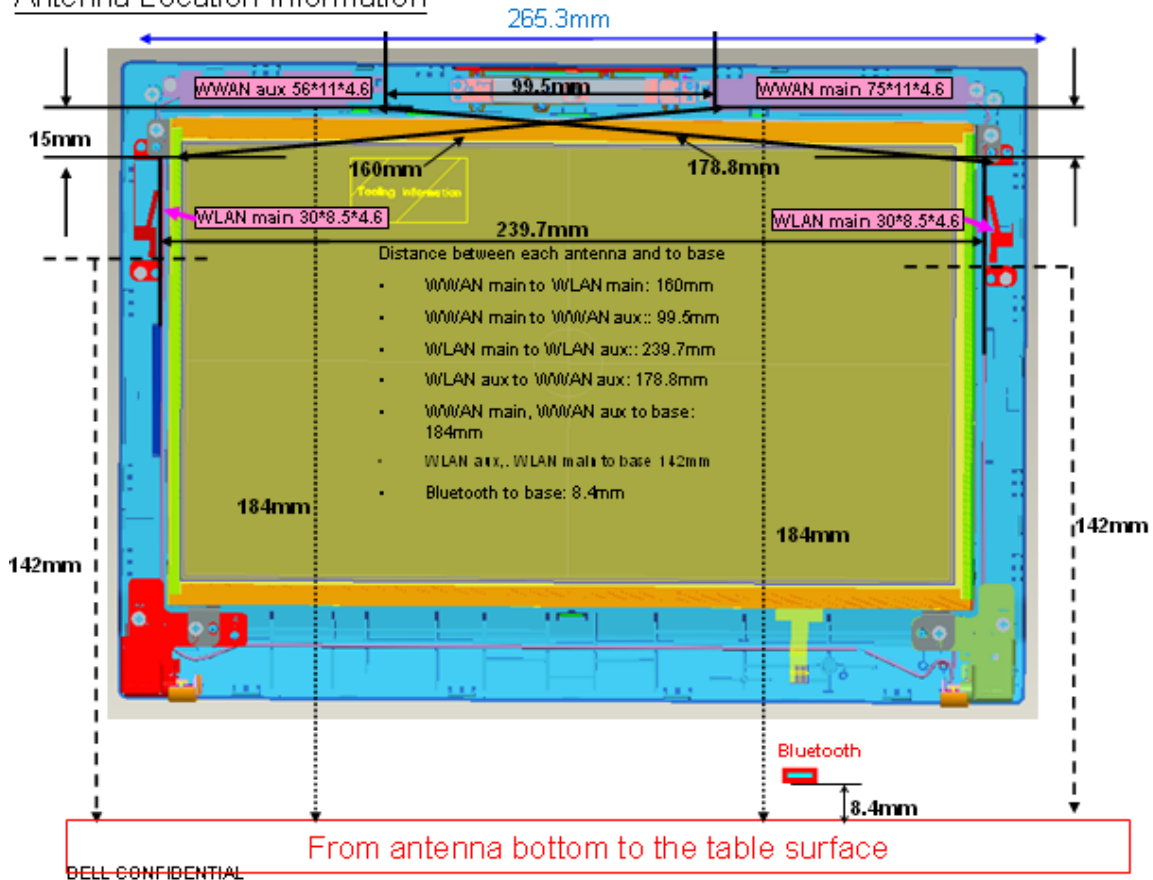

BELL CONFIDENTIAL

Power Measurement Setup

See setup pictures



1.5 Test Vector Details

The current test vectors do not use control symbols as in actual usage conditions. All UL symbols are traffic symbols transmitting at full power.

Test Vector File Name	BW	Calculated Duty Factor	DL/UL	UL duty Cycle Measured	Actual Power(mW)- Maximum power is used among L/M/H
DQ4_12_UQ16_12_10 M	10MHz	24.7%	32/15	23.9%	204 mW
DQ64_UQ4_12_21s_10 M	10 MHz	43.2%	23/24	41.8%	195 mW
DQ4_12_UQ16_34_5M	5 MHz	37%	26/21	35.9%	224 mW
DQ64_56_UQ4_12_5M	5 MHz	37%	26/21	36.4%	234.4 mW

The current configuration of the Intel WiMAX/WiFi Link 6250 test vectors operate with an unconventional DL:UL configuration as presented in the table above. Because of this scaling factors will have to be applied following the guidance of the FCC 802.16e/WiMAX Permit-But-Ask and SAR Guidance as per page 5 of said document.



Time Domain Plots Duty Factor Measurement

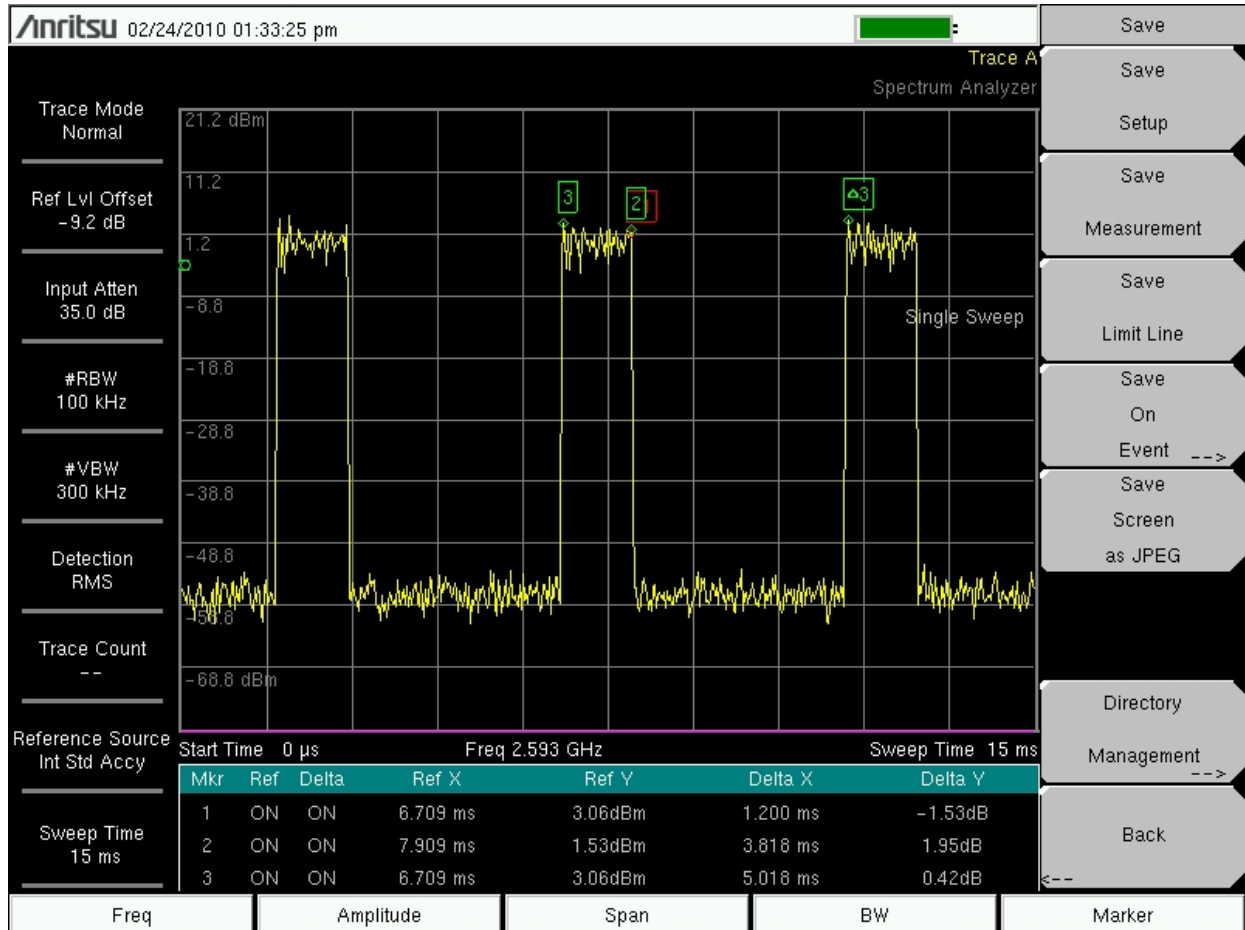

DQ4_12_UQ16_12_10M

NOTE:

These plots are for reference only and show the physical waveform measured for the SAR test and are not used for any of the scaling. The theoretical calculated duty factors are used for the SAR measured scaling factors.



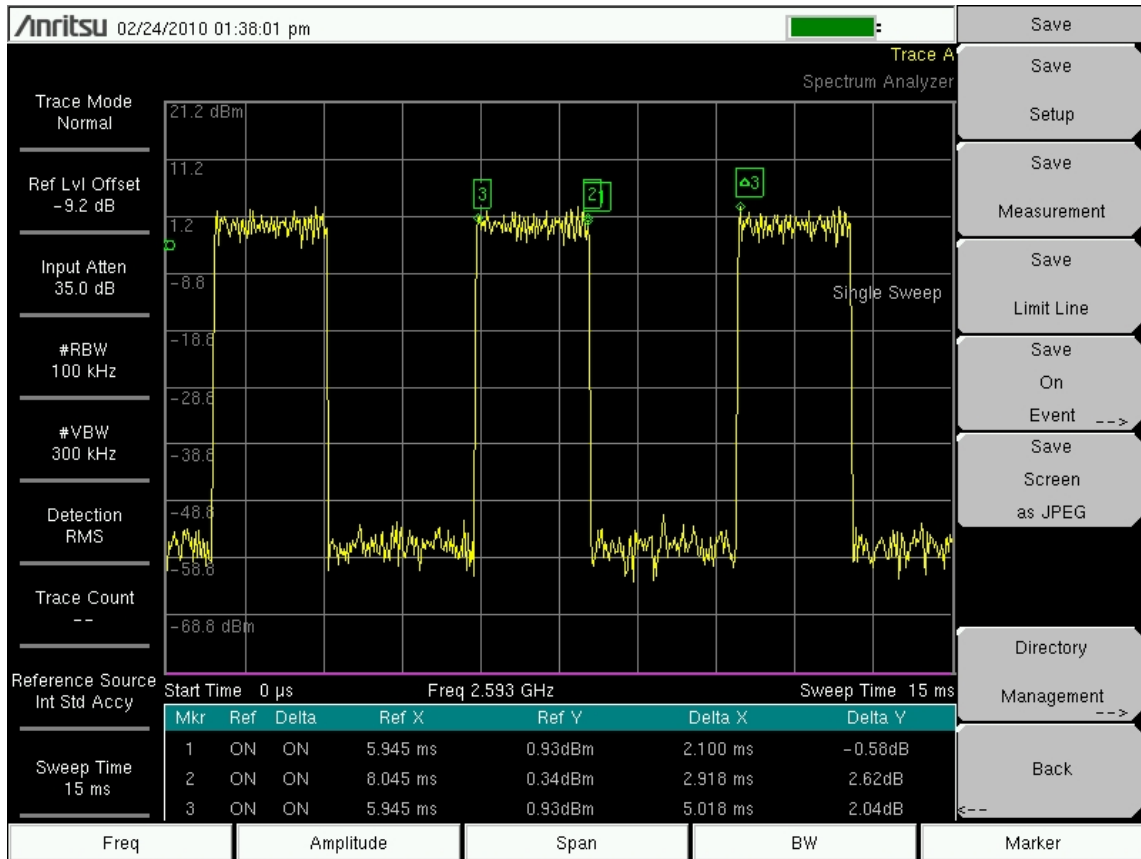

DQ64_UQ4_12_21S_10M

NOTE:

These plots are for reference only and show the physical waveform measured for the SAR test and are not used for any of the scaling. The theoretical calculated duty factors are used for the SAR measured scaling factors.



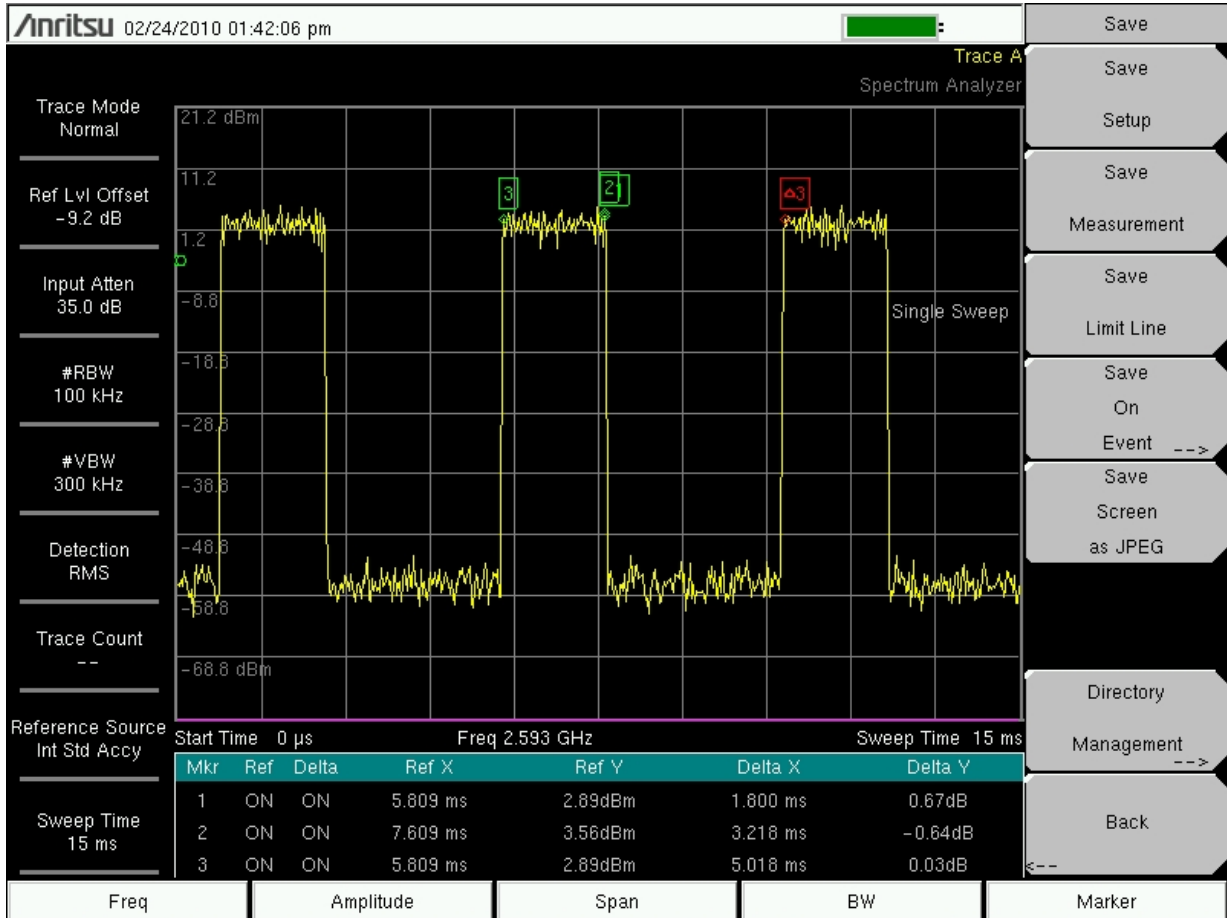

DQ64_56_UQ4_12_5M

NOTE:

These plots are for reference only and show the physical waveform measured for the SAR test and are not used for any of the scaling. The theoretical calculated duty factors are used for the SAR measured scaling factors.



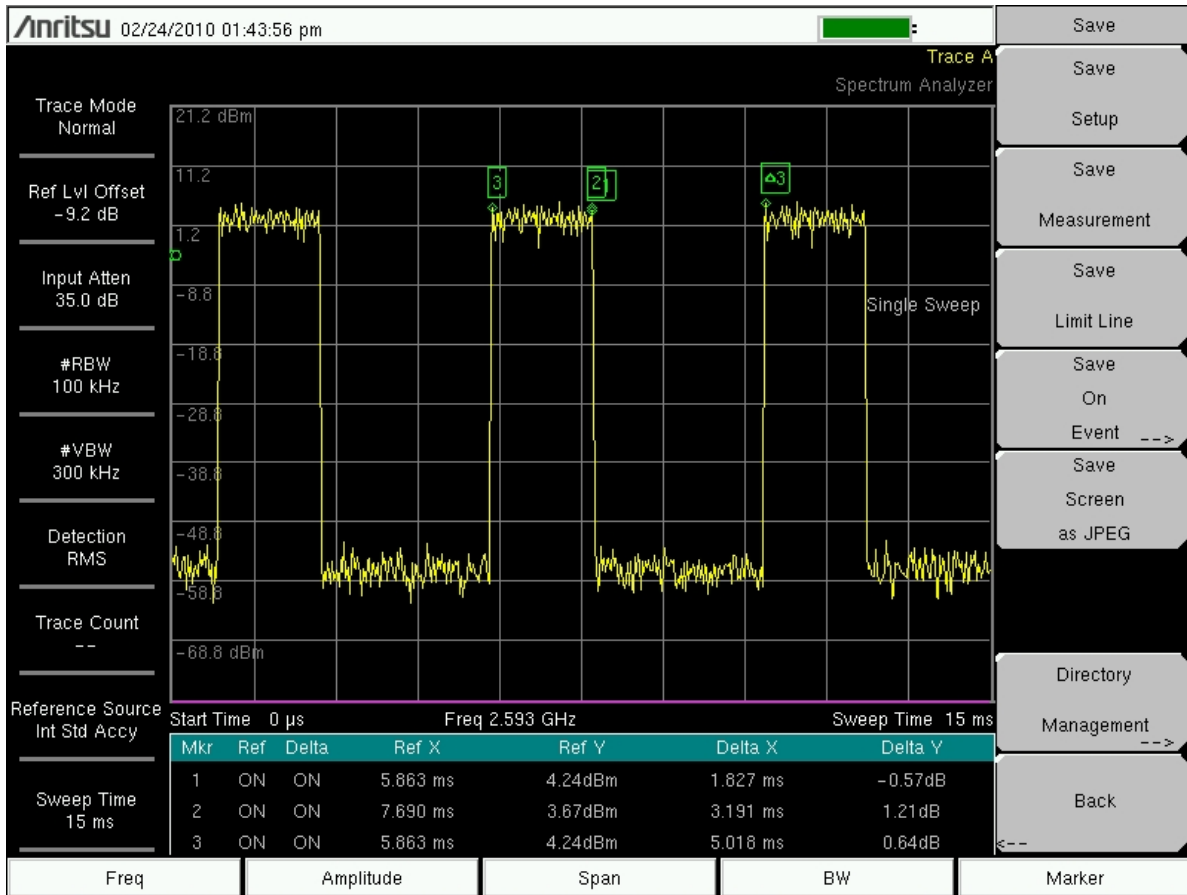

DQ4_12_UQ16_34_5M

NOTE:

These plots are for reference only and show the physical waveform measured for the SAR test and are not used for any of the scaling. The theoretical calculated duty factors are used for the SAR measured scaling factors.



1.6 WiMAX Power Measurements

Measurements were made with a spectrum analyzer.

Spectrum Analyser with Channel Power function and Gate On Peak power: RBW=100 kHz; VBW = 300 kHz with Peak detection, sweep time = 1 s Average power: RBW=100 kHz; VBW = 300 kHz with Average detection, sweep time = 1 s

Peak and average output power measurements were measured only during the ON time of the burst. If control symbols were turned on then it would be assumed that the PAR would exceed 8dBm (peak to average delta power) for all measurements on a “On Time Only” measurement. However, since the wave form is all traffic symbols at full power with no control symbols then hence the significant delta between what is measured and what one would normally expect to see.

Mode	Channel Band-Width (MHz)	Channel Number	Freq(MHz)	Conducted Power (dBm)		Peak to Average Ratio
				Peak	Average	
16QAM	10	736	2685	29.9	23.1	6.8

Mode	Channel Band-Width (MHz)	Channel Number	Freq(MHz)	Conducted Power (dBm)		Peak to Average Ratio
				Peak	Average	
QPSK	10	0	2501	28.9	22.6	6.3

Mode	Channel Band-Width (MHz)	Channel Number	Freq(MHz)	Conducted Power (dBm)		Peak to Average Ratio
				Peak	Average	
16QAM	5	756	2687.5	30.6	23.8	6.8

Mode	Channel Band-Width (MHz)	Channel Number	Freq(MHz)	Conducted Power (dBm)		Peak to Average Ratio
				Peak	Average	
QPSK	5	0	2498.5	30.6	23.7	6.9



The max target output power for a DL:UL ratio of 29:18 is then calculated as follows:

Modulation	Channel Bandwidth	29:18 DL:UL Ratio Power (mW)
16QAM	10MHz	$(32.71 \times 3) + (229 \times 15) = 3533.13\text{mW}$
QPSK	10MHz	$(32.71 \times 3) + (229 \times 15) = 3533.13\text{mW}$
16QAM	5MHz	$(79.12 \times 3) + (269 \times 15) = 4272.36\text{mW}$
QPSK	5Mz	$(79.12 \times 3) + (269 \times 15) = 4272.36\text{mW}$

DQ4_12_UQ16_12_10M (32:15 DL:UL Ratio) 10MHz / 16 QAM				
Channel #	Frequency (MHz)	Measured Power	# of Traffic Symbols	Traffic Symbols Power
0	2501	190.5mW	12	2286mW
368	2593	197.2mW	12	2366.4mW
736	2685	204.2mW	12	2450.4mW

DQ64_UQ4_12_21S_10M (23 :24 DL:UL Ratio) 10MHz / QPSK				
Channel #	Frequency (MHz)	Measured Power	# of Traffic Symbols	Traffic Symbols Power
0	2501	182mW	21	3822mW
368	2593	186.2mW	21	3910.2mW
736	2685	195mW	21	4095mW

DQ4_UQ16_34_5M (26 :21 DL:UL Ratio) 5MHz / 16 QAM				
Channel #	Frequency (MHz)	Measured Power	# of Traffic Symbols	Traffic Symbols Power
0	2498.5	229.1mW	18	4123.8mW
378	2593	251.2mW	18	4521.6mW
756	2687.5	240mW	18	4320mW

DQ64_56_UQ4_12_5M (26 :21 DL:UL Ratio) 5MHz / QPSK				
Channel #	Frequency (MHz)	Measured Power	# of Traffic Symbols	Traffic Symbols Power
0	2498.5	234.4mW	18	4219.2mW
378	2593	251.2mW	18	4521.6mW
756	2687.5	251.2mW	18	4521.6mW



Duty Factor Scaling to DL:UL Ratio of 29:18

DQ4_12_UQ16_12_10M (32:15 DL:UL Ratio) 10MHz / 16 QAM				
Channel #	Frequency (MHz)	29:18 Max Rated Power (traffic + control symbols)	32:15 Actual Traffic Symbol Power	Scaling Factor (max rated pwr/ actual pwr)
0	2501	3533.13	2286mW	1.545
368	2593	3533.13	2366.4mW	1.49
736	2685	3533.13	2450.4mW	1.44
DQ64_UQ4_12_21S_10M (23 :24 DL:UL Ratio) 10MHz / QPSK				
0	2501	3533.13	3822mW	0.92
368	2593	3533.13	3910.2mW	0.90
736	2685	3533.13	4095mW	0.86
DQ4_UQ16_34_5M (26 :21 DL:UL Ratio) 5MHz / 16 QAM				
0	2498.5	4272.36	4123.8mW	1.04
378	2593	4272.36	4521.6mW	0.94
756	2687.5	4272.36	4320mW	0.99
DQ64_56_UQ4_12_5M (26 :21 DL:UL Ratio) 5MHz / QPSK				
0	2498.5	4272.36	4219.2mW	1.01
378	2593	4272.36	4521.6mW	0.94
756	2687.5	4272.36	4521.6mW	0.94

By implementing the scaling changes the DL:UL is the equivalent to that presented in the table below.

Test Vector File Name	BW	Maximum DL/UL
DQ4_12_UQ16_12_10M	10MHz	29/18
DQ64_UQ4_12_21s_10M	10 MHz	29/18
DQ4_12_UQ16_34_5M	5 MHz	29/18
DQ64_56_UQ4_12_5M	5 MHz	29/18

NOTE:

If control symbols were present it can be assumed that the PAR would exceed 8dBm (peak to average delta power) for all measurements on a “On Time Only” measurement however the wave form is all traffic at full power hence the significant delta between what is measured and what the FCC would expect to see. Target Avg output power is the power shown in the original modular approval application for Tx on time only.



1.7 Duty Factor Power Scaling

The current configuration of the Intel WiMAX/WiFi Link 6250 test vectors operate with an unconventional DL:UL configuration as presented in the table below. Because of this scaling factors will have to be applied following the guidance of the FCC 802.16e/WiMAX Permit-But-Ask and SAR Guidance as per page 5 of said document.

Test Vector File Name	BW	Calculated Duty Factor	DL/UL	UL duty Cycle Measured
DQ4_12_UQ16_12_10 M	10MHz	24.7%	32/15	23.9%
DQ64_UQ4_12_21s_10 M	10 MHz	43.2%	23/24	41.8%
DQ4_12_UQ16_34_5M	5 MHz	37%	26/21	35.9%
DQ64_56_UQ4_12_5M	5 MHz	37%	26/21	36.4%

All scaling calculations are based on KDB 615223 FCC 802.16e/WiMAX Permit-But-Ask and SAR Guidance as per page 5-6.



1.8 Crest factor

The current configuration of the Intel WiMAX/WiFi Link 6250 test vectors operate with an unconventional DL:UL configuration as presented in the table below. If control symbols were present it can be assumed that the PAR would exceed 8dBm for all measurements on a “On Time Only” measurement however the wave form is all traffic at full power hence the significant delta between what is measured and what the FCC would expect to see.

Test Vector File Name	BW	Calculated Duty Factor	DL/UL	UL duty Cycle Measured (for reference only)	Crest Factor Used in SAR Measurement
DQ4_12_UQ16_12_10M	10MHz	24.7%	32/15	23.9%	4.05
DQ64_UQ4_12_21s_10M	10 MHz	43.2%	23/24	41.8%	2.3
DQ4_12_UQ16_34_5M	5 MHz	37%	26/21	35.9%	2.7
DQ64_56_UQ4_12_5M	5 MHz	37%	26/21	36.4%	2.7

The crest factor is calculated as follows for the test vector file,

$$\mathbf{DQ4_12_UQ16_12_10M = 1/Calculated DF = 1/24.7\% = 4.05}$$

The crest factor is calculated as follows for the test vector file,

$$\mathbf{DQ64_UQ4_12_21s_10M = 1/Calculated DF = 1/43.2\% = 2.3}$$

The crest factor is calculated as follows for the test vector file,

$$\mathbf{DQ4_12_UQ16_34_5M = 1/Calculated DF = 1/37\% = 2.7}$$

The crest factor is calculated as follows for the test vector file,

$$\mathbf{DQ64_56_UQ4_12_5M = 1/Calculated DF = 1/37\% = 2.7}$$



2.0 Applicable Documents

ANSI/IEEE C95.1-1999, IEEE Standard for Safety Levels with Respect to Human Exposure to Radio Frequency Electromagnetic Fields, 3 kHz to 300 GHz.

ANSI/IEEE C95.3-1992, IEEE Recommended Practice for the Measurement of Potentially Hazardous Electromagnetic Fields – RF and Microwave.

OET Bulletin 65 (Edition 97-01) Supplement C (Edition 01-01), “Evaluating Compliance with FCC Guidelines for Human Exposure to Radio Frequency Electromagnetic Fields”.

OET Laboratory Division FCC (December 2007) SAR Evaluation Considerations for Laptop Computers with Antennas Built –in on Display Screens

OET Laboratory Division FCC (May 2007 Revised) SAR Measurement Procedures for 802.11abg Transmitters

OET Laboratory Division FCC (October 2006) SAR Measurement Procedures for 3-6GHz

IEEE 1528b “Recommended Practice for Determining the Peak Spatial Average Specific Absorption Rate (SAR) in the Human Body Due to Wireless Communication Devices: Experimental Techniques.”

ICNIRP Guidelines “GUIDELINES FOR LIMITING EXPOSURE TO TIME-VARYING ELECTRIC, MAGNETIC, AND ELECTROMAGNETIC FIELDS (UP TO 300 GHz)”

IEC-62209 “Human exposure to radio frequency fields from hand-held and body-mounted wireless communication devices – Human models, instrumentation, and procedures”
 Part 1: “Procedure to determine the Specific Absorption Rate (SAR) for hand-held devices used in close proximity of the ear (frequency range of 300 MHz to 3 GHz)”

IEC-62209 “Human exposure to radio frequency fields from hand-held and body-mounted wireless communication devices – Human models, instrumentation, and procedures”
 Part 2 *Draft*: “Procedure to determine the Specific Absorption Rate (SAR) for hand-held devices used in close proximity of the ear (frequency range of 30 MHz to 6 GHz)”

OET Laboratory Division FCC Mobile and Portable Device RF Exposure Equipment Authorization Procedures KDB -447498

OET Laboratory Division FCC Permit But Ask Procedure KDB-388624

KDB 615223 FCC 802.16e/WiMAX Permit-But-Ask and SAR Guidance

3.0 ALSAS-10U System Description

APREL Laboratories ALSAS-10-U (APREL Laboratories SAR Assessment System) is fully optimized for the dosimetric evaluation of a broad range of wireless transceivers and antennas. It is an easy-to-use development and compliance tool, which provides excellent application flexibility. Developed in line with the latest methodologies it is fully compliant with the technical and scientific requirements of IEEE 1528, IEC 62212, CENELEC, ARIB, ACA, and the Federal Communications Commission. The system comprises of a six axes articulated robot which utilizes a dedicated controller.

ALSAS-10U has been developed with a strong engineering focus, and with custom modular software/hardware for the broadest range of applications, including dosimetry research and measurements in various Phantoms – SAM Phantom, UniPhantom™ Universal Phantom, Universal Flat Phantom and others.

Free space E-Field measurements of mobile devices and base station antennas can also be executed using ALSAS. With the current ALSAS configuration, several phantoms and setups can be arranged around the system – and since the phantoms are designed to be light and easy to move for interchanging between test frequencies.

ALSAS-10U has been developed using the latest methodologies and FDTD modeling to provide a platform which is repeatable with minimum uncertainty.

The ongoing commitment from APREL Laboratories to the field of Dosimetric research and development will ensure that the ALSAS-10-U measurement system can easily be upgraded to accommodate changes to wireless technologies, and scientific methodologies.



3.1 Applications

Predefined measurement procedures compliant with the guidelines of CENELEC, IEEE, IEC, FCC, etc are utilized during the assessment for the device. Automatic detection for all SAR maxima are embedded within the core architecture for the system, ensuring that peak locations used for centering the zoom scan are within a 1mm resolution and a 0.05mm repeatable position. A little less than 10 min per device position measurement completion time, (depending of DUT size) ensures minimum power drift during the assessment. No user interaction is required during the measurement processes: area scan, evaluation of cube maximal search, fine cube measurements and device power drift measurement. System operation range currently available up-to 6 GHz in simulated tissue.

ALSAS-10U can be used for all analog and digital devices, including wideband, spread spectrum and pulsed systems, etc.: handsets, handhelds, wireless data, electronic article surveillance, accessories, wireless access points, WLAN, cordless, radio, etc.

3.2 Visualization and reporting

2/3D isoline distribution, scatter graphics, polar graphics, and vector reproduction. Device representation and phantom visualization in 2/3D graphics with measurement data overlaid (in color plot format). Freely configurable output graphic formats with automatic title, data and legend generation which includes all relevant information relating to the measurement process. Uncertainty analysis and budget calculated and reported drawing on active device drift assessment, and tissue simulation values.

3.3 Field scans

ALSAS-10U can provide multiple scan types including Measurements along lines (X, Y, Z), multiple planes, curved surfaces (normalize probe to surface), volumes in free space or restricted volumes (phantoms). Cube measurements with surface extrapolation and spatial SAR evaluation for 1g and/or 10g. Time measurements (source power drift). Probe rotation measurements (isotropy) and many others in line with the requirements of any given standard or procedure.

3.3.1 Area Scans

Area scans are defined prior to the measurement process being executed with a user defined variable spacing between each measurement point (integral) allowing low uncertainty measurements to be conducted. Scans defined for FCC applications utilize a 10mm² step integral, with 1mm interpolation used to locate the peak SAR area used for zoom scan assessments.

A maximum area scan size is set at 280mm x 200mm which can be changed to a smaller size dependent on the filed distribution of the device under test. The area scan size is documented within the SAR report which is delivered by the SAR system software.

Where the system identifies multiple SAR peaks (which are within 2dB of each peak value) the system will provide the user with the option of assessing each peak location individually for zoom scan averaging.

3.3.2 Zoom Scan (Cube Scan Averaging)

The averaging zoom scan volume utilized in the ALSAS-10U software is in the shape of a cube and the side dimension of a 1 g or 10 g mass is dependent on the density of the liquid representing the simulated tissue. A density of 1 000 kg/m³ is used to represent the head and body tissue density and not the phantom liquid density, in order to be consistent with the definition of the liquid dielectric properties, i.e. the side length of the 1 g cube is 10mm, with the side length of the 10 g cube 21,5mm.

When the cube intersects with the surface of the phantom, it is oriented so that 3 vertices touch the surface of the shell or the centre of a face is tangent to the surface. The face of the cube closest to the surface is modified in order to conform to the tangent surface. The centre of the cube and the tangential angle associated defines each face of the cube so that all transitional points follow this tangential angle.

The zoom scan integer steps can be user defined so as to reduce uncertainty, but normal practice for typical test applications (including FCC) utilize a physical step of 5x5x9 (8mmx8mmx4mm Fx <3GHz) and 9x9x17 (4mmx4mmx2mm Fx >3GHz) providing a volume of 32mm in the X & Y axis, and 32mm in the Z axis. All points remain tangential to the surface by utilizing the normalize (probe tilt) feature so as to reduce measurement uncertainty.

3.4 Operator settings

Multiple access levels (password protected) for parametric modifications/test scenarios in line with selected standards, including the FCC. Any number of predefined settings (probes, phantoms, liquids, devices, measurement procedures, etc.) can be stored for future use and repeatable assessments.

3.5 ALSAS-10U Interpolation and Extrapolation Uncertainty

The overall uncertainty for the methodology and algorithms that are used during the SAR calculation was evaluated using the data from IEEE 1528 based on the example f3 algorithm:

$$f_3(x, y, z) = A \frac{a^2}{\frac{a^2}{4} + x'^2 + y'^2} \cdot \left(e^{-\frac{2z}{a}} + \frac{a^2}{2(a + 2z)^2} \right)$$

4.0 ALSAS-10U Hardware

The ALSAS-10U comprises of hardware designed exclusively by APREL Laboratories based on methodologies presented in IEEE 1528, IEC 62212, CENELEC and FCC supplement C OET bulletin 65.

4.1 Isotropic E-Field Probe

The isotropic E-Field probe used by APREL Laboratories, has been fully calibrated and assessed for isotropicity, and boundary effect within a controlled environment. Depending on the frequency for which the probe is calibrated the method utilized for calibration will change. APREL Laboratories utilize a number of methods for calibrating probes, and these are outlined in the table below.

Calibration Frequency (MHz)	Air Calibration	Tissue Calibration
300	TEM Cell	Temperature
450	TEM Cell	Temperature
835	TEM Cell	Temperature
900	TEM Cell	Temperature
1800	TEM Cell	Temperature
1900	TEM Cell	Temperature
2450	Waveguide	Waveguide
2600	Waveguide	Waveguide
5200	Waveguide	Waveguide
5600	Waveguide	Waveguide
5800	Waveguide	Waveguide

The APREL Laboratories E-Field probe utilizes a triangular sensor arrangement as detailed in the diagram below.



SAR is assessed with a calibrated probe which moves at a default height of 1.4mm from the centre of the diode, which is mounted to the sensor, to the phantom surface (in the Z Axis). The 1.4mm offset height has been selected so as to minimize any resultant boundary effect due to the probe being in close proximity to the phantom surface.

The following algorithm is an example of the function used by the system for linearization of the output from the probe when measuring complex modulation schemes.

$$V_i = U_i + U_i^2 \cdot \frac{cf}{dcp_i}$$

4.2 Isotropic E-Field Probe Specification

Calibration in Air	Frequency Dependent Below 2GHz Calibration in air performed in a TEM Cell Above 2GHz Calibration in air performed in waveguide
Sensitivity	0.60 $\mu\text{V}/(\text{V}/\text{m})^2$ to 1.25 $\mu\text{V}/(\text{V}/\text{m})^2$
Dynamic Range	0.001 W/kg to 100 W/kg
Isotropic Response	Better than 0.2dB in air Better than 0.1dB in tissue
Diode Compression Point (DCP)	Calibrated for Specific Frequency typically 95mV +/- 10%
Probe Tip Radius	<2.9mm
Sensor Offset	1.06 (+/-0.02mm)
Probe Length	290mm
Video Bandwidth	@ 500 Hz: 1 dB @ 1.02 KHz: 3 dB
Boundary Effect	Less than 2% for distances greater than 1.4mm
Spatial Resolution	Better than 1mm
Probe Diameter	Less than 2.8mm

4.3 WiMAX Probe Calibration

Standard approach following IEEE-1528 and IEC-62209 has been used for the probe calibration.

The E-Field probe is calibrated in a waveguide so as to determine the sensitivity, isotropy and tissue conversion factor at the frequency applicable. Linearity and sensitivity are derived in the waveguide using a standard CW signal.

A validation is then executed using a standard dipole antenna using the derived sensitivities and tissue conversion factor to establish uncertainty for the calibrated probe.

The linearity for the probe is presented on the chart below.

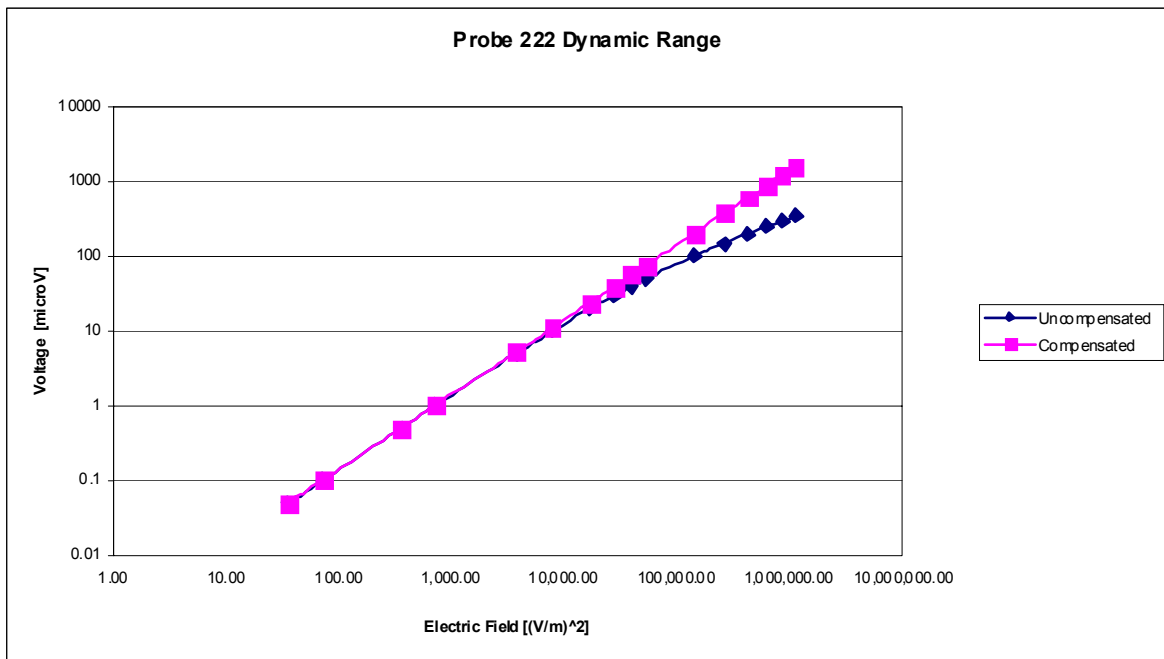

Probe Linearity @ 2600MHz CW

All assessments are made at 2600MHz with tissue dielectric parameters in the table below.

Frequency	Epsilon	Sigma
2600MHz	52.4	2.15

4.3 Boundary Detection Unit and Probe Mounting Device

ALSAS-10U incorporates a boundary detection unit with a sensitivity of 0.05mm for detecting all types of surfaces. The robust design allows for detection during probe tilt (probe normalize) exercises, and utilizes a second stage emergency stop. The signal electronics are fed directly into the robot controller for high accuracy surface detection in lateral and axial detection modes (X, Y, & Z).

The probe is mounted directly onto the Boundary Detection unit for accurate tooling and displacement calculations controlled by the robot kinematics. The probe is connect to an isolated probe interconnect where the output stage of the probe is fed directly into the amplifier stage of the Daq-Paq.

4.4 Daq-Paq (Analog to Digital Electronics)

ALSAS-10U incorporates a fully calibrated Daq-Paq (analog to digital conversion system) which has a 4 channel input stage, sent into an amplifier module. The input signal is amplified accordingly so as to offer a dynamic range from 5µV to 800mV. Integration of the fields measured is carried out at board level utilizing a Co-Processor which then sends the measured fields down into the main computational module in digitized form via an RS232 communications port. Probe linearization and duty cycle compensation is carried out within the main Daq-Paq module.

ADC	16 Bit
Amplifier Range	30 µV to +200 mV (16 bit resolution: 4µV, 400mV)
Field Integration	Local Co-Processor utilizing proprietary integration algorithms
Number of Input Channels	4 in total 3 dedicated and 1 spare
Communication	Packet data via RS232



4.5 Axis Articulated Robot



ALSAS-10U utilizes a six axis articulated robot, which is controlled using a Pentium based real-time movement controller. The movement kinematics engine utilizes proprietary (Thermo CRS) interpolation and extrapolation algorithms, which allow full freedom of movement for each of the six joints within the working envelope. Utilization of joint 6 allows for full probe rotation with a tolerance better than 0.05mm around the central axis.

Robot/Controller Manufacturer	Thermo CRS
Number of Axis	Six independently controlled axis
Positioning Repeatability	0.05mm
Controller Type	Single phase Pentium based C500C
Robot Reach	710mm
Communication	RS232 and LAN compatible

4.6 ALSAS Universal Workstation

ALSAS Universal workstation was developed with a strong engineering focus taking into consideration flexibility and engineering needs, and the necessity to have integrated system which will allow for repeatability and fast adaptability. ALSAS workstation technology is stable and robust in structure, but at the same time flexible so that users can do calibration, testing and measurements using different types of phantoms with one set up, which significantly speeds up the measurement process.

The workstation incorporates a modular structure which can be easily adapted to specific engineering requirements and needs. Phantoms which are self contained modular units are easily located, removable and swappable. Three fully configurable shelves allow for setting up of a test device in a way which can either utilize the APREL Laboratories device positioner, or custom designed units. When using the modular shelf for positioning of a device, additional loading characteristics have been avoided.

The workstation has been constructed entirely out of composite wood and Canadian maple, with all metallic fasteners kept at a compliant distance from the Device under test.



4.7 Universal Device Positioner

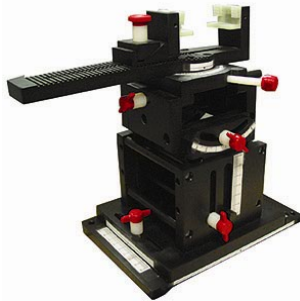

The APREL Laboratories universal device positioner has been developed so as to allow complete freedom of movement of the DUT. Developed to hold a DUT in a free-space scenario any additional loading attributable to the material used in the construction of the positioner has been eliminated. Repeatability has been enhanced through the linear scales which form the design used to indicate positioning for any given test scenario in all major axes. A 15° tilt indicator has been included for the of aid cheek to tilt movements for head SAR analysis. Overall uncertainty for measurements have been reduced due to the design of the Universal device positioner, which allows positioning of a device in as near to a free-space scenario as possible, and by providing the means for complete repeatability.



Length	201mm
Width	140mm
Height	222mm
Weight	1.95kg
Number of Axis	6 axis freedom of movement
Translation Along MB Line	+/- 76.2mm
Translation Along NF Line	+/- 38.1mm
Translation Along Z Axis	+/- 25.4mm (expandable to 500mm)
Rotation Around MB Line (yaw)	+/- 10°
Rotation Around NF Line (pitch)	+/- 30°
Rotation Around Z Axis (roll)	360° full circle
Minimum Grip Range	0mm
Maximum Grip	152mm
Maximum Distance from Device to Positioner Material	40mm
Tilt Movement	Full movement with predefined 15° guide

4.8 Phantom Types

The ALSAS-10U has been designed so as to allow the integration of multiple phantom types. This includes but is not limited to the APREL Laboratories SAM Phantoms fully compliant with IEEE 1528, Universal Phantom, and Universal Flat.

4.8.1 APREL SAM Phantoms

The APREL Laboratories SAM phantoms have been designed so as to aid repeatability and positioning for any DUT. Developed using the IEEE SAM CAD file they are fully compliant with the requirements for both IEEE 1528 and FCC Supplement C. Both the left and right SAM phantoms are interchangeable, transparent and include the IEEE 1528 grid with visible NF and MB lines.

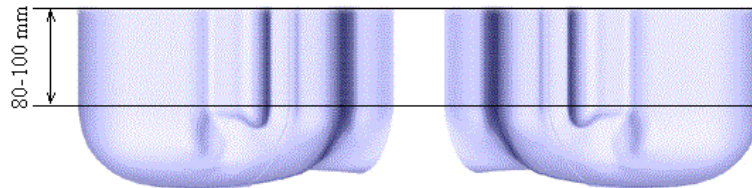

Compliant Standards	IEEE-1528, IEC 62212, CENELEC, and others
Manufacturing Process	Injection molded
Material	Composite urethane
Manufacturing Tolerance	+/- 0.2mm
Frame Material	Corian
Tissue Simulation Volume	7 ltr with 15cm tissue
Thickness	2mm nominally 6mm at NF/MB intersection
Loss Tangent	<0.05
Relative Permittivity	<5
Resistant to Solvents	Resistant to all solvents detailed in IEEE 1528
Load Deflection	<1mm with sugar water compositions

4.8.2 APREL Laboratories Universal Phantom



The APREL Laboratories Universal Phantom has been developed as an engineering tool for both compliance and development. It is also used on the ALSAS-10U as a system validation phantom. The unique design allows repeatable measurements for all devices, including handsets, PDA units, laptop computers, and validation dipoles. The APREL Laboratories Universal Phantom has been fully validated both experimentally from 800MHz to 6GHz and numerically using XFDTD numerical software. The shell thickness is 2mm overall, with a 4mm spacer located at the NF/MB intersection providing an overall thickness of 6mm in line with the requirements of IEEE-1528. The design allows for fast and accurate measurements, of handsets, by allowing the conservative SAR to be evaluated at on frequency for

both left and right head experiments in one measurement. The phantom is surrounded by a Corian frame, which adds additional support and load bearing characteristics.

Compliant Standards	IEEE-1528, IEC 62212, CENELEC, and others
Frequency Range	800MHz to 6GHz
Material	Vivac
Manufacturing Tolerance	+/- 0.2mm
Frame Material	Corian
Tissue Simulation Volume	8 ltr with 15cm tissue
Thickness	2mm nominally 6mm at NF/MB intersection
Loss Tangent	<0.05
Relative Permittivity	<5
Resistant to Solvents	Resistant to all solvents detailed in IEEE 1528
Load Deflection	<1% Length with sugar water compositions
Dimensions	Length 220mm x breadth 170mm



4.9 Validation Dipoles

APREL Laboratories utilize dipoles based on the IEEE-1528 standard, and have ensured that they comply with mechanical and electrical specifications in line with the requirements of both IEEE and FCC Supplement C. The table below provides details for the mechanical and electrical specifications for the dipoles used by APREL Laboratories.

Body validation target numbers have been derived using XFDTD numerical software, and validated experimentally.

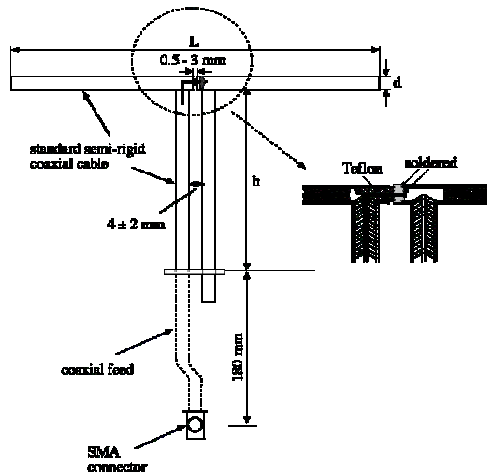

APREL Laboratories have developed high frequency dipoles based on current scientific research carried both experimentally and numerically here at the APREL Laboratories site. Mechanical and electrical parameters for the dipoles have been established using experimental and numerical techniques, and target SAR values have been established following IEC methodologies. The results of the experimental and numerical research have been published and released for peer review.

Frequency (MHz)	L (mm)	h (mm)	d (mm)
300	396.0	250.0	6.0
450	270.0	166.7	6.0
835	161.0	89.8	3.6
900	149.0	83.3	3.6
1450	89.1	51.7	3.6
1800	72.0	41.7	3.6
1900	68.0	39.5	3.6
2000	64.5	37.5	3.6
2450	51.5	30.4	3.6
2600	49.0	30	3.6
3000	41.5	25.0	3.6
5200	23.6	14	3.6
5800	21.6	13	3.6
5190-5900	23.1	20.7	3.6

5.0 Tissue Simulation Fluid

Tissue simulation fluids in the frequency range of 450MHz to 2450MHz are based on IEEE-1528 and FCC Supplement C guidelines. All fluids meet the dielectric specifications as outlined in the above standards (within allowable tolerances) and are calibrated on a regular basis, to maintain stability. The recipes used along with the dielectric target values are included in the table below.

Ingredients (% Weight)	450 MHz Head	835 MHz Head	915 MHz Head	1900 MHz Head	2450 MHz Head
Water	38.56	41.45	41.05	54.9	62.7
Salt	3.95	1.45	1.35	0.18	0.5
Sugar	56.32	56.0	56.5	x	x
HEC	0.98	1.0	1.0	x	x
Bactericide	0.19	0.1	0.1	0.1	X
Triton-X	X	X	X	X	36.8
DGBE	X	X	X	44.92	x
ϵ^r	43.42	42.54	42.0	39.9	39.8
δ	0.85	0.91	1.0	1.42	1.88

Ingredients (% Weight)	450 MHz Body	835 MHz Body	915 MHz Body	1900 MHz Body	2450 MHz Body
Water	51.16	52.4	56.0	40.4	73.2
Salt	1.49	1.4	0.76	0.5	0.04
Sugar	46.78	45.0	41.76	58.0	X
HEC	0.52	1.0	1.21	1.0	X
Bactericide	0.05	0.1	0.27	0.1	X
Triton-X	X	X	X	X	X
DGBE	X	X	X	X	26.7
ϵ^r	58.0	56.1	56.8	54.0	52.5
δ	0.83	0.95	1.07	1.45	1.95

NOTE. Recipes are based on those presented in FCC Supplement C Page 36.

For frequencies above 2450MHz recipes will be presented as and when requested by a designated body.

Ingredients (% Weight)	2600 MHz Body	5200 MHz Body	5600 MHz Body	5800 MHz Body
Water	69.6	x	x	x
Salt	0.03	x	x	x
Sugar	X	x	x	x
HEC	X	x	x	x
Bactericide	X	x	x	x
Triton-X	X	x	x	x
DGBE	30.37	x	x	x
ϵ^r	52.4	48.9	47.6	48.2
δ	2.15	5.35	5.8	6.00



5.1 Tissue Calibration Procedure Using a Coaxial Probe

The VNA (Vector Network Analyzer) is configured and calibrated for the frequency of the simulated tissue which has to be assessed. The Coaxial probe is then calibrated in line with the tissue frequency using an open, short, and De-Ionized water routine. The sample of simulated tissue is placed into a non-metallic container for use during the calibration. The temperature of the simulated tissue sample is measured. The probe head is then completely immersed in the simulated tissue sample (the probe is held in place using a non metallic probe holder). The simulated tissue sample is then measured to assess the permittivity and conductivity.

5.2 Tissue Calibration Results

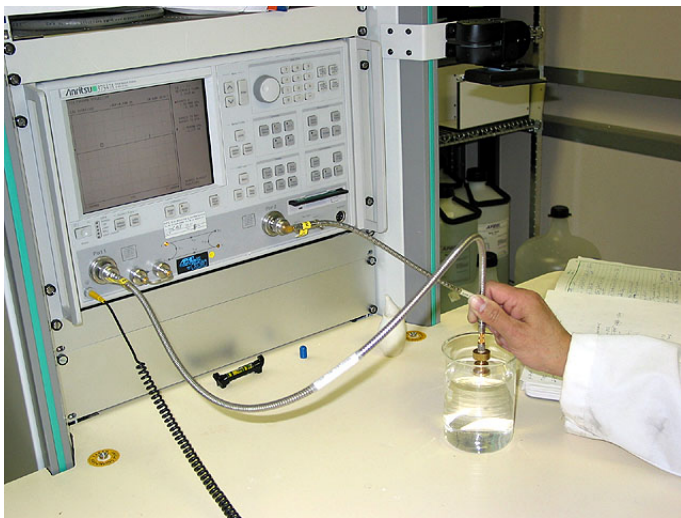

Tissue used during the SAR assessment is calibrated prior to use in the measurement process. APREL Laboratories use the co-axial probe method for all tissue calibration exercises. Tissue which is being used over a period of 24 hours is re-calibrated to ensure that no change to the dielectric properties will affect the SAR measurement process. The table below provides details of the results from the tissue equivalent dielectric calibration. This project was conducted over a period of 6 days and the tissues were calibrated daily to ensure that they met the values presented below.

Calibrated By	Calibration Date	Frequency MHz	Tissue Type	Epsilon (ϵ')	Sigma (δ)
Maryna. N	Daily	2450	Body	50.8	2.01
Maryna. N	Daily	2600	Body	50.28	2.15
Maryna. N	Daily	5200	Body	49.31	5.25
Maryna. N	Daily	5600	Body	47.81	5.85
Maryna. N	Daily	5800	Body	47.07	6.19

Variation of the tissue was maintained daily to be less than 2%.

6.0 System Validation

ALSAS-10U is fully validated prior to the SAR assessment of the DUT following methodologies presented in IEEE-1528 section 8. The system is validated using tissue which has been calibrated within a 24 hour period. When the measurement process exceeds a 24 hour period a secondary system validation is executed and the results presented within this test report. The graphic plots resulting from the system validation are included in Appendix A SAR plots.

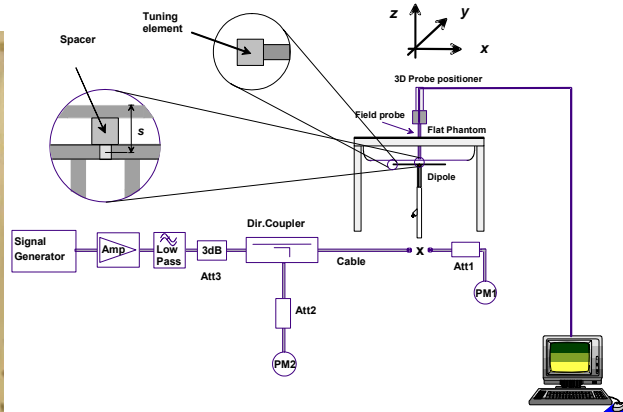

Date	Validation Frequency (MHZ)	Dipole Separation Distance mm	Power W	Dipole	SAR 1g W/kg	Target 1g W/kg
Daily	2450	10	1.0	AL-CD10	51.8	52.9
Daily	2600	10	1.0	ALS-WiMAX	53.1	54.4
Daily	5200	10	1.0	Broad-band	52.6	51.8
Daily	5600	10	1.0	Broad-band	51.3	52.1
Daily	5800	10	1.0	Broad-band	48.6	49.1

Currently no standards are in place for validating a system while using body tissue. System validation and values are based on current guidance coming from the FCC and utilize the APREL Laboratories dipoles for frequencies above 5GHz. This project was conducted over a period of 6 working days and when necessary system validations were repeated when the test completion was greater than a 24 hour period. Where the system validation was greater than 2% from those presented above the tissue was then reassessed and brought back to within 2% of initial dielectric values to show consistency throughout the measurement cycle.

6.1 SAR Linearity

In the normal use condition the SAR is mostly measured close to or in the noise floor. This makes it difficult to show linearity for SAR measurements. Additional measurements were made on the laptop with the LCD facing the phantom using the waveform and power setting which gave the highest SAR in the pre-test analysis. Additional measurements were made to reduce the power by 50% to show linearity. The SAR linearity exercise was ran with the LCD directly against the phantom (as per the image below) so as to show linearity and that the wireless card is not in saturation. To do this the device was rotated from the normal use condition to the SAR linearity device position.

See setup pictures

SAR Linearity Device Position

Normal Use Condition

SAR Linearity

QPSK 10MHz

Average Power mW	0	12.5	25	50	100	200
Measured 1g SAR	0	0.07	0.137	0.274	0.52	1.04
Linear Line	0	0.07	0.14	0.28	0.56	1.12

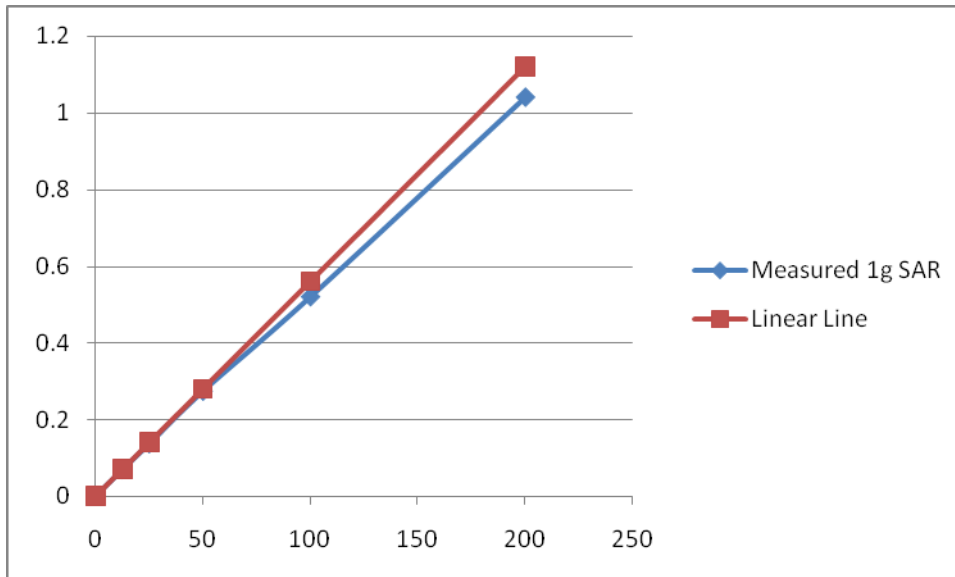

Maximum Deviation @ 200mW = 7.1%



16 QAM 10MHz

Average Power mW	0	12.5	25	50	100	200
Measured 1g SAR	0	0.092	0.182	0.359	0.701	1.314
Linear Line	0	0.092	0.184	0.368	0.736	1.472

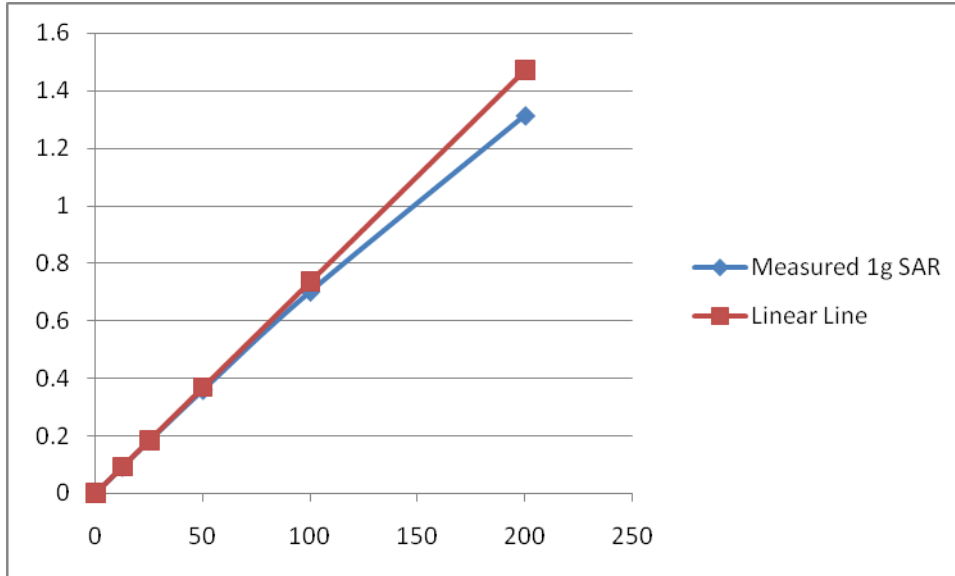

Maximum Deviation @ 200mW = 10.7%



QPSK 5MHz

Average Power mW	0	12.5	25	50	100	200
Measured 1g SAR	0	0.055	0.109	0.22	0.421	0.821
Linear Line	0	0.055	0.111	0.221	0.442	0.884

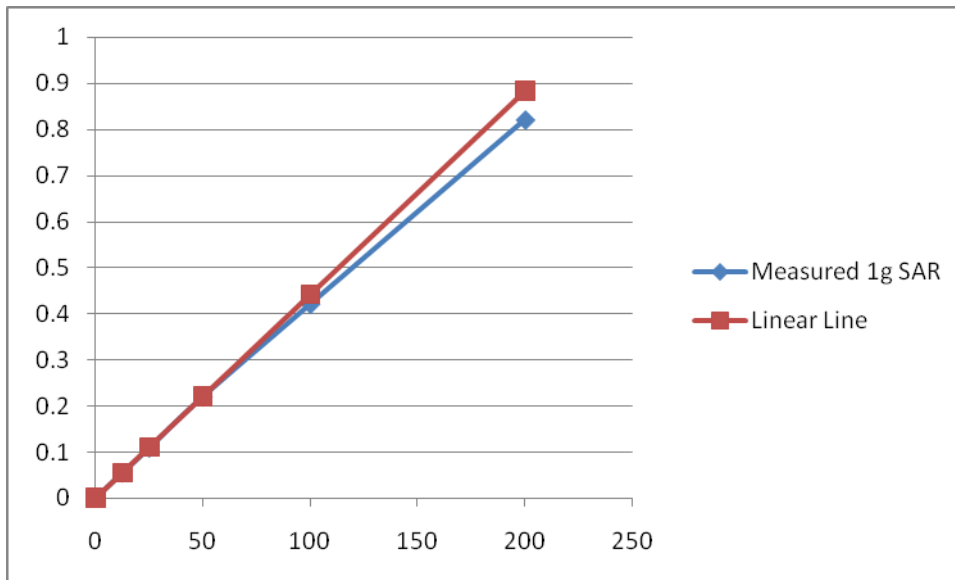

Maximum Deviation @ 200mW = 7.1%



16QAM 5MHz

Average Power mW	0	12.5	25	50	100	200
Measured 1g SAR	0	0.052	0.103	0.201	0.409	0.763
Linear Line	0	0.052	0.104	0.208	0.416	0.832

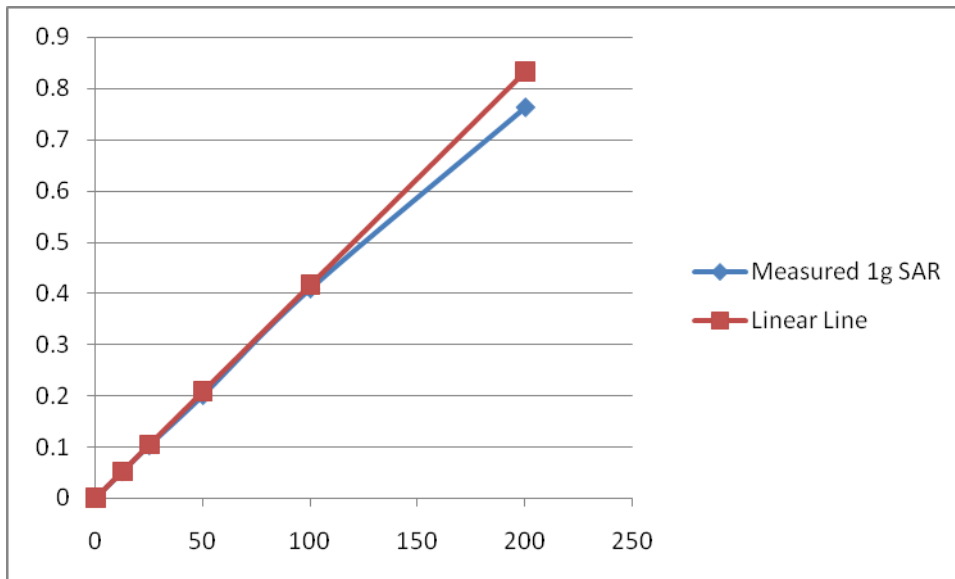

Maximum Deviation @ 200mW = 8.3%



6.2 WiMAX System Validation

Additional validation procedures were made to determine the linearity of the test setup and to ensure that the probe and electronics were functioning correctly.

The values presented below relate to the deviation from the standard CW validation target numbers along with deviations from predicted values when the signal is modulated with the appropriate square waveform.

Frequency	Separation	Power	Measured	Target
2600	10	1.0	53.1	54.4

All measurements were taken at 2600MHz

Measured with dipole and CW signal

100 mW	2.4%
200 mW	3.4%
500 mW	2.8%

6.1 Experimental Results Summary

The results for each experimental assessment are contained within this section. Where any deviation has been made from the given procedures contained within IEEE-1528 or FCC Supplement C this has been described accordingly.

6.2 SAR Measurement Procedure

The ALSAS-10U calculates SAR using the following equation,

$$SAR = \frac{\sigma |E|^2}{\rho}$$

σ : represents the simulated tissue conductivity
 ρ : represents the tissue density

The DUT is set to transmit at the required power in line with product specification, at each frequency relating to the LOW, MID, and HIGH channel settings.

Pre-scans are made on the device to establish the location for the transmitting antenna, using a large area scan in either air or tissue simulation fluid.

The DUT is placed against the Universal Phantom where the maximum area scan dimensions are larger than the physical size of the resonating antenna. When the scan size is not large enough to cover the peak SAR distribution, it is modified by either extending the area scan size in both the X and Y directions, or the device is shifted within the predefined area.

The area scan is then run to establish the peak SAR location (interpolated resolution set at 1mm²) which is then used to orient the center of the zoom scan. The zoom scan is then executed and the 1g and 10g averages are derived from the zoom scan volume (interpolated resolution set at 1mm³).

6.3 SAR Exposure Limits

SAR assessments have been made in line with the requirements of the documents listed in section 2 of this report.

Type of Exposure	Uncontrolled Environment Limit
Spatial Peak SAR (1g cube tissue for brain or body)	1.60 W/kg
Spatial Average SAR (whole body)	0.08 W/kg
Spatial Peak SAR (10g for hands, feet, ankles and wrist)	4.00 W/kg



6.4 Equipment List

APREL Laboratories utilize the following equipment.

Equipment Description	Asset/Serial Number	Calibration Date
ALSAS-10U	301571	Prior to Test and Every 24hrs
Boundary Detection Unit	301572	Calibrated Once
Daq-Paq	301573	January 2009
Pentium 4 Workstation	301574	Not Required
Signal Generator	301468	September 2009
Anritsu SpectrumMaster MS2721B	301620	September 2009
HP-Directional Coupler	100251	October 2009
APREL Laboratories 800-4200MHz 12W Amplifier	301577	Prior to Test
APREL Laboratories 2450MHz Validation Dipole	301581	November 2009
APREL Laboratories E-030 E-Field Probe	226	May 2009
40MHz -20GHz VNA	301382	August 2009
TRL Calibration Kit	301582	January 2009
APREL Laboratories Coaxial Probe (Dielectric Probe Kit)	100757	Prior to Test
APREL Laboratories Universal Phantom	301511	Calibrated Once
APREL Laboratories SAM Phantom LHS	301500	Calibrated Once
APREL Laboratories SAM Phantom RHS	301501	Calibrated Once
APREL Laboratories 15mm Dipole Separation Kit	301546	Calibrated Once
APREL Laboratories 10mm Dipole Separation Kit	301547	Calibrated Once
APREL Laboratories 5-6GHz 2 W Amplifier	NYA	March 2009
APREL Laboratories MMW Directional Coupler	NYA	March 2009
APREL Laboratories 5240MHz Validation Dipole	301460	March 2009
APREL Laboratories 5800MHz Validation Dipole	PT-015-a	March 2009
ALSAS-10 Device Positioner ALS-H-E-SET-2	ALS-H-E-SET-2-LAB1	Not Required
APREL Laboratories 2600MHz Validation Dipole	ALS-WiMAX-2600	July 12 th 2009
Agilent ESG	100892	September 2009

6.5 SAR Measurement Results

Intel® WiFi-Link 6250 Series Network Connection with AUDEN Antennas **802.11b MODE**

Power	16.64dBm
DUT Position	Underside
Separation	0mm
Antenna Type	IFA
Antenna Manufacturer	AUDEN
Antenna Location	Right Hand Side
Power Mode	Battery
Tx Frequency	2412-2462MHz
Duty Cycle	100%
Epsilon	50.8
Sigma	2.01
Tissue Depth	15cm
Phantom Type	Universal
DUT Workstation Location	Centre
Device Positioner	Not Needed
Test Date	March 2010
Test Engineer	Maryna. N

Mode	Antenna Separation Distance	Separation Distance (mm)	Channel	Frequency MHz	1g SAR W/kg
802.11b	142mm	0	1	2412	0.022
802.11b	142mm	0	6	2437	0.021
802.11b	142mm	0	11	2462	0.027

Chain B

Mode	Antenna Separation Distance	Channel	Frequency MHz	1g SAR W/kg
802.11b	142mm	6	2437	0.024

SAR Limit	Conservative Measured SAR
1.6 W/kg 1 gram Average Maximum	0.027 W/kg 1gram Average

SAR Plot for Conservative SAR Included in Appendix A.



Intel® WiFi-Link 6250 Series Network Connection with AUDEN Antennas **802.11g MODE**

Power	16.64dBm
DUT Position	Underside
Separation	0mm
Antenna Type	IFA
Antenna Manufacturer	AUDEN
Antenna Location	Right Hand Side
Power Mode	Battery
Tx Frequency	2412-2462MHz
Duty Cycle	100%
Epsilon	50.8
Sigma	2.01
Tissue Depth	15cm
Phantom Type	Universal
DUT Workstation Location	Centre
Device Positioner	Not Needed
Test Date	March 2010
Test Engineer	Maryna. N

Mode	Antenna Separation Distance	Separation Distance (mm)	Channel	Frequency MHz	1g SAR W/kg
802.11g	142mm	0	1	2412	0.022
802.11g	142mm	0	6	2437	0.061
802.11g	142mm	0	11	2462	0.024

Chain B

Mode	Antenna Separation Distance	Channel	Frequency MHz	1g SAR W/kg
802.11g	142mm	6	2437	0.024

SAR Limit	Conservative Measured SAR
1.6 W/kg 1 gram Average Maximum	0.061 W/kg 1gram Average

SAR Plot for Conservative SAR Included in Appendix A.



Intel® WiFi-Link 6250 Series Network Connection with AUDEN Antennas **2450n MODE**

Power	16.64dBm
DUT Position	Underside
Separation	0mm
Antenna Type	IFA
Antenna Manufacturer	AUDEN
Antenna Location	Right Hand Side
Power Mode	Battery
Tx Frequency	2412-2462MHz
Duty Cycle	100%
Epsilon	50.8
Sigma	2.01
Tissue Depth	15cm
Phantom Type	Universal
DUT Workstation Location	Centre
Device Positioner	Not Needed
Test Date	March 2010
Test Engineer	Maryna. N

Mode	Antenna Separation Distance	Separation Distance (mm)	Channel	Frequency MHz	1g SAR W/kg
802.11n	142mm	0	1	2412	0.029
802.11n	142mm	0	6	2437	0.024
802.11n	142mm	0	11	2462	0.074
802.11n 40MHz	142mm	0	6	2437	0.056

Chain B

Mode	Separation Distance (mm)	Channel	Frequency MHz	1g SAR W/kg
802.11n 40MHz	142mm	11	2462	0.050

SAR Limit	Conservative Measured SAR
1.6 W/kg 1gram Average Maximum 20MHz	0.074 W/kg 1gram Average
1.6 W/kg 1gram Average Maximum 40MHz	0.056 W/kg 1gram Average

SAR Plot for Conservative SAR Included in Appendix A.





SAR & HAC Instruments for Wireless • Consulting • Research • Standards • Compliance • Training

Intel® WiFi-Link 6250 Series Network Connection with AUDEN Antennas **WiMAX MODE**

Scaling factor calculated using actual measured power

Power	As Below
DUT Position	Underside
Separation	0mm
Antenna Type	IFA
Antenna Manufacturer	AUDEN
Antenna Location	Right Hand Side
Power Mode	Battery/AC
Tx Frequency	2501-2685MHz
Duty Cycle	Calculated
Epsilon	50.28
Sigma	2.15
Tissue Depth	15cm
Phantom Type	Universal
DUT Workstation Location	Centre
Device Positioner	Not Needed
Test Date	April 2010
Test Engineer	Maryna. N

Mode	Antenna Separation Distance	Channel	Average Power mW	Frequency MHz	Waveform 16QAM	1g SAR W/kg	Scaling Factor	Corrected SAR
WiMAX	157mm	0	190.5mW	2501	DQ4_12_UQ16_12_10M	0.024	1.545	0.037
WiMAX	157mm	386	197.2mW	2593	DQ4_12_UQ16_12_10M	0.021	1.49	0.031
WiMAX	157mm	736	204.2mW	2685	DQ4_12_UQ16_12_10M	0.022	1.44	0.032

Scaling factor calculated using actual measured power

Mode	Antenna Separation Distance	Channel	Average Power mW	Frequency MHz	Waveform QPSK	1g SAR W/kg	Scaling Factor	Corrected SAR
WiMAX	157mm	0	182mW	2501	DQ64_UQ4_12_21S_10M	0.032	0.92	0.029
WiMAX	157mm	386	186.2mW	2593	DQ64_UQ4_12_21S_10M	0.030	0.90	0.027
WiMAX	157mm	736	195mW	2685	DQ64_UQ4_12_21S_10M	0.024	0.86	0.021

Scaling factor calculated using actual measured power

Mode	Antenna Separation Distance	Channel	Average Power mW	Frequency MHz	Waveform 16QAM	1g SAR W/kg	Scaling Factor	Corrected SAR
WiMAX	157mm	0	229.1mW	2501	DQ4_12_UQ16_34_5M	0.023	1.04	0.024
WiMAX	157mm	386	251.2mW	2593	DQ4_12_UQ16_34_5M	0.032	0.94	0.030
WiMAX	157mm	736	240mW	2685	DQ4_12_UQ16_34_5M	0.030	0.99	0.030

Scaling factor calculated using actual measured power

Mode	Antenna Separation Distance	Channel	Average Power mW	Frequency MHz	Waveform QPSK	1g SAR W/kg	Scaling Factor	Corrected SAR
WiMAX	157mm	0	234.4mW	2501	DQ64_56_UQ4_12_5M	0.025	1.01	0.025
WiMAX	157mm	386	251.2mW	2593	DQ64_56_UQ4_12_5M	0.030	0.94	0.028
WiMAX	157mm	736	251.2mW	2685	DQ64_56_UQ4_12_5M	0.029	0.94	0.027

SAR Limit	Conservative Measured SAR
1.6 W/kg 1gram Average Maximum	0.024 W/kg 1gram Average Corrected 0.037W/kg 16QAM 10MHz

SAR Plot for Conservative SAR Included in Appendix A.





SAR & HAC Instruments for Wireless • Consulting • Research • Standards • Compliance • Training

Intel® WiFi-Link 6250 Series Network Connection with AUDEN Antennas **802.11a Low Band MODE**

Power	14.81dBm
DUT Position	Underside
Separation	0mm
Antenna Type	IFA
Antenna Manufacturer	AUDEN
Antenna Location	Right Hand Side
Power Mode	Battery
Tx Frequency	5180-5320MHz
Duty Cycle	100%
Epsilon	49.31
Sigma	5.25
Tissue Depth	15cm
Phantom Type	Universal
DUT Workstation Location	Centre
Device Positioner	Not Needed
Test Date	March 2010
Test Engineer	Maryna. N

Mode	Antenna Separation Distance	Separation Distance (mm)	Channel	Frequency MHz	1g SAR W/kg
802.11a	142mm	0	36	5180	0.082
802.11a	142mm	0	52	5260	0.084
802.11a	142mm	0	64	5320	0.103

Chain B

Mode	Antenna Separation Distance	Channel	Frequency MHz	1g SAR W/kg
802.11a	142mm	64	5320	0.076

SAR Limit	Conservative Measured SAR
1.6 W/kg 1gram Average Maximum	0.103 W/kg 1gram Average

SAR Plot for Conservative SAR Included in Appendix A.





SAR & HAC Instruments for Wireless • Consulting • Research • Standards • Compliance • Training

Intel® WiFi-Link 6250 Series Network Connection with AUDEN Antennas 802.11an Low Band MODE

Power	14.81dBm
DUT Position	Underside
Separation	0mm
Antenna Type	IFA
Antenna Manufacturer	AUDEN
Antenna Location	Right Hand Side
Power Mode	Battery
Tx Frequency	5180-5320MHz
Duty Cycle	100%
Epsilon	49.31
Sigma	5.25
Tissue Depth	15cm
Phantom Type	Universal
DUT Workstation Location	Centre
Device Positioner	Not Needed
Test Date	March 2010
Test Engineer	Maryna. N

Mode	Antenna Separation Distance	Channel	Frequency MHz	1g SAR W/kg
802.11n 20MHz	142mm	64	5320	0.095
802.11n 40MHz	142mm	62	5310	0.097

Chain B

Mode	Antenna Separation Distance	Channel	Frequency MHz	1g SAR W/kg
802.11a	142mm	64	5320	0.091

SAR Limit	Conservative Measured SAR
1.6 W/kg 1gram Average Maximum	0.097 W/kg 1gram Average

SAR Plot for Conservative SAR Included in Appendix A.



Intel® WiFi-Link 6250 Series Network Connection with AUDEN Antennas **802.11a Mid Band MODE**

Power	14.55dBm
DUT Position	Underside
Separation	0mm
Antenna Type	IFA
Antenna Manufacturer	AUDEN
Antenna Location	Right Hand Side
Power Mode	Battery
Tx Frequency	5500-5700MHz
Duty Cycle	100%
Epsilon	47.81
Sigma	5.85
Tissue Depth	15cm
Phantom Type	Universal
DUT Workstation Location	Centre
Device Positioner	Not Needed
Test Date	March 2010
Test Engineer	Maryna. N

Mode	Antenna Separation Distance	Channel	Frequency MHz	1g SAR W/kg
802.11a	142mm	100	5500	0.101
802.11a	142mm	120	5600	0.097
802.11a	142mm	140	5700	0.117

Chain B

Mode	Antenna Separation Distance	Channel	Frequency MHz	1g SAR W/kg
802.11a	142mm	140	5700	0.088

SAR Limit	Conservative Measured SAR
1.6 W/kg 1gram Average Maximum	0.117 W/kg 1gram Average

SAR Plot for Conservative SAR Included in Appendix A.





SAR & HAC Instruments for Wireless • Consulting • Research • Standards • Compliance • Training

Intel® WiFi-Link 6250 Series Network Connection with AUDEN Antennas **802.11an Mid Band MODE**

Power	14.55dBm
DUT Position	Underside
Separation	0mm
Antenna Type	IFA
Antenna Manufacturer	AUDEN
Antenna Location	Right Hand Side
Power Mode	Battery
Tx Frequency	5500-5700MHz
Duty Cycle	100%
Epsilon	47.81
Sigma	5.85
Tissue Depth	15cm
Phantom Type	Universal
DUT Workstation Location	Centre
Device Positioner	Not Needed
Test Date	March 2010
Test Engineer	Maryna. N

Mode	Antenna Separation Distance	Channel	Frequency MHz	1g SAR W/kg
802.11n 20MHz	142mm	140	5700	0.134
802.11n 40MHz	142mm	134	5670	0.085

Chain B

Mode	Antenna Separation Distance	Channel	Frequency MHz	1g SAR W/kg
802.11a	142mm	140	5700	0.091

SAR Limit	Conservative Measured SAR
1.6 W/kg 1gram Average Maximum	0.110 W/kg 1gram Average

SAR Plot for Conservative SAR Included in Appendix A.



Intel® WiFi-Link 6250 Series Network Connection with AUDEN Antennas **802.11a High Band MODE**

Power	14.68dBm
DUT Position	Underside
Separation	0mm
Antenna Type	IFA
Antenna Manufacturer	AUDEN
Antenna Location	Right Hand Side
Power Mode	Battery
Tx Frequency	5745-5825MHz
Duty Cycle	100%
Epsilon	47.07
Sigma	6.19
Tissue Depth	15cm
Phantom Type	Universal
DUT Workstation Location	Centre
Device Positioner	Not Needed
Test Date	March 2010
Test Engineer	Maryna. N

Mode	Antenna Separation Distance	Channel	Frequency MHz	1g SAR W/kg
802.11a	142mm	149	5745	0.089
802.11a	142mm	157	5785	0.124
802.11a	142mm	165	5825	0.111

Chain B

Mode	Antenna Separation Distance	Channel	Frequency MHz	1g SAR W/kg
802.11a	142mm	157	5785	0.111

SAR Limit	Conservative Measured SAR
1.6 W/kg 1gram Average Maximum	0.124 W/kg 1gram Average

SAR Plot for Conservative SAR Included in Appendix A.





SAR & HAC Instruments for Wireless • Consulting • Research • Standards • Compliance • Training

Intel® WiFi-Link 6250 Series Network Connection with AUDEN Antennas **802.11an Mid Band MODE**

Power	14.68dBm
DUT Position	Underside
Separation	0mm
Antenna Type	IFA
Antenna Manufacturer	AUDEN
Antenna Location	Right Hand Side
Power Mode	Battery
Tx Frequency	5745-5825MHz
Duty Cycle	100%
Epsilon	47.07
Sigma	6.19
Tissue Depth	15cm
Phantom Type	Universal
DUT Workstation Location	Centre
Device Positioner	Not Needed
Test Date	March 2010
Test Engineer	Maryna. N

Mode	Antenna Separation Distance	Channel	Frequency MHz	1g SAR W/kg
802.11n 20MHz	142mm	157	5785	0.122
802.11n 40MHz	142mm	159	5795	0.116

Chain B

Mode	Antenna Separation Distance	Channel	Frequency MHz	1g SAR W/kg
802.11n 20MHz	142mm	165	5825	0.112

SAR Limit	Conservative Measured SAR
1.6 W/kg 1gram Average Maximum	0.122 W/kg 1gram Average

SAR Plot for Conservative SAR Included in Appendix A.





SAR & HAC Instruments for Wireless • Consulting • Research • Standards • Compliance • Training

6.6 Additional Information

The Intel® WiFi-Link 6250 Series Network Connection card located inside a Dell laptop computer was tested at other locations to ensure a conservative SAR was assessed.

See setup pictures





SAR & HAC Instruments for Wireless • Consulting • Research • Standards • Compliance • Training

Appendix A SAR Plots



SAR Test Report

Report Date : 24-Mar-2010
 By Operator : 123
 Measurement Date : 24-Mar-2010
 Starting Time : 24-Mar-2010 12:09:02 PM
 End Time : 24-Mar-2010 12:20:48 PM
 Scanning Time : 706 secs

Product Data
 Device Name : Mott-Auden-WiMAX
 Serial No. : 5N793
 Type : Other
 Model : Auden - 6250
 Frequency : 2450.00 MHz
 Max. Transmit Pwr : 1 W
 Drift Time : 0 min(s)
 Length : 115 mm
 Width : 85 mm
 Depth : 10 mm
 Antenna Type : Internal
 Orientation : Touch
 Power Drift-Start : 0.007 W/kg
 Power Drift-Finish : 0.007 W/kg
 Power Drift (%) : -4.037
 Picture : C:\alsas\bitmap\Mott-WiMAX-1.bmp

Phantom Data
 Name : APREL-Uni
 Type : Uni-Phantom
 Size (mm) : 280 x 280 x 200
 Serial No. : User Define
 Location : Center
 Description : U

Tissue Data
 Type : BODY
 Serial No. : 2450_B
 Frequency : 2450.00 MHz
 Last Calib. Date : 22-Mar-2010
 Temperature : 20.00 °C
 Ambient Temp. : 20.00 °C
 Humidity : 45.00 RH%
 Epsilon : 50.1 F/m
 Sigma : 2.02 S/m
 Density : 1000.00 kg/cu. m

Probe Data

Name : .E30
 Model : E30
 Type : E-Field Triangle
 Serial No. : 222
 Last Calib. Date : 04-Feb-2010
 Frequency : 2450.00 MHz
 Duty Cycle Factor: 1
 Conversion Factor: 4.0
 Probe Sensitivity: 1.20 1.20 1.20 $\mu\text{V}/(\text{V}/\text{m})^2$
 Compression Point: 95.00 mV
 Offset : 0.56 mm

Measurement Data

Crest Factor : 1
 Scan Type : Complete
 Tissue Temp. : 21.00 °C
 Ambient Temp. : 22.00 °C
 Set-up Date : 24-Mar-2010
 Set-up Time : 11:08:53 AM
 Area Scan : 5x7x1 : Measurement x=10mm, y=10mm, z=4mm
 Zoom Scan : 5x5x8 : Measurement x=8mm, y=8mm, z=4mm

Other Data

DUT Position : Touch
 Separation : 142
 Channel : High



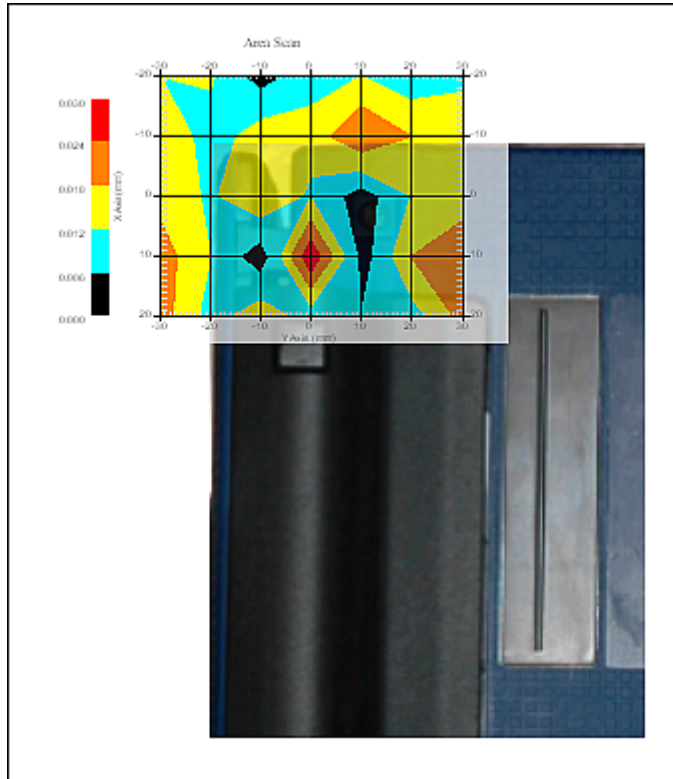

1 gram SAR value : 0.074 W/kg
 Zoom Scan Peak SAR : 0.130 W/kg





SAR & HAC Instruments for Wireless • Consulting • Research • Standards • Compliance • Training

Exposure Assessment Measurement Uncertainty

Source of Uncertainty	Tolerance Value	Probability Distribution	Divisor	c_i^{-1} (1-g)	c_i^{-1} (10-g)	Standard Uncertainty (1-g) %	Standard Uncertainty (10-g) %
Measurement System							
Probe Calibration	3.5	normal	1	1	1	3.5	3.5
Axial Isotropy	3.7	rectangular	•3	$(1-cp)^{1/2}$	$(1-cp)^{1/2}$	1.5	1.5
Hemispherical Isotropy	10.9	rectangular	•3	•cp	•cp	4.4	4.4
Boundary Effect	1.0	rectangular	•3	1	1	0.6	0.6
Linearity	4.7	rectangular	•3	1	1	2.7	2.7
Detection Limit	1.0	rectangular	•3	1	1	0.6	0.6
Readout Electronics	1.0	normal	1	1	1	1.0	1.0
Response Time	0.8	rectangular	•3	1	1	0.5	0.5
Integration Time	1.7	rectangular	•3	1	1	1.0	1.0
RF Ambient Condition	3.0	rectangular	•3	1	1	1.7	1.7
Probe Positioner Mech.	0.4	rectangular	•3	1	1	0.2	0.2
Restriction							
Probe Positioning with respect to Phantom Shell	2.9	rectangular	•3	1	1	1.7	1.7
Extrapolation and Integration	3.7	rectangular	•3	1	1	2.1	2.1
Test Sample Positioning	4.0	normal	1	1	1	4.0	4.0
Device Holder Uncertainty	2.0	normal	1	1	1	2.0	2.0
Drift of Output Power	4.0	rectangular	•3	1	1	2.3	2.3
Phantom and Setup							
Phantom Uncertainty (shape & thickness tolerance)	3.4	rectangular	•3	1	1	2.0	2.0
Liquid Conductivity (target)	5.0	rectangular	•3	0.7	0.5	2.0	1.4
Liquid Conductivity (meas.)	3.1	normal	1	0.7	0.5	2.2	1.5
Liquid Permittivity (target)	5.0	rectangular	•3	0.6	0.5	1.7	1.4
Liquid Permittivity (meas.)	3.6	normal	1	0.6	0.5	2.2	1.8
Combined Uncertainty		RSS				10.0	9.6
Combined Uncertainty (coverage factor=2)		Normal (k=2)				20.0	19.3



SAR-Z Axis

at Hotspot x:2.15 y:-16.10

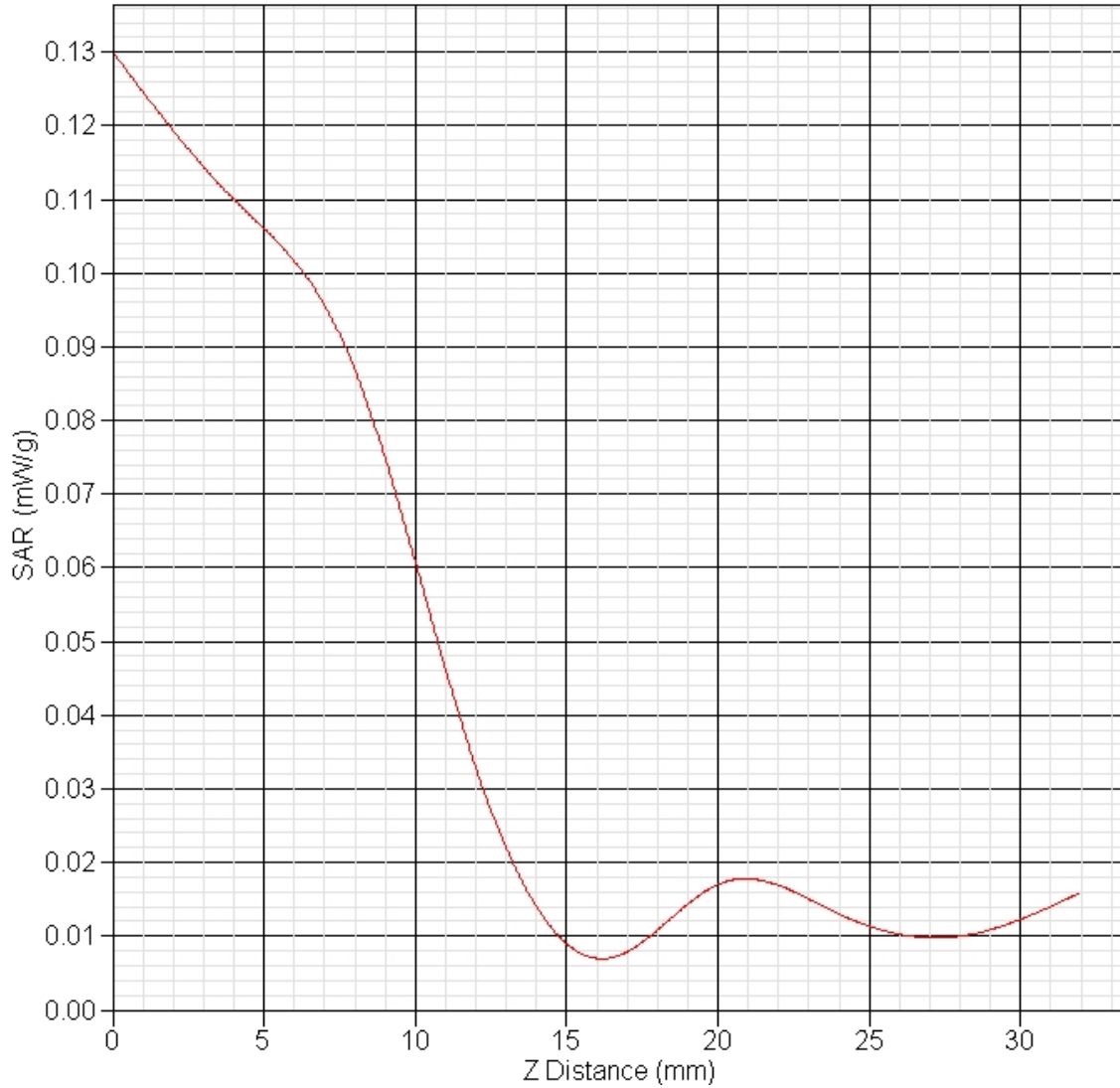

SAR Test Report

WiMAX 16QAM 10MHz

Report Date : 01-Apr-2010
 By Operator : 123
 Measurement Date : 01-Apr-2010
 Starting Time : 01-Apr-2010 08:56:05 AM
 End Time : 01-Apr-2010 09:19:54 AM
 Scanning Time : 1429 secs

Product Data
 Device Name : Mott-Auden-WiMAX
 Serial No. : 5N793
 Type : Other
 Model : Auden - 6250
 Frequency : 2600.00 MHz
 Max. Transmit Pwr : 1 W
 Drift Time : 0 min(s)
 Length : 115 mm
 Width : 85 mm
 Depth : 10 mm
 Antenna Type : Internal
 Orientation : Touch
 Power Drift-Start : 0.014 W/kg
 Power Drift-Finish: 0.015 W/kg
 Power Drift (%) : 3.805
 Picture : C:\alsas\bitmap\Mott-WiMAX-1.bmp

Phantom Data
 Name : APREL-Uni
 Type : Uni-Phantom
 Size (mm) : 280 x 280 x 200
 Serial No. : User Define
 Location : Center
 Description : U

Tissue Data
 Type : BODY
 Serial No. : 2600-B
 Frequency : 2600.00 MHz
 Last Calib. Date : 31-Mar-2010
 Temperature : 20.00 °C
 Ambient Temp. : 20.00 °C
 Humidity : 50.00 RH%
 Epsilon : 49.5 F/m
 Sigma : 2.19 S/m
 Density : 1000.00 kg/cu. m

Probe Data

Name : .E30
 Model : E30
 Type : E-Field Triangle
 Serial No. : 222
 Last Calib. Date : 05-Feb-2010
 Frequency : 2600.00 MHz
 Duty Cycle Factor: 2.3
 Conversion Factor: 3.95
 Probe Sensitivity: 1.20 1.20 1.20 $\mu\text{V}/(\text{V}/\text{m})^2$
 Compression Point: 95.00 mV
 Offset : 0.56 mm

Measurement Data

Crest Factor : 2.3
 Scan Type : Complete
 Tissue Temp. : 21.00 °C
 Ambient Temp. : 22.00 °C
 Set-up Date : 01-Apr-2010
 Set-up Time : 8:52:58 AM
 Area Scan : 9x5x1 : Measurement x=10mm, y=10mm, z=4mm
 Zoom Scan : 7x7x7 : Measurement x=5mm, y=5mm, z=5mm

Other Data

DUT Position : Touch
 Separation : 157
 Channel : Low



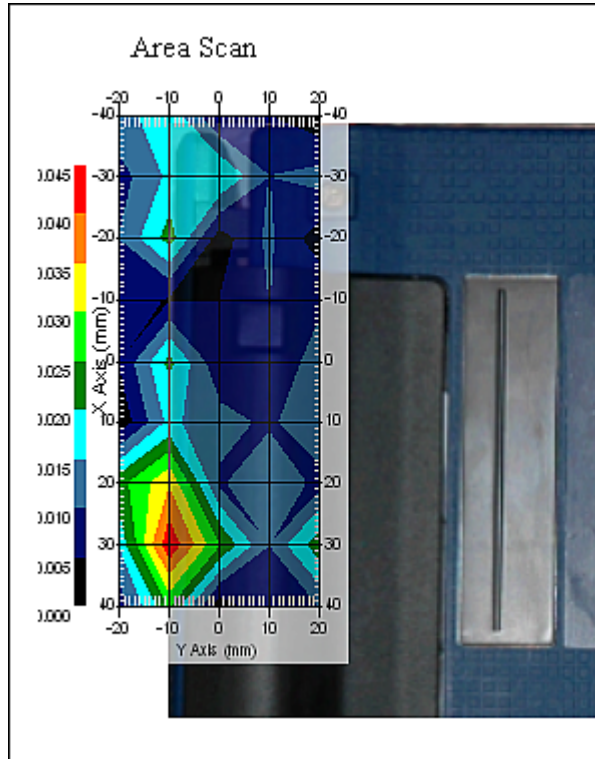

1 gram SAR value : 0.024 W/kg
 Zoom Scan Peak SAR : 0.120 W/kg





SAR & HAC Instruments for Wireless • Consulting • Research • Standards • Compliance • Training

Exposure Assessment Measurement Uncertainty

Source of Uncertainty	Tolerance Value	Probability Distribution	Divisor	c_i^{-1} (1-g)	c_i^{-1} (10-g)	Standard Uncertainty (1-g) %	Standard Uncertainty (10-g) %
Measurement System							
Probe Calibration	3.5	normal	1	1	1	3.5	3.5
Axial Isotropy	3.7	rectangular	•3	$(1-cp)^{1/2}$	$(1-cp)^{1/2}$	1.5	1.5
Hemispherical Isotropy	10.9	rectangular	•3	•cp	•cp	4.4	4.4
Boundary Effect	1.0	rectangular	•3	1	1	0.6	0.6
Linearity	4.7	rectangular	•3	1	1	2.7	2.7
Detection Limit	1.0	rectangular	•3	1	1	0.6	0.6
Readout Electronics	1.0	normal	1	1	1	1.0	1.0
Response Time	0.8	rectangular	•3	1	1	0.5	0.5
Integration Time	1.7	rectangular	•3	1	1	1.0	1.0
RF Ambient Condition	3.0	rectangular	•3	1	1	1.7	1.7
Probe Positioner Mech.	0.4	rectangular	•3	1	1	0.2	0.2
Restriction							
Probe Positioning with respect to Phantom Shell	2.9	rectangular	•3	1	1	1.7	1.7
Extrapolation and Integration	3.7	rectangular	•3	1	1	2.1	2.1
Test Sample Positioning	4.0	normal	1	1	1	4.0	4.0
Device Holder Uncertainty	2.0	normal	1	1	1	2.0	2.0
Drift of Output Power	3.8	rectangular	•3	1	1	1.9	1.9
Phantom and Setup							
Phantom Uncertainty (shape & thickness tolerance)	3.4	rectangular	•3	1	1	2	2
Liquid Conductivity (target)	5.0	rectangular	•3	0.7	0.5	2	1.4
Liquid Conductivity (meas.)	1.4	normal	1	0.7	0.5	3.3	2.3
Liquid Permittivity (target)	5.0	rectangular	•3	0.6	0.5	1.7	1.4
Liquid Permittivity (meas.)	1.4	normal	1	0.6	0.5	2.5	2.1
Combined Uncertainty		RSS				13.4	11.1
Combined Uncertainty (coverage factor=2)		Normal (k=2)				26.8	22.2



SAR-Z Axis at Hotspot x:40.35 y:-0.12

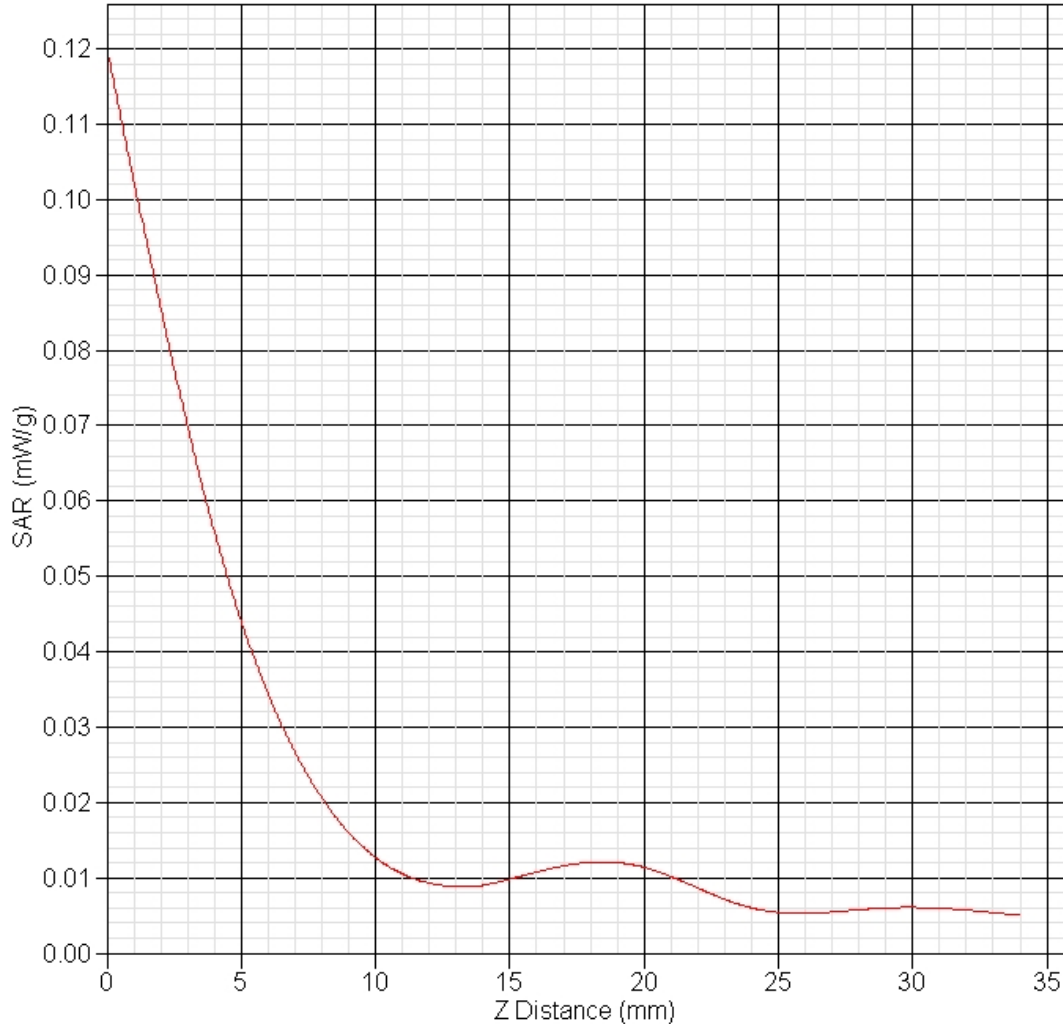

SAR Test Report

WiMAX QPSK 10MHz

Report Date : 01-Apr-2010
 By Operator : 123
 Measurement Date : 01-Apr-2010
 Starting Time : 01-Apr-2010 11:50:10 AM
 End Time : 01-Apr-2010 12:11:59 PM
 Scanning Time : 1309 secs

Product Data
 Device Name : Mott-Auden-WiMAX
 Serial No. : 5N793
 Type : Other
 Model : Auden - 6250
 Frequency : 2600.00 MHz
 Max. Transmit Pwr : 1 W
 Drift Time : 0 min(s)
 Length : 115 mm
 Width : 85 mm
 Depth : 10 mm
 Antenna Type : Internal
 Orientation : Touch
 Power Drift-Start : 0.009 W/kg
 Power Drift-Finish : 0.010 W/kg
 Power Drift (%) : 3.134
 Picture : C:\alsas\bitmap\Mott-WiMAX-1.bmp

Phantom Data
 Name : APREL-Uni
 Type : Uni-Phantom
 Size (mm) : 280 x 280 x 200
 Serial No. : User Define
 Location : Center
 Description : U

Tissue Data
 Type : BODY
 Serial No. : 2600-B
 Frequency : 2600.00 MHz
 Last Calib. Date : 31-Mar-2010
 Temperature : 20.00 °C
 Ambient Temp. : 20.00 °C
 Humidity : 50.00 RH%
 Epsilon : 49.5 F/m
 Sigma : 2.19 S/m
 Density : 1000.00 kg/cu. m

Probe Data

Name : .E30
 Model : E30
 Type : E-Field Triangle
 Serial No. : 222
 Last Calib. Date : 05-Feb-2010
 Frequency : 2600.00 MHz
 Duty Cycle Factor: 2.3
 Conversion Factor: 3.95
 Probe Sensitivity: 1.20 1.20 1.20 $\mu\text{V}/(\text{V}/\text{m})^2$
 Compression Point: 95.00 mV
 Offset : 0.56 mm

Measurement Data

Crest Factor : 2.3
 Scan Type : Complete
 Tissue Temp. : 21.00 °C
 Ambient Temp. : 22.00 °C
 Set-up Date : 01-Apr-2010
 Set-up Time : 11:49:43 AM
 Area Scan : 7x5x1 : Measurement x=10mm, y=10mm, z=4mm
 Zoom Scan : 7x7x7 : Measurement x=5mm, y=5mm, z=5mm

Other Data

DUT Position : Touch
 Separation : 157
 Channel : Low

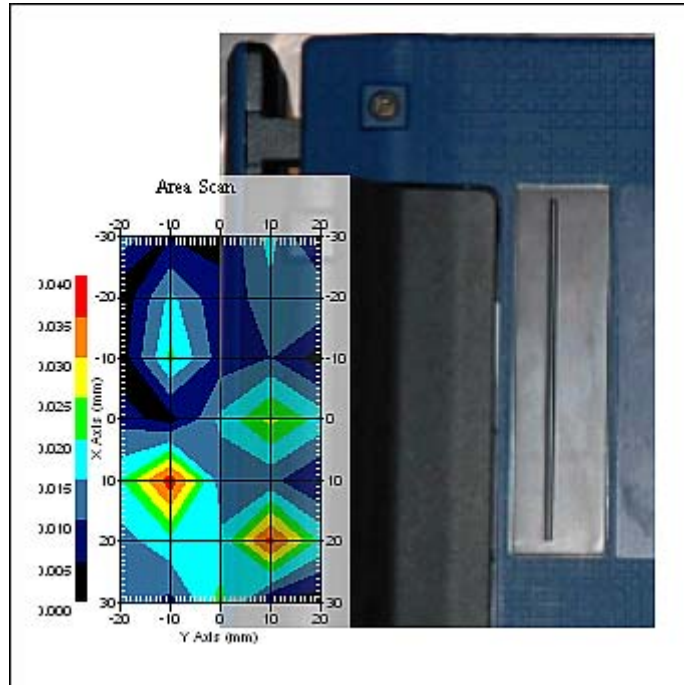

1 gram SAR value : 0.032 W/kg
 Zoom Scan Peak SAR : 0.120 W/kg



Exposure Assessment Measurement Uncertainty

Source of Uncertainty	Tolerance Value	Probability Distribution	Divisor	c_i^{-1} (1-g)	c_i^{-1} (10-g)	Standard Uncertainty (1-g) %	Standard Uncertainty (10-g) %
Measurement System							
Probe Calibration	3.5	normal	1	1	1	3.5	3.5
Axial Isotropy	3.7	rectangular	•3	$(1-cp)^{1/2}$	$(1-cp)^{1/2}$	1.5	1.5
Hemispherical Isotropy	10.9	rectangular	•3	•cp	•cp	4.4	4.4
Boundary Effect	1.0	rectangular	•3	1	1	0.6	0.6
Linearity	4.7	rectangular	•3	1	1	2.7	2.7
Detection Limit	1.0	rectangular	•3	1	1	0.6	0.6
Readout Electronics	1.0	normal	1	1	1	1.0	1.0
Response Time	0.8	rectangular	•3	1	1	0.5	0.5
Integration Time	1.7	rectangular	•3	1	1	1.0	1.0
RF Ambient Condition	3.0	rectangular	•3	1	1	1.7	1.7
Probe Positioner Mech.	0.4	rectangular	•3	1	1	0.2	0.2
Restriction							
Probe Positioning with respect to Phantom Shell	2.9	rectangular	•3	1	1	1.7	1.7
Extrapolation and Integration	3.7	rectangular	•3	1	1	2.1	2.1
Test Sample Positioning	4.0	normal	1	1	1	4.0	4.0
Device Holder Uncertainty	2.0	normal	1	1	1	2.0	2.0
Drift of Output Power	3.1	rectangular	•3	1	1	1.7	1.7
Phantom and Setup							
Phantom Uncertainty (shape & thickness tolerance)	3.4	rectangular	•3	1	1	2	2
Liquid Conductivity (target)	5.0	rectangular	•3	0.7	0.5	2	1.4
Liquid Conductivity (meas.)	1.4	normal	1	0.7	0.5	3.3	2.3
Liquid Permittivity (target)	5.0	rectangular	•3	0.6	0.5	1.7	1.4
Liquid Permittivity (meas.)	1.4	normal	1	0.6	0.5	2.5	2.1
Combined Uncertainty		RSS				13.2	10.9
Combined Uncertainty (coverage factor=2)		Normal (k=2)				26.4	21.8



SAR-Z Axis at Hotspot x:15.16 y:-0.12

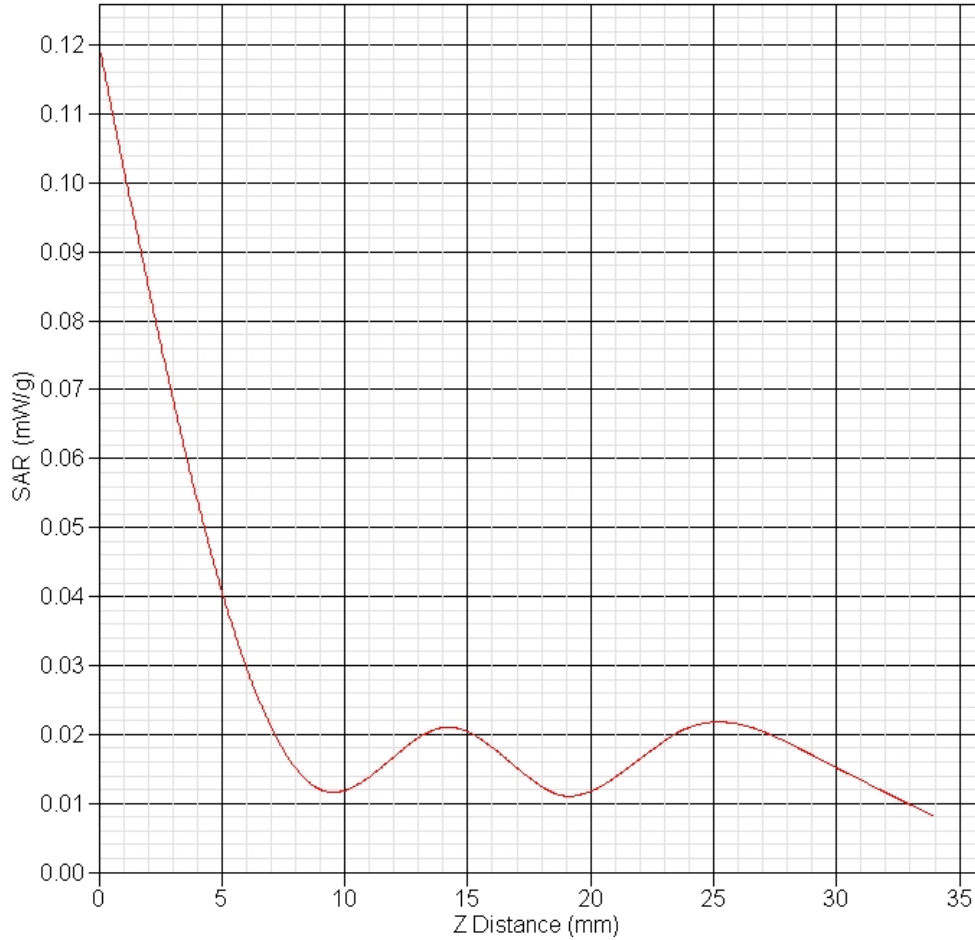

SAR Test Report

WiMAX 16QAM 5MHz

Report Date : 01-Apr-2010
 By Operator : 123
 Measurement Date : 01-Apr-2010
 Starting Time : 01-Apr-2010 01:33:19 PM
 End Time : 01-Apr-2010 01:55:11 PM
 Scanning Time : 1312 secs

Product Data
 Device Name : Mott-Auden-WiMAX
 Serial No. : 5N793
 Type : Other
 Model : Auden - 6250
 Frequency : 2600.00 MHz
 Max. Transmit Pwr : 1 W
 Drift Time : 0 min(s)
 Length : 115 mm
 Width : 85 mm
 Depth : 10 mm
 Antenna Type : Internal
 Orientation : Touch
 Power Drift-Start : 0.012 W/kg
 Power Drift-Finish: 0.029 W/kg
 Power Drift (%) : 144.696
 Picture : C:\alsas\bitmap\Mott-WiMAX-1.bmp

Phantom Data
 Name : APREL-Uni
 Type : Uni-Phantom
 Size (mm) : 280 x 280 x 200
 Serial No. : User Define
 Location : Center
 Description : U

Tissue Data
 Type : BODY
 Serial No. : 2600-B
 Frequency : 2600.00 MHz
 Last Calib. Date : 31-Mar-2010
 Temperature : 20.00 °C
 Ambient Temp. : 20.00 °C
 Humidity : 50.00 RH%
 Epsilon : 49.5 F/m
 Sigma : 2.19 S/m
 Density : 1000.00 kg/cu. m

Probe Data

Name : .E30
 Model : E30
 Type : E-Field Triangle
 Serial No. : 222
 Last Calib. Date : 05-Feb-2010
 Frequency : 2600.00 MHz
 Duty Cycle Factor: 2.7
 Conversion Factor: 3.95
 Probe Sensitivity: 1.20 1.20 1.20 $\mu\text{V}/(\text{V}/\text{m})^2$
 Compression Point: 95.00 mV
 Offset : 0.56 mm

Measurement Data

Crest Factor : 2.7
 Scan Type : Complete
 Tissue Temp. : 21.00 °C
 Ambient Temp. : 22.00 °C
 Set-up Date : 01-Apr-2010
 Set-up Time : 1:32:32 PM
 Area Scan : 7x5x1 : Measurement x=10mm, y=10mm, z=4mm
 Zoom Scan : 7x7x7 : Measurement x=5mm, y=5mm, z=5mm

Other Data

DUT Position : Touch
 Separation : 157
 Channel : Mid



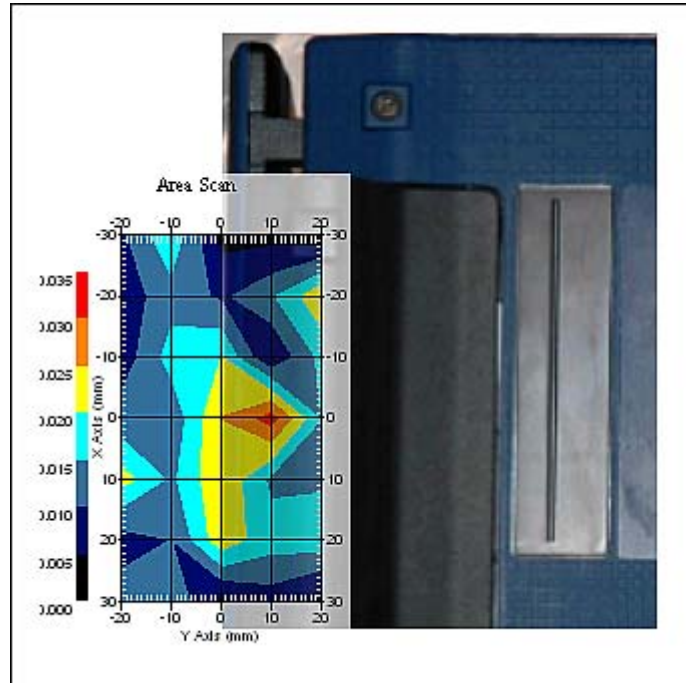

1 gram SAR value : 0.032 W/kg
 Zoom Scan Peak SAR : 0.150 W/kg



Exposure Assessment Measurement Uncertainty

Source of Uncertainty	Tolerance Value	Probability Distribution	Divisor	c_i^{-1} (1-g)	c_i^{-1} (10-g)	Standard Uncertainty (1-g) %	Standard Uncertainty (10-g) %
Measurement System							
Probe Calibration	3.5	normal	1	1	1	3.5	3.5
Axial Isotropy	3.7	rectangular	•3	$(1-cp)^{1/2}$	$(1-cp)^{1/2}$	1.5	1.5
Hemispherical Isotropy	10.9	rectangular	•3	•cp	•cp	4.4	4.4
Boundary Effect	1.0	rectangular	•3	1	1	0.6	0.6
Linearity	4.7	rectangular	•3	1	1	2.7	2.7
Detection Limit	1.0	rectangular	•3	1	1	0.6	0.6
Readout Electronics	1.0	normal	1	1	1	1.0	1.0
Response Time	0.8	rectangular	•3	1	1	0.5	0.5
Integration Time	1.7	rectangular	•3	1	1	1.0	1.0
RF Ambient Condition	3.0	rectangular	•3	1	1	1.7	1.7
Probe Positioner Mech.	0.4	rectangular	•3	1	1	0.2	0.2
Restriction							
Probe Positioning with respect to Phantom Shell	2.9	rectangular	•3	1	1	1.7	1.7
Extrapolation and Integration	3.7	rectangular	•3	1	1	2.1	2.1
Test Sample Positioning	4.0	normal	1	1	1	4.0	4.0
Device Holder Uncertainty	2.0	normal	1	1	1	2.0	2.0
Drift of Output Power	3.8	rectangular	•3	1	1	1.9	1.9
Phantom and Setup							
Phantom Uncertainty (shape & thickness tolerance)	3.4	rectangular	•3	1	1	2	2
Liquid Conductivity (target)	5.0	rectangular	•3	0.7	0.5	2	1.4
Liquid Conductivity (meas.)	1.4	normal	1	0.7	0.5	3.3	2.3
Liquid Permittivity (target)	5.0	rectangular	•3	0.6	0.5	1.7	1.4
Liquid Permittivity (meas.)	1.4	normal	1	0.6	0.5	2.5	2.1
Combined Uncertainty		RSS				13.4	11.1
Combined Uncertainty (coverage factor=2)		Normal (k=2)				26.8	22.2



SAR-Z Axis at Hotspot x:0.15 y:9.90

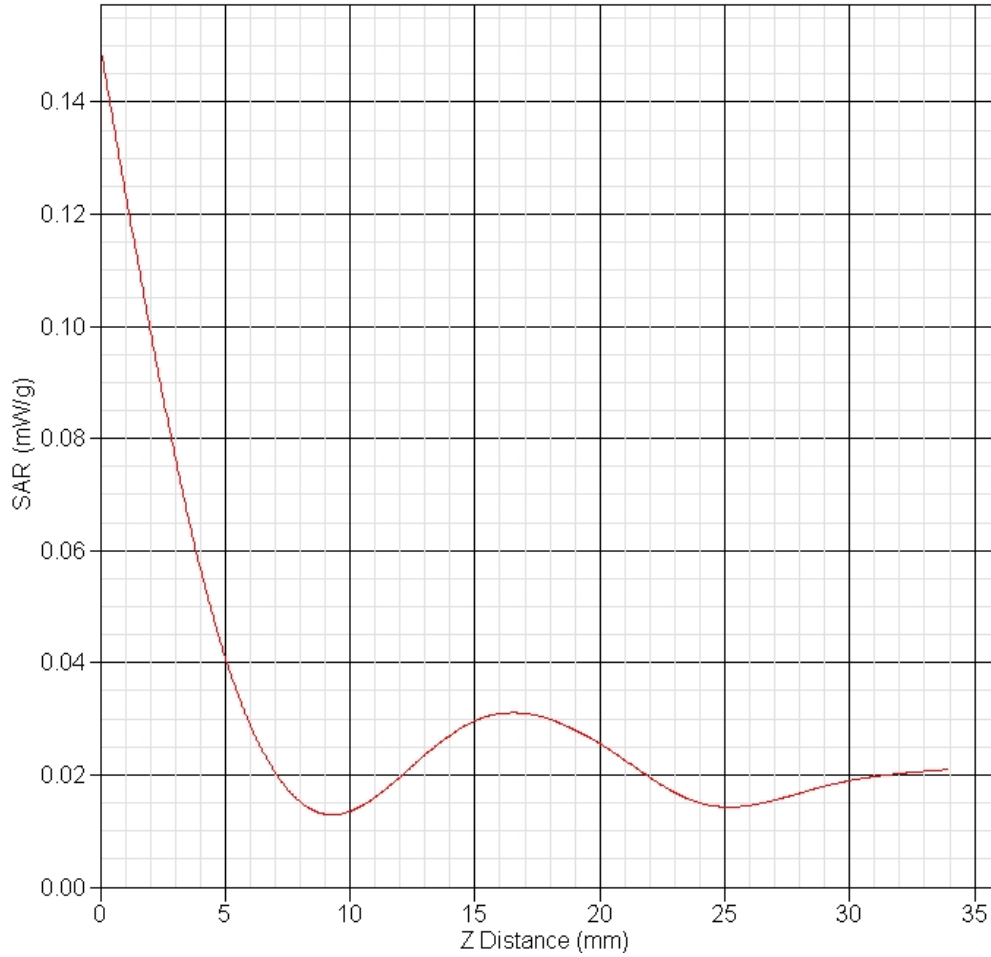

SAR Test Report

WiMAX QPSK 5MHz

Report Date : 01-Apr-2010
 By Operator : 123
 Measurement Date : 01-Apr-2010
 Starting Time : 01-Apr-2010 04:14:47 PM
 End Time : 01-Apr-2010 04:36:38 PM
 Scanning Time : 1311 secs

Product Data
 Device Name : Mott-Auden-WiMAX
 Serial No. : 5N793
 Type : Other
 Model : Auden - 6250
 Frequency : 2600.00 MHz
 Max. Transmit Pwr : 1 W
 Drift Time : 0 min(s)
 Length : 115 mm
 Width : 85 mm
 Depth : 10 mm
 Antenna Type : Internal
 Orientation : Touch
 Power Drift-Start : 0.012 W/kg
 Power Drift-Finish: 0.011 W/kg
 Power Drift (%) : -3.816
 Picture : C:\alsas\bitmap\Mott-WiMAX-1.bmp

Phantom Data
 Name : APREL-Uni
 Type : Uni-Phantom
 Size (mm) : 280 x 280 x 200
 Serial No. : User Define
 Location : Center
 Description : U

Tissue Data
 Type : BODY
 Serial No. : 2600-B
 Frequency : 2600.00 MHz
 Last Calib. Date : 31-Mar-2010
 Temperature : 20.00 °C
 Ambient Temp. : 20.00 °C
 Humidity : 50.00 RH%
 Epsilon : 49.5 F/m
 Sigma : 2.19 S/m
 Density : 1000.00 kg/cu. m

Probe Data

Name : .E30
 Model : E30
 Type : E-Field Triangle
 Serial No. : 222
 Last Calib. Date : 05-Feb-2010
 Frequency : 2600.00 MHz
 Duty Cycle Factor: 2.7
 Conversion Factor: 3.95
 Probe Sensitivity: 1.20 1.20 1.20 $\mu\text{V}/(\text{V}/\text{m})^2$
 Compression Point: 95.00 mV
 Offset : 0.56 mm

Measurement Data

Crest Factor : 2.7
 Scan Type : Complete
 Tissue Temp. : 21.00 °C
 Ambient Temp. : 22.00 °C
 Set-up Date : 01-Apr-2010
 Set-up Time : 4:14:28 PM
 Area Scan : 7x5x1 : Measurement x=10mm, y=10mm, z=4mm
 Zoom Scan : 7x7x7 : Measurement x=5mm, y=5mm, z=5mm

Other Data

DUT Position : Touch
 Separation : 157
 Channel : Mid



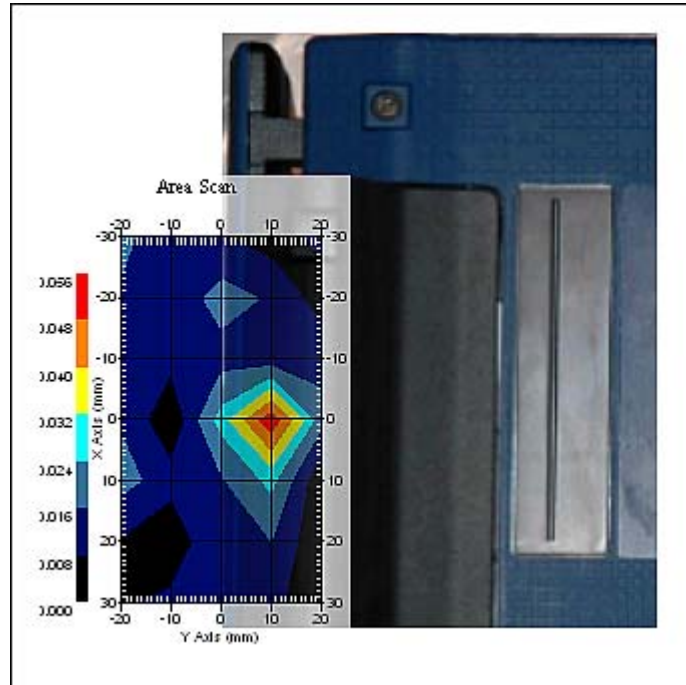

1 gram SAR value : 0.030 W/kg
 Zoom Scan Peak SAR : 0.130 W/kg





SAR & HAC Instruments for Wireless • Consulting • Research • Standards • Compliance • Training

Exposure Assessment Measurement Uncertainty

Source of Uncertainty	Tolerance Value	Probability Distribution	Divisor	c_i^{-1} (1-g)	c_i^{-1} (10-g)	Standard Uncertainty (1-g) %	Standard Uncertainty (10-g) %
Measurement System							
Probe Calibration	3.5	normal	1	1	1	3.5	3.5
Axial Isotropy	3.7	rectangular	•3	$(1-cp)^{1/2}$	$(1-cp)^{1/2}$	1.5	1.5
Hemispherical Isotropy	10.9	rectangular	•3	•cp	•cp	4.4	4.4
Boundary Effect	1.0	rectangular	•3	1	1	0.6	0.6
Linearity	4.7	rectangular	•3	1	1	2.7	2.7
Detection Limit	1.0	rectangular	•3	1	1	0.6	0.6
Readout Electronics	1.0	normal	1	1	1	1.0	1.0
Response Time	0.8	rectangular	•3	1	1	0.5	0.5
Integration Time	1.7	rectangular	•3	1	1	1.0	1.0
RF Ambient Condition	3.0	rectangular	•3	1	1	1.7	1.7
Probe Positioner Mech.	0.4	rectangular	•3	1	1	0.2	0.2
Restriction							
Probe Positioning with respect to Phantom Shell	2.9	rectangular	•3	1	1	1.7	1.7
Extrapolation and Integration	3.7	rectangular	•3	1	1	2.1	2.1
Test Sample Positioning	4.0	normal	1	1	1	4.0	4.0
Device Holder Uncertainty	2.0	normal	1	1	1	2.0	2.0
Drift of Output Power	3.8	rectangular	•3	1	1	2.2	2.2
Phantom and Setup							
Phantom Uncertainty (shape & thickness tolerance)	3.4	rectangular	•3	1	1	2	2
Liquid Conductivity (target)	5.0	rectangular	•3	0.7	0.5	2	1.4
Liquid Conductivity (meas.)	1.4	normal	1	0.7	0.5	3.3	2.3
Liquid Permittivity (target)	5.0	rectangular	•3	0.6	0.5	1.7	1.4
Liquid Permittivity (meas.)	1.4	normal	1	0.6	0.5	2.5	2.1
Combined Uncertainty		RSS				13.7	11.4
Combined Uncertainty (coverage factor=2)		Normal (k=2)				27.4	22.8



SAR-Z Axis at Hotspot x:0.18 y:14.91

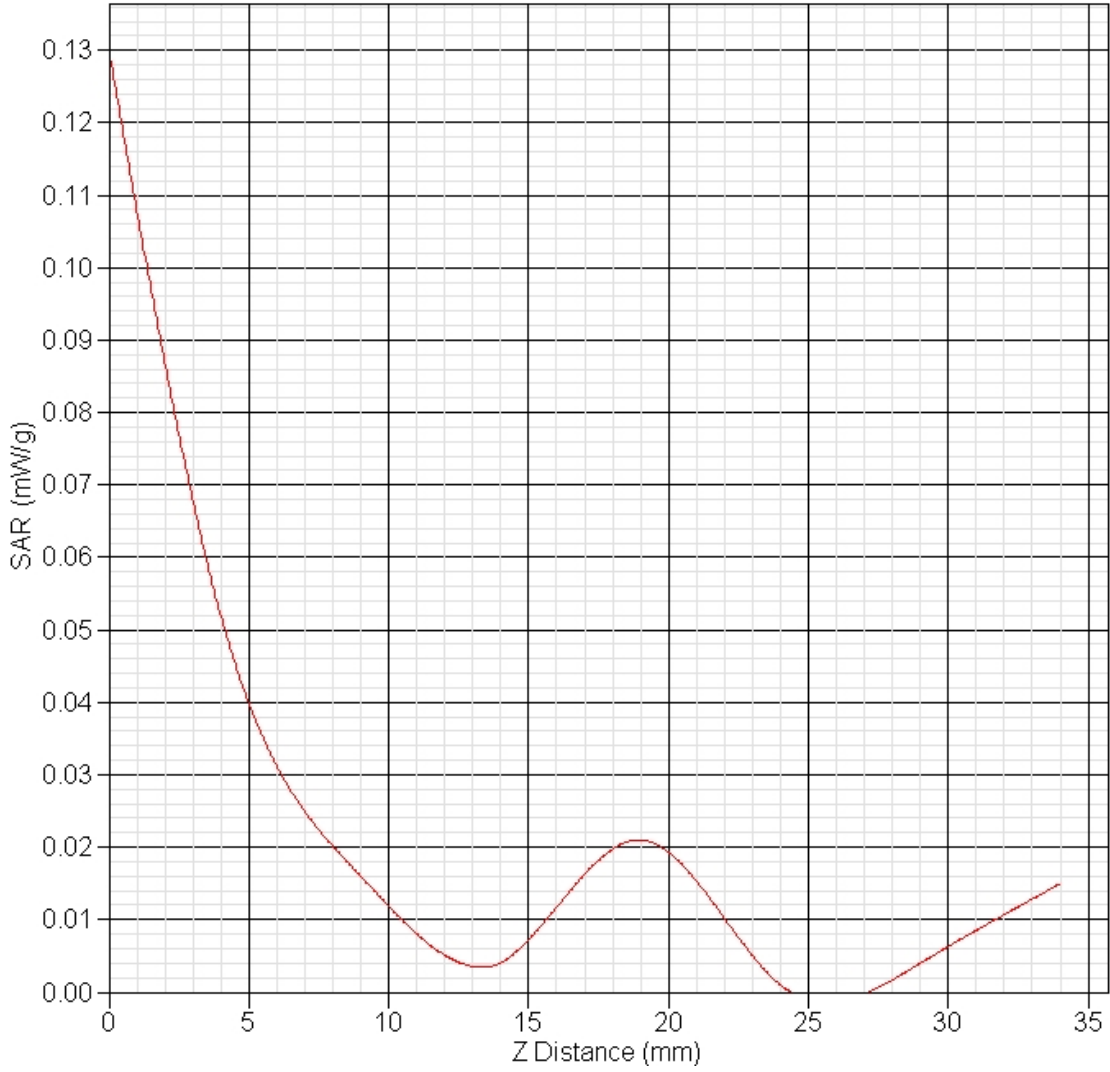

SAR Test Report

Report Date : 25-Mar-2010
 By Operator : 123
 Measurement Date : 25-Mar-2010
 Starting Time : 25-Mar-2010 12:35:29 PM
 End Time : 25-Mar-2010 01:52:10 PM
 Scanning Time : xxxx secs

Product Data
 Device Name : Mott-Auden-WiMAX
 Serial No. : 5N793
 Type : Other
 Model : Auden - 6250
 Frequency : 5200.00 MHz
 Max. Transmit Pwr : 1 W
 Drift Time : 0 min(s)
 Length : 115 mm
 Width : 85 mm
 Depth : 10 mm
 Antenna Type : Internal
 Orientation : Touch
 Power Drift-Start : 0.042 W/kg
 Power Drift-Finish: 0.044 W/kg
 Power Drift (%) : 4.785
 Picture : C:\alsas\bitmap\Mott-WiMAX-1.bmp

Phantom Data
 Name : APREL-Uni
 Type : Uni-Phantom
 Size (mm) : 280 x 280 x 200
 Serial No. : User Define
 Location : Center
 Description : U

Tissue Data
 Type : BODY
 Serial No. : 5200-B
 Frequency : 5200.00 MHz
 Last Calib. Date : 24-Mar-2010
 Temperature : 20.00 °C
 Ambient Temp. : 20.00 °C
 Humidity : 40.00 RH%
 Epsilon : 49.6 F/m
 Sigma : 5.44 S/m
 Density : 1000.00 kg/cu. m

Probe Data

Name : .E30
 Model : E30
 Type : E-Field Triangle
 Serial No. : 222
 Last Calib. Date : 07-Feb-2010
 Frequency : 5200.00 MHz
 Duty Cycle Factor: 1
 Conversion Factor: 3.1
 Probe Sensitivity: 1.20 1.20 1.20 $\mu\text{V}/(\text{V}/\text{m})^2$
 Compression Point: 95.00 mV
 Offset : 0.56 mm

Measurement Data

Crest Factor : 1
 Scan Type : Complete
 Tissue Temp. : 21.00 °C
 Ambient Temp. : 22.00 °C
 Set-up Date : 25-Mar-2010
 Set-up Time : 12:13:54 PM
 Area Scan : 7x5x1 : Measurement x=10mm, y=10mm, z=2mm
 Zoom Scan : 9x9x17 : Measurement x=9mm, y=9mm, z=2mm

Other Data

DUT Position : Touch
 Separation : 142
 Channel : High

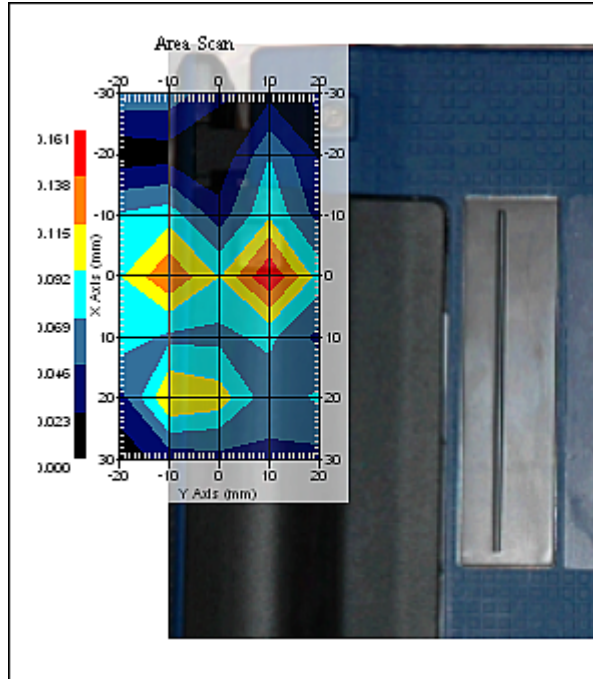

1 gram SAR value : 0.103 W/kg
 Zoom Scan Peak SAR : 0.520 W/kg



Exposure Assessment Measurement Uncertainty

Source of Uncertainty	Tolerance Value	Probability Distribution	Divisor	c_i^{-1} (1-g)	c_i^{-1} (10-g)	Standard Uncertainty (1-g) %	Standard Uncertainty (10-g) %
Measurement System							
Probe Calibration	3.5	normal	1	1	1	3.5	3.5
Axial Isotropy	3.7	rectangular	•3	$(1-cp)^{1/2}$	$(1-cp)^{1/2}$	1.5	1.5
Hemispherical Isotropy	10.9	rectangular	•3	•cp	•cp	4.4	4.4
Boundary Effect	1.0	rectangular	•3	1	1	0.6	0.6
Linearity	4.7	rectangular	•3	1	1	2.7	2.7
Detection Limit	1.0	rectangular	•3	1	1	0.6	0.6
Readout Electronics	1.0	normal	1	1	1	1.0	1.0
Response Time	0.8	rectangular	•3	1	1	0.5	0.5
Integration Time	1.7	rectangular	•3	1	1	1.0	1.0
RF Ambient Condition	3.0	rectangular	•3	1	1	1.7	1.7
Probe Positioner Mech.	0.4	rectangular	•3	1	1	0.2	0.2
Restriction							
Probe Positioning with respect to Phantom Shell	2.9	rectangular	•3	1	1	1.7	1.7
Extrapolation and Integration	3.7	rectangular	•3	1	1	2.1	2.1
Test Sample Positioning	4.0	normal	1	1	1	4.0	4.0
Device Holder Uncertainty	2.0	normal	1	1	1	2.0	2.0
Drift of Output Power	4.8	rectangular	•3	1	1	2.2	2.2
Phantom and Setup							
Phantom Uncertainty (shape & thickness tolerance)	3.4	rectangular	•3	1	1	2	2
Liquid Conductivity (target)	5.0	rectangular	•3	0.7	0.5	2	1.4
Liquid Conductivity (meas.)	1.5	normal	1	0.7	0.5	1	0.7
Liquid Permittivity (target)	5.0	rectangular	•3	0.6	0.5	1.7	1.4
Liquid Permittivity (meas.)	0.7	normal	1	0.6	0.5	0.4	0.4
Combined Uncertainty		RSS				9.3	8.1
Combined Uncertainty (coverage factor=2)		Normal (k=2)				18.6	16.2



SAR-Z Axis at Hotspot x:10.12 y:14.91

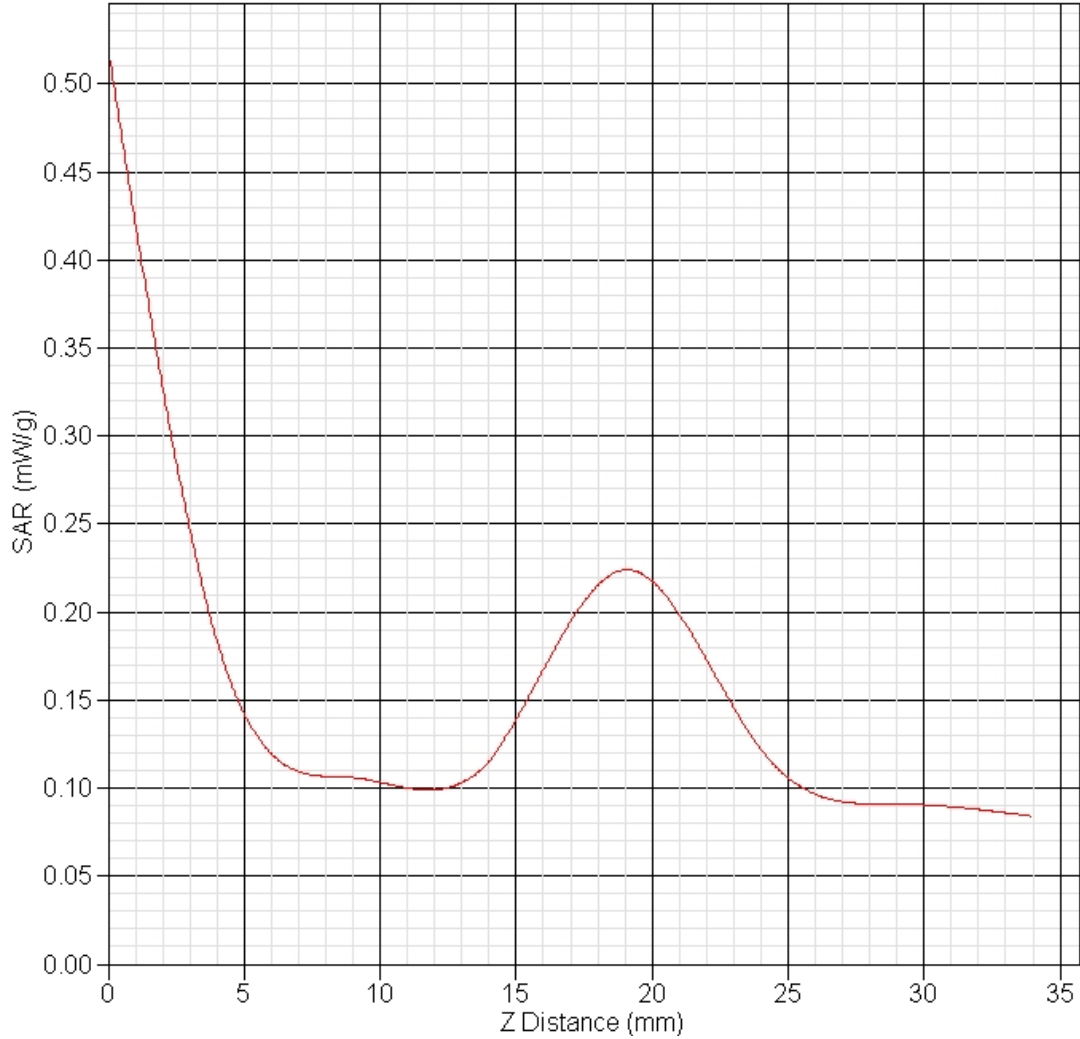

SAR Test Report

Report Date : 26-Mar-2010
 By Operator : 123
 Measurement Date : 26-Mar-2010
 Starting Time : 26-Mar-2010 09:18:16 AM
 End Time : 26-Mar-2010 10:36:00 AM
 Scanning Time : xxxx secs

Product Data
 Device Name : Mott-Auden-WiMAX
 Serial No. : 5N793
 Type : Other
 Model : Auden - 6250
 Frequency : 5600.00 MHz
 Max. Transmit Pwr : 1 W
 Drift Time : 0 min(s)
 Length : 115 mm
 Width : 85 mm
 Depth : 10 mm
 Antenna Type : Internal
 Orientation : Touch
 Power Drift-Start : 0.055 W/kg
 Power Drift-Finish : 0.052 W/kg
 Power Drift (%) : -4.698
 Picture : C:\alsas\bitmap\Mott-WiMAX-1.bmp

Phantom Data
 Name : APREL-Uni
 Type : Uni-Phantom
 Size (mm) : 280 x 280 x 200
 Serial No. : User Define
 Location : Center
 Description : U

Tissue Data
 Type : BODY
 Serial No. : 5600BB
 Frequency : 5600.00 MHz
 Last Calib. Date : 24-Mar-2010
 Temperature : 20.00 °C
 Ambient Temp. : 20.00 °C
 Humidity : 22.00 RH%
 Epsilon : 48.3 F/m
 Sigma : 5.62 S/m
 Density : 1000.00 kg/cu. m

Probe Data

Name : .E30
 Model : E30
 Type : E-Field Triangle
 Serial No. : 222
 Last Calib. Date : 08-Feb-2010
 Frequency : 5600.00 MHz
 Duty Cycle Factor: 1
 Conversion Factor: 3.2
 Probe Sensitivity: 1.20 1.20 1.20 $\mu\text{V}/(\text{V}/\text{m})^2$
 Compression Point: 95.00 mV
 Offset : 0.56 mm

Measurement Data

Crest Factor : 1
 Scan Type : Complete
 Tissue Temp. : 21.00 °C
 Ambient Temp. : 22.00 °C
 Set-up Date : 26-Mar-2010
 Set-up Time : 9:17:24 AM
 Area Scan : 7x6x1 : Measurement x=10mm, y=10mm, z=2mm
 Zoom Scan : 9x9x17 : Measurement x=4mm, y=4mm, z=2mm

Other Data

DUT Position : Touch
 Separation : 142
 Channel : High



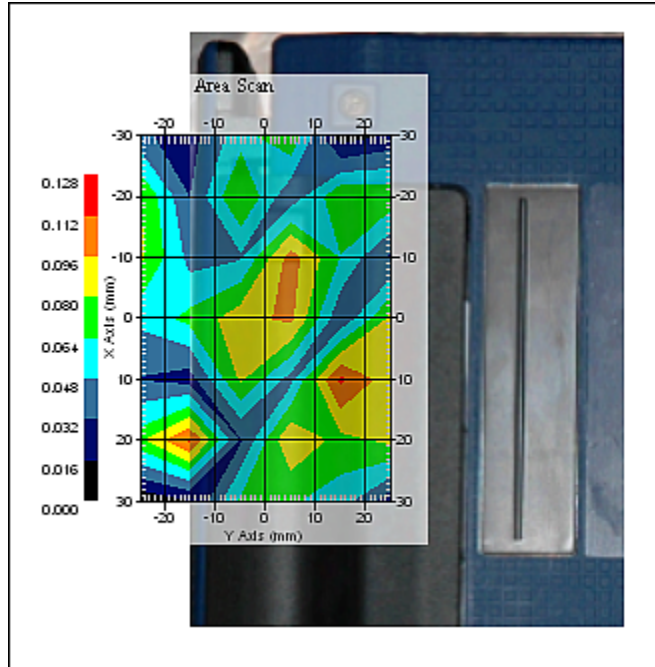

1 gram SAR value : 0.134 W/kg
 Zoom Scan Peak SAR : 0.560 W/kg





SAR & HAC Instruments for Wireless • Consulting • Research • Standards • Compliance • Training

Exposure Assessment Measurement Uncertainty

Source of Uncertainty	Tolerance Value	Probability Distribution	Divisor	c_i^{-1} (1-g)	c_i^{-1} (10-g)	Standard Uncertainty (1-g) %	Standard Uncertainty (10-g) %
Measurement System							
Probe Calibration	3.5	normal	1	1	1	3.5	3.5
Axial Isotropy	3.7	rectangular	•3	$(1-cp)^{1/2}$	$(1-cp)^{1/2}$	1.5	1.5
Hemispherical Isotropy	10.9	rectangular	•3	•cp	•cp	4.4	4.4
Boundary Effect	1.0	rectangular	•3	1	1	0.6	0.6
Linearity	4.7	rectangular	•3	1	1	2.7	2.7
Detection Limit	1.0	rectangular	•3	1	1	0.6	0.6
Readout Electronics	1.0	normal	1	1	1	1.0	1.0
Response Time	0.8	rectangular	•3	1	1	0.5	0.5
Integration Time	1.7	rectangular	•3	1	1	1.0	1.0
RF Ambient Condition	3.0	rectangular	•3	1	1	1.7	1.7
Probe Positioner Mech.	0.4	rectangular	•3	1	1	0.2	0.2
Restriction							
Probe Positioning with respect to Phantom Shell	2.9	rectangular	•3	1	1	1.7	1.7
Extrapolation and Integration	3.7	rectangular	•3	1	1	2.1	2.1
Test Sample Positioning	4.0	normal	1	1	1	4.0	4.0
Device Holder Uncertainty	2.0	normal	1	1	1	2.0	2.0
Drift of Output Power	4.7	rectangular	•3	1	1	2.1	2.1
Phantom and Setup							
Phantom Uncertainty (shape & thickness tolerance)	3.4	rectangular	•3	1	1	2	2
Liquid Conductivity (target)	5.0	rectangular	•3	0.7	0.5	2	1.4
Liquid Conductivity (meas.)	1.4	normal	1	0.7	0.5	3.3	2.3
Liquid Permittivity (target)	5.0	rectangular	•3	0.6	0.5	1.7	1.4
Liquid Permittivity (meas.)	1.4	normal	1	0.6	0.5	2.5	2.1
Combined Uncertainty		RSS				13.6	11.3
Combined Uncertainty (coverage factor=2)		Normal (k=2)				27.2	22.6



SAR-Z Axis at Hotspot x:10.16 y:9.93

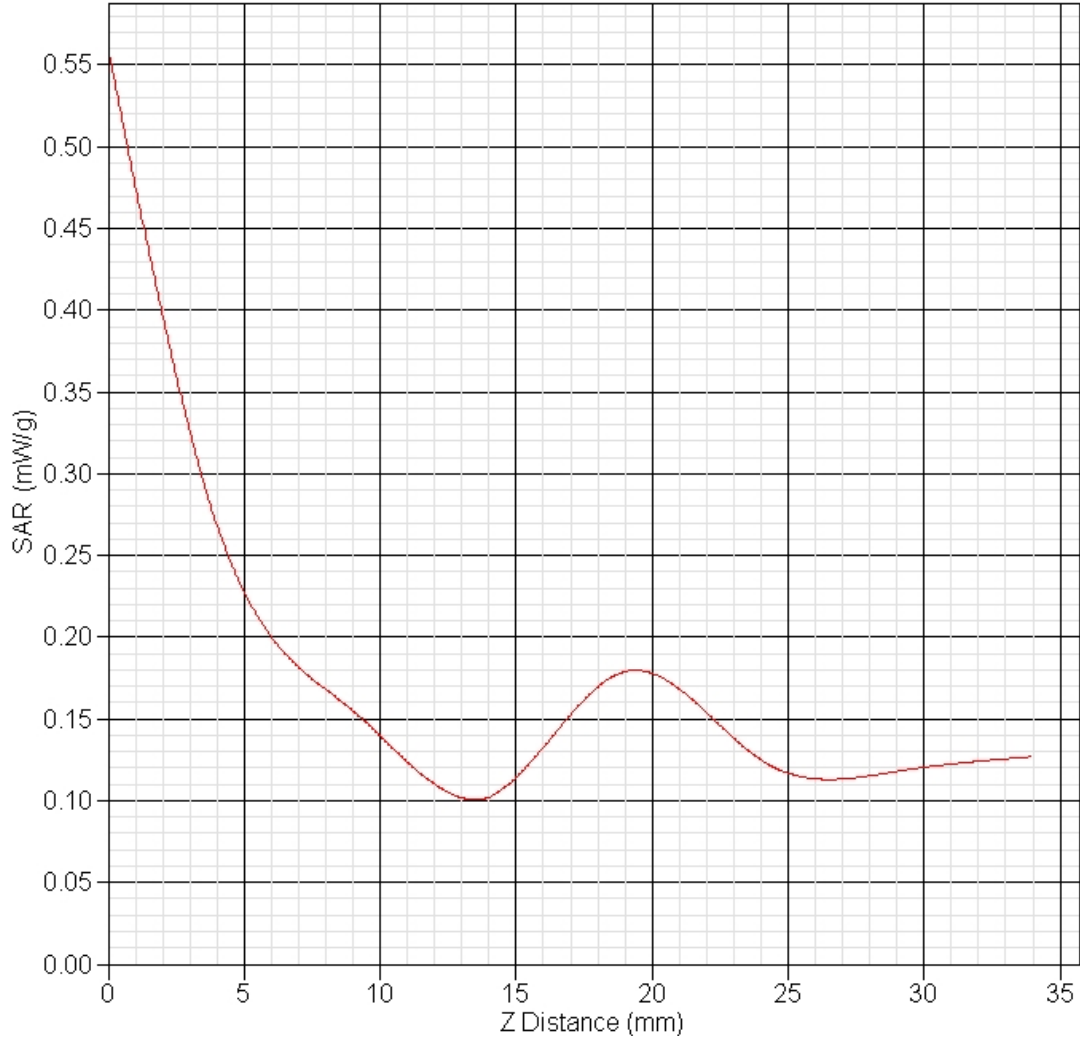

SAR Test Report

Report Date : 26-Mar-2010
 By Operator : 123
 Measurement Date : 26-Mar-2010
 Starting Time : 26-Mar-2010 12:38:50 PM
 End Time : 26-Mar-2010 01:55:32 PM
 Scanning Time : xxxx secs

Product Data
 Device Name : Mott-Auden-WiMAX
 Serial No. : 5N793
 Type : Other
 Model : Auden - 6250
 Frequency : 5800.00 MHz
 Max. Transmit Pwr : 1 W
 Drift Time : 0 min(s)
 Length : 115 mm
 Width : 85 mm
 Depth : 10 mm
 Antenna Type : Internal
 Orientation : Touch
 Power Drift-Start : 0.053 W/kg
 Power Drift-Finish : 0.055 W/kg
 Power Drift (%) : 4.195
 Picture : C:\alsas\bitmap\Mott-WiMAX-1.bmp

Phantom Data
 Name : APREL-Uni
 Type : Uni-Phantom
 Size (mm) : 280 x 280 x 200
 Serial No. : User Define
 Location : Center
 Description : U

Tissue Data
 Type : BODY
 Serial No. : 5800-B
 Frequency : 5800.00 MHz
 Last Calib. Date : 24-Mar-2010
 Temperature : 20.00 °C
 Ambient Temp. : 20.00 °C
 Humidity : 50.00 RH%
 Epsilon : 48.9 F/m
 Sigma : 6.15 S/m
 Density : 1000.00 kg/cu. m

Probe Data

Name : .E30
 Model : E30
 Type : E-Field Triangle
 Serial No. : 222
 Last Calib. Date : 09-Feb-2010
 Frequency : 5800.00 MHz
 Duty Cycle Factor: 1
 Conversion Factor: 3.2
 Probe Sensitivity: 1.20 1.20 1.20 $\mu\text{V}/(\text{V}/\text{m})^2$
 Compression Point: 95.00 mV
 Offset : 0.56 mm

Measurement Data

Crest Factor : 1
 Scan Type : Complete
 Tissue Temp. : 21.00 °C
 Ambient Temp. : 22.00 °C
 Set-up Date : 26-Mar-2010
 Set-up Time : 12:12:38 PM
 Area Scan : 7x5x1 : Measurement x=10mm, y=10mm, z=2mm
 Zoom Scan : 9x9x17 : Measurement x=4mm, y=4mm, z=2mm

Other Data

DUT Position : Touch
 Separation : 142
 Channel : Mid



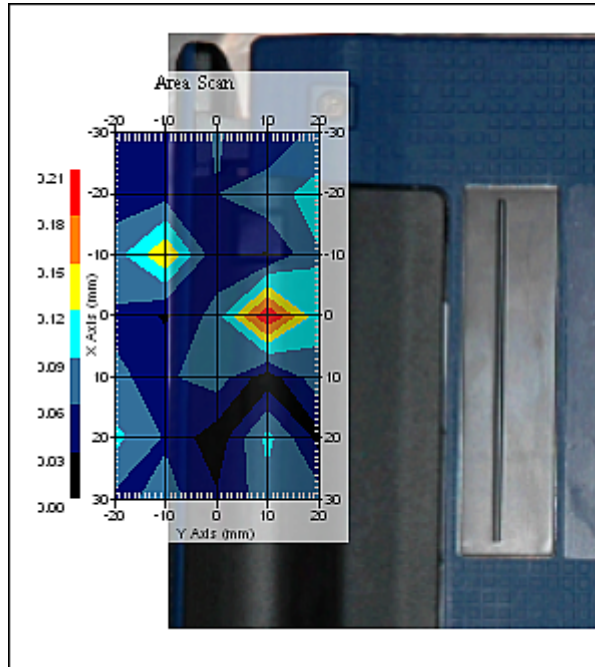

1 gram SAR value : 0.124 W/kg
 Zoom Scan Peak SAR : 0.330 W/kg





SAR & HAC Instruments for Wireless • Consulting • Research • Standards • Compliance • Training

Exposure Assessment Measurement Uncertainty

Source of Uncertainty	Tolerance Value	Probability Distribution	Divisor	c_i^{-1} (1-g)	c_i^{-1} (10-g)	Standard Uncertainty (1-g) %	Standard Uncertainty (10-g) %
Measurement System							
Probe Calibration	3.5	normal	1	1	1	3.5	3.5
Axial Isotropy	3.7	rectangular	•3	$(1-cp)^{1/2}$	$(1-cp)^{1/2}$	1.5	1.5
Hemispherical Isotropy	10.9	rectangular	•3	•cp	•cp	4.4	4.4
Boundary Effect	1.0	rectangular	•3	1	1	0.6	0.6
Linearity	4.7	rectangular	•3	1	1	2.7	2.7
Detection Limit	1.0	rectangular	•3	1	1	0.6	0.6
Readout Electronics	1.0	normal	1	1	1	1.0	1.0
Response Time	0.8	rectangular	•3	1	1	0.5	0.5
Integration Time	1.7	rectangular	•3	1	1	1.0	1.0
RF Ambient Condition	3.0	rectangular	•3	1	1	1.7	1.7
Probe Positioner Mech.	0.4	rectangular	•3	1	1	0.2	0.2
Restriction							
Probe Positioning with respect to Phantom Shell	2.9	rectangular	•3	1	1	1.7	1.7
Extrapolation and Integration	3.7	rectangular	•3	1	1	2.1	2.1
Test Sample Positioning	4.0	normal	1	1	1	4.0	4.0
Device Holder Uncertainty	2.0	normal	1	1	1	2.0	2.0
Drift of Output Power	4.2	rectangular	•3	1	1	2	2
Phantom and Setup							
Phantom Uncertainty (shape & thickness tolerance)	3.4	rectangular	•3	1	1	2	2
Liquid Conductivity (target)	5.0	rectangular	•3	0.7	0.5	2	1.4
Liquid Conductivity (meas.)	2.8	normal	1	0.7	0.5	2	1.4
Liquid Permittivity (target)	5.0	rectangular	•3	0.6	0.5	1.7	1.4
Liquid Permittivity (meas.)	2.2	normal	1	0.6	0.5	1.3	1.1
Combined Uncertainty		RSS				11	9.3
Combined Uncertainty (coverage factor=2)		Normal (k=2)				22	18.6



SAR-Z Axis at Hotspot x:-9.87 y:19.87

