

## Regulatory WLAN Antenna Information

<b>Platform</b>	
Platform Owner	Dell Inc.
Brand Name	Dell
Regulatory Model	PT02
Regulatory Type	PT02002
ODM	Quanta Computer Inc.
Target Launch Date	2010/3/30
<b>Antenna</b>	
Brand Name	Auden
Part Number	■ Tx1 Antenna: 220265-09
	■ Tx2 (or Rx2) Antenna : 220265-09
<b>Module</b>	
With WLAN Module	■ Intel 6250
(Check Box)	

## Antenna Sample / Antenna Data Requirements for worldwide regulatory approval

Section	Description of Required OEM / ODM Antenna Information	US / IC	EU	Japan	Taiwan	S.Korea
1A	Part Number for Antenna only	Required	Required	Required	Required	Required
1B	Antenna Manufacturer Name	Required	Required	Required	Required	Required
1C	Description of Antenna Type	Required	N/A	N/A	N/A	N/A
1D	Part number of Antenna Assembly / cable impedance, length & diameter.	Required	Desired	Desired	Desired	Desired
1E	Tx1, Tx2 & Tx3 antenna (Peak Gain W/ cable loss) *	Required	Required	Required	Required	Required
	1E OR 1F, 1G, 1H					
1F	Tx1, Tx2 & Tx3 antenna (Peak Gain only) *	Required	Required	Required	Required	Required
1G	VSWR of cable including connector	Required	Required	Required	Required	Required
1H	Tx1, Tx2 & Tx3 antenna (Cable loss W/ connector) *	Required	Required	Required	Required	Required
2	Dimensioned Photographs <u>and</u> Drawings of Tx1, Tx2, and Tx3 (or Rx3) antennas	Required	Required	Required	Required	Required
3	Radiation patterns of antennas loaded in the host platform.	Required	Desired	Required	N/A	Required
4	Platform model name / number - correlated to antenna manufacturer and antenna part number	Required	Required	Desired	Required	Desired
5	Photograph(s) or Drawings showing location of antennas in platform. (S. Korea requires photographs of antennas for approval submission). Taiwan requires pictures of each antenna type shown in the system.	Required	Required	Desired	<u>Required (Photos)</u>	<u>Required (Photos)</u>
6	Mech. drawings / photos with dimensions of antenna locations and distance from end-user (For evaluation of SAR testing requirement).	Required	N/A	N/A	N/A	N/A
7	Photograph(s) or Drawings showing the location of all antennas (WLAN, other) and distance between those transmitting antennas. Information will be used to evaluate whether co-location testing is required.	Required	N/A	N/A	N/A	N/A
8	Local representative contact information for LMA/ PARS process.	Required	N/A	N/A	N/A	N/A

**NOTE:**

(\*) if 3<sup>rd</sup> antenna is Rx only, then peak gain and cable loss not required

# Antenna Information

## Section 1. Antenna Assembly Specifications

### Antenna Assembly Summary:

1A Antenna Part Number	1B Manufactur e	1C Antenna Type	1D Cable Assembly Part Number and Information	1E *Peak Gain W/ Cable loss (dBi)	1F Peak Gain w/o Cable Loss (dBi)	1G VSWR	1H Cable Loss (dBi)
(P/N: 220265-09) Tx1 antenna	Auden Tech	PIFA (RoHS: Yes), PCB	(P/N: DQ622026500) 50 ohm Coaxial. length:627 mm diameter: 1.13mmLL Connector: U.FL	2400-2500MHz -0.35 dBi (peak)	2400-2500MHz 1.22 dBi (peak)	2400-2500MHz 3 max	2400-2500MHz 1.57 dBi (peak)
				2496-2690MHz 0.25 dBi (peak)	2496-2690MHz 1.90 dBi (peak)	2496-2690MHz 3 max	2496-2690MHz 1.65 dBi (peak)
				5150-5350MHz -0.44 dBi (peak)	5150-5350MHz 2.16 dBi (peak)	5150-5350MHz 3max	5150-5350MHz 2.60 dBi (peak)
				5470-5725MHz 0.35 dBi (peak)	5470-5725MHz 3 dBi (peak)	5470-5725MHz 3 max	5470-5725MHz 2.65 dBi (peak)
				5725-5850MHz 0.46 dBi (peak)	5725-5850MHz 3.13 dBi (peak)	5725-5850MHz 3max	5725-5850MHz 2.67 dBi (peak)
(P/N: 220265-09) Tx2 antenna (or Rx2 )	Auden Tech	PIFA (RoHS: Yes), PCB	(P/N: DQ622026500) 50 ohm Coaxial. length:403.2 mm diameter: 1.13mmLL Connector: U.FL	2400-2500MHz -0.53 dBi (peak) *	2400-2500MHz 0.48 dBi (peak) *	2400-2500MHz 3 max *	2400-2500MHz 1.008 dBi (peak) *
				2496-2690MHz -1.93 dBi (peak) *	2496-2690MHz -0.87 dBi (peak) *	2496-2690MHz 3max*	2496-2690MHz 1.06 dBi (peak) *
				5150-5350MHz 2.20 dBi (peak) *	5150-5350MHz 3.87 dBi (peak) *	5150-5350MHz 3 max *	5150-5350MHz 1.67 dBi (peak) *
				5470-5725MHz 2.17 dBi (peak) *	5470-5725MHz 3.87 dBi (peak) *	5470-5725MHz 3 max *	5470-5725MHz 1.70 dBi (peak) *
				5725-5850MHz 0.80 dBi (peak) *	5725-5850MHz 2.52 dBi (peak) *	5725-5850MHz 3 max *	5725-5850MHz 1.72 dBi (peak) *

#### NOTE:

(\* ) If Rx2/Rx3 only (2<sup>nd</sup> or 3<sup>rd</sup> antenna receives only), then the information marked with \* is not required

**Antenna Peak Gain Table:**

Frequency (MHz)	Tx1 antenna		Tx2 (or Rx2) Antenna	
	Horizontal (dBi)	Vertical (dBi)	Horizontal (dBi)	Vertical (dBi)
2400	-2.62	-1.36	-2.62	-0.94
2442	-1.69	-0.36	-1.85	-0.53
2482	-1.61	-0.35	-2.41	-1.58
2501	-1.45	-0.66	-2.87	-1.98
2593	-1.02	-0.54	-3.49	-2.38
2685	-1.92	0.25	-2.99	-1.93
5150	-3.15	0.35	-1.04	2.18
5250	-2.91	0.08	0.20	2.20
5350	-3.52	-1.27	0.01	1.89
5470	-2.88	-0.55	-0.49	2.17
5600	-1.88	0.10	0.06	1.62
5725	-1.45	0.07	0.54	0.80
5785	-1.92	0.46	0.31	0.52
5850	-2.75	-0.47	0.16	0.28

- Antenna Peak Gain required being test in system basis.
- 1E frame contend absolutely peak antenna gain include H/V
- If Rx2 or Rx3 only (2<sup>nd</sup> or 3<sup>rd</sup> antenna receives only), then the information is not required for Rx2 or Rx3.





Antenna Manufacturer: Auden Tech

Antenna Part Number: 220265-09 (Tx1 Antenna) , 220265-09 (Tx2 or Rx2 Antenna)

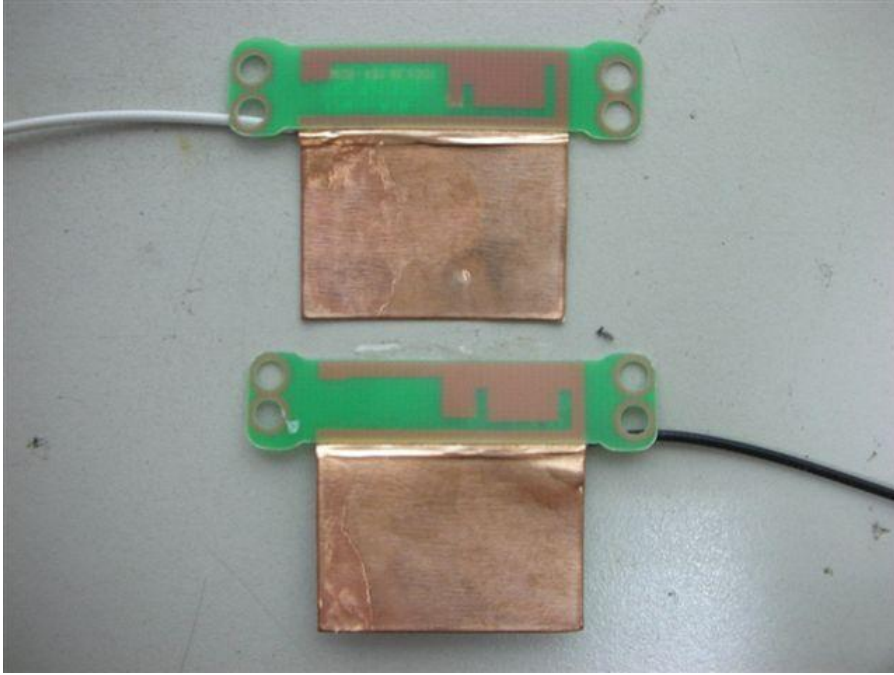

**Include back view photo of all antennas here.**

Antenna Manufacturer: Auden Tech

Antenna Part Number: 220265-09 (Tx1 Antenna) , 220265-09 (Tx2 or Rx2 Antenna)

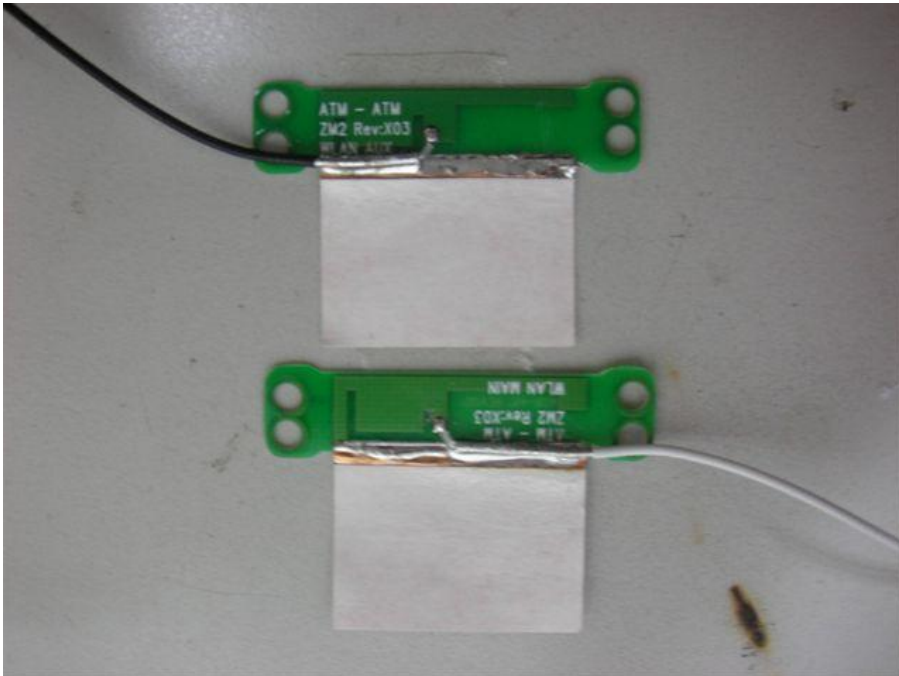

### Section 3. Radiation characteristics of antennae Loaded in Host Platform

#### 2400-2500MHz radiation characteristic

Tx1 antenna: 2400 MHz

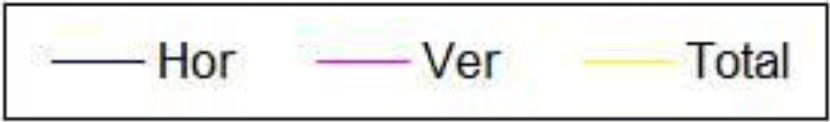
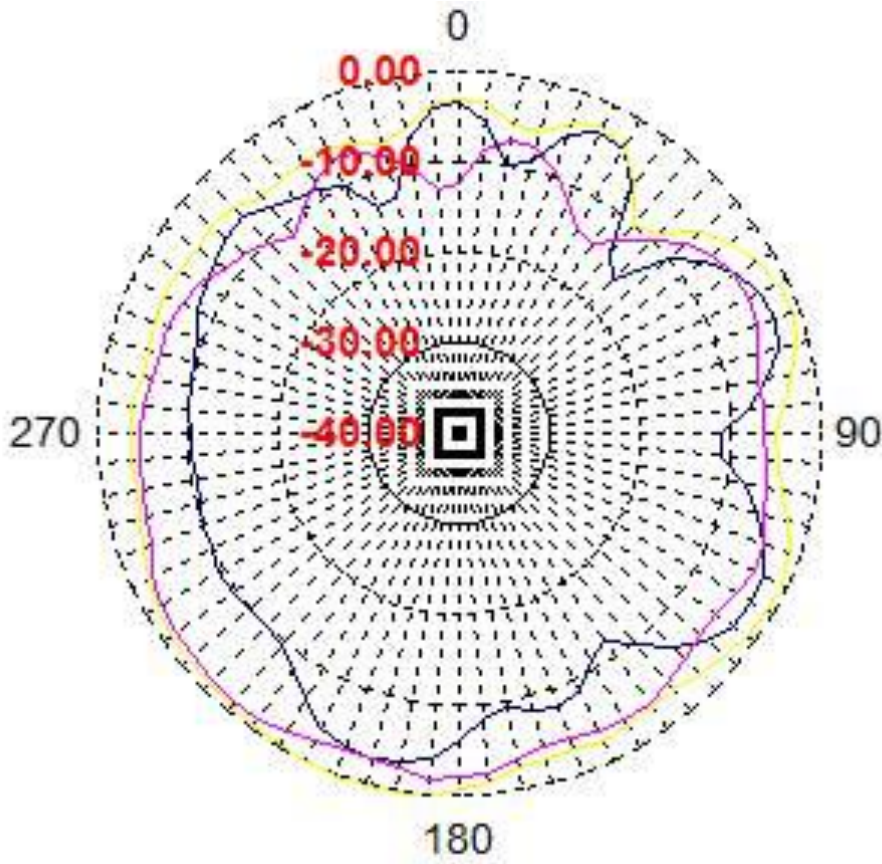

<b>Centre Frequency</b>	<b>2400MHz</b>
Horizontal peak gain (dBi)	-2.62
Vertical peak gain (dBi)	-1.36



**Tx1 antenna: 2442 MHz**

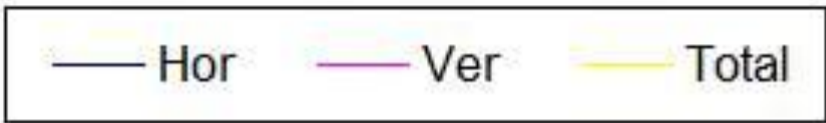
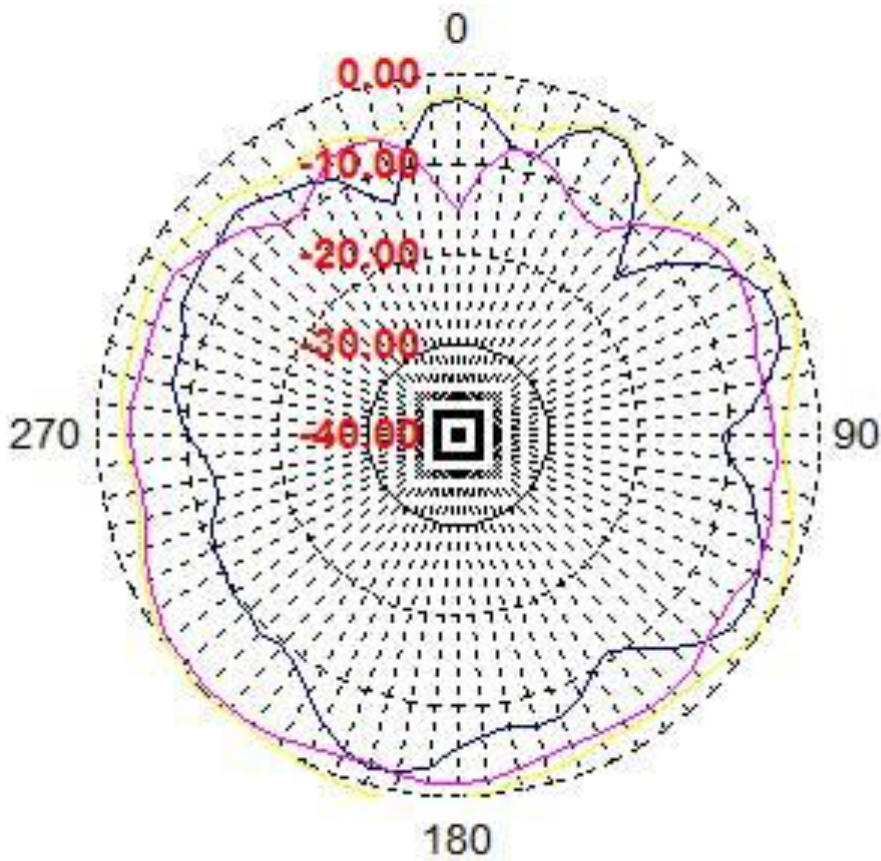

<b>Centre Frequency</b>	<b>2442MHz</b>
Horizontal peak gain (dBi)	-1.69
Vertical peak gain (dBi)	-0.36

**Tx1 antenna: 2482 MHz**

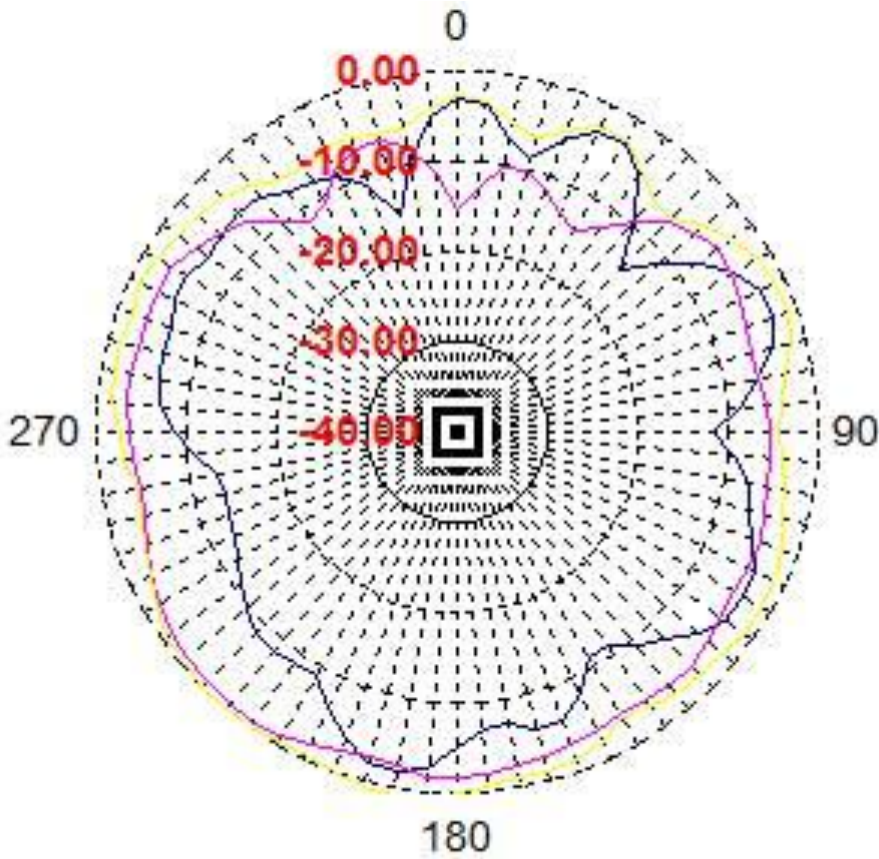

<b>Centre Frequency</b>	<b>2482MHz</b>
Horizontal peak gain (dBi)	-1.61
Vertical peak gain (dBi)	-0.53

**Tx2 (or Rx2) antenna: 2400 MHz (Plot is not required if 2<sup>nd</sup> Antenna is receive only e.g. Rx2 for 512 family)**

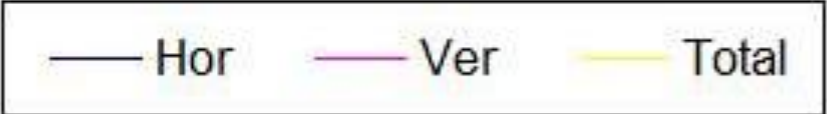
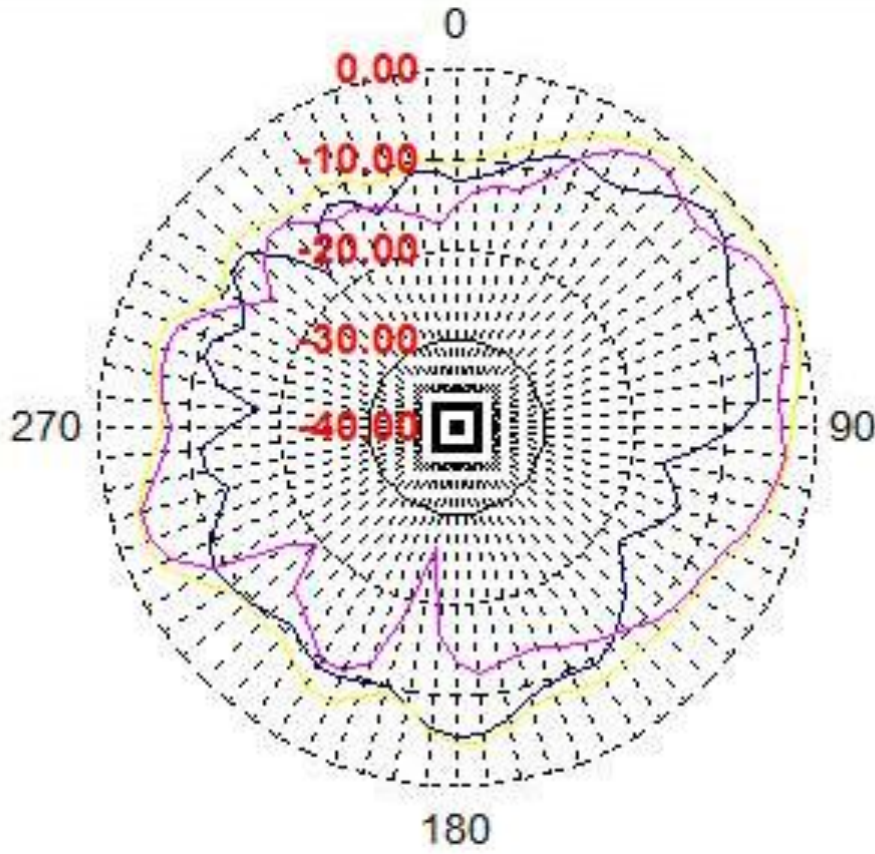

<b>Centre Frequency</b>	<b>2400MHz</b>
Horizontal peak gain (dBi)	-2.62
Vertical peak gain (dBi)	-0.94



**Tx2 (or Rx2) antenna: 2442 MHz (Plot is not required if 2<sup>nd</sup> Antenna is receive only e.g. Rx2 for 512 family)**

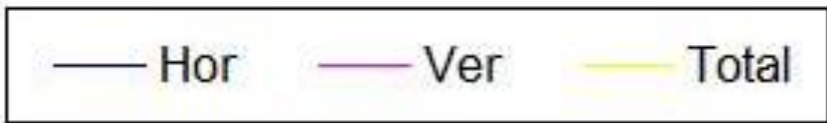
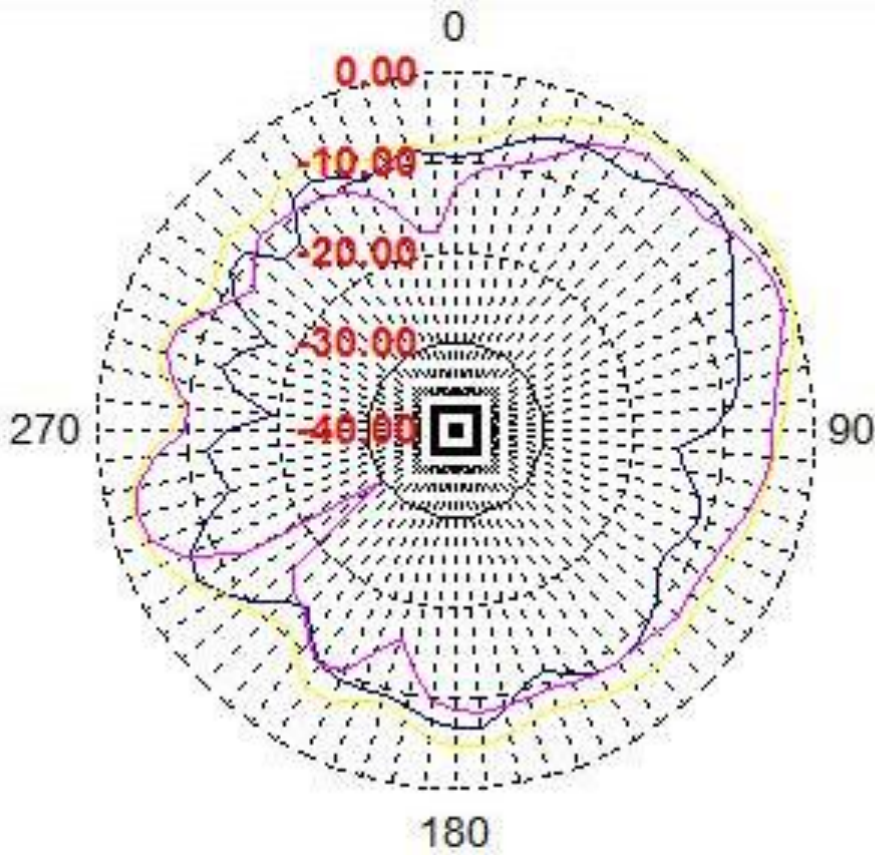

<b>Centre Frequency</b>	<b>2442MHz</b>
Horizontal peak gain (dBi)	-1.85
Vertical peak gain (dBi)	-0.53

**Tx2 (or Rx2) antenna: 2482 MHz (Plot is not required if 2<sup>nd</sup> Antenna is receive only e.g. Rx2 for 512 family)**

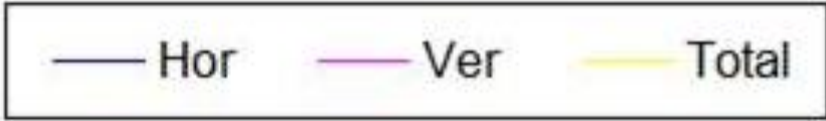
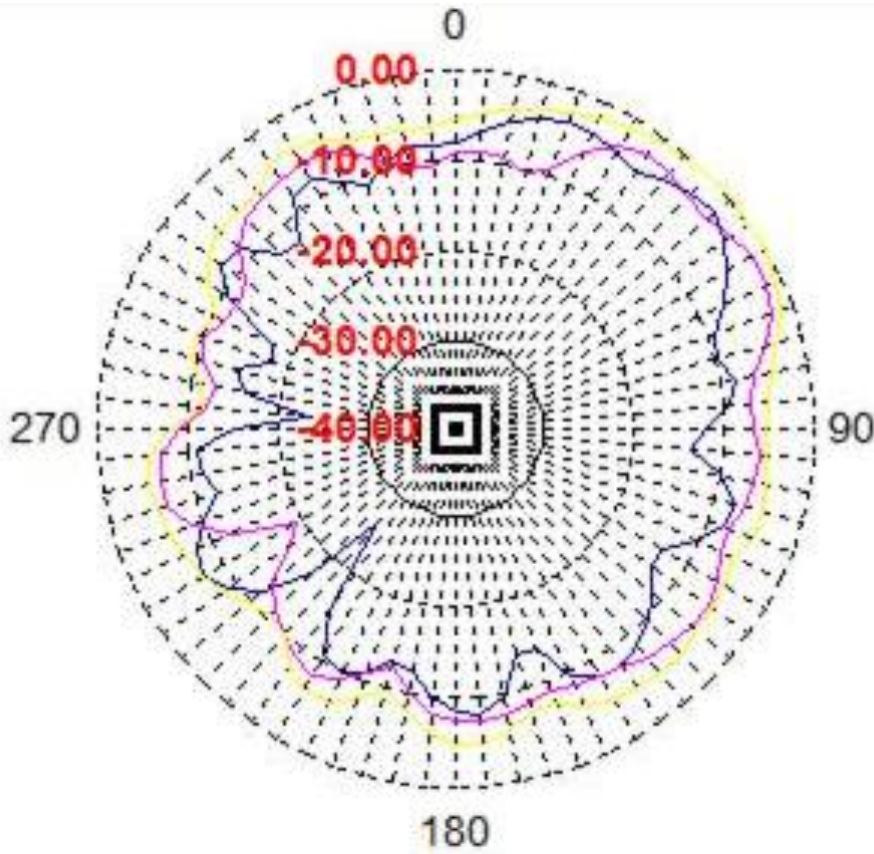

<b>Centre Frequency</b>	<b>2482MHz</b>
Horizontal peak gain (dBi)	-2.41
Vertical peak gain (dBi)	-1.58

2490-2700MHz radiation characteristic

Tx1antenna: 2501 MHz

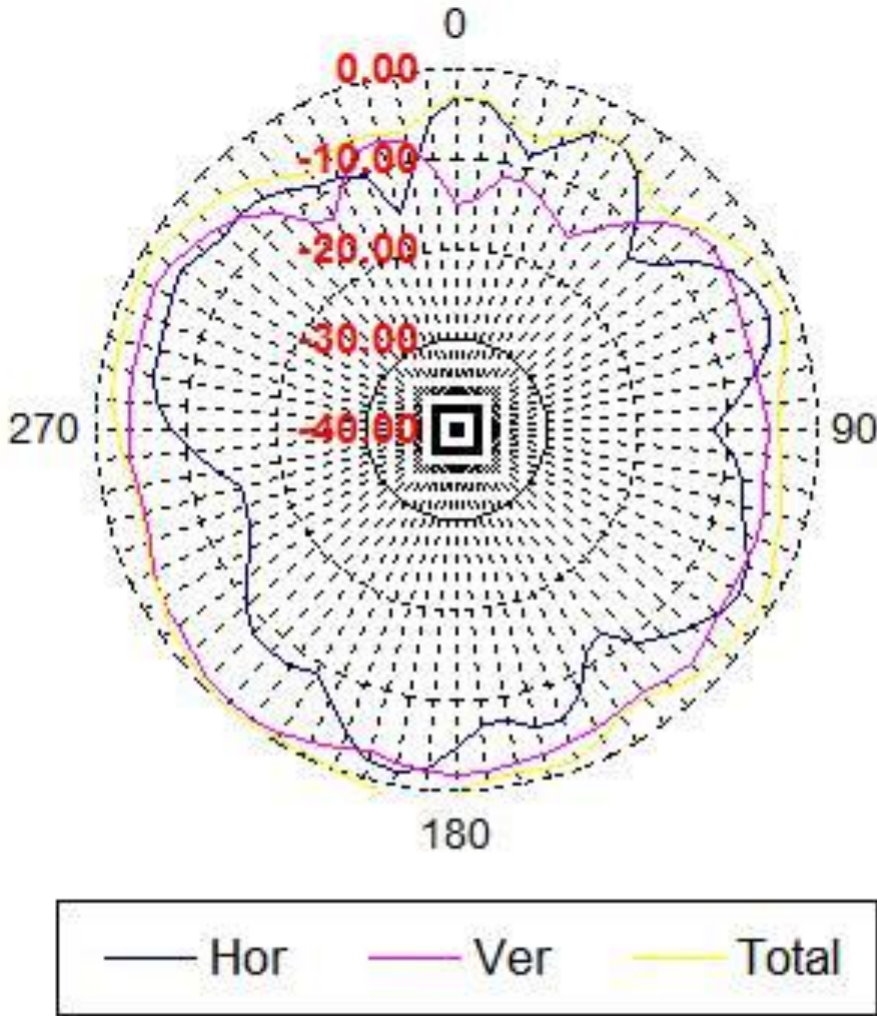

<b>Centre Frequency</b>	<b>2501MHz</b>
Horizontal peak gain (dBi)	-1.45
Vertical peak gain (dBi)	-0.66



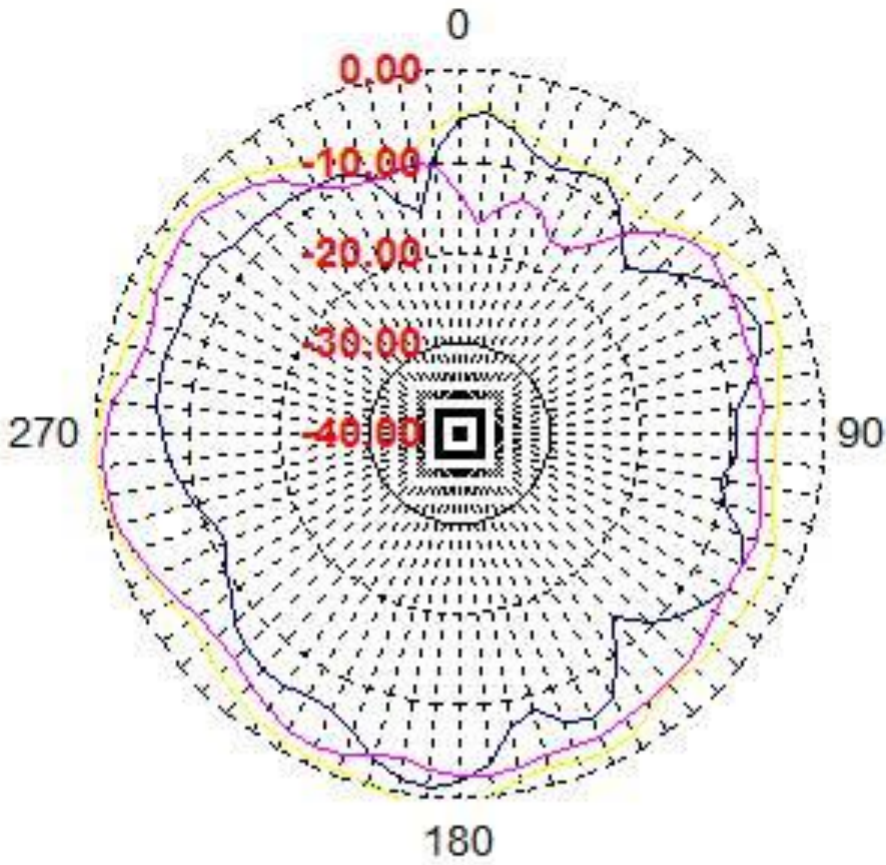

<b>Centre Frequency</b>	<b>2593MHz</b>
Horizontal peak gain (dBi)	-1.02
Vertical peak gain (dBi)	-0.54

**Tx1 antenna: 2685 MHz**

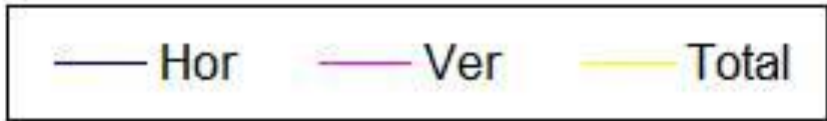
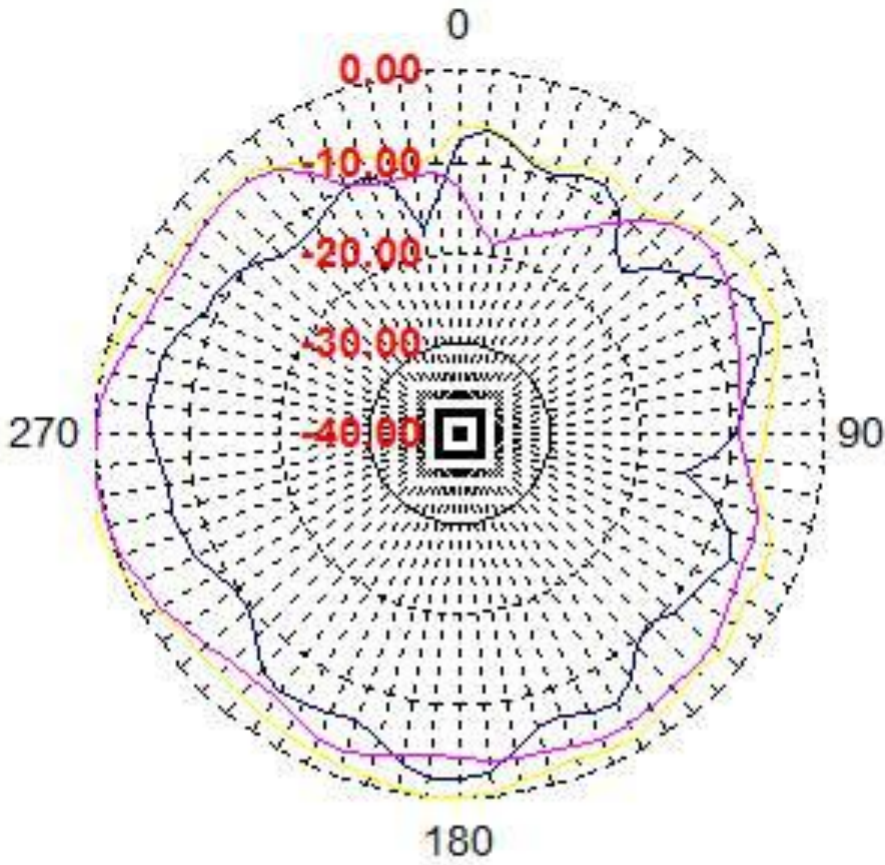

<b>Centre Frequency</b>	<b>2685MHz</b>
Horizontal peak gain (dBi)	-1.92
Vertical peak gain (dBi)	0.25



**Tx2 (or Rx2) antenna: 2501MHz (Plot is not required if 2<sup>nd</sup> Antenna is receive only e.g. Rx2 for 512 family)**

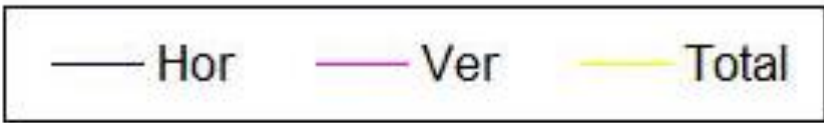
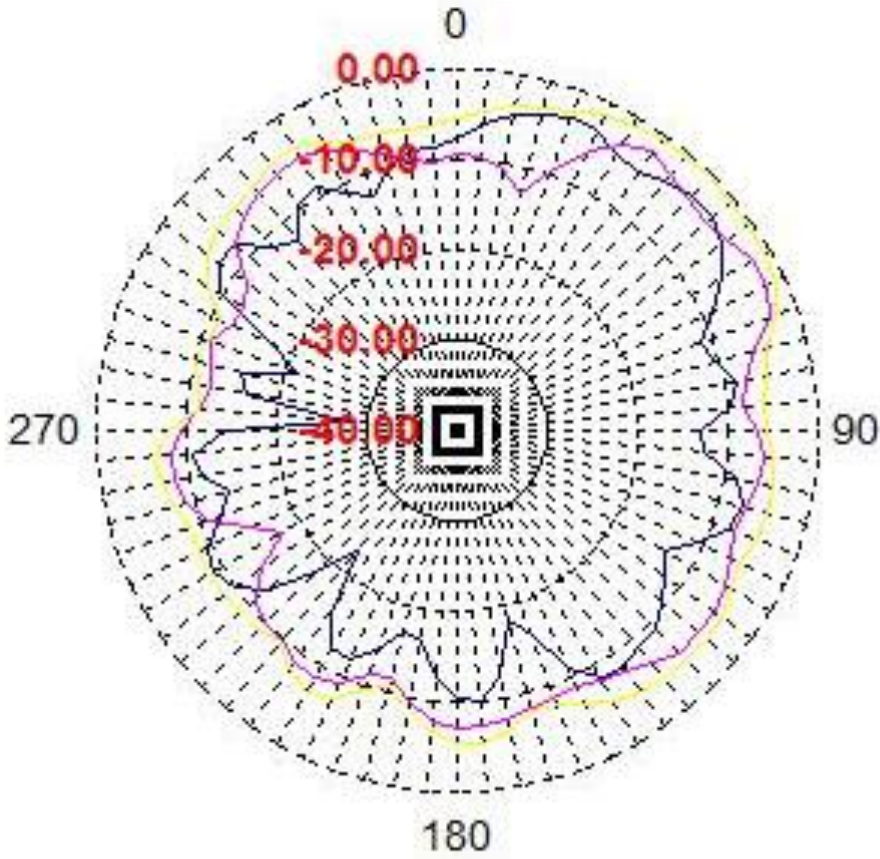

<b>Centre Frequency</b>	<b>2501MHz</b>
Horizontal peak gain (dBi)	-2.87
Vertical peak gain (dBi)	-1.98

**Tx2 (or Rx2) antenna: 2593MHz (Plot is not required if 2<sup>nd</sup> Antenna is receive only e.g. Rx2 for 512 family)**

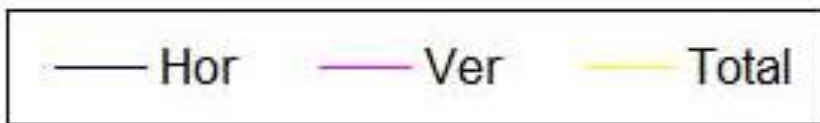
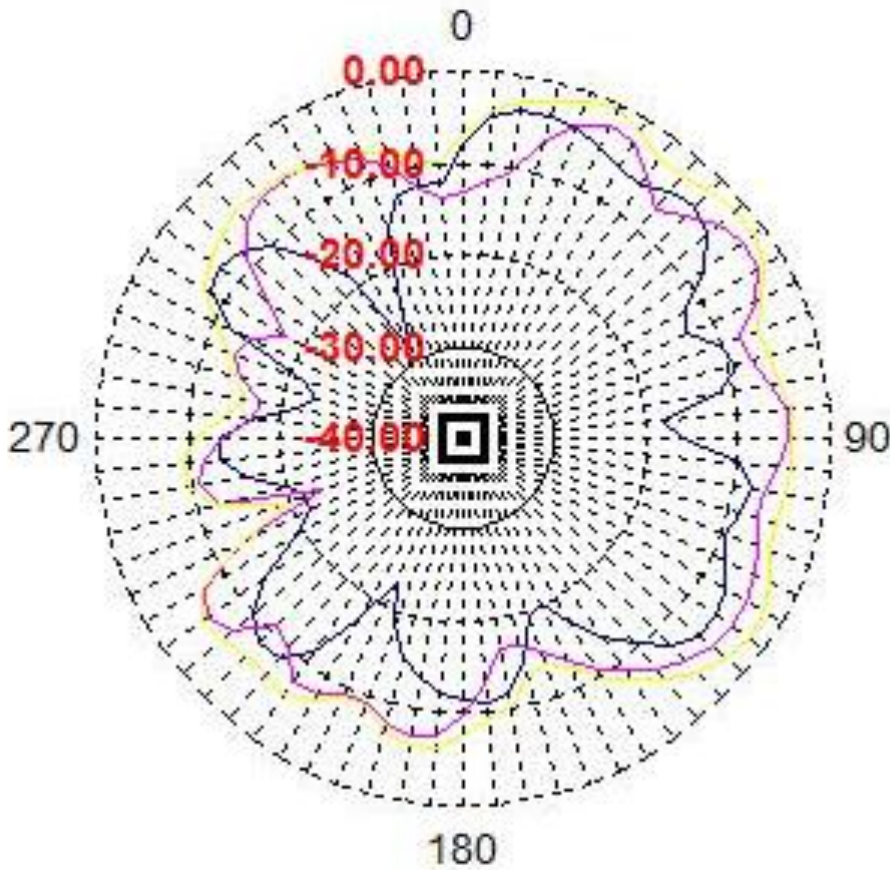

<b>Centre Frequency</b>	<b>2593MHz</b>
Horizontal peak gain (dBi)	-3.49
Vertical peak gain (dBi)	-2.38

**Tx2 (or Rx2) antenna: 2685 MHz (Plot is not required if 2<sup>nd</sup> Antenna is receive only e.g. Rx2 for 512 family)**

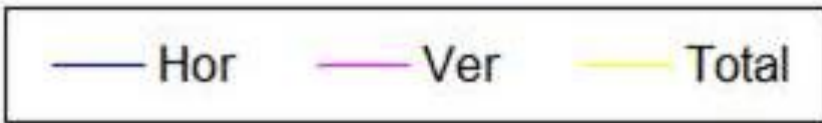
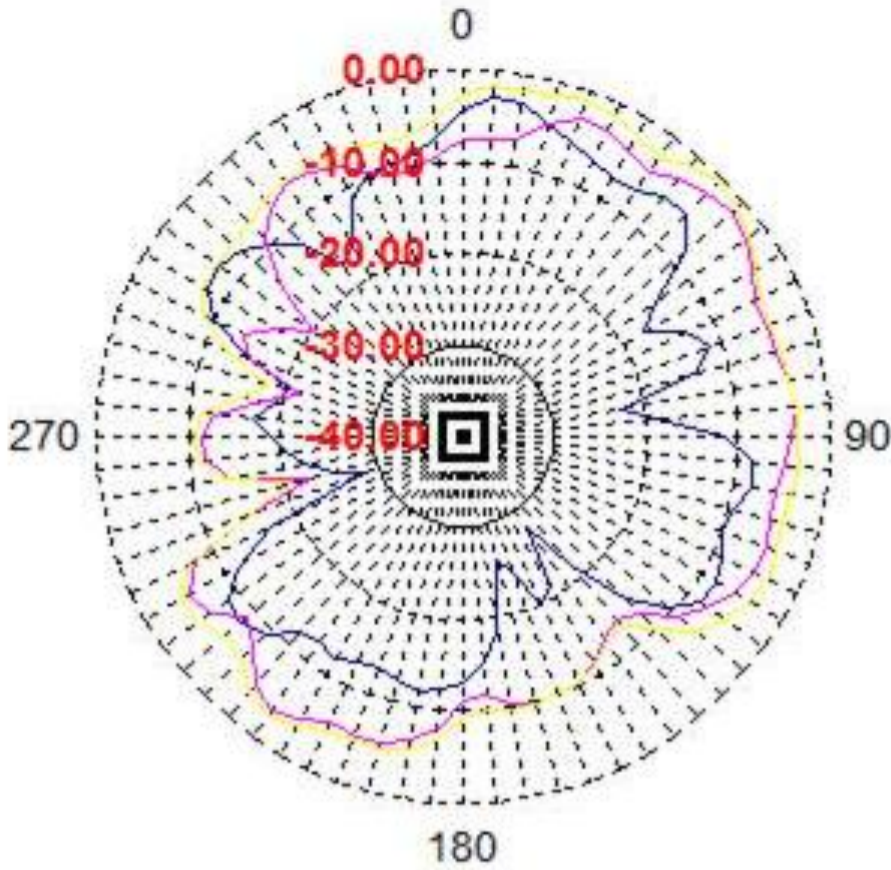

<b>Centre Frequency</b>	<b>2685MHz</b>
Horizontal peak gain (dBi)	-2.99
Vertical peak gain (dBi)	-1.93



5150-5350 MHz radiation characteristic

Tx1 antenna: 5150 MHz

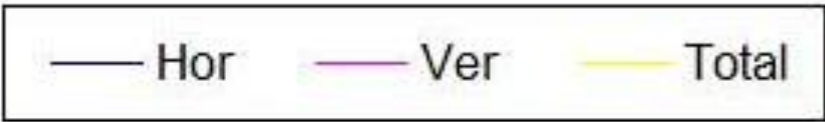
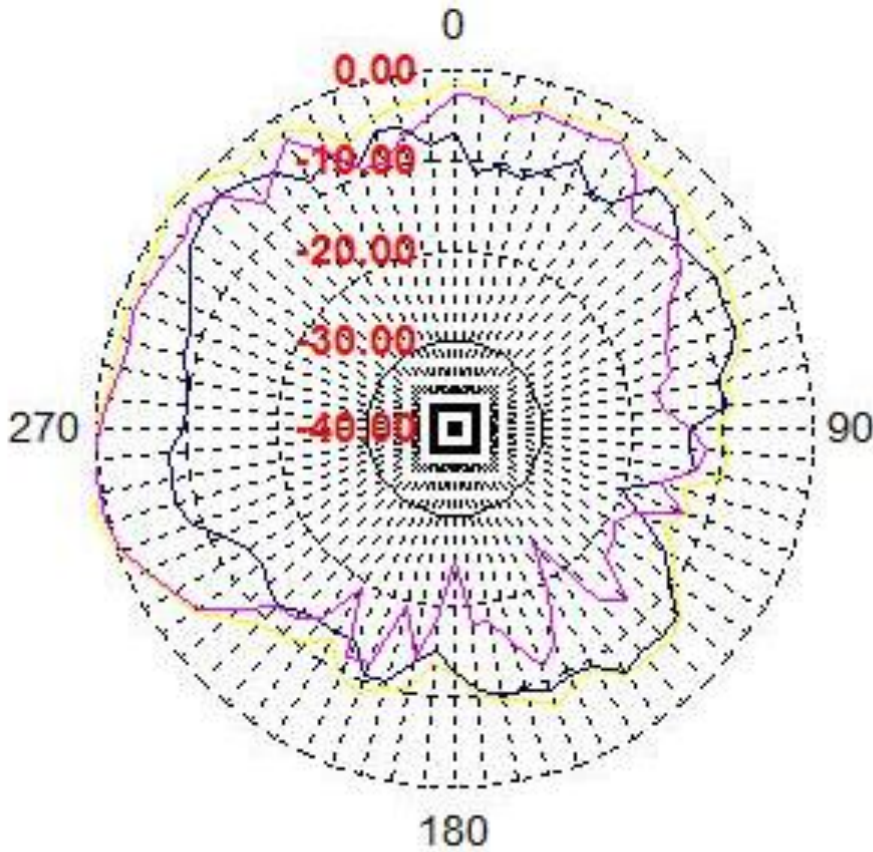

<b>Centre Frequency</b>	<b>5150MHz</b>
Horizontal peak gain (dBi)	-3.15
Vertical peak gain (dBi)	0.35

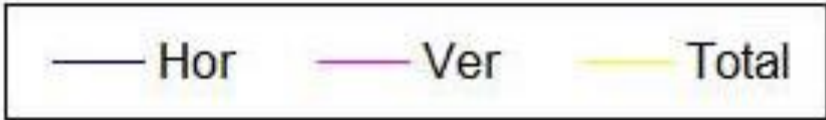
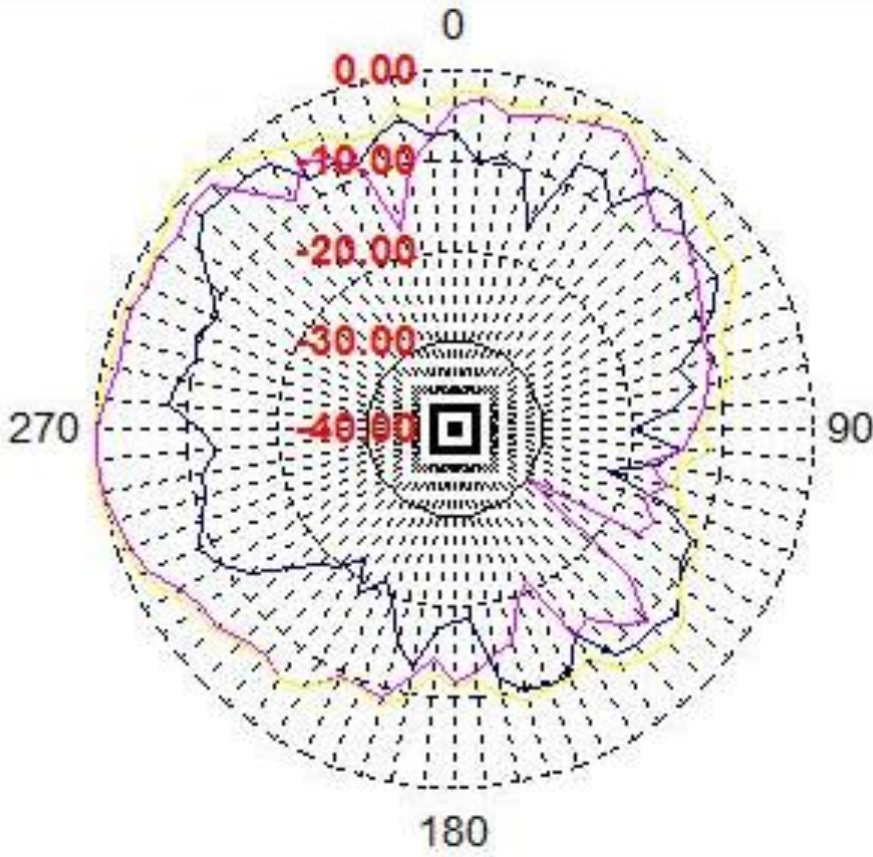

<b>Centre Frequency</b>	<b>5250MHz</b>
Horizontal peak gain (dBi)	-2.91
Vertical peak gain (dBi)	0.08

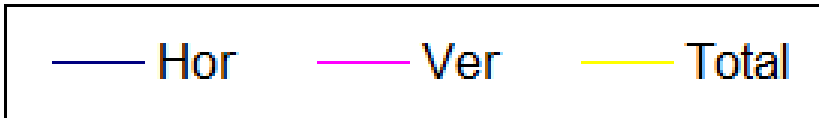
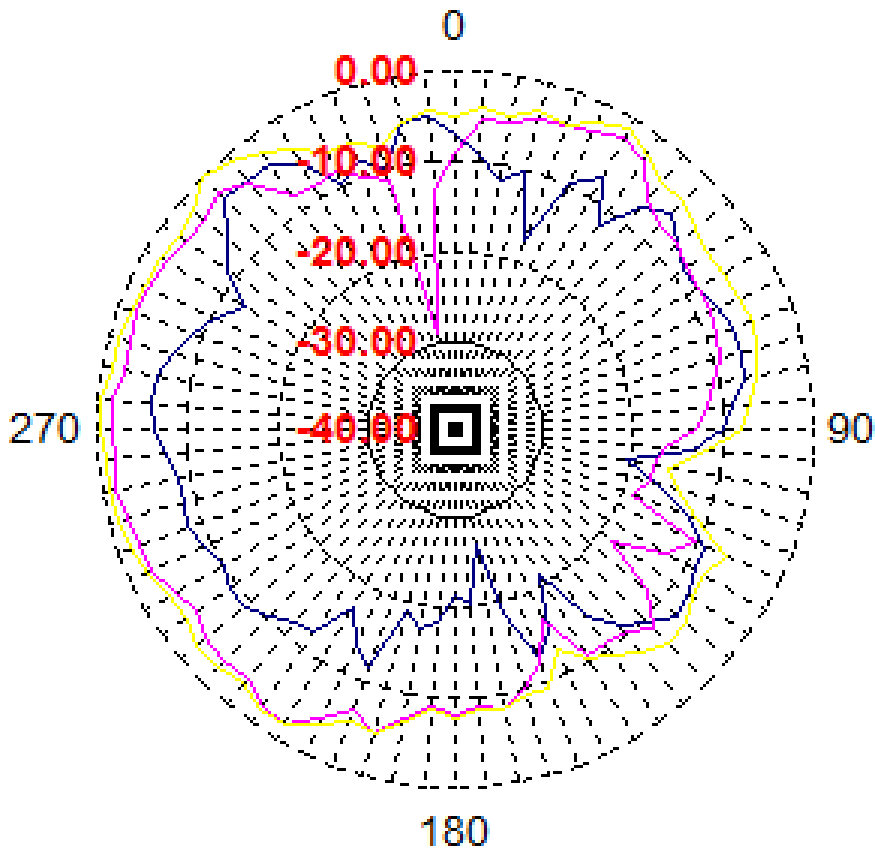

<b>Centre Frequency</b>	<b>5350MHz</b>
Horizontal peak gain (dBi)	-3.52
Vertical peak gain (dBi)	-1.27

**Tx2 (or Rx2) antenna: 5150 MHz (Plot is not required if 2<sup>nd</sup> Antenna is receive only e.g. Rx2 for 512 family)**

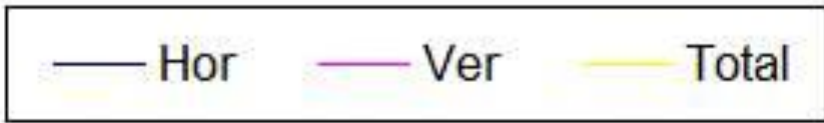
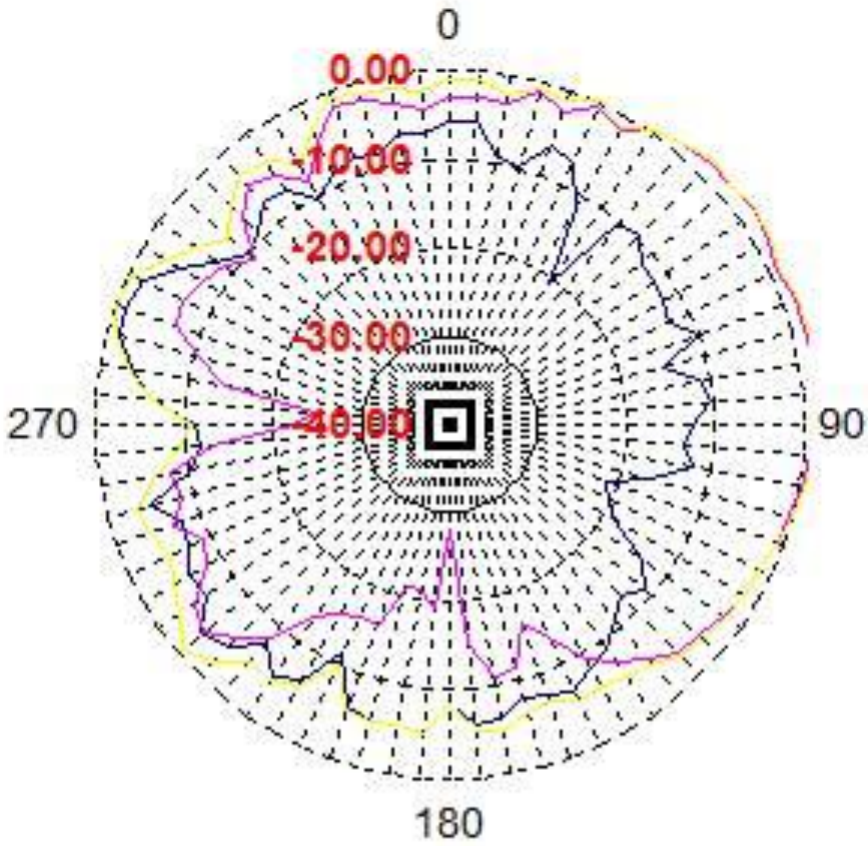

<b>Centre Frequency</b>	<b>5150MHz</b>
Horizontal peak gain (dBi)	-1.04
Vertical peak gain (dBi)	2.18



**Tx2 (or Rx2) antenna: 5250 MHz (Plot is not required if 2<sup>nd</sup> Antenna is receive only e.g. Rx2 for 512 family)**

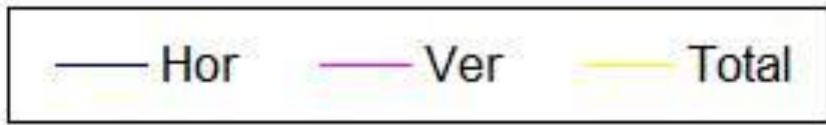
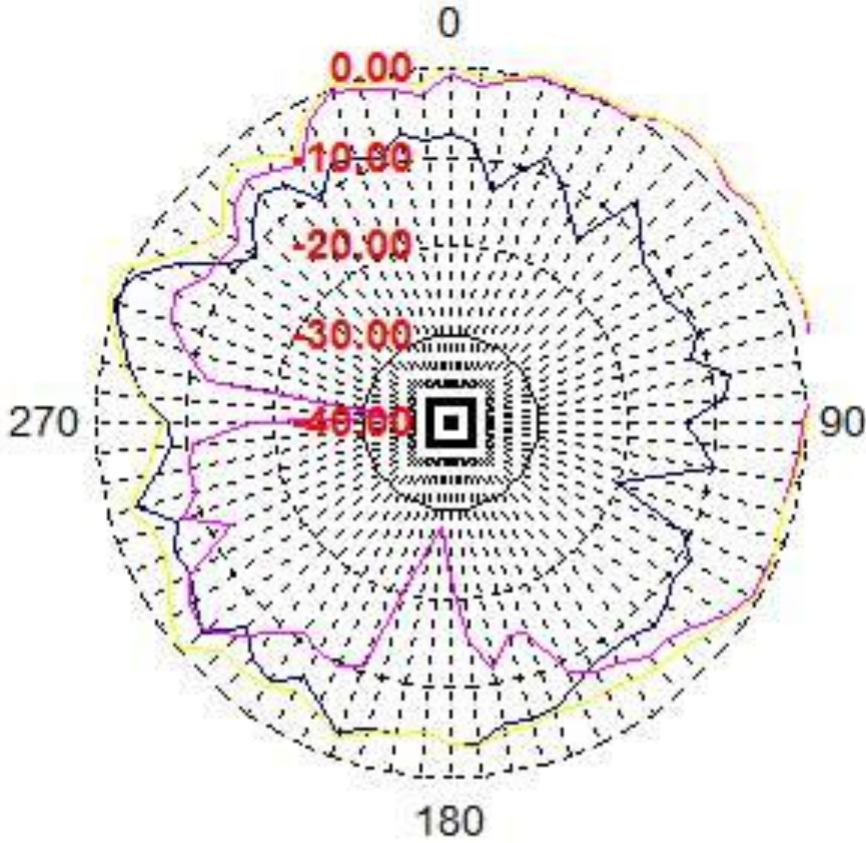

<b>Centre Frequency</b>	<b>5250MHz</b>
Horizontal peak gain (dBi)	0.20
Vertical peak gain (dBi)	2.20



**Tx2 (or Rx2) antenna: 5350 MHz (Plot is not required if 2<sup>nd</sup> Antenna is receive only e.g. Rx2 for 512 family)**

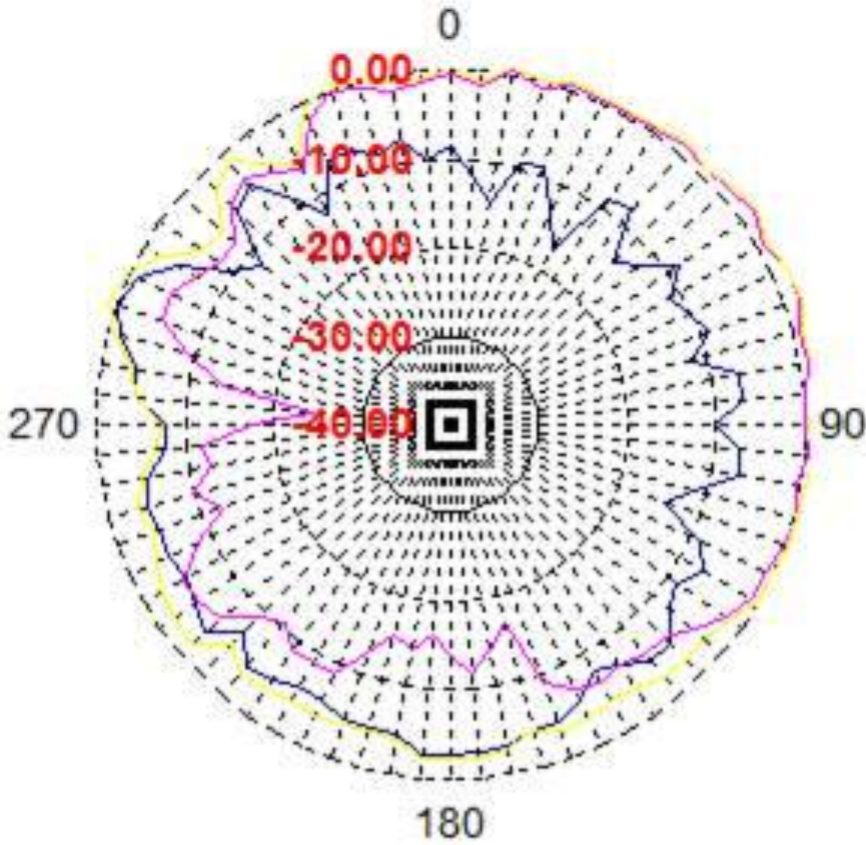

<b>Centre Frequency</b>	<b>5350MHz</b>
Horizontal peak gain (dBi)	0.01
Vertical peak gain (dBi)	1.89

5470-5725MHz radiation characteristic

Tx1 antenna: 5470 MHz

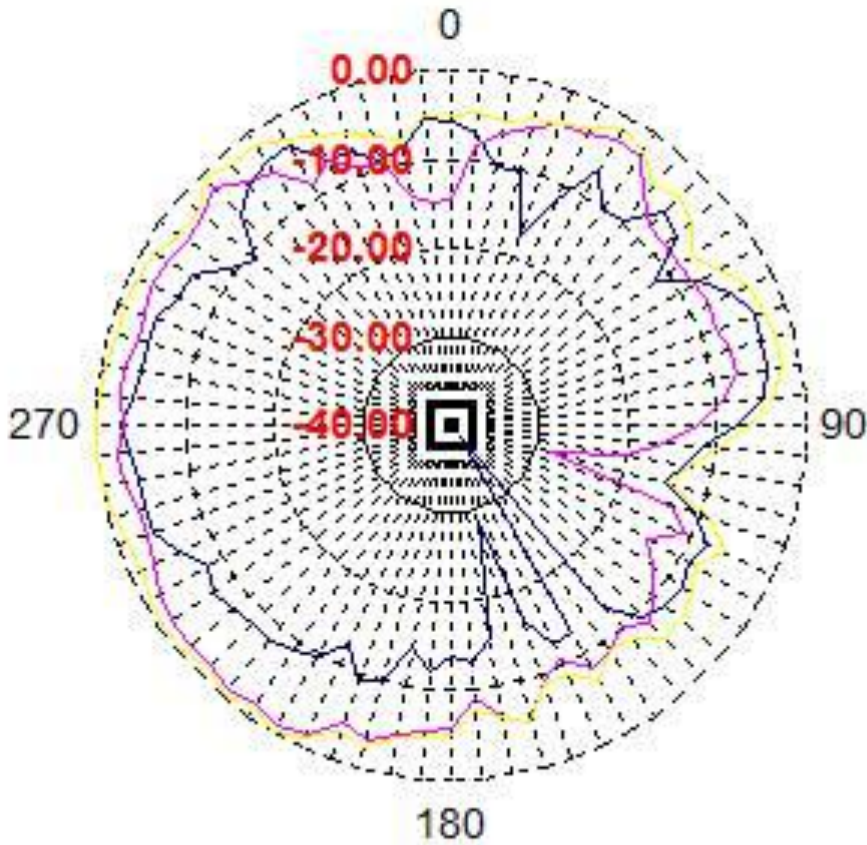

<b>Centre Frequency</b>	<b>5470MHz</b>
Horizontal peak gain (dBi)	-2.88
Vertical peak gain (dBi)	-0.55

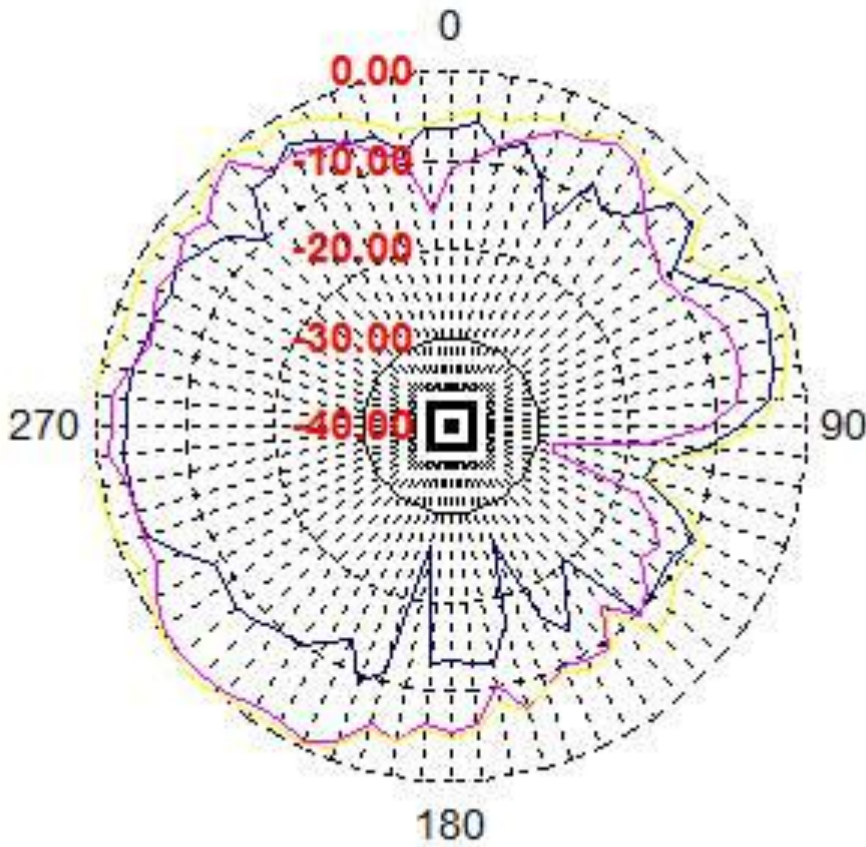

<b>Centre Frequency</b>	<b>5600MHz</b>
Horizontal peak gain (dBi)	-1.88
Vertical peak gain (dBi)	0.10



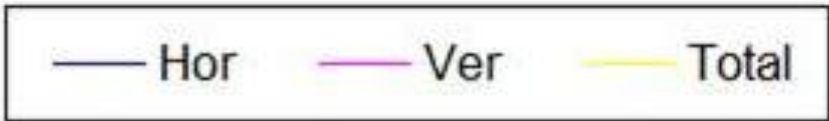
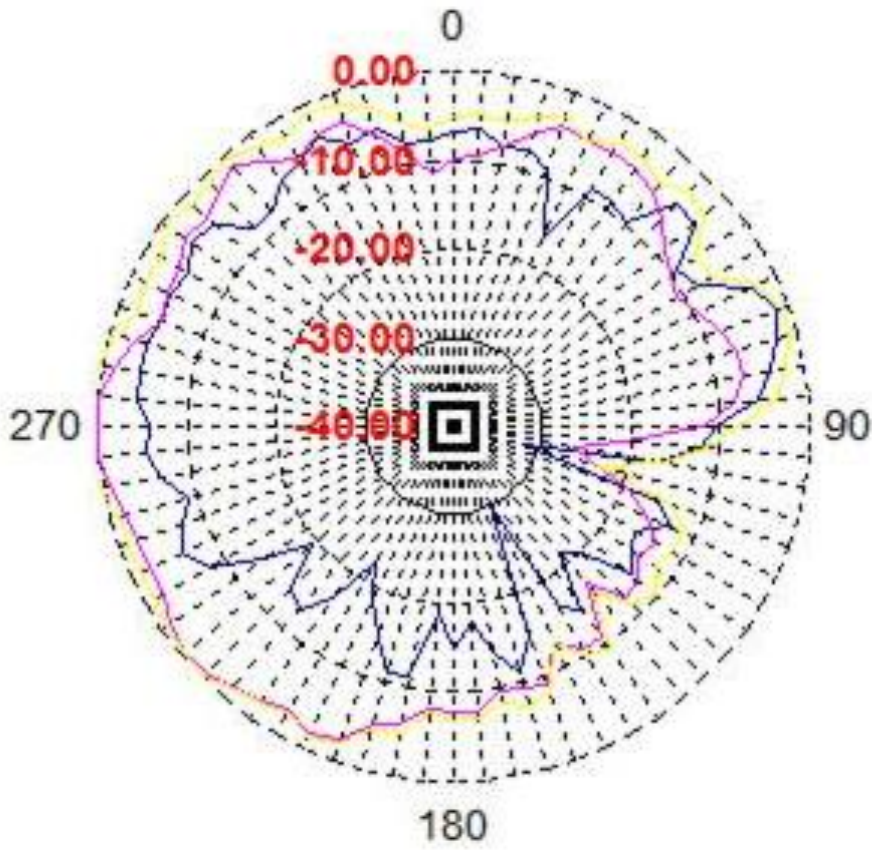

<b>Centre Frequency</b>	<b>5725MHz</b>
Horizontal peak gain (dBi)	-1.45
Vertical peak gain (dBi)	0.07

**Tx2 (or Rx2) antenna: 5470 MHz (Plot is not required if 2<sup>nd</sup> Antenna is receive only e.g. Rx2 for 512 family)**

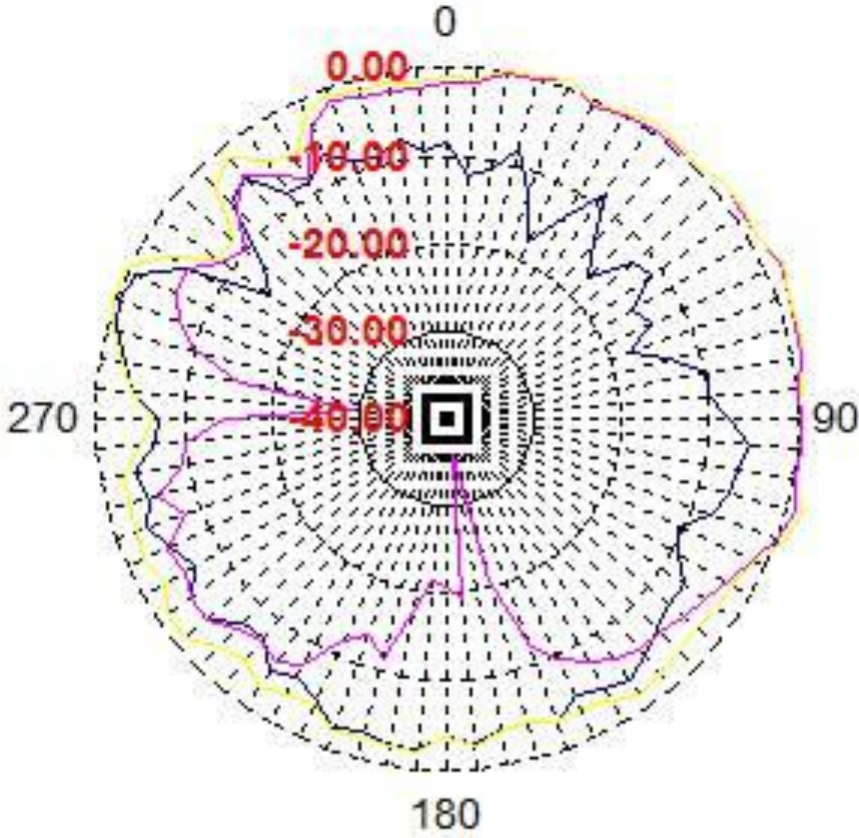

<b>Centre Frequency</b>	<b>5470MHz</b>
Horizontal peak gain (dBi)	-0.49
Vertical peak gain (dBi)	2.17

**Tx2 (or Rx2) antenna: 5600 MHz (Plot is not required if 2<sup>nd</sup> Antenna is receive only e.g. Rx2 for 512 family)**

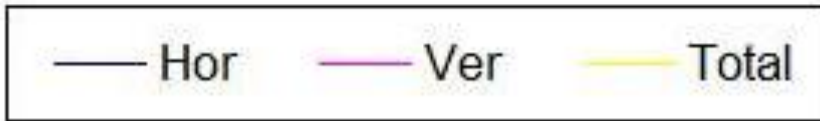
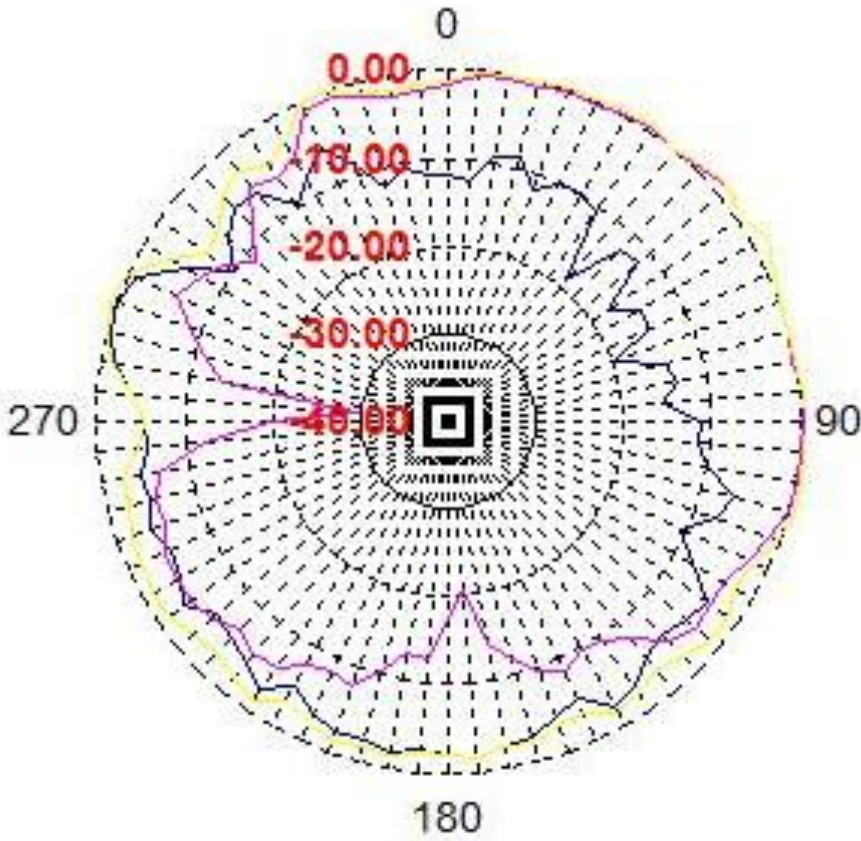

<b>Centre Frequency</b>	<b>5600MHz</b>
Horizontal peak gain (dBi)	0.06
Vertical peak gain (dBi)	1.62



**Tx2 (or Rx2) antenna: 5725 MHz (Plot is not required if 2<sup>nd</sup> Antenna is receive only e.g. Rx2 for 512 family)**

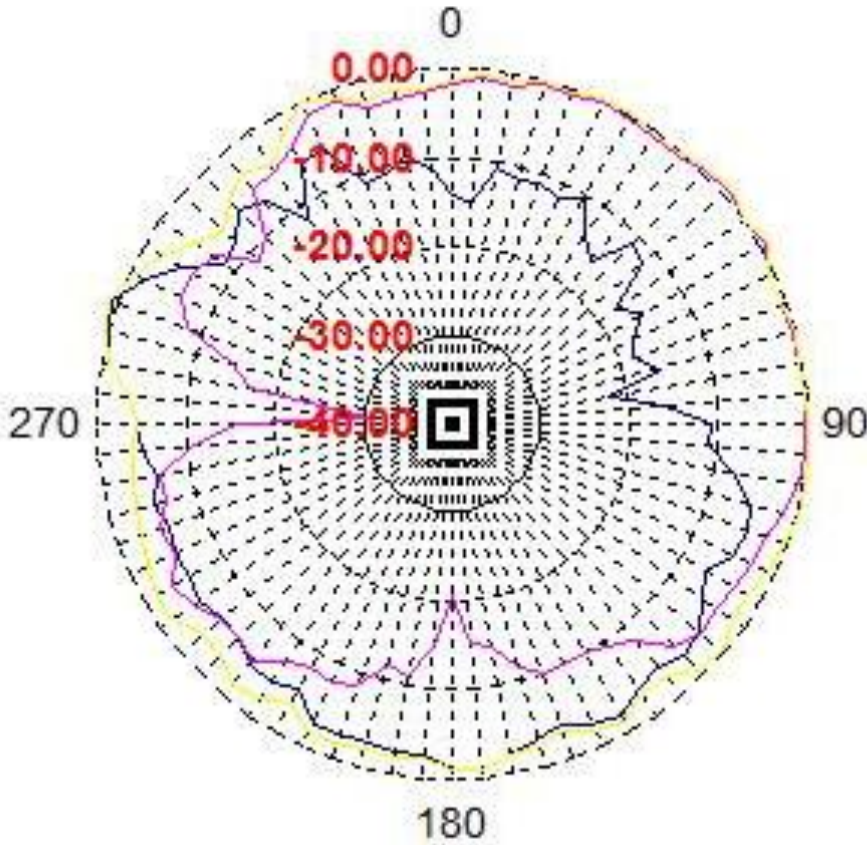

<b>Centre Frequency</b>	<b>5725MHz</b>
Horizontal peak gain (dBi)	0.54
Vertical peak gain (dBi)	0.80

5725-5850 MHz radiation characteristic

Tx1 antenna: 5725 MHz

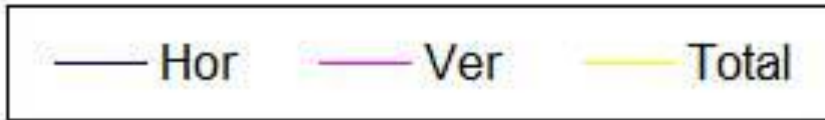
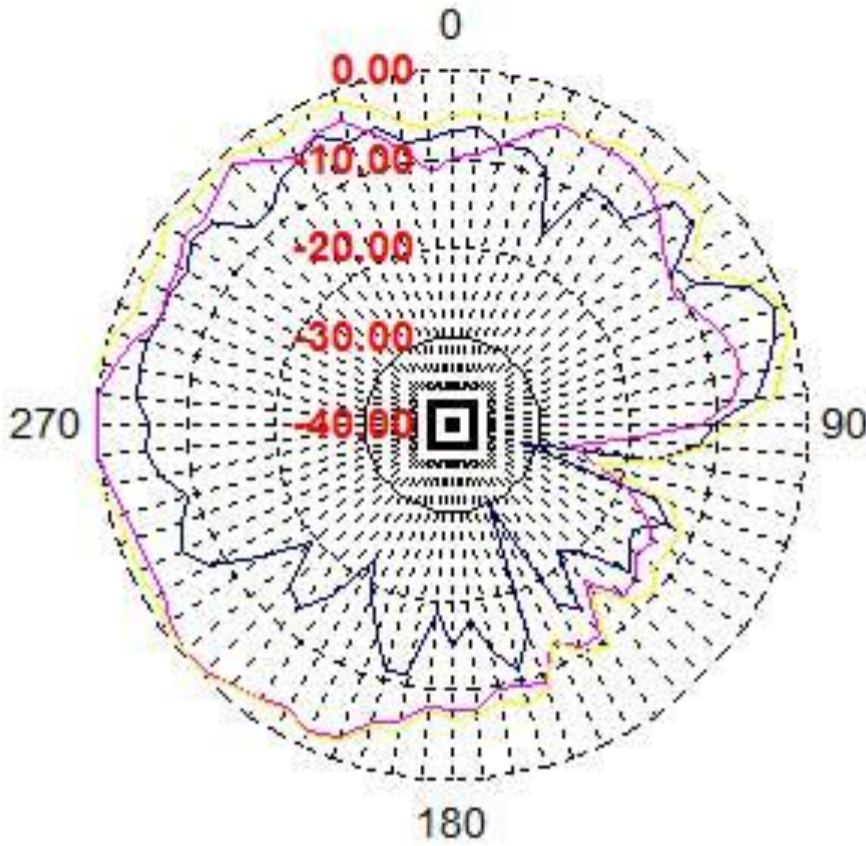

<b>Centre Frequency</b>	<b>5725MHz</b>
Horizontal peak gain (dBi)	-1.45
Vertical peak gain (dBi)	0.07



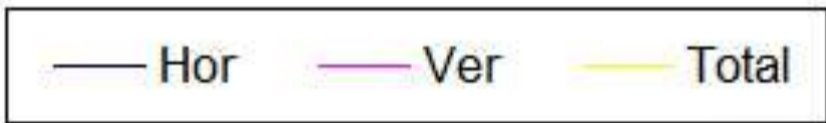
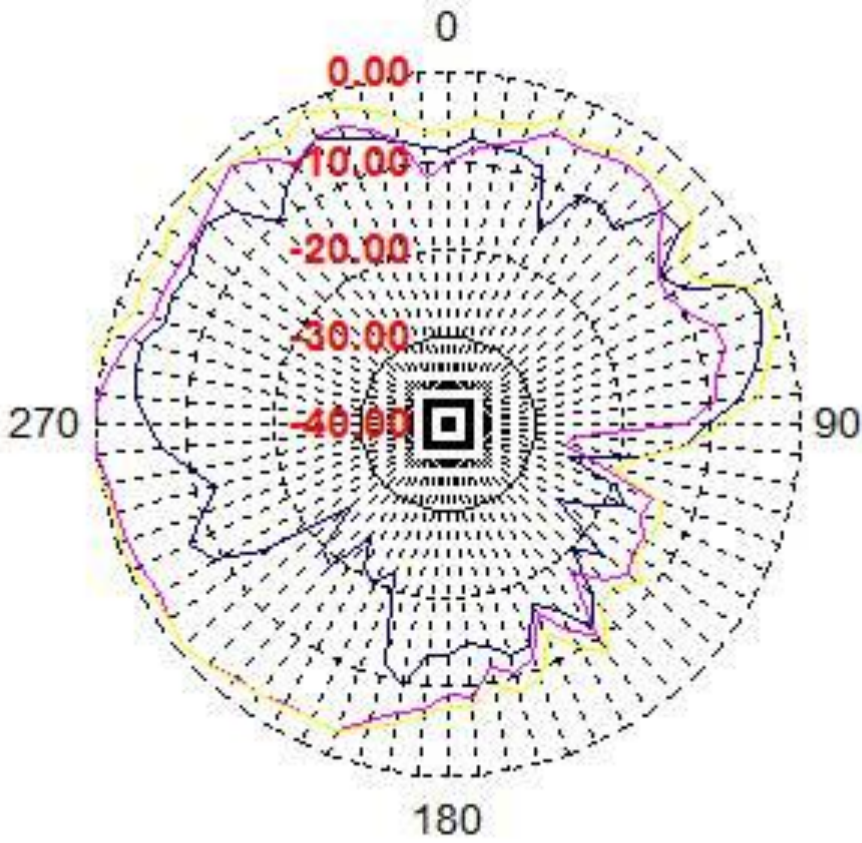

<b>Centre Frequency</b>	<b>5785MHz</b>
Horizontal peak gain (dBi)	-1.92
Vertical peak gain (dBi)	0.46

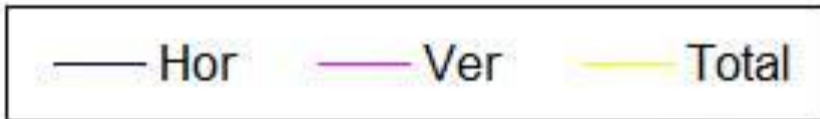
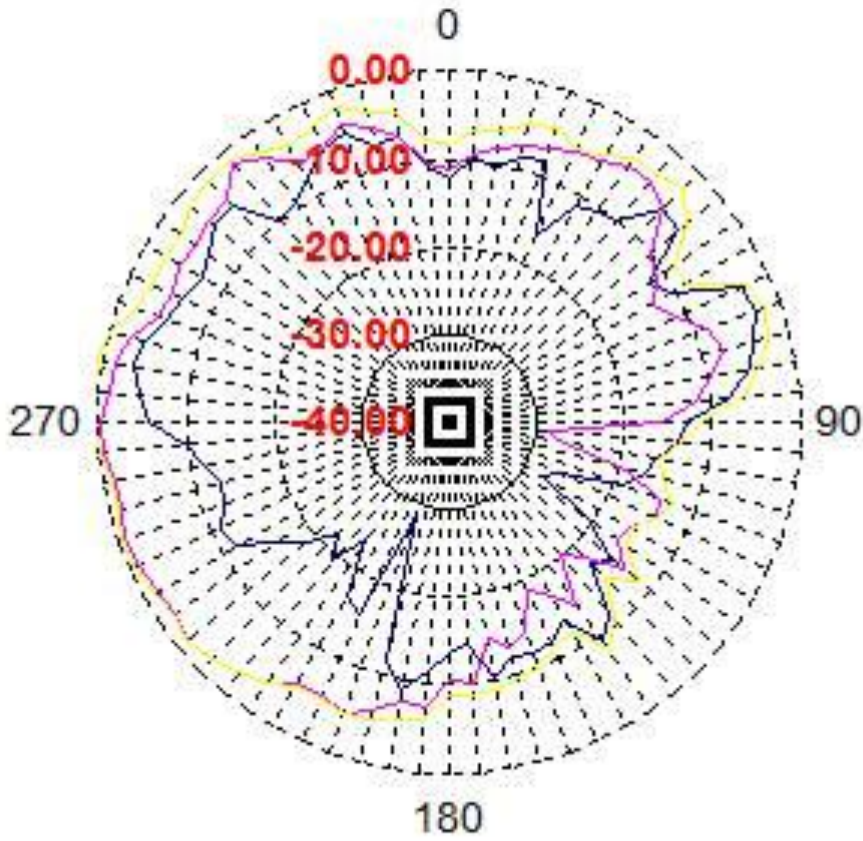

<b>Centre Frequency</b>	<b>5850MHz</b>
Horizontal peak gain (dBi)	-2.75
Vertical peak gain (dBi)	-0.47

**Tx2 (or Rx2) antenna: 5725 MHz (Plot is not required if 2<sup>nd</sup> Antenna is receive only e.g. Rx2 for 512 family)**

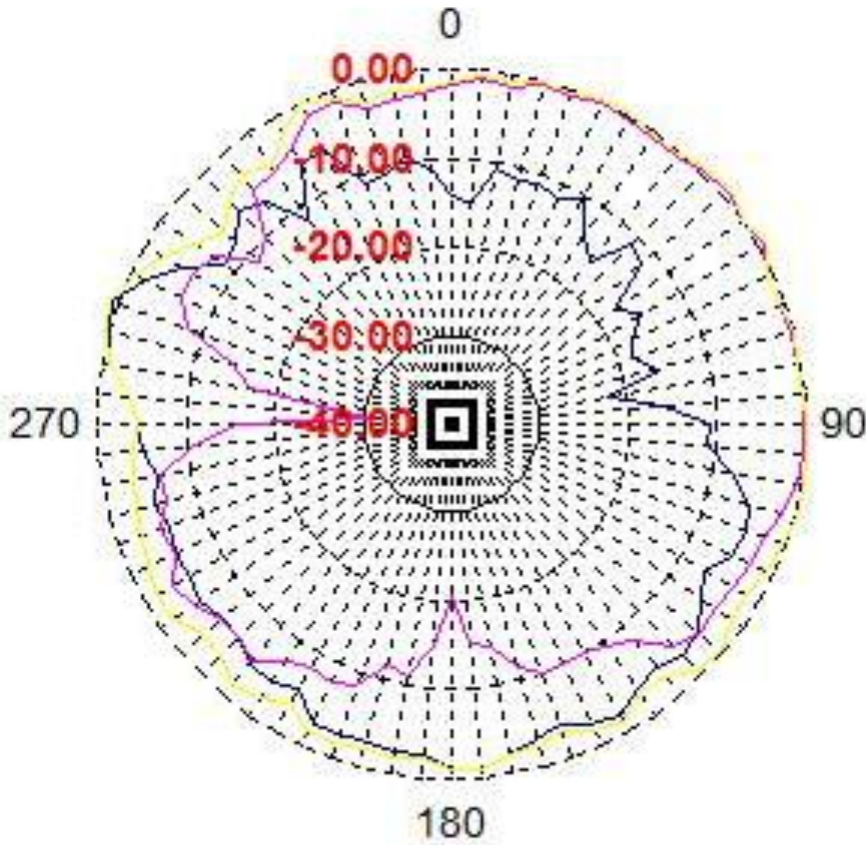

<b>Centre Frequency</b>	<b>5725MHz</b>
Horizontal peak gain (dBi)	0.54
Vertical peak gain (dBi)	0.80

**Tx2 (or Rx2) antenna: 5785 MHz (Plot is not required if 2<sup>nd</sup> Antenna is receive only e.g. Rx2 for 512 family)**

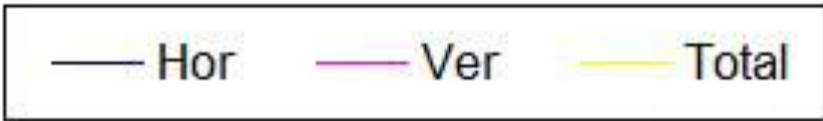
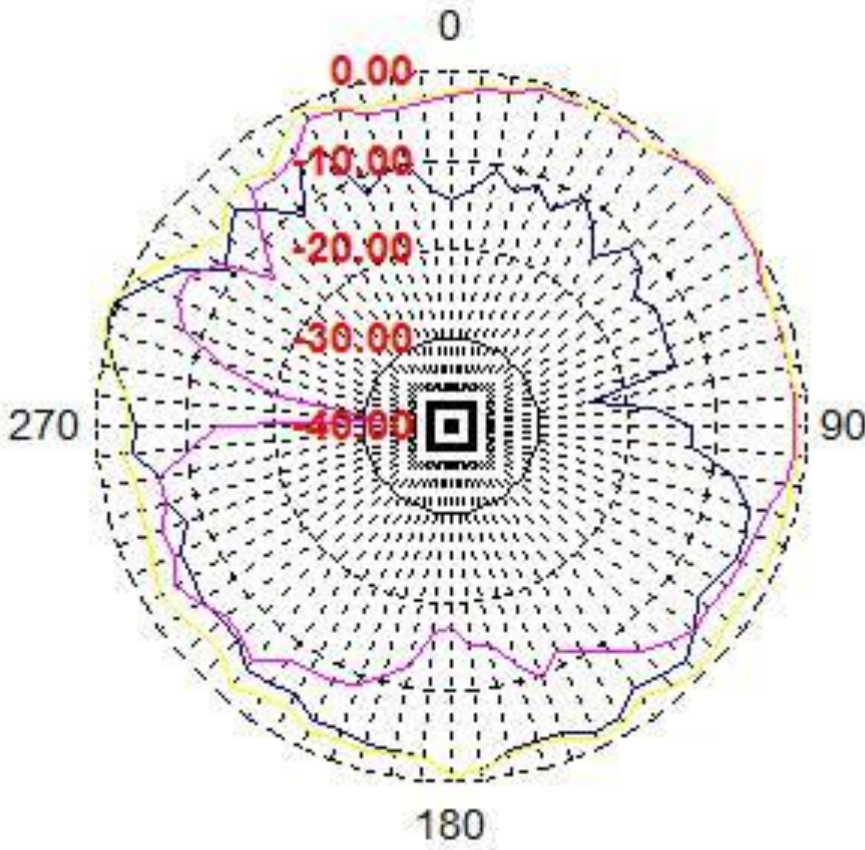

<b>Centre Frequency</b>	<b>5785MHz</b>
Horizontal peak gain (dBi)	0.31
Vertical peak gain (dBi)	0.52



**Tx2 (or Rx2) antenna: 5850 MHz (Plot is not required if 2<sup>nd</sup> Antenna is receive only e.g. Rx2 for 512 family)**

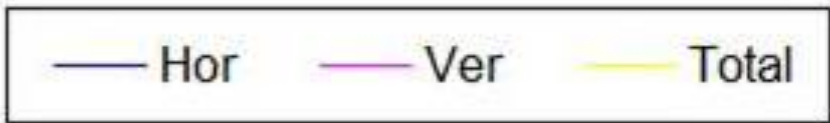
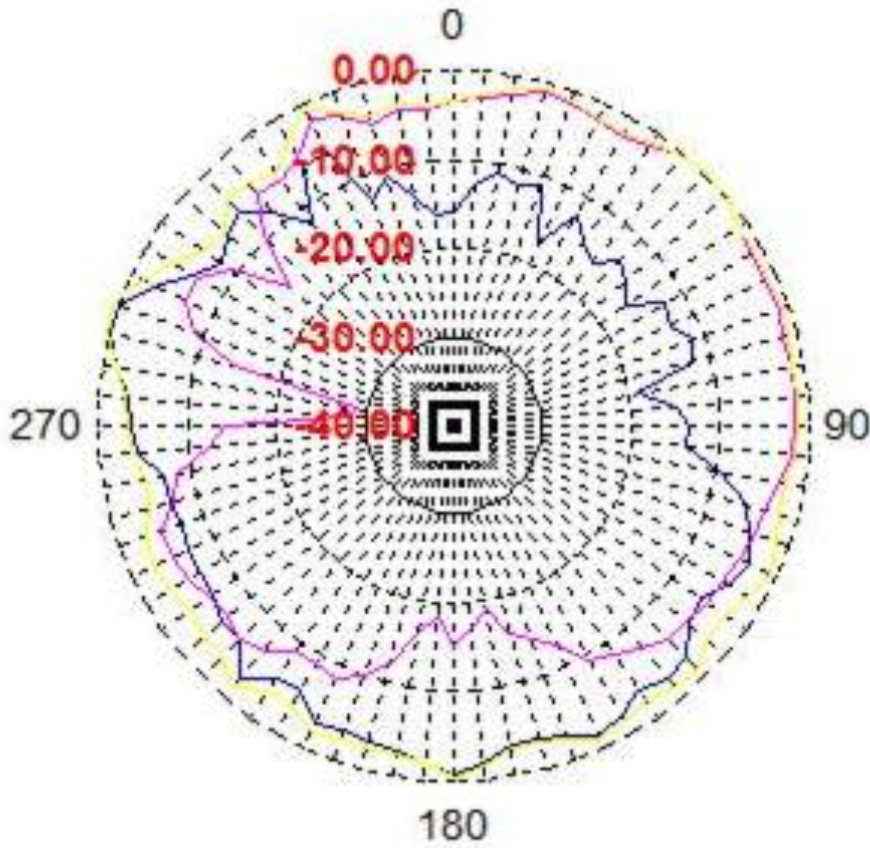

<b>Centre Frequency</b>	<b>5850MHz</b>
Horizontal peak gain (dBi)	0.16
Vertical peak gain (dBi)	0.28

## Section 4. Host Platform Information

OEM / ODM Host platform:

Rating Label Photo:

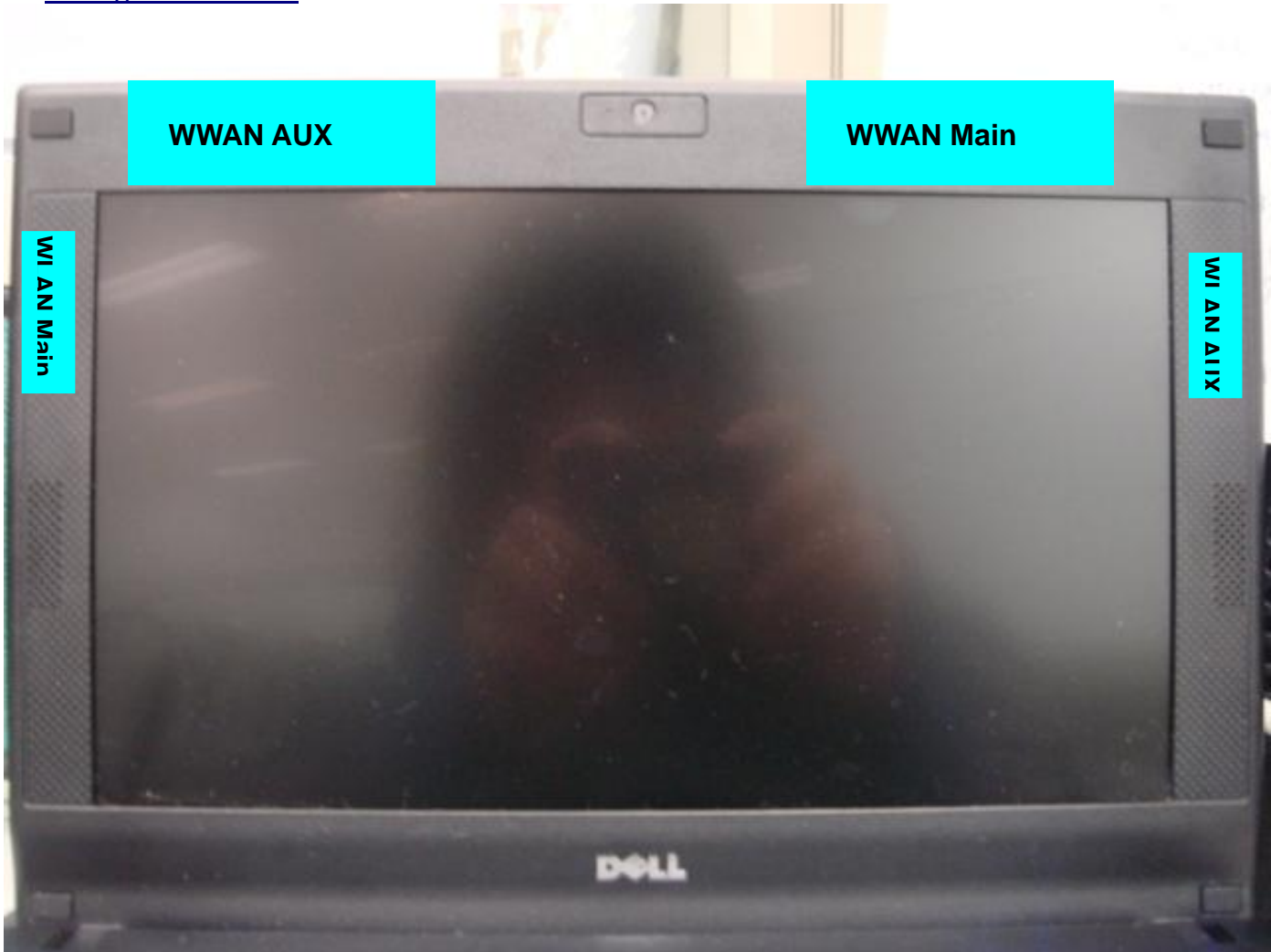

## Section 5. Antenna Host Platform Location Information

### Antenna Location Information

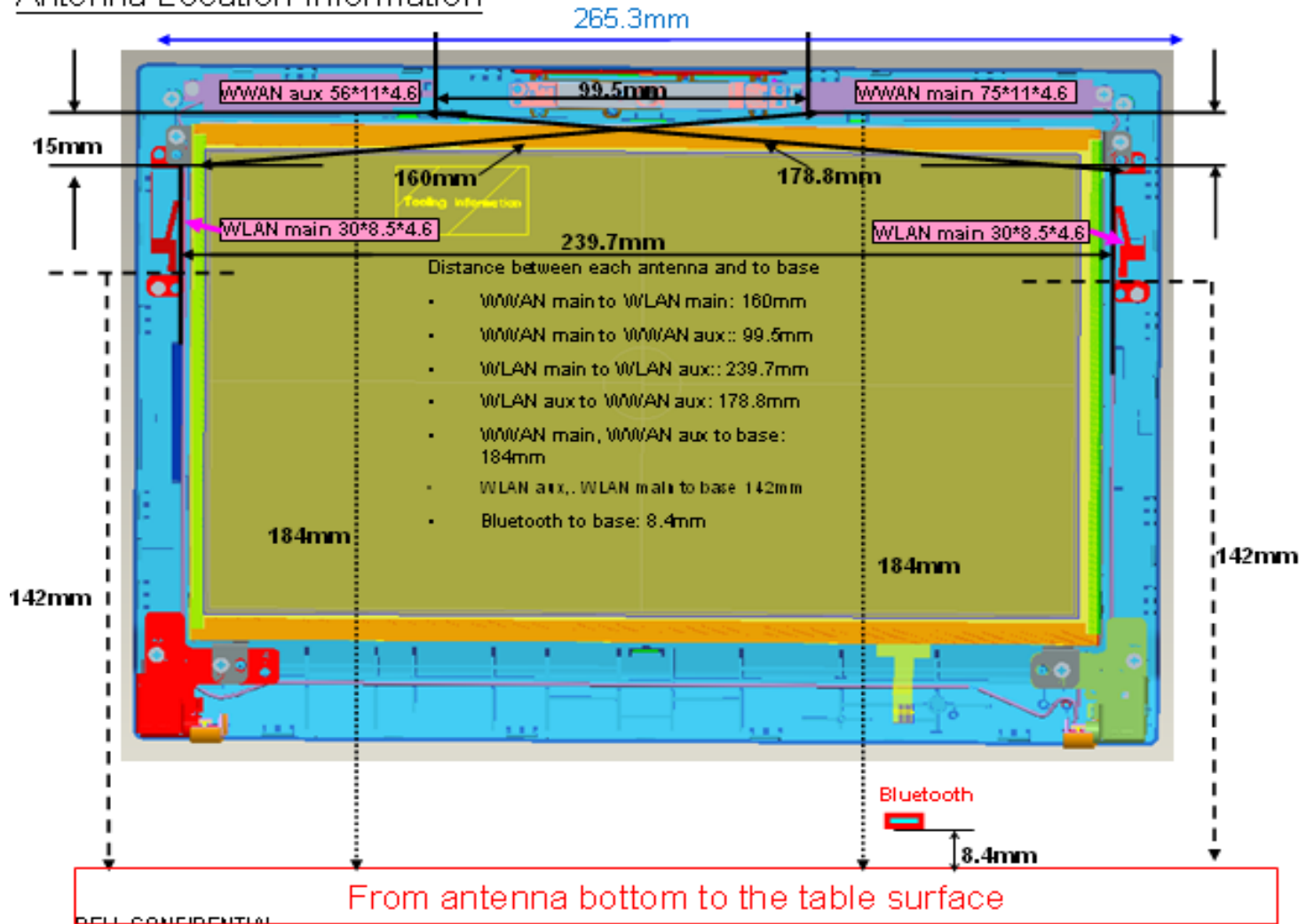

BELL CONFIDENTIAL

## Section 6. Antenna dimensional information for SAR evaluation

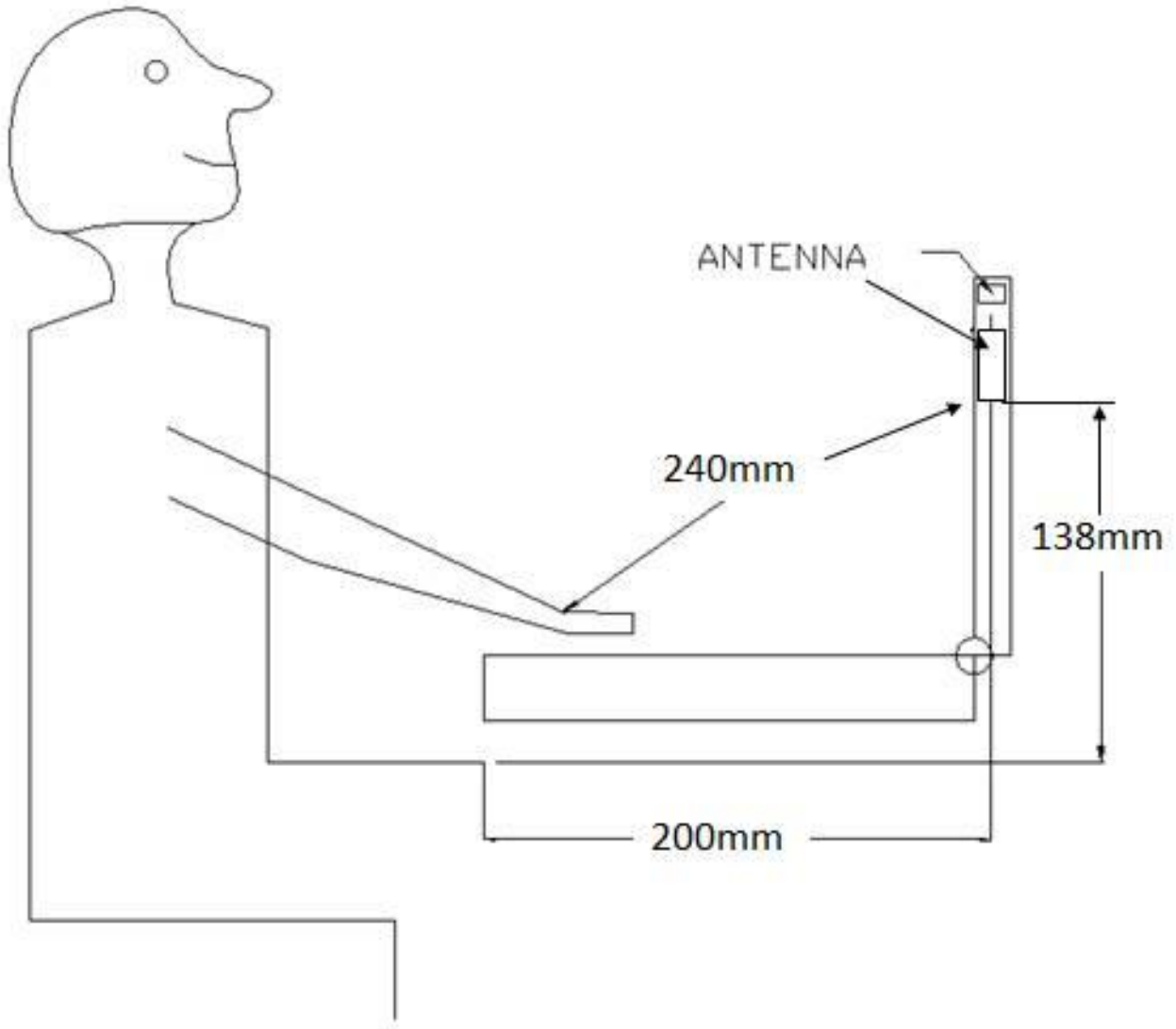



Antenna dimensional information

Please open the LCD lid to **90°** , which is perpendicular to the table surface.

Then do those measurements.

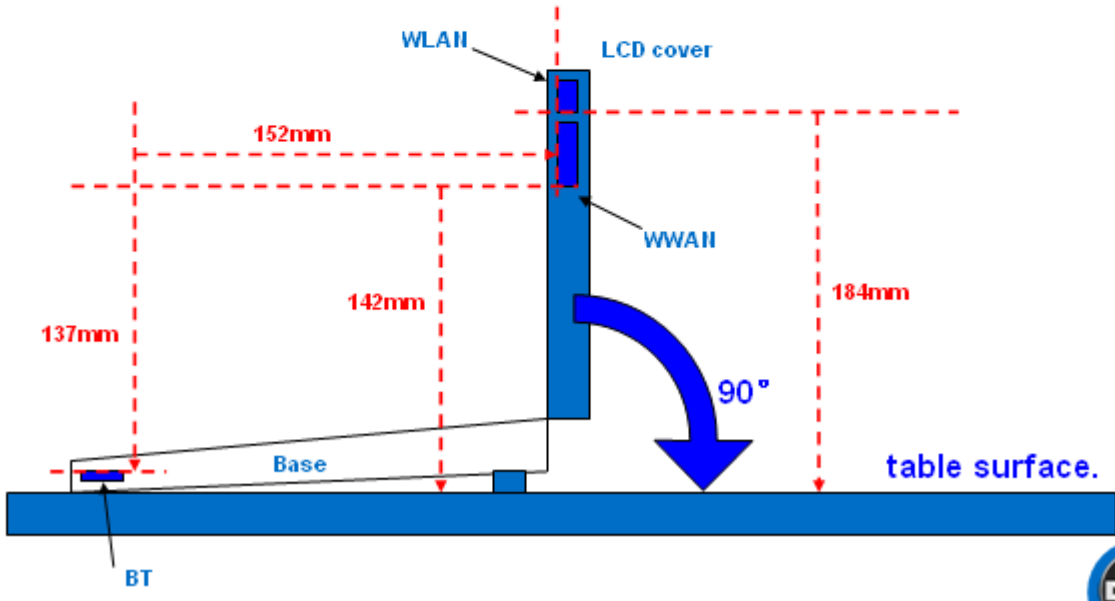

## Section 7. Diagram Example of Co-Location Antenna Separation



## Section 8. Local representative contact information

Local representative contact information is required for regulatory support for target countries below.

	Local company name	Contact name	Phone number	FAX Number	e-Mail Address	Notes
Argentina						
Brazil						
Indonesia						
Israel						
Malaysia						
Mexico						
Singapore						
South Africa						
USA, Canada						



