



**AEGIS LABS INC.**



Class II Permissive Change  
Test Report  
And Application for Grant of Equipment Authorization

Pertaining To:

EUT	FCC ID:
<b>Latitude   120L Notebook Computer, MN: PP21L</b>	<b>E2K5HCKT</b>

Configuration
<b>Tested with an Intel PRO/Wireless 2915ABG Network Connection, MN: WM3A2915ABG</b> With a set of Wistron NeWeb Corp. Antennas

*MEASUREMENTS PERFORMED IN ACCORDANCE WITH*

Regulatory Standard(s)
<b>47 CFR Part 15, Subpart E Section 15.407 (UNII Devices)</b>
Test Method: ANSI C63.4: 2003 American National Standard for Methods of Measurement of Radio-Noise Emissions from Low-Voltage Electrical and Electronic Equipment in the Range of 9 kHz to 40 GHz



Certificate Number: 1111.01

**APPLICANT:**

Dell Computer Corporation  
One Dell Way  
Round Rock, TX 78682

Contact(s): Mr. Jason Limoges

**PREPARED BY:**

Aegis Labs, Inc.  
22431 Antonio Parkway B160-417  
Rancho S. Margarita, CA 92688

Agent(s): Mr. Steve Kuiper  
Mr. Rick Candelas  
Mr. Johnny Candelas

Test Report #: INTEL-050916F  
Test Report Revision: None

	REPORT BODY	APPENDICES <i>A</i>	TOTAL PAGES
--	----------------	------------------------	----------------

The contents of this report shall not be reproduced except in full, without the written approval of Aegis Labs, Inc.

*Page 1 of 16  
Report Number: INTEL-050916F  
FCC ID: E2K5HCKT*



# TABLE OF CONTENTS

SECTION	TITLE	PAGE
	COVER SHEET.....	01
	TABLE OF CONTENTS.....	02
1.0	CERTIFICATION OF TEST DATA.....	03
2.0	SUMMARY OF TEST RESULTS.....	04
3.0	ADMINISTRATIVE DATA AND TEST DESCRIPTION.....	05
4.0	DESCRIPTION OF EUT.....	07
4.1	EUT Description.....	07
4.2	EUT Configuration.....	08
4.3	List of EUT Sub-Assemblies and Host Equipment.....	09
4.4	I/O Cabling Diagram and Description.....	10
5.0	TEST EQUIPMENT AND TEST SETUPS.....	11
5.1	AC Power Line Conducted Emissions.....	11
5.2	Spurious Radiated Emissions.....	12
5.3	Conducted Emissions At The Antenna Port.....	12
5.4	Test and Measurement Equipment Used.....	13
6.0	SAMPLE CALCULATIONS.....	14
7.0	MODIFICATIONS AND RECOMMENDATIONS.....	16

## APPENDICES

A	Test Data
---	-----------



AEGIS LABS INC.

## 1.0 CERTIFICATION OF TEST DATA

Aegis Labs, Inc. operates as both a Nevada and California Corporation with no organizational or financial relationship with any company, institution, or private individual.

Testing and engineering functions provided by Aegis Labs are furnished through the use of part-time, full-time or consulting engineers with the appropriate qualifications to carry out their duties. The intended purpose of this test report is to describe the measurement procedure and to determine whether the equipment under test "EUT" complies with both the conducted and radiated limits. Limits for emissions testing are described under Subpart E of Part 15 of the FCC rules for Unlicensed National Information Infrastructure (UNII) Devices.

The data, data evaluation and equipment configuration represented herein are a true and accurate representation of the Equipment Under Test (EUT) under the requirements specified in the emissions standard as described below. The test results contained in this report are only representative of the test sample tested as described in Section 3.0 of this report. Certification of the EUT is required as a prerequisite to marketing as defined in Part 2 of the FCC Rules.

### Prepared By:

**Johnny Candelas**  
Test Technician  
Aegis Labs, Inc.

10/06/05

Date:

### Reviewed By:

**Rick Candelas**  
Lab Manager  
Aegis Labs, Inc.

10/06/05

Date:

### Report Approved By:

**Steve J. Kuiper**  
Quality Assurance Manager  
Aegis Labs, Inc.

10/06/05

Date:

Page 3 of 16

Report Number: INTEL-050916F

FCC ID: E2K5HCKT



AEGIS LABS INC.

## 2.0 SUMMARY OF TEST RESULTS

The test results provided within this report, indicate that the EUT has been found to be in **COMPLIANCE** with the test specifications based upon the following RF compliance standards:

Pass/Fail determination is based upon the nominal values of the test data.

EMISSIONS STANDARD			
FCC Part 15 Section	Description	Results	Comments
<b>Operation in the 5.15-5.25 GHz Band</b>			
15.407(d)	Any UNII device shall use a transmitting antenna that is an integral part of the device.	PASSED	The antenna will be integral when installed in a notebook computer
15.407(e)	UNII devices will be restricted to indoor operations.	PASSED	Refer to "User's Manual" Exhibit
15.407(a)(1)	26dB emissions bandwidth in MHz.	N/A	5.18 GHz = 23.33 MHz
15.407(a)(1)	Peak transmit power shall not exceed the lesser of 50mW or 4dBm+10logB (where B = 26dB emissions bandwidth).	PASSED	5.18 GHz = 11.20 dBm (13.18 mW) 5.24 GHz = 11.00 dBm (12.59 mW)
15.407(a)(1)	The peak power spectral density shall not exceed 4dBm in any 1MHz band.	PASSED	5.18 GHz = -3.17 dBm
15.407(a)(1)	Peak transmit power and the peak power spectral density shall be reduced by the amount in dB that the transmitting antenna exceeds 6dBi.	N/A	All antennas tested have less than 6dBi antenna gain (Please see the antenna data sheets)
15.407(b)(5) / 15.209	Unwanted emissions below 1 GHz must comply with the general field strength limits set forth in Section 15.209.	PASSED	See Data Sheets
15.407(b)(1)	All emissions outside of the 5.15-5.35 GHz band shall not exceed an EIRP of -27dBm/MHz.	PASSED	See Data Sheets
<b>Operation in the 5.25-5.35 GHz Band</b>			
15.407(a)(2)	26dB emissions bandwidth in MHz.	N/A	5.26 GHz = 23.25 MHz 5.32 GHz = 23.33 MHz
15.407(a)(2)	Peak transmit power shall not exceed the lesser of 250mW or 11dBm+10logB (where B = 26dB emissions bandwidth).	PASSED	5.26 GHz = 15.90 dBm (38.90 mW) 5.32 GHz = 16.00 dBm (39.81 mW)
15.407(a)(2)	The peak power spectral density shall not exceed 11dBm in any 1MHz band.	PASSED	5.26 GHz = 2.00 dBm 5.32 GHz = 1.33 dBm
15.407(a)(2)	Peak transmit power and the peak power spectral density shall be reduced by the amount in dB that the transmitting antenna exceeds 6dBi.	N/A	All antennas tested have less than 6dBi antenna gain (Please see the antenna data sheets)
15.407(b)(5) / 15.209	Unwanted emissions below 1 GHz must comply with the general field strength limits set forth in Section 15.209.	PASSED	See Data Sheets
15.407(b)(2)	All emissions outside of the 5.15-5.35 GHz band shall not exceed an EIRP of -27dBm/MHz. Must meet all applicable technical requirements for operating in the 5.15-5.25 GHz band.	PASSED	See Data Sheets

Page 4 of 16

Report Number: INTEL-050916F

FCC ID: E2K5HCKT



AEGIS LABS INC.

## 2.0 SUMMARY OF TEST RESULTS (Continued)

EMISSIONS STANDARD			
FCC Part 15 Section	Description	Results	Comments
<b>General Requirements For All Bands</b>			
15.407(a)(6)	The ratio of the peak excursion of the modulation envelope to the peak transmit power shall not exceed 13dB across any 1 MHz bandwidth or the emissions bandwidth whichever is less.	PASSED	5.18 GHz = 6.34 dB 5.26 GHz = 6.17 dB 5.32 GHz = 5.83 dB
15.407(f)	Radio frequency radiation exposure requirement.	PASSED	Refer to MPE Calculations
15.407(b) / 15.207	UNII devices using AC power line are required to comply with the conducted limits set forth in Section 15.207.	PASSED	See Data Sheets

Page 5 of 16  
Report Number: INTEL-050916F  
FCC ID: E2K5HCKT



AEGIS LABS INC.

### 3.0 ADMINISTRATIVE DATA AND TEST DESCRIPTION

<b>DEVICE TESTED:</b>	ITE Type: Latitude   120L Notebook Computer Model Number(s): PP21L Serial Number: 814D90100952900173KS00 FCC ID: E2K5HCKT
<b>TEST DATE (S):</b>	September 14 - 20, 2005
<b>DATE EUT RECEIVED:</b>	September 12, 2005
<b>ORIGIN OF TEST SAMPLE(S):</b>	Production Unit
<b>RESPONSIBLE PARTY:</b>	Dell Computer Corporation One Dell Way Round Rock, TX 78682
<b>CLIENT CONTACT:</b>	Mr. Jason Limoges
<b>MANUFACTURER:</b>	Dell Computer Corporation
<b>TEST LOCATION:</b>	Aegis Labs, Inc. 32231 Trabuco Creek Road Trabuco Canyon, CA 92678 Conducted Site #2 Radiated Site #2
<b>A2LA CERTIFICATE:</b>	1111.01, Valid through February 28, 2006
<b>PURPOSE OF TEST:</b>	To demonstrate compliance with the relevant standards described in Section 2.0 of this report.
<b>TEST(S) PERFORMED:</b>	Refer to Table in Section 2.0 of this report.

All calibration vendors were responsible for certifying Aegis Labs, Inc. test equipment as per the manufacturer's specifications and that the equipment is calibrated using instruments and standards where the accuracy is traceable to the National Institute of Standards and Technology (NIST). Calibration of all test equipment conforms to ANSI/NCSL Z540-1 and ISO 10012-1 and/or ISO/IEC Guide 17025 compliance (Additionally, other pertinent test equipment will carry MIL-STD-45662A). All calibration documents are on file with Aegis Labs, Inc., with copies provided upon request.

Page 6 of 16  
Report Number: INTEL-050916F  
FCC ID: E2K5HCKT



#### 4.0 DESCRIPTION OF EUT

##### 4.1 EUT Description

Equipment Under Test (EUT)	
<b>Trade Name:</b>	Latitude   120L Notebook Computer
<b>Model Number:</b>	PP21L tested with an Intel PRO/Wireless 2915ABG Network Connection, MN: WM3A2915ABG
<b>Frequency Range:</b>	5.15-5.35 GHz
<b>Enclosure:</b>	The EUT contains it's own shield made of aluminum approximately 3.5cm wide by 3.5cm deep by 2mm high.
<b>Transfer Rate:</b>	6/36/52 Mbps
<b>Antenna Type:</b>	<u>Wistron NeWeb Corp.:</u> PIFA (Main/Aux)
<b>Antenna Gain (See Note 2):</b>	<u>Wistron NeWeb Corp.:</u> 5 GHz = 0.34 (Main), 0.01 (Aux) dBi
<b>Transmit Output Power:</b>	11.50 dBm (Typical) for 5.15-5.25 GHz 15.90 dBm (Typical) for 5.25-5.35 GHz Please see Appendix A (Data Sheets) for actual output power.
<b>Power Supply:</b>	3.3VDC from computer MPCIE slot.
<b>Number of External Test Ports Exercised:</b>	2 Antenna Ports (1 Main & 1 Auxiliary)

The Latitude | 120L Notebook Computer was tested with an Intel PRO/Wireless 2915ABG Network Connection as an embedded 2.4 GHz Wireless Local Area Network Mini-PCI adapter. The Mini-PCI Type 3A form factor is designed for notebook computer systems where overall thickness must be kept to an absolute minimum and connect to antennas internal to the notebook computer. It is capable of a data rate of up to 52 Mbps.

**NOTE 1:** For a more detailed description, please refer to the manufacture's specifications or User's Manual.

**NOTE 2:** Refer to the antenna specifications for a further description of the antennas. Antennas will be professionally installed inside the laptop computer by the laptop vendor.



AEGIS LABS INC.

## 4.2 EUT Configuration

The EUT was tested with an Intel PRO/Wireless 2915ABG Network Connection installed in its mini PCI slot and was connected to a set of Wistron NeWeb Corp. triple band antennas via its main and auxiliary antenna ports. Data can be found in Appendix A.

For conducted emissions at the AC mains port and radiated emissions, the EUT was connected to a Dell monitor and Logitech mouse via its video and USB ports respectively.

The low, middle, and high channels were tested in 802.11a, b, & g modes. Also, the EUT was tested once transmitting from the MAIN antenna port and once transmitting from the AUX antenna port. The EUT was placed in either continuous transmit or continuous receive mode by a program provided by the manufacturer (*CRTU Version 3.2.15.0000*).





AEGIS LABS INC.

#### 4.3 List of EUT, Sub-Assemblies, and Host Equipment

<b>LIST OF EUT AND SUB-ASSEMBLIES</b>			
<b>Equipment Name</b>	<b>Manufacturer</b>	<b>Model Number</b>	<b>Serial Number</b>
Latitude   120L Notebook Computer	Dell Computer Corporation	PP21L	814D90100952 900173KS00
<b>EUT Sub-Assemblies</b>			
Intel PRO/Wireless 2915ABG Network Connection	Intel Corporation	WM3A2915ABG	MY-0C6952- 12462-4A7-00YL
Auxiliary Triple Band Antenna	Wistron NeWeb Corp.	EBU-A	N/A
Main Triple Band Antenna	Wistron NeWeb Corp.	EBU-A	N/A

<b>HOST EQUIPMENT LIST</b>			
<b>Equipment Name</b>	<b>Manufacturer</b>	<b>Model Number</b>	<b>Serial Number</b>
Monitor	Compaq	610	712BC060B526
Mouse	Logitech	Y-BF37	MCTZ5200581
Keyboard	Logitech	M-BJ58	PMA32715049

NOTE: All the power cords of the above support equipment are standard non-shielded, 1.8 meters long.

Page 9 of 16  
Report Number: INTEL-050916F  
FCC ID: E2K5HCKT



#### 4.4 I/O Cabling Diagram and Description

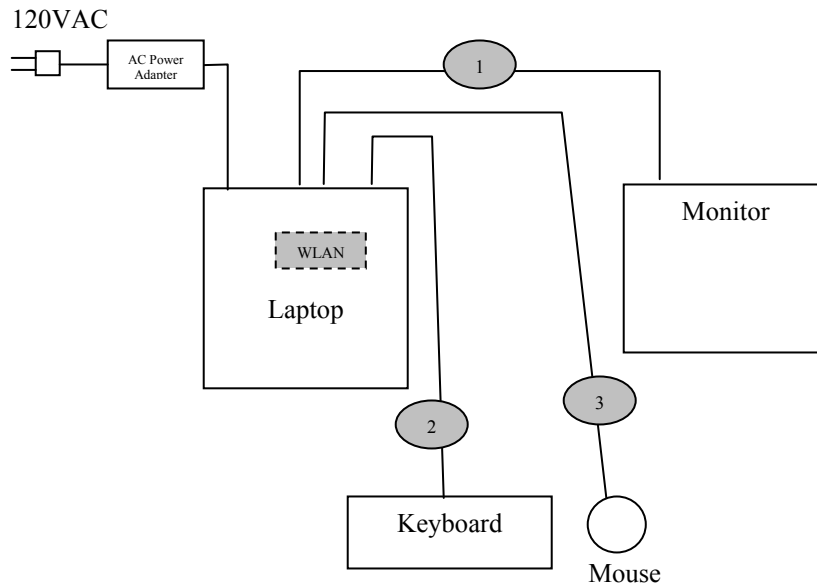

- Cable 1: This is a 6-foot braid and foil shielded round cable connecting the host computer with the monitor. It has metallic DB-15 type connector at the computer end and is hardwired to the monitor. The cable is bundled to a length of one meter and the shield of the cable is grounded to the chassis of both devices via the connector shells.
- Cable 2: This is a 6-foot braid and foil shielded round cable connecting the host computer to the keyboard. It has a metallic 6-pin mini din type connector at the computer end and is hardwired to the keyboard. The shield of the cable is grounded to the chassis of the computer via the connector shell.
- Cable 3: This is a 6-foot braid and foil shielded round cable connecting the host computer to the mouse. It has a metallic 6-pin mini din type connector at the computer end and is hardwired to the mouse. The shield of the cable is grounded to the chassis of the computer via the connector shell.



AEGIS LABS INC.

## 5.0 TEST EQUIPMENT AND TEST SETUPS

The test equipment settings and functions are selected using the guidance of ANSI C63.4-2003. All test equipment setups and operations during conducted and radiated emissions testing are in accordance with this reference document.

### 5.1 AC Power Line Conducted Emissions

During conducted emissions measurements, a spectrum analyzer was used as the measuring instrument along with a preselector and quasi-peak detector. A 10 dB attenuation pad was used for the protection of the spectrum analyzer input stage. The conducted emissions from the EUT in the frequency range from 150 kHz to 30 MHz were captured for graphical display through the use of automated LABVIEW EMI measurement software. All graphical readings were measured in the “Peak” mode only to reduce testing time. Upon completion of the graphical scan, the test lab personnel performed the conducted measurement scan manually using the spectrum analyzer front panel keys. All peak measurements coming within 3 dB of the limit line were “Averaged” and/or “Quasi-Peaked” and denoted appropriately in the EXCEL spreadsheet.

The Equipment Under Test (EUT) was configured as a system with peripherals connected, so that at least one interface port of each type is connected to one external peripheral when tested for conducted emissions according to ANSI C63.4: 2003. Excess power cord length was wrapped in a bundle 30 to 40 centimeters in length near the center of the cord. The EUT was tested in a tabletop configuration.

The emission readings for Line 1 and Line 2 are highlighted on the data sheets in Appendix A. The graphical scans only reflect peak readings while the tabulated data sheets reflect peak, average, and/or quasi-peak readings which ever applies.



AEGIS LABS INC.

## 5.2 Spurious Radiated Emissions

A spectrum analyzer was used as the measuring instrumentation along with a preselector and quasi-peak-detector. The pre-amplifiers were used to increase the sensitivity of the instrument. The spectrum analyzer was used in the peak detector mode with the “max-hold” feature activated and in Positive Peak mode. In this mode, the spectrum analyzer records the highest measured reading over all the sweeps. The quasi-peak detector was used only for those readings, which are marked accordingly in the data sheet. The effective measurement bandwidth used for the radiated emissions test was 120 kHz for (30 MHz- 1000 MHz). The spectrum analyzer operated such that the modulation of the signal was filtered out to set the analyzer in linear mode. For testing beyond 1000 MHz a spectrum analyzer capable of taking reading above 1000 MHz was connected to the high frequency amplifier, where these measurement readings were taken with the transducer placed at a 3-meter test distance from the EUT.

The Open Area Test Sites (OATS) was used for radiated emission testing. These test sites are designed according to ANSI C63.4: 2003 and ANSI C63.7: 1992 guidelines. The Measurements were conducted in accordance with ANSI C63.4: 2003 and ANSI C63.7: 1992 requirements.

Broadband biconical, log periodic, and horn antennas were used as transducers during the measurement reading phase. The frequency spans were wide (30 MHz-88 MHz, 88 MHz- 216 MHz, 216 MHz- 300 MHz, and 300 MHz- 1000 MHz). After 1000 MHz the horn antenna was used to measure emissions. The emission readings in both horizontal and vertical polarities are highlighted on the data sheets in Appendix A.

## 5.3 Conducted Emissions at the Antenna Port

A spectrum analyzer or power meter was used as the measuring instrumentation along with an attenuator and/or filter connected to the EUT antenna port. The attenuator and filters are used to ensure that the front end of the measurement instrument is not overloaded by the fundamental transmission. . The instruments recorded the measured readings with the bandwidths (video and resolution) set in accordance with the FCC Rules and regulations.

The measured readings are on the data sheets in Appendix A.

*Page 12 of 16*  
*Report Number: INTEL-050916F*  
*FCC ID: E2K5HCKT*



AEGIS LABS INC.

#### 5.4 Test and Measurement Equipment Used

TEST EQUIPMENT USED					
Equipment Name	Manufacturer	Model Number	Serial Number	Calibration Due Date	Calibration Cycle
Spectrum Analyzer	Agilent	8564EC	4046A00387	08/15/06	1 Year
Preamp	Aegis Preamplifier	Aegis-Oats1-1-18	001	07/27/06	1 Year
2.4 GHz Notch Filter	Micro-Tronics	BRM50702-02	003	04/21/06	1 Year
5.15-5.35 GHz Notch Filter	Microwave Circuits	N0452502	3173-01	06/27/06	1 Year
5.725-5.850 GHz Notch Filter	Microwave Circuits	N0257881	3173-01	06/27/06	1 Year
Horn Antenna	EMCO	3115	2230	02/06/06	1 Year
Antenna - 18-26.5 GHz Pre-amplified Horn	Aegis Labs, Inc.	H042	SLK-35-3W	11/04/05	1 Year
Antenna - 26.5-40 GHz Pre-amplified Horn	Aegis Labs, Inc.	H028	GM1260-10	11/04/05	1 Year
Cable	Semflex	60637	S1L29BFS1348	04/11/06	1 Year
Temperature/Humidity Monitor	Dickson	TH550	7255185	N/A	N/A
Power Meter	Anritsu	ML2487A	6K00001785	04/12/06	1 Year
Wide Bandwidth Sensor	Anritsu	MA2491A	31193	04/12/06	1 Year
12dB Attenuator	Narda	4779-12	203	08/06/06	1 Year
Antenna - Biconical	EMCO	3110	9108-1421	05/17/06	1 Year
Antenna - Log Periodic	EMCO	3148	4947	05/11/06	1 Year
LISN (EUT)	FCC	FCC-LISN-50-25-2	9931	02/06/06	1 Year
LISN (Access)	Com-Power	LI-200	12019	07/05/07	1 Year
LISN (Access)	Com-Power	LI-200	12018	07/05/07	1 Year

Page 13 of 16  
Report Number: INTEL-050916F  
FCC ID: E2K5HCKT



## 6.0 SAMPLE CALCULATIONS

If a preamplifier is used during the Radiated Emissions Testing, it is required that the amplifier gain be subtracted from the Spectrum Analyzer (Meter) Reading. In addition, a correction factor for the antenna, cable and a distance factor, if any, must be applied to the Meter Reading before a true field strength reading can be obtained. In the Automatic Mode of A.R.M.S. measurements, these considerations are automatically presented as a part of the printout. In the case of manual measurements and for greater efficiency and convenience, usage of the calibration correction factors in the Appendices is necessary to calculate the Corrected Meter Reading. These correlation factors for each meter reading, shall be modified to reflect these correlation factors at each frequency value so that the meter readings can be compared directly to the modified specification limit. This modified specification limit is referred to as the “Corrected Meter Reading Limit” (CML).

The equation shall be derived in the following manner:

$$\text{Corrected Meter Reading} = \text{Meter Reading} + F + C - G - D$$

Where, F = Antenna Factor

C = Cable Factor

G = Amplifier Gain

D = Distance Factor

Therefore, the equation for determining the Corrected Meter Reading Limit (CML) is:

$$\text{CML} = \text{Specification Limit} - F - C + G + D$$

For the manual mode of measurement, a table of corrected meter reading limits shall be used to permit immediate comparison of the meter reading to determine if the measured emission amplitude exceeded the specification limit at that specific frequency. There shall be two calculation sheets done, one for three meter and one for ten-meter measurement distances, where applicable. The correction factors for the antenna and the amplifier gain are attached in the Appendices.



AEGIS LABS INC.

## 6.0 Sample Calculations (Continued)

### Peak Transmit Power Output:

A correction factor for the cable must be applied to the Conducted Power before a true power reading can be obtained. This is referred to as the “Corrected Power” (CP).

The equation shall be derived in the following manner:

$$\text{Corrected Power Reading} = \text{Conducted Power Reading} + C$$

Where, C = Cable Factor

The conducted power is taken in units of dBm. To obtain units of mW the following equation is used:

$$\text{mW} = 10^{(\text{dBm}/10)}$$



**AEGIS LABS INC.**

## **7.0 MODIFICATIONS AND RECOMMENDATIONS**

No modifications were made to the EUT.

*Page 16 of 16*  
*Report Number: INTEL-050916F*  
*FCC ID: E2K5HCKT*





**AEGIS LABS** INC.

## **APPENDIX A**

### ***TEST DATA***

*Page 1 of 37 (Appendix A)*  
*Report Number: INTEL-050916F*  
*FCC ID: E2K5HCKT*



AEGIS LABS INC.

## AC POWER LINE CONDUCTED EMISSIONS TEST RESULTS

<b>CLIENT:</b>	Dell Computer Corporation	<b>DATE:</b>	09/20/05
<b>EUT:</b>	Latitude   120L Notebook Computer	<b>PROJECT NUMBER:</b>	INTEL-050914
<b>MODEL NUMBER:</b>	PP21L	<b>TEST ENGINEER:</b>	JC
<b>SERIAL NUMBER:</b>	814D90100952900173KS00	<b>SITE #:</b>	2
<b>CONFIGURATION:</b>	Tested with an Intel PRO/Wireless 2915ABG Network Connection installed in its mini PCI slot and connected to a set of <b>Wistron NeWeb Corp.</b> antennas.	<b>TEMPERATURE:</b>	21 C
		<b>HUMIDITY:</b>	49% RH
		<b>TIME:</b>	3:45 PM

<b>Standard:</b>	FCC CFR 47, Part 15.207
<b>Description:</b>	AC Power Line Conducted Emissions
<b>Results:</b>	Passes the conducted limits by -1.19 @ 0.220 MHz

Conducted Limits		
Frequency (MHz)	Quasi-Peak Limit (dBuV)	Average Limit (dBuV)
0.15-0.5	66 to 56*	56 to 46*
0.5-5	56	46
5-30	60	50

\*Decreases with the logarithm of the frequency.

NOTE: During preliminary scans, there wasn't any difference which channel or data rate was used with the EUT; therefore only Channel 1 at a data rate of 1 Mbps was used for final testing. Also, the scan was only done with the Wistron NeWeb Corp. set of antennas.

Page 2 of 37 (Appendix A)  
Report Number: INTEL-050916F  
FCC ID: E2K5HCKT



# AC Power Line Conducted Emissions Test Results (Continued)

AEGIS LABS INC.

CONDUCTED EMISSIONS – LINE 1						
Freq. (MHz)	Meter Reading (dBuV)	Detector (PK/QP/AV)	Average Limit (dBuV)	Average Delta (dB)	Quasi-Peak Limit (dBuV)	Quasi-Peak Delta (dB)
0.1500	57.89	PK	56.00	1.89	66.00	-8.11
0.1500	27.99	AV	56.00	-28.01	66.00	-38.01
0.1600	59.55	PK	55.71	3.84	65.71	-6.16
0.1600	23.85	AV	55.71	-31.86	65.71	-41.86
0.1900	52.83	PK	54.86	-2.03	64.86	-12.03
0.2000	51.05	PK	54.57	-3.52	64.57	-13.52
0.2100	49.31	PK	54.29	-4.98	64.29	-14.98
0.2200	50.41	PK	54.00	-3.59	64.00	-13.59

 14:33:58 SEP 20, 2005  
 14:52:53 APR 14, 2003 11:58:46 SEP 23, 2004  
 ACTV DET: PEAK  
 MEAS DET: PEAK QP AVG  
 MKR 160 kHz  
 59.55 dBuV



RBW = 100 kHz, VBW = 100 kHz



AC Power Line Conducted Emissions Test Results (Continued)

AEGIS LABS INC.

CONDUCTED EMISSIONS - LINE 2						
Freq. (MHz)	Meter Reading (dBuV)	Detector (PK/QP/AV)	Average Limit (dBuV)	Average Delta (dB)	Quasi-Peak Limit (dBuV)	Quasi-Peak Delta (dB)
0.1700	59.66	PK	55.43	4.23	65.43	-5.77
0.1700	42.07	AV	55.43	-13.36	65.43	-23.36
0.1800	52.92	PK	55.14	-2.22	65.14	-12.22
0.2000	52.50	PK	54.57	-2.07	64.57	-12.07
0.2200	52.81	PK	54.00	-1.19	64.00	-11.19
0.2300	49.52	PK	53.71	-4.19	63.71	-14.19
0.2500	47.63	PK	53.14	-5.51	63.14	-15.51

 14:44:20 SEP 20, 2005  
 14:52:53 APR 14, 2003 11:58:46 SEP 23, 2004  
 ACTV DET: PEAK  
 MEAS DET: PEAK QP AVG  
 MKR 170 kHz  
 59.66 dBuV



RBW = 100 kHz, VBW = 100 kHz



AEGIS LABS INC.

## SPURIOUS RADIATED EMISSIONS TEST RESULTS

<b>CLIENT:</b>	Dell Computer Corporation	<b>DATE:</b>	09/20/05
<b>EUT:</b>	Latitude   120L Notebook Computer	<b>PROJECT NUMBER:</b>	INTEL-050914
<b>MODEL NUMBER:</b>	PP21L	<b>TEST ENGINEER:</b>	JC
<b>SERIAL NUMBER:</b>	814D90100952900173KS00	<b>SITE #:</b>	2
<b>CONFIGURATION:</b>	Tested with an Intel PRO/Wireless 2915ABG Network Connection installed in its mini PCI slot and connected to a set of Wistron NeWeb Corp. antennas.	<b>TEMPERATURE:</b>	25 C
		<b>HUMIDITY:</b>	49% RH
		<b>TIME:</b>	10:45 AM

<b>Standard:</b>	FCC Pt. 15.209
<b>Description:</b>	Unwanted emissions below 1 GHz must comply with the general field strength limits set forth in Sec. 15.209.
<b>Results:</b>	Passes the radiated limits by -6.45@ 49.88 MHz (Vertical antenna polarization)

Radiated Limits	
Frequency (MHz)	Quasi-Peak Limit (dBuV) @ 10m
30-88	40
88-216	43.5
216-960	46
960-1000	54

NOTE 1: During preliminary scans, there wasn't any difference which channel or data rate was used with the EUT; therefore only Channel 1 at a data rate of 1 Mbps was used for final testing. Also, the scan was only done with the Wistron NeWeb Corp. set of antennas.

NOTE 2: RBW/VBW = 1 MHz

Page 5 of 37 (Appendix A)  
Report Number: INTEL-050916F  
FCC ID: E2K5HCKT



Spurious Radiated Emissions Test Results (Continued)

**RADIATED EMISSIONS - Horizontal Antenna Polarization**

Freq. (MHz)	Meter Reading (dBuV)	Antenna Height (cm)	Azimuth (degrees)	Peak, Quasi pk or AVG (dBuV)		Preamp Factor (dB)	Cable Factor (dB)	Ant. Factor (dB)	10 Meter Distance Factor (dB)	Corrected Reading (dBuV)	Limits (dBuV)	Diff (dB) +/-FAIL
49.84	6.71	400	135				1.10	11.86	10.46	30.13	40.00	-9.87
84.03	10.70	400	135				1.44	7.33	10.46	29.93	40.00	-10.07
117.19	9.73	400	180				1.77	12.81	10.46	34.77	43.50	-8.73
162.51	5.60	400	225				2.02	15.60	10.46	28.08	43.50	-15.42
250.01	10.75	400	135				2.80	17.50	10.46	30.76	46.00	-15.24
300.00	7.87	300	270				2.90	13.50	10.46	34.73	46.00	-11.27
375.04	7.52	300	135				3.35	14.80	10.46	36.13	46.00	-9.87
399.96	7.01	300	180				3.50	14.90	10.46	35.87	46.00	-10.13
437.50	6.98	250	135				3.65	15.65	10.46	36.74	46.00	-9.26

**RADIATED EMISSIONS - Vertical Antenna Polarization**

Freq. (MHz)	Meter Reading (dBuV)	Antenna Height (cm)	Azimuth (degrees)	Peak, Quasi pk or AVG (dBuV)		Preamp Factor (dB)	Cable Factor (dB)	Ant. Factor (dB)	10 Meter Distance Factor (dB)	Corrected Reading (dBuV)	Limits (dBuV)	Diff (dB) +/-FAIL
49.88	11.45	100	135				1.10	10.54	10.46	33.55	40.00	-6.45
117.16	7.22	100	180				1.77	11.67	10.46	31.13	43.50	-12.37
162.47	6.43	100	135				2.02	14.64	10.46	33.55	43.50	-9.95
250.03	7.28	100	225	6.06	Q		2.80	18.50	10.46	37.82	46.00	-8.18
300.02	8.46	100	135				2.90	14.50	10.46	27.86	46.00	-18.14
353.83	8.02	100	270				3.22	15.25	10.46	36.96	46.00	-9.04
375.03	5.89	100	315				3.35	16.10	10.46	35.80	46.00	-10.20
384.99	8.15	100	315				3.41	15.82	10.46	37.84	46.00	-8.16

NOTE: The measurements were taken at 10 meters and extrapolated to 3 meters.

NOTE 2: The measurements are Peak readings unless otherwise specified.



AEGIS LABS INC.

## Spurious Radiated Emissions Test Results (Continued)

<b>CLIENT:</b>	Dell Computer Corporation	<b>DATE:</b>	09/15/05
<b>EUT:</b>	Latitude   120L Notebook Computer	<b>PROJECT NUMBER:</b>	INTEL-050914
<b>MODEL NUMBER:</b>	PP21L	<b>TEST ENGINEER:</b>	JC/BM
<b>SERIAL NUMBER:</b>	814D90100952900173KS00	<b>SITE #:</b>	2
<b>CONFIGURATION:</b>	Tested with an Intel PRO/Wireless 2915ABG Network Connection installed in its mini PCI slot and connected to a set of <b>Wistron NeWeb Corp.</b> antennas in <b>802.11a (5150-5350 MHz) mode.</b>	<b>TEMPERATURE:</b>	22 C
		<b>HUMIDITY:</b>	50% RH
		<b>TIME:</b>	7:00 PM

<b>Standard:</b>	FCC CFR 47, Part 15.407(b)(6)
<b>Description:</b>	The provisions of Sec. 15.205 apply to intentional radiators operating under this section.
<b>Results:</b>	Passes (See Data Sheets)

### Unwanted Spurious Emissions Limits

Frequency (MHz)	Field Strength (uV/m)	Field Strength (dBuV/m) (Emissions in the restricted bands)	Field Strength (dBm/MHz) (Emissions outside the restricted bands)
Above 960	500	54.00 (Average) 74.00 (Peak)	EIRP < -27dBm/MHz (68.3dBuV/m)

Page 7 of 37 (Appendix A)  
Report Number: INTEL-050916F  
FCC ID: E2K5HCKT



Spurious Radiated Emissions Test Results (Continued)

*Fundamental Measurements in 802.11a mode (5150-5350 MHz)  
Channels 36, 51, 52, & 64  
Continuous TX at MAIN Antenna port with Wistron NeWeb Corp. Antennas  
Aegis Labs, Inc. File #: INTEL-050914-06*

RADIATED EMISSIONS - Horizontal Antenna Polarization										
Freq. (MHz)	Meter Reading (dBuV)	Antenna Height (cm)	Azimuth (degrees)	Quasi pk or AVG (dBuV)		Preamp Factor (dB)	Cable Factor (dB)	Ant. Factor (dB)	Corrected Reading (dBuV)	Note
5180.00	60.83	100	225				4.51	34.77	100.11	<b>Ch. 36</b>
5180.00				49.67	A		4.51	34.77	88.95	
5240.00	60.33	100	225				4.53	34.80	99.66	<b>Ch. 51</b>
5240.00				49.25	A		4.53	34.80	88.58	
5260.00	64.50	100	225				4.54	34.80	103.84	<b>Ch. 52</b>
5260.00				53.56	A		4.54	34.80	92.90	
5320.00	60.83	100	225				4.56	34.83	100.22	<b>Ch. 64</b>
5320.00				50.13	A		4.56	34.83	89.52	

RADIATED EMISSIONS - Vertical Antenna Polarization										
Freq. (MHz)	Meter Reading (dBuV)	Antenna Height (cm)	Azimuth (degrees)	Quasi pk or AVG (dBuV)		Preamp Factor (dB)	Cable Factor (dB)	Ant. Factor (dB)	Corrected Reading (dBuV)	Note
5180.00	57.67	100	225				4.51	34.64	96.81	<b>Ch. 36</b>
5180.00				46.12	A		4.51	34.64	85.26	
5240.00	58.50	100	225				4.53	34.65	97.68	<b>Ch. 51</b>
5240.00				47.59	A		4.53	34.65	86.77	
5260.00	63.67	100	90				4.54	34.65	102.86	<b>Ch. 52</b>
5260.00				52.49	A		4.54	34.65	91.68	
5320.00	60.17	100	135				4.56	34.66	99.40	<b>Ch. 64</b>
5320.00				49.43	A		4.56	34.66	88.66	

NOTE: Fundamental signals measured to calculate the band edge field strengths using the “Marker Delta Method”.





Spurious Radiated Emissions Test Results (Continued)

*Band Edge Field Strength Calculations in 802.11a mode (5150-5350 MHz)  
Channels 36 & 64  
Continuous TX at MAIN Antenna port with Wistron NeWeb Corp. Antennas  
Aegis Labs, Inc. File #: INTEL-050914-06*

**RADIATED EMISSIONS - Horizontal Antenna Polarization**

Freq. (MHz)	Meter Reading (dBuV)	Antenna Height (cm)	Azimuth (degrees)	Quasi pk or AVG (dBuV)	Preamp Factor (dB)	Cable Factor (dB)	Ant. Factor (dB)	Corrected Reading (dBuV)	Limits (dBuV)	Diff (dB) +=FAIL	Note
5150.00								46.77	74.00	-27.23	Ch. 36
5150.00				A				34.62	54.00	-19.38	
5140.00								49.11	74.00	-24.89	
5140.00				A				35.62	54.00	-18.38	
5350.00								54.72	74.00	-19.28	Ch. 64
5350.00				A				36.02	54.00	-17.98	
5400.00								51.72	74.00	-22.28	
5400.00				A				38.52	54.00	-15.48	

**RADIATED EMISSIONS - Vertical Antenna Polarization**

Freq. (MHz)	Meter Reading (dBuV)	Antenna Height (cm)	Azimuth (degrees)	Quasi pk or AVG (dBuV)	Preamp Factor (dB)	Cable Factor (dB)	Ant. Factor (dB)	Corrected Reading (dBuV)	Limits (dBuV)	Diff (dB) +=FAIL	Note
5150.00								43.47	74.00	-30.53	Ch. 36
5150.00				A				30.93	54.00	-23.07	
5140.00								45.81	74.00	-28.19	
5140.00				A				31.93	54.00	-22.07	
5350.00								53.90	74.00	-20.10	Ch. 64
5350.00				A				35.16	54.00	-18.84	
5400.00								50.90	74.00	-23.10	
5400.00				A				37.66	54.00	-16.34	

NOTE: The “Band Edge Field Strength” was calculated using the “Fundamental” and “Conducted Band Edge” measurements per the “Marker-Delta Method” with the following formula:

$$BE = F_m - \Delta m$$

Where

BE = Band Edge Field Strength

F<sub>m</sub> = Measured Fundamental (Peak or Average)

Δ<sub>m</sub> = Measured Conducted Band Edge Delta (Peak or Average)







AEGIS LABS INC.

Spurious Radiated Emissions Test Results (Continued)

*Spurious Emissions Measurements in 802.11a mode (5150-5350 MHz)*  
*Channels 36, 52, & 64*  
*Continuous TX at MAIN Antenna port with Wistron NeWeb Corp. Antennas*  
*Aegis Labs, Inc. File #: INTEL-050914-08*

**RADIATED EMISSIONS - Horizontal Antenna Polarization**

<i>Freq. (MHz)</i>	<i>Meter Reading (dBuV)</i>	<i>Antenna Height (cm)</i>	<i>Azimuth (degrees)</i>	<i>Quasi pk or AVG (dBuV)</i>	<i>Preamp Factor (dB)</i>	<i>Cable Factor (dB)</i>	<i>Ant. Factor (dB)</i>	<i>Corrected Reading (dBuV)</i>	<i>Limits (dBuV)</i>	<i>Diff (dB) +=FAIL</i>	<i>Note</i>	
3453.29	55.17	100	135			50.72	3.64	31.50	39.58	68.00	-28.42	Ch. 36
6906.54	58.83	100	180			50.41	5.21	36.78	50.41	68.00	-17.59	
10360.01	52.67	100	135			50.05	6.48	38.60	47.70	68.00	-20.30	
13813.36	54.83	100	135			51.63	7.56	41.68	52.44	68.00	-15.56	
3506.72	58.50	100	135			50.71	3.66	31.62	43.07	68.00	-24.93	Ch. 52
7013.26	59.50	100	180			50.34	5.26	37.09	51.50	68.00	-16.50	
10519.88	55.67	100	135			50.05	6.55	38.61	50.78	68.00	-17.22	
14026.62	56.67	100	135			51.70	7.60	42.17	54.74	68.00	-13.26	
3546.66	56.83	100	135			50.70	3.69	31.72	41.54	68.00	-26.46	Ch. 64
7093.33	56.00	100	135			50.27	5.29	37.01	48.02	68.00	-19.98	
10639.98	55.00	100	135			50.07	6.58	38.68	50.20	74.00	-23.80	
10639.98				42.94	A	50.07	6.58	38.68	38.14	54.00	-15.86	
14186.58	55.17	100	135			51.74	7.65	41.98	53.06	68.00	-14.94	

*Page 12 of 37 (Appendix A)*  
*Report Number: INTEL-050916F*  
*FCC ID: E2K5HCKT*



AEGIS LABS INC.

## Spurious Radiated Emissions Test Results (Continued)

<b>RADIATED EMISSIONS – Vertical Antenna Polarization</b>												
<i>Freq. (MHz)</i>	<i>Meter Reading (dBuV)</i>	<i>Antenna Height (cm)</i>	<i>Azimuth (degrees)</i>	<i>Quasi pk or AVG (dBuV)</i>		<i>Preamp Factor (dB)</i>	<i>Cable Factor (dB)</i>	<i>Ant. Factor (dB)</i>	<i>Corrected Reading (dBuV)</i>	<i>Limits (dBuV)</i>	<i>Diff (dB) +=FAIL</i>	<i>Note</i>
3453.29	56.67	100	45			50.72	3.64	31.52	41.10	68.00	-26.90	<b>Ch. 36</b>
6906.59	59.33	100	135			50.41	5.21	36.62	50.75	68.00	-17.25	
10359.93	54.00	100	135			50.05	6.48	38.80	49.23	68.00	-18.77	
3506.67	56.50	100	90			50.71	3.66	31.62	41.07	68.00	-26.93	<b>Ch. 52</b>
7013.32	58.50	100	225			50.34	5.26	36.89	50.31	68.00	-17.69	
10519.92	55.17	100	135			50.05	6.55	38.82	50.48	68.00	-17.52	
3546.66	56.50	100	45			50.70	3.69	31.72	41.21	68.00	-26.79	<b>Ch. 64</b>
7093.33	56.67	100	135			50.27	5.29	36.84	48.53	68.00	-19.47	
10639.98	54.50	100	135			50.07	6.58	38.91	49.92	74.00	-24.08	
10639.98				42.65	A	50.07	6.58	38.91	38.07	54.00	-15.93	

Page 13 of 37 (Appendix A)  
Report Number: INTEL-050916F  
FCC ID: E2K5HCKT



AEGIS LABS INC.

Spurious Radiated Emissions Test Results (Continued)

*Spurious Emissions Measurements in 802.11a mode (5150-5350 MHz)  
Channels 36, 52, & 64  
Continuous RX at MAIN Antenna port with Wistron NeWeb Corp. Antennas  
Aegis Labs, Inc. File #: INTEL-050914-08*

RADIATED EMISSIONS – Horizontal Antenna Polarization												
Freq. (MHz)	Meter Reading (dBuV)	Antenna Height (cm)	Azimuth (degrees)	Quasi pk or AVG (dBuV)		Preamp Factor (dB)	Cable Factor (dB)	Ant. Factor (dB)	Corrected Reading (dBuV)	Limits (dBuV)	Diff (dB) +=FAIL	Note
3453.31	58.33	100	135			50.72	3.64	31.50	42.74	80.00	-37.26	Ch. 36
3453.31				48.04	A	50.72	3.64	31.50	32.45	60.00	-27.55	
6906.66	56.33	100	135			50.41	5.21	36.78	47.91	80.00	-32.09	
6906.66				44.19	A	50.41	5.21	36.78	35.77	60.00	-24.23	
10359.95	44.00	100	135			50.05	6.48	38.60	39.03	80.00	-40.97	
10359.95				31.32	A	50.05	6.48	38.60	26.35	60.00	-33.65	
13813.25	55.67	100	135			51.63	7.56	41.68	53.28	80.00	-26.72	
13813.25				43.01	A	51.63	7.56	41.68	40.62	60.00	-19.38	
3506.66	58.00	100	135			50.71	3.66	31.62	42.57	80.00	-37.43	Ch. 52
3506.66				48.56	A	50.71	3.66	31.62	33.13	60.00	-26.87	
7013.33	56.00	100	135			50.34	5.26	37.09	48.00	80.00	-32.00	
7013.33				43.88	A	50.34	5.26	37.09	35.88	60.00	-24.12	
10519.94	54.83	100	135			50.05	6.55	38.61	49.94	80.00	-30.06	
10519.94				42.01	A	50.05	6.55	38.61	37.12	60.00	-22.88	
14026.53	57.33	100	135			51.70	7.60	42.17	55.40	80.00	-24.60	
14026.53				44.17	A	51.70	7.60	42.17	42.24	60.00	-17.76	
3546.72	58.67	100	135			50.70	3.69	31.72	43.38	80.00	-36.62	Ch. 64
3546.72				48.52	A	50.70	3.69	31.72	33.23	60.00	-26.77	
7093.27	55.00	100	270			50.27	5.29	37.01	47.02	80.00	-32.98	
7093.27				43.10	A	50.27	5.29	37.01	35.12	60.00	-24.88	
10639.92	54.33	100	135			50.07	6.58	38.68	49.53	80.00	-30.47	
10639.92				42.12	A	50.07	6.58	38.68	37.32	60.00	-22.68	
14186.64	55.67	100	135			51.74	7.65	41.98	53.56	80.00	-26.44	
14186.64				43.10	A	51.74	7.65	41.98	40.99	60.00	-19.01	



AEGIS LABS INC.

Spurious Radiated Emissions Test Results (Continued)

<b>RADIATED EMISSIONS – Vertical Antenna Polarization</b>												
<i>Freq. (MHz)</i>	<i>Meter Reading (dBuV)</i>	<i>Antenna Height (cm)</i>	<i>Azimuth (degrees)</i>	<i>Quasi pk or AVG (dBuV)</i>		<i>Preamp Factor (dB)</i>	<i>Cable Factor (dB)</i>	<i>Ant. Factor (dB)</i>	<i>Corrected Reading (dBuV)</i>	<i>Limits (dBuV)</i>	<i>Diff (dB) +=FAIL</i>	<i>Note</i>
3453.30	57.17	100	315			50.72	3.64	31.52	41.60	80.00	-38.40	<b>Ch. 36</b>
3453.30				45.67	A	50.72	3.64	31.52	30.10	60.00	-29.90	
6906.67	56.17	100	135			50.41	5.21	36.62	47.59	80.00	-32.41	
6906.67				45.99	A	50.41	5.21	36.62	37.41	60.00	-22.59	
10360.00	52.83	100	135			50.05	6.48	38.80	48.06	80.00	-31.94	
10360.00				39.90	A	50.05	6.48	38.80	35.13	60.00	-24.87	
3506.68	55.67	100	135			50.71	3.66	31.62	40.24	80.00	-39.76	<b>Ch. 52</b>
3506.68				44.84	A	50.71	3.66	31.62	29.41	60.00	-30.59	
7013.36	58.17	100	270			50.34	5.26	36.89	49.98	80.00	-30.02	
7013.36				51.18	A	50.34	5.26	36.89	42.99	60.00	-17.01	
10519.95	54.00	100	135			50.05	6.55	38.82	49.31	80.00	-30.69	
10519.95				40.83	A	50.05	6.55	38.82	36.14	60.00	-23.86	
3546.66	58.50	100	45			50.70	3.69	31.72	43.21	80.00	-36.79	<b>Ch. 64</b>
3546.66				48.44	A	50.70	3.69	31.72	33.15	60.00	-26.85	
7093.33	57.00	100	270			50.27	5.29	36.84	48.86	80.00	-31.14	
7093.33				49.67	A	50.27	5.29	36.84	41.53	60.00	-18.47	
10639.97	54.17	100	135			50.07	6.58	38.91	49.59	80.00	-30.41	
10639.97				41.29	A	50.07	6.58	38.91	36.71	60.00	-23.29	

Page 15 of 37 (Appendix A)  
 Report Number: INTEL-050916F  
 FCC ID: E2K5HCKT



AEGIS LABS INC.

## PEAK TRANSMIT POWER

<b>CLIENT:</b>	Dell Computer Corporation	<b>DATE:</b>	09/14/05
<b>EUT:</b>	Latitude   120L Notebook Computer	<b>PROJECT NUMBER:</b>	INTEL-050914
<b>MODEL NUMBER:</b>	PP21L	<b>TEST ENGINEER:</b>	JC
<b>SERIAL NUMBER:</b>	814D90100952900173KS00	<b>SITE #:</b>	2
<b>CONFIGURATION:</b>	Tested with an Intel PRO/Wireless 2915ABG Network Connection installed in its mini PCI slot.	<b>TEMPERATURE:</b>	22 C
		<b>HUMIDITY:</b>	42% RH
		<b>TIME:</b>	9:30 AM

<b>Standard:</b>	FCC CFR 47, Part 15.407(a)(1) & 15.407(a)(2)
<b>Description:</b>	For the band 5.15-5.25 GHz, the peak transmit power over the frequency band of operation shall not exceed the lesser of 50 mW or 4 dBm + 10logB, where B is the 26-dB emission bandwidth in MHz.  For the band 5.25-5.35 GHz, the peak transmit power over the frequency band of operation shall not exceed the lesser of 250 mW or 11 dBm + 10logB, where B is the 26-dB emission bandwidth in MHz.
<b>Results:</b>	See Data Sheet

Peak Transmit Power Limits		
Frequency (MHz)	Output Power (mW)	Output Power (Note 1)
5150-5250	50 (17 dBm)	4 dBm + 10logB = 17.68 dBm @ 5180 MHz
5250-5350	250 (24 dBm)	11 dBm + 10logB = 24.66 dBm @ 5260 MHz 11 dBm + 10logB = 24.68 dBm @ 5320 MHz

Note 1: Calculated using the 26-dB emissions bandwidth measurements.

Page 16 of 37 (Appendix A)  
Report Number: INTEL-050916F  
FCC ID: E2K5HCKT





Peak Transmit Power (Continued)

Mode	Channel	Frequency (MHz)	Rate (Mbps)	Average Power (dBm)	Average Power (mW)	Peak Power (dBm)	Peak Power (mW)
802.11a	36	5180	6	8.12	6.49	11.20	13.18
802.11a	51	5240	6	8.82	7.62	11.00	12.59
802.11a	52	5260	6	14.03	25.29	15.90	38.90
802.11a	64	5320	6	14.44	27.80	16.00	39.81

Note: Power was measured conducted.



AEGIS LABS INC.

### CONDUCTED BAND EDGE EMISSIONS TEST RESULTS

<b>CLIENT:</b>	Dell Computer Corporation	<b>DATE:</b>	09/15/05
<b>EUT:</b>	Latitude   120L Notebook Computer	<b>PROJECT NUMBER:</b>	INTEL-050914
<b>MODEL NUMBER:</b>	PP21L	<b>TEST ENGINEER:</b>	JC
<b>SERIAL NUMBER:</b>	814D90100952900173KS00	<b>SITE #:</b>	2
<b>CONFIGURATION:</b>	Tested with an Intel PRO/Wireless 2915ABG Network Connection installed in its mini PCI slot.	<b>TEMPERATURE:</b>	15 C
		<b>HUMIDITY:</b>	49% RH
		<b>TIME:</b>	8:25 AM

<b>Standard:</b>	FCC CFR 47, Part 15.407(b)(2)
<b>Description:</b>	For transmitters operating in the 5.25-5.35 GHz band: all emissions outside of the 5.15-5.35 GHz band shall not exceed an EIRP of -27 dBm/MHz. Devices operating in the 5.25-5.35 GHz band that generate emissions in the 5.15-5.25 GHz band must meet all applicable technical requirements for operation in the 5.15-5.25 GHz band (including indoor use) or alternatively meet an out-of-band emission EIRP limit of -27 dBm/MHz in the 5.15-5.25 GHz band.
<b>Results:</b>	Passes (See Data Sheets)

Unwanted Spurious Emissions Limits	
Frequency (MHz)	Field Strength (dBm/MHz) (Emissions outside the restricted bands)
5250-5350	EIRP < -27dBm/MHz (68.3dBuV/m)

<i>Freq. (MHz)</i>	<i>Power Spec Den. Reading (dBm/MHz)</i>	<i>Antenna Gain (dBi)</i>	<i>Corrected Reading (dBm/MHz)</i>	<i>Limits (dBm/MHz)</i>	<i>Diff (dB) +=FAIL</i>	<i>Comments</i>
With Wistron NeWeb Corp. Antennas						
5250.00	-64.90	0.34	-64.56	-27.00	-37.56	Tx @ 5240 MHz
5250.00	-59.60	0.34	-59.26	-27.00	-32.26	Tx @ 5260 MHz

Page 18 of 37 (Appendix A)  
 Report Number: INTEL-050916F  
 FCC ID: E2K5HCKT





AEGIS LABS INC.

## 26-dB EMISSIONS BANDWIDTH

<b>CLIENT:</b>	Dell Computer Corporation	<b>DATE:</b>	09/15/05
<b>EUT:</b>	Latitude   120L Notebook Computer	<b>PROJECT NUMBER:</b>	INTEL-050914
<b>MODEL NUMBER:</b>	PP21L	<b>TEST ENGINEER:</b>	JC
<b>SERIAL NUMBER:</b>	814D90100952900173KS00	<b>SITE #:</b>	2
<b>CONFIGURATION:</b>	Tested with an Intel PRO/Wireless 2915ABG Network Connection installed in its mini PCI slot.	<b>TEMPERATURE:</b>	15 C
		<b>HUMIDITY:</b>	49% RH
		<b>TIME:</b>	8:25 AM

<b>Standard:</b>	FCC CFR 47, Part 15.407(a)(1) & 15.407(a)(2)
<b>Description:</b>	26-dB emission bandwidth in MHz
<b>Results:</b>	See Data Sheets

*Page 20 of 37 (Appendix A)  
Report Number: INTEL-050916F  
FCC ID: E2K5HCKT*







AEGIS LABS INC.

## PEAK POWER SPECTRAL DENSITY

<b>CLIENT:</b>	Dell Computer Corporation	<b>DATE:</b>	09/15/05
<b>EUT:</b>	Latitude   120L Notebook Computer	<b>PROJECT NUMBER:</b>	INTEL-050914
<b>MODEL NUMBER:</b>	PP21L	<b>TEST ENGINEER:</b>	JC
<b>SERIAL NUMBER:</b>	814D90100952900173KS00	<b>SITE #:</b>	2
<b>CONFIGURATION:</b>	Tested with an Intel PRO/Wireless 2915ABG Network Connection installed in its mini PCI slot.	<b>TEMPERATURE:</b>	15 C
		<b>HUMIDITY:</b>	49% RH
		<b>TIME:</b>	8:25 AM

<b>Standard:</b>	FCC CFR 47, Part 15.407(a)(1) & 15.407(a)(2)
<b>Description:</b>	For the band 5.15-5.25 GHz, the peak power spectral density shall not exceed 4 dBm in any 1-MHz band
	For the band 5.2 5-5.35 GHz, the peak power spectral density shall not exceed 11 dBm in any 1-MHz band
<b>Results:</b>	See Data Sheets

Peak Power Spectral Density Limits	
Frequency (MHz)	Limit (dBm)
5150-5250	4
5250-5350	11

Page 23 of 37 (Appendix A)  
Report Number: INTEL-050916F  
FCC ID: E2K5HCKT

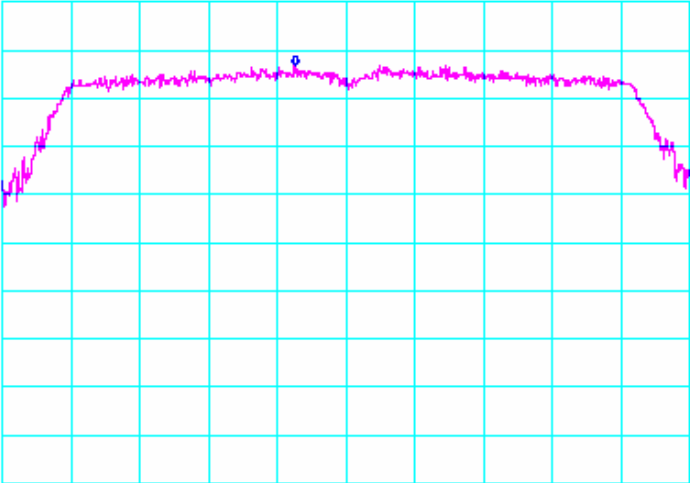
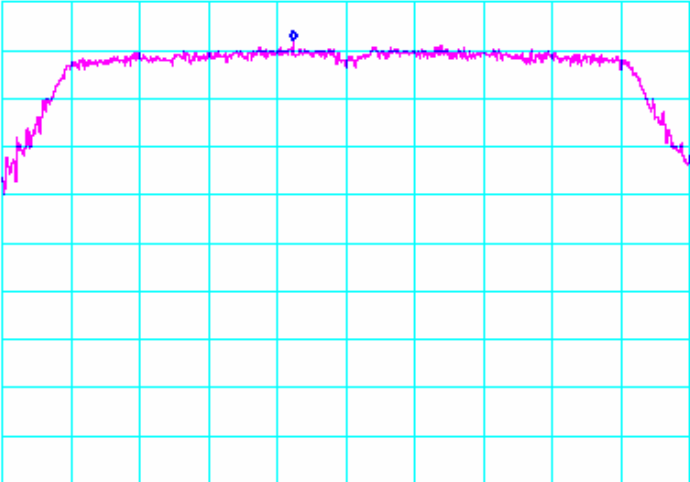

Peak Power Spectral Density (Continued)

Test Date	Data	Test Eng.
09/15/05	5.18 GHz (INTEL-050914-04a1)	JC
<p>*ATTEN 20dB    VAUG 100    MKR -3.17dBm RL 10.0dBm    10dB/    5.17853GHz</p>  <p>CENTER 5.18000GHz    SPAN 20.00MHz *RBW 1.0MHz    *VBW 3.0MHz    SWP 50.0ms</p>		
Test Date	Data	Test Eng.
09/15/05	5.26 GHz (INTEL-050914-04a3)	JC
<p>*ATTEN 20dB    VAUG 100    MKR 2.00dBm RL 10.0dBm    10dB/    5.25847GHz</p>  <p>CENTER 5.26000GHz    SPAN 20.00MHz *RBW 1.0MHz    *VBW 3.0MHz    SWP 50.0ms</p>		





AEGIS LABS INC.

### Peak Power Spectral Density (Continued)

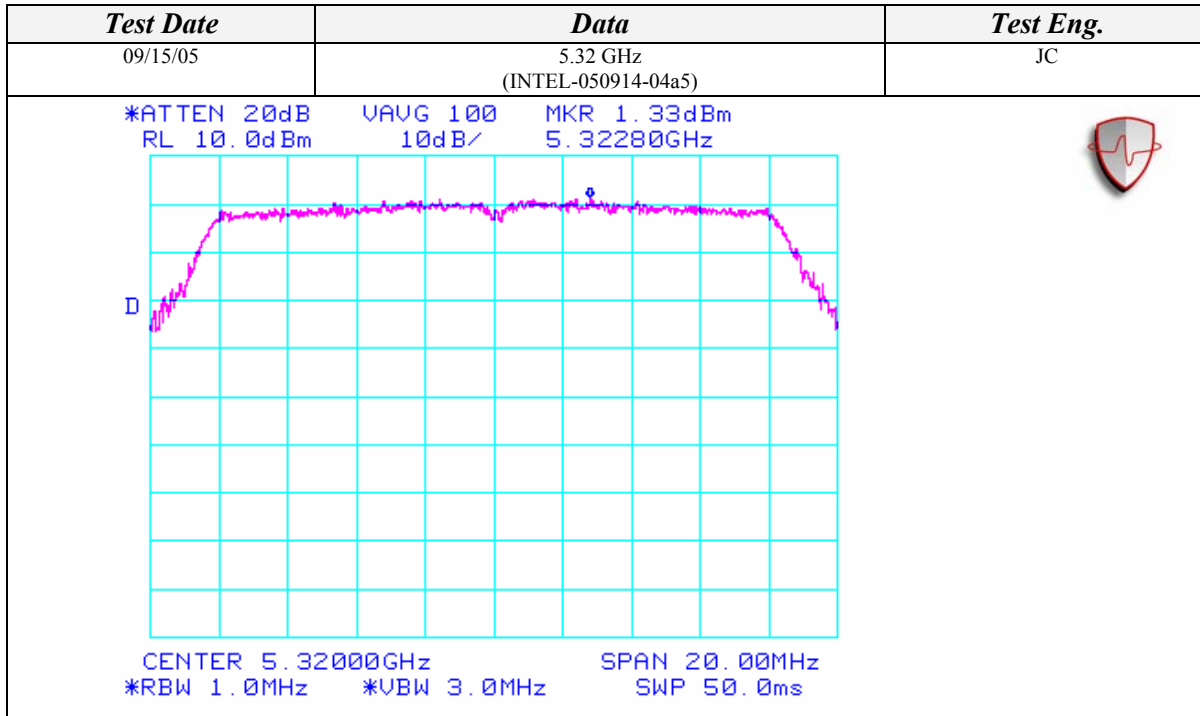

Page 25 of 37 (Appendix A)  
Report Number: INTEL-050916F  
FCC ID: E2K5HCKT



AEGIS LABS INC.

## PEAK EXCURSION

<b>CLIENT:</b>	Dell Computer Corporation	<b>DATE:</b>	09/15/05
<b>EUT:</b>	Latitude   120L Notebook Computer	<b>PROJECT NUMBER:</b>	INTEL-050914
<b>MODEL NUMBER:</b>	PP21L	<b>TEST ENGINEER:</b>	JC
<b>SERIAL NUMBER:</b>	814D90100952900173KS00	<b>SITE #:</b>	2
<b>CONFIGURATION:</b>	Tested with an Intel PRO/Wireless 2915ABG Network Connection installed in its mini PCI slot.	<b>TEMPERATURE:</b>	15 C
		<b>HUMIDITY:</b>	49% RH
		<b>TIME:</b>	8:25 AM

<b>Standard:</b>	FCC CFR 47, Part 15.407(a)(6)
<b>Description:</b>	The ratio of the peak excursion of the modulation envelope (measured using a peak hold function) to the peak transmit power shall not exceed 13 dB across any 1 MHz bandwidth or the emission bandwidth whichever is less.
<b>Results:</b>	See Data Sheets

Peak Excursion Limits	
Frequency (MHz)	Limit (dB)
5150-5350	13

Page 26 of 37 (Appendix A)  
Report Number: INTEL-050916F  
FCC ID: E2K5HCKT





AEGIS LABS INC.

### Peak Excursion (Continued)

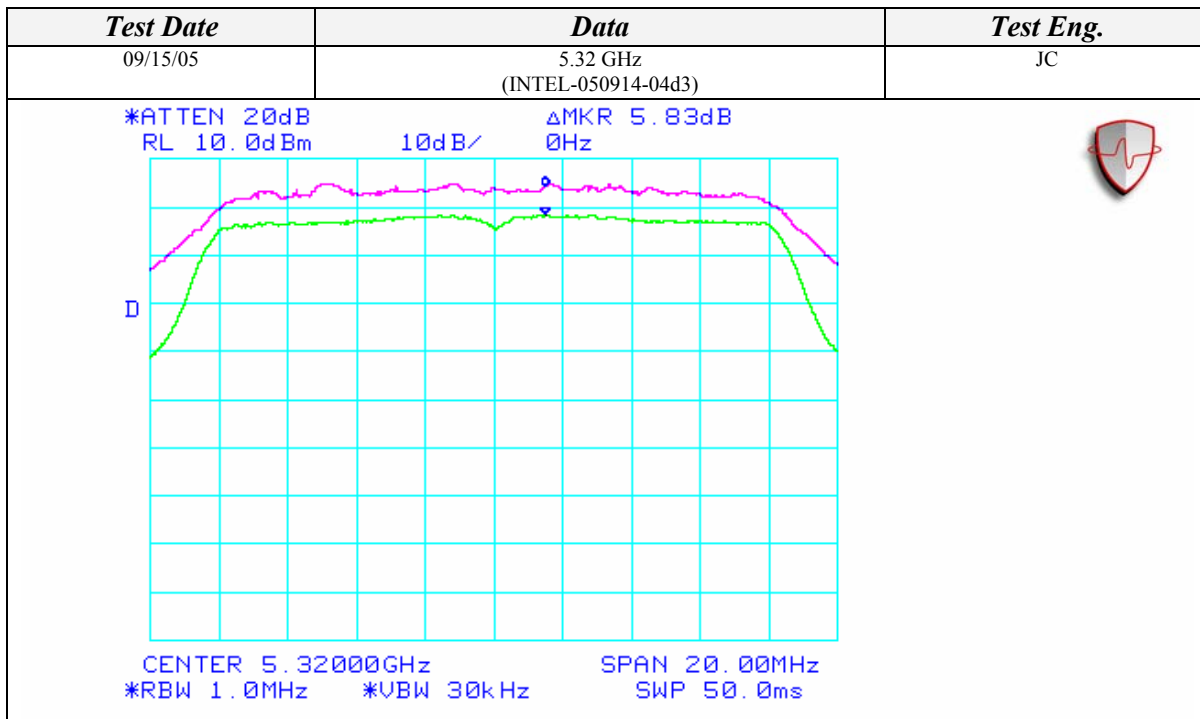

Page 28 of 37 (Appendix A)  
 Report Number: INTEL-050916F  
 FCC ID: E2K5HCKT



AEGIS LABS INC.

## CONDUCTED OUT OF BAND EMISSIONS

<b>CLIENT:</b>	Dell Computer Corporation	<b>DATE:</b>	09/15/05
<b>EUT:</b>	Latitude   120L Notebook Computer	<b>PROJECT NUMBER:</b>	INTEL-050914
<b>MODEL NUMBER:</b>	PP21L	<b>TEST ENGINEER:</b>	JC
<b>SERIAL NUMBER:</b>	814D90100952900173KS00	<b>SITE #:</b>	2
<b>CONFIGURATION:</b>	Tested with an Intel PRO/Wireless 2915ABG Network Connection installed in its mini PCI.	<b>TEMPERATURE:</b>	15 C
		<b>HUMIDITY:</b>	49% RH
		<b>TIME:</b>	8:25 AM

<b>Standard:</b>	FCC CFR 47, Part 15.407(b)(1) and 15.407(b)(2)
<b>Description:</b>	For transmitters operating in the 5.15-5.25 GHz band: all emissions outside of the 5.15-5.35 GHz band shall not exceed an EIRP of -27 dBm/MHz.
	For transmitters operating in the 5.25-5.35 GHz band: all emissions outside of the 5.15-5.35 GHz band shall not exceed an EIRP of -27 dBm/MHz. Devices operating in the 5.25-5.35 GHz band that generate emissions in the 5.15-5.25 GHz band must meet all applicable technical requirements for operation in the 5.15-5.25 GHz band (including indoor use) or alternatively meet an out-of-band emission EIRP limit of -27 dBm/MHz in the 5.15-5.25 GHz band.

Page 29 of 37 (Appendix A)  
Report Number: INTEL-050916F  
FCC ID: E2K5HCKT



















AEGIS LABS INC.

Conducted Out Of Band Emissions (Continued)

