



FCC 47 CFR PART 15 SUBPART C

TEST REPORT

For

Notebook PC with RFID transmitter

Regulatory Model: PP08X

Regulatory Type: PP08X001

Trade Name: DELL

Issued to

**Dell Computer Corporation
ONE DELL WAY, ROUND ROCK, TEXAS 78682, U.S.A.**

Issued by

**Compliance Certification Services Inc.
No. 81-1, Lane 210, Pa-De 2nd Rd., Luchu Hsiang,
Taoyuan Shien, (338) Taiwan, R.O.C.
TEL: 886-3-324-0332
FAX: 886-3-324-5235
<http://www.ccsrf.com>
service@ccsrf.com**



Note: This report shall not be reproduced except in full, without the written approval of Compliance Certification Services Inc. This document may be altered or revised by Compliance Certification Services Inc. personnel only, and shall be noted in the revision section of the document.



Revision History

Rev.	Issue Date	Revisions	Effect Page	Revised By
00	August 12, 2009	Initial Issue	ALL	Celine Chou



TABLE OF CONTENTS

- 1. TEST RESULT CERTIFICATION.....4**
- 2. EUT DESCRIPTION.....5**
- 3. TEST METHODOLOGY.....6**
 - 3.1 EUT CONFIGURATION.....6
 - 3.2 EUT EXERCISE.....6
 - 3.3 GENERAL TEST PROCEDURES.....6
 - 3.4 FCC PART 15.205 RESTRICTED BANDS OF OPERATIONS.....7
 - 3.5 DESCRIPTION OF TEST MODES.....7
- 4. INSTRUMENT CALIBRATION.....8**
 - 4.1 MEASURING INSTRUMENT CALIBRATION.....8
 - 4.2 MEASUREMENT EQUIPMENT USED.....8
- 5. FACILITIES AND ACCREDITATIONS.....9**
 - 5.1 FACILITIES.....9
 - 5.2 EQUIPMENT.....9
 - 5.3 TABLE OF ACCREDITATIONS AND LISTINGS.....10
- 6. SETUP OF EQUIPMENT UNDER TEST.....11**
 - 6.1 SETUP CONFIGURATION OF EUT.....11
 - 6.2 SUPPORT EQUIPMENT.....11
- 7. FCC PART 15.225 REQUIREMENTS.....12**
 - 7.1 RADIATED EMISSIONS.....12
 - 7.2.1 FREQUENCY STABILITY.....16
 - 7.2 POWERLINE CONDUCTED EMISSIONS.....18
- APPENDIX I PHOTOGRAPHS OF TEST SETUP.....21**



1. TEST RESULT CERTIFICATION

Applicant: Dell Computer Corporation
ONE DELL WAY, ROUND ROCK, TEXAS 78682, U.S.A.

Equipment Under Test: Notebook PC with RFID transmitter

Trade Name: DELL

Regulatory Model: PP08X

Regulatory Type: PP08X001

Date of Test: July 29 ~ August 11, 2009

APPLICABLE STANDARDS	
STANDARD	TEST RESULT
FCC 47 CFR Part 15 Subpart C	No non-compliance noted

We hereby certify that:

The above equipment was tested by Compliance Certification Services Inc. The test data, data evaluation, test procedures, and equipment configurations shown in this report were made in accordance with the procedures given in ANSI C63.4: 2003 and the energy emitted by the sample tested as described in this report is in compliance with the requirements of FCC Rules Part 15.225.

The test results of this report relate only to the tested sample identified in this report.

Approved by:

David Wang
Director
Compliance Certification Services Inc.

Reviewed by:

Ethan Huang
Section Manager
Compliance Certification Services Inc.



2. EUT DESCRIPTION

Product	Notebook PC with RFID transmitter		
Trade Name	DELL		
Regulatory Model	PP08X		
Regulatory Type	PP08X001		
Model Difference	N/A		
EUT Power Rating	19.5VDC, 12.3A; 19.5VDC, 10.8A		
Power Adapter Manufacturer	Delta	Model	GA240PE1-00 (Dell/ PA-9E)
			DA210PE1-00 (Dell/ PA-7E)
	Flextronics	Model	GA240PE1-00 (Dell/ PA-9E)
Power Adapter Power Rating	For Delta / GA240PE1-00; Flextronics / GA240PE1-00 I/P: 100-240VAC, 50-60Hz, 3.5A O/P: 19.5VDC, 12.3A For Delta / DA210PE1-00 I/P: 100-240VAC, 50-60Hz, 3.2A O/P: 19.5VDC, 10.8A		
Frequency Range	13.56MHz		
Modulation Technique	ASK		
Transmit Power	43.81dBuV		
Number of Channels	1 Channel		
Antenna Specification	Loop Antenna		

Remark:

1. The sample selected for test was engineering sample that approximated to production product and was provided by manufacturer.
2. This submittal(s) (test report) is intended for FCC ID: **E2K5880-PP08X001** filing to comply with Section 15.225 of the FCC Part 15, Subpart C Rules.



3. TEST METHODOLOGY

The tests documented in this report were performed in accordance with ANSI C63.4: 2003 and FCC CFR 47 Part 2, 15.207, 15.209 and 15.225.

3.1 EUT CONFIGURATION

The EUT configuration for testing is installed on RF field strength measurement to meet the Commissions requirement and operating in a manner that intends to maximize its emission characteristics in a continuous normal application.

3.2 EUT EXERCISE

The EUT was operated in the engineering mode to fix the TX frequency that was for the purpose of the measurements.

3.3 GENERAL TEST PROCEDURES

Conducted Emissions

The EUT is placed on the turntable, which is 0.8 m above ground plane. According to the requirements in Section 13.1.4.1 of ANSI C63.4: 2003. Conducted emissions from the EUT measured in the frequency range between 0.15 MHz and 30MHz using CISPR Quasi-peak and average detector modes.

Radiated Emissions

The EUT is placed on a turn table, which is 0.8 m above ground plane. The turntable shall rotate 360 degrees to determine the position of maximum emission level. EUT is set 3m away from the receiving antenna, which varied from 1m to 4m to find out the highest emission. And also, each emission was to be maximized by changing the polarization of receiving antenna both horizontal and vertical. In order to find out the maximum emissions, exploratory radiated emission measurements were made according to the requirements in Section 13.1.4.1 of ANSI C63.4: 2003.



3.4 FCC PART 15.205 RESTRICTED BANDS OF OPERATIONS

(a) Except as shown in paragraph (d) of this section, only spurious emissions are permitted in any of the frequency bands listed below:

MHz	MHz	MHz	GHz
0.090 - 0.110	16.42 - 16.423	399.9 - 410	4.5 - 5.15
¹ 0.495 - 0.505	16.69475 - 16.69525	608 - 614	5.35 - 5.46
2.1735 - 2.1905	16.80425 - 16.80475	960 - 1240	7.25 - 7.75
4.125 - 4.128	25.5 - 25.67	1300 - 1427	8.025 - 8.5
4.17725 - 4.17775	37.5 - 38.25	1435 - 1626.5	9.0 - 9.2
4.20725 - 4.20775	73 - 74.6	1645.5 - 1646.5	9.3 - 9.5
6.215 - 6.218	74.8 - 75.2	1660 - 1710	10.6 - 12.7
6.26775 - 6.26825	108 - 121.94	1718.8 - 1722.2	13.25 - 13.4
6.31175 - 6.31225	123 - 138	2200 - 2300	14.47 - 14.5
8.291 - 8.294	149.9 - 150.05	2310 - 2390	15.35 - 16.2
8.362 - 8.366	156.52475 -	2483.5 - 2500	17.7 - 21.4
8.37625 - 8.38675	156.52525	2655 - 2900	22.01 - 23.12
8.41425 - 8.41475	156.7 - 156.9	3260 - 3267	23.6 - 24.0
12.29 - 12.293	162.0125 - 167.17	3332 - 3339	31.2 - 31.8
12.51975 - 12.52025	167.72 - 173.2	3345.8 - 3358	36.43 - 36.5
12.57675 - 12.57725	240 - 285	3600 - 4400	(²)
13.36 - 13.41	322 - 335.4		

¹ Until February 1, 1999, this restricted band shall be 0.490-0.510 MHz.

² Above 38.6

(b) Except as provided in paragraphs (d) and (e), the field strength of emissions appearing within these frequency bands shall not exceed the limits shown in Section 15.209. At frequencies equal to or less than 1000 MHz, compliance with the limits in Section 15.209 shall be demonstrated using measurement instrumentation employing a CISPR quasi-peak detector. Above 1000 MHz, compliance with the emission limits in Section 15.209 shall be demonstrated based on the average value of the measured emissions. The provisions in Section 15.35 apply to these measurements.

3.5 DESCRIPTION OF TEST MODES

The three Power Adapters (Delta / GA210PE1-00, Delta / GA240PE1-00, Flextronics / GA240PE1-00) and two antennas (Tyco, Yageo) have been pre-scanned during the test. The Adapter (Flextronics / GA240PE1-00) and the Antenna (Yageo) were selected as the worst case for final test.

The EUT (model: PP08X001) had been tested under operating condition.

Software used to control the EUT for staying in continuous transmitting and receiving mode was programmed.

After verification, all tests carried out were with the worst-case test modes as shown below except radiated spurious emission worst case was in normal link mode with cradle.

RF ID: Channel 13.56MHz was chosen for full testing.



4. INSTRUMENT CALIBRATION

4.1 MEASURING INSTRUMENT CALIBRATION

The measuring equipment, which was utilized in performing the tests documented herein, has been calibrated in accordance with the manufacturer's recommendations for utilizing calibration equipment, which is traceable to recognized national standards.

4.2 MEASUREMENT EQUIPMENT USED

Equipment Used for Emissions Measurement

Remark: Each piece of equipment is scheduled for calibration once a year.

3M Semi Anechoic Chamber				
Name of Equipment	Manufacturer	Model	Serial Number	Calibration Due
Spectrum Analyzer	Agilnet	E4446A	MY48250064	10/28/2009
Spectrum Analyzer	R&S	FSEB	825829/011	10/29/2009
Pre-Amplifier	HP	8447D	2944A06530	12/31/2009
Pre-Amplifier	HP	8449B	3008A01738	04/17/2010
EMI Test Receiver	SCHAFFNER	SCR 3501	436	01/21/2010
Loop Antenna	EMCO	6502	2356	05/28/2010
Bilog Antenna	SCHWAZBECK	VULB9160	3084	09/08/2009
Horn Antenna	EMCO	3115	00022250	05/08/2010
Turn Table	CCS	CC-T-1F	N/A	N.C.R
Antenna Tower	CCS	CC-A-1F	N/A	N.C.R
Controller	CCS	CC-C-1F	N/A	N.C.R
Test S/W	LabVIEW 6.1 (Wugu Chamber EMI Teat V1_4.5.3)			

Powerline Conducted Emissions Test Site				
Name of Equipment	Manufacturer	Model	Serial Number	Calibration Due
EMI Test Receiver	R&S	ESCI	100782	06/01/2010
LISN	R&S	ENV216	100066	05/06/2010
LISN	R&S	ENV 4200	830326/016	04/15/2010
Test S/W	CCS-3A1-CE			

4.3 MEASUREMENT UNCERTAINTY

Parameter	Uncertainty
Powerline Conducted Emission	±1.7806
3M Semi Anechoic Chamber / 30MHz ~ 1GHz	±4.0474
3M Semi Anechoic Chamber / Above 1GHz	±3.8967

Remark: This uncertainty represents an expanded uncertainty expressed at approximately the 95% confidence level using a coverage factor of k=2.



5. FACILITIES AND ACCREDITATIONS

5.1 FACILITIES

All measurement facilities used to collect the measurement data are located at

- No.199, Chunghsen Road, Hsintien City, Taipei Hsien, Taiwan, R.O.C.
Tel: 886-2-2217-0894 / Fax: 886-2-2217-1029
- No.11, Wugong 6th Rd., Wugu Industrial Park, Taipei Hsien 248, Taiwan
Tel: 886-2-2299-9720 / Fax: 886-2-2298-4045
- No. 81-1, Lane 210, Pa-De 2nd Rd., Luchu Hsiang, Taoyuan Shien, (338) Taiwan, R.O.C.
Tel: 886-3-324-0332 / Fax: 886-3-324-5235

The sites are constructed in conformance with the requirements of ANSI C63.7, ANSI C63.4: 2003 and CISPR Publication 22.

5.2 EQUIPMENT





Radiated emissions are measured with one or more of the following types of linearly polarized antennas: tuned dipole, biconical, log periodic, bi-log, and/or ridged waveguide, horn. Spectrum analyzers with pre-selectors and quasi-peak detectors are used to perform radiated measurements.

Conducted emissions are measured with Line Impedance Stabilization Networks and EMI Test Receivers.

Calibrated wideband preamplifiers, coaxial cables, and coaxial attenuators are also used for making measurements.

All receiving equipment conforms to CISPR Publication 16-1, "Radio Interference Measuring Apparatus and Measurement Methods."

5.3 TABLE OF ACCREDITATIONS AND LISTINGS

Country	Agency	Scope of Accreditation	Logo
USA	A2LA	CFR 47, FCC Part15/18, CISPR 22, EN 55022, ICES-003, AS/NZS CISPR 22, VCCI V-3, EN 55011, CISPR 11, IEC/EN 61000-4-2/3/4/5/6/8/11, EN 61000-6-1/2/3/4, EN 55024, CISPR 24, AS/NZS CISPR 24, AS/NZS 61000.6.2, EN 55014-1/-2, ETSI EN 300 386 v1.3.2/v1.3.3, IEC/EN 61000-3-2, AS/NZS 61000.3.2, IEC/EN 61000-3-3, AS/NZS 61000.3.3	 ACCREDITED No. 0824-01
USA	FCC MRA	3/10 meter Open Area Test Sites to perform FCC Part 15/18 measurements	
Japan	VCCI	3/10 meter Open Area Test Sites and conducted test sites to perform radiated/conducted measurements	VCCI R-2882/2541/2798/725/1868 C-402/747/912 T-321/325
Taiwan	TAF	EN 55014-1, CISPR 14, CNS 13781-1, EN 55013, CISPR 13, CNS 13439, EN 55011, CISPR 11, CNS 13803, PLMN09, IS2045-0, LP0002 FCC Part 27/90, Part 15B/C/D/E, RSS-192/193/210/310 ETSI EN 300 328/ 300 220-1/ 300 220-2/ 301 893/ 301 489-01/ 301 489-03/ 301 489-07 / 301 489-17/ 300 440-1/ 300 440-2 AS/NZS 4268, AS/NZS 4771 CISPR 22, EN 55022, CNS 13438, AS/NZS CISPR 22, VCCI, IEC/EN 61000-4-2/3/4/5/6/8/11, CNS 14676-2/3/4/5/6/8, CNS 14934-2/3, CNS 13783-1, CNS 13439, CNS 13803	
Taiwan	BSMI	CNS 13438, CNS 13783-1, CNS 13439, CNS 14115	SL2-IS-E-0014 / IN-E-0014 /A1-E-0014 /R1-E-0014 /R2-E-0014 /L1-E-0014
Canada	Industry Canada	RSS212, Issue 1	

Note: No part of this report may be used to claim or imply product endorsement by A2LA, TAF or other government agency.



6. SETUP OF EQUIPMENT UNDER TEST

6.1 SETUP CONFIGURATION OF EUT

See test photographs attached in Appendix 1 for the actual connections between EUT and support equipment.

6.2 SUPPORT EQUIPMENT

For Radiated Emission test only							
No.	Device Type	Brand	Model	Series No.	FCC ID	Data Cable	Power Cord
	N/A						

****No any support equipment during the test.**

For Powerline Conducted Emissions test only							
No.	Device Type	Brand	Model	Series No.	FCC ID	Data Cable	Power Cord
1	LCD Monitor	DELL	2407WFPb	CN-0FC255-46633-66 0-045S	FCC DoC	VGA Cable: Shielded, 1.8m with two cores	Unshielded, 1.8m
2	Multimedia Headset	CJC	CJC-5258MV	0507068013	FCC DoC	Unshielded, 1.8m	N/A
3	USB Mouse	HP	MO19UCA	020440943	FCC DoC	Unshielded, 1.8m	N/A
4	USB 2.0 External HDD	TeraSys	F12-U	A0100214-43b0015	FCC DoC	Unshielded, 1.8m	N/A
5	Flash Drive	PQI	U172	N/A	N/A	Shielded, 1.8m	N/A
6	Flash Drive	PQI	U172	N/A	N/A	Shielded, 1.8m	N/A
7	Flash Drive	PQI	U172	N/A	N/A	Shielded, 1.8m	N/A
8	Notebook PC (Remote)	HP	COMPAQ NC 4010	CNU441F8LV	FCC DOC	LAN Cable: Unshielded, 10m Line Cable: Unshielded, 10m	AC I/P: Unshielded, 1.8m DC O/P: Unshielded, 1.8m with a core

Note: Grounding was established in accordance with the manufacturer's requirements and conditions for the intended use.



7. FCC PART 15.225 REQUIREMENTS

7.1 RADIATED EMISSIONS

LIMIT

According to §15.225,

- (a) The field strength of any emissions within the band 13.553 – 13.567 MHz shall not exceed 15,848 microvolts / meter at 30 meters.
- (b) Within the bands 13.410 – 13.553 MHz and 13.567 -13.710 MHz, the field strength of any emissions shall not exceed 334 microvolts / meter at 30 meters.
- (c) Within the bands 13.110 – 13.410 MHz and 13.710 – 14.010 MHz the field strength of any emissions shall not exceed 106 microvolts / meter at 30 meters.
- (d) The field strength of any emissions appearing outside of the 13.110 – 14.010 MHz and shall not exceed the general radiated emission limits in §15.209.

According to §15.225(a), except as provided elsewhere in this Subpart, the emissions from an intentional radiator shall not exceed the field strength levels specified in the following table:

Frequency (MHz)	Field Strength (µV/m at meter)	Measurement Distance (meter)
0.009 – 0.490	2400 / F (kHz)	300
0.490 – 1.705	24000 / F (kHz)	30
1.705 – 30.0	30	30
30 - 88	100**	3
88-216	150**	3
216-960	200**	3
Above 960	500	3

** Except as provided in paragraph (g), fundamental emissions from intentional radiators operating under this Section shall not be located in the frequency bands 54-72 MHz, 76-88 MHz, 174-216 MHz or 470-806 MHz. However, operation within these frequency bands is permitted under other sections of this Part, e.g., Sections 15.231 and 15.241.

TEST CONFIGURATION

9kHz ~ 30MHz

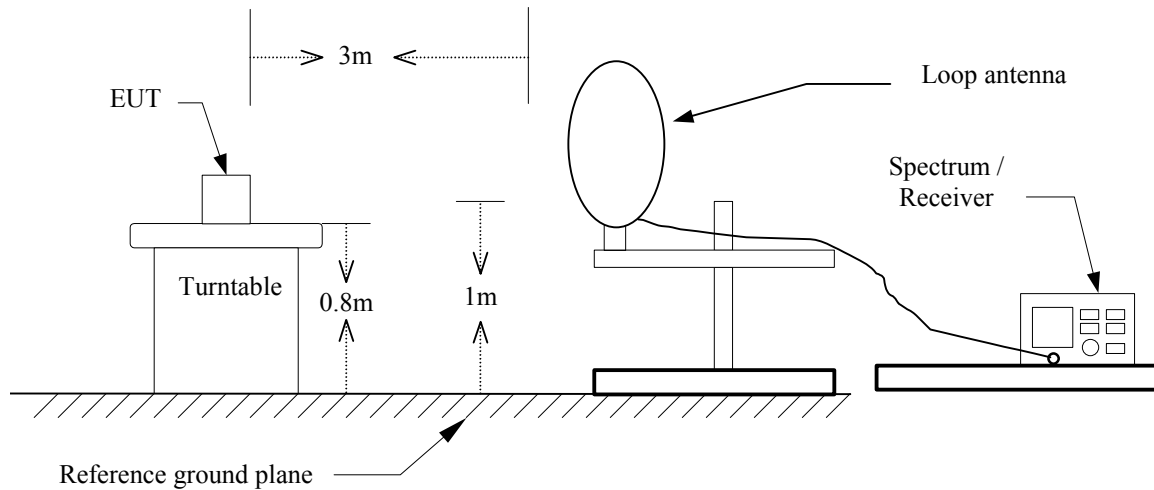

30MHz ~ 1 GHz

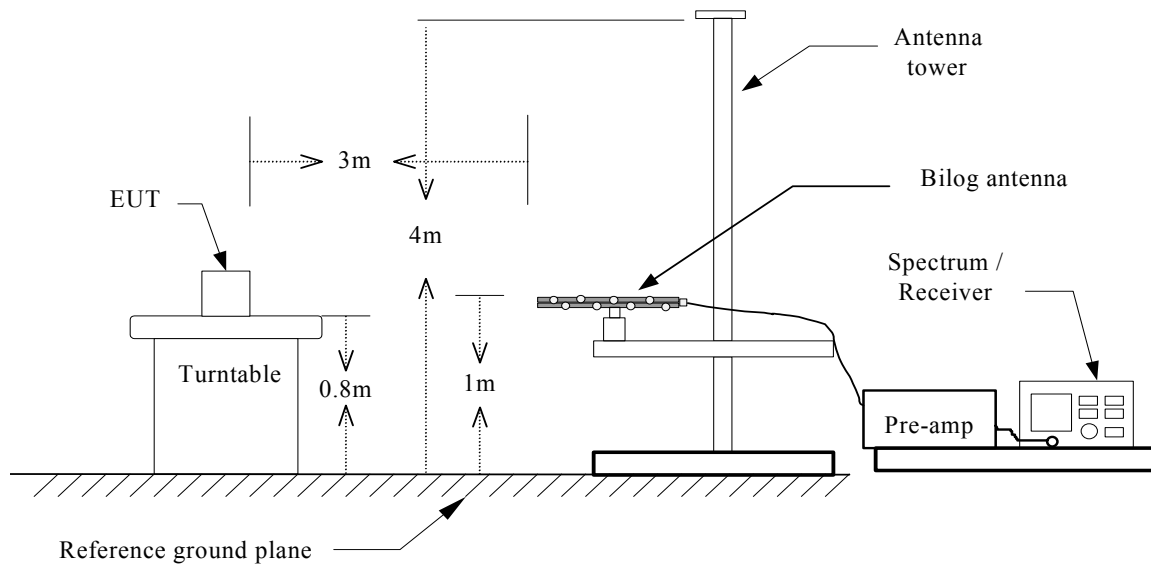



TEST PROCEDURE

1. The EUT is placed on a turntable, which is 0.8m above ground plane.
2. The turntable shall be rotated for 360 degrees to determine the position of maximum emission level.
3. EUT is set 3m away from the receiving antenna, which is varied from 1m to 4m to find out the highest emissions.
4. Maximum procedure was performed on the six highest emissions to ensure EUT compliance.
5. And also, each emission was to be maximized by changing the polarization of receiving antenna both horizontal and vertical.
6. Set the spectrum analyzer in the following setting as:
RBW=100kHz / VBW=300kHz / Sweep=AUTO
7. Repeat above procedures until the measurements for all frequencies are complete.

TEST RESULTS

No non-compliance noted



TEST DATA

Operation Mode: TX mode **Test Date:** July 29, 2009
Temperature: 18°C **Tested by:** Stan Lin
Humidity: 60 % RH **Polarity:** Ver. / Hor.

Frequency (MHz)	Ant.Pol. (H/V)	Detector Mode (PK/QP/AVG)	Reading (dBuV)	Correction Factor (dB/m)	Result (dBuV/m)	Limit 3m (dBuV/m)	Margin (dB)
13.5575	V	QP	33.87	9.59	43.46	124.00	-80.54
30.0000	V	QP	38.25	-15.00	23.25	40.00	-16.75
34.8500	V	QP	45.25	-15.15	30.10	40.00	-9.90
46.9750	V	QP	42.91	-14.35	28.56	40.00	-11.44
100.3250	V	QP	40.10	-17.12	22.98	43.50	-20.52
233.7000	V	QP	38.24	-14.13	24.11	46.00	-21.89
287.1500	V	QP	43.57	-12.05	31.52	46.00	-14.48
541.5800	V	QP	38.11	-8.53	29.58	46.00	-16.42
13.5600	H	QP	34.22	9.59	43.81	124.00	-80.19
56.6750	H	QP	35.17	-14.49	20.68	40.00	-19.32
160.9400	H	QP	31.58	-12.34	19.24	43.50	-24.26
198.5900	H	QP	38.42	-14.63	23.79	43.50	-19.71
232.8200	H	QP	40.11	-14.14	25.97	46.00	-20.03
283.9200	H	QP	42.18	-11.98	30.20	46.00	-15.80
390.4300	H	QP	34.62	-10.99	23.63	46.00	-22.37
475.6200	H	QP	33.84	-8.61	25.23	46.00	-20.77
848.2800	H	QP	30.44	-1.75	28.69	46.00	-17.31

Remark:

1. No emission found between lowest internal used / generated frequency to 30 MHz. (9kHz ~ 30MHz)
2. Measuring frequencies from 9 kHz to the 1GHz.
3. Radiated emissions measured in the measured frequency range were made with an instrument using peak detector or quasi-peak detector mode.
4. Data of measurement within this frequency range shown " --- " in the table above means the reading of emissions are attenuated more than 20dB below the permissible limits or the field strength is too small to be measured.
5. The IF bandwidth of SPA between 30MHz to 1GHz was 100kHz.
6. Calculation by Converting 30m to 3meter limits.
30m limit= 15848 (uV/m)
**3m limit = 20*log(15848)+40log(30m/3m) (dBuV/m)
= 84 + 40 (dBuV/m)
= 124 (dBuV/m)

7.2.1 FREQUENCY STABILITY

LIMIT

According to §15.207(e), the frequency tolerance of the carrier signal shall be maintained within +/- 0.01% of the operating frequency over a temperature variation of -20 degrees to +50 degrees C at normal supply voltage, and for a variation in the primary supply voltage from 85% to 115% of the rated supply voltage at a temperature of 20 degrees C. For battery operated equipment, the equipment tests shall be performed using a new battery.

TEST CONFIGURATION

Temperature and Voltage Measurement (under normal and extreme test conditions)

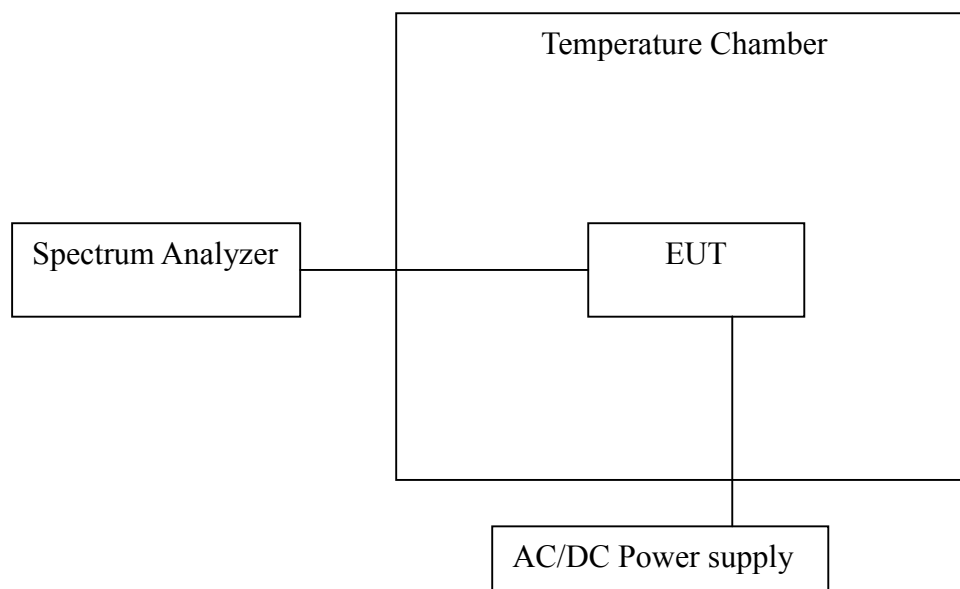

TEST PROCEDURE

1. Place the EUT on the table and set it in the transmitting mode.
2. Remove the antenna from the EUT and then connect a low loss RF cable from the antenna port to the spectrum analyzer.
3. Set the environment into appropriate environment.
4. Set the spectrum analyzer as RBW=1kHz, VBW = RBW, Span = 200kHz, Sweep = auto.
5. Mark the peak frequency and measure the frequency tolerance using frequency counter function.
6. Repeat until all the results are investigated.



TEST RESULTS

No non-compliance noted

TEST DATA

Temperature Variations

Temp. (°C)	Voltage (VAC)	Measured Frequency (MHz)	Delta Frequency (Hz)	Tolerance (%)	Limit (±%)	Result (Pass/Fail)
-20	110	13.561084	1084	0.007994	±0.01	Pass
-10		13.561154	1154	0.008510	±0.01	Pass
0		13.561037	1037	0.007647	±0.01	Pass
10		13.561044	1044	0.007699	±0.01	Pass
20		13.560015	15	0.000111	±0.01	Pass
30		13.560752	752	0.005546	±0.01	Pass
40		13.560925	925	0.006822	±0.01	Pass
50		13.560841	841	0.006202	±0.01	Pass

Voltage Variations

Temp. (°C)	Voltage (VAC)	Measured Frequency (MHz)	Delta Frequency (Hz)	Tolerance (%)	Limit (±%)	Result (Pass/Fail)
20	93.5	13.561287	1287	0.009491	±0.01	Pass
	110	13.561278	1278	0.009425	±0.01	Pass
	126.5	13.561272	1272	0.009381	±0.01	Pass



7.2 POWERLINE CONDUCTED EMISSIONS

LIMIT

According to §15.207(a), except as shown in paragraphs (b) and (c) of this section, for an intentional radiator that is designed to be connected to the public utility (AC) power line, the radio frequency voltage that is conducted back onto the AC power line on any frequency or frequencies within the band 150 kHz to 30 MHz shall not exceed the limits in the following table, as measured using a 50 μ H/50 ohms line impedance stabilization network (LISN). Compliance with the provisions of this paragraph shall be based on the measurement of the radio frequency voltage between each power line and ground at the power terminal. The lower limit applies at the boundary between the frequency ranges.

Frequency Range (MHz)	Limits (dB μ V)	
	Quasi-peak	Average
0.15 to 0.50	66 to 56*	56 to 46*
0.50 to 5	56	46
5 to 30	60	50

* Decreases with the logarithm of the frequency.

TEST PROCEDURE

1. The EUT was placed on a table, which is 0.8m above ground plane.
2. Maximum procedure was performed on the six highest emissions to ensure EUT compliance.
3. Repeat above procedures until all frequency measured were complete.



TEST RESULTS

The initial step in collecting conducted data is a spectrum analyzer peak scan of the measurement range. Significant peaks are then marked as shown on the following data page, and these signals are then quasi-peaked.

Operation Mode: Normal Link

Test Date: August 11, 2009

Temperature: 25°C

Tested by: Stan Lin

Humidity: 57% RH

Freq. (MHz)	QP Reading (dBuV)	AV Reading (dBuV)	Corr. factor (dB)	QP Result (dBuV)	AV Result (dBuV)	QP Limit (dBuV)	AV Limit (dBuV)	QP Margin (dB)	AV Margin (dB)	Note
0.1500	51.81	43.61	9.69	61.50	53.30	66.00	56.00	-4.50	-2.70	L1
0.1773	33.32	12.32	9.68	43.00	22.00	64.61	54.61	-21.61	-32.61	L1
0.6656	6.02	0.02	9.58	15.60	9.60	56.00	46.00	-40.40	-36.40	L1
0.8648	10.51	1.31	9.59	20.10	10.90	56.00	46.00	-35.90	-35.10	L1
1.0250	35.61	20.21	9.59	45.20	29.80	56.00	46.00	-10.80	-16.20	L1
1.2047	37.89	25.59	9.61	47.50	35.20	56.00	46.00	-8.50	-10.80	L1
1.5523	35.94	17.14	9.66	45.60	26.80	56.00	46.00	-10.40	-19.20	L1
5.1383	34.48	13.08	9.82	44.30	22.90	60.00	50.00	-15.70	-27.10	L1
7.2125	34.74	18.94	9.86	44.60	28.80	60.00	50.00	-15.40	-21.20	L1
11.9000	45.49	33.49	10.21	55.70	43.70	60.00	50.00	-4.30	-6.30	L1
14.9430	42.12	31.02	10.28	52.40	41.30	60.00	50.00	-7.60	-8.70	L1
20.3453	38.02	28.42	10.38	48.40	38.80	60.00	50.00	-11.60	-11.20	L1
0.1539	50.01	39.41	9.69	59.70	49.10	65.79	55.79	-6.09	-6.69	L2
0.6500	36.21	20.31	9.59	45.80	29.90	56.00	46.00	-10.20	-16.10	L2
0.8336	36.80	19.20	9.60	46.40	28.80	56.00	46.00	-9.60	-17.20	L2
1.0133	36.20	18.50	9.60	45.80	28.10	56.00	46.00	-10.20	-17.90	L2
1.1852	34.68	11.18	9.62	44.30	20.80	56.00	46.00	-11.70	-25.20	L2
1.3922	38.16	21.16	9.64	47.80	30.80	56.00	46.00	-8.20	-15.20	L2
1.5797	35.94	16.54	9.66	45.60	26.20	56.00	46.00	-10.40	-19.80	L2
1.7672	34.12	12.62	9.68	43.80	22.30	56.00	46.00	-12.20	-23.70	L2
5.2984	35.36	17.86	9.84	45.20	27.70	60.00	50.00	-14.80	-22.30	L2
11.8102	42.44	29.24	10.26	52.70	39.50	60.00	50.00	-7.30	-10.50	L2
14.6266	41.35	28.75	10.35	51.70	39.10	60.00	50.00	-8.30	-10.90	L2
20.9156	37.46	24.86	10.54	48.00	35.40	60.00	50.00	-12.00	-14.60	L2

Remark:

1. Measuring frequencies from 0.15 MHz to 30MHz.
2. The emissions measured in frequency range from 0.15 MHz to 30MHz were made with an instrument using Quasi-peak detector and average detector.
3. The IF bandwidth of SPA between 0.15MHz and 30MHz was 10kHz; the IF bandwidth of Test Receiver between 0.15MHz and 30MHz was 9kHz;
4. L1 = Line One (Live Line) / L2 = Line Two (Neutral Line)



Test Plots

Conducted emissions (Line 1)

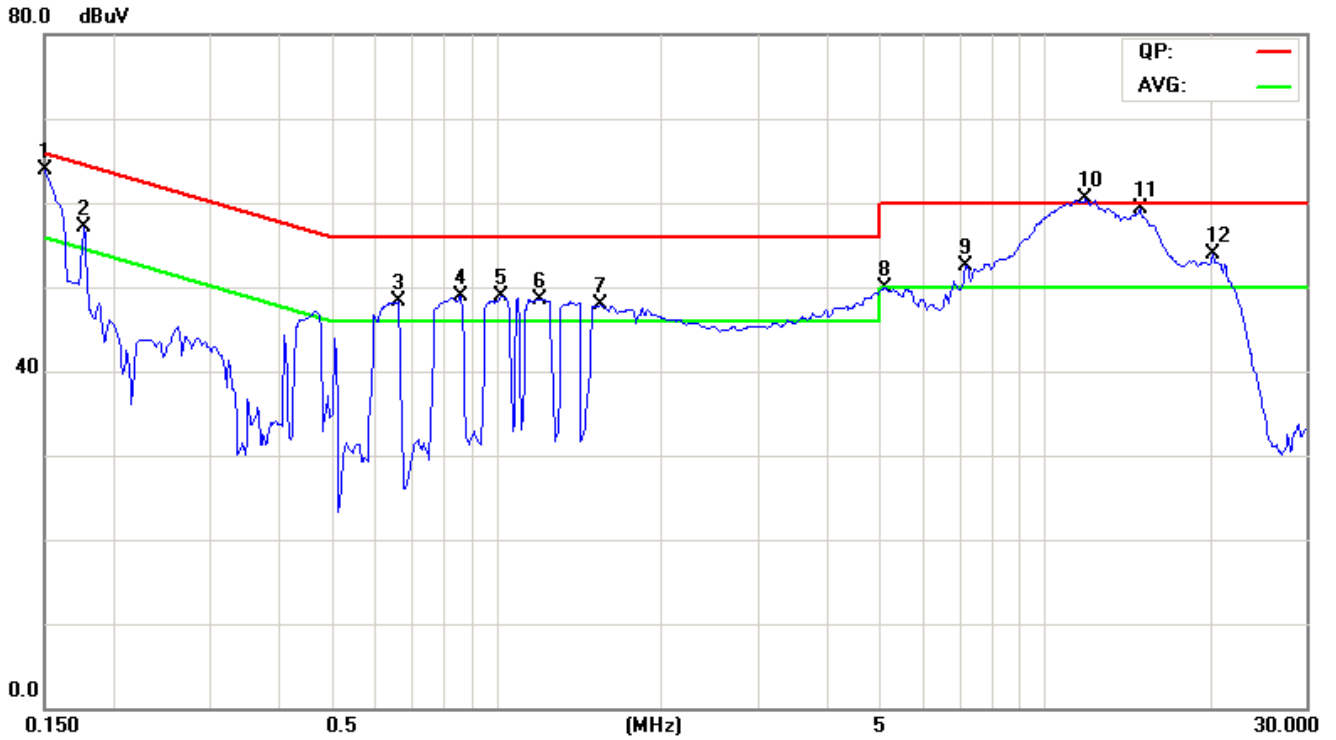

Conducted emissions (Line 2)

