



FCC 47 CFR PART 15 SUBPART C

TEST REPORT

For

Notebook PC

Model: PP30L

Trade Name: DELL

Issued to

**Dell Computer Corporation
ONE DELL WAY, ROUND ROCK, TEXAS 78682, U.S.A.**

Issued by

**Compliance Certification Services Inc.
No. 81-1, Lane 210, Pa-De 2nd Rd., Luchu Hsiang,
Taoyuan Shien, (338) Taiwan, R.O.C.
<http://www.ccsemc.com.tw>
service@tw.ccsemc.com**



Note: This report shall not be reproduced except in full, without the written approval of Compliance Certification Services Inc. This document may be altered or revised by Compliance Certification Services Inc. personnel only, and shall be noted in the revision section of the document.



TABLE OF CONTENTS

- 1. TEST RESULT CERTIFICATION..... 3**
- 2. EUT DESCRIPTION 4**
- 3. TEST METHODOLOGY 5**
 - 3.1 EUT CONFIGURATION 5
 - 3.2 EUT EXERCISE 5
 - 3.3 GENERAL TEST PROCEDURES 5
 - 3.4 FCC PART 15.205 RESTRICTED BANDS OF OPERATIONS 6
 - 3.5 DESCRIPTION OF TEST MODES 6
- 4. INSTRUMENT CALIBRATION..... 7**
 - 4.1 MEASURING INSTRUMENT CALIBRATION 7
 - 4.2 MEASUREMENT EQUIPMENT USED 7
- 5. FACILITIES AND ACCREDITATIONS 9**
 - 5.1 FACILITIES 9
 - 5.2 EQUIPMENT 9
 - 5.3 TABLE OF ACCREDITATIONS AND LISTINGS 10
- 6. SETUP OF EQUIPMENT UNDER TEST 11**
 - 6.1 SETUP CONFIGURATION OF EUT 11
 - 6.2 SUPPORT EQUIPMENT 11
- 7. FCC PART 15.225 REQUIREMENTS..... 12**
 - 7.1 RADIATED EMISSIONS 12
 - 7.2.1 FREQUENCY STABILITY 17
 - 7.2 POWERLINE CONDUCTED EMISSIONS 19
- APPENDIX I PHOTOGRAPHS OF TEST SETUP 22**



1. TEST RESULT CERTIFICATION

Applicant: **Dell Computer Corporation**
ONE DELL WAY, ROUND ROCK, TEXAS 78682, U.S.A.

Equipment Under Test: Notebook PC

Trade Name: DELL

Model Number: PP30L

Date of Test: March 21 ~ 26, 2008

APPLICABLE STANDARDS	
STANDARD	TEST RESULT
FCC 47 CFR Part 15 Subpart C	No non-compliance noted

We hereby certify that:

The above equipment was tested by Compliance Certification Services Inc. The test data, data evaluation, test procedures, and equipment configurations shown in this report were made in accordance with the procedures given in ANSI C63.4: 2003 and the energy emitted by the sample tested as described in this report is in compliance with the requirements of FCC Rules Part 15.225.

The test results of this report relate only to the tested sample identified in this report.

Approved by:

Reviewed by:

S.C. Wang
Executive Vice President
Compliance Certification Services Inc.

Miller Lee
Deputy Manager of Linkou Laboratory
Compliance Certification Services Inc.



2. EUT DESCRIPTION

Product	Notebook PC		
Trade Name	DELL		
Model Number	PP30L		
Model Difference	N/A		
EUT Power Rating	19.5VDC, 4.62A		
Power Adapter Manufacturer	DELL	Model	DA90PE0-00
			DA90PE1-00
		Model	LA90PE1-00
			LA90PS3-00
		Model	FA90PE0-00
			FA90PE1-00
Power Adapter Power Rating	I/P: 100-240Vac, 50/60Hz, 1.5A O/P: 19.5V, 4.62A		
Frequency Range	13.56MHz		
Modulation Technique	ASK		
Antenna Specification	Loop Antenna		

Remark:

- The sample selected for test was engineering sample that approximated to production product and was provided by manufacturer.*
- This submittal(s) (test report) is intended for FCC ID: E2K5880-30 filing to comply with Section 15.225 of the FCC Part 15, Subpart C Rules.*



3. TEST METHODOLOGY

The tests documented in this report were performed in accordance with ANSI C63.4 and FCC CFR 47 2.1046, 2.1047, 2.1049, 2.1051, 2.1053, 2.1055, 2.1057, 15.207, 15.209 and 15.225.

3.1 EUT CONFIGURATION

The EUT configuration for testing is installed on RF field strength measurement to meet the Commissions requirement and operating in a manner that intends to maximize its emission characteristics in a continuous normal application.

3.2 EUT EXERCISE

The EUT was operated in the engineering mode to fix the TX frequency that was for the purpose of the measurements.

3.3 GENERAL TEST PROCEDURES

Conducted Emissions

The EUT is placed on the turntable, which is 0.8 m above ground plane. According to the requirements in Section 13.1.4.1 of ANSI C63.4. Conducted emissions from the EUT measured in the frequency range between 0.15 MHz and 30MHz using CISPR Quasi-peak and average detector modes.

Radiated Emissions

The EUT is placed on a turn table, which is 0.8 m above ground plane. The turntable shall rotate 360 degrees to determine the position of maximum emission level. EUT is set 3m away from the receiving antenna, which varied from 1m to 4m to find out the highest emission. And also, each emission was to be maximized by changing the polarization of receiving antenna both horizontal and vertical. In order to find out the maximum emissions, exploratory radiated emission measurements were made according to the requirements in Section 13.1.4.1 of ANSI C63.4.



3.4 FCC PART 15.205 RESTRICTED BANDS OF OPERATIONS

(a) Except as shown in paragraph (d) of this section, only spurious emissions are permitted in any of the frequency bands listed below:

MHz	MHz	MHz	GHz
0.090 - 0.110	16.42 - 16.423	399.9 - 410	4.5 - 5.15
¹ 0.495 - 0.505	16.69475 - 16.69525	608 - 614	5.35 - 5.46
2.1735 - 2.1905	16.80425 - 16.80475	960 - 1240	7.25 - 7.75
4.125 - 4.128	25.5 - 25.67	1300 - 1427	8.025 - 8.5
4.17725 - 4.17775	37.5 - 38.25	1435 - 1626.5	9.0 - 9.2
4.20725 - 4.20775	73 - 74.6	1645.5 - 1646.5	9.3 - 9.5
6.215 - 6.218	74.8 - 75.2	1660 - 1710	10.6 - 12.7
6.26775 - 6.26825	108 - 121.94	1718.8 - 1722.2	13.25 - 13.4
6.31175 - 6.31225	123 - 138	2200 - 2300	14.47 - 14.5
8.291 - 8.294	149.9 - 150.05	2310 - 2390	15.35 - 16.2
8.362 - 8.366	156.52475 -	2483.5 - 2500	17.7 - 21.4
8.37625 - 8.38675	156.52525	2655 - 2900	22.01 - 23.12
8.41425 - 8.41475	156.7 - 156.9	3260 - 3267	23.6 - 24.0
12.29 - 12.293	162.0125 - 167.17	3332 - 3339	31.2 - 31.8
12.51975 - 12.52025	167.72 - 173.2	3345.8 - 3358	36.43 - 36.5
12.57675 - 12.57725	240 - 285	3600 - 4400	(²)
13.36 - 13.41	322 - 335.4		

¹ Until February 1, 1999, this restricted band shall be 0.490-0.510 MHz.

² Above 38.6

(b) Except as provided in paragraphs (d) and (e), the field strength of emissions appearing within these frequency bands shall not exceed the limits shown in Section 15.209. At frequencies equal to or less than 1000 MHz, compliance with the limits in Section 15.209 shall be demonstrated using measurement instrumentation employing a CISPR quasi-peak detector. Above 1000 MHz, compliance with the emission limits in Section 15.209 shall be demonstrated based on the average value of the measured emissions. The provisions in Section 15.35 apply to these measurements.

3.5 DESCRIPTION OF TEST MODES

The six Power Adapters (DA90PE0-00, DA90PE1-00, FA90PE0-00, FA90PE1-00, LA90PS3-00 & LA90PE1-00), two mother boards and four antennas have been pre-scanned during the test. The Adapter (FA90PE1-00), mother board (Discrete) and the Antenna (Smart Approach) were selected as the worst case for final test.

The EUT (model: PP30L) had been tested under operating condition.

Software used to control the EUT for staying in continuous transmitting and receiving mode was programmed.

After verification, all tests carried out were with the worst-case test modes as shown below except radiated spurious emission worst case was in normal link mode with cradle.

RF ID: Channel 13.56MHz was chosen for full testing.



4. INSTRUMENT CALIBRATION

4.1 MEASURING INSTRUMENT CALIBRATION

The measuring equipment, which was utilized in performing the tests documented herein, has been calibrated in accordance with the manufacturer's recommendations for utilizing calibration equipment, which is traceable to recognized national standards.

4.2 MEASUREMENT EQUIPMENT USED

Equipment Used for Emissions Measurement

Remark: Each piece of equipment is scheduled for calibration once a year.

Open Area Test Site # 3				
Name of Equipment	Manufacturer	Model	Serial Number	Calibration Due
Spectrum Analyzer	Agilnet	E4411B	MY41440314	N.C.R
Spectrum Analyzer	R&S	FSP30	100112	10/14/2008
EMI Test Receiver	R&S	ESVS10	834468/006	04/15/2008
Pre-Amplifier	Anritsu	MH648A	M18767	09/09/2008
Pre-Amplifier	Agilent	8449B	3008A01738	04/11/2008
Bilog Antenna	SCHWAZBECK	VULB9163	144	03/30/2008
Horn Antenna	EMCO	3115	00022250	05/03/2008
Loop Antenna	EMCO	6502	2356	05/28/2010
Turn Table	Chance Most	CM-T003-1	T807-6	N.C.R
Antenna Tower	Chance Most	CM-A003-1	A807-6	N.C.R
Controller	CCS	CC-C-1F	N/A	N.C.R
RF Switch	ANRITSU	MP59B	M53867	N.C.R
Site NSA	CCS	N/A	N/A	05/18/2008
Test S/W	LABVIEW (V 6.1)			

Remark:

1. The measurement uncertainty is less than +/-2.0065dB (30MHz ~ 1GHz), which is evaluated as per the NAMAS NIS 81 and CISPR/A/291/CDV.
2. Each piece of equipment is scheduled for calibration once a year.



3M Semi Anechoic Chamber				
Name of Equipment	Manufacturer	Model	Serial Number	Calibration Due
Spectrum Analyzer	R&S	FSP30	100112	10/14/2008
Spectrum Analyzer	R&S	FSEB	825829/011	10/11/2008
Pre-Amplifier	Anritsu	MH648A	M89145	07/20/2008
Pre-Amplifier	Agilent	8449B	3008A01738	04/11/2008
Bilog Antenna	FRANKONIA	BTA-M	030003M	N.C.R
Horn Antenna	EMCO	3115	00022257	12/16/2008
Antenna Tower	HD	AS620E	N/A	N.C.R
Controller	HD	HD100	N/A	N.C.R
Turn Table	HD	DT-K312	N/A	N.C.R
Test S/W	LabVIEW 6.1 (Wugu Chamber EMI Teat V1_4.5.3)			

Remark:

1. The measurement uncertainty is less than +/-3.0958dB (Above 1GHz), which is evaluated as per the NAMAS NIS 81 and CISPR/A/291/CDV.
2. Each piece of equipment is scheduled for calibration once a year.

Powerline Conducted Emissions Test Site				
Name of Equipment	Manufacturer	Model	Serial Number	Calibration Due
EMI Test Receiver	SCHAFFNER	SCR 3501	410	12/16/2008
LISN	R&S	ESH3-Z5	848773/014	10/28/2008
LISN	FCC	FCC-LISN-50/ 250-16-2-07	06012	11/20/2008
Pulse Limiter	R&S	ESH3-Z2	100230	11/01/2008
Test S/W	LabVIEW 6.1 (CCS Conduction Test SW Version_01)			

Remark:

1. The measurement uncertainty is less than +/- 1.9280dB, which is evaluated as per the NAMAS NIS 81 and CISPR/A/291/CDV.
2. Each piece of equipment is scheduled for calibration once a year.



5. FACILITIES AND ACCREDITATIONS

5.1 FACILITIES

All measurement facilities used to collect the measurement data are located at

No.199, Chunghsen Road, Hsintien City, Taipei Hsien, Taiwan, R.O.C.

Tel: 886-2-2217-0894 / Fax: 886-2-2217-1029

No.11, Wugong 6th Rd., Wugu Industrial Park, Taipei Hsien 248, Taiwan

Tel: 886-2-2299-9720 / Fax: 886-2-2298-4045

No. 81-1, Lane 210, Pa-De 2nd Rd., Luchu Hsiang, Taoyuan Shien, (338) Taiwan, R.O.C.

Tel: 886-3-324-0332 / Fax: 886-3-324-5235

The sites are constructed in conformance with the requirements of ANSI C63.7, ANSI C63.4 and CISPR Publication 22.

5.2 EQUIPMENT





Radiated emissions are measured with one or more of the following types of linearly polarized antennas: tuned dipole, biconical, log periodic, bi-log, and/or ridged waveguide, horn. Spectrum analyzers with pre-selectors and quasi-peak detectors are used to perform radiated measurements.

Conducted emissions are measured with Line Impedance Stabilization Networks and EMI Test Receivers.

Calibrated wideband preamplifiers, coaxial cables, and coaxial attenuators are also used for making measurements.

All receiving equipment conforms to CISPR Publication 16-1, "Radio Interference Measuring Apparatus and Measurement Methods."

5.3 TABLE OF ACCREDITATIONS AND LISTINGS

Country	Agency	Scope of Accreditation	Logo
USA	A2LA	EN 55011, EN 55014-1/2, CISPR 11, CISPR 14-1/2, EN 55022, EN 55015, CISPR 22, CISPR 15, AS/NZS 3548, VCCI V3 (2001), CFR 47, FCC Part 15/18, CNS 13783-1, CNS 13439, CNS 13438, CNS 13803, CNS 14115, EN 55024, IEC 801-2, IEC 801-3, IEC 801-4, IEC/EN 61000-3-2, IEC/EN 61000-3-3, IEC/EN 61000-4-2/3/4/5/6/8/11, EN 50081-1/EN 61000-6-3, EN 50081-2/EN 61000-6-4, EN 50081-2/EN 61000-6-1: 2001	 ACCREDITED TESTING CERT #0824.01
USA	FCC	3/10 meter Open Area Test Sites to perform FCC Part 15/18 measurements	 93105, 90471
Japan	VCCI	3/10 meter Open Area Test Sites and conducted test sites to perform radiated/conducted measurements	VCCI R-2541/2316/725/1868 C-402/747/912
Taiwan	TAF	EN 300 328-1, EN 300 328-2, EN 300 220-1, EN 300 220-2, EN 300 220-3, 47 CFR FCC Part 15 Subpart C, EN 61000-3-2, EN 61000-3-3, CNS 13439, CNS 13783-1, CNS 14115, CNS 13438, AS/NZS CISPR 22, CNS 13022-1, IEC 61000-4-2/3/4/5/6/8/11, CNS 13022-2/3	 Testing Laboratory 0363
Taiwan	BSMI	CNS 13438, CNS 13783-1, CNS 13439, CNS 14115	 SL2-IS-E-0014 / IN-E-0014 /A1-E-0014 /R1-E-0014 /R2-E-0014 /L1-E-0014
Canada	Industry Canada	RSS212, Issue 1	 IC 2324C-3 IC 2324C-5

Note: No part of this report may be used to claim or imply product endorsement by A2LA, TAF or other government agency.



6. SETUP OF EQUIPMENT UNDER TEST

6.1 SETUP CONFIGURATION OF EUT

See test photographs attached in Appendix 1 for the actual connections between EUT and support equipment.

6.2 SUPPORT EQUIPMENT

No.	Device Type	Brand	Model	Series No.	FCC ID	Data Cable	Power Cord
	N/A						

****No any support equipment during the test.**

Note: Grounding was established in accordance with the manufacturer's requirements and conditions for the intended use.



7. FCC PART 15.225 REQUIREMENTS

7.1 RADIATED EMISSIONS

LIMIT

According to §15.225,

- (a) The field strength of any emissions within the band 13.553 – 13.567 MHz shall not exceed 15,848 microvolts / meter at 30 meters.
- (b) Within the bands 13.410 – 13.553 MHz and 13.567 -13.710 MHz, the field strength of any emissions shall not exceed 334 microvolts / meter at 30 meters.
- (c) Within the bands 13.110 – 13.410 MHz and 13.710 – 14.010 MHz the field strength of any emissions shall not exceed 106 microvolts / meter at 30 meters.
- (d) The field strength of any emissions appearing outside of the 13.110 – 14.010 MHz and shall not exceed the general radiated emission limits in §15.209.

According to §15.225(a), except as provided elsewhere in this Subpart, the emissions from an intentional radiator shall not exceed the field strength levels specified in the following table:

Frequency (MHz)	Field Strength (µV/m at meter)	Measurement Distance (meter)
0.009 – 0.490	2400 / F (kHz)	300
0.490 – 1.705	24000 / F (kHz)	30
1.705 – 30.0	30	30
30 - 88	100**	3
88-216	150**	3
216-960	200**	3
Above 960	500	3

** Except as provided in paragraph (g), fundamental emissions from intentional radiators operating under this Section shall not be located in the frequency bands 54-72 MHz, 76-88 MHz, 174-216 MHz or 470-806 MHz. However, operation within these frequency bands is permitted under other sections of this Part, e.g., Sections 15.231 and 15.241.

Test Configuration

9kHz ~ 30MHz

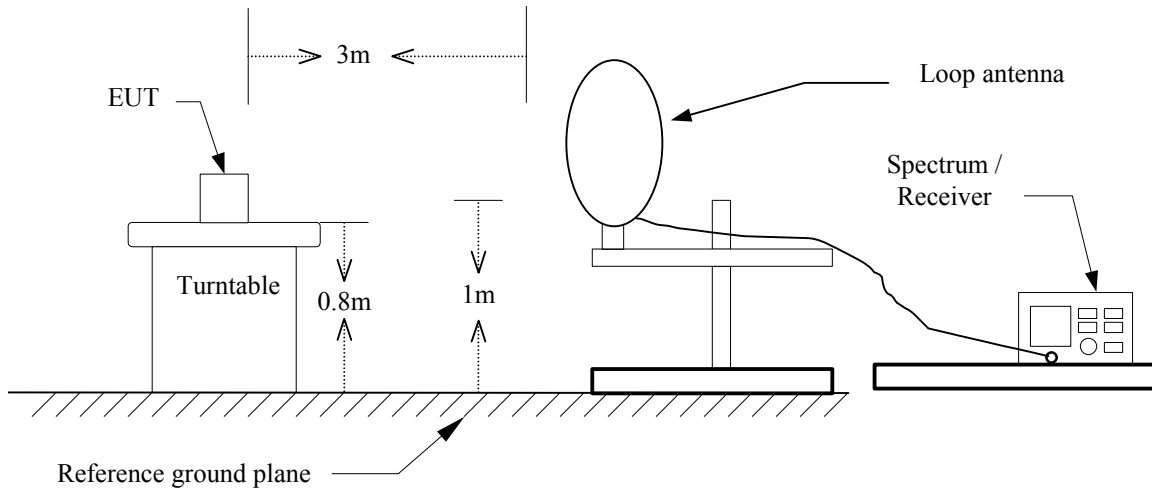

30MHz ~ 1 GHz

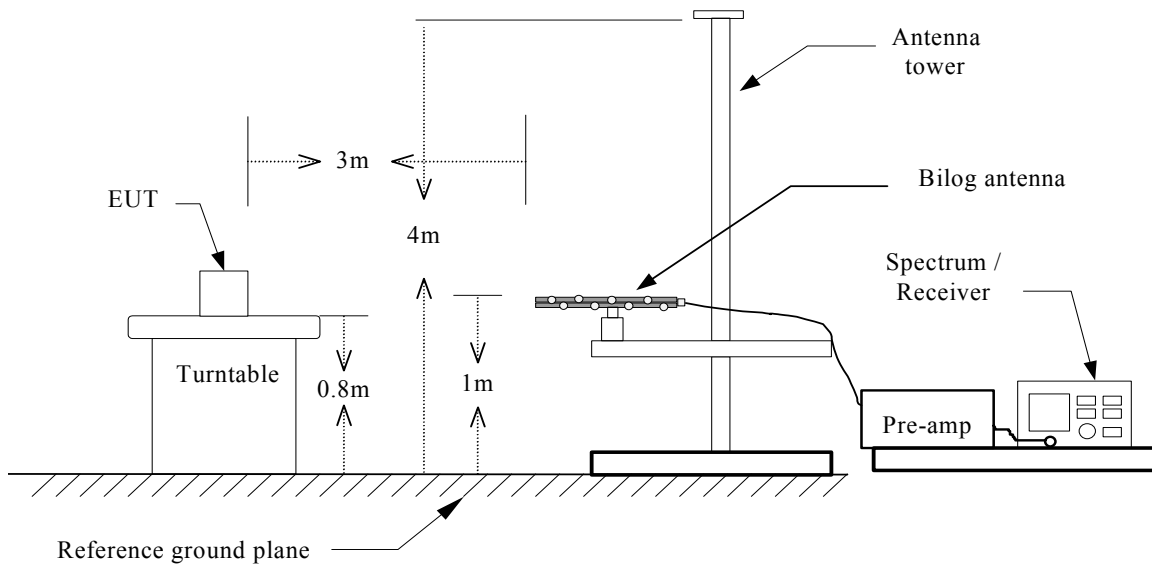



TEST PROCEDURE

1. The EUT is placed on a turntable, which is 0.8m above ground plane.
2. The turntable shall be rotated for 360 degrees to determine the position of maximum emission level.
3. EUT is set 3m away from the receiving antenna, which is varied from 1m to 4m to find out the highest emissions.
4. Maximum procedure was performed on the six highest emissions to ensure EUT compliance.
5. And also, each emission was to be maximized by changing the polarization of receiving antenna both horizontal and vertical.
6. Set the spectrum analyzer in the following setting as:
RBW=100kHz / VBW=300kHz / Sweep=AUTO
7. Repeat above procedures until the measurements for all frequencies are complete.



TEST RESULTS

Operation Mode: TX mode (Power On) **Test Date:** March 26, 2008
Temperature: 20°C **Tested by:** Arno Hsieh
Humidity: 55 % RH **Polarity:** Ver. / Hor.

Frequency (MHz)	Ant.Pol. (H/V)	Detector Mode (PK/QP/AVG)	Reading (dBuV)	Correction Factor (dB/m)	Result (dBuV/m)	Limit 3m (dBuV/m)	Margin (dB)
13.56	V	Peak	19.42	11.62	31.04	123.99	-92.95
176.28	V	Peak	22.94	11.29	34.23	43.50	-9.27
216.95	V	Peak	16.04	13.05	29.08	46.00	-16.92
230.45	V	Peak	15.12	13.53	28.64	46.00	-17.36
244.08	V	Peak	12.84	14.05	26.88	46.00	-19.12
257.63	V	Peak	11.44	14.41	25.85	46.00	-20.15
366.43	V	Peak	16.80	17.10	33.90	46.00	-12.10
13.56	H	Peak	18.25	11.62	29.87	123.99	-94.12
175.60	H	Peak	19.72	11.26	30.98	43.50	-12.52
216.97	H	Peak	23.83	13.05	36.88	46.00	-9.12
230.55	H	Peak	21.12	13.53	34.65	46.00	-11.35
244.08	H	Peak	23.30	14.05	37.35	46.00	-8.65
257.65	H	Peak	19.18	14.41	33.59	46.00	-12.41
366.43	H	Peak	22.71	17.10	39.81	46.00	-6.19

Remark:

1. Measuring frequencies from 9kHz to the 1GHz.
2. Radiated emissions measured in frequency range from 9kHz to 1000MHz were made with an instrument using peak/quasi-peak/average detector mode.
3. Measurements above show only up to 6 maximum emissions noted, or would be lesser, with " N/A " remark, if no specific emissions from the EUT are recorded (ie: margin>20dB from the applicable limit) and considered that's already beyond the background noise floor.
4. $Margin (dB) = Result (dBuV/m) - Limit (dBuV/m)$.



Operation Mode: TX mode (Power Off) **Test Date:** March 26, 2008
Temperature: 20°C **Tested by:** Arno Hsieh
Humidity: 55 % RH **Polarity:** Ver. / Hor.

Frequency (MHz)	Ant.Pol. (H/V)	Detector Mode (PK/QP/AVG)	Reading (dBuV)	Correction Factor (dB/m)	Result (dBuV/m)	Limit 3m (dBuV/m)	Margin (dB)
175.80	V	Peak	19.31	13.79	33.10	43.50	-10.40
216.20	V	Peak	14.41	14.01	28.42	46.00	-17.58
230.61	V	Peak	14.45	13.66	28.11	46.00	-17.89
244.92	V	Peak	12.20	14.21	26.41	46.00	-19.59
257.12	V	Peak	9.76	15.16	24.92	46.00	-21.08
367.51	V	Peak	16.20	17.76	33.96	46.00	-12.04
175.21	H	Peak	15.69	13.85	29.54	43.50	-13.96
216.80	H	Peak	22.44	13.97	36.41	46.00	-9.59
230.51	H	Peak	19.06	13.65	32.71	46.00	-13.29
244.00	H	Peak	21.94	14.18	36.12	46.00	-9.88
257.41	H	Peak	18.43	15.19	33.62	46.00	-12.38
367.12	H	Peak	20.68	17.76	38.44	46.00	-7.56

Remark:

5. Measuring frequencies from 9kHz to the 1GHz.
6. Radiated emissions measured in frequency range from 9kHz to 1000MHz were made with an instrument using peak/quasi-peak/average detector mode.
7. Measurements above show only up to 6 maximum emissions noted, or would be lesser, with " N/A " remark, if no specific emissions from the EUT are recorded (ie: margin>20dB from the applicable limit) and considered that's already beyond the background noise floor.
8. Margin (dB) = Result (dBuV/m) – Limit (dBuV/m).

7.2.1 FREQUENCY STABILITY

LIMIT

According to §15.207(e), the frequency tolerance of the carrier signal shall be maintained within +/- 0.01% of the operating frequency over a temperature variation of -20 degrees to +50 degrees C at normal supply voltage, and for a variation in the primary supply voltage from 85% to 115% of the rated supply voltage at a temperature of 20 degrees C. For battery operated equipment, the equipment tests shall be performed using a new battery.

Test Configuration

Temperature and Voltage Measurement (under normal and extreme test conditions)

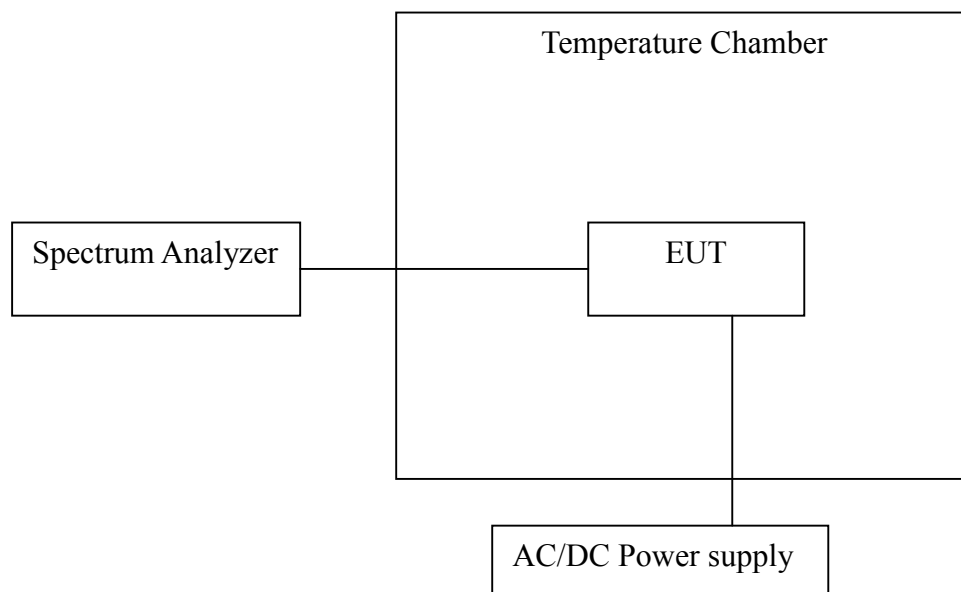

TEST PROCEDURE

1. Place the EUT on the table and set it in the transmitting mode.
2. Remove the antenna from the EUT and then connect a low loss RF cable from the antenna port to the spectrum analyzer.
3. Set the environment into appropriate environment.
4. Set the spectrum analyzer as RBW=1kHz, VBW = RBW, Span = 200kHz, Sweep = auto.
5. Mark the peak frequency and measure the frequency tolerance using frequency counter function.
6. Repeat until all the results are investigated.



TEST RESULTS

No non-compliance noted

Temperature Variations

Temp. (°C)	Voltage (VAC)	Measured Frequency (MHz)	Delta Frequency (Hz)	Tolerance (%)	Limit (±%)	Result (Pass/Fail)
-20	110	13.559377	-623	-0.004594	±0.01	Pass
-10		13.559373	-627	-0.004624	±0.01	Pass
0		13.559358	-642	-0.004735	±0.01	Pass
10		13.559326	-674	-0.004971	±0.01	Pass
20		13.559304	-696	-0.005133	±0.01	Pass
30		13.559342	-658	-0.004853	±0.01	Pass
40		13.559326	-674	-0.004971	±0.01	Pass
50		13.559342	-658	-0.004853	±0.01	Pass

Voltage Variations

Temp. (°C)	Voltage (VAC)	Measured Frequency (MHz)	Delta Frequency (Hz)	Tolerance (%)	Limit (±%)	Result (Pass/Fail)
20	93.5	13.559333	-667	-0.004919	±0.01	Pass
	110	13.559304	-696	-0.005133	±0.01	Pass
	126.5	13.559344	-656	-0.004838	±0.01	Pass



7.2 POWERLINE CONDUCTED EMISSIONS

LIMIT

According to §15.207(a), except as shown in paragraphs (b) and (c) of this section, for an intentional radiator that is designed to be connected to the public utility (AC) power line, the radio frequency voltage that is conducted back onto the AC power line on any frequency or frequencies within the band 150 kHz to 30 MHz shall not exceed the limits in the following table, as measured using a 50 μ H/50 ohms line impedance stabilization network (LISN). Compliance with the provisions of this paragraph shall be based on the measurement of the radio frequency voltage between each power line and ground at the power terminal. The lower limit applies at the boundary between the frequency ranges.

Frequency Range (MHz)	Limits (dB μ V)	
	Quasi-peak	Average
0.15 to 0.50	66 to 56*	56 to 46*
0.50 to 5	56	46
5 to 30	60	50

* Decreases with the logarithm of the frequency.

Test Procedure

1. The EUT was placed on a table, which is 0.8m above ground plane.
2. Maximum procedure was performed on the six highest emissions to ensure EUT compliance.
3. Repeat above procedures until all frequency measured were complete.



Test Plots

Conducted emissions (Line 1)

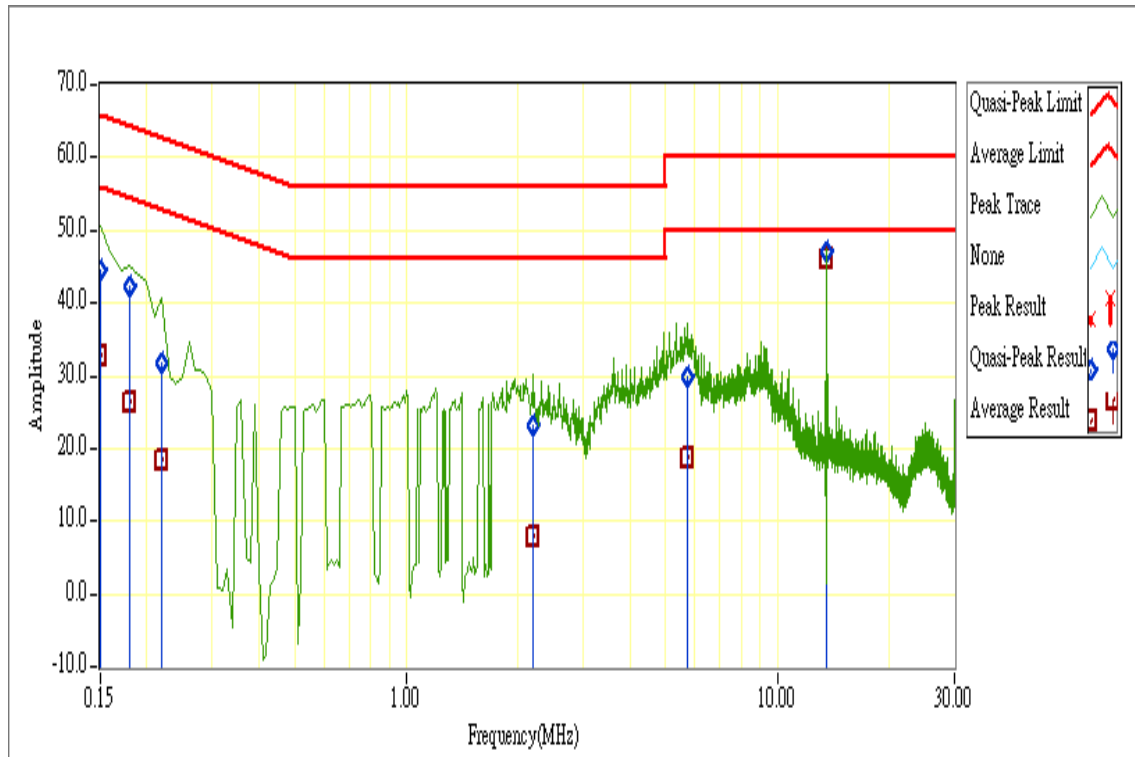

Conducted emissions (Line 2)

