

Regulatory WLAN Antenna Information

(English Language Required for Intel Regulatory Review / Approval)

**(OEM/ODM or antenna vendor is required to complete this document with platform antenna information.
Remove Intel references and make this your own document)**

Platform	
Platform Owner	DELL
Brand Name	
Model Name	
ODM	COMPAL
Target Launch Date	(YYYY/ MM/ DD)
Antenna	
Brand Name	GALTRONICS
Antenna Set Name	WLAN_L
Antenna Set P/N	021020201NC3793-1
Part Number	<input type="checkbox"/> Tx1 Antenna: 06-7015-03 (MAIN) <input type="checkbox"/> Tx2 Antenna: 06-7016-03 (AUX)
Antenna Set Name	WLAN_R
Antenna Set P/N	021020201NC3793-2
Part Number	<input type="checkbox"/> Tx3 Antenna: 06-7014-03 (MIMO)
Module	
With WLAN Module	
(Check Box)	
	<input type="checkbox"/> 533ANX Family
	<input type="checkbox"/> 512ANX Family
	<input type="checkbox"/> 533AN Family
	<input type="checkbox"/> 512AN Family

Antenna Sample / Antenna Data Requirements for worldwide regulatory approval

Section	Description of Required OEM / ODM Antenna Information	US / IC	EU	Japan	Taiwan	S.Korea
1A	Part Number for Antenna only	Required	Required	Required	Required	Required
1B	Antenna Manufacturer Name	Required	Required	Required	Required	Required
1C	Description of Antenna Type	Required	N/A	N/A	N/A	N/A
1D	Part number of Antenna Assembly / cable impedance, length & diameter.	Required	Desired	Desired	Desired	Desired
1E	Tx1, Tx2 & Tx3 antenna (Peak Gain W/ cable loss) *	Required	Required	Required	Required	Required
	1E OR 1F, 1G, 1H					
1F	Tx1, Tx2 & Tx3 antenna (Peak Gain only) *	Required	Required	Required	Required	Required
1G	VSWR of cable including connector	Required	Required	Required	Required	Required
1H	Tx1, Tx2 & Tx3 antenna (Cable loss W/ connector) *	Required	Required	Required	Required	Required
2	Dimensioned Photographs <u>and</u> Drawings of Tx1, Tx2, and Tx3 (or Rx3) antennas	Required	Required	Required	Required	Required
3	Radiation patterns of antennas loaded in the host platform.	Required	Desired	Required	N/A	Required
4	Platform model name / number - correlated to antenna manufacturer and antenna part number	Required	Required	Desired	Required	Desired
5	Photograph(s) or Drawings showing location of antennas in platform. <u>(S. Korea requires photographs of antennas for approval submission). Taiwan requires pictures of each antenna type shown in the system.</u>	Required	Required	Desired	<u>Required (Photos)</u>	<u>Required (Photos)</u>
6	Mech. drawings / photos with dimensions of antenna locations and distance from end-user (For evaluation of SAR testing requirement).	Required	N/A	N/A	N/A	N/A
7	Photograph(s) or Drawings showing the location of all antennas (WLAN, other) and distance between those transmitting antennas. Information will be used to evaluate whether co-location testing is required.	Required	N/A	N/A	N/A	N/A
8	Local representative contact information for LMA/ PARS process.	Required	N/A	N/A	N/A	N/A

NOTE:

(*) if 3rd antenna is Rx only (e.g. receive only for 4965AGN) then peak gain and cable loss not required

Antenna Information

Section 1. Antenna Assembly Specifications

Antenna Assembly Summary:

1A Antenna Part Number	1B Manufacture	1C Antenna Type	1D Cable Assembly Part Number and Information	1E *Peak Gain W/ Cable loss (dBi)	1F Peak Gain w/o Cable Loss (dBi)	1G VSWR	1H Cable Loss (dBi)
(P/N:06-7015-03) Tx1 antenna	Galtronics	PIFA	(P/N: 03-7007-01) 50 ohm Coaxial. length:53.9cm diameter: 1.13mm Connector: U.FL	2400-2500MHz -2.49 dBi (peak)	2400-2500MHz -1.15 dBi (peak)	2400-2500MHz 2.00 max	2400-2500MHz -1.34 dBi (peak)
				2496-2690MHz -2.19 dBi (peak)	2496-2690MHz -0.85 dBi (peak)	2496-2690MHz 1.47 max	2496-2690MHz -1.34 dBi (peak)
				5150-5350MHz -1.88 dBi (peak)	5150-5350MHz -0.36 dBi (peak)	5150-5350MHz 1.59 max	5150-5350MHz -2.24 dBi (peak)
				5470-5725MHz 0.40 dBi (peak)	5470-5725MHz 1.84 dBi (peak)	5470-5725MHz 1.73 max	5470-5725MHz -2.24 dBi (peak)
				5725-5850MHz -0.52 dBi (peak)	5725-5850MHz 1.72 dBi (peak)	5725-5850MHz 2.00 max	5725-5850MHz 2.24 dBi (peak)
(P/N:06-7016-03) Tx2 antenna	Galtronics	PIFA	(P/N: 03-7008-01) 50 ohm Coaxial. length:49.1cm diameter: 1.13mm Connector: U.FL	2400-2500MHz 0.18 dBi (peak) *	2400-2500MHz 1.40 dBi (peak) *	2400-2500MHz 1.80 max *	2400-2500MHz -1.22 dBi (peak) *
				2496-2690MHz 0.18 dBi (peak) *	2496-2690MHz 1.40 dBi (peak) *	2496-2690MHz 1.56 max *	2496-2690MHz -1.22 dBi (peak) *
				5150-5350MHz 1.32 dBi (peak) *	5150-5350MHz 3.36 dBi (peak) *	5150-5350MHz 2.50 max *	5150-5350MHz -2.04 dBi (peak) *
				5470-5725MHz -0.60dBi (peak) *	5470-5725MHz 1.44 dBi (peak) *	5470-5725MHz 2.03max *	5470-5725MHz -2.04 dBi (peak) *
				5725-5850MHz -1.31 dBi (peak) *	5725-5850MHz 0.73 dBi (peak) *	5725-5850MHz 1.65 max *	5725-5850MHz -2.04 dBi (peak) *
(P/N:06-7014-03) Tx3 antenna	Galtronics	PIFA	(P/N: 03-7009-01) 50 ohm Coaxial. length:32.9cm diameter: 1.13mm Connector: U.FL	2400-2500MHz -1.8 dBi (peak) *	2400-2500MHz -0.98 dBi (peak) *	2400-2500MHz 2.65 max *	2400-2500MHz -0.82 dBi (peak) *
				2496-2690MHz -1.28 dBi (peak) *	2496-2690MHz -0.46 dBi (peak) *	2496-2690MHz 1.36 max *	2496-2690MHz -0.82 dBi (peak) *
				5150-5350MHz 1.37 dBi (peak) *	5150-5350MHz 0 dBi (peak) *	5150-5350MHz 1.13 max *	5150-5350MHz -1.37 dBi (peak) *
				5470-5725MHz -0.87 dBi (peak) *	5470-5725MHz 0.50 dBi (peak) *	5470-5725MHz 1.21 max *	5470-5725MHz -1.37 dBi (peak) *
				5725-5850MHz -1.76 dBi (peak) *	5725-5850MHz -0.39 dBi (peak) *	5725-5850MHz 1.73 max *	5725-5850MHz -1.37 dBi (peak) *

NOTE:

(*) If Rx2/Rx3 only (2nd or 3rd antenna receives only, e.g. for 512 family & 4965AGN) then the information marked with * is not required

Antenna Peak Gain Table:

Frequency (MHz)	Tx1 antenna		Tx2 Antenna		Tx3 Antenna	
	Horizontal (dBi)	Vertical (dBi)	Horizontal (dBi)	Vertical (dBi)	Horizontal (dBi)	Vertical (dBi)
2400	-2.49	-4.62	-1.84	-6.34	-3.01	-3.40
2450	-2.84	-2.73	-2.76	-3.52	-0.69	-3.12
2500	-3.97	-2.69	-2.33	-2.41	-2.00	-2.87
2500	-3.97	-2.69	-2.33	-2.41	-2.00	-2.87
2600	-2.23	-3.06	-1.62	-5.19	-1.35	-3.63
2700	-2.78	-2.19	-3.20	-2.54	-2.75	-3.10
5150	-6.38	-1.88	-7.72	-1.07	-11.42	-3.46
5470	-4.66	0.30	-8.86	-1.71	-6.27	-0.83
5600	-6.23	0.40	-8.63	-2.10	-4.30	0.64
5785	-7.23	-2.04	-9.22	-4.54	-3.23	0.15
5850	-3.27	-0.52	-6.55	-2.48	-2.57	1.62

- Antenna Peak Gain required being test in system basis.
- 1E frame contend absolutely peak antenna gain include H/V

Section 2. Dimensioned Photos or Drawings of Antennas

Include a dimensioned photo and dimensioned drawing of Tx1 antenna here.

Tx1 Antenna Dimensioned Drawing: (MAIN)

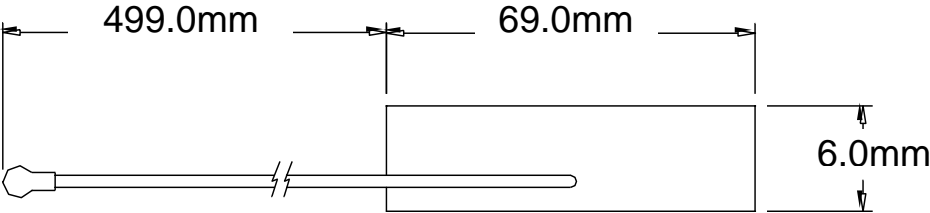

Tx1 Antenna Photo:



Include a dimensioned photo and dimensioned drawing of Tx2 antenna here.

Tx2 Antenna Dimensioned Drawing: (AUX)

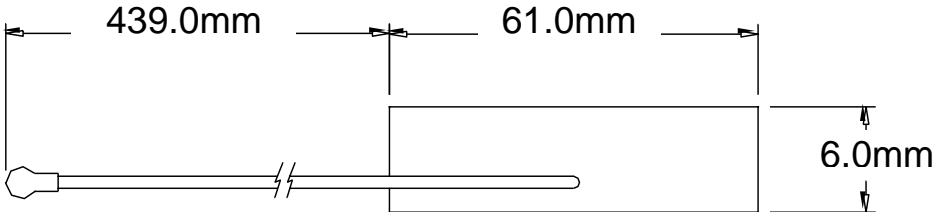

Tx2 Antenna Photo:



Include a dimensioned photo and dimensioned drawing of Tx3 antenna here.

Tx3 Antenna Dimensioned Drawing: (MIMO)

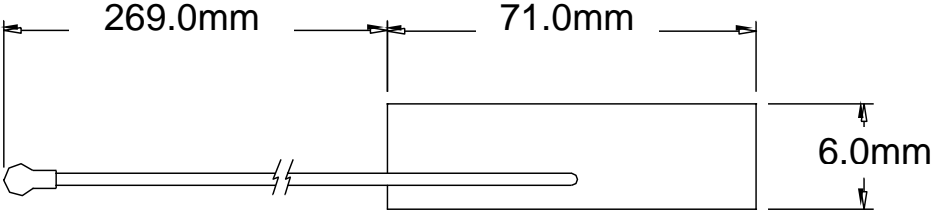

Tx3 Antenna Photo:



Include front view photo of all 3 antennas here.

Antenna Manufacturer: Galtronics

Antenna Part Number: 06-7015-03 (Tx1), 06-7016-03 (Tx2), 06-7014-03 (Tx3)



Include back view photo of all 3 antennas here.

Antenna Manufacturer: Galtronics

Antenna Part Number: 06-7015-03 (Main), 06-7016-03 (Aux), 06-7014-03 (MIMO)



Section 3. Radiation characteristics of antennae Loaded in Host Platform

2400-2500MHz radiation characteristic

Tx1 antenna: 2400 MHz

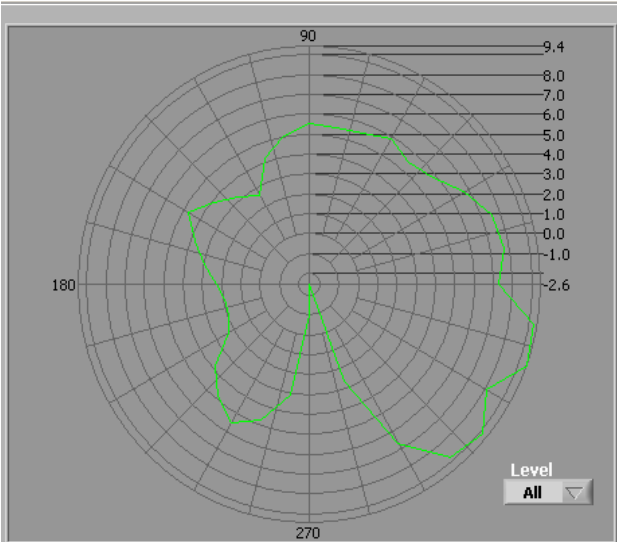

Total

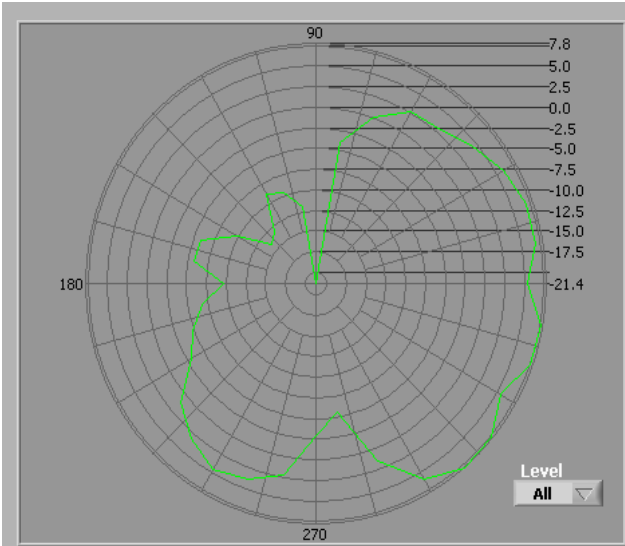

Horizontal

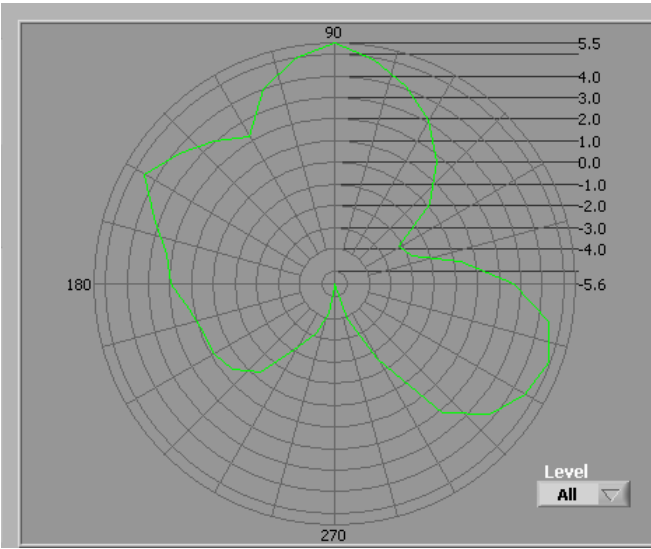

Vertical

Center Frequency	2400 MHz
Horizontal (dBi) peak	-2.49
Vertical (dBi) peak	-4.62

Tx1 antenna: 2450 MHz

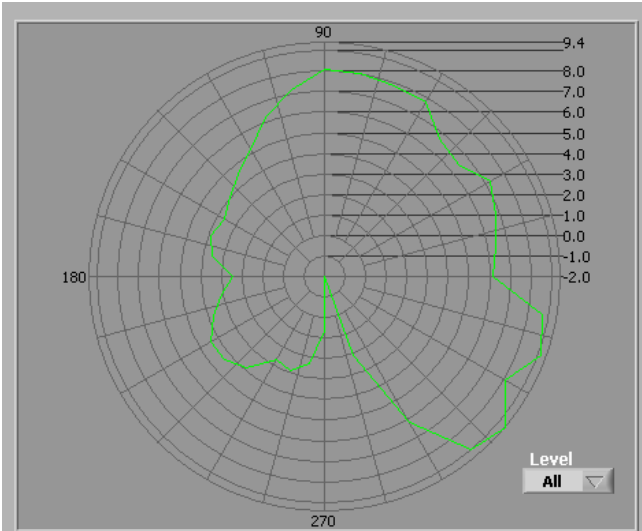

Total

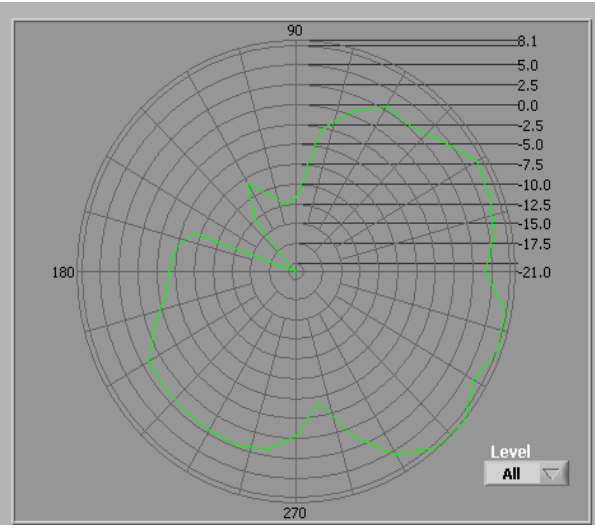

Horizontal

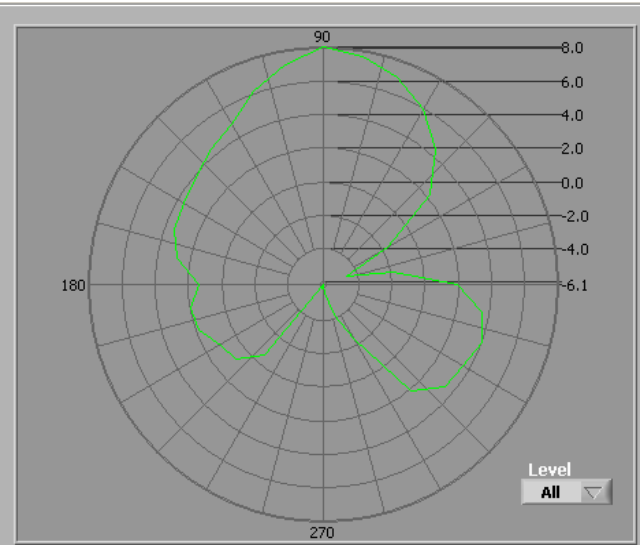

Vertical

Center Frequency	2450 MHz
Horizontal (dBi) peak	-2.84
Vertical (dBi) peak	-2.73

Tx1 antenna: 2500 MHz

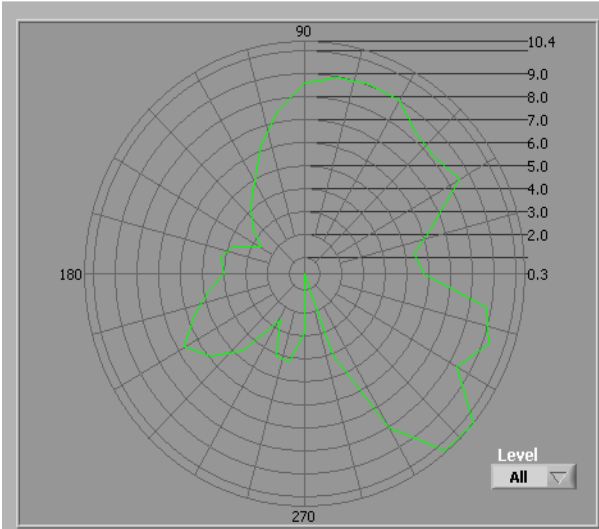

Total

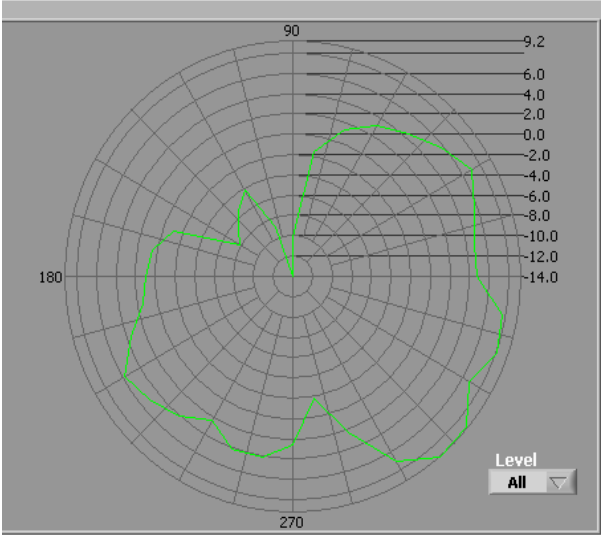

Horizontal

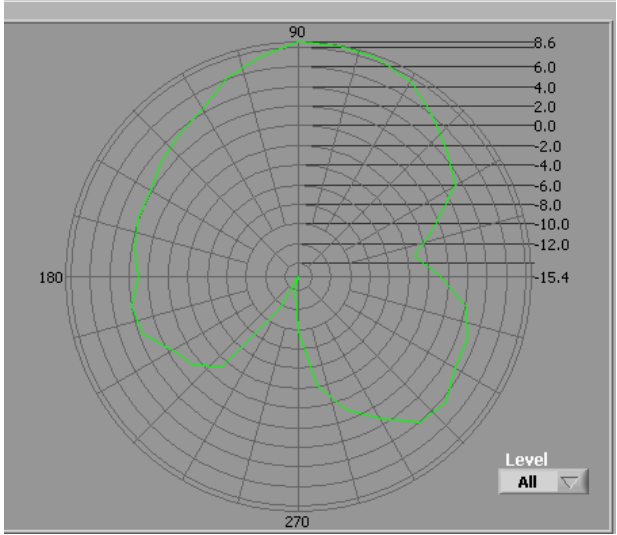

Vertical

Center Frequency	2500 MHz
Horizontal (dBi) peak	-3.97
Vertical (dBi) peak	-2.69

Tx2 (or Rx2) antenna: 2400 MHz (Plot is not required if 2nd Antenna is receive only e.g. Rx2 for 512 family)

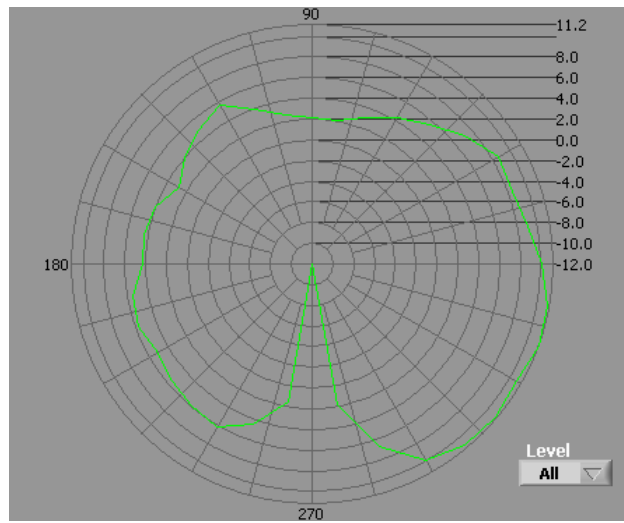

Total

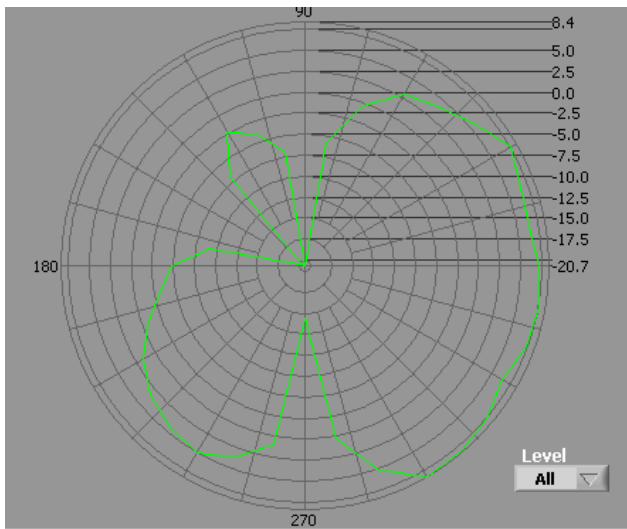

Horizontal

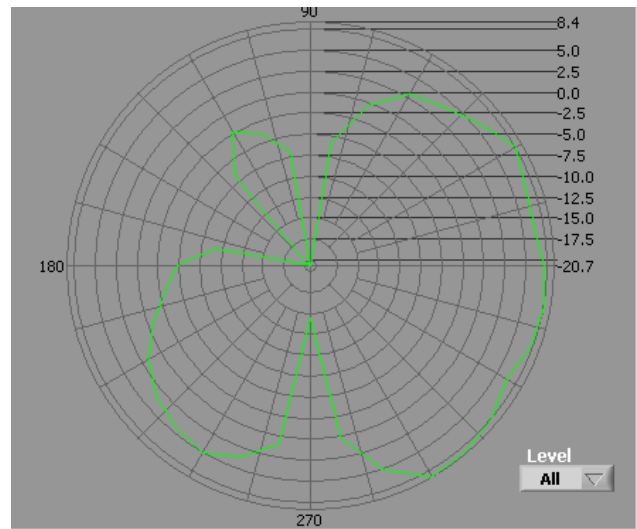

Vertical

Center Frequency	2400 MHz
Horizontal (dBi) peak	-1.84
Vertical (dBi) peak	-6.34

Tx2 (or Rx2) antenna: 2450 MHz (Plot is not required if 2nd Antenna is receive only e.g. Rx2 for 512 family)

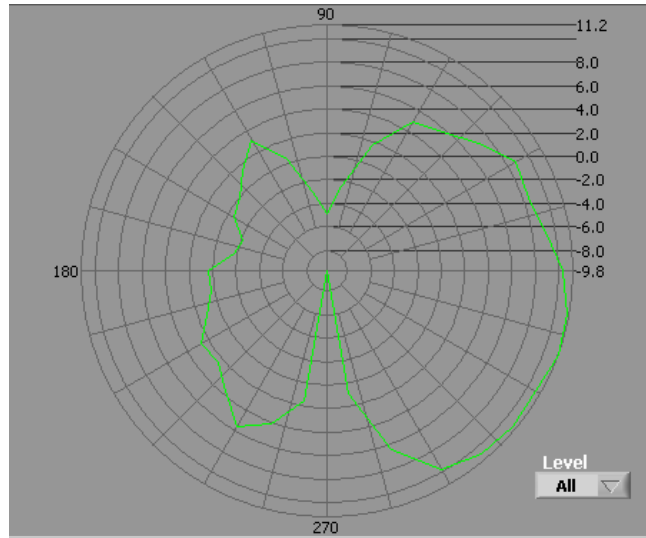

Total

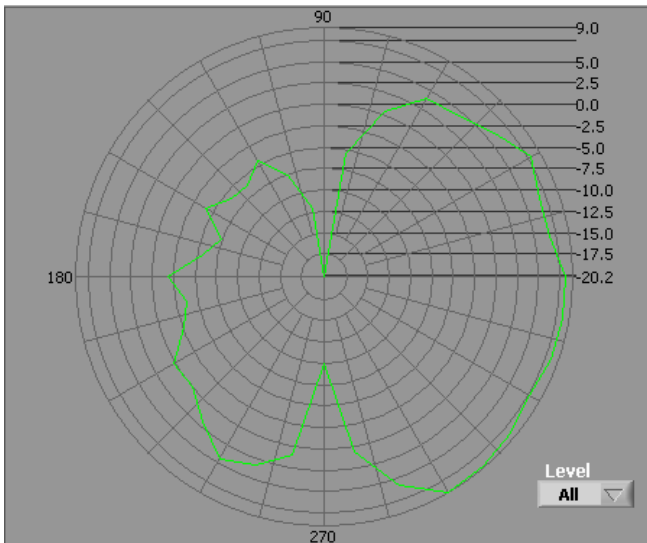

Horizontal

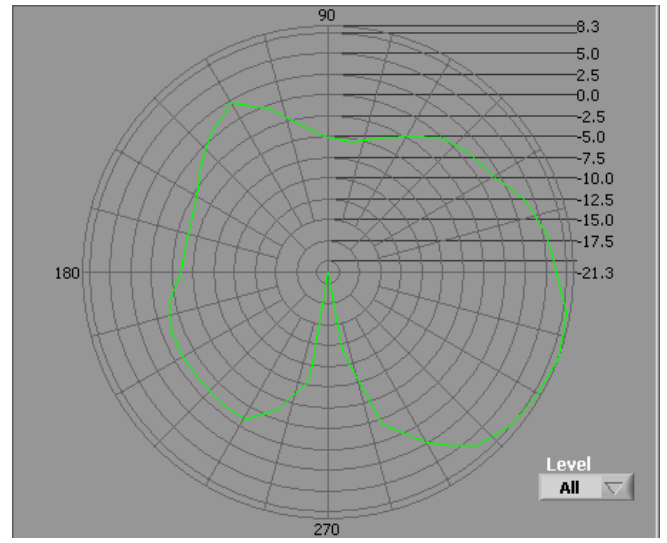

Vertical

Center Frequency	2450 MHz
Horizontal (dBi) peak	-2.76
Vertical (dBi) peak	-3.52

Tx2 (or Rx2) antenna: 2500 MHz (Plot is not required if 2nd Antenna is receive only e.g. Rx2 for 512 family)

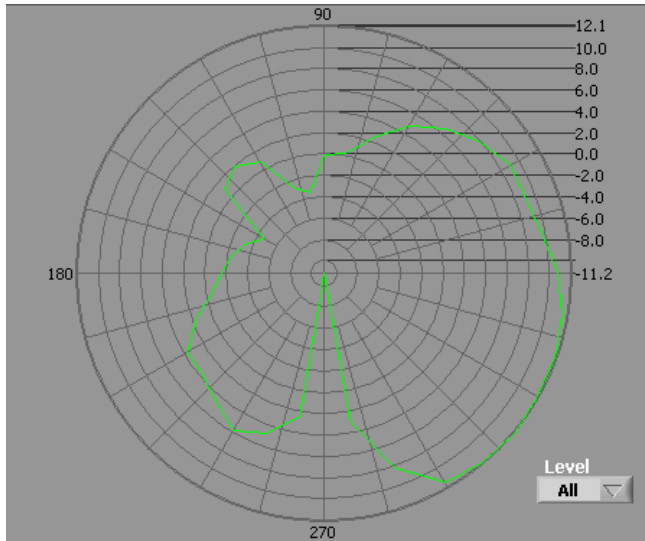

Total

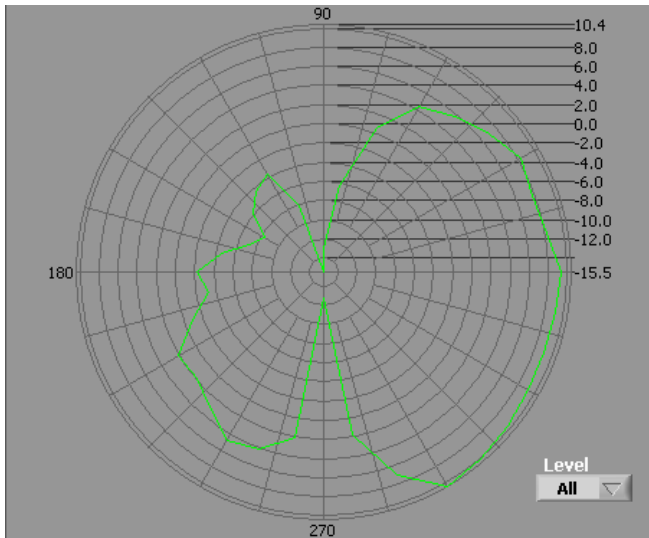

Horizontal

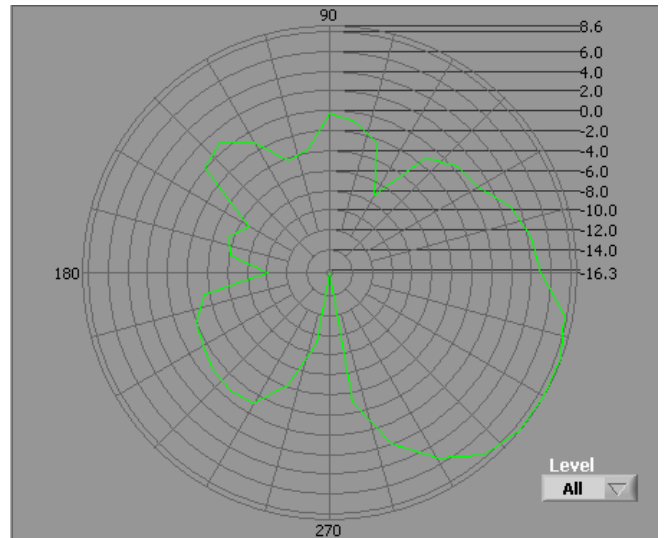

Vertical

Center Frequency	2500 MHz
Horizontal (dBi) peak	-2.33
Vertical (dBi) peak	-2.41

Tx3 (or Rx3) antenna: 2400 MHz (Plot is not required if 3rd Antenna is receive only e.g. Rx3 for 4965AGN)

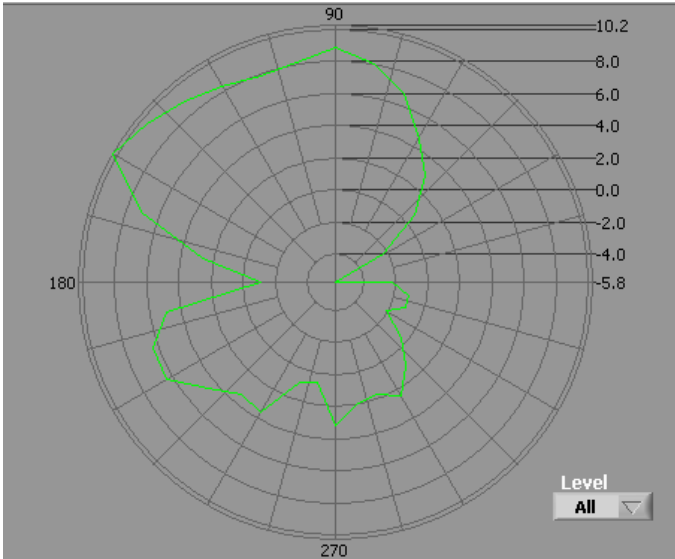

Total

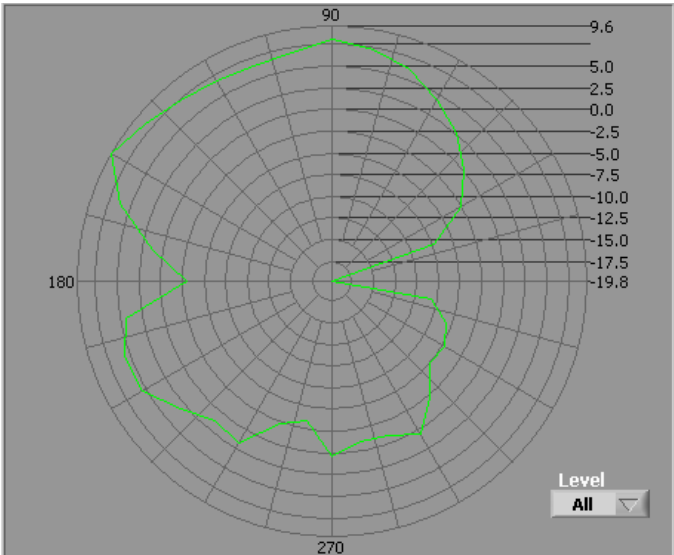

Horizontal

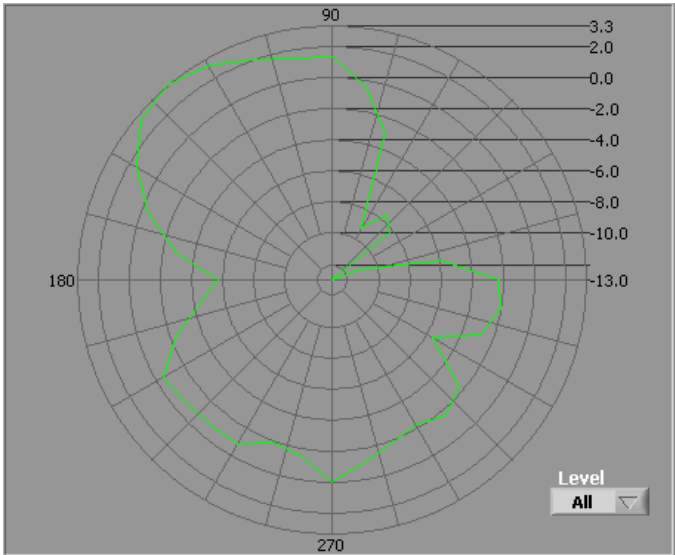

Vertical

Center Frequency	2400 MHz
Horizontal (dBi) peak	-3.01
Vertical (dBi) peak	-3.70

Tx3 (or Rx3) antenna: 2450 MHz (Plot is not required if 3rd Antenna is receive only e.g. Rx3 for 4965AGN)

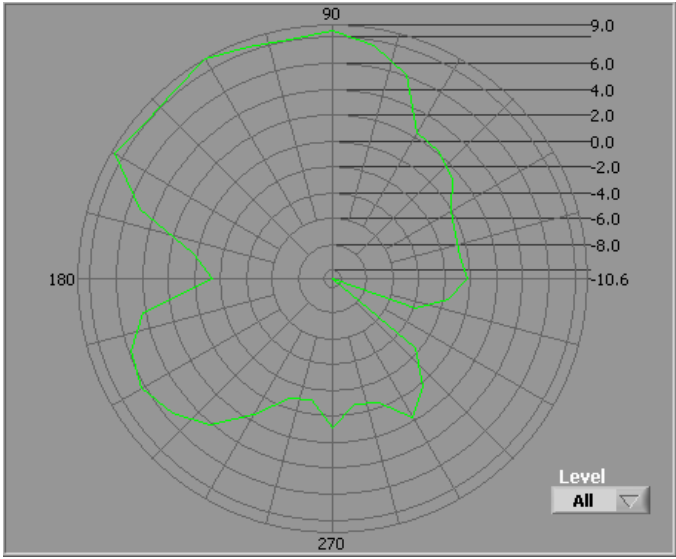

Total

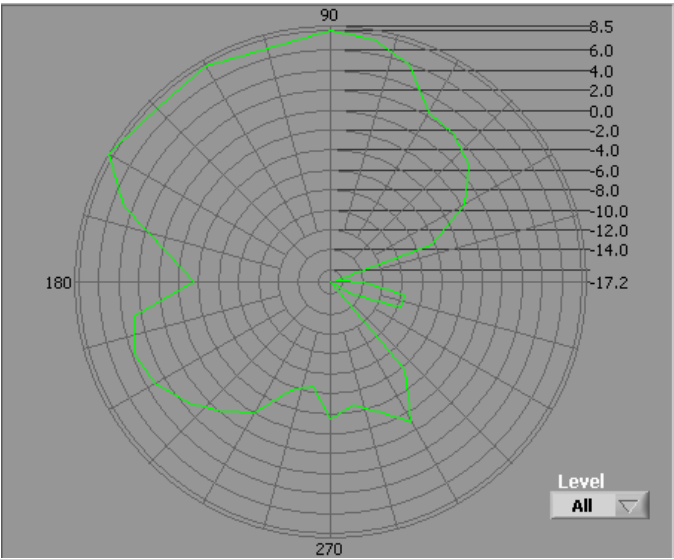

Horizontal

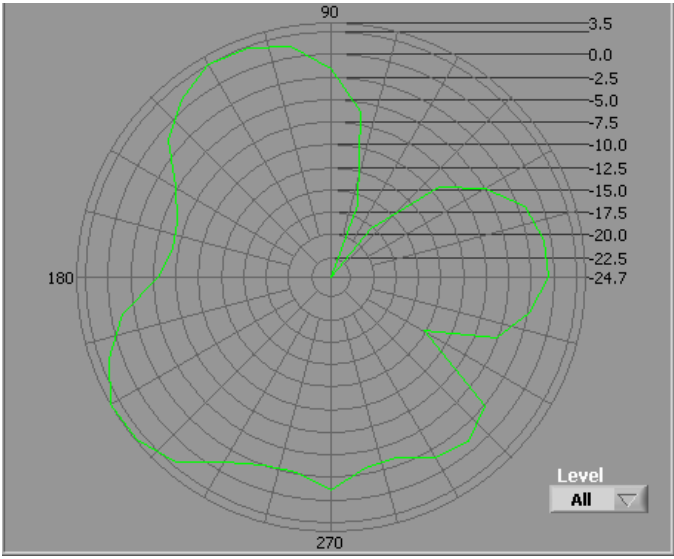

Vertical

Center Frequency	2450 MHz
Horizontal (dBi) peak	-0.69
Vertical (dBi) peak	-3.12

Tx3 (or Rx3) antenna: 2500 MHz (Plot is not required if 3rd Antenna is receive only e.g. Rx3 for

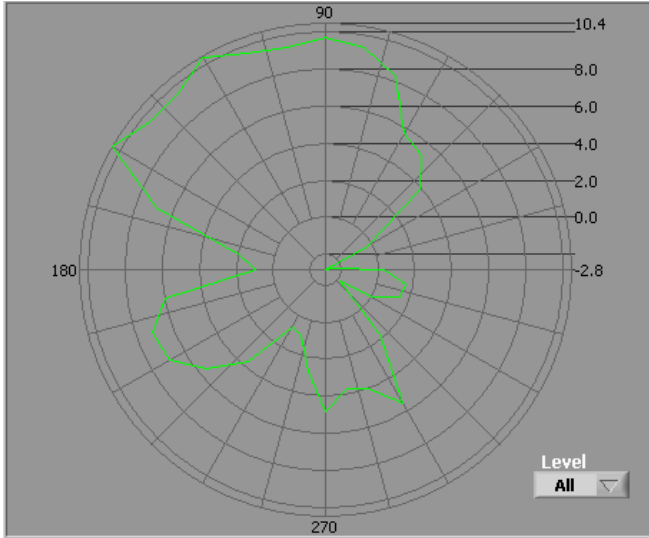

4965AGN)

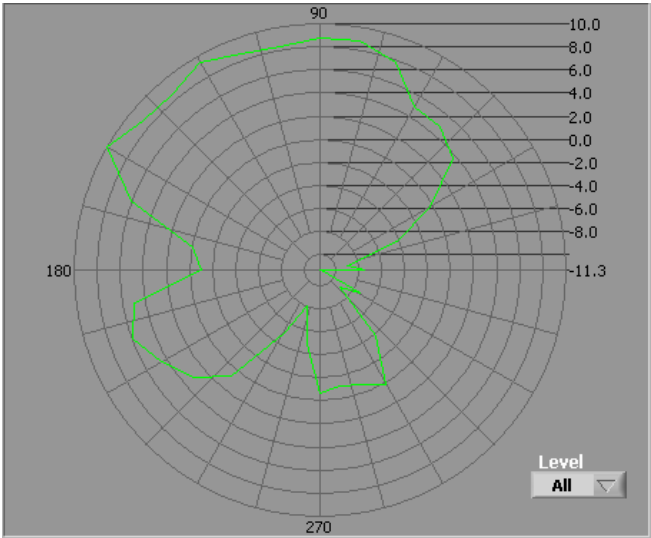

Horizontal

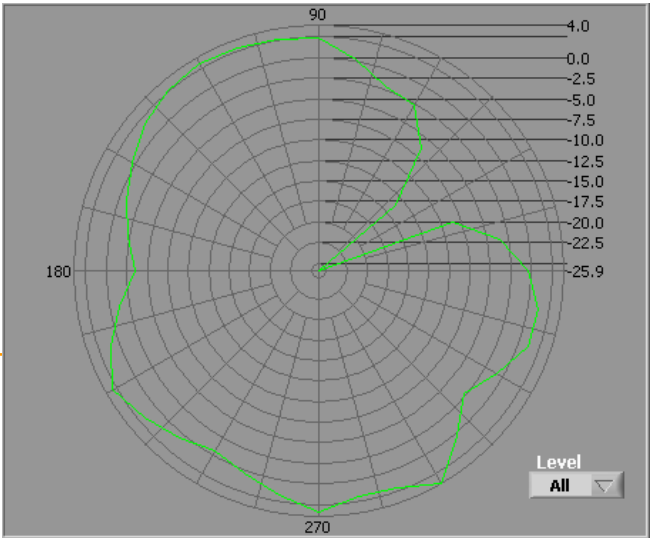

Vertical

Total

Center Frequency	2500 MHz
Horizontal (dBi) peak	-2
Vertical (dBi) peak	-2.87

2490-2700MHz radiation characteristic

Tx1 antenna: 2500MHz

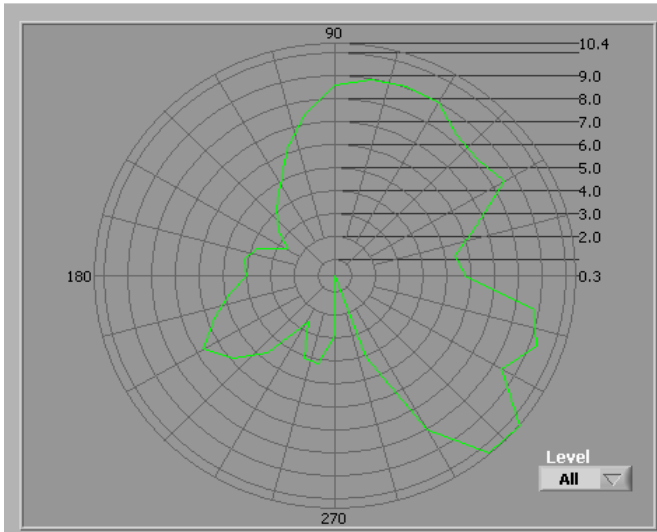

Total

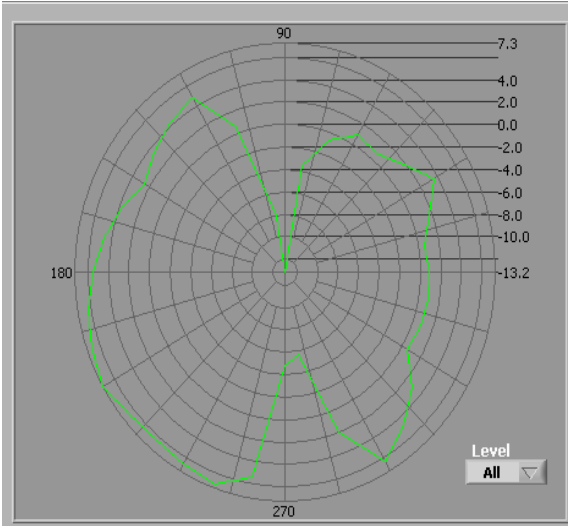

Horizontal

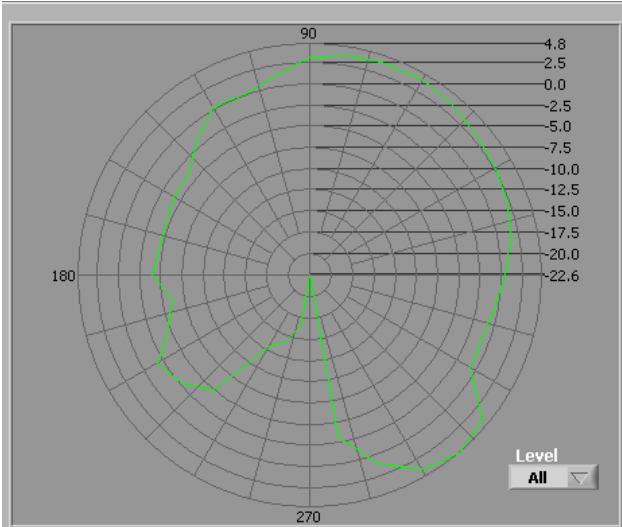

Vertical

Center Frequency	2500 MHz
Horizontal (dBi) peak	-3.97
Vertical (dBi) peak	-2.69

Tx1 antenna: 2600MHz

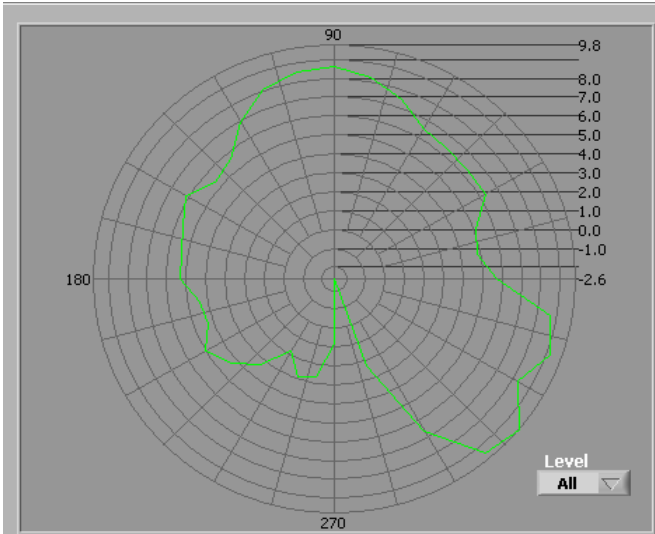

Total

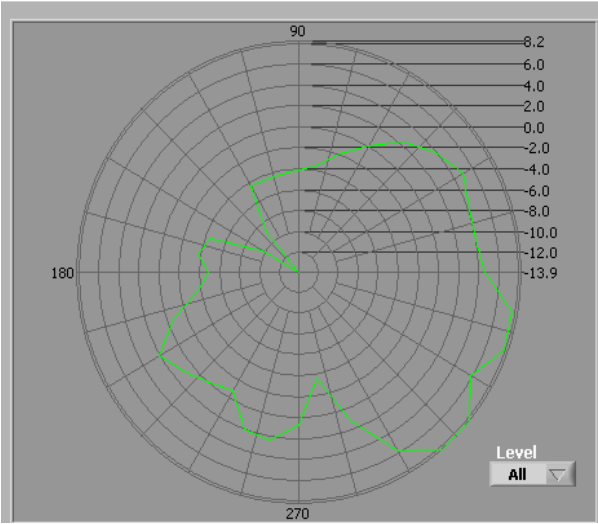

Horizontal

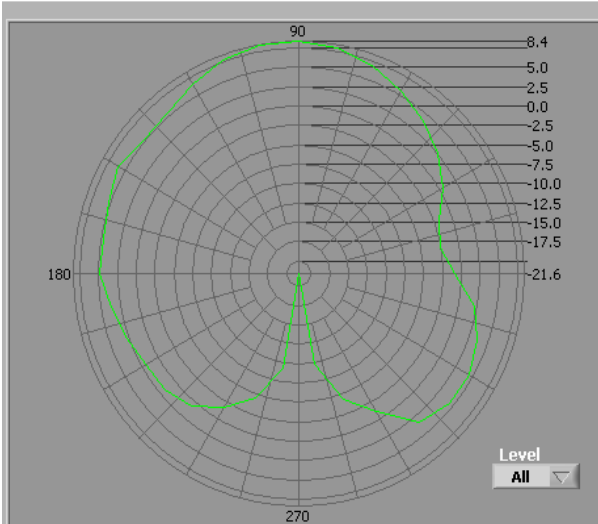

Vertical

Center Frequency	2600 MHz
Horizontal (dBi) peak	-2.23
Vertical (dBi) peak	-3.06

Tx1 antenna: 2700 MHz

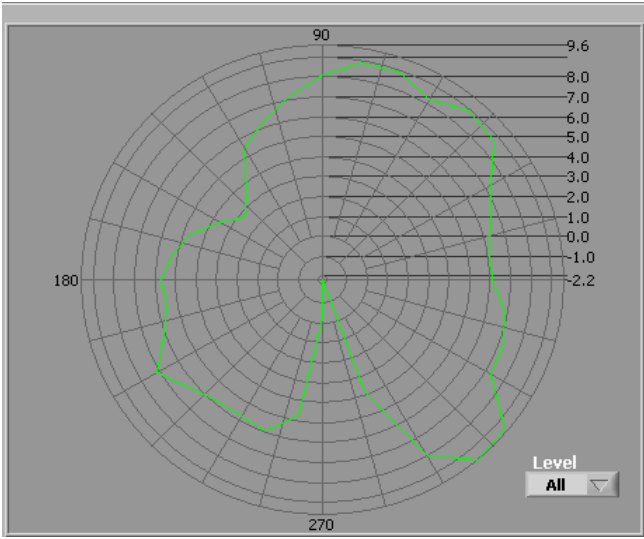

Total

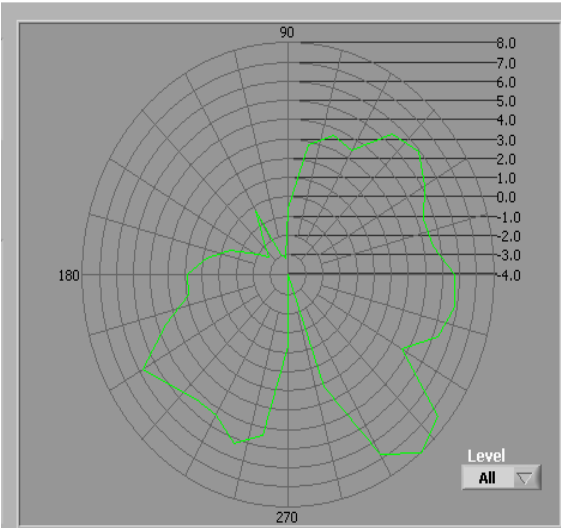

Horizontal

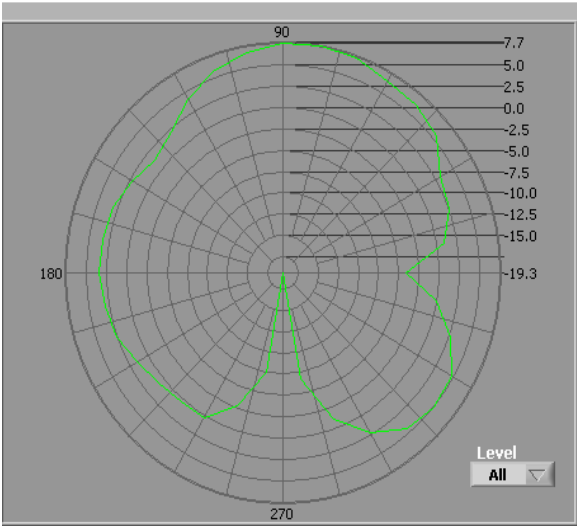

Vertical

Center Frequency	2700 MHz
Horizontal (dBi) peak	-2.78
Vertical (dBi) peak	-2.19

Tx2 (or Rx2) antenna: 2500MHz (Plot is not required if 2nd Antenna is receive only e.g. Rx2 for 512 family)

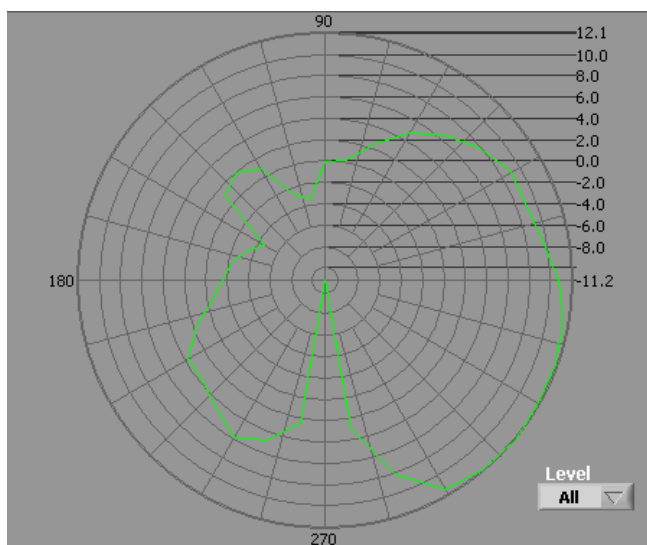

Total

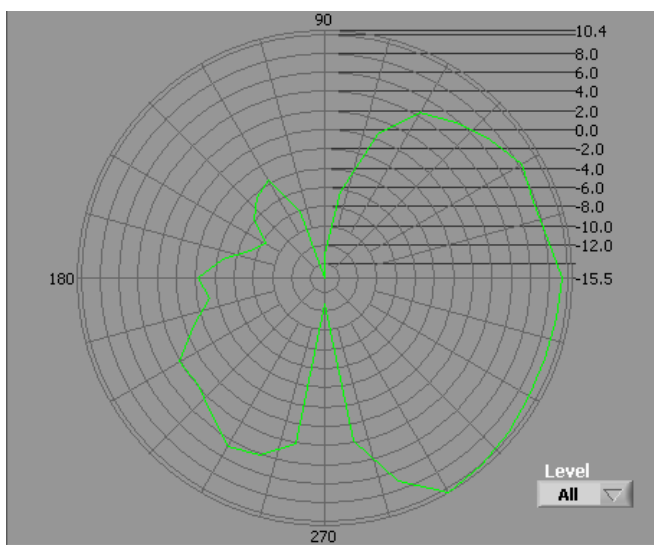

Horizontal

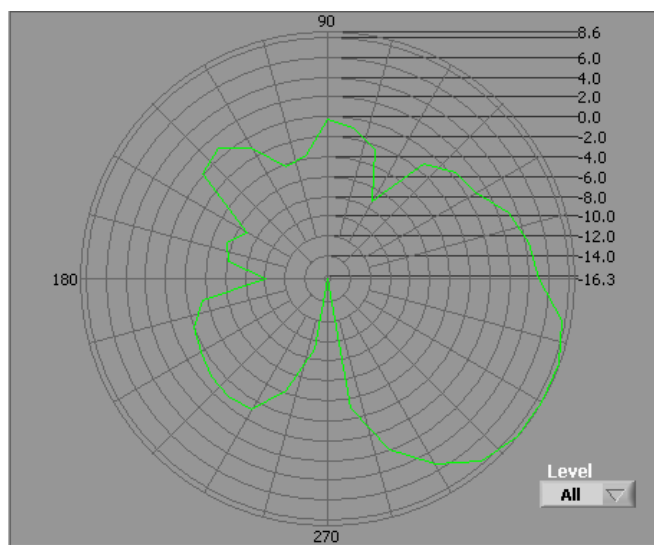

Vertical

Center Frequency	2500 MHz
Horizontal (dBi) peak	-2.33
Vertical (dBi) peak	-2.41

Tx2 (or Rx2) antenna: 2600MHz (Plot is not required if 2nd Antenna is receive only e.g. Rx2 for 512 family)

1

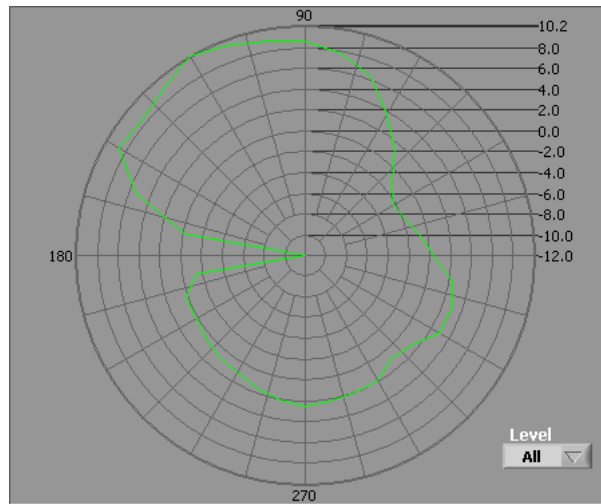

total

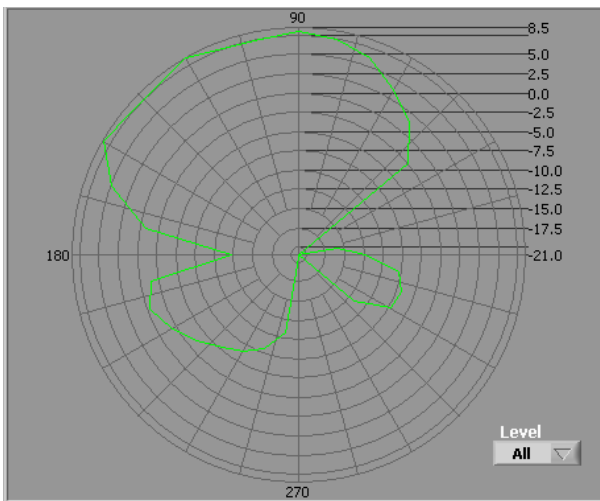

Horizontal

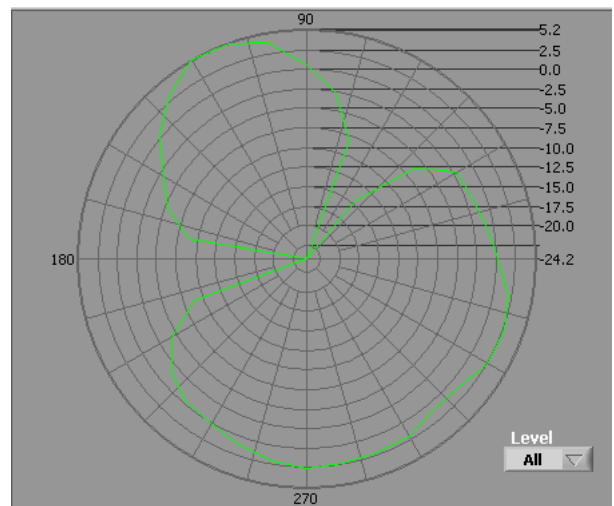

Vertical

Center Frequency	2600 MHz
Horizontal (dBi) peak	-1.62
Vertical (dBi) peak	-5.19

Tx2 (or Rx2) antenna: 2700 MHz (Plot is not required if 2nd Antenna is receive only e.g. Rx2 for 512 family)

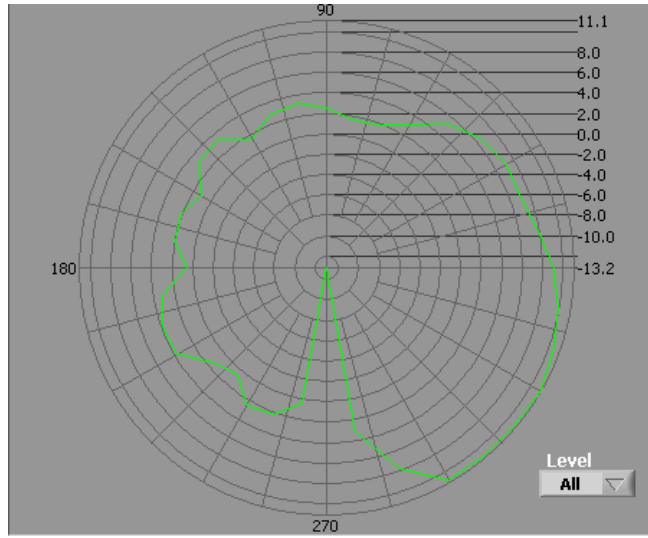

Total

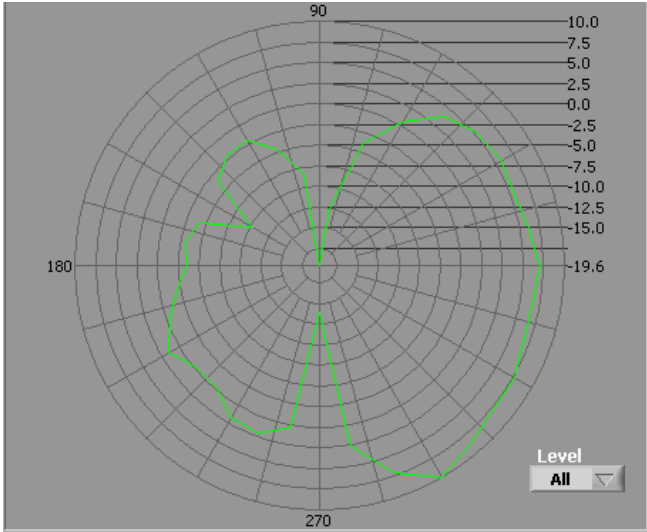

Horizontal

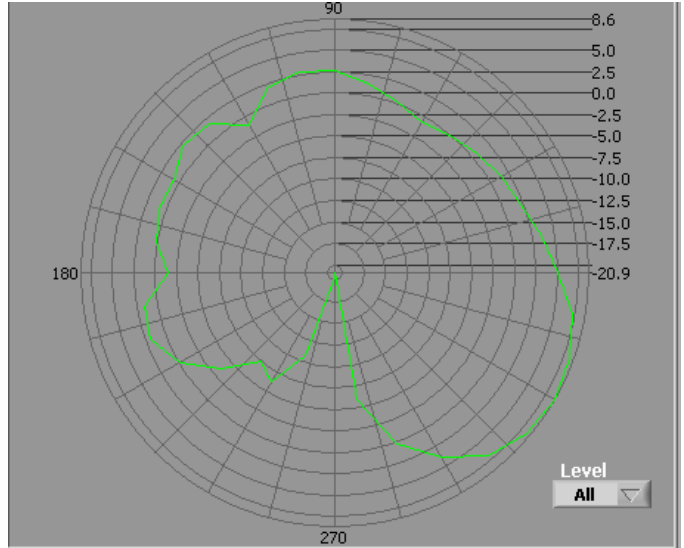

Vertical

Center Frequency	2700 MHz
Horizontal (dBi) peak	-3.20
Vertical (dBi) peak	-2.54

Tx3 (or Rx3) antenna: 2500 MHz (Plot is not required if 3rd Antenna is receive only e.g. Rx3 for 4965AGN)

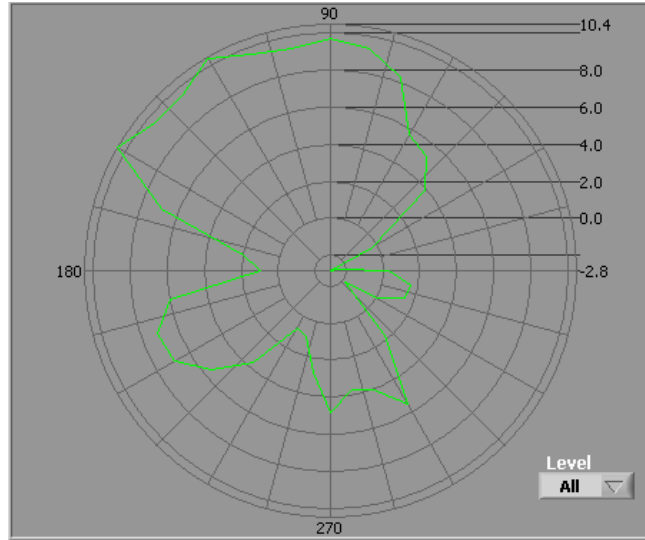

Total

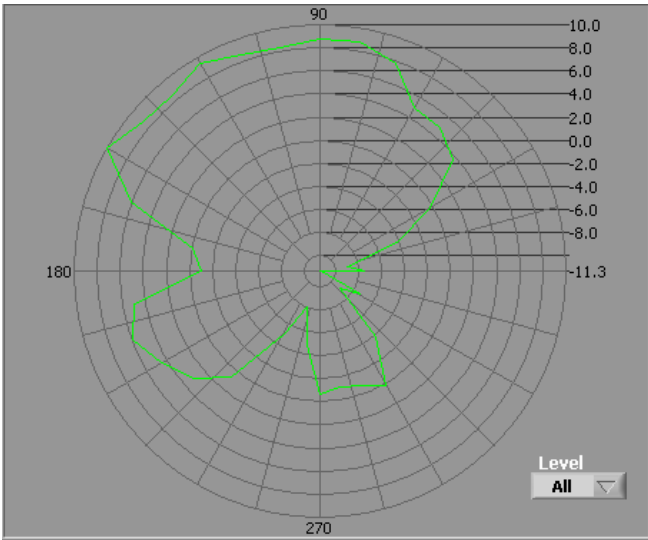

Horizontal

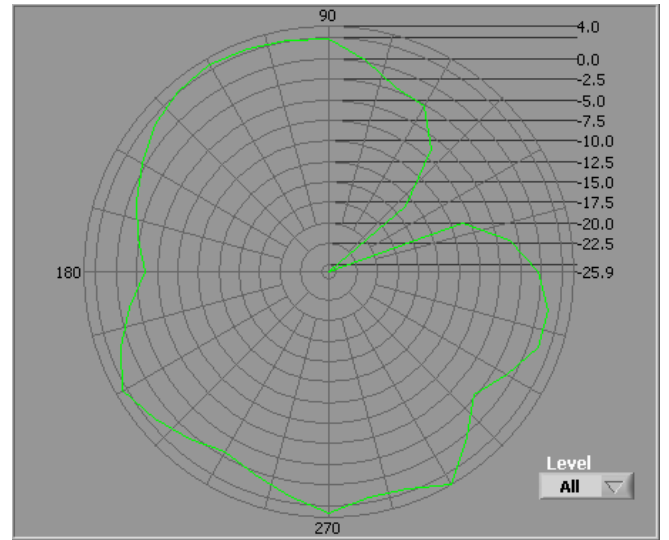

Vertical

Center Frequency	2500 MHz
Horizontal (dBi) peak	-2
Vertical (dBi) peak	-2.87

Tx3 (or Rx3) antenna: 2600MHz (Plot is not required if 3rd Antenna is receive only e.g. Rx3 for 4965AGN)

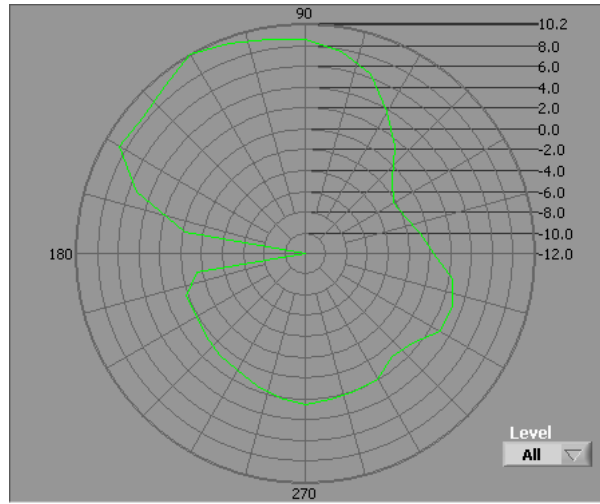

Total

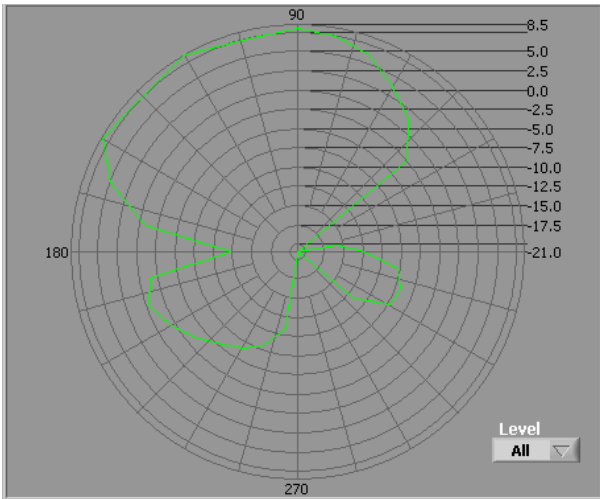

Horizontal

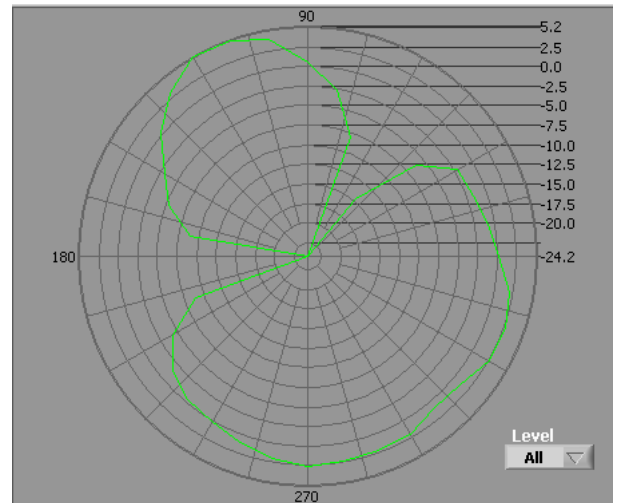

Vertical

Center Frequency	2600 MHz
Horizontal (dBi) peak	-1.35
Vertical (dBi) peak	-3.63

Tx3 (or Rx3) antenna: 2700 MHz (Plot is not required if 3rd Antenna is receive only e.g. Rx3 for 4965AGN)

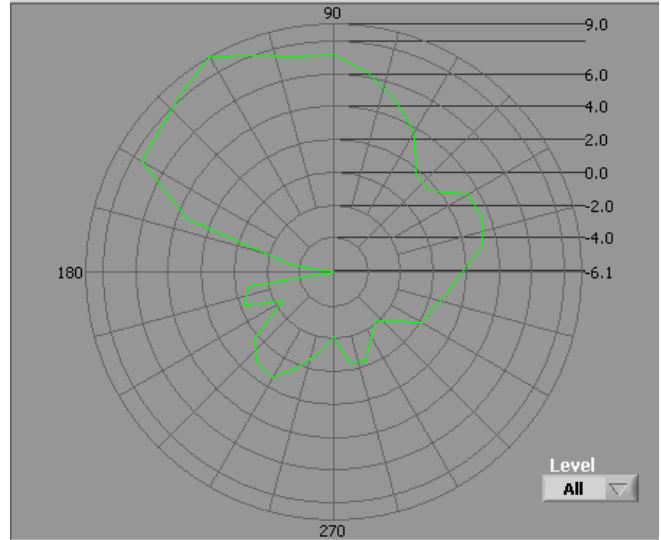

Total

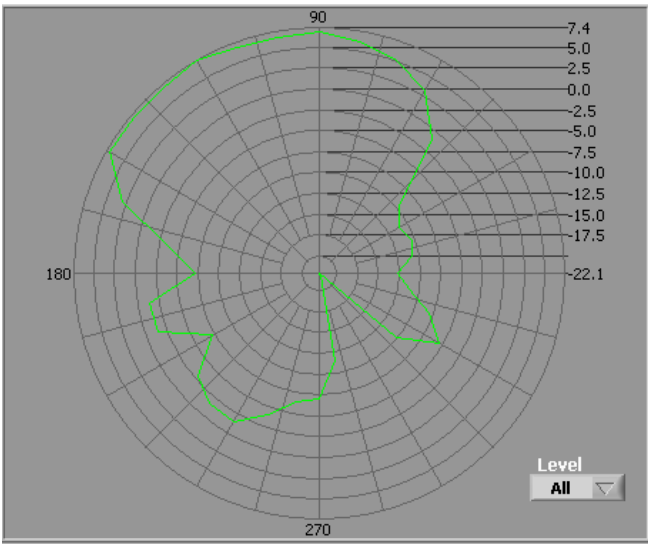

Horizontal

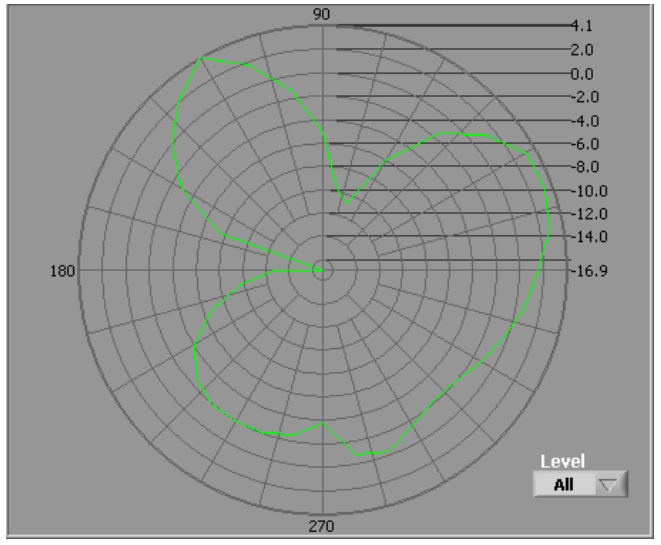

Vertical

Center Frequency	2700 MHz
Horizontal (dBi) peak	-2.75
Vertical (dBi) peak	-3.1

5150-5350 MHz radiation characteristic

Tx1 antenna: 5150 MHz

Far-Field Phi Cut, Theta=90 f=5.1500 GHz

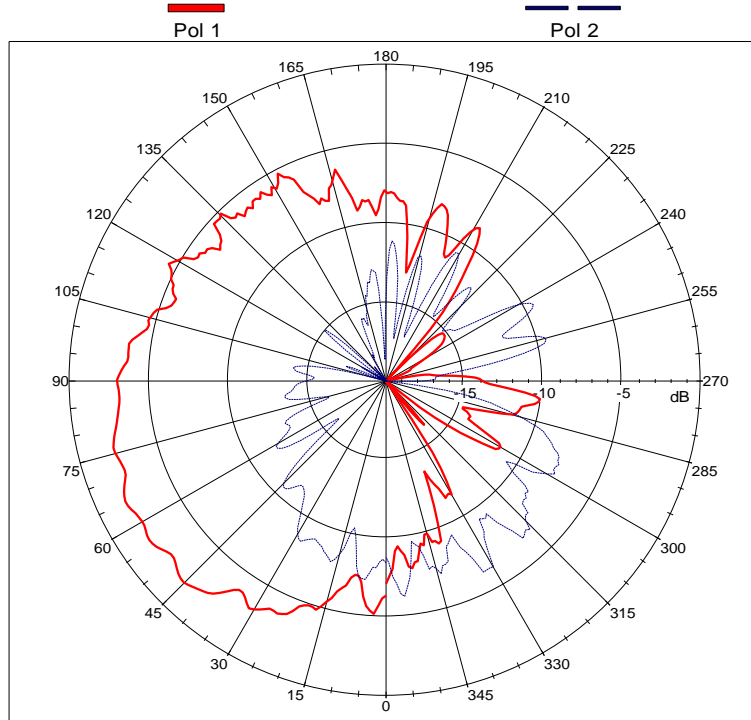

Far-Field Pwr SumPhi Cut, Theta=90 f=5.1500 GHz

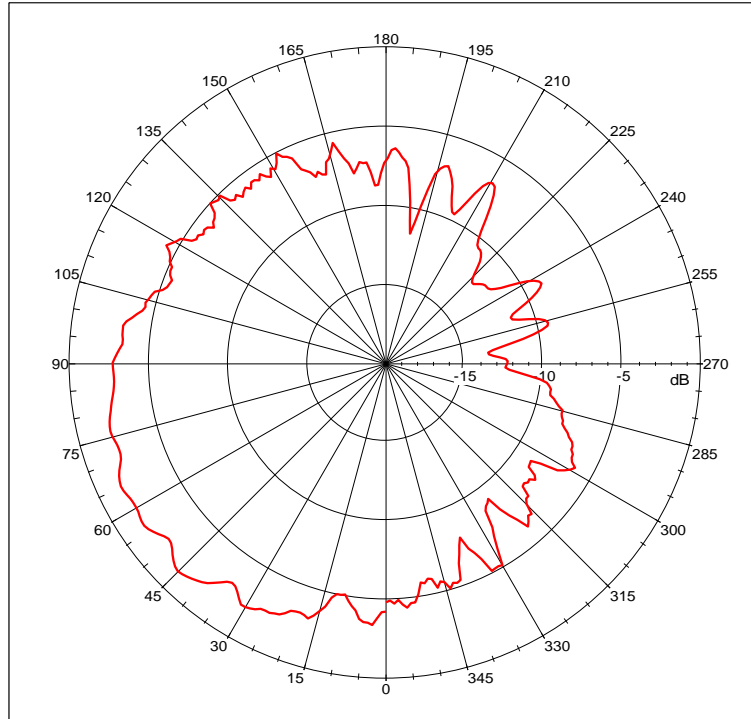

Center Frequency	5150 MHz
Horizontal (dBi) peak	-6.38
Vertical (dBi) peak	-1.88

Tx2 (or Rx2) antenna: 5150 MHz (Plot is not required if 2nd Antenna is receive only e.g. Rx2 for 512 family)

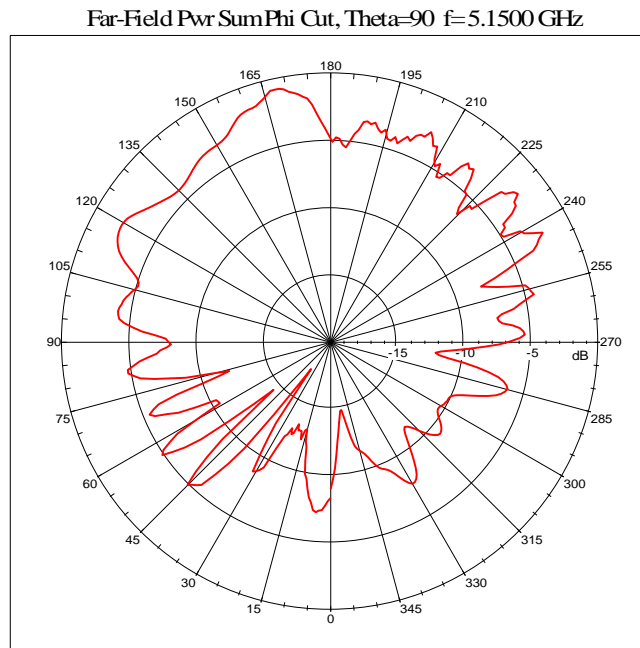
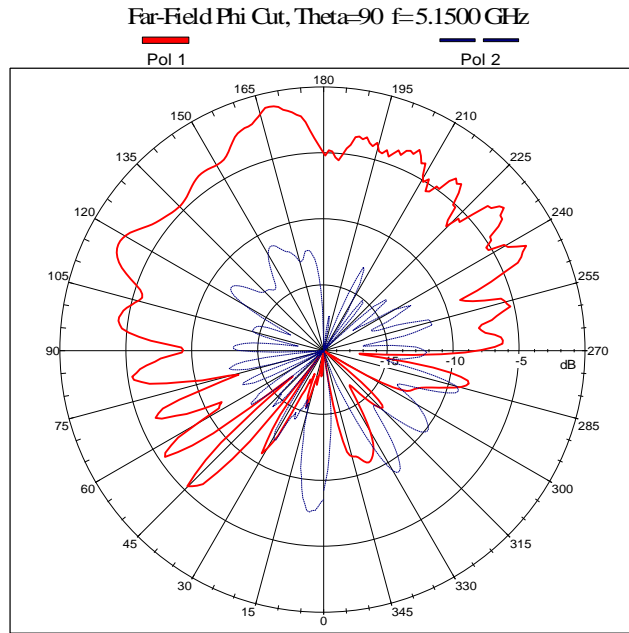

Center Frequency	5150 MHz
Horizontal (dBi) peak	-7.721
Vertical (dBi) peak	-1.071

Tx3 (or Rx3) antenna: 5150 MHz (Plot is not required if 3rd Antenna is receive only e.g. Rx3 for 4965AGN)

Far-Field Pwr SumPhi Cut, Theta=90 f=5.1500 GHz

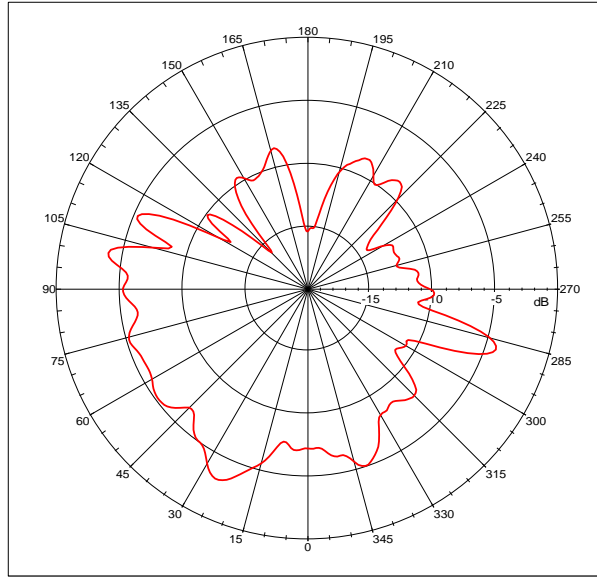

Far-Field Phi Cut, Theta=90 f=5.1500 GHz

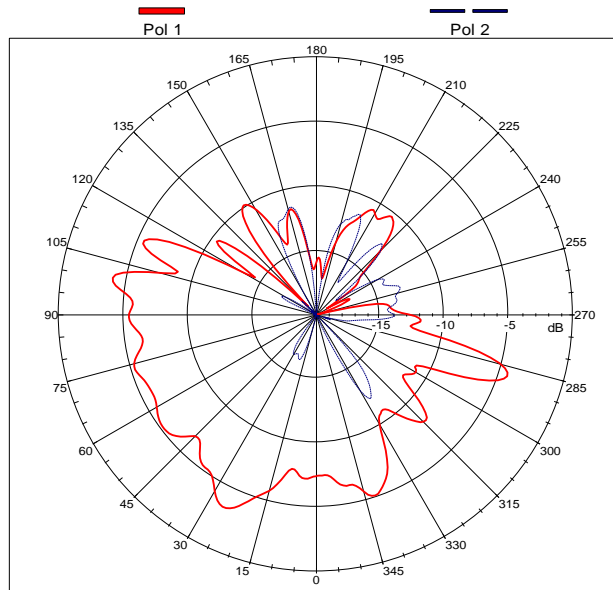

Center Frequency	5150 MHz
Horizontal (dBi) peak	-11.4
Vertical (dBi) peak	-3.46

5470-5725MHz radiation characteristic

Tx1 antenna: 5470 MHz

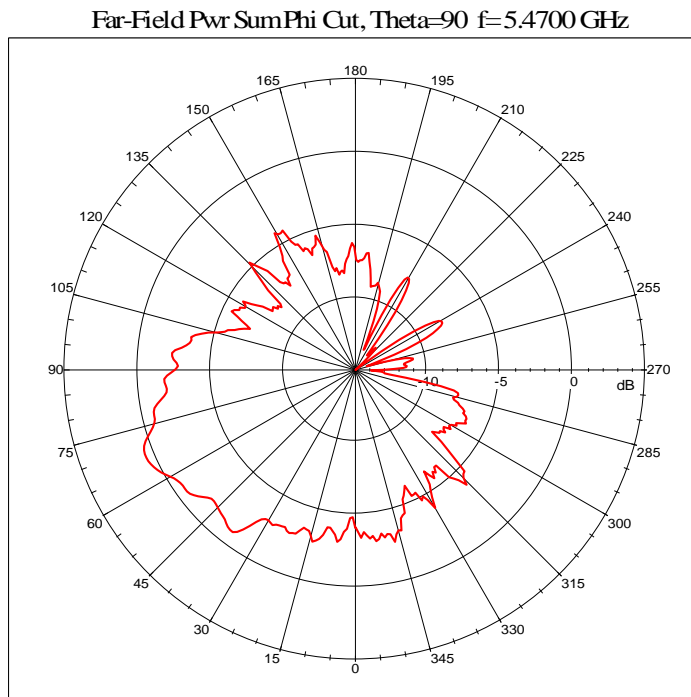
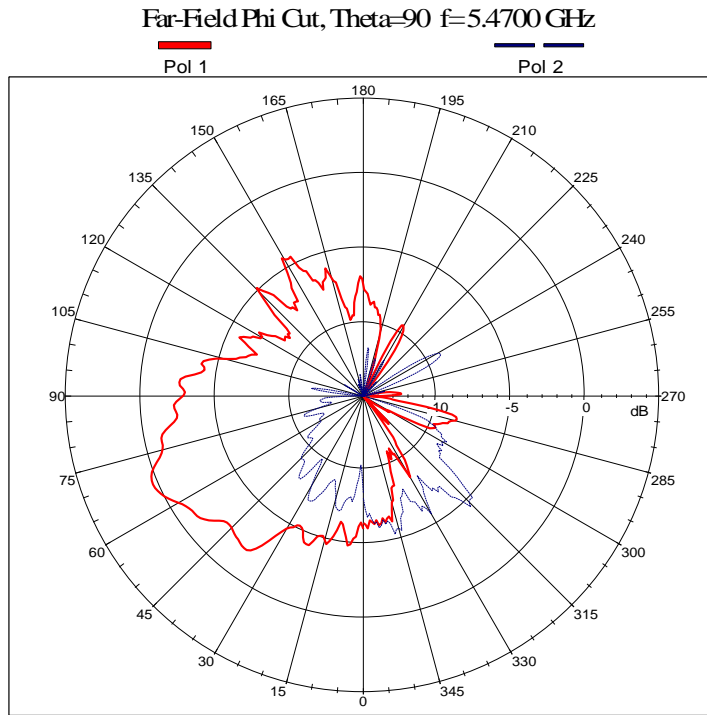

Center Frequency	5470 MHz
Horizontal (dBi) peak	-4.66
Vertical (dBi) peak	0.30

Tx1 antenna: 5600 MHz

Far-Field Phi Cut, Theta=90 f=5.6000 GHz

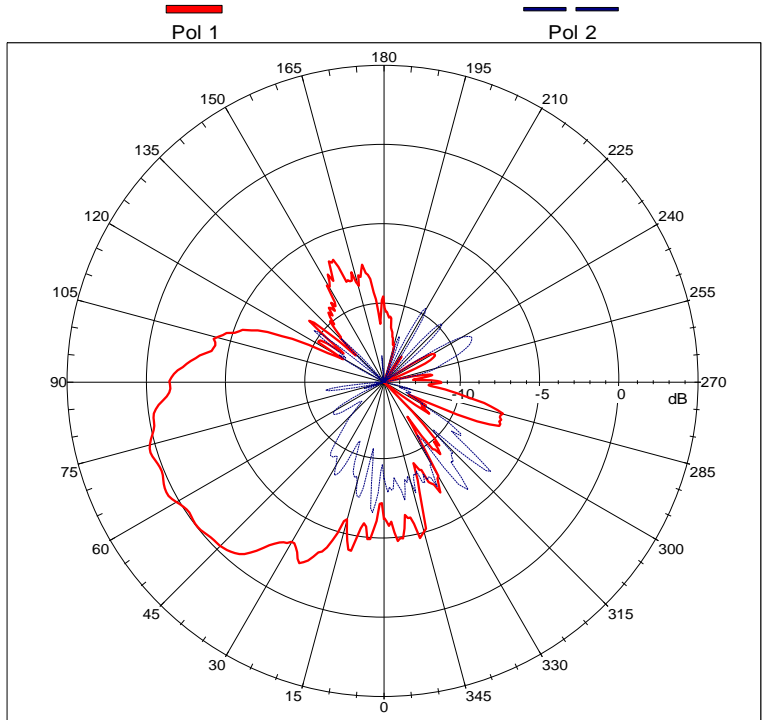

Far-Field Pwr Sum Phi Cut, Theta=90 f=5.6000 GHz

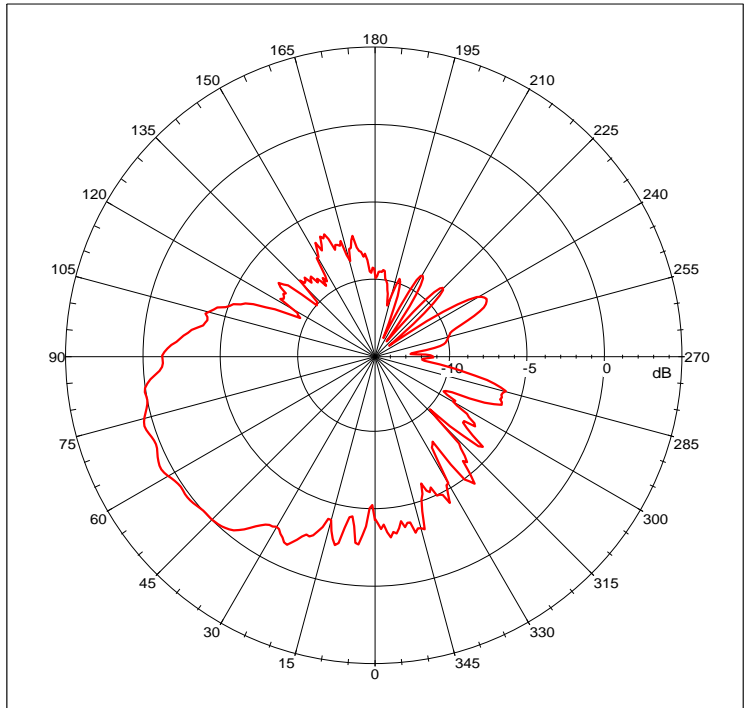

Center Frequency	5600 MHz
Horizontal (dBi) peak	-6.23
Vertical (dBi) peak	0.40

Far-Field Phi Cut, Theta=90 f=5.7250 GHz

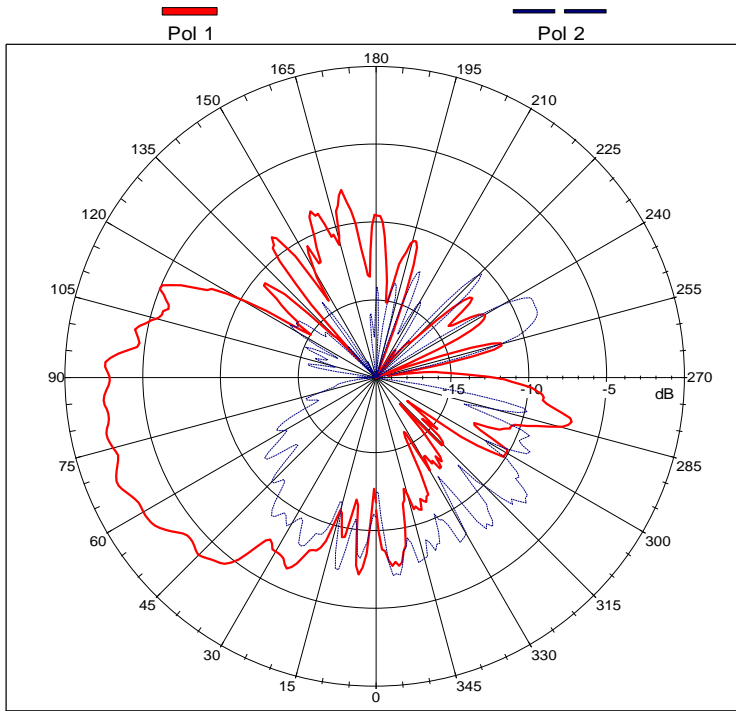

Far-Field Pwr Sum Phi Cut, Theta=90 f=5.7250 GHz

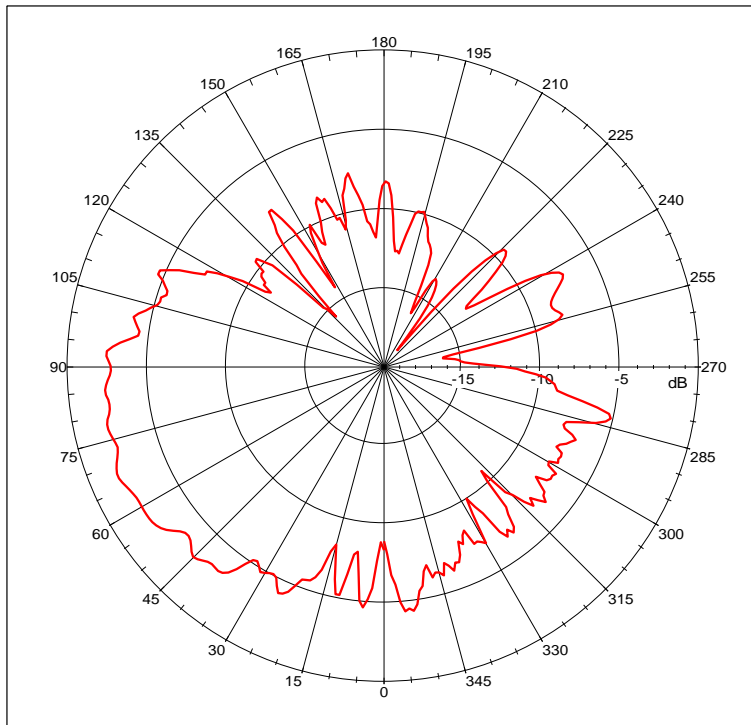

Center Frequency	5725 MHz
Horizontal (dBi) peak	-7.23
Vertical (dBi) peak	-2.04

Tx2 (or Rx2) antenna: 5470 MHz (Plot is not required if 2nd Antenna is receive only e.g. Rx2 for 512 family)

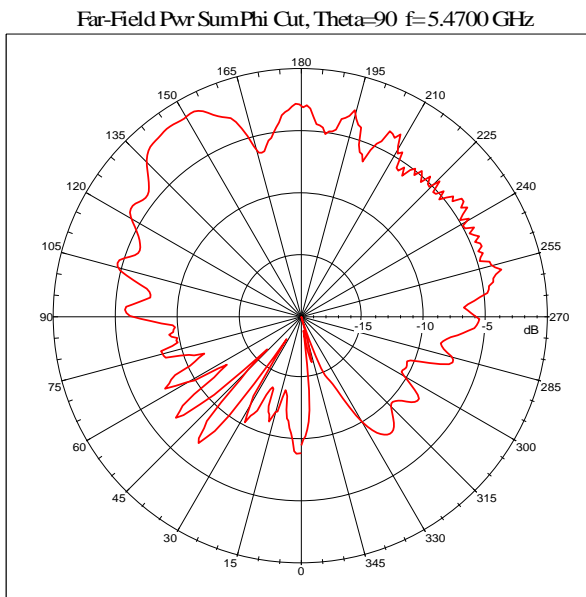
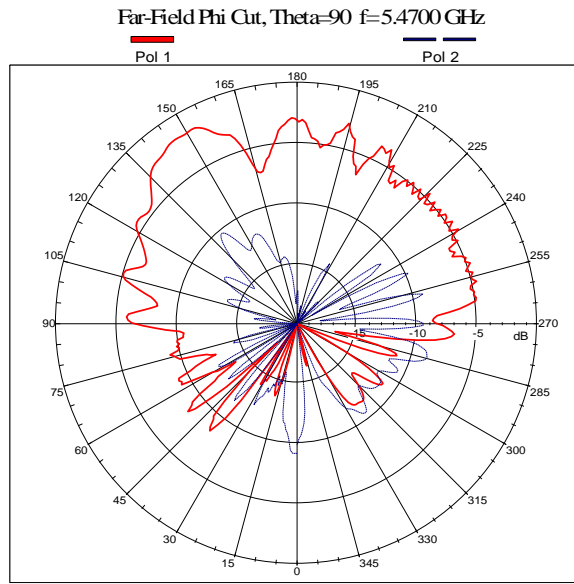

Center Frequency	5470 MHz
Horizontal (dBi) peak	-8.86
Vertical (dBi) peak	-1.71

Tx2 (or Rx2) antenna: 5600 MHz (Plot is not required if 2nd Antenna is receive only e.g. Rx2 for 512 family)

Far-Field Phi Cut, Theta=90 f=5.6000 GHz

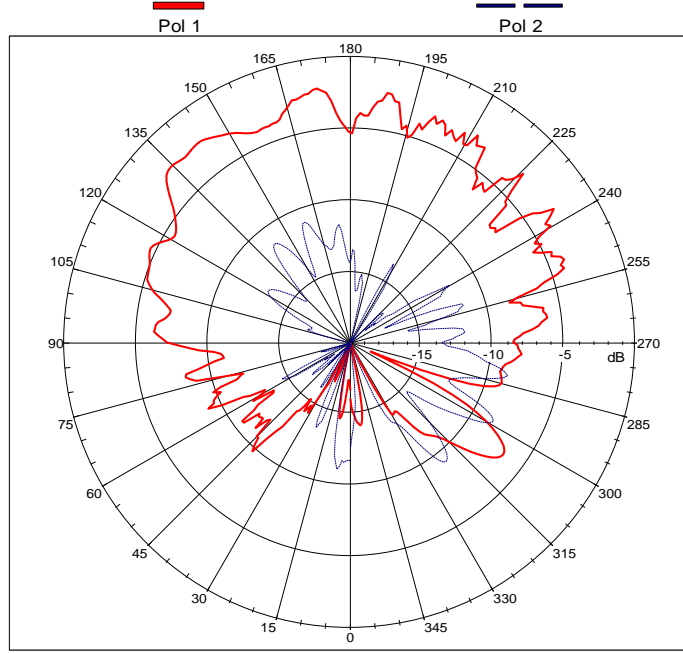

Far-Field Pwr SumPhi Cut, Theta=90 f=5.6000 GHz

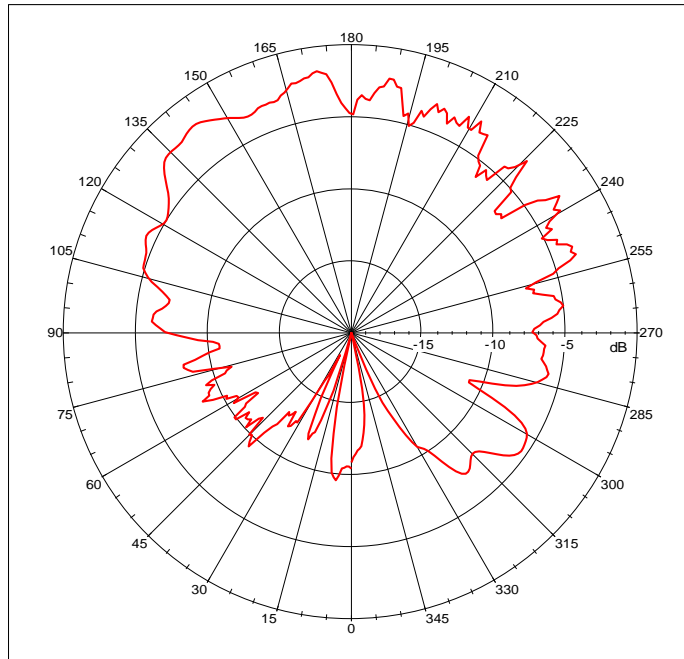

Center Frequency	5600 MHz
Horizontal (dBi) peak	-8.63
Vertical (dBi) peak	-2.10

Tx2 (or Rx2) antenna: 5725 MHz (Plot is not required if 2nd Antenna is receive only e.g. Rx2 for 512 family)

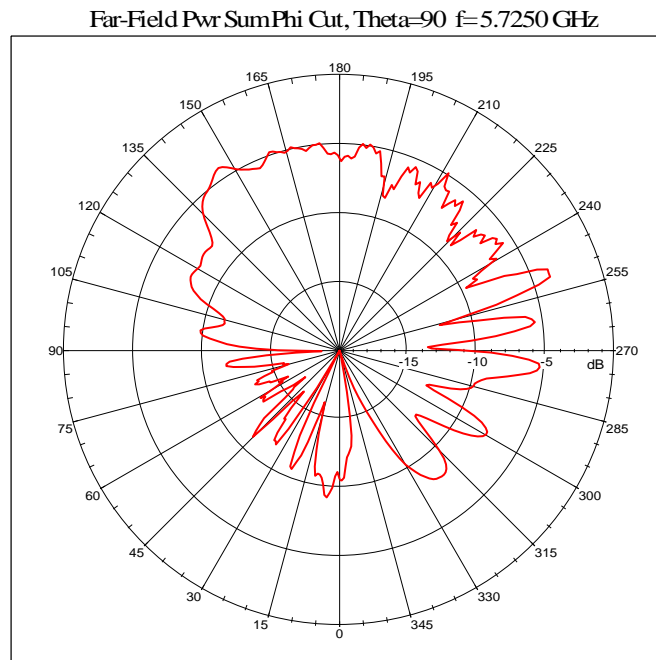
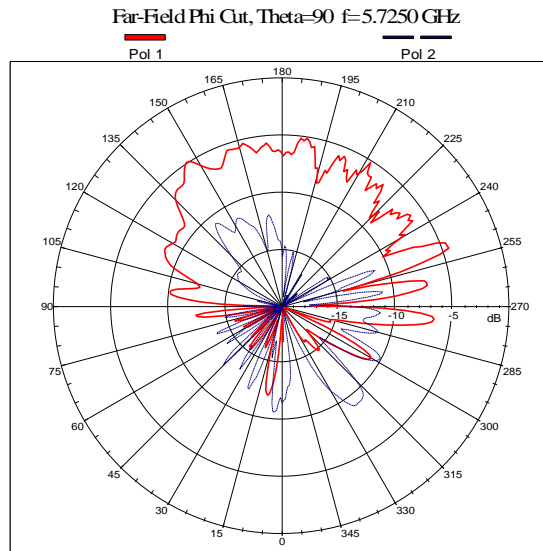

Center Frequency	5725 MHz
Horizontal (dBi) peak	-9.22
Vertical (dBi) peak	-4.55

Tx3 (or Rx3) antenna: 5470 MHz (Plot is not required if 3rd Antenna is receive only e.g. Rx3 for 4965AGN)

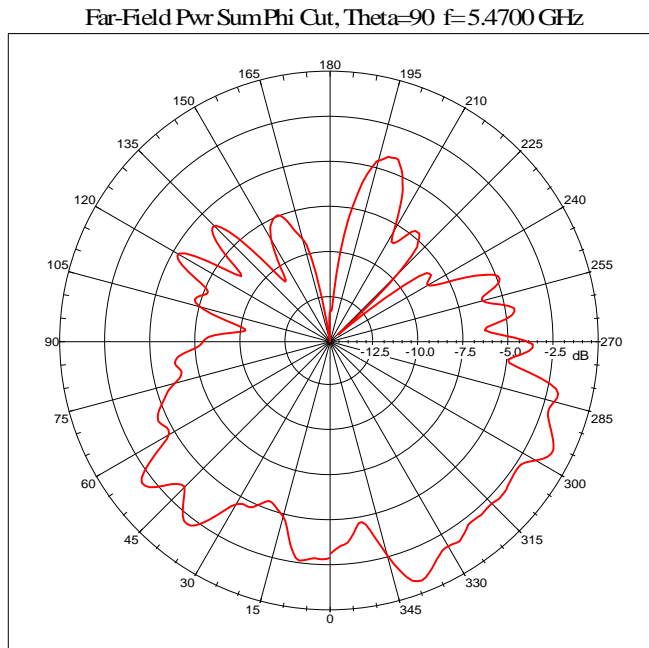
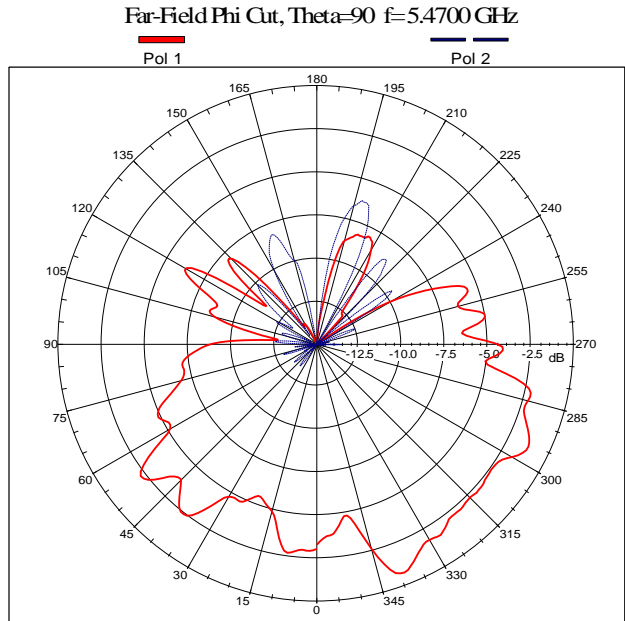

Center Frequency	5470 MHz
Horizontal (dBi) peak	-6.28
Vertical (dBi) peak	-0.83

Tx3 (or Rx3) antenna: 5600 MHz (Plot is not required if 3rd Antenna is receive only e.g. Rx3 for 4965AGN)

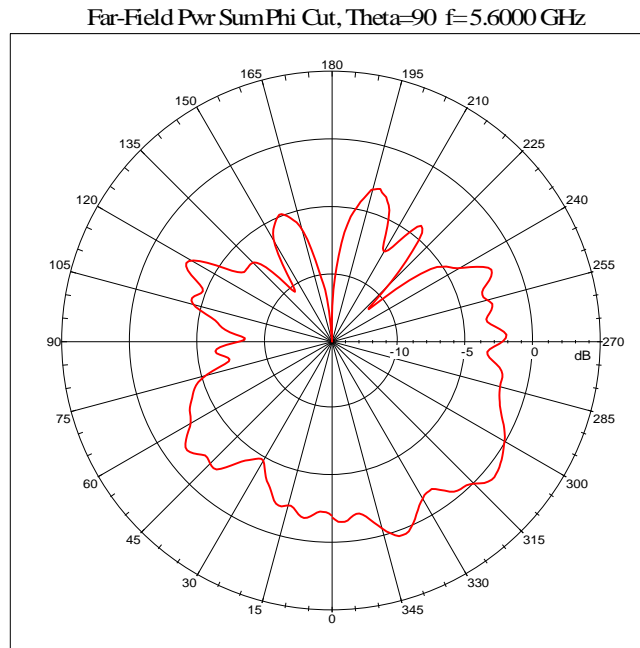
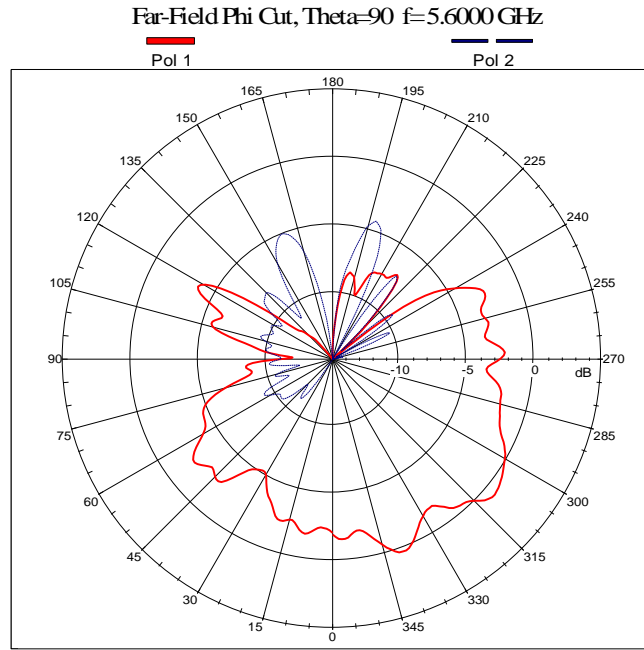

Center Frequency	5600 MHz
Horizontal (dBi) peak	-4.3
Vertical (dBi) peak	-0.64

Tx3 (or Rx3) antenna: 5750 MHz (Plot is not required if 3rd Antenna is receive only e.g. Rx3 for 4965AGN)

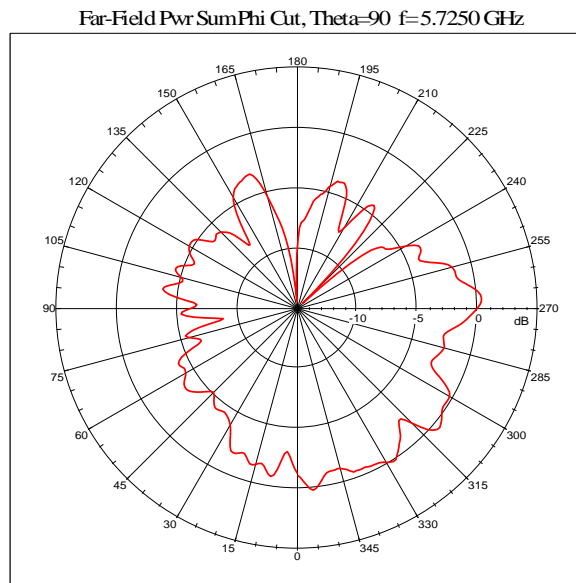
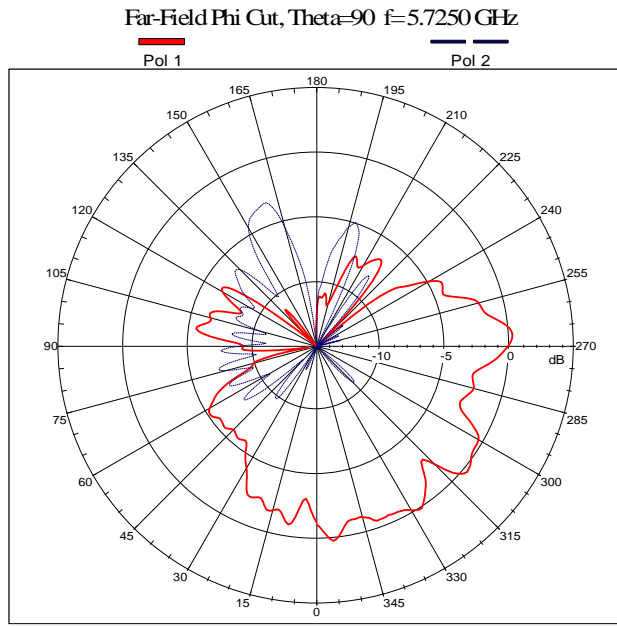

Center Frequency	5725 MHz
Horizontal (dBi) peak	-3.24
Vertical (dBi) peak	0.15

5725-5850 MHz radiation characteristic

Tx1 antenna: 5725 MHz

Far-Field Phi Cut, Theta=90 f=5.7250 GHz

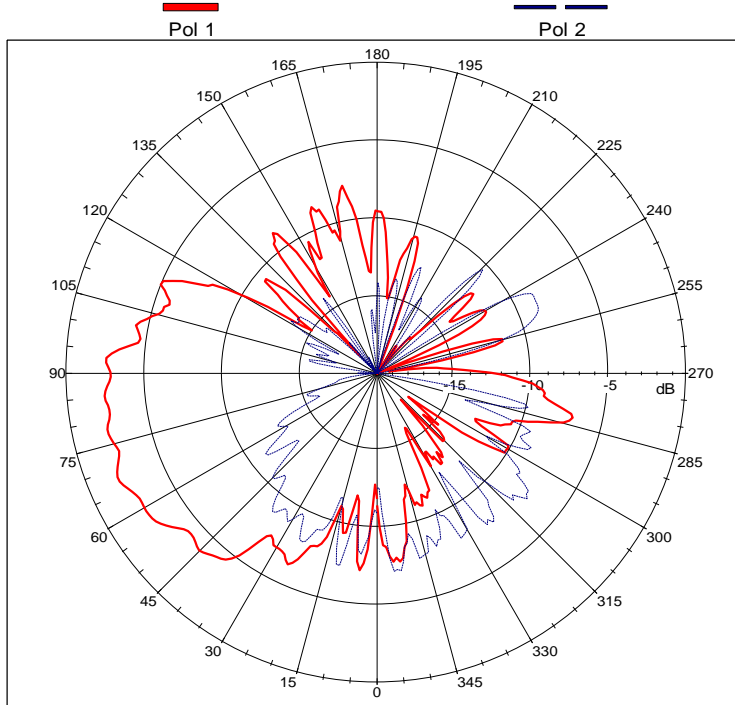

Far-Field Pwr SumPhi Cut, Theta=90 f=5.7250 GHz

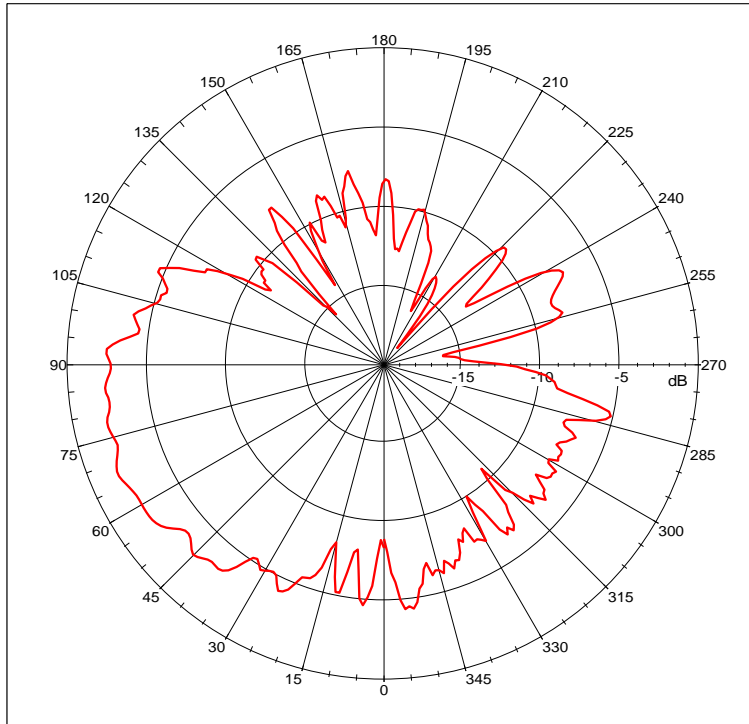

Center Frequency	5725 MHz
Horizontal (dBi) peak	-7.23
Vertical (dBi) peak	-2.04

Tx1 antenna: 5850 MHz

Far-Field Phi Cut, Theta=90 f=5.8500 GHz

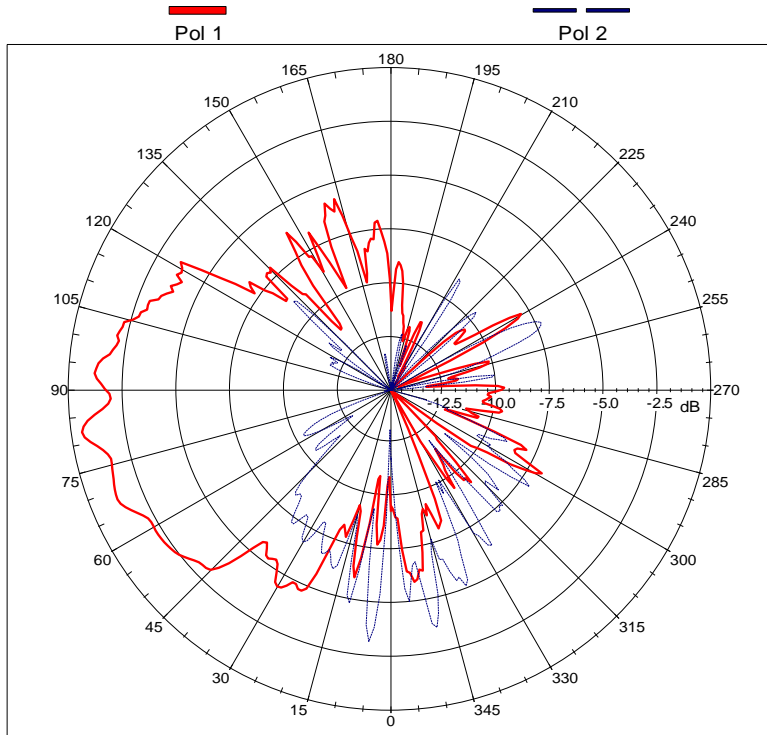

Far-Field Pwr Sum Phi Cut, Theta=90 f=5.8500 GHz

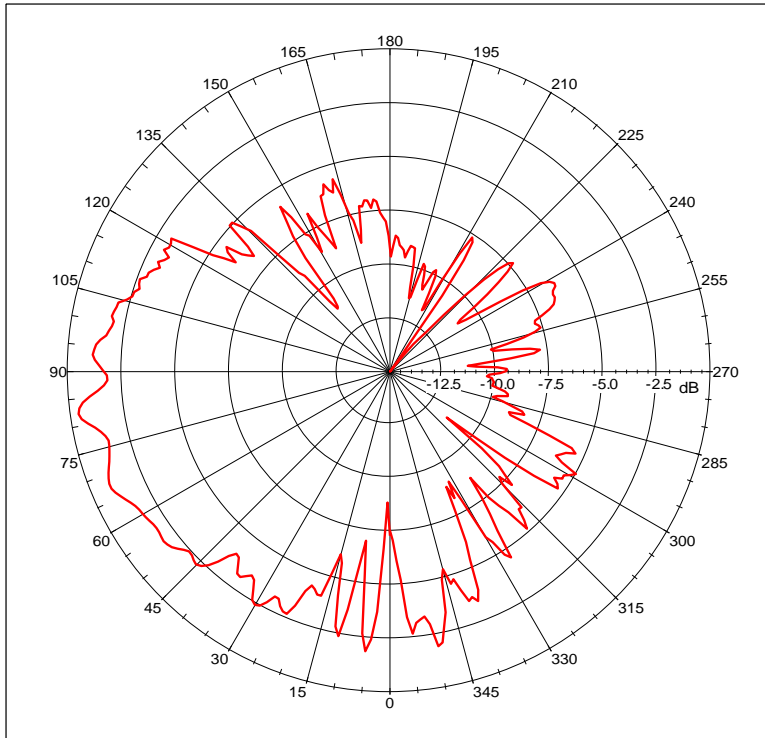

Center Frequency	5850 MHz
Horizontal (dBi) peak	-3.27
Vertical (dBi) peak	-0.52

Tx2 (or Rx2) antenna: 5725 MHz (Plot is not required if 2nd Antenna is receive only e.g. Rx2 for 512 family)

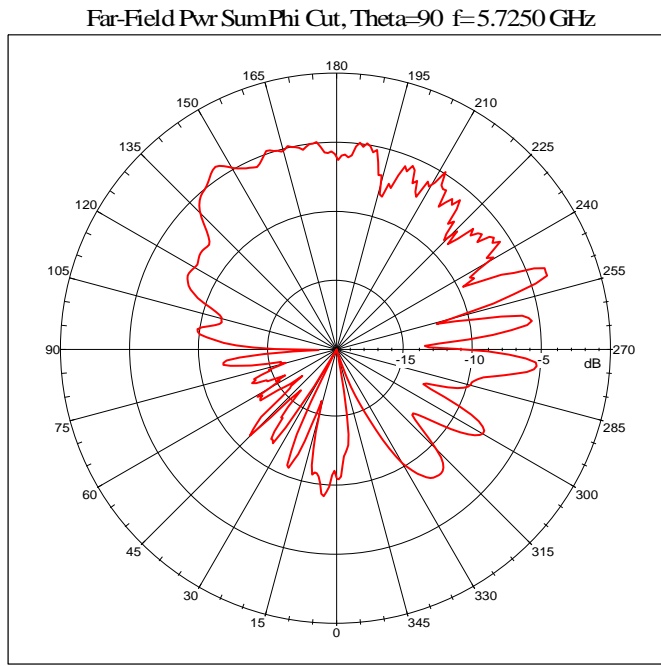
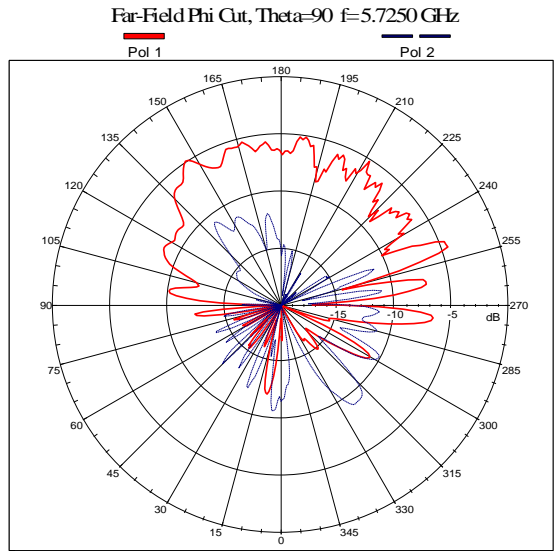

Center Frequency	5725 MHz
Horizontal (dBi) peak	-9.22
Vertical (dBi) peak	-4.55

Tx2 (or Rx2) antenna: 5850 MHz (Plot is not required if 2nd Antenna is receive only e.g. Rx2 for 512 family)

Far-Field Phi Cut, Theta=90 f=5.8500 GHz

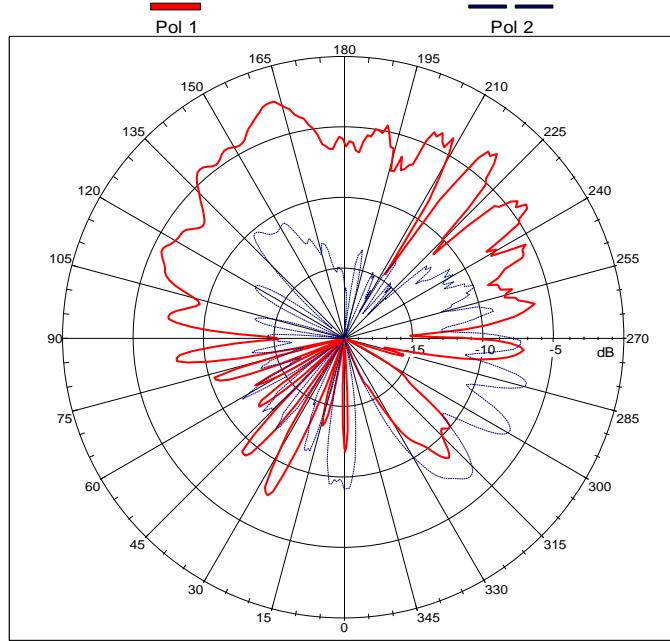

Far-Field Pwr Sum Phi Cut, Theta=90 f=5.8500 GHz

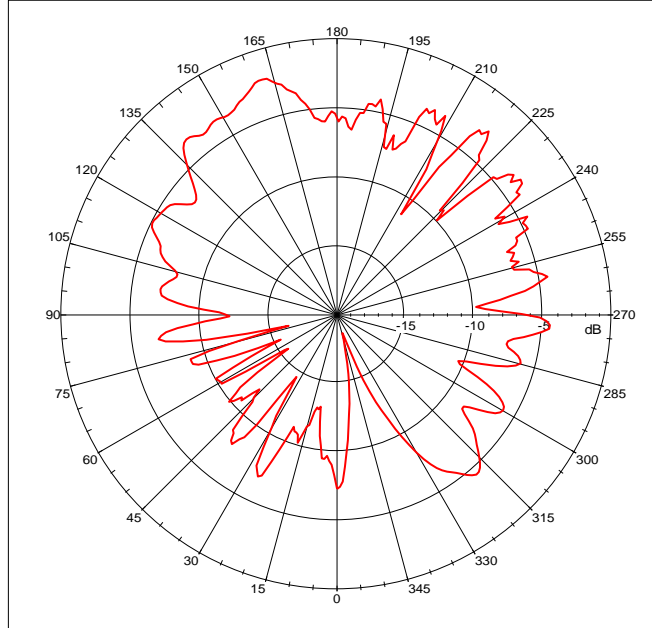

Center Frequency	5850 MHz
Horizontal (dBi) peak	-6.55
Vertical (dBi) peak	-2.49

Tx3 (or Rx3) antenna: 5725 MHz (Plot is not required if 3rd Antenna is receive only e.g. Rx3 for 4965AGN)

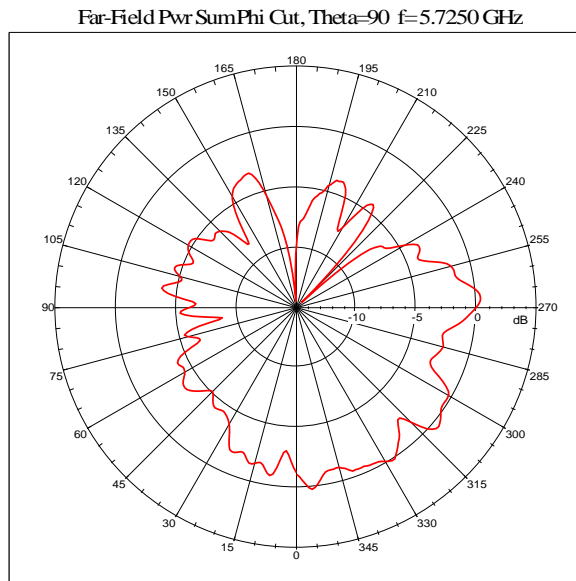
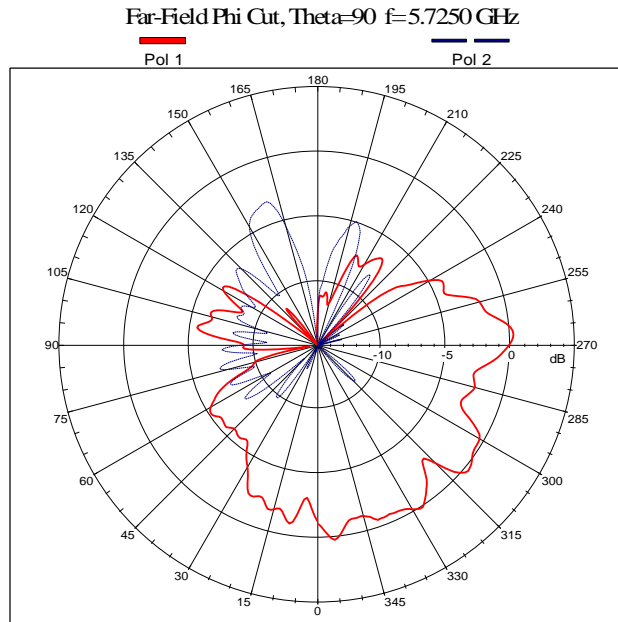

Center Frequency	5725 MHz
Horizontal (dBi) peak	-3.24
Vertical (dBi) peak	0.15

Tx3 (or Rx3) antenna: 5850 MHz (Plot is not required if 3rd Antenna is receive only e.g. Rx3 for 4965AGN)

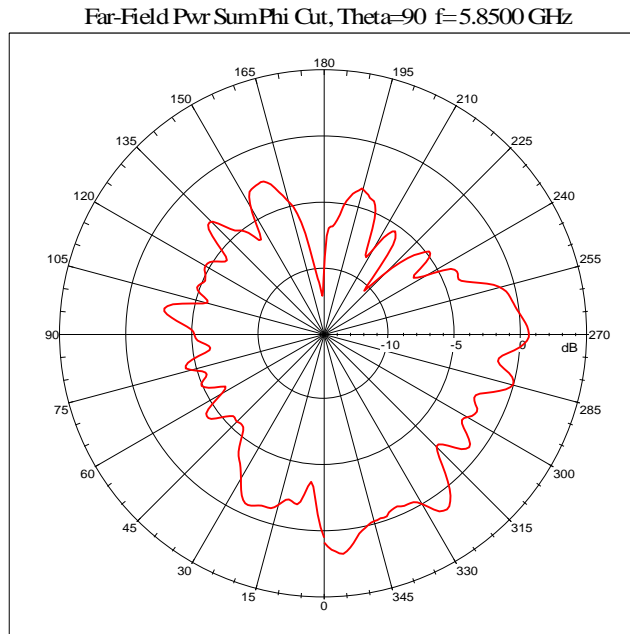
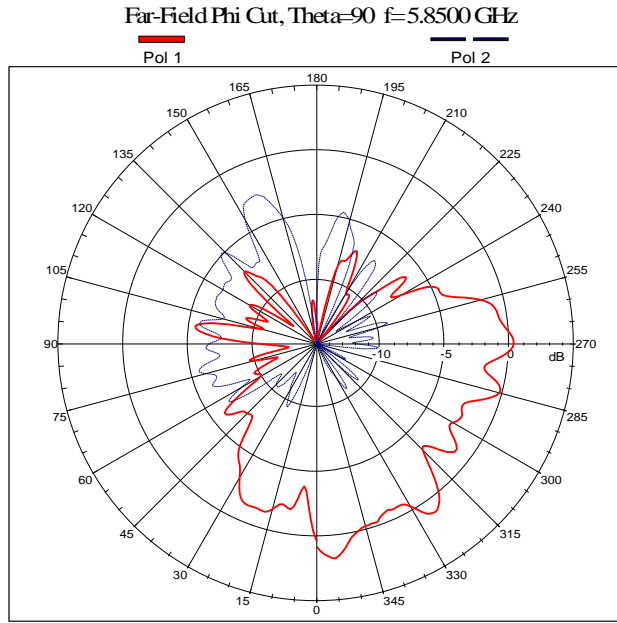

Center Frequency	5850 MHz
Horizontal (dBi) peak	-2.57
Vertical (dBi) peak	-1.63

Section 4. Host Platform Information

OEM / ODM Host platform: (XXXXXXX) platform correlated to antenna data

Rating Label Photo:

Section 5. Antenna Host Platform Location Information

Include a **dimensioned photo or dimensioned drawing** of Tx1, Tx2 and Tx3 antenna placements (measurements are not required for receive-only antenna). Any antenna that transmits must show dimensions to bottom of laptop.

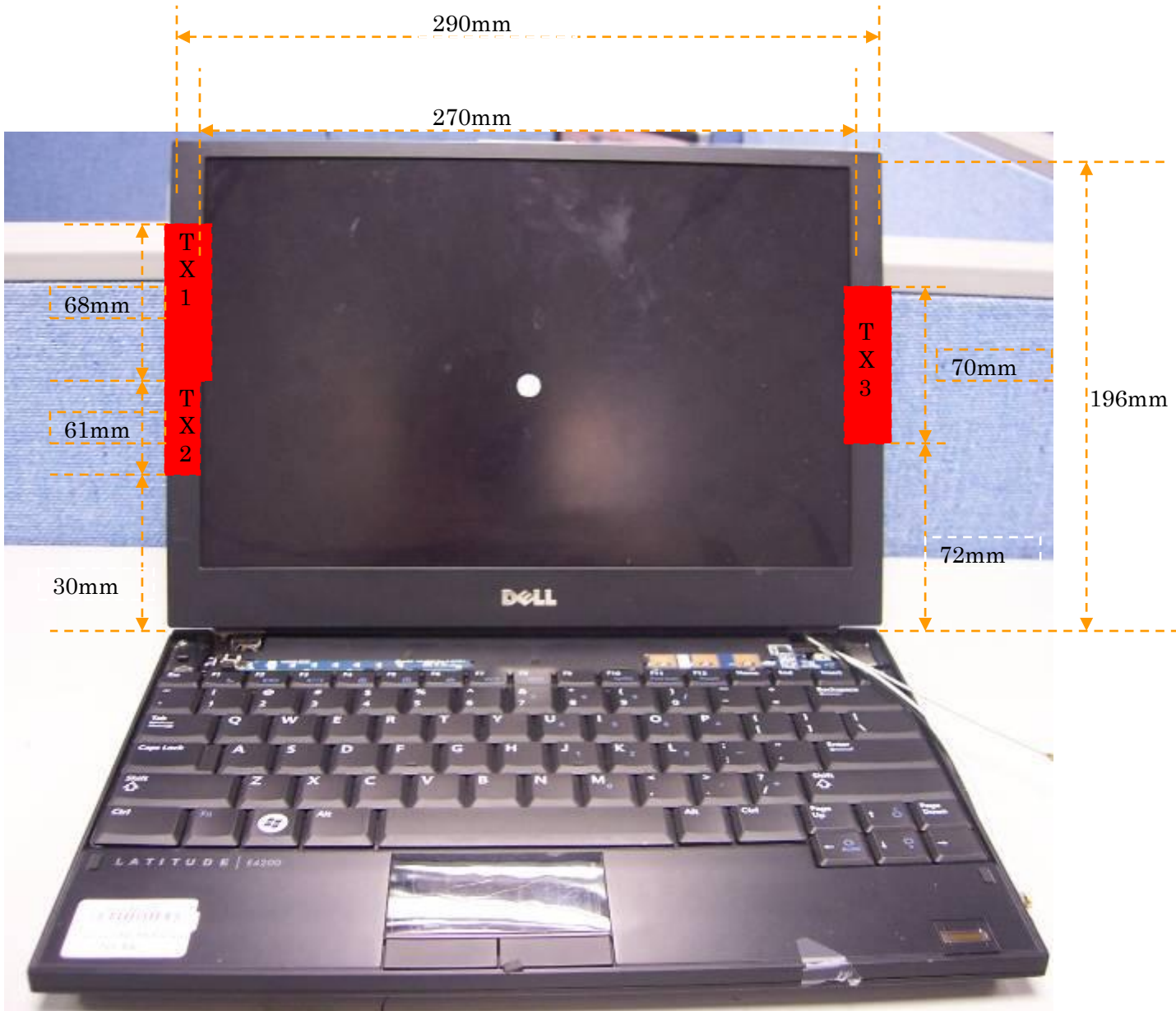

Section 6. Antenna dimensional information for SAR evaluation

Include a **dimensioned photo or dimensioned drawing** showing the distance (mm) between the transmit antennas and the user (excluding hands, wrist, feet, lap/ thigh, and ankle)

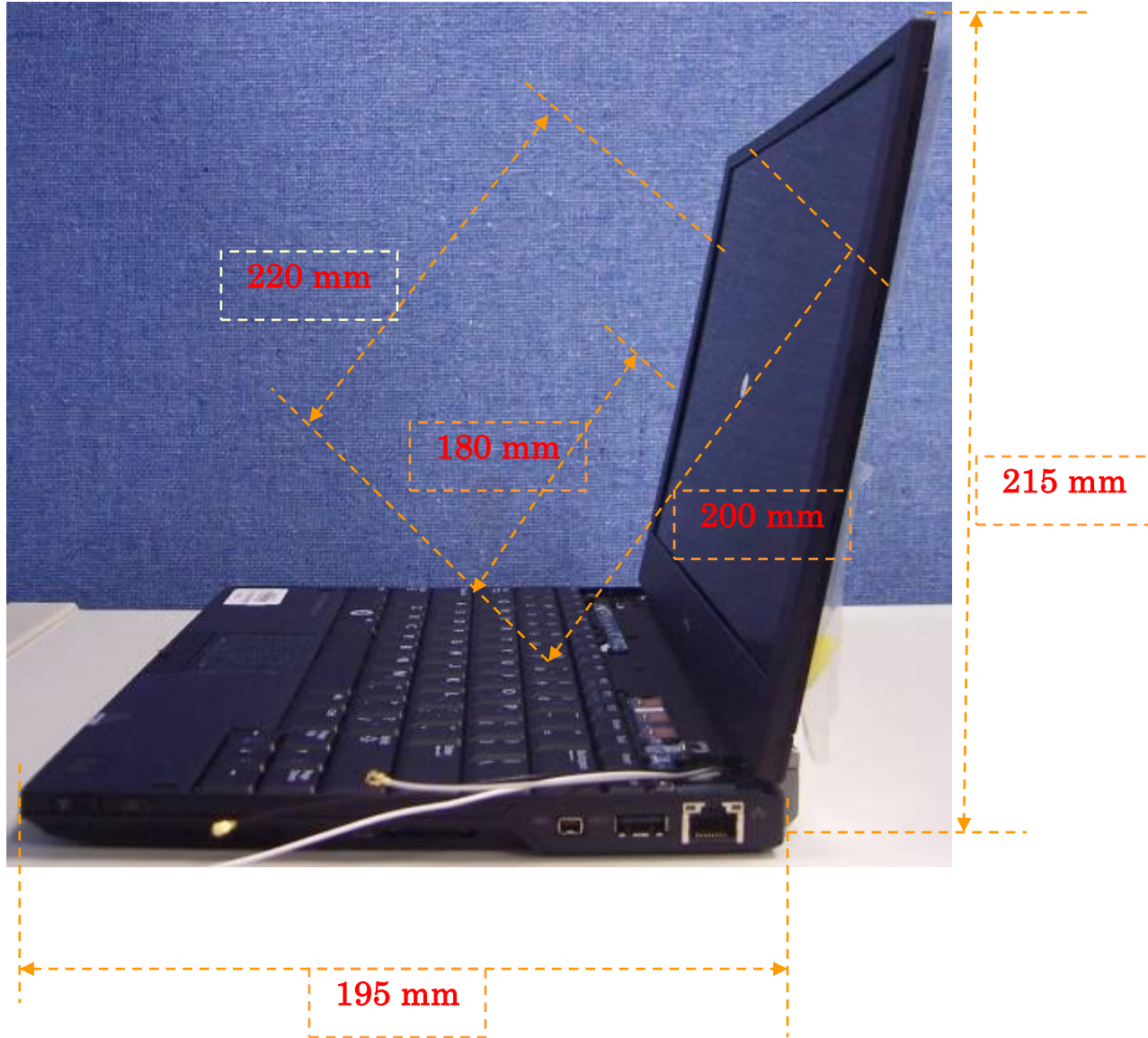

Section 7. Diagram Example of Co-Location Antenna Separation

Include a **dimensioned photo or dimensioned drawing** showing the distance (mm) between **all WLAN transmit antennas** and other co-located radiator transmit antenna such as Bluetooth, WWAN,..

(Note: Due to the evolving rules regarding co-location, each platform will need to be reviewed on a case by case basis)

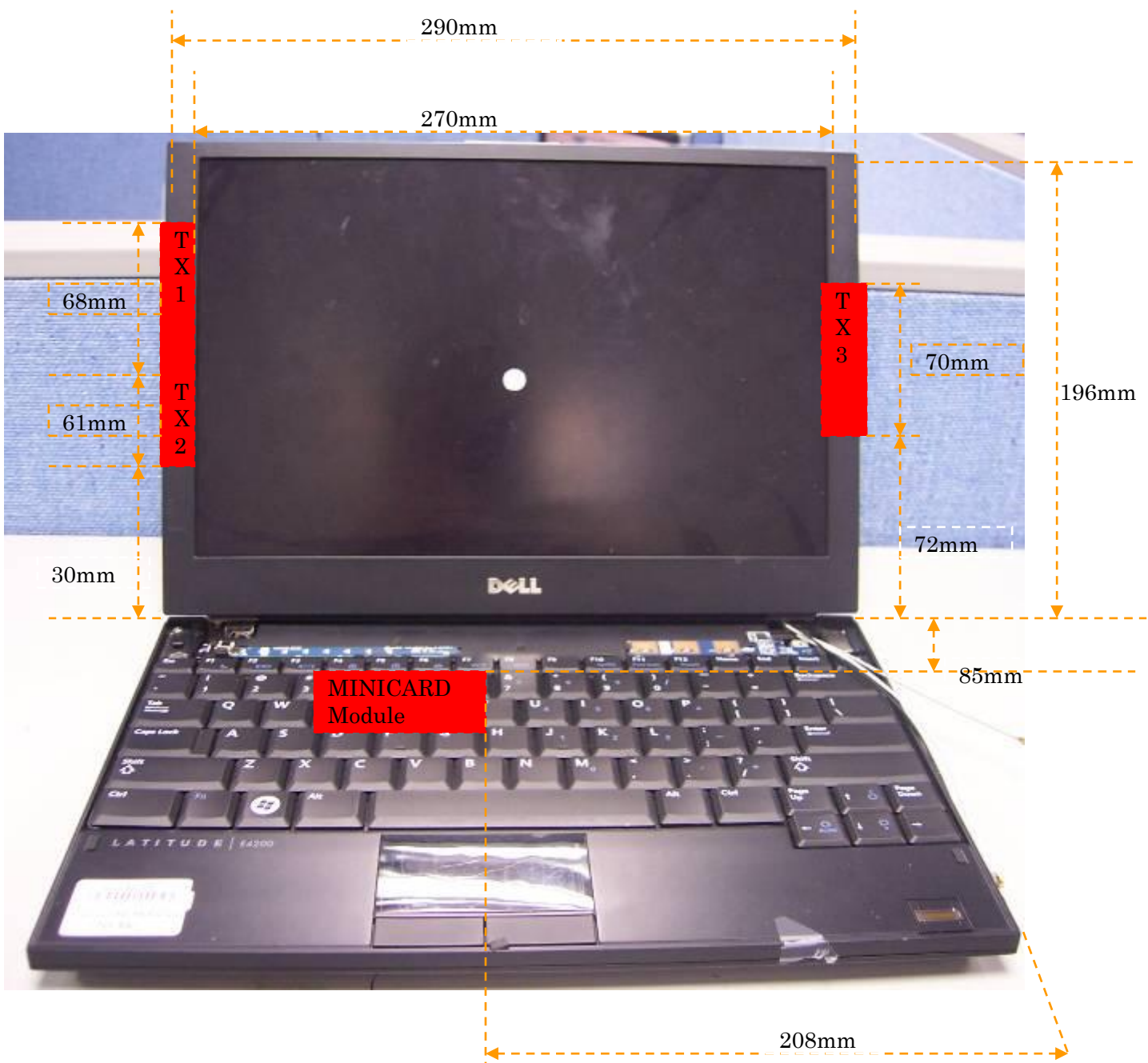

Section 8. Local representative contact information

Local representative contact information is required for regulatory support for target countries below.

	Local company name	Contact name	Phone number	FAX Number	e-Mail Address	Notes
Argentina						
Brazil						
Indonesia						
Israel	Galtronics LTD	Doron Kenigsbuch	+972-46-739-812	+972-46-734-138	Doron.kenigsbuch@galtronics.coml	
Malaysia						
Mexico						
Singapore						Telecommunication Equipment Dealer License Required
South Africa						
USA, Canada						