

Regulatory WLAN Antenna Information

Platform	
Platform Owner	DELL
Brand Name	DELL
Model Name	Latitude E4200
ODM	Compal Corporation
Target Launch Date	(2009/ 07/28)
Antenna	
Brand Name	Tyco Electronics
Part Number	<ul style="list-style-type: none"> ■ Tx1 Antenna: 1556016-1
	<ul style="list-style-type: none"> ■ Tx2 Antenna: 1556016-1
	<ul style="list-style-type: none"> ■ Tx3 Antenna: 1556016-1
Module	
With WLAN Module	<input type="checkbox"/> 512ANX Family
(Check Box)	<input type="checkbox"/> 533AN Family
	<input type="checkbox"/> 512AN Family

Antenna Sample / Antenna Data Requirements for worldwide regulatory approval

Section	Description of Required OEM / ODM Antenna Information	US / IC	EU	Japan	Taiwan	S.Korea
1A	Part Number for Antenna only	Required	Required	Required	Required	Required
1B	Antenna Manufacturer Name	Required	Required	Required	Required	Required
1C	Description of Antenna Type	Required	N/A	N/A	N/A	N/A
1D	Part number of Antenna Assembly / cable impedance, length & diameter.	Required	Desired	Desired	Desired	Desired
1E	Tx1, Tx2 & Tx3 antenna (Peak Gain W/ cable loss) *	Required	Required	Required	Required	Required
	1E OR 1F, 1G, 1H					
1F	Tx1, Tx2 & Tx3 antenna (Peak Gain only) *	Required	Required	Required	Required	Required
1G	VSWR of cable including connector	Required	Required	Required	Required	Required
1H	Tx1, Tx2 & Tx3 antenna (Cable loss W/ connector) *	Required	Required	Required	Required	Required
2	Dimensioned Photographs and Drawings of Tx1, Tx2, and Tx3 (or Rx3) antennas	Required	Required	Required	Required	Required
3	Radiation patterns of antennas loaded in the host platform.	Required	Desired	Required	N/A	Required
4	Platform model name / number - correlated to antenna manufacturer and antenna part number	Required	Required	Desired	Required	Desired
5	Photograph(s) or Drawings showing location of antennas in platform. (S. Korea requires photographs of antennas for approval submission). Taiwan requires pictures of each antenna type shown in the system.	Required	Required	Desired	Required (Photos)	Required (Photos)
6	Mech. drawings / photos with dimensions of antenna locations and distance from end-user (For evaluation of SAR testing requirement).	Required	N/A	N/A	N/A	N/A
7	Photograph(s) or Drawings showing the location of all antennas (WLAN, other) and distance between those transmitting antennas. Information will be used to evaluate whether co-location testing is required.	Required	N/A	N/A	N/A	N/A
8	Local representative contact information for LMA/ PARS process.	Required	N/A	N/A	N/A	N/A

NOTE:

(*) if 3rd antenna is Rx only (e.g. receive only for 4965AGN) then peak gain and cable loss not required

Antenna Information

Section 1. Antenna Assembly Specifications

Antenna Assembly Summary:

1A Antenna Part Number	1B Manufacture	1C Antenna Type	1D Cable Assembly Part Number and Information	1E *Peak Gain W/ Cable loss (dBi)	1F Peak Gain w/o Cable Loss (dBi)	1G VSWR	1H Cable Loss (dBi)
(P/N: 1556016-1) Tx1 antenna	Tyco Electronics	PIFA	(P/N:20351-111R-13) 50 ohm Coaxial. length:48.0cm diameter: 1.13mm Connector: MHF	2400-2500MHz -0.89dBi (peak)	2400-2500MHz 0.24dBi (peak)	2400-2500MHz 1.9max*	2400-2500MHz 1.13dBi (peak) *
				2496-2690MHz -0.65dBi (peak)	2496-2690MHz 0.54dBi (peak)	2496-2690MHz 1.7max*	2496-2690MHz 1.19dBi (peak) *
				5150-5350MHz 0.48dBi (peak)	5150-5350MHz 2.13dBi (peak)	5150-5350MHz 1.6max*	5150-5350MHz 1.65dBi (peak) *
				5470-5725MHz 0.8dBi (peak)	5470-5725MHz 2.54dBi (peak)	5470-5725MHz 1.5max*	5470-5725MHz 1.74dBi (peak) *
				5725-5850MHz -3.01dBi (peak)	5725-5850MHz -1.19dBi (peak)	5725-5850MHz 1.6max*	5725-5850MHz 1.82dBi (peak) *
(P/N: 1556016-1) Tx2 (or Rx2) antenna	Tyco Electronics	PIFA	(P/N:20278-111R-13) 50 ohm Coaxial. length: 44.5cm diameter: 1.13mm Connector: MHF	2400-2500MHz -1.52dBi (peak) *	2400-2500MHz -0.42dBi (peak) *	2400-2500MHz 1.5max*	2400-2500MHz 1.1dBi (peak) *
				2496-2690MHz -1.53dBi (peak) *	2496-2690MHz -0.38dBi (peak) *	2496-2690MHz 1.6max*	2496-2690MHz 1.15dBi (peak) *
				5150-5350MHz 0.65dBi (peak) *	5150-5350MHz 2.25dBi (peak) *	5150-5350MHz 1.3max*	5150-5350MHz 1.6dBi (peak) *
				5470-5725MHz -0.47dBi (peak) *	5470-5725MHz 1.23dBi (peak) *	5470-5725MHz 1.4max*	5470-5725MHz 1.7dBi (peak) *
				5725-5850MHz -2.06dBi (peak) *	5725-5850MHz -0.26dBi (peak) *	5725-5850MHz 1.3max*	5725-5850MHz 1.8dBi (peak) *
(P/N: 1556016-1) Tx3 (or Rx3) antenna	Tyco Electronics	PIFA	(P/N:20278-111R-13) 50 ohm Coaxial. length: 18cm diameter: 1.13mm Connector: MHF	2400-2500MHz 0.18dBi (peak) *	2400-2500MHz 0.63dBi (peak) *	2400-2500MHz 1.3max*	2400-2500MHz 0.45dBi (peak) *
				5150-5350MHz -0.63dBi (peak) *	5150-5350MHz 1.28dBi (peak) *	5150-5350MHz 1.3max*	5150-5350MHz 0.65dBi (peak) *
				5470-5725MHz 0.15dBi (peak) *	5470-5725MHz 0.83dBi (peak) *	5470-5725MHz 1.4max*	5470-5725MHz 0.68dBi (peak) *
				5725-5850MHz 1.28dBi (peak) *	5725-5850MHz 1.99dBi (peak) *	5725-5850MHz 1.4max*	5725-5850MHz 0.71dBi (peak) *

NOTE:

(*) If Rx2/Rx3 only (2nd or 3rd antenna receives only, e.g. for 512 family & 4965AGN) then the information marked with * is not required

Antenna Peak Gain Table:

Frequency (MHz)	Tx1 antenna		Tx2 (or Rx2) Antenna		Tx3 (or Rx3) Antenna	
	Horizontal (dBi)	Vertical (dBi)	Horizontal (dBi)	Vertical (dBi)	Horizontal (dBi)	Vertical (dBi)
2400	-1.04	-2.04	-2.58	-2.73	-1.78	-10.25
2450	-0.89	-1.87	-2.14	-1.91	-0.60	-8.78
2500	-1.25	-3.98	-2.86	-1.52	0.18	-5.96
2501	-1.28	-4.12	-2.88	-1.53	0.21	-5.92
2593	-4.79	0.60	-3.19	-1.97	1.26	-9.18
2685	-1.19	-4.93	-4.66	-2.31	1.19	-9.25
5150	0.48	-1.74	-0.65	-1.28	-1.07	-7.71
5250	0.27	-0.49	0.65	-1.11	-0.63	-7.13
5350	-0.08	-0.32	-0.66	-3.05	-1.18	-6.92
5470	0.80	-0.47	-1.30	-2.84	-0.84	-8.37
5600	0.48	-1.25	-1.58	-4.32	-0.73	-5.85
5725	0.72	-0.76	-2.46	-4.01	0.15	-5.36
5785	0.52	-0.79	-2.45	-2.79	1.18	-5.07
5850	0.58	-0.90	-2.95	-2.06	1.28	-6.31

- Antenna Peak Gain required being test in system basis.
- 1E frame contend absolutely peak antenna gain include H/V
- If Rx2 only (2nd antenna receives only, e.g. for 512 family) then the information is not required for Rx2.
- If Rx3 only (3rd antenna receives only, e.g. for 4965AGN) then the information is not required for Rx3

Section 2. Dimensioned Photos or Drawings of Antennas

Include a dimensioned photo and dimensioned drawing of Tx1 antenna here.

Tx1 Antenna Dimensioned Drawing:

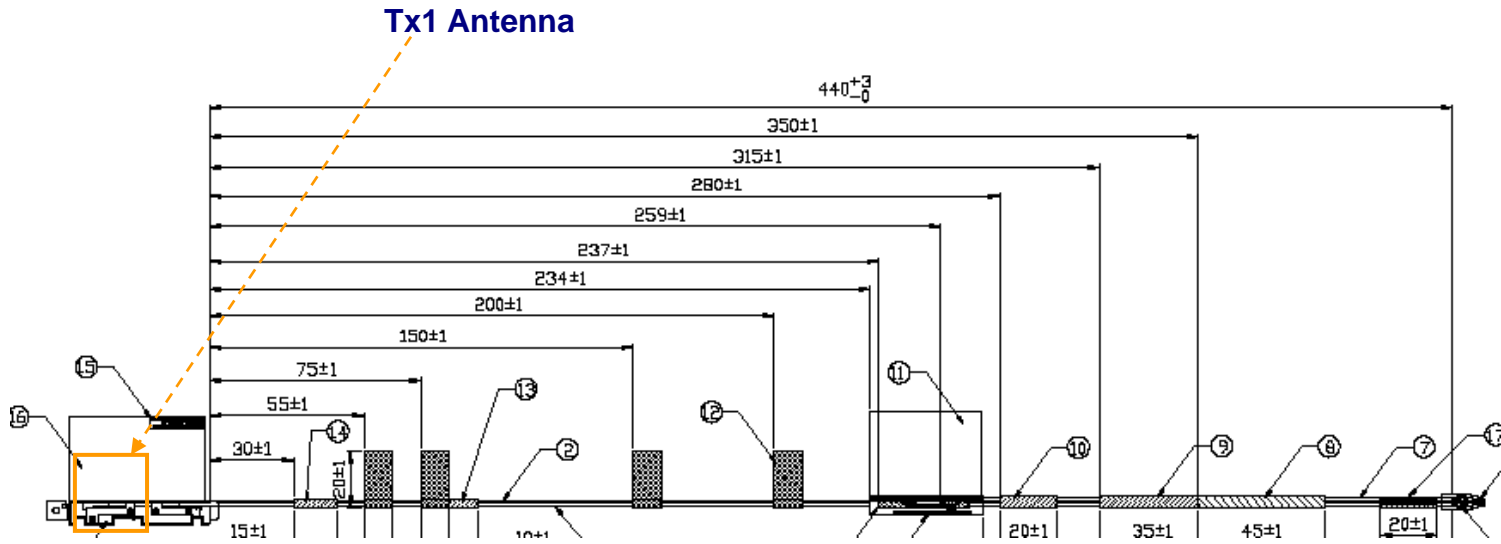

Tx1 Antenna Photo:

Tx1 Antenna

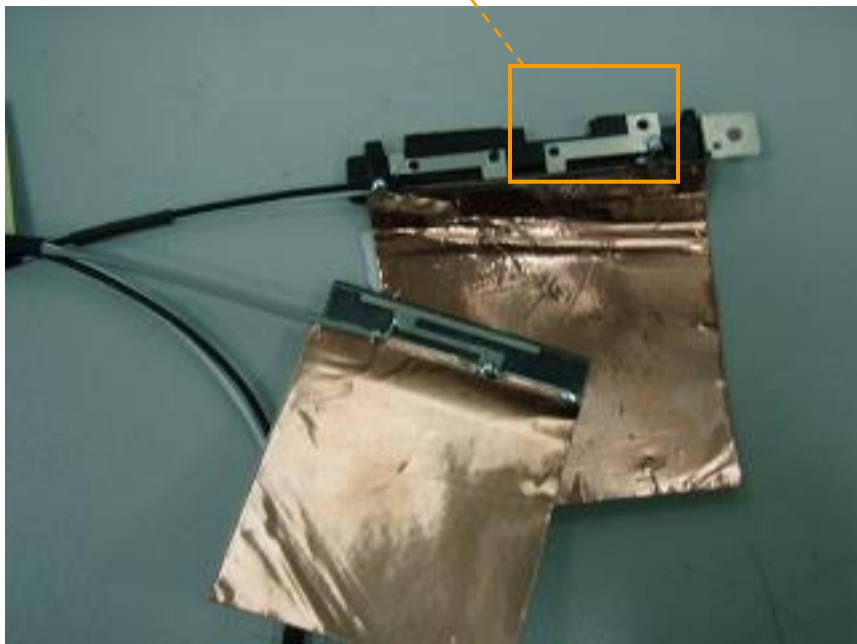

Include a dimensioned photo and dimensioned drawing of Tx2 (or Rx2) antenna here.

Tx2 (or Rx2) Antenna Dimensioned Drawing:

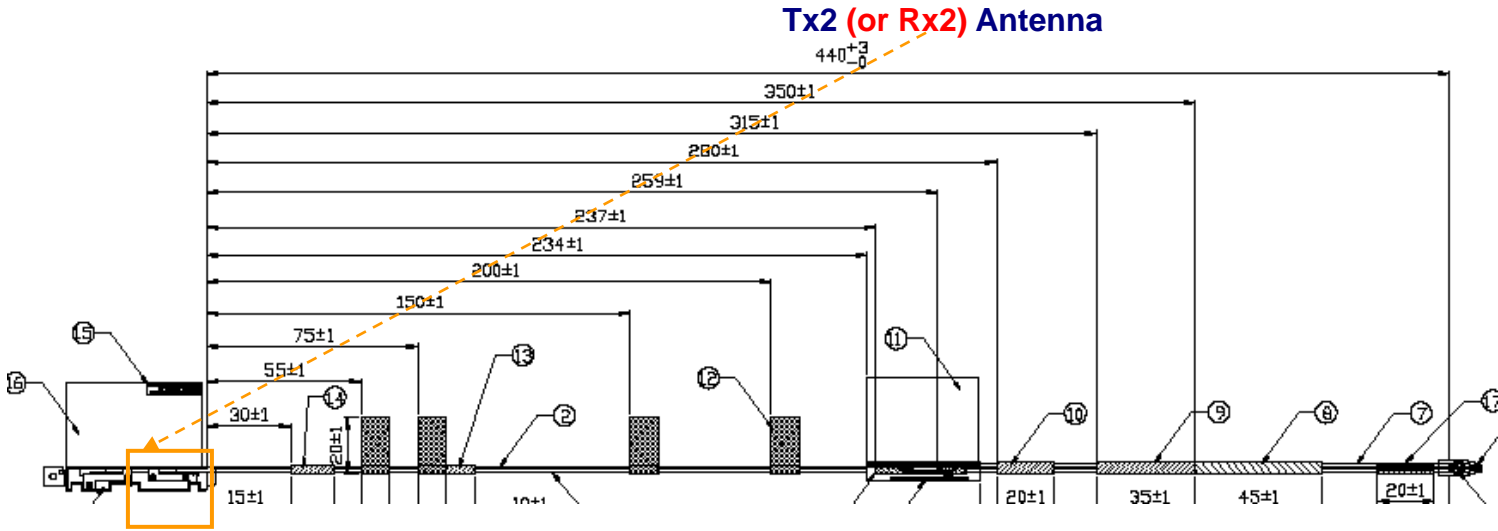

Tx2 (or Rx2) Antenna Photo:

Tx2 (or Rx2) Antenna

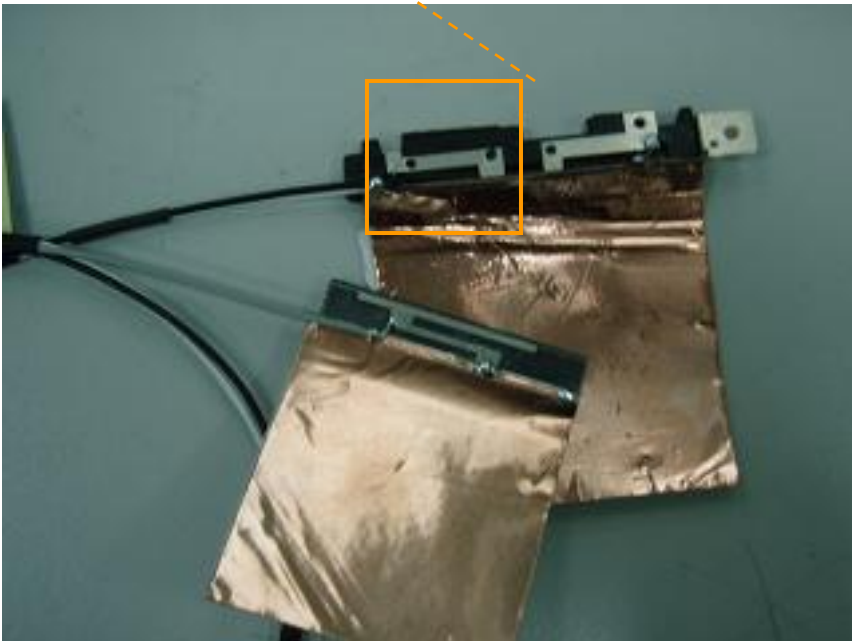

Include a dimensioned photo and dimensioned drawing of Tx3 (or Rx3) antenna here.

Tx3 (or Rx3) Antenna Dimensioned Drawing:

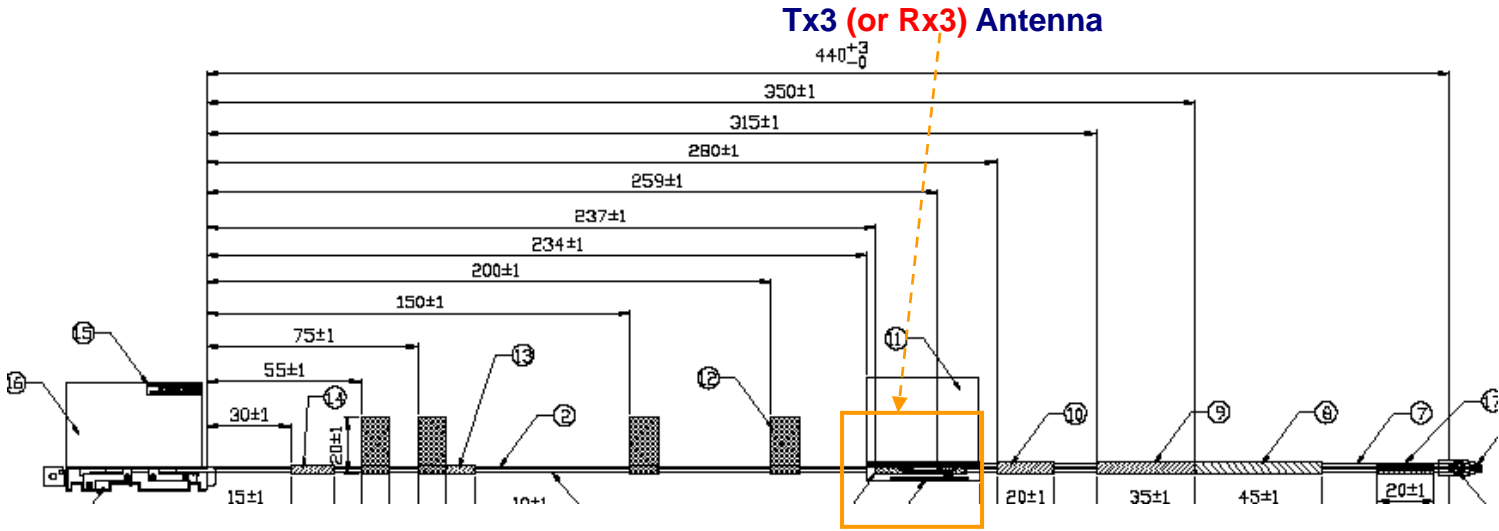

Tx3 (or Rx3) Antenna Photo:

Tx3 (or Rx3) Antenna

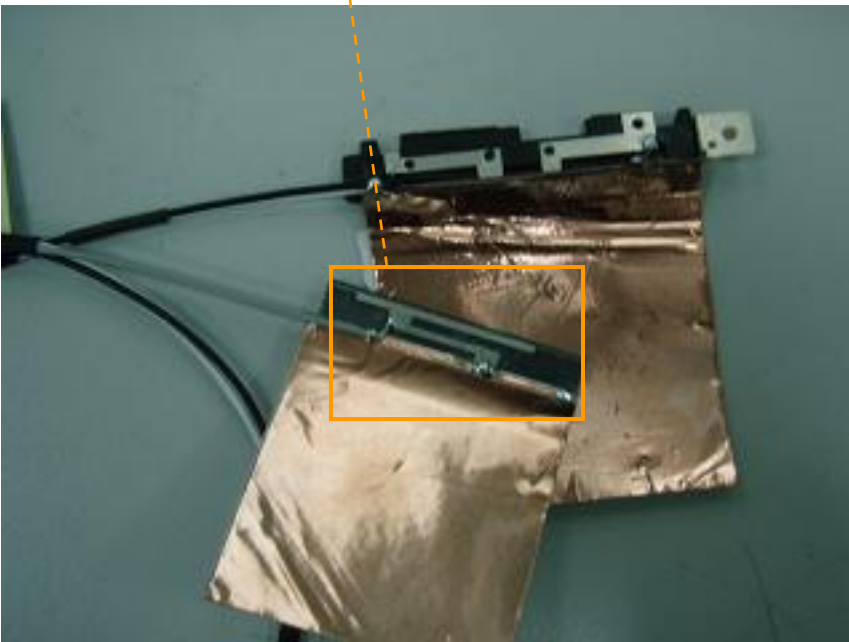

Include front view photo of all 3 antennas here.

Antenna Manufacturer: TYCO

Antenna Part Number: 1556016-1 (Tx1), 1556016-1 (Tx2 or Rx2), 1556016-1 (Tx3 or Rx3)



Include back view photo of all 3 antennas here.

Antenna Manufacturer: TYCO

Antenna Part Number: 1556016-1 (Tx1), 1556016-1 (Tx2 or Rx2), 1556016-1 (Tx3 or Rx3)

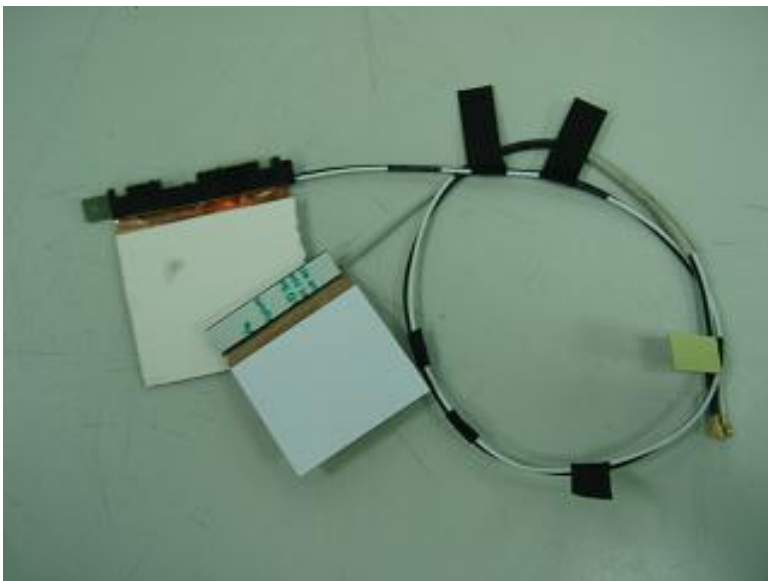

Section 3. Radiation characteristics of antennae Loaded in Host Platform

2400-2500MHz radiation characteristic

Tx1 antenna: 2400 MHz

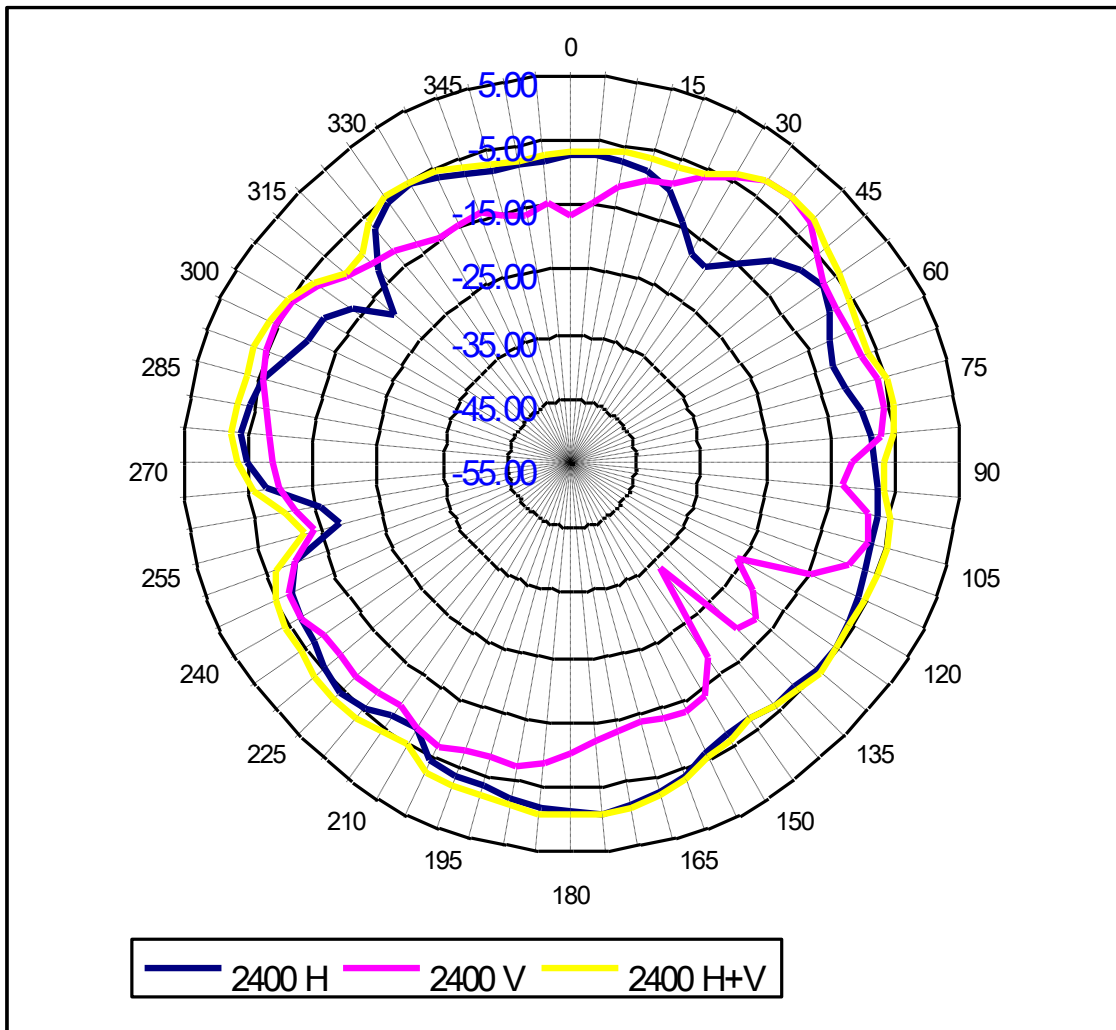

Center Frequency	2400 MHz
Horizontal (dBi) peak	-1.04
Vertical (dBi) peak	-2.04

Tx1 antenna: 2450 MHz

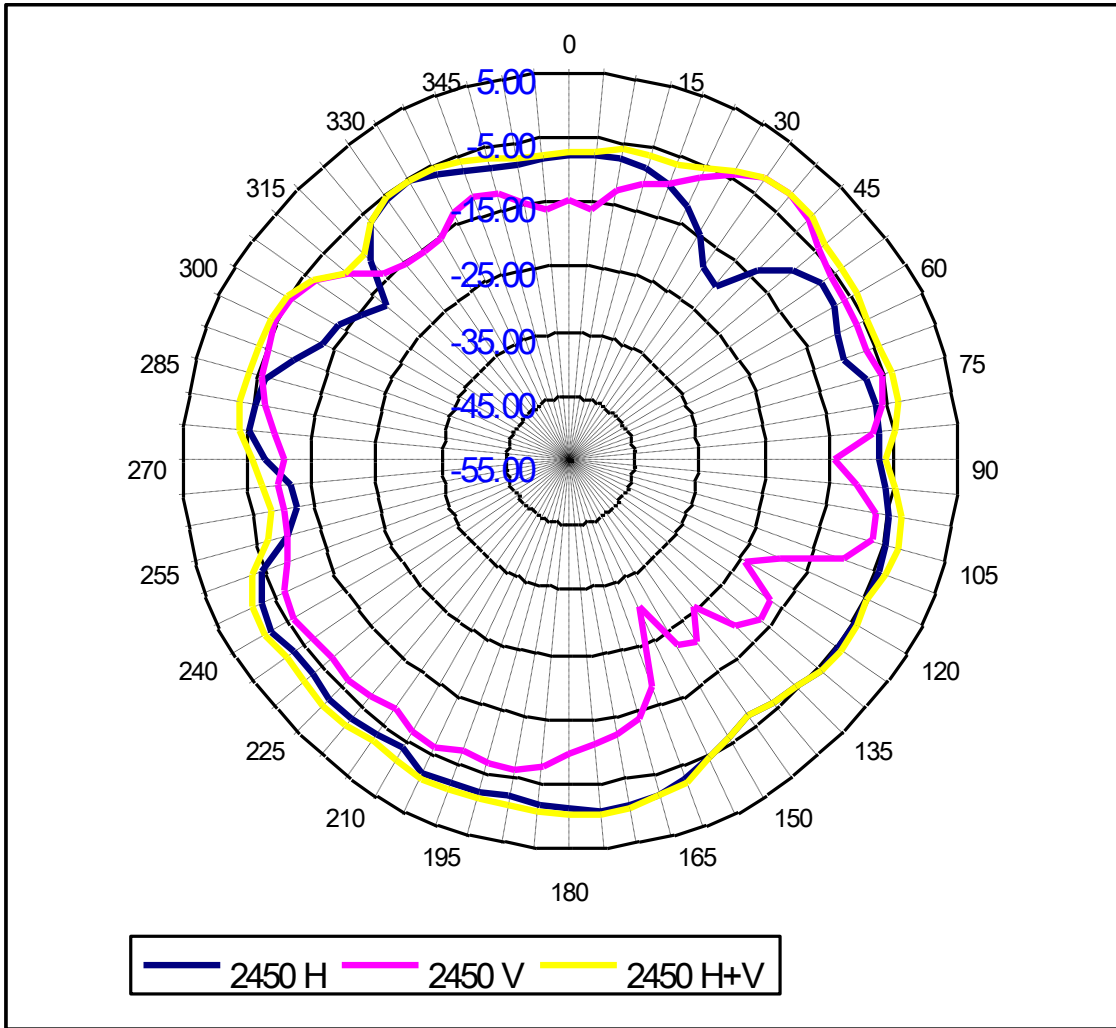

Center Frequency	2450 MHz
Horizontal (dBi) peak	-0.89
Vertical (dBi) peak	-1.87

Tx1 antenna: 2500 MHz

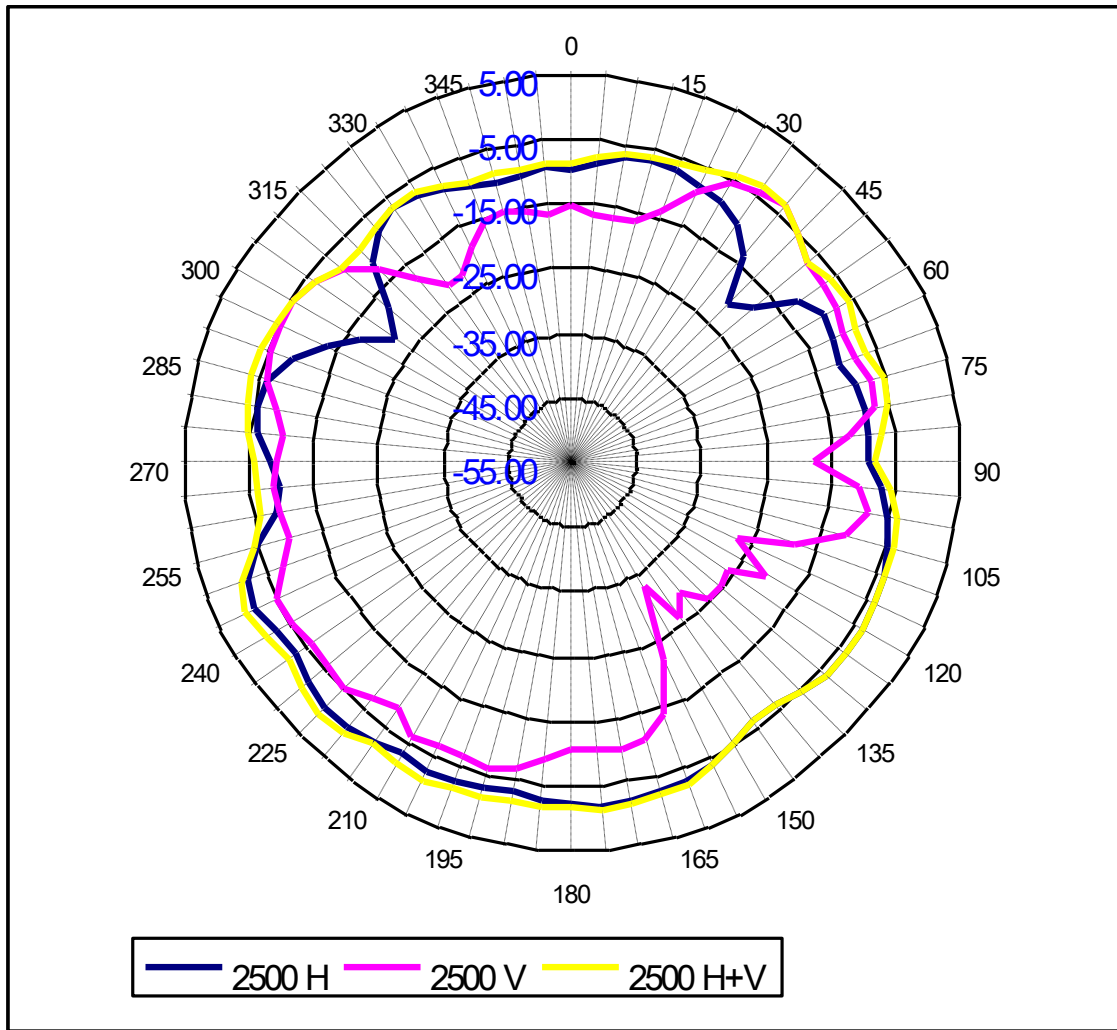

Center Frequency	2500 MHz
Horizontal (dBi) peak	-1.25
Vertical (dBi) peak	-3.98

Tx2 (or Rx2) antenna: 2400 MHz (Plot is not required if 2nd Antenna is receive only e.g. Rx2 for 512 family)

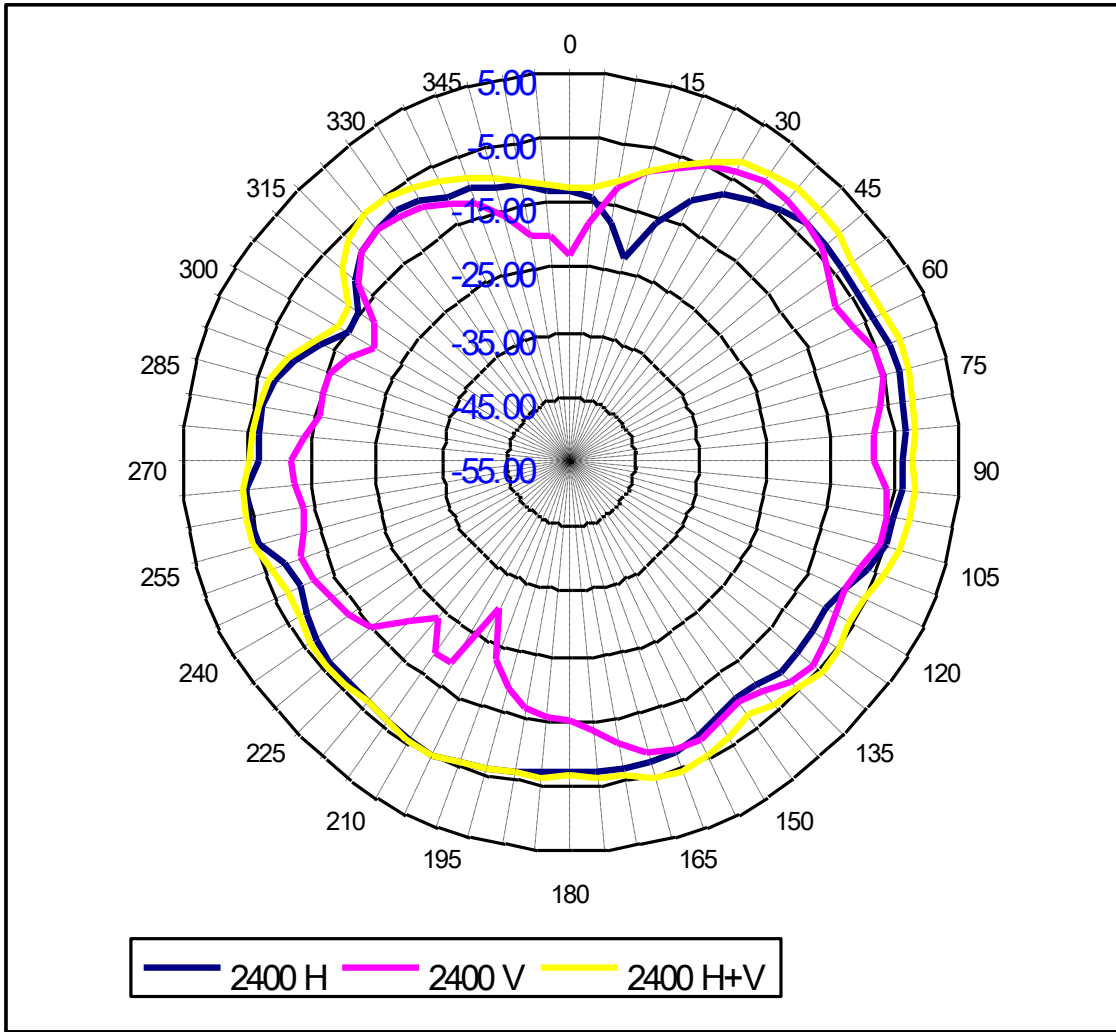

Center Frequency	2400 MHz
Horizontal (dBi) peak	-2.58
Vertical (dBi) peak	-2.73

Tx2 (or Rx2) antenna: 2450 MHz (Plot is not required if 2nd Antenna is receive only e.g. Rx2 for 512 family)

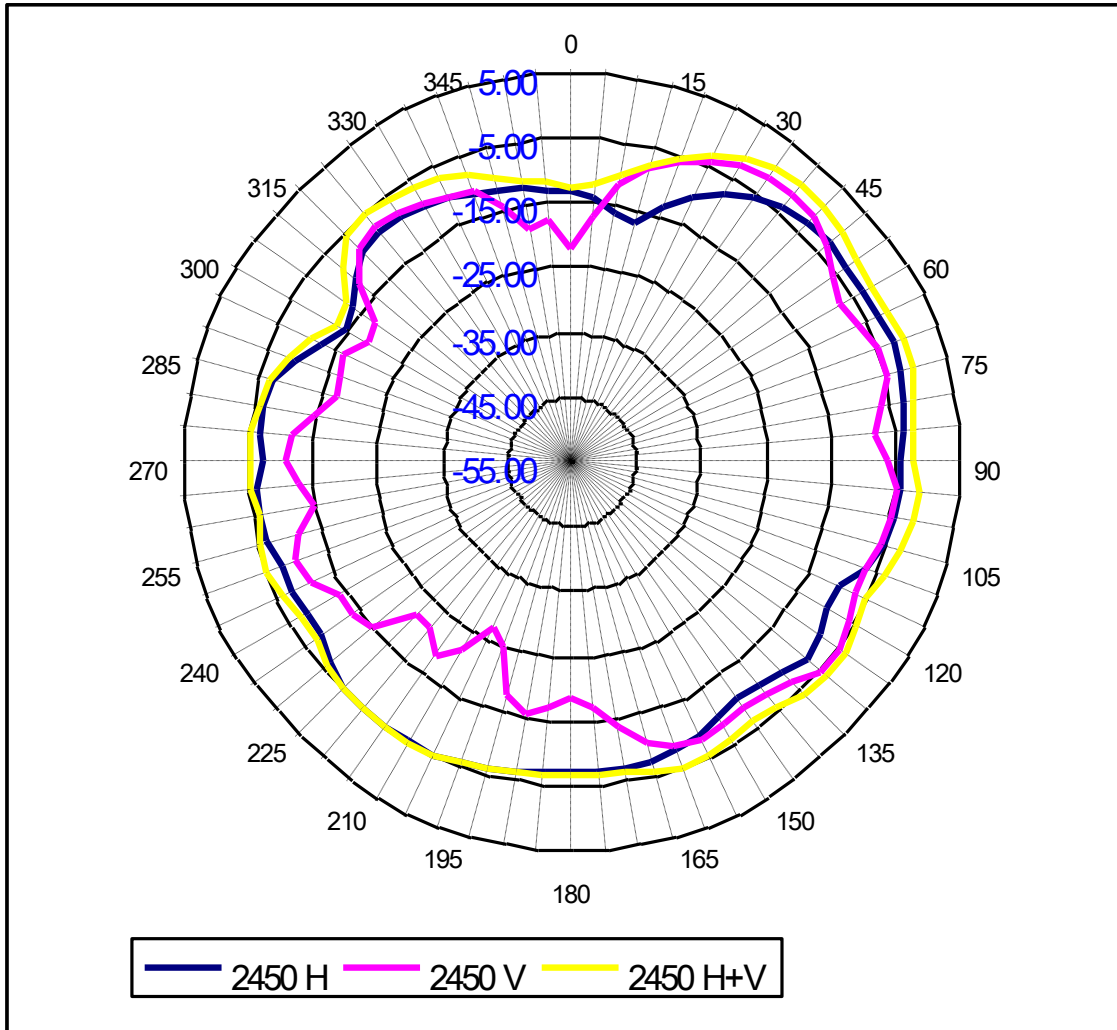

Center Frequency	2450 MHz
Horizontal (dBi) peak	-2.14
Vertical (dBi) peak	-1.91

Tx2 (or Rx2) antenna: 2500 MHz (Plot is not required if 2nd Antenna is receive only e.g. Rx2 for 512 family)

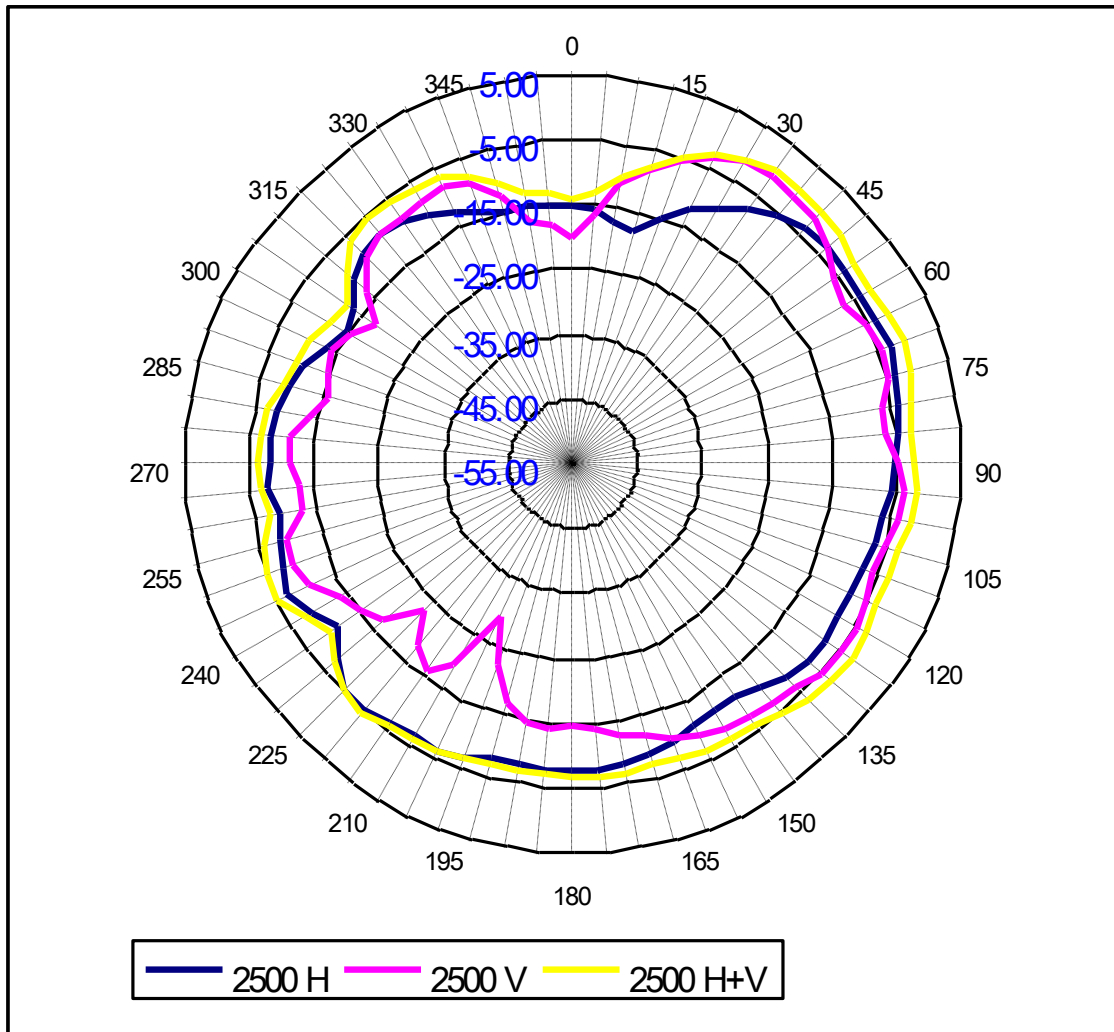

Center Frequency	2500 MHz
Horizontal (dBi) peak	-2.86
Vertical (dBi) peak	-1.52

Tx3 (or Rx3) antenna: 2400 MHz (Plot is not required if 2nd Antenna is receive only e.g. Rx3 for 512 family)

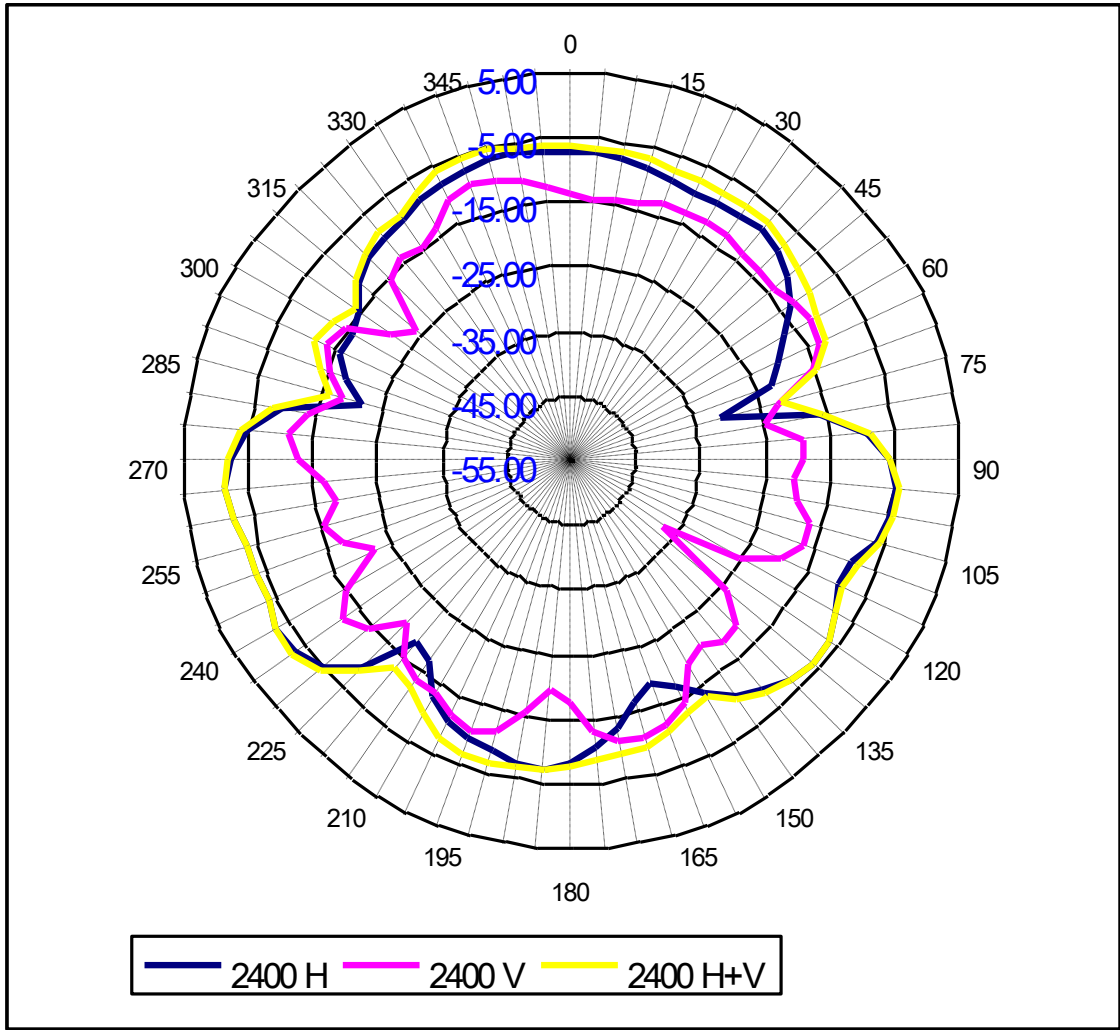

Center Frequency	2400 MHz
Horizontal (dBi) peak	-1.78
Vertical (dBi) peak	-10.25

Tx3 (or Rx3) antenna: 2450 MHz (Plot is not required if 2nd Antenna is receive only e.g. Rx3 for 512 family)

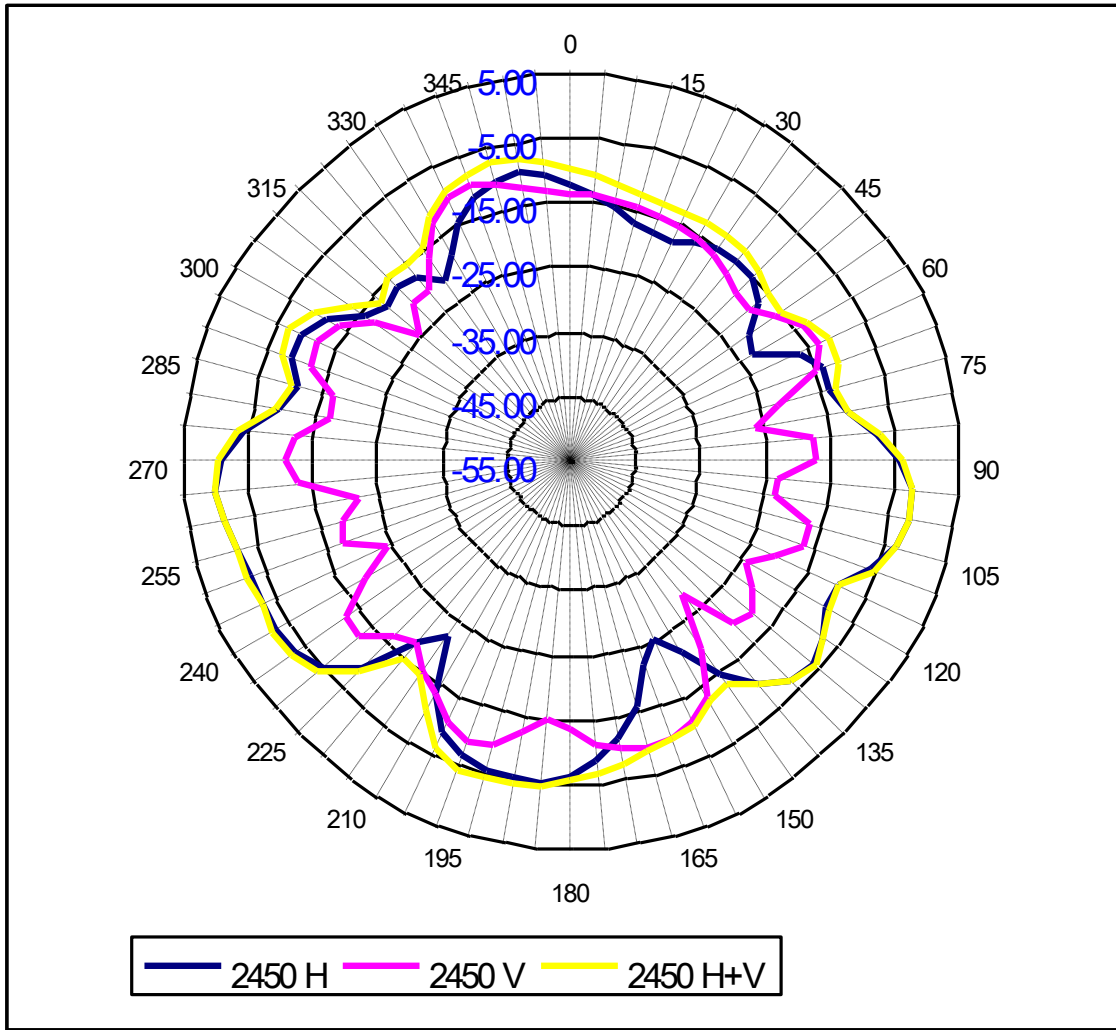

Center Frequency	2450 MHz
Horizontal (dBi) peak	-0.60
Vertical (dBi) peak	-8.78

Tx3 (or Rx3) antenna: 2500 MHz (Plot is not required if 2nd Antenna is receive only e.g. Rx3 for 512 family)

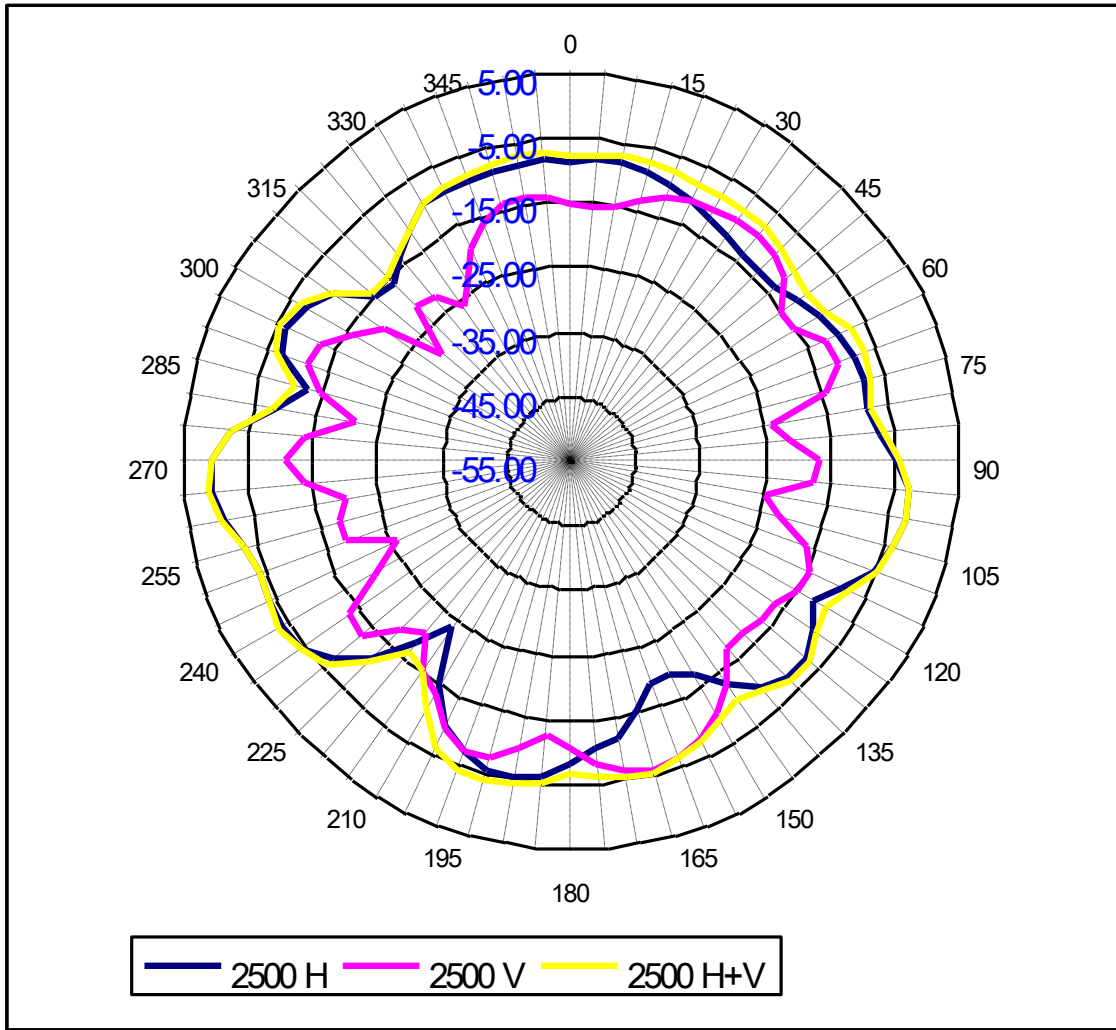

Center Frequency	2500 MHz
Horizontal (dBi) peak	0.18
Vertical (dBi) peak	-5.96

2490-2700MHz radiation characteristic

Tx1antenna: 2501MHz

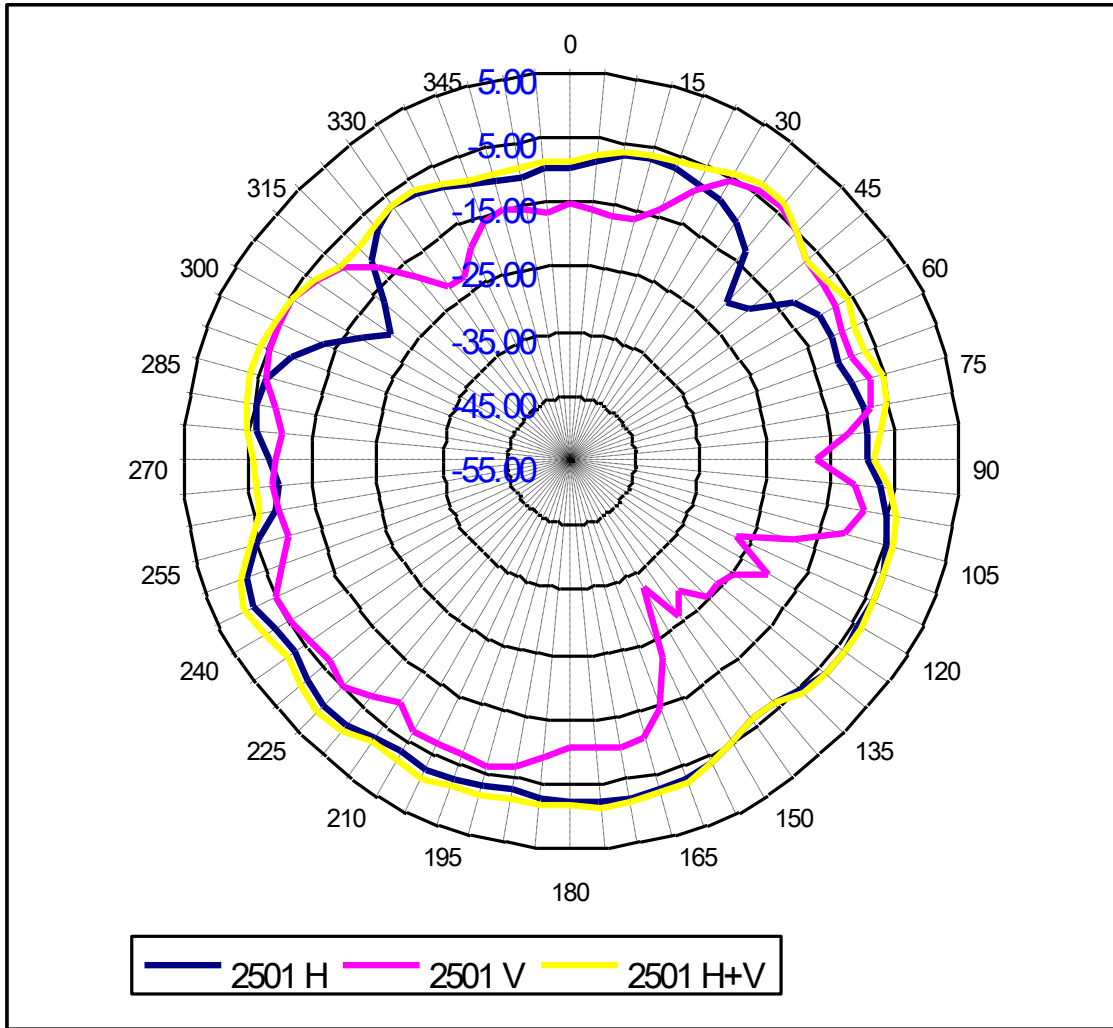

Center Frequency	2501MHz
Horizontal (dBi) peak	-1.28
Vertical (dBi) peak	-4.12

Tx1 antenna: 2593MHz

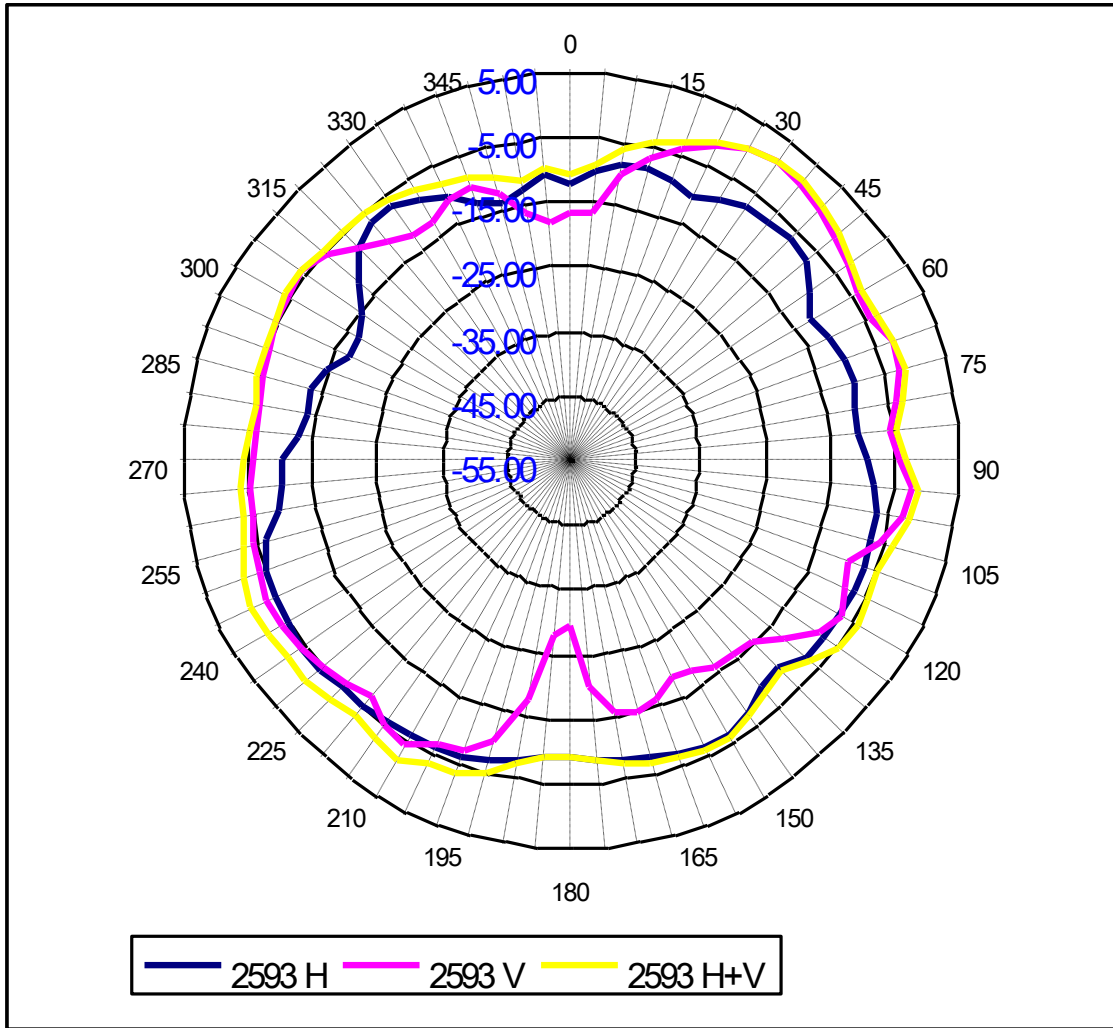

Center Frequency	2593 MHz
Horizontal (dBi) peak	-4.79
Vertical (dBi) peak	0.60

Tx1 antenna: 2685 MHz

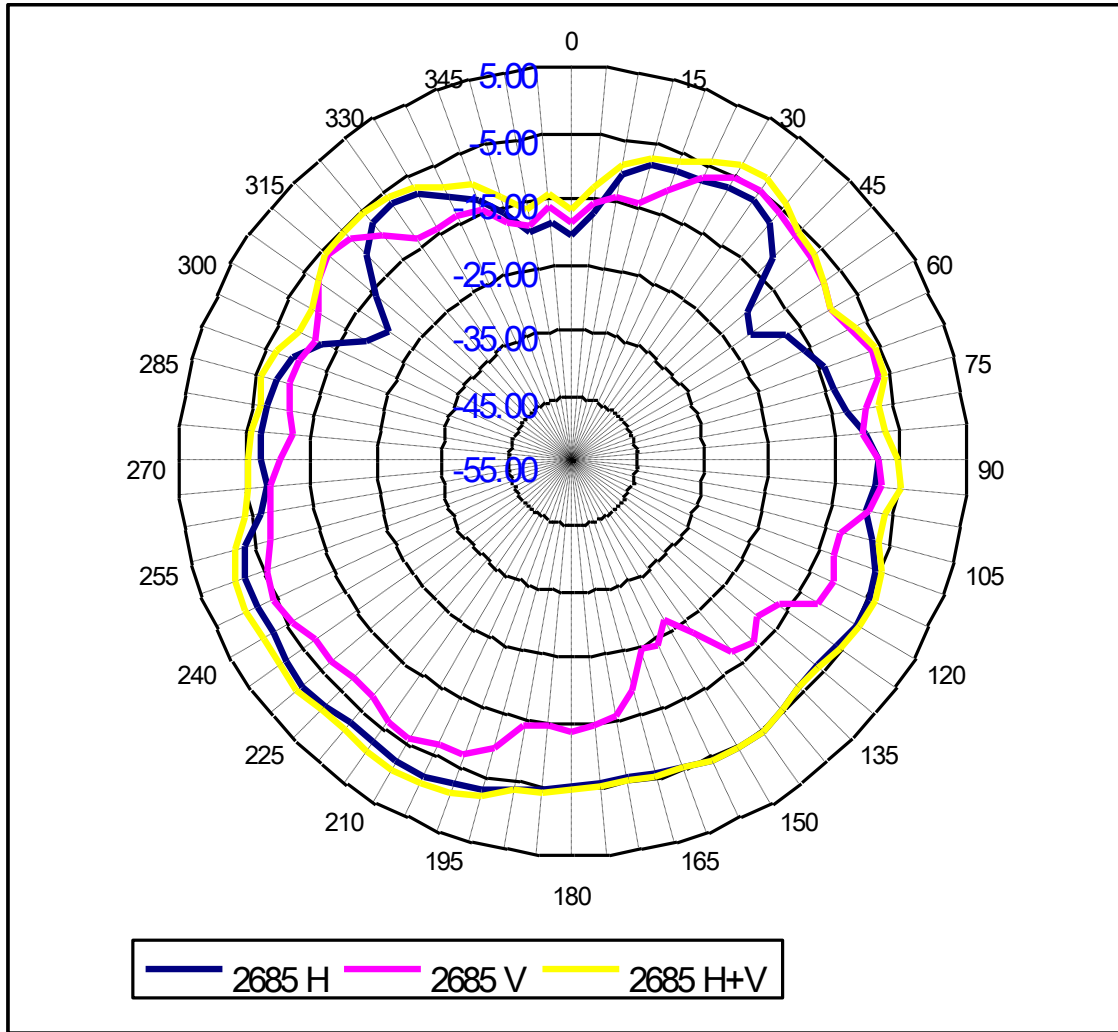

Center Frequency	2685 MHz
Horizontal (dBi) peak	-1.19
Vertical (dBi) peak	-4.93

Tx2 (or Rx2) antenna: 2501MHz (Plot is not required if 2nd Antenna is receive only e.g. Rx2 for 512 family)

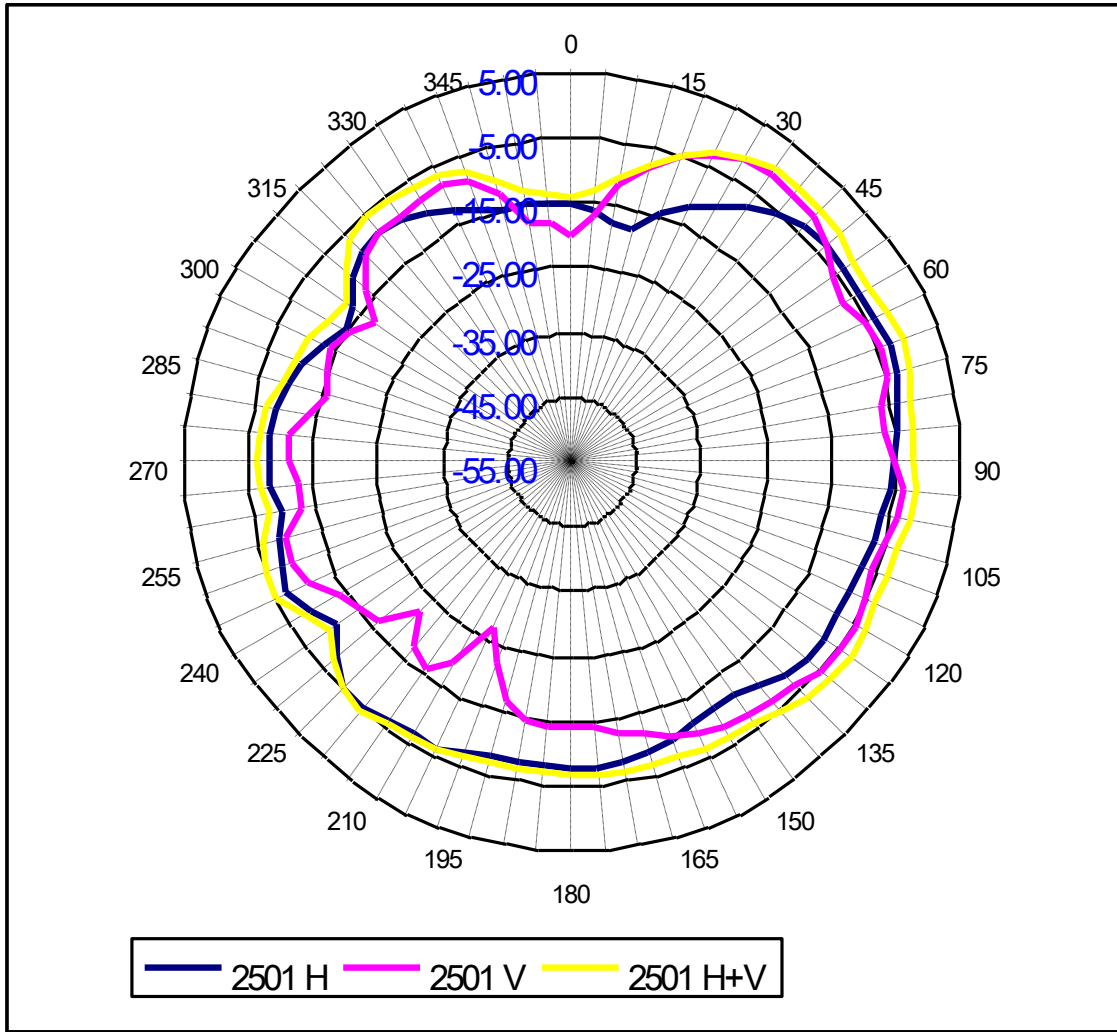

Center Frequency	2501 MHz
Horizontal (dBi) peak	-2.88
Vertical (dBi) peak	-1.53

Tx2 (or Rx2) antenna: 2593MHz (Plot is not required if 2nd Antenna is receive only e.g. Rx2 for 512 family)

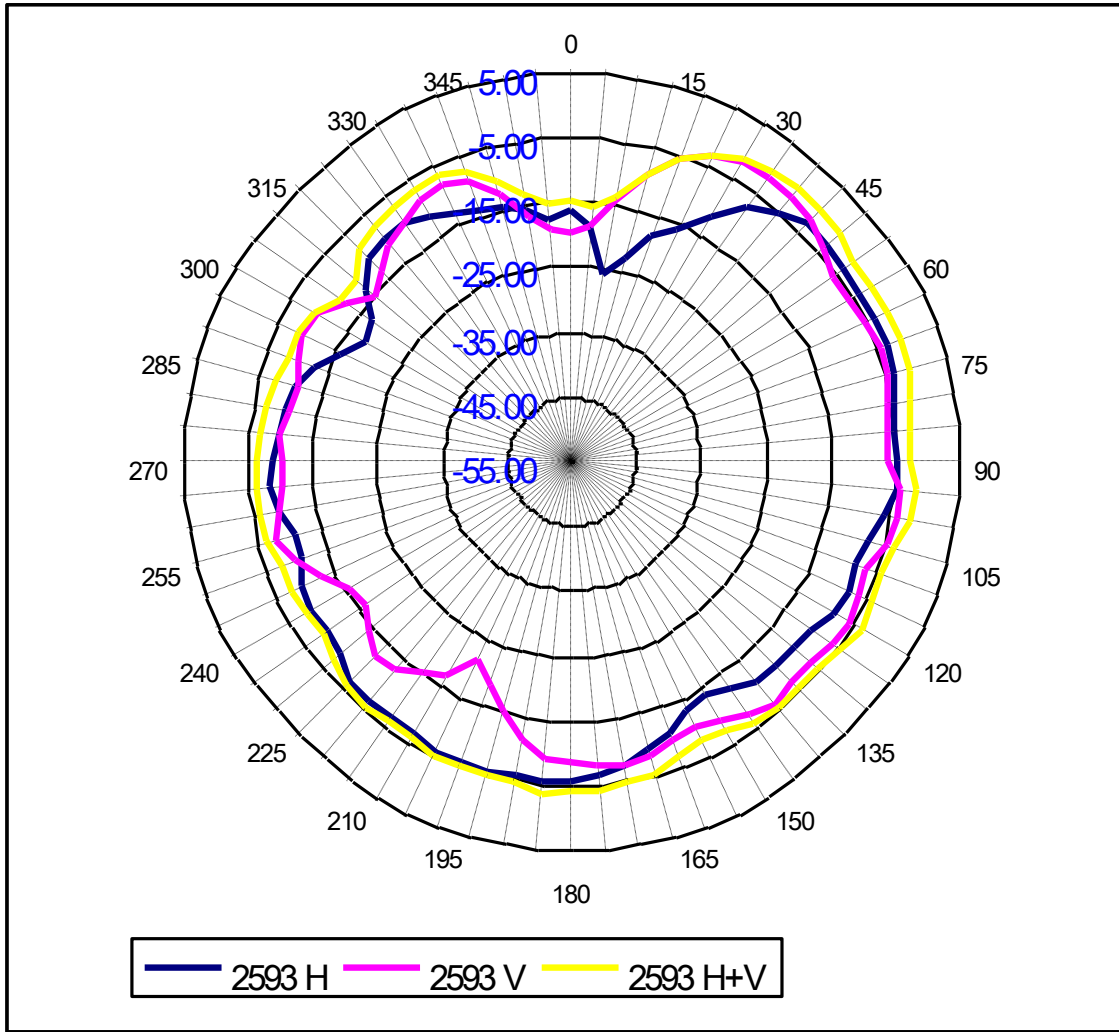

Center Frequency	2593 MHz
Horizontal (dBi) peak	-3.19
Vertical (dBi) peak	-1.97

Tx2 (or Rx2) antenna: 2685 MHz (Plot is not required if 2nd Antenna is receive only e.g. Rx2 for 512 family)

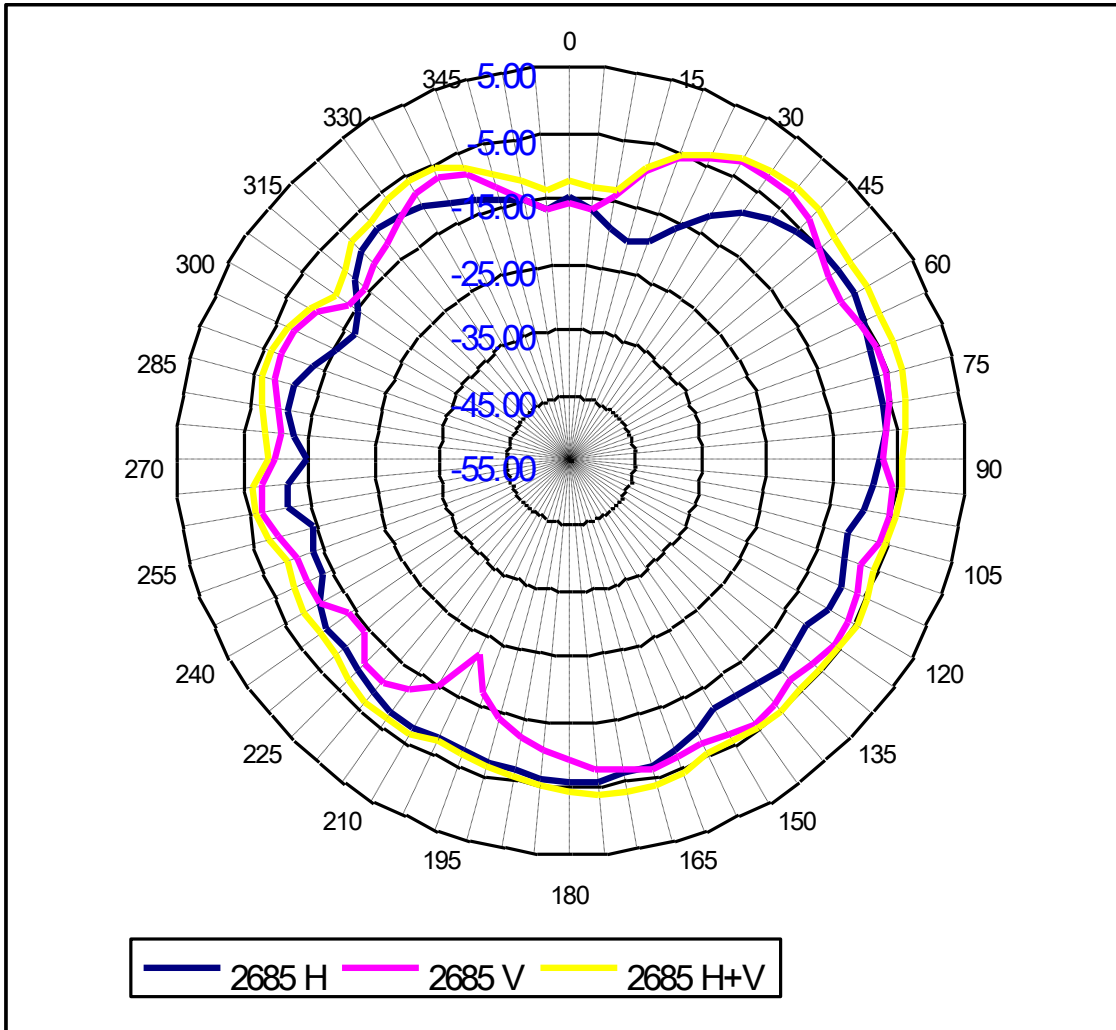

Center Frequency	2685 MHz
Horizontal (dBi) peak	-4.66
Vertical (dBi) peak	-2.31

5150-5350 MHz radiation characteristic

Tx1 antenna: 5150 MHz

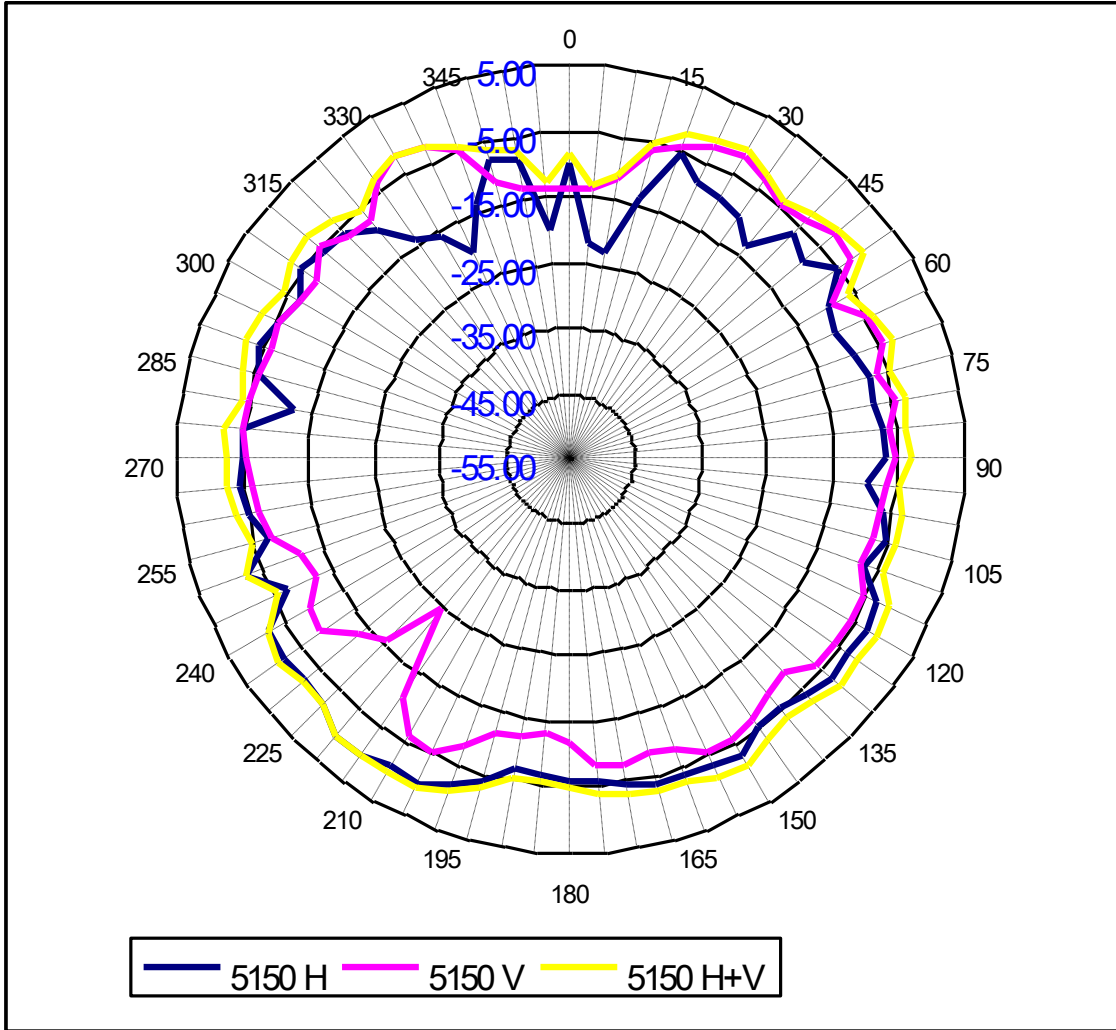

Center Frequency	5150 MHz
Horizontal (dBi) peak	0.48
Vertical (dBi) peak	-1.74

Tx1 antenna: 5250 MHz

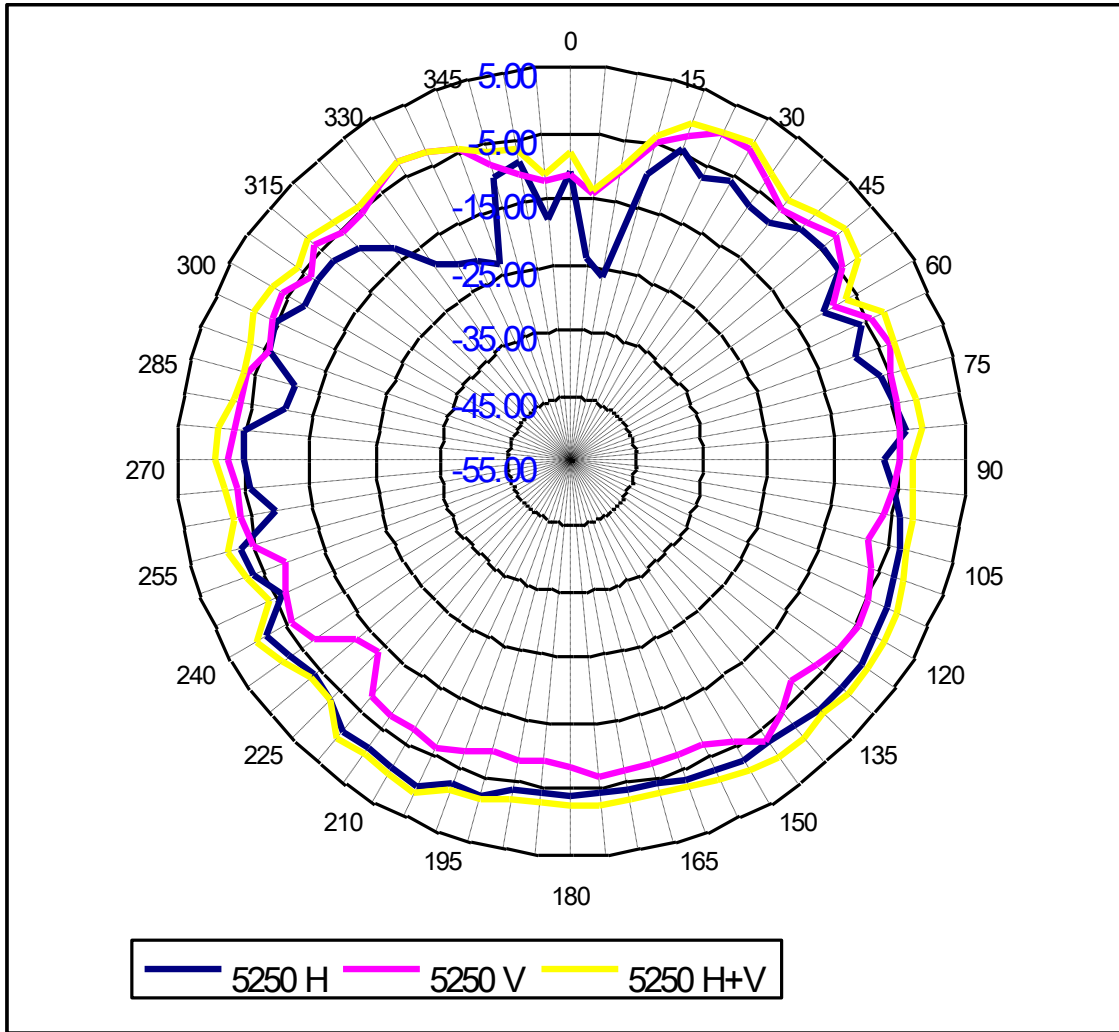

Center Frequency	5250 MHz
Horizontal (dBi) peak	0.27
Vertical (dBi) peak	-0.49

Tx1 antenna: 5350 MHz

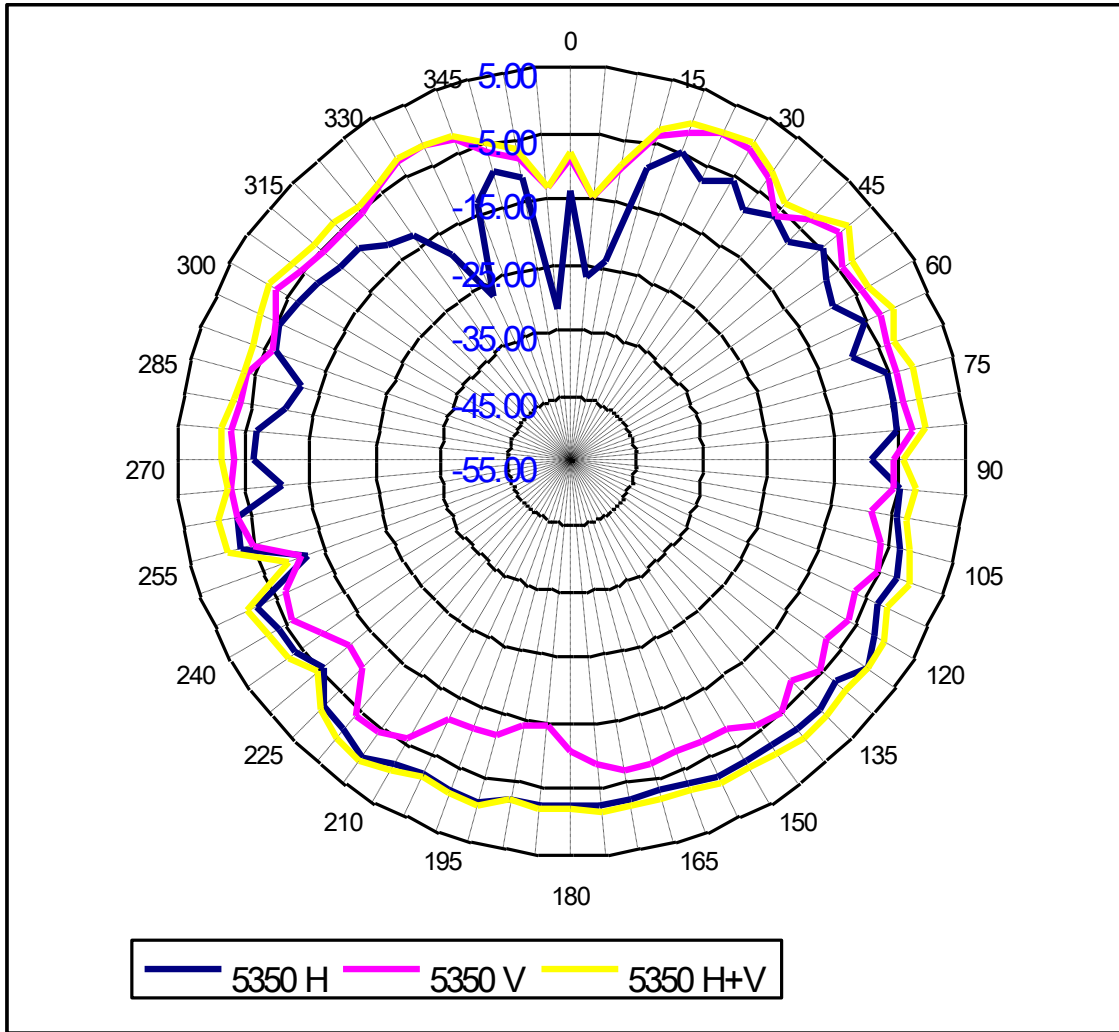

Center Frequency	5350 MHz
Horizontal (dBi) peak	-0.08
Vertical (dBi) peak	-0.32

Tx2 (or Rx2) antenna: 5150 MHz (Plot is not required if 2nd Antenna is receive only e.g. Rx2 for 512 family)

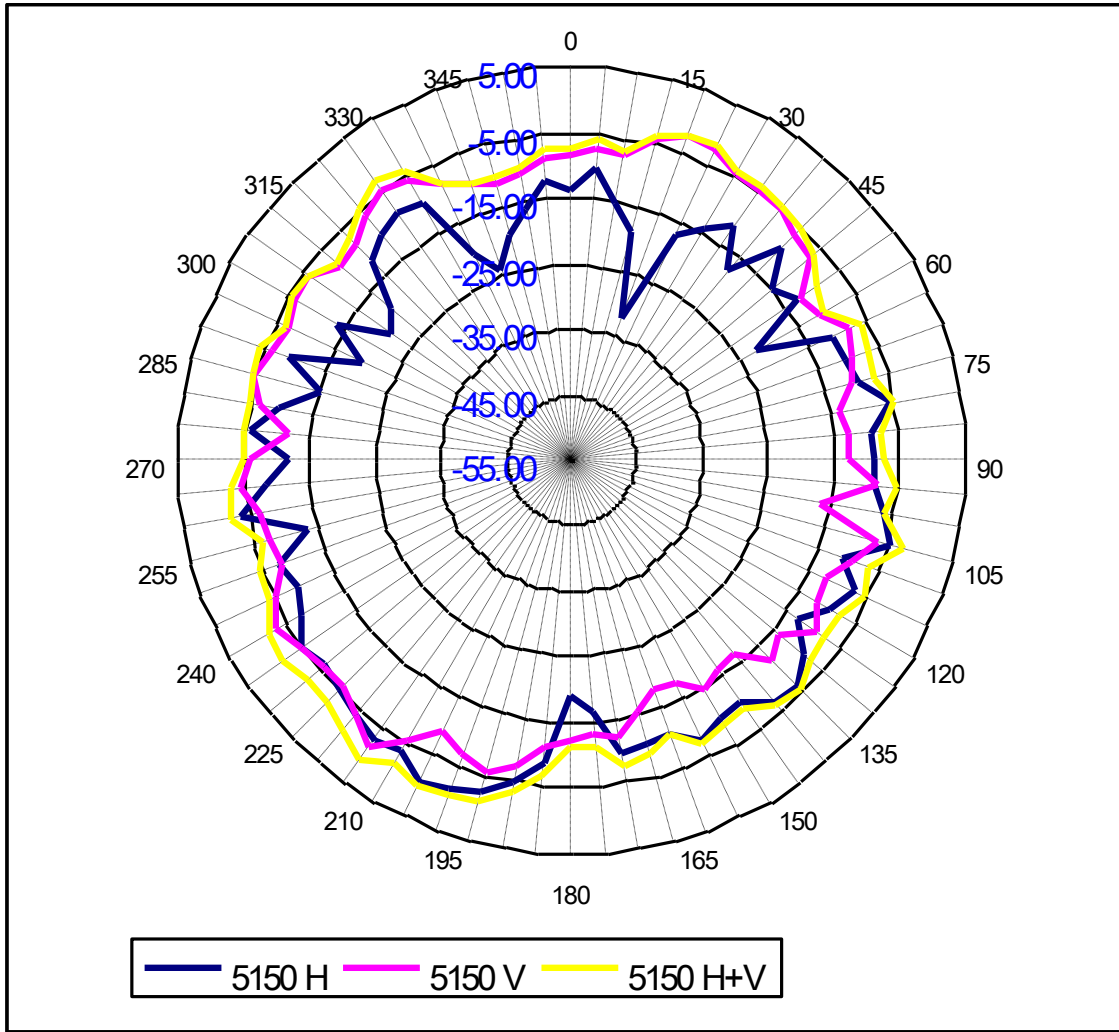

Center Frequency	5150 MHz
Horizontal (dBi) peak	-0.65
Vertical (dBi) peak	-1.28

Tx2 (or Rx2) antenna: 5250 MHz (Plot is not required if 2nd Antenna is receive only e.g. Rx2 for 512 family)

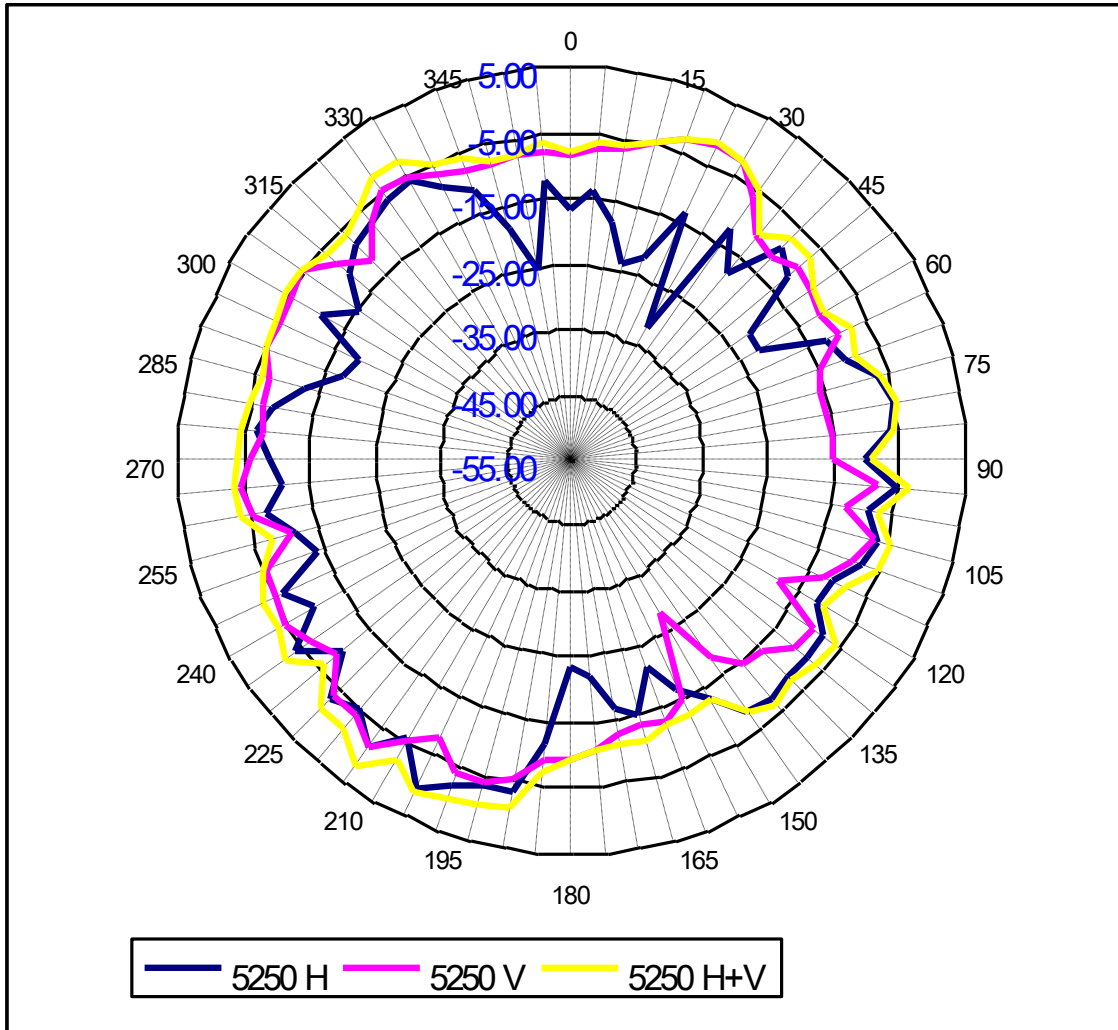

Center Frequency	5250 MHz
Horizontal (dBi) peak	0.65
Vertical (dBi) peak	-1.11

Tx2 (or Rx2) antenna: 5350 MHz (Plot is not required if 2nd Antenna is receive only e.g. Rx2 for 512 family)

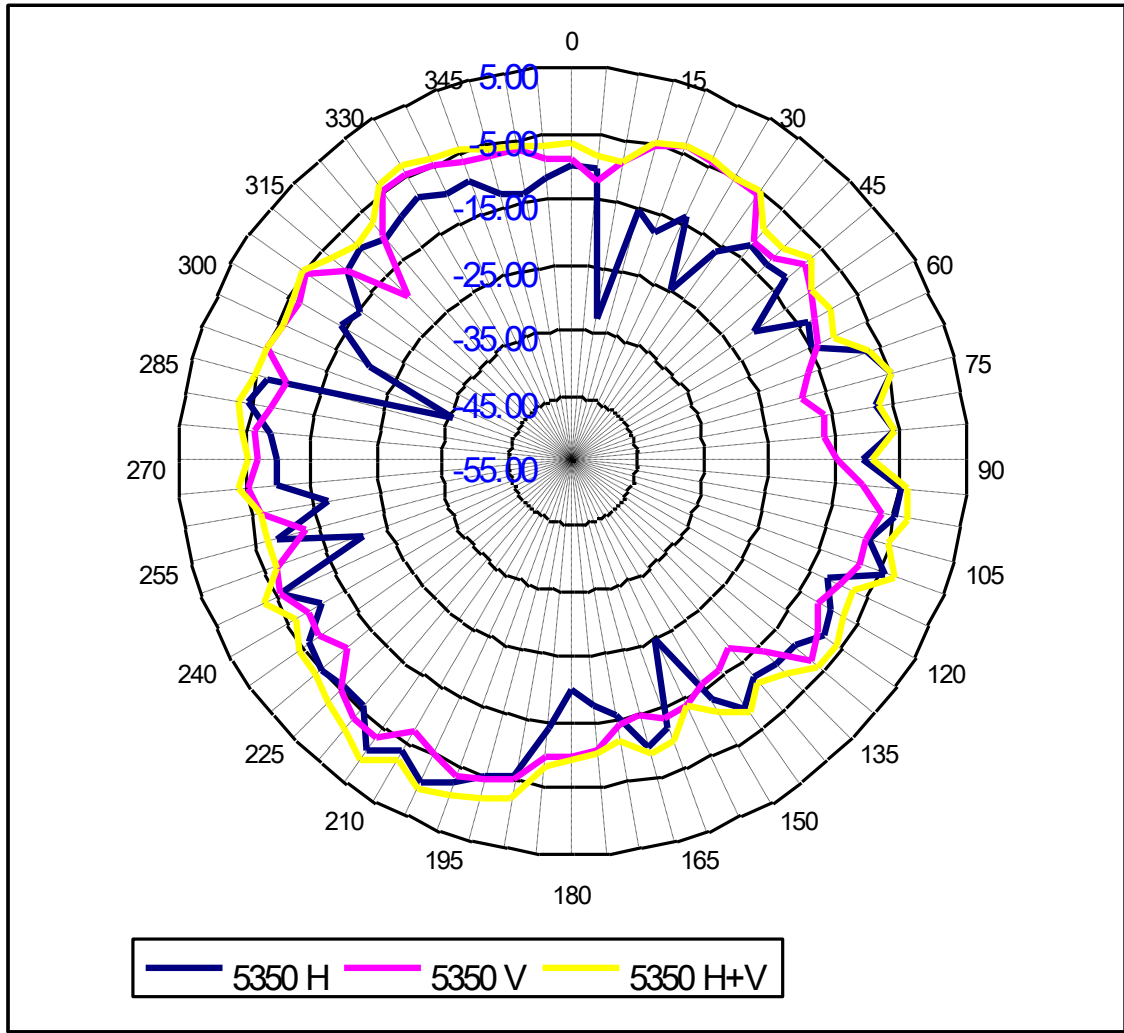

Center Frequency	5350 MHz
Horizontal (dBi) peak	-0.66
Vertical (dBi) peak	-3.05

Tx3 (or Rx3) antenna: 5150 MHz (Plot is not required if 2nd Antenna is receive only e.g. Rx3 for 512 family)

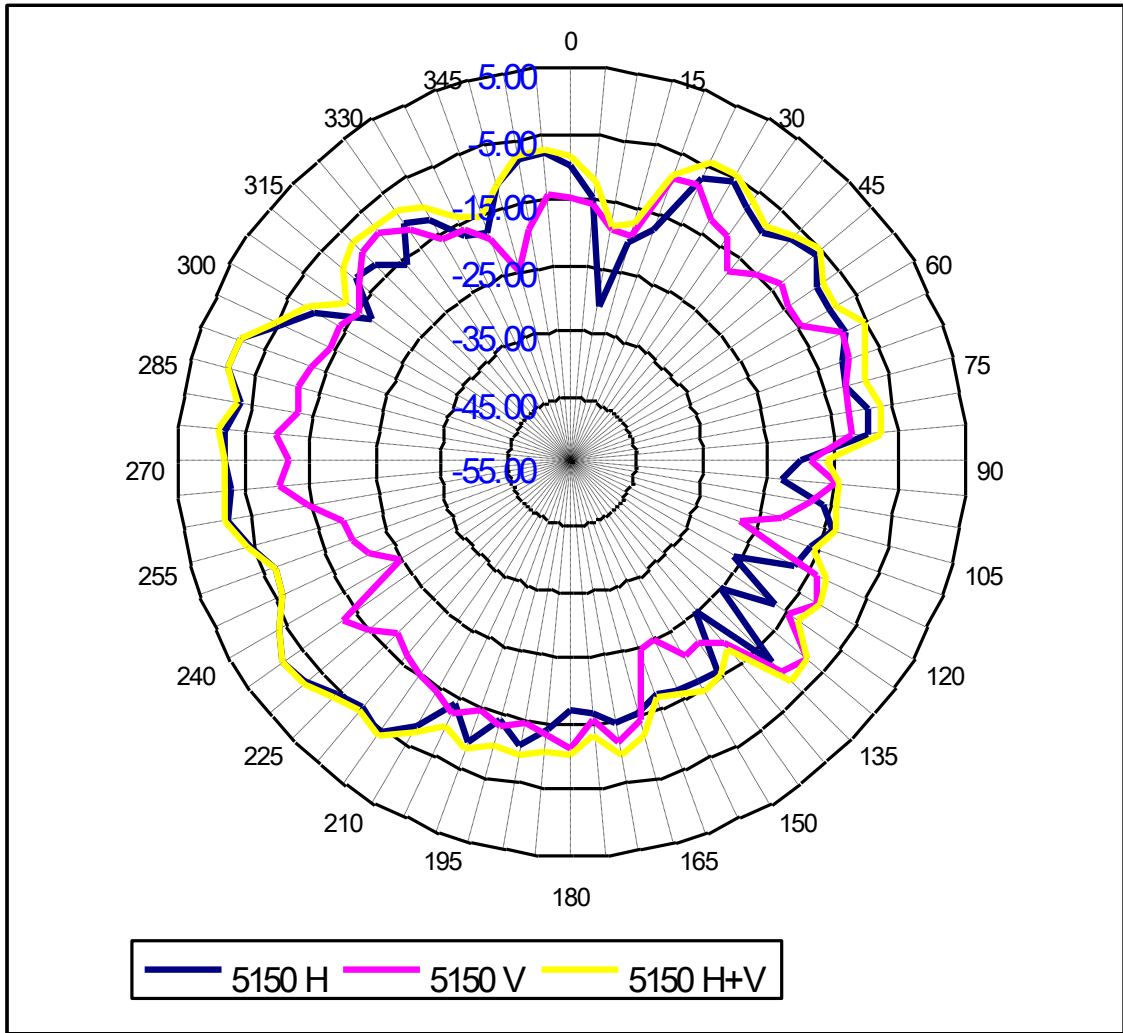

Center Frequency	5150 MHz
Horizontal (dBi) peak	-1.07
Vertical (dBi) peak	-7.71

Tx3 (or Rx3) antenna: 5250 MHz (Plot is not required if 2nd Antenna is receive only e.g. Rx3 for 512 family)

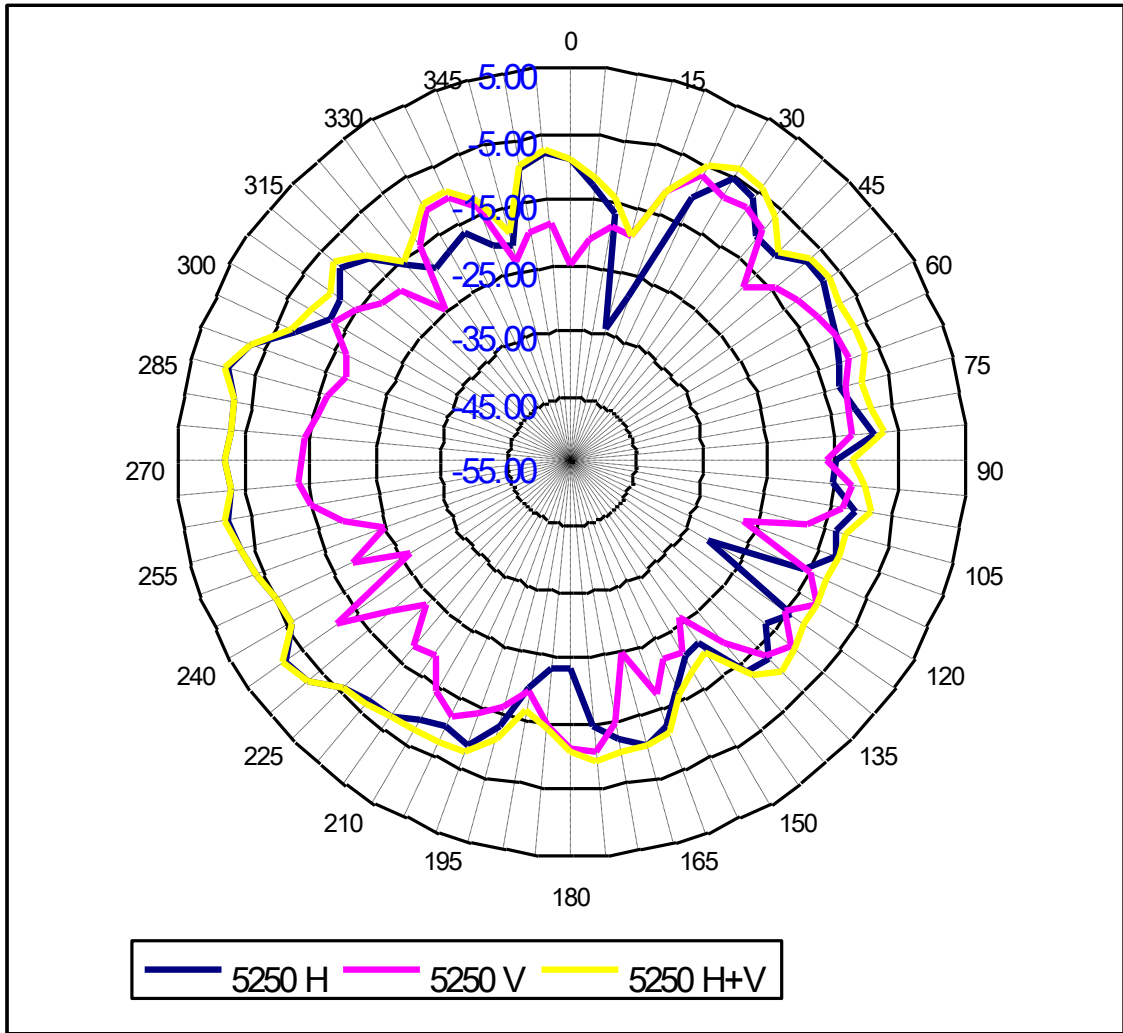

Center Frequency	5250 MHz
Horizontal (dBi) peak	-0.63
Vertical (dBi) peak	-7.13

Tx3 (or Rx3) antenna: 5350 MHz (Plot is not required if 2nd Antenna is receive only e.g. Rx3 for 512 family)

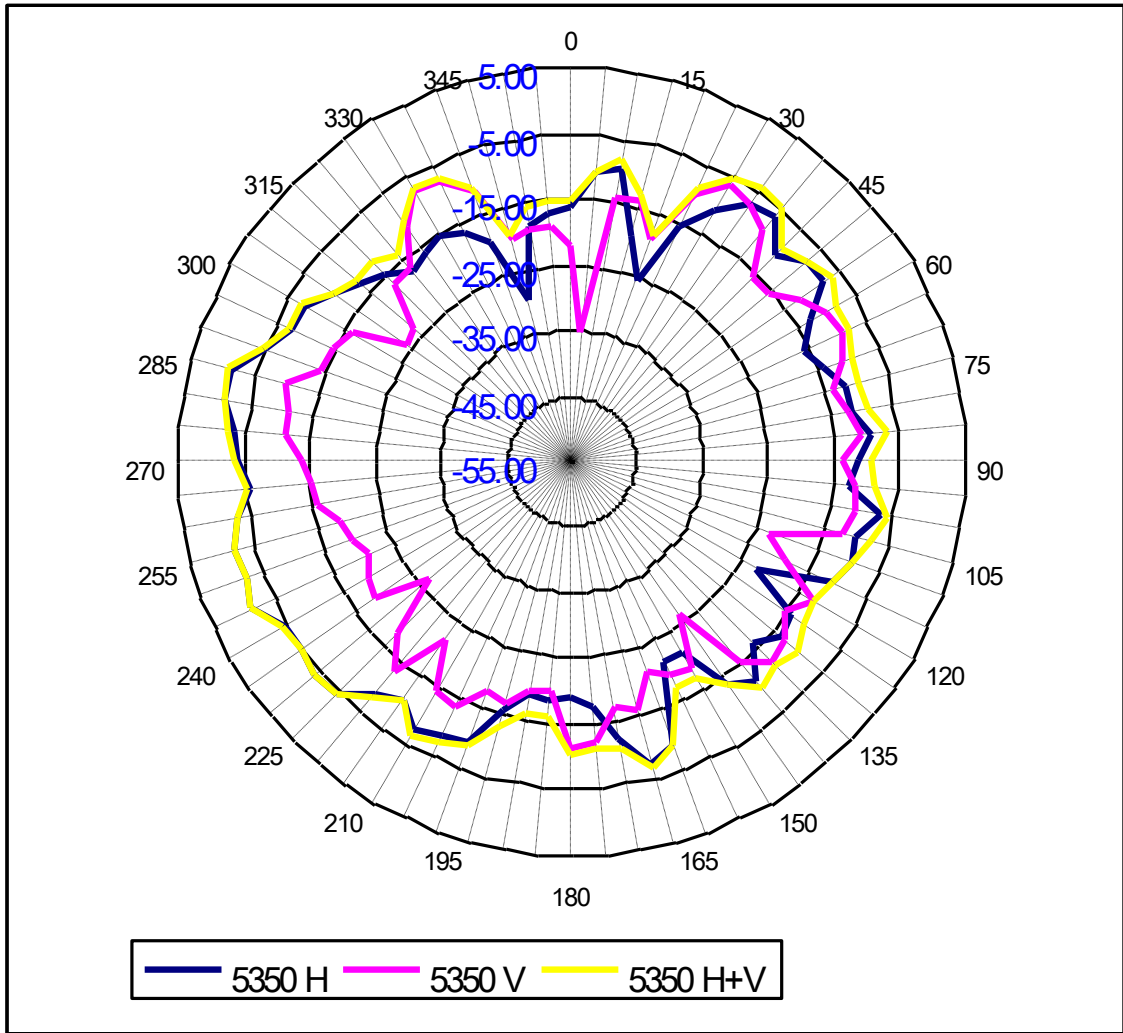

Center Frequency	5350 MHz
Horizontal (dBi) peak	-1.18
Vertical (dBi) peak	-6.92

5470-5725MHz radiation characteristic

Tx1 antenna: 5470 MHz

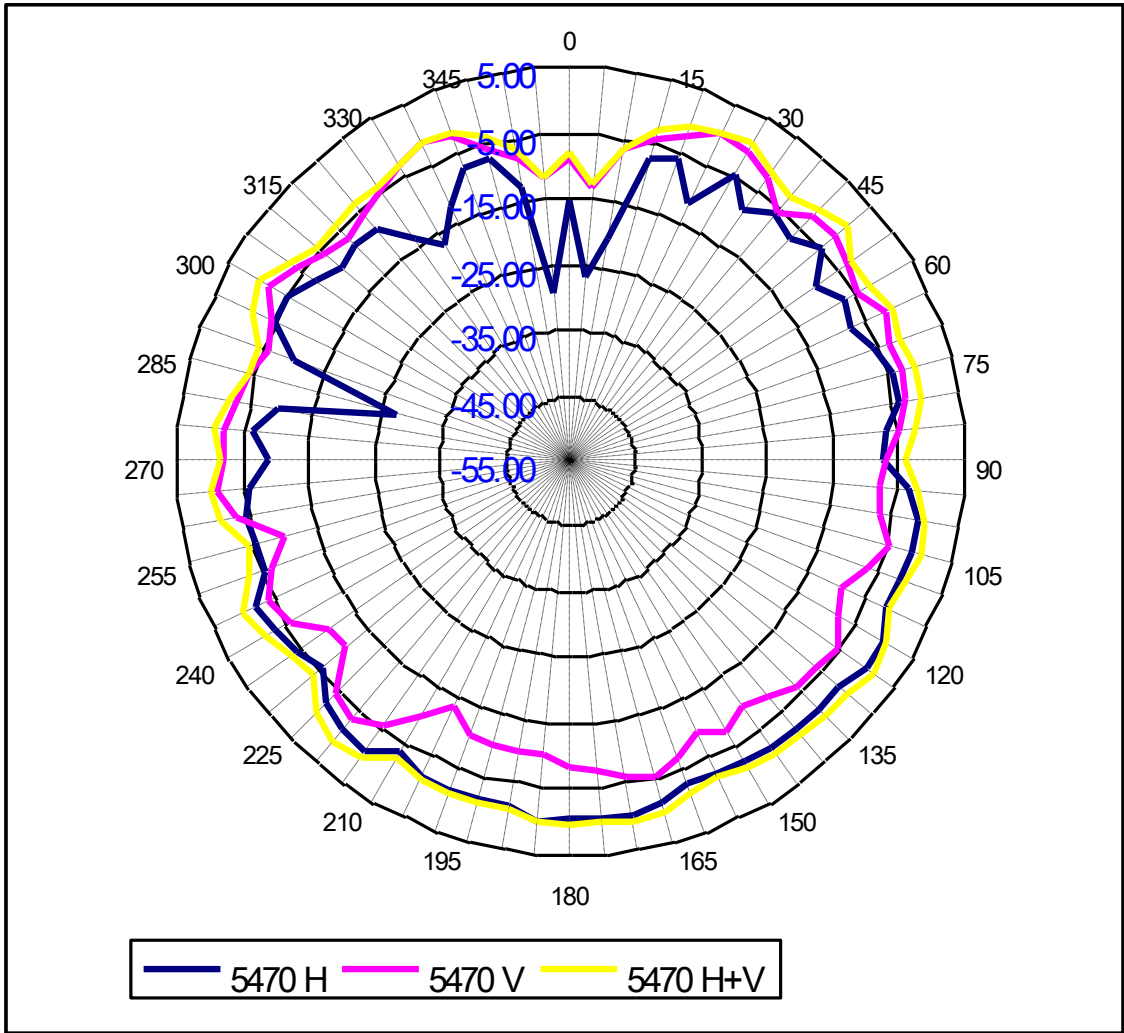

Center Frequency	5470 MHz
Horizontal (dBi) peak	0.80
Vertical (dBi) peak	-0.47

Tx1 antenna: 5597.5 MHz

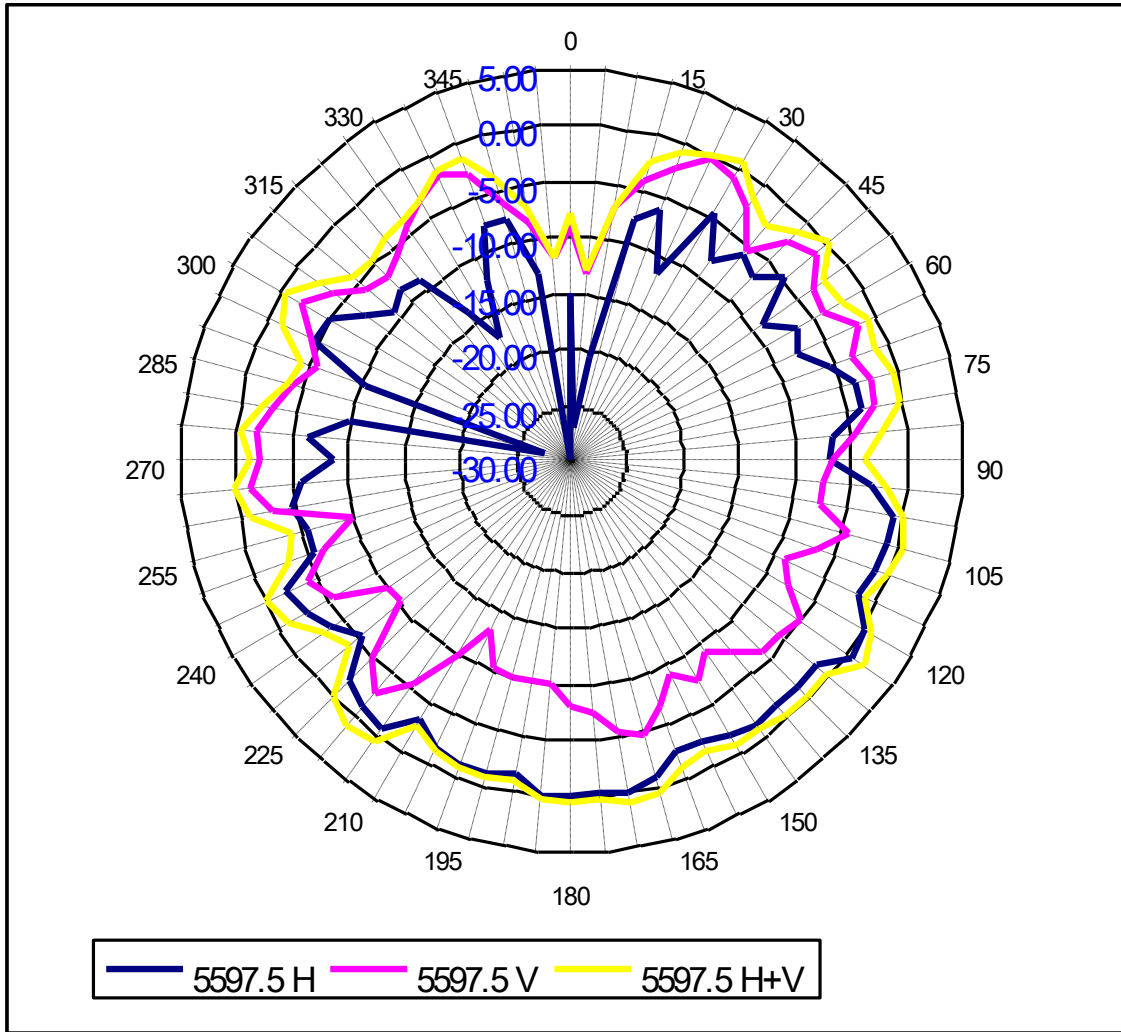

Center Frequency	5597.5 MHz
Horizontal (dBi) peak	0.48
Vertical (dBi) peak	-1.25

Tx1 antenna: 5725 MHz

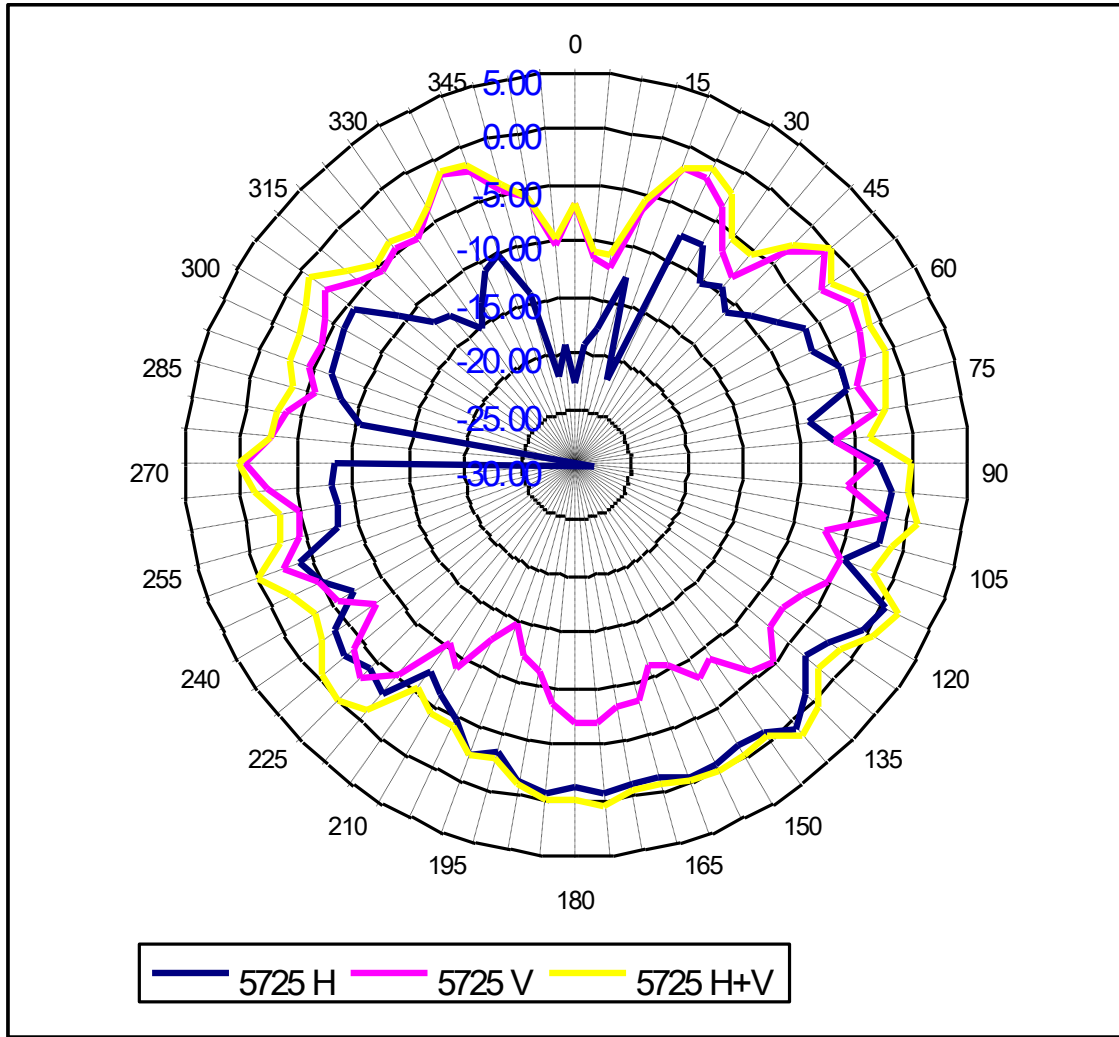

Center Frequency	5725 MHz
Horizontal (dBi) peak	0.72
Vertical (dBi) peak	-0.76

Tx2 (or Rx2) antenna: 5470 MHz (Plot is not required if 2nd Antenna is receive only e.g. Rx2 for 512 family)

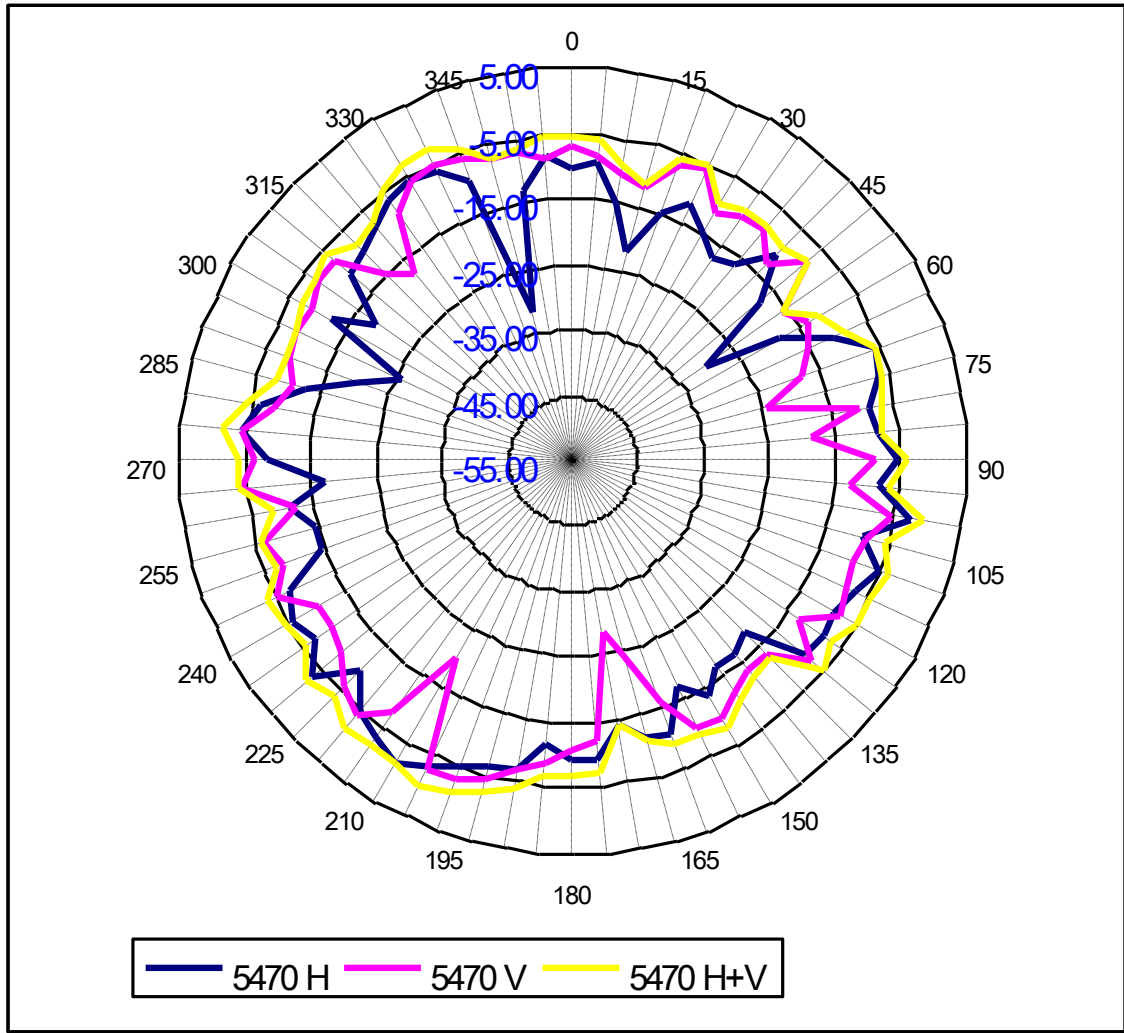

Center Frequency	5470 MHz
Horizontal (dBi) peak	-1.30
Vertical (dBi) peak	-2.84

Tx2 (or Rx2) antenna: 5597.5 MHz (Plot is not required if 2nd Antenna is receive only e.g. Rx2 for 512 family)

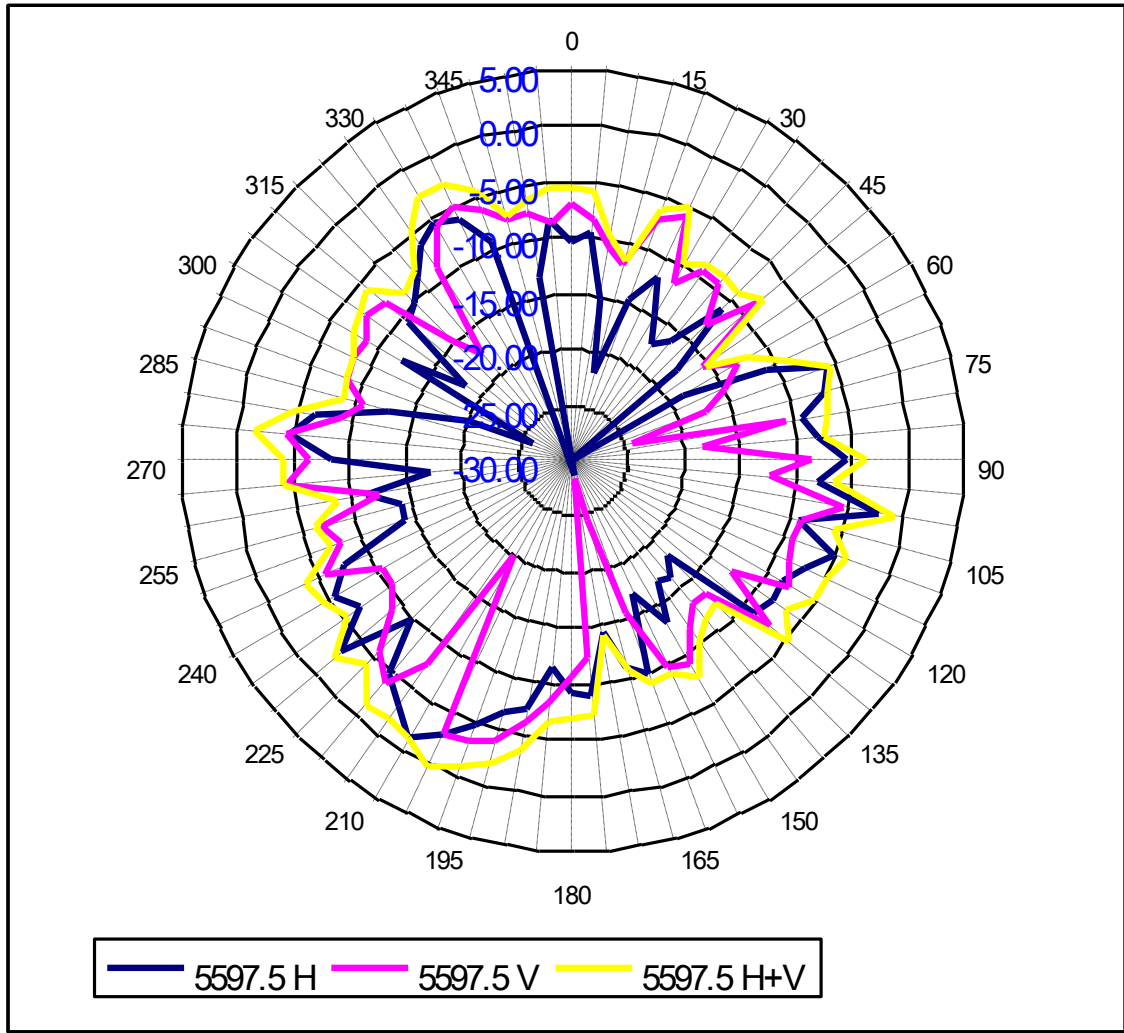

Center Frequency	5597.5 MHz
Horizontal (dBi) peak	-1.58
Vertical (dBi) peak	-4.32

Tx2 (or Rx2) antenna: 5725 MHz (Plot is not required if 2nd Antenna is receive only e.g. Rx2 for 512 family)

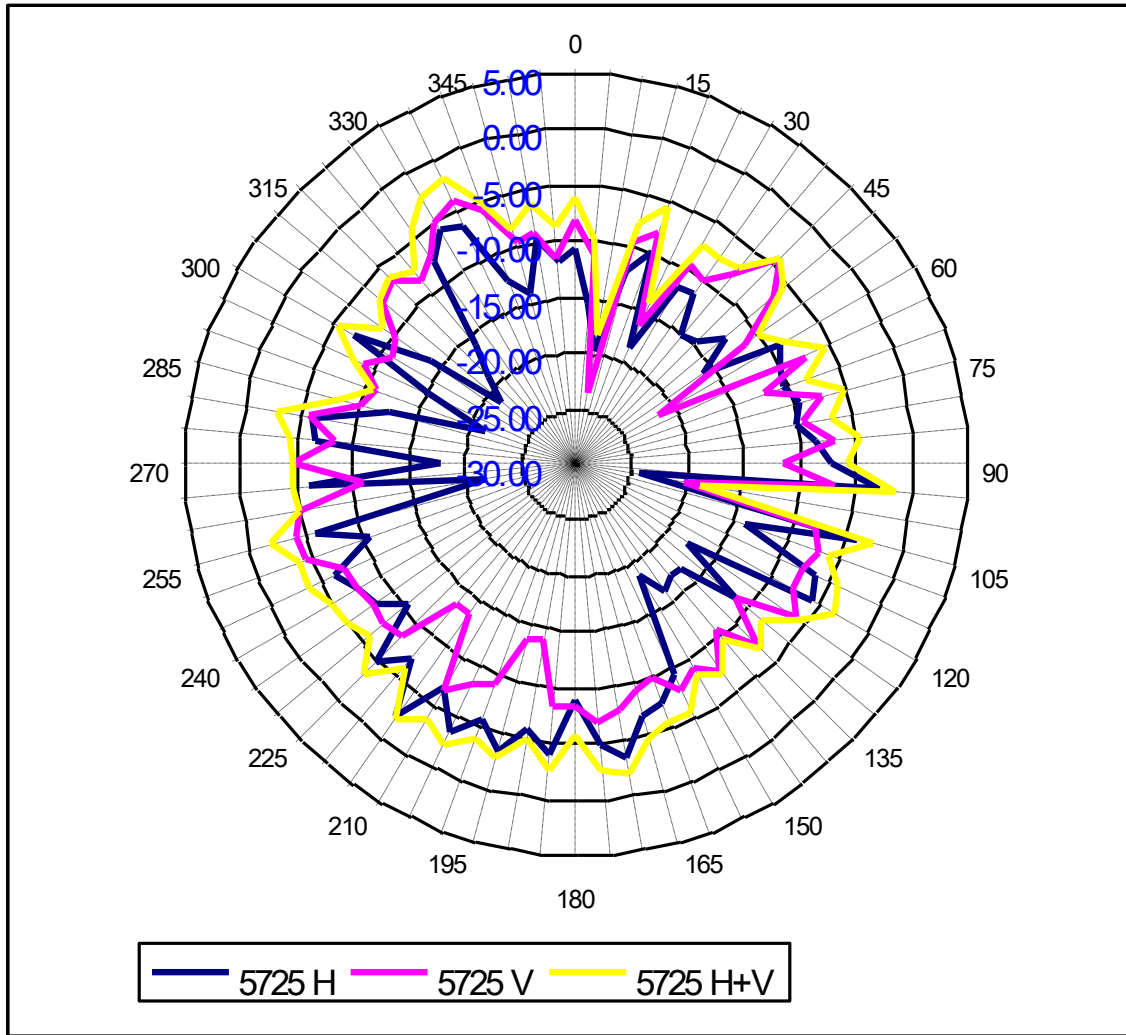

Center Frequency	5725 MHz
Horizontal (dBi) peak	-2.46
Vertical (dBi) peak	-4.01

Tx3 (or Rx3) antenna: 5470 MHz (Plot is not required if 2nd Antenna is receive only e.g. Rx3 for 512 family)

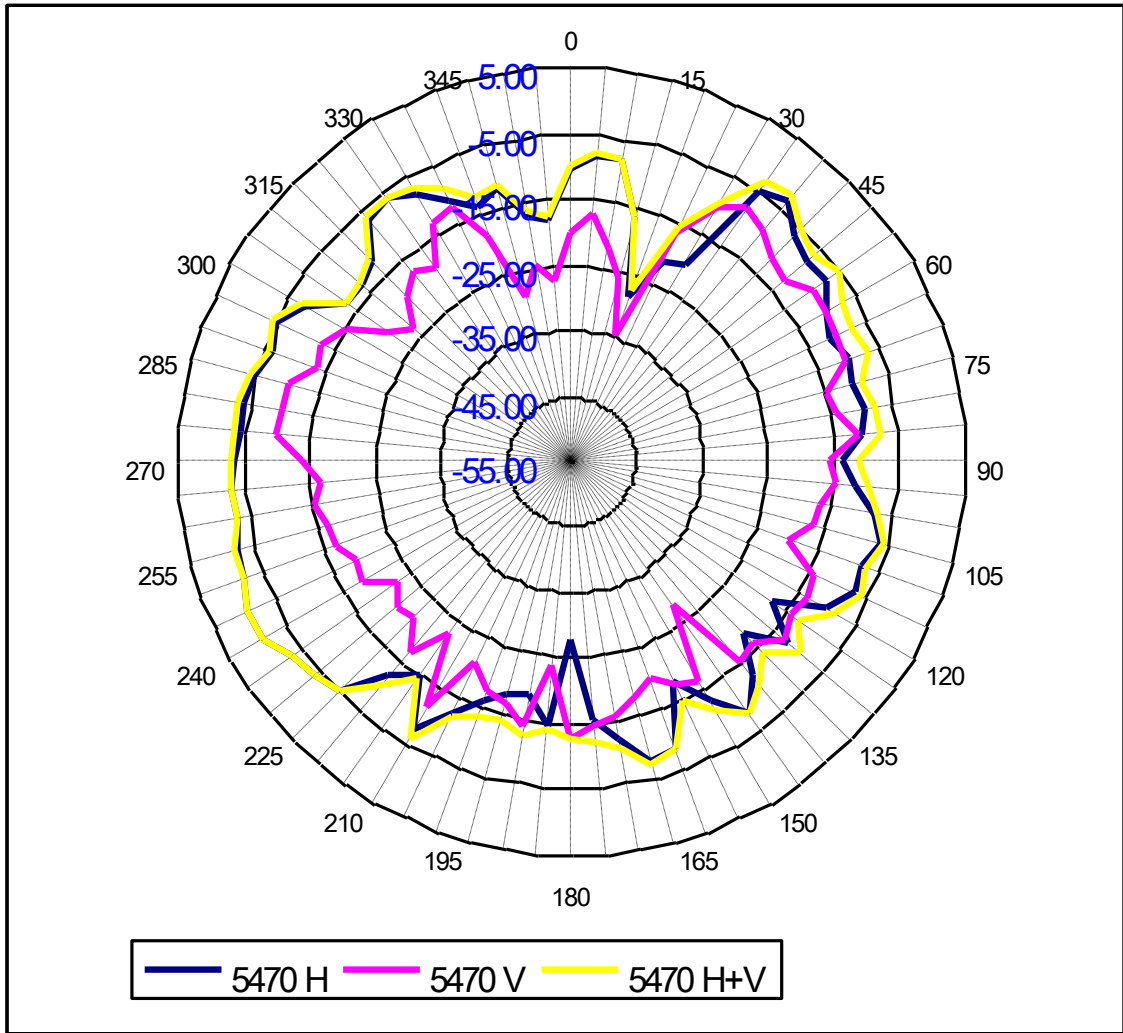

Center Frequency	5470 MHz
Horizontal (dBi) peak	-0.84
Vertical (dBi) peak	-8.37

Tx3 (or Rx3) antenna: 5597.5 MHz (Plot is not required if 2nd Antenna is receive only e.g. Rx3 for 512 family)

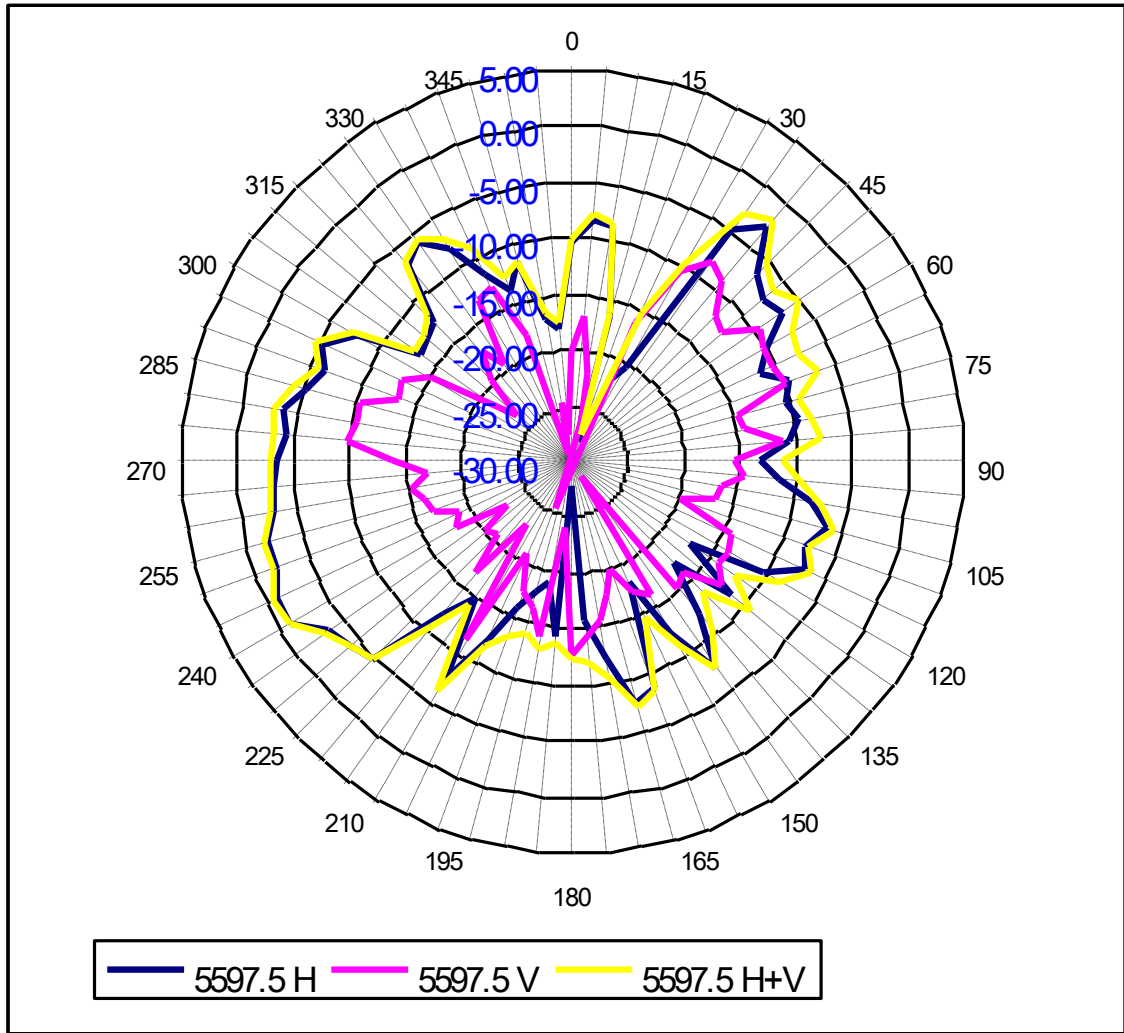

Center Frequency	5597.5 MHz
Horizontal (dBi) peak	-0.73
Vertical (dBi) peak	-5.85

Tx3 (or Rx3) antenna: 5725 MHz (Plot is not required if 2nd Antenna is receive only e.g. Rx3 for 512 family)

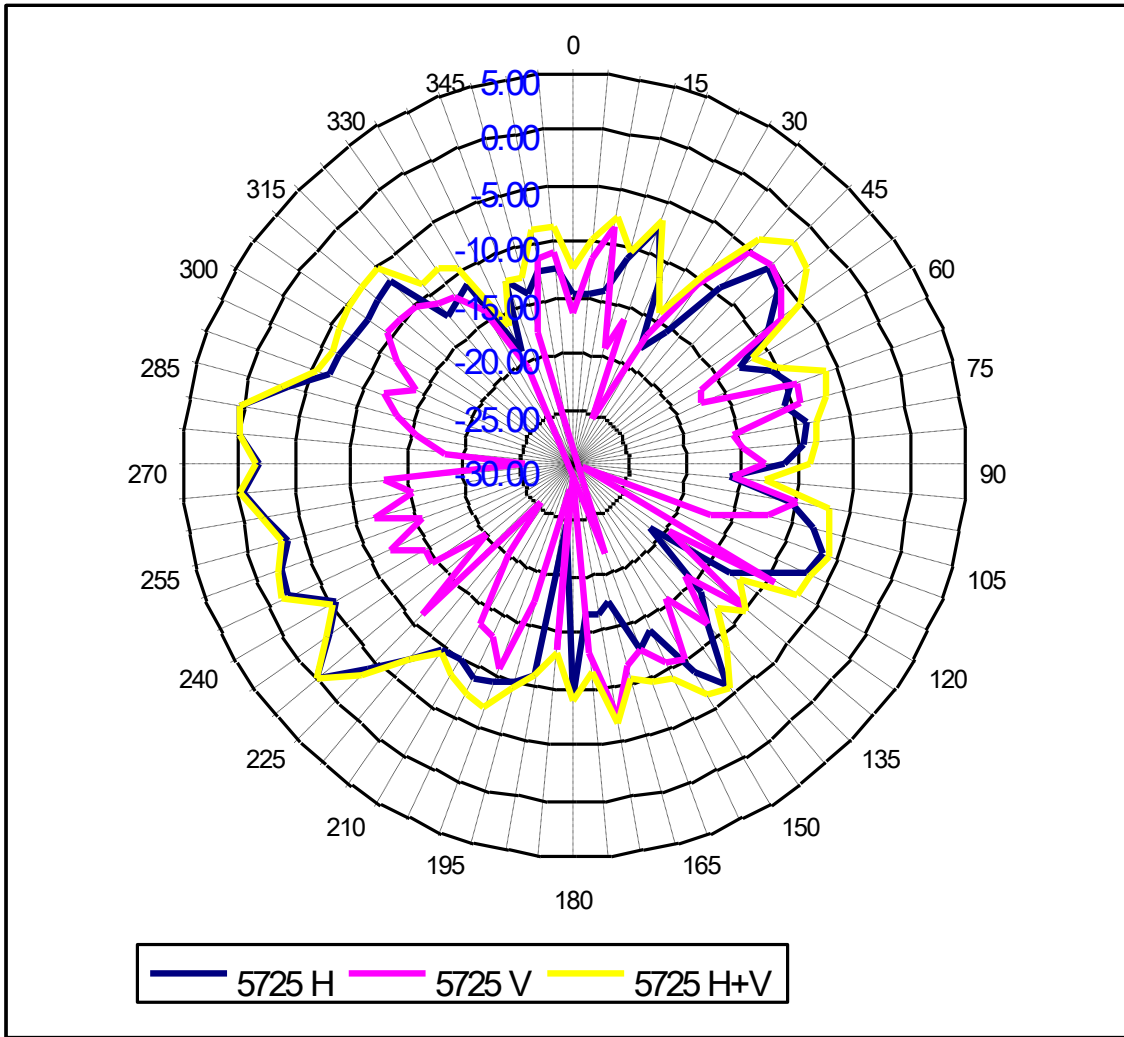

Center Frequency	5725 MHz
Horizontal (dBi) peak	0.15
Vertical (dBi) peak	-5.36

5725-5850 MHz radiation characteristic

Tx1 antenna: 5725 MHz

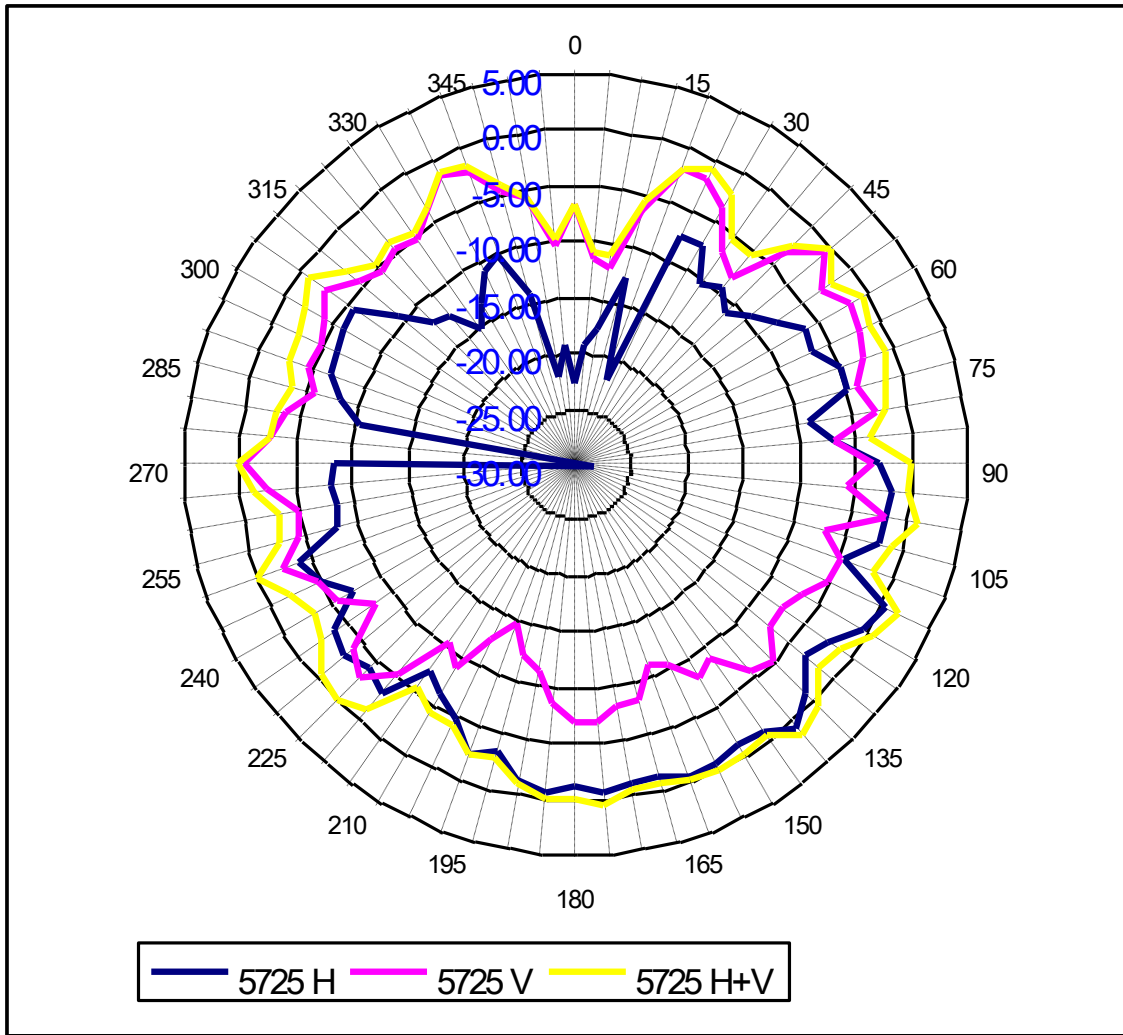

Center Frequency	5725 MHz
Horizontal (dBi) peak	0.72
Vertical (dBi) peak	-0.76

Tx1 antenna: 5785 MHz

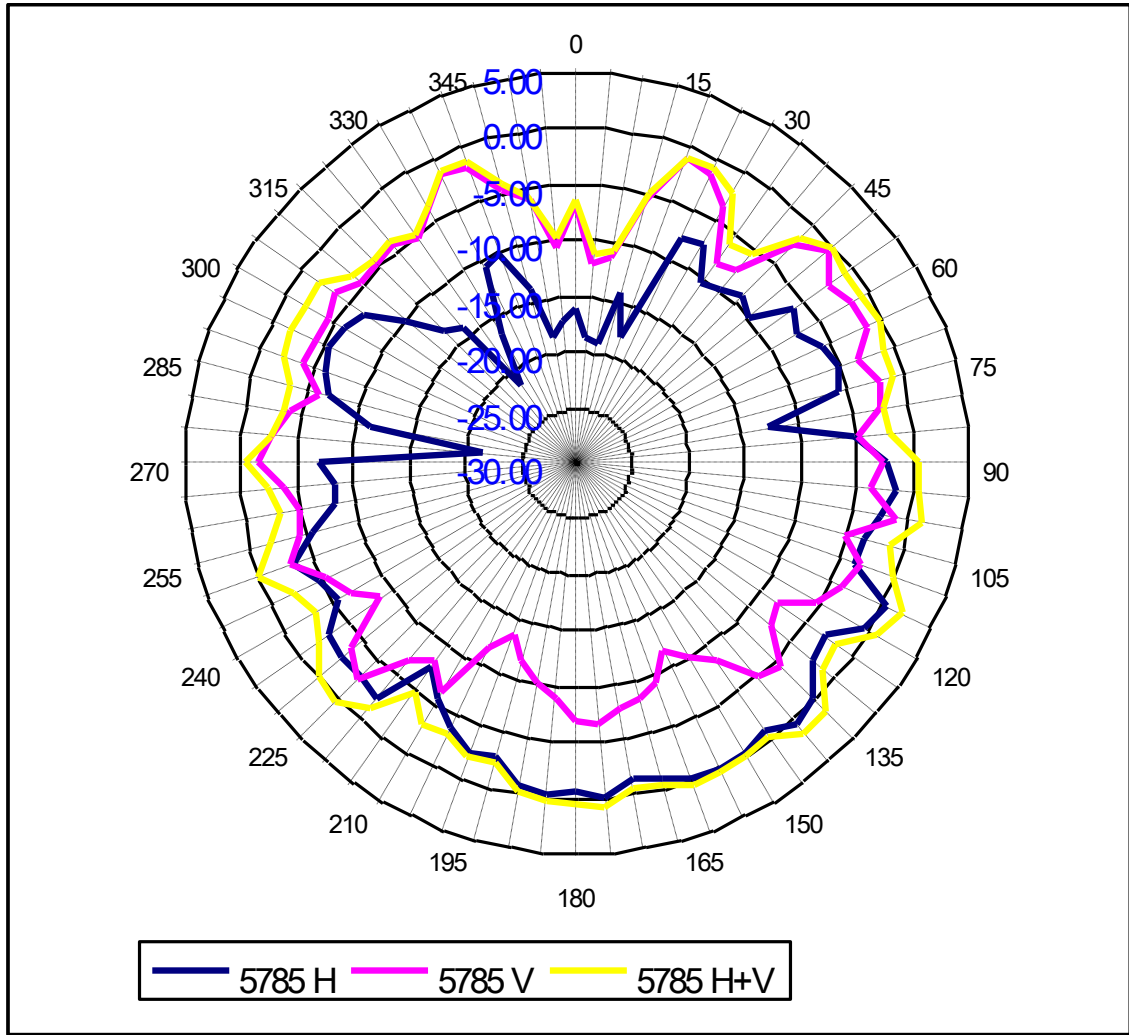

Center Frequency	5785 MHz
Horizontal (dBi) peak	0.52
Vertical (dBi) peak	-0.79

Tx1 antenna: 5850 MHz

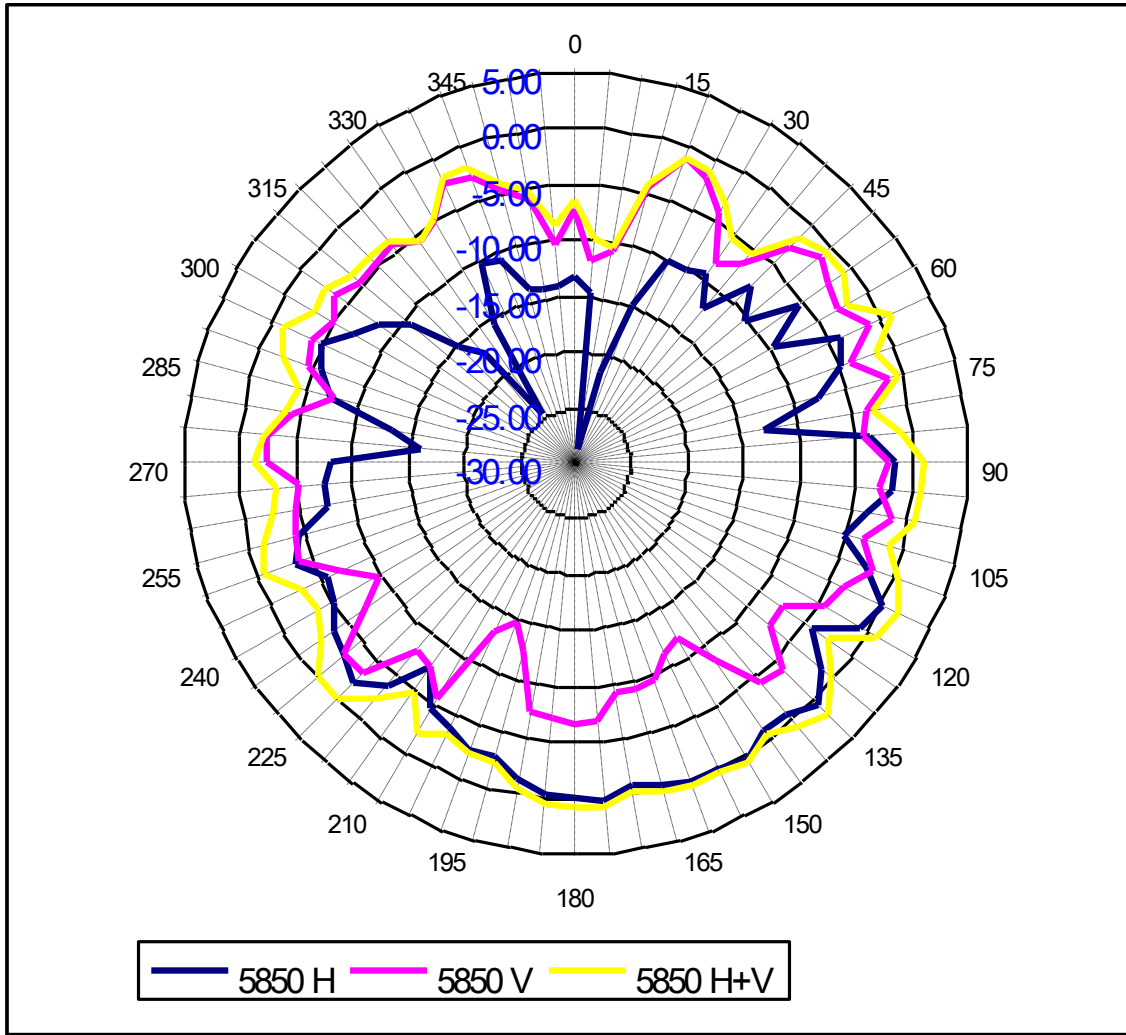

Center Frequency	5850 MHz
Horizontal (dBi) peak	0.58
Vertical (dBi) peak	-0.90

Tx2 (or Rx2) antenna: 5725 MHz (Plot is not required if 2nd Antenna is receive only e.g. Rx2 for 512 family)

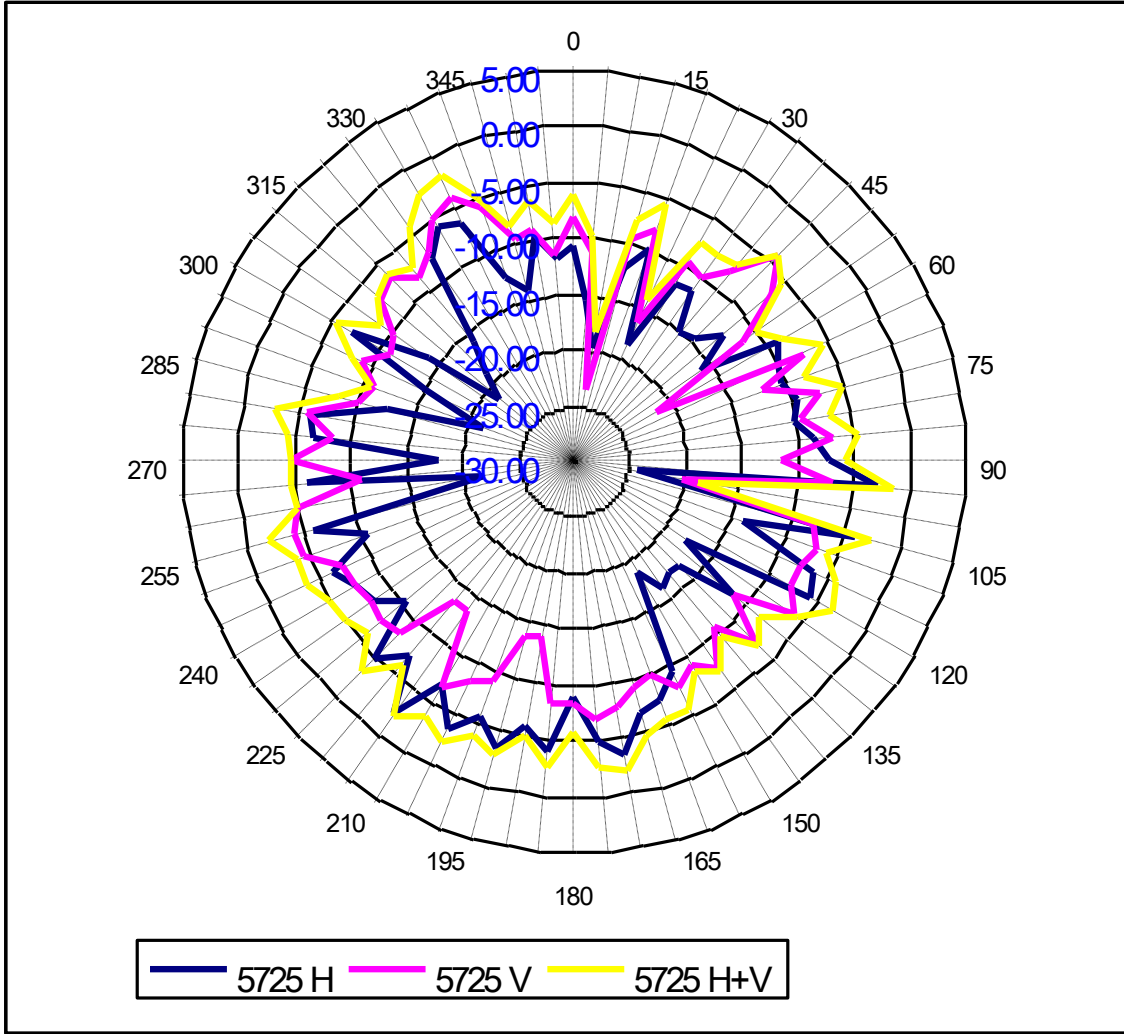

Center Frequency	5725 MHz
Horizontal (dBi) peak	-2.46
Vertical (dBi) peak	-4.01

Tx2 (or Rx2) antenna: 5785 MHz (Plot is not required if 2nd Antenna is receive only e.g. Rx2 for 512 family)

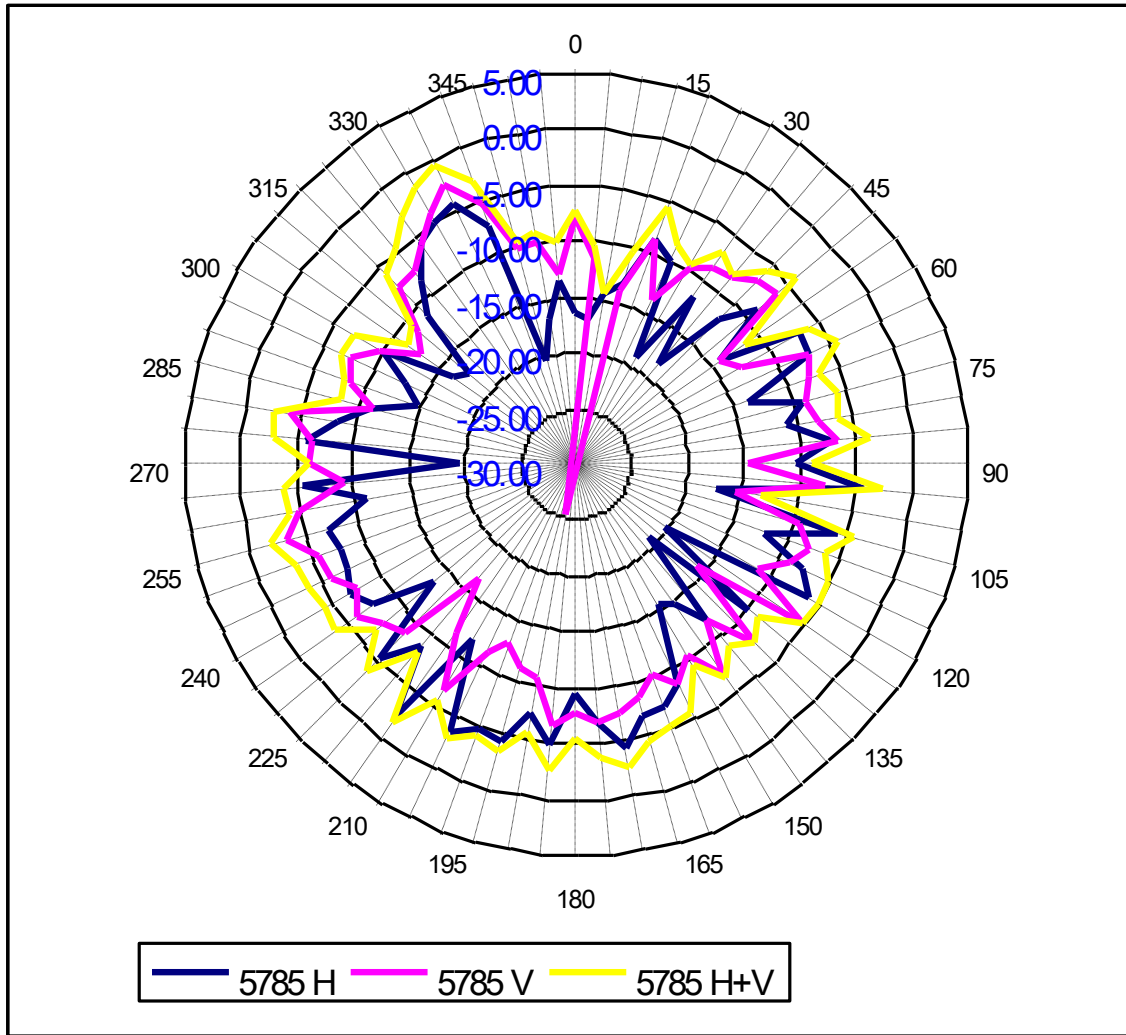

Center Frequency	5785 MHz
Horizontal (dBi) peak	-2.45
Vertical (dBi) peak	-2.79

Tx2 (or Rx2) antenna: 5850 MHz (Plot is not required if 2nd Antenna is receive only e.g. Rx2 for 512 family)

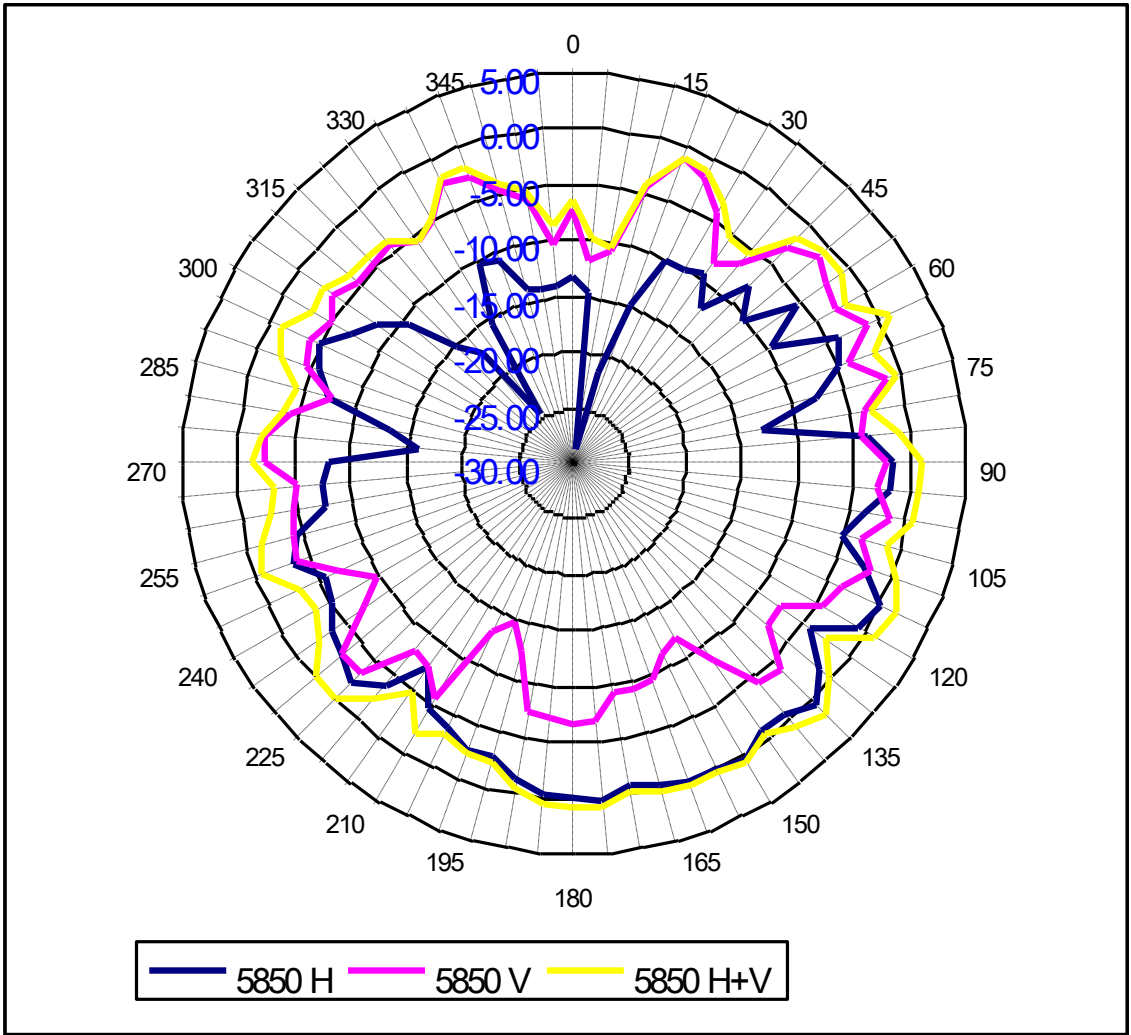

Center Frequency	5850 MHz
Horizontal (dBi) peak	-2.95
Vertical (dBi) peak	-2.06

Tx3 (or Rx3) antenna: 5725 MHz (Plot is not required if 2nd Antenna is receive only e.g. Rx3 for 512 family)

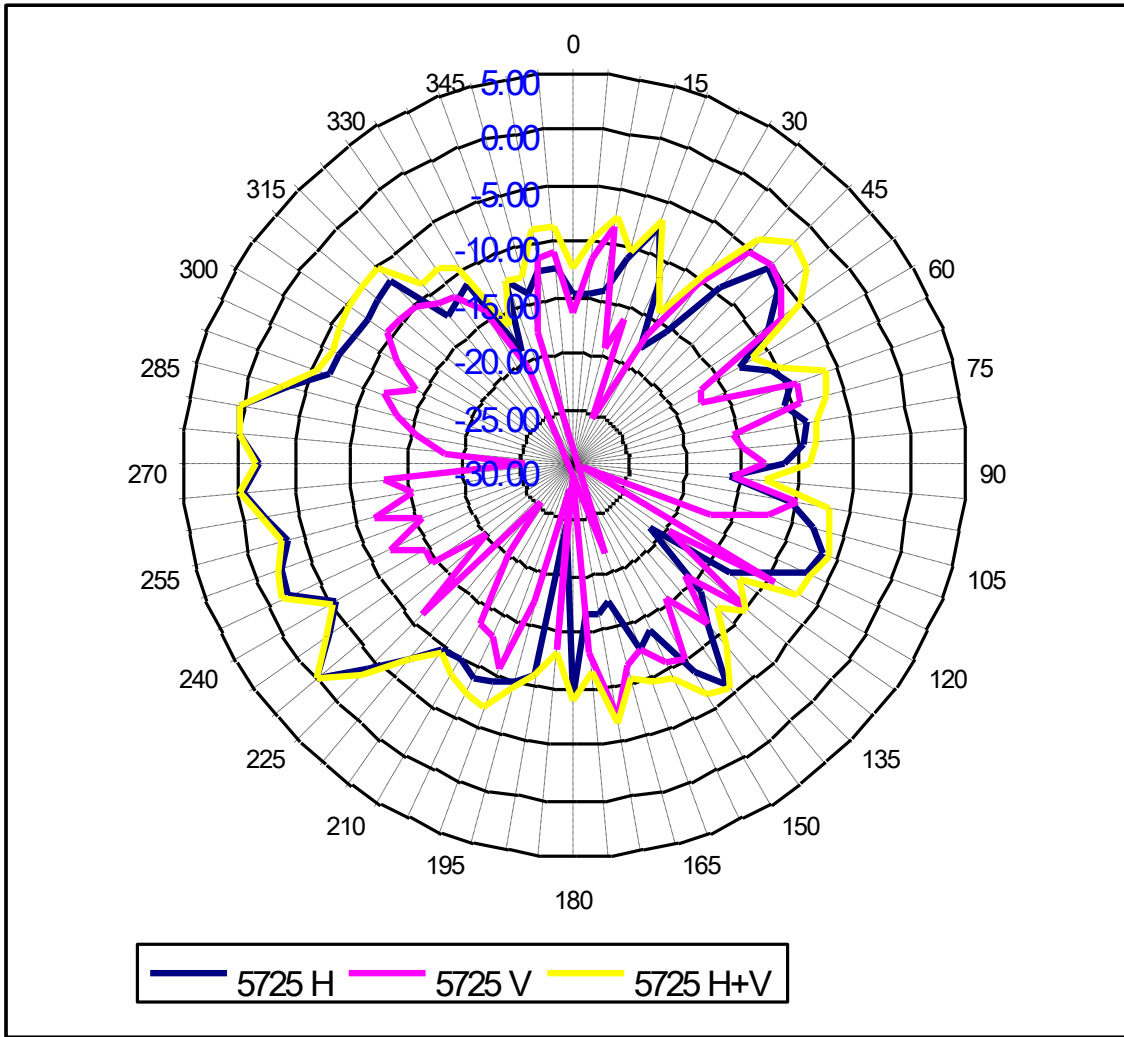

Center Frequency	5725 MHz
Horizontal (dBi) peak	0.15
Vertical (dBi) peak	-5.36

Tx3 (or Rx3) antenna: 5785 MHz (Plot is not required if 2nd Antenna is receive only e.g. Rx3 for 512 family)

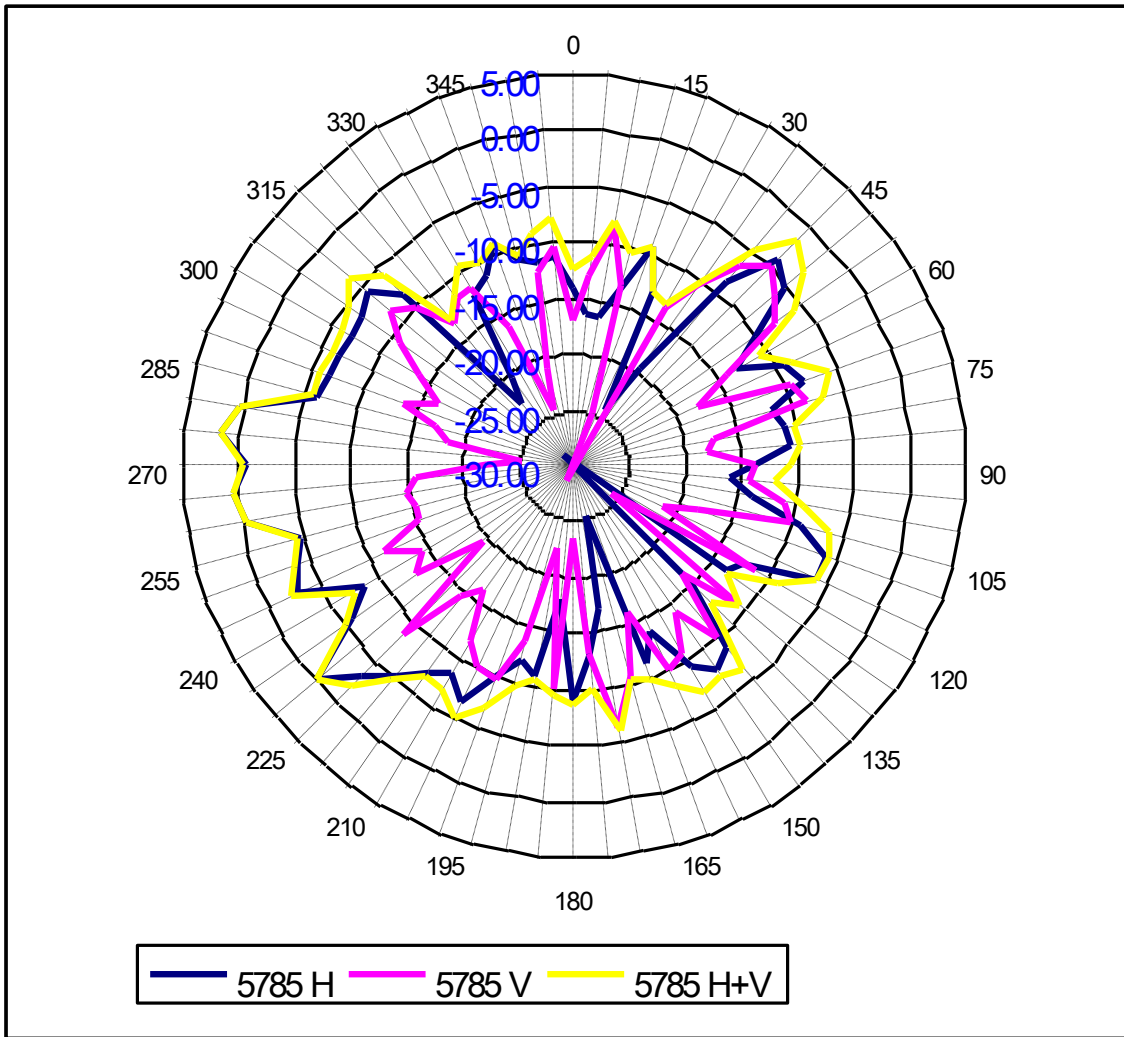

Center Frequency	5785 MHz
Horizontal (dBi) peak	1.18
Vertical (dBi) peak	-5.07

Tx3 (or Rx3) antenna: 5850 MHz (Plot is not required if 2nd Antenna is receive only e.g. Rx3 for 512 family)

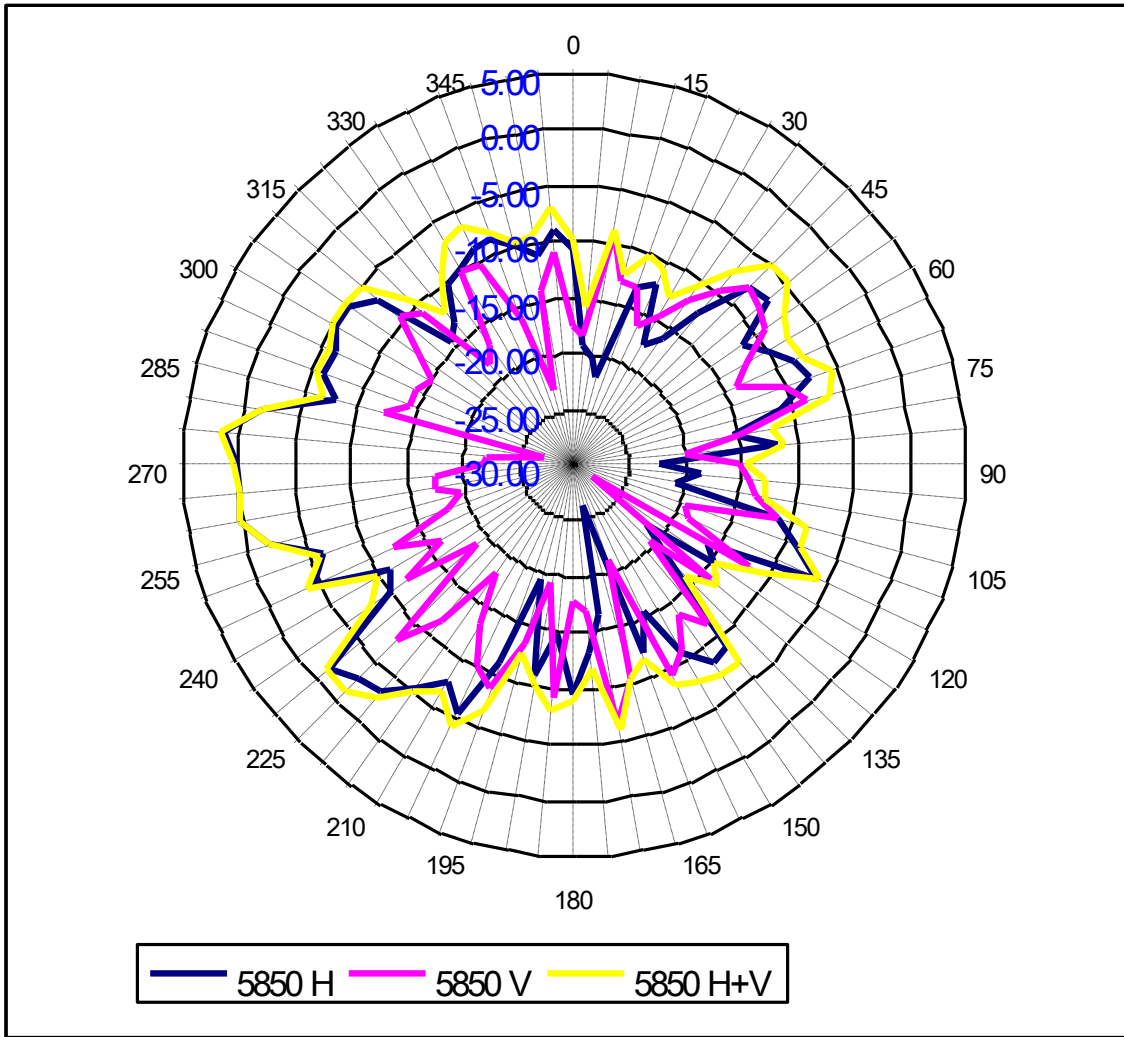

Center Frequency	5850 MHz
Horizontal (dBi) peak	1.28
Vertical (dBi) peak	-6.31

Section Section 4. Host Platform Information

OEM / ODM Host platform: (XXXXXXX) platform correlated to antenna data

Rating Label Photo:

Section 5. Antenna Host Platform Location Information

Include a **dimensioned photo or dimensioned drawing** of Tx1 and Tx2 and Tx3 antenna placements (measurements are not required for receive-only antenna). Any antenna that transmits must show dimensions to bottom of laptop.



Section 6. Antenna dimensional information for SAR evaluation

Include a **dimensioned photo** or **dimensioned drawing** showing the distance (mm) between the transmit antennas and the user (excluding hands, wrist, feet, lap/ thigh, and ankle)

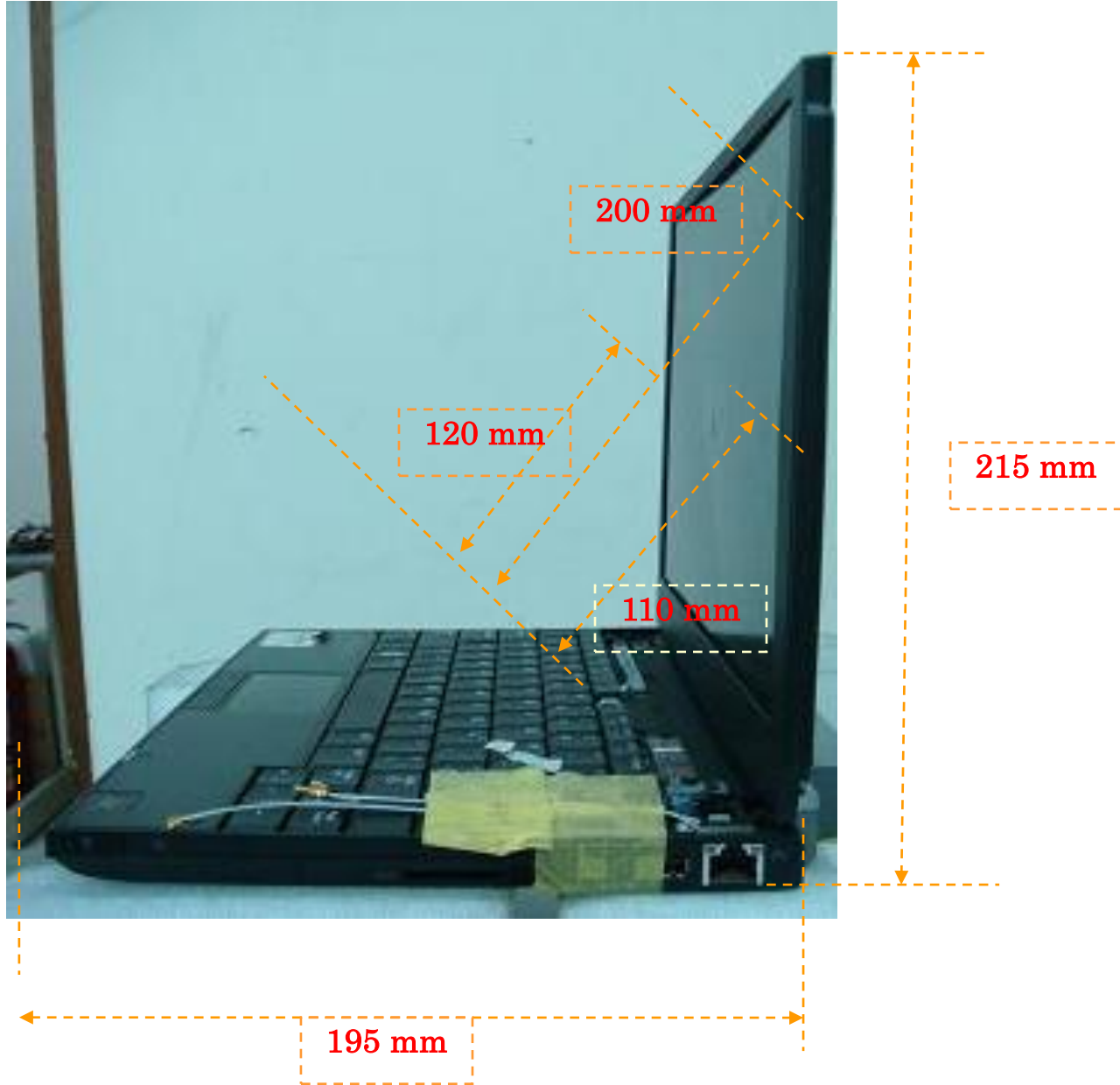

Section 7. Diagram Example of Co-Location Antenna Separation

Include a **dimensioned photo or dimensioned drawing** showing the distance (mm) between **all WLAN transmit antennas** and other co-located radiator transmit antenna such as Bluetooth, WWAN,..

(Note: Due to the evolving rules regarding co-location, each platform will need to be reviewed on a case by case basis)



Section 8. Local representative contact information

Local representative contact information is required for regulatory support for target countries below.

	Local company name	Contact name	Phone number	FAX Number	e-Mail Address	Notes
Argentina						
Brazil						
Indonesia						
Israel						
Malaysia						
Mexico						
Singapore						Telecommunication Equipment Dealer License Required
South Africa						
USA, Canada						