

Regulatory WLAN Antenna Information

Yageo WLAN Antennae exclusively for DELL AMG (PC Mode) Platform

Platform	
Platform Owner	DELL Corporation
Brand Name	DELL
Model Name	AMG Non_bump (PC Mode)
ODM	Wistron Corporation
Target Launch Date	2008/ 09/ 19
Antenna	
Brand Name	Yageo
Part Number	<input checked="" type="checkbox"/> WLAN_Main Antenna: CAN4313802022501B
	<input checked="" type="checkbox"/> WLAN_Aux Antenna: CAN4313802022501B
	<input checked="" type="checkbox"/> MIMO Antenna : CAN4313802012501B
Module	
With WLAN Module	<input checked="" type="checkbox"/> Intel 5100
(Check Box)	<input checked="" type="checkbox"/> Intel 5300
	<input type="checkbox"/> WM3B2200BG
	<input type="checkbox"/> WM3B2915ABG
	<input type="checkbox"/> WM3945ABG
	<input type="checkbox"/> 4965AGN
	<input type="checkbox"/> 4965AG_
	<input type="checkbox"/> 533ANX Family
	<input type="checkbox"/> 512ANX Family
	<input type="checkbox"/> 533AN Family
	<input type="checkbox"/> 512AN Family

Antenna Sample / Antenna Data Requirements for worldwide regulatory approval

Section	Description of Required OEM / ODM Antenna Information	US / IC	EU	Japan	Taiwan	S.Korea
1A	Part Number for Antenna only	Required	Required	Required	Required	Required
1B	Antenna Manufacturer Name	Required	Required	Required	Required	Required
1C	Description of Antenna Type	Required	N/A	N/A	N/A	N/A
1D	Part number of Antenna Assembly / cable impedance, length & diameter.	Required	Desired	Desired	Desired	Desired
1E	WLAN_Main Antenna, WLAN_Aux Antenna & MIMO Antenna antenna (Peak Gain W/ cable loss) *	Required	Required	Required	Required	Required
	1E OR 1F, 1G, 1H					
1F	WLAN_Main Antenna, WLAN_Aux Antenna & MIMO Antenna antenna (Peak Gain only) *	Required	Required	Required	Required	Required
1G	VSWR of cable including connector	Required	Required	Required	Required	Required
1H	WLAN_Main Antenna, WLAN_Aux Antenna & MIMO Antenna antenna (Cable loss W/ connector) *	Required	Required	Required	Required	Required
2	Dimensioned Photographs and Drawings of WLAN_Main Antenna, WLAN_Aux Antenna, and MIMO Antenna (or Rx3) antennas	Required	Required	Required	Required	Required
3	Radiation patterns of antennas loaded in the host platform.	Required	Desired	Required	N/A	Required
4	Platform model name / number - correlated to antenna manufacturer and antenna part number	Required	Required	Desired	Required	Desired
5	Photograph(s) or Drawings showing location of antennas in platform. (S. Korea requires photographs of antennas for approval submission). Taiwan requires pictures of each antenna type shown in the system.	Required	Required	Desired	Required (Photos)	Required (Photos)
6	Mech. drawings / photos with dimensions of antenna locations and distance from end-user (For evaluation of SAR testing requirement).	Required	N/A	N/A	N/A	N/A
7	Photograph(s) or Drawings showing the location of all antennas (WLAN, other) and distance between those transmitting antennas. Information will be used to evaluate whether co-location testing is required.	Required	N/A	N/A	N/A	N/A
8	Local representative contact information for LMA/ PARS process.	Required	N/A	N/A	N/A	N/A

NOTE:

(*) if 3rd antenna is Rx only (e.g. receive only for 4965AGN) then peak gain and cable loss not required

Antenna Information

Section 1. Antenna Assembly Specifications

Antenna Assembly Summary:

1A Antenna Part Number	1B Manufacturer	1C Antenna Type	1D Cable Assembly Part Number and Information	1E Peak Gain W/ Cable Loss (dBi)	1F Peak Gain w/o Cable Loss (dBi)	1G VSWR	1H Cable Loss (dBi)
CAN4313802022501B WLAN_Main antenna	YAGEO	PIFA	50 ohm Coaxial length: 45 cm diameter: 1.13 mm Connector: Hirose U.FL-LP IPEX MHF or equivalent	2400-2500MHz	2400-2500MHz	2400-2500MHz	2400-2500MHz
				-0.40 dBi (peak)	0.73 dBi (peak)	3.00 max	1.13 dBi (peak)
				2496-2690MHz	2496-2690MHz	2496-2690MHz	2496-2690MHz
				-0.98 dBi (peak)	0.18 dBi (peak)	3.00 max	1.16 dBi (peak)
				5150-5350MHz	5150-5350MHz	5150-5350MHz	5150-5350MHz
				-2.88 dBi (peak)	-1.12 dBi (peak)	3.00 max	1.76 dBi (peak)
CAN4313802022501B WLAN_Aux antenna	YAGEO Corporation	PIFA	50 ohm Coaxial length: 45.6 cm diameter: 1.13 mm Connector: Hirose U.FL-LP IPEX MHF or equivalent	2400-2500MHz	2400-2500MHz	2400-2500MHz	2400-2500MHz
				-0.65 dBi (peak)	0.49 dBi (peak)	3.00 max	1.14 dBi (peak)
				2496-2690MHz	2496-2690MHz	2496-2690MHz	2496-2690MHz
				-0.94 dBi (peak)	0.23 dBi (peak)	3.00 max	1.17 dBi (peak)
				5150-5350MHz	5150-5350MHz	5150-5350MHz	5150-5350MHz
				1.63 dBi (peak)	3.42 dBi (peak)	3.00 max	1.79 dBi (peak)
CAN4313802012501B MIMO antenna	YAGEO Corporation	PIFA	50 ohm Coaxial length: 46.3 cm diameter: 1.13 mm Connector: Hirose U.FL-LP IPEX MHF or equivalent	2400-2500MHz	2400-2500MHz	2400-2500MHz	2400-2500MHz
				0.55 dBi (Peak)	1.71 dBi (peak)	3.00 max	1.16 dBi (peak)
				2496-2690MHz	2496-2690MHz	2496-2690MHz	2496-2690MHz
				-0.15 dBi (Peak)	1.04 dBi (peak)	3.00 max	1.19 dBi (peak)
				5150-5350MHz	5150-5350MHz	5150-5350MHz	5150-5350MHz
				0.03 dBi (Peak)	1.84 dBi (peak)	3.00 max	1.81 dBi (peak)
				5470-5725MHz	5470-5725MHz	5470-5725MHz	5470-5725MHz
				-0.37 dBi (Peak)	1.53 dBi (peak)	3.00 max	1.90 dBi (peak)
				5725-5850MHz	5725-5850MHz	5725-5850MHz	5725-5850MHz
				-0.31 dBi (peak)	1.63 dBi (peak)	3.00 max	1.94 dBi (peak)

NOTE:

(*) If Rx3 only (3rd antenna receives only, e.g. for 4965AGN) then the information marked with * is not required

Antenna Peak Gain Table:

Frequency (MHz)	WLAN_Main Antenna		WLAN_Aux Antenna		MIMO Antenna	
	Horizontal (dBi)	Vertical (dBi)	Horizontal (dBi)	Vertical (dBi)	Horizontal (dBi)	Vertical (dBi)
2400	-1.72	-0.95	-2.10	-0.65	-0.13	0.55
2450	-2.18	-1.87	-1.46	-1.73	-1.09	0.27
2500	-0.48	-0.40	-2.19	-4.70	-1.01	-1.58
2501	-1.43	-1.39	-2.32	-4.70	-1.04	-1.55
2593	-3.05	-1.35	-0.94	-2.84	-1.10	-0.36
2685	-3.21	-0.98	-1.94	-1.93	-2.48	-0.15
5150	-3.25	-4.56	-3.48	0.90	-2.43	-0.36
5250	-2.88	-2.92	-2.50	1.16	-1.80	0.03
5350	-4.01	-3.63	-2.80	1.63	-2.91	-0.45
5470	-4.29	-2.46	-2.15	0.79	-2.88	-1.97
5600	-3.81	-2.87	-1.51	0.19	-2.45	-1.40
5725	-3.14	-2.91	-2.53	-0.51	-1.58	-0.37
5785	-2.23	-2.83	-1.82	1.08	-0.65	-0.31
5850	-3.65	-2.66	-2.85	-0.69	-1.04	-0.63

- Antenna Peak Gain required being test in system basis.
- 1E frame contend absolutely peak antenna gain include H/V
- If Rx3 only (3rd antenna receives only, e.g. for 4965AGN) then the information is not required for Rx3.

Section 2. Dimensioned Photos or Drawings of Antennas

Include a dimensioned photo and dimensioned drawing of WLAN_Main Antenna antenna here.

WLAN Main Antenna Antenna Dimensioned Drawing:

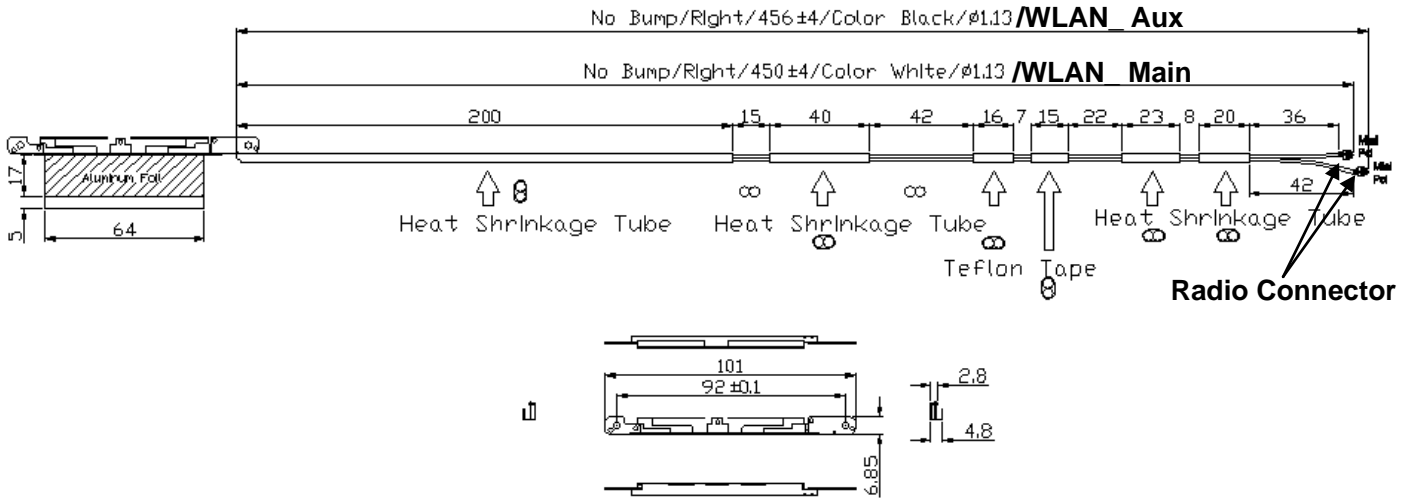

WLAN Main Antenna Photo:

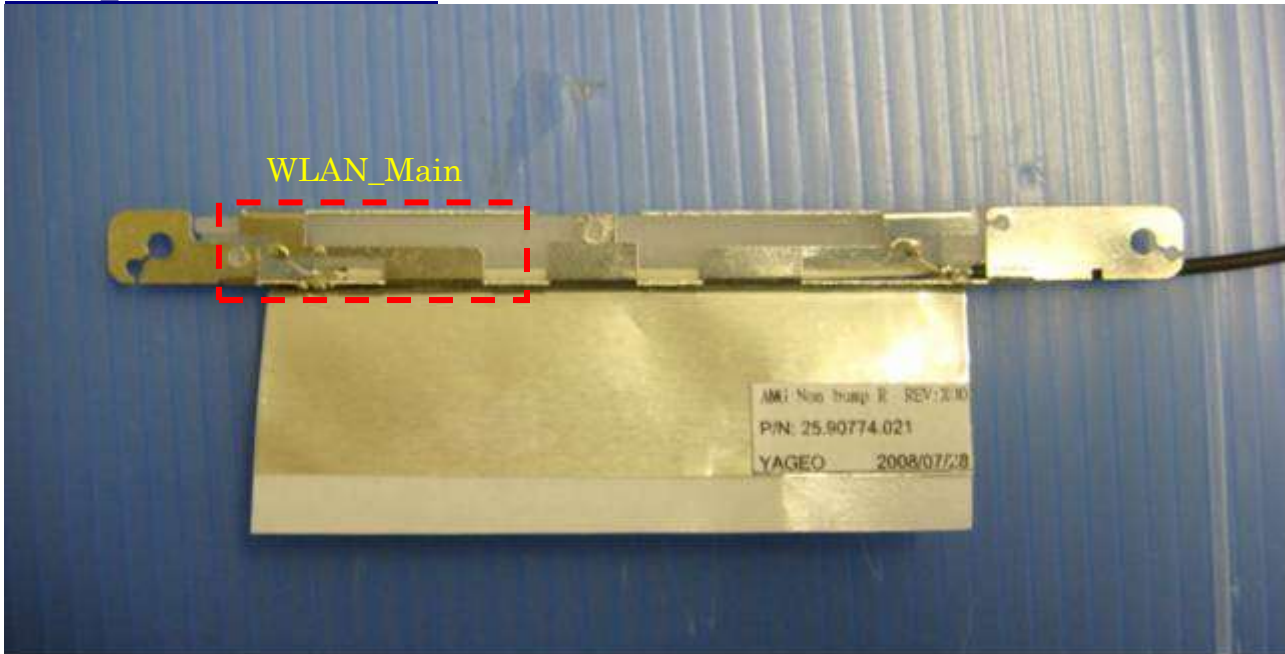

Include a dimensioned photo and dimensioned drawing of WLAN_Aux Antenna antenna here.

WLAN Aux Antenna Dimensioned Drawing:

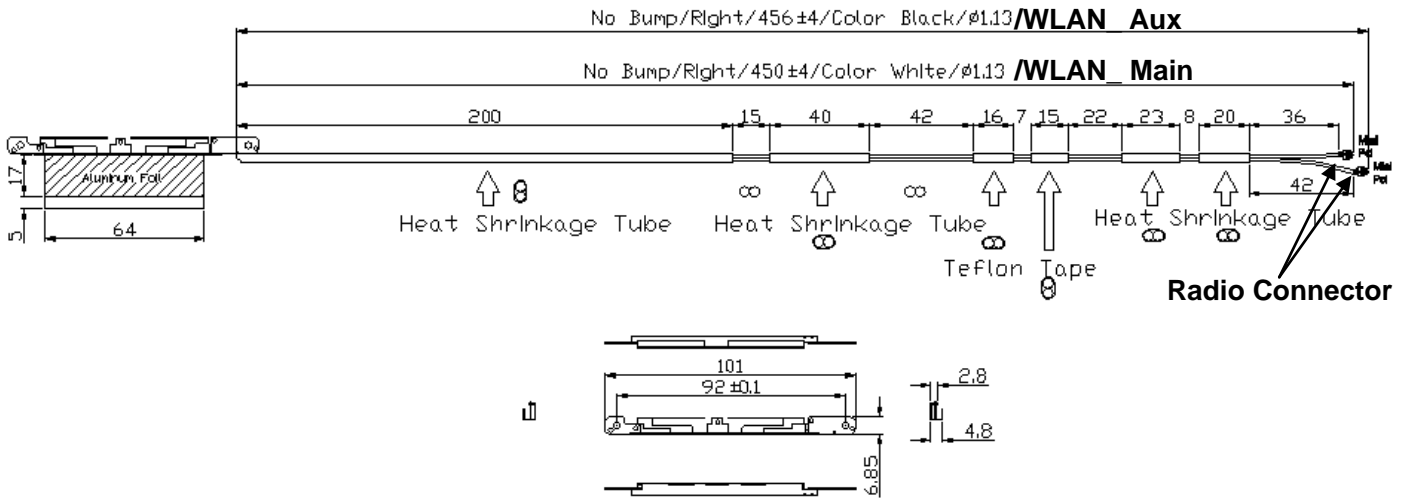

WLAN Aux Antenna Photo:

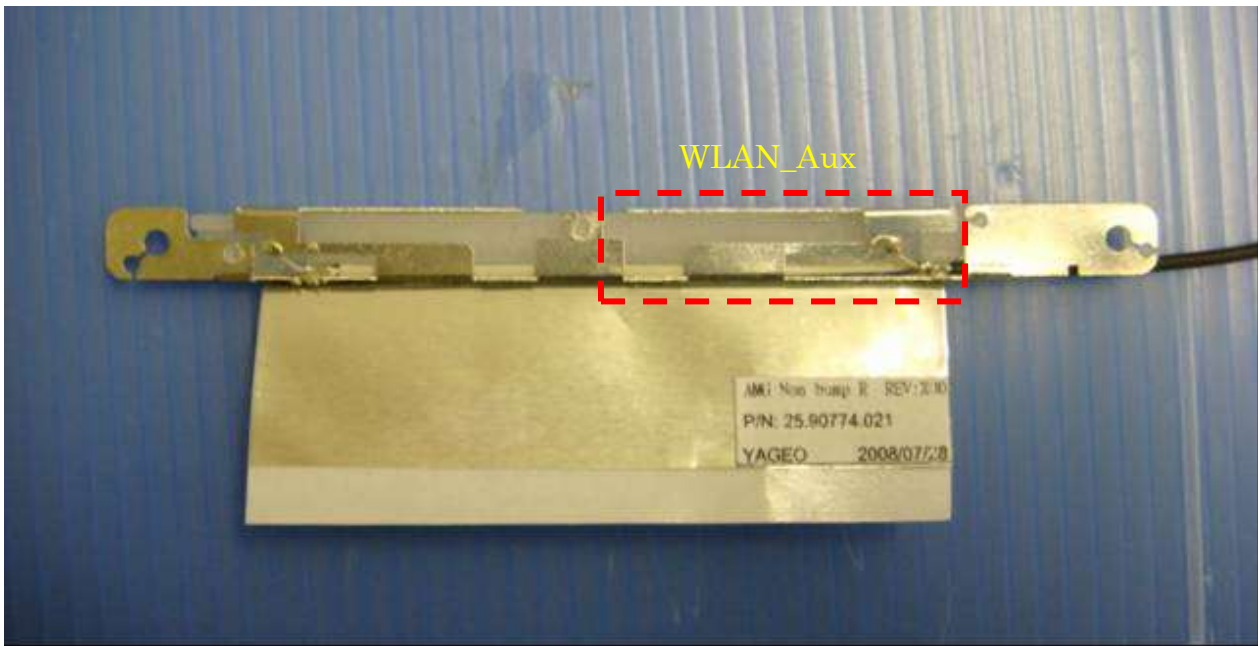

Include a dimensioned photo and dimensioned drawing of MIMO Antenna (or Rx3) antenna here.

MIMO Antenna Dimensioned Drawing:

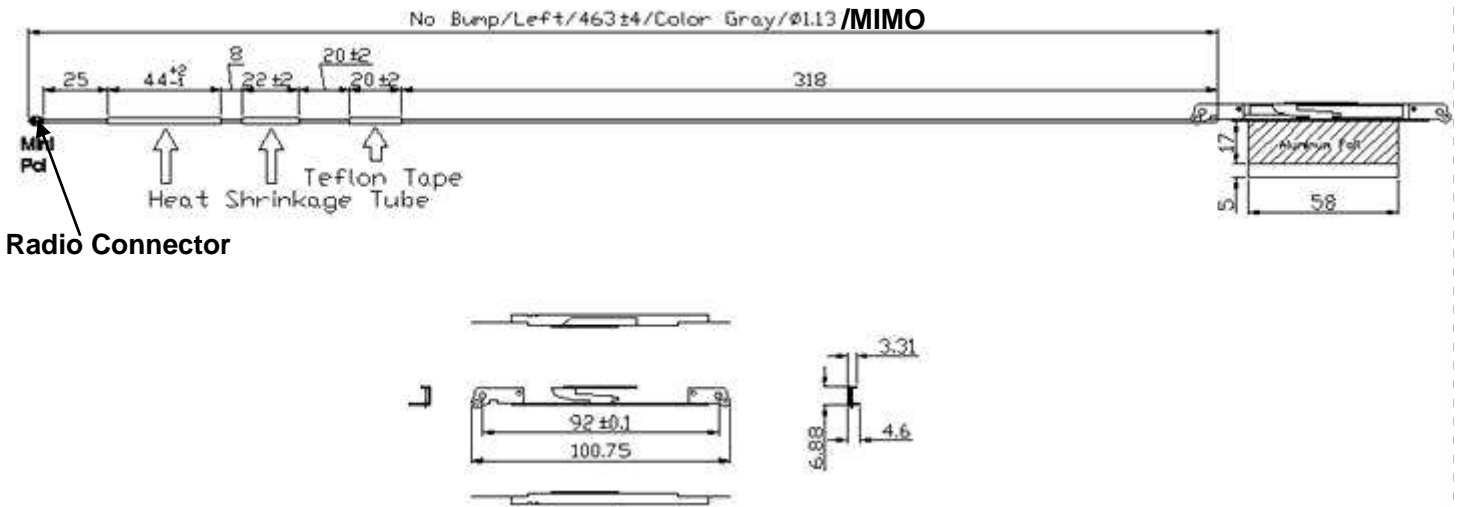

MIMO Antenna Photo:



Include front view photo of all 3 antennas here.

Antenna Manufacturer: Yageo Corporation
Antenna Part Number: CAN4313802022501B (WLAN_Main),
CAN4313802022501B (WLAN_Aux),
CAN4313802012501B (MIMO)



Include back view photo of all 3 antennas here.

Antenna Manufacturer: Yageo Corporation
Antenna Part Number: CAN4313802022501B (WLAN_Main),
CAN4313802022501B (WLAN_Aux),
CAN4313802012501B (MIMO)



Section 3. Radiation characteristics of antennae Loaded in Host Platform

2400-2500MHz radiation characteristic

WLAN_Main Antenna antenna: 2400 MHz

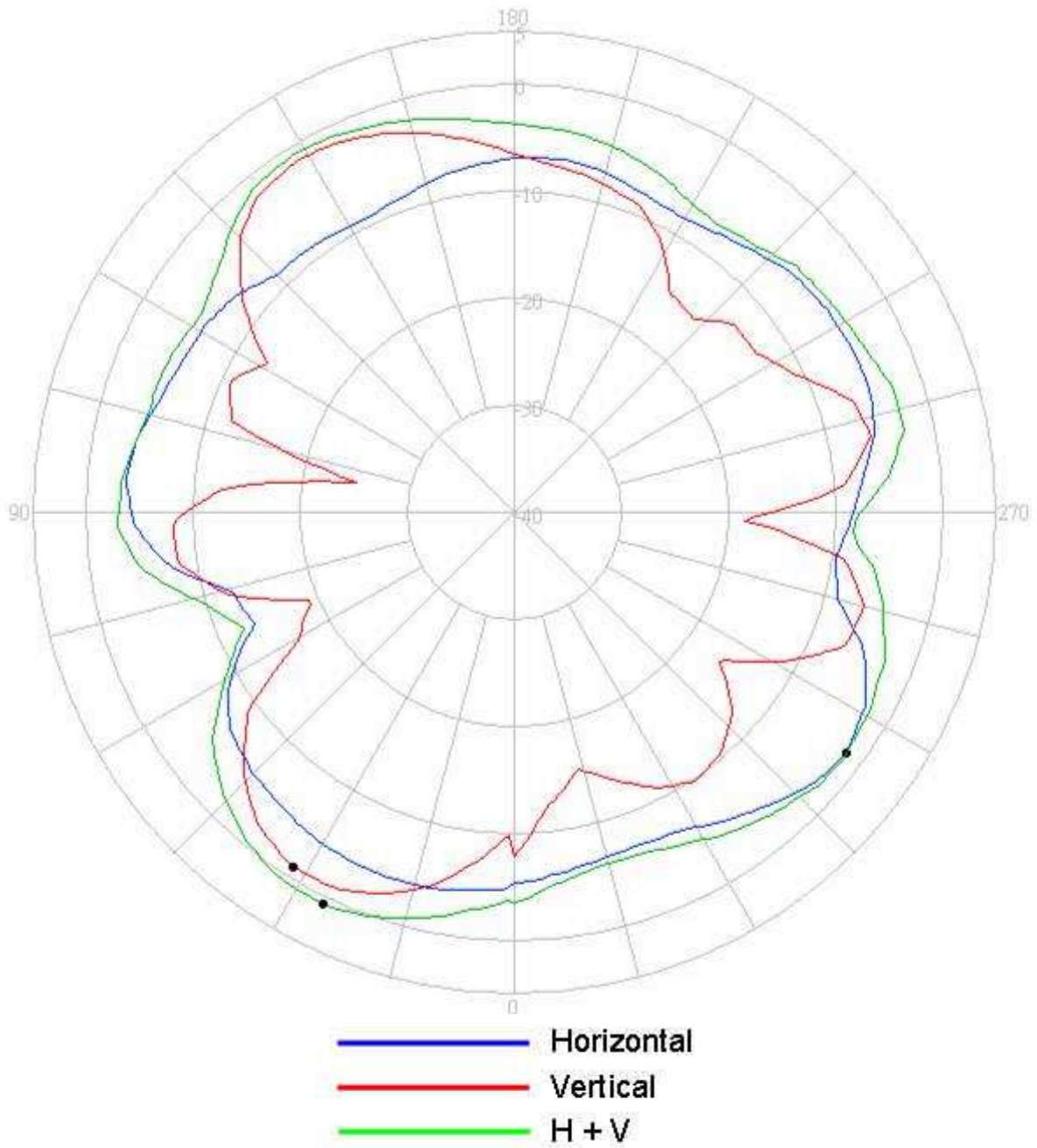

Center Frequency	2400 MHz
Horizontal (dBi) Peak	-1.72
Vertical (dBi) Peak	-0.95

WLAN_Main Antenna antenna: 2450 MHz

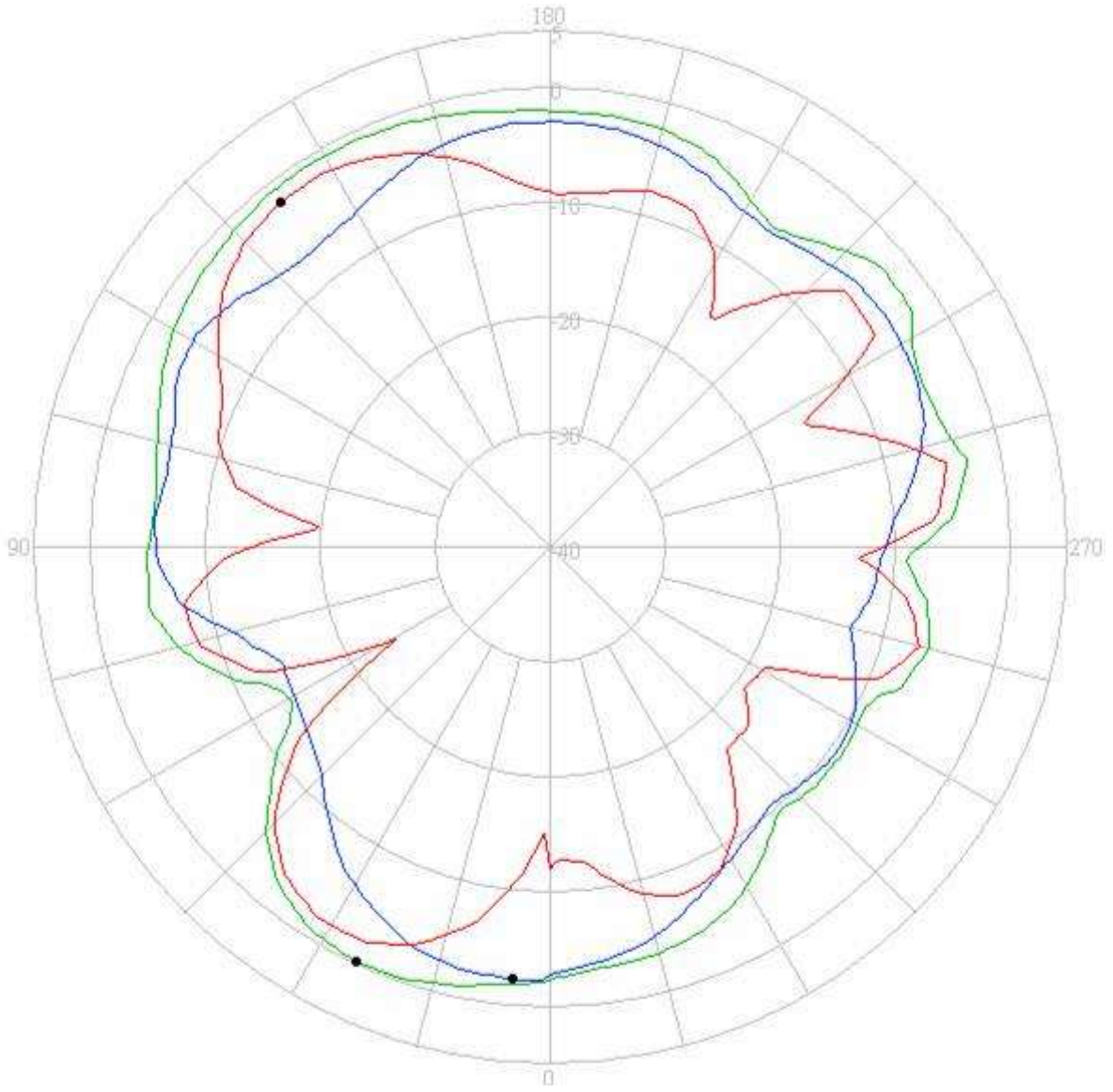

- Horizontal
- Vertical
- H + V

Center Frequency	2450 MHz
Horizontal (dBi) Peak	-2.18
Vertical (dBi) Peak	-1.87

WLAN_Main Antenna antenna: 2500 MHz

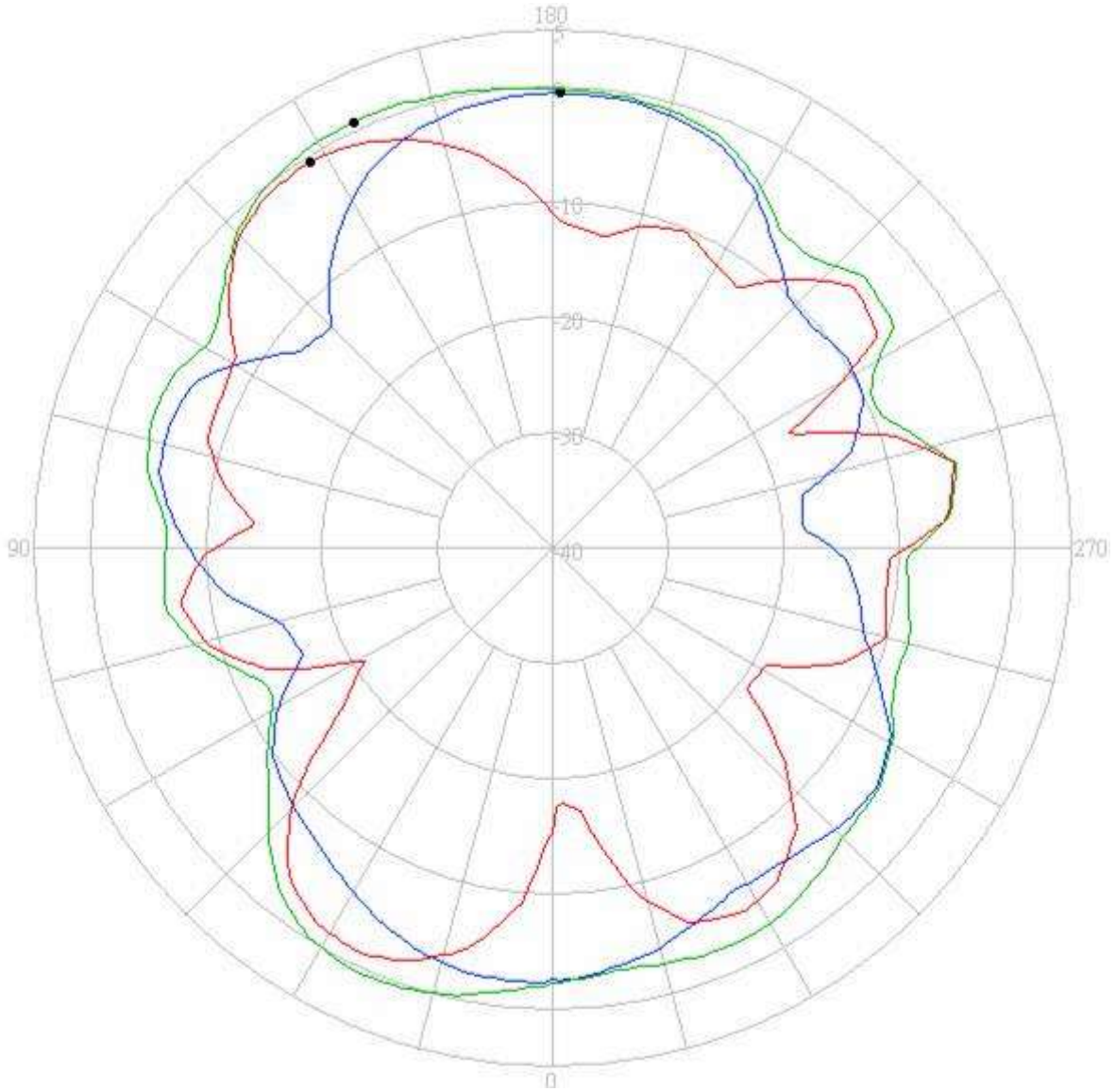

- Horizontal
- Vertical
- H + V

Center Frequency	2500 MHz
Horizontal (dBi) Peak	-0.48
Vertical (dBi) Peak	-0.40

WLAN_Aux Antenna antenna: 2400 MHz

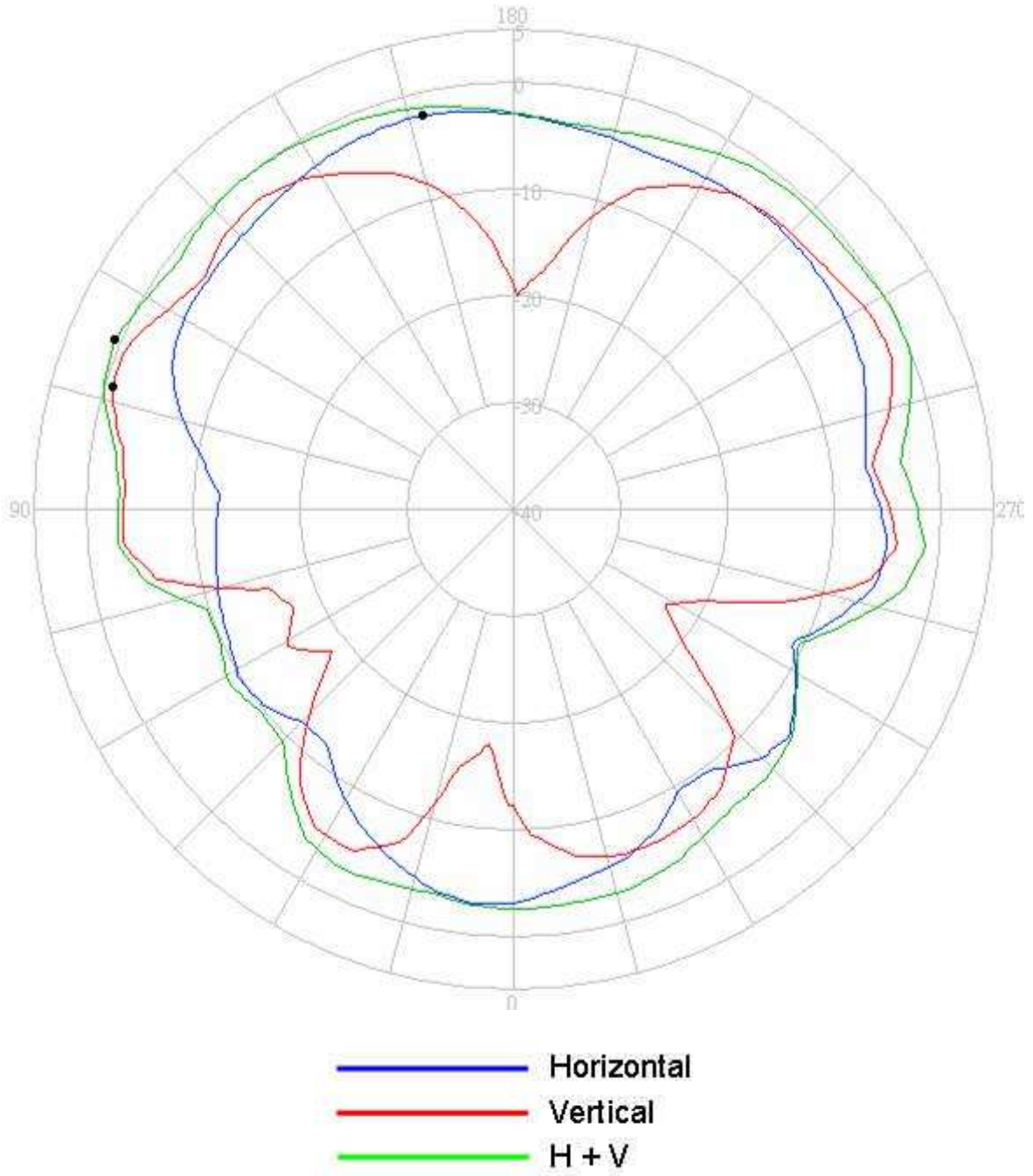

Center Frequency	2400 MHz
Horizontal (dBi) Peak	-2.10
Vertical (dBi) Peak	-0.65

WLAN_Aux Antenna antenna: 2450 MHz

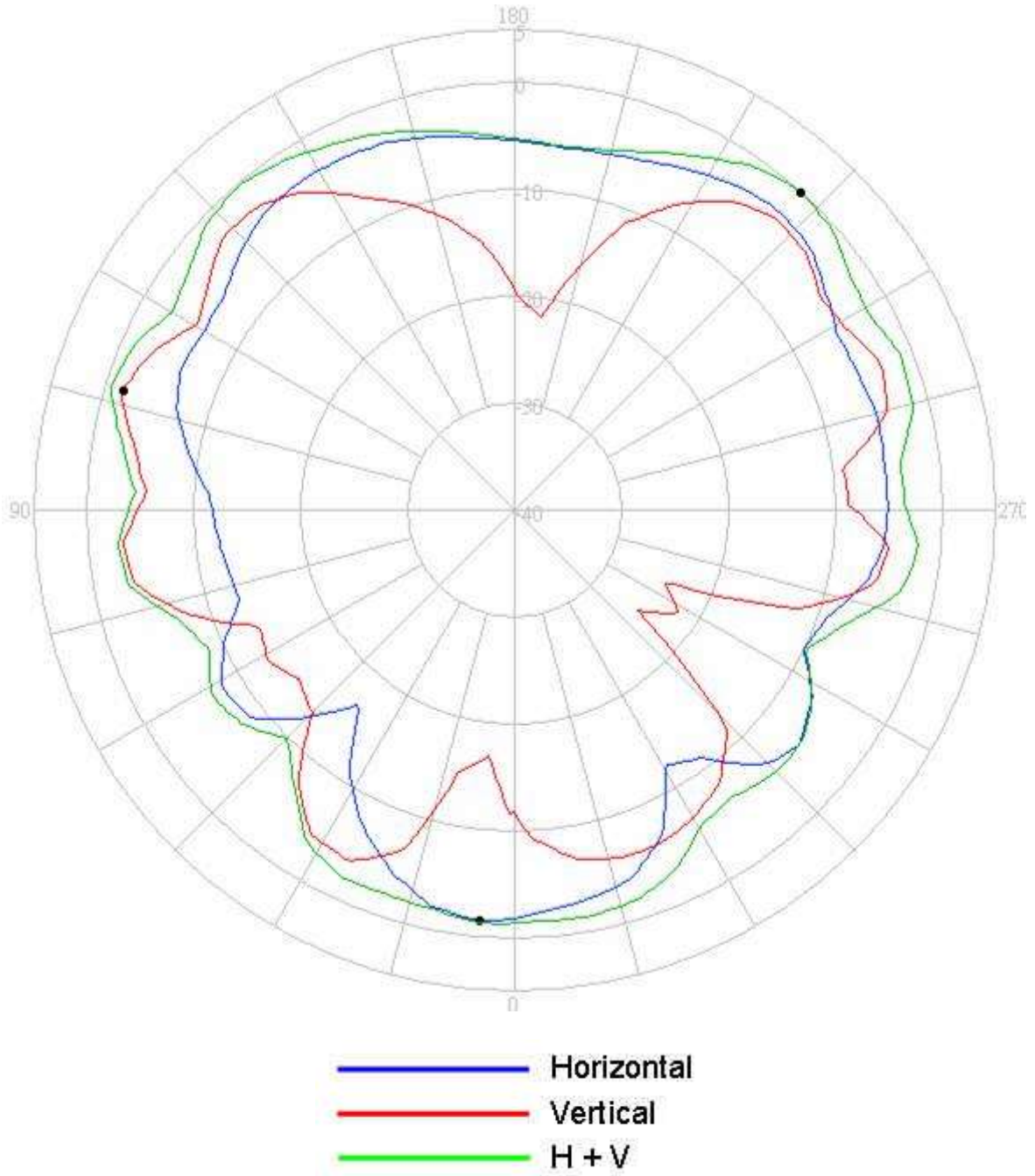

Center Frequency	2450 MHz
Horizontal (dBi) Peak	-1.46
Vertical (dBi) Peak	-1.73

WLAN_Aux Antenna antenna: 2500 MHz

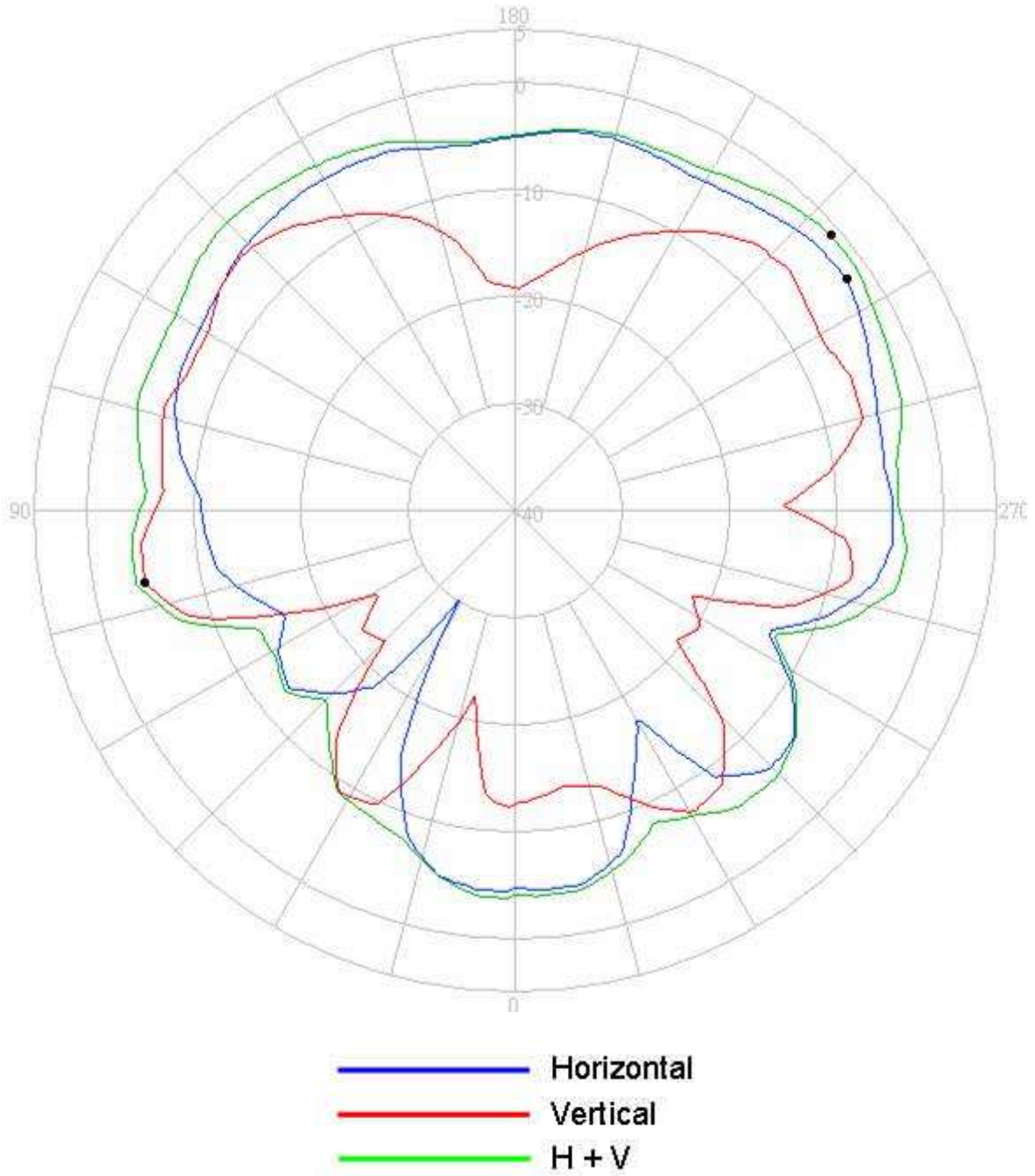

Center Frequency	2500 MHz
Horizontal (dBi) Peak	-2.19
Vertical (dBi) Peak	-4.70

MIMO Antenna antenna: 2400 MHz

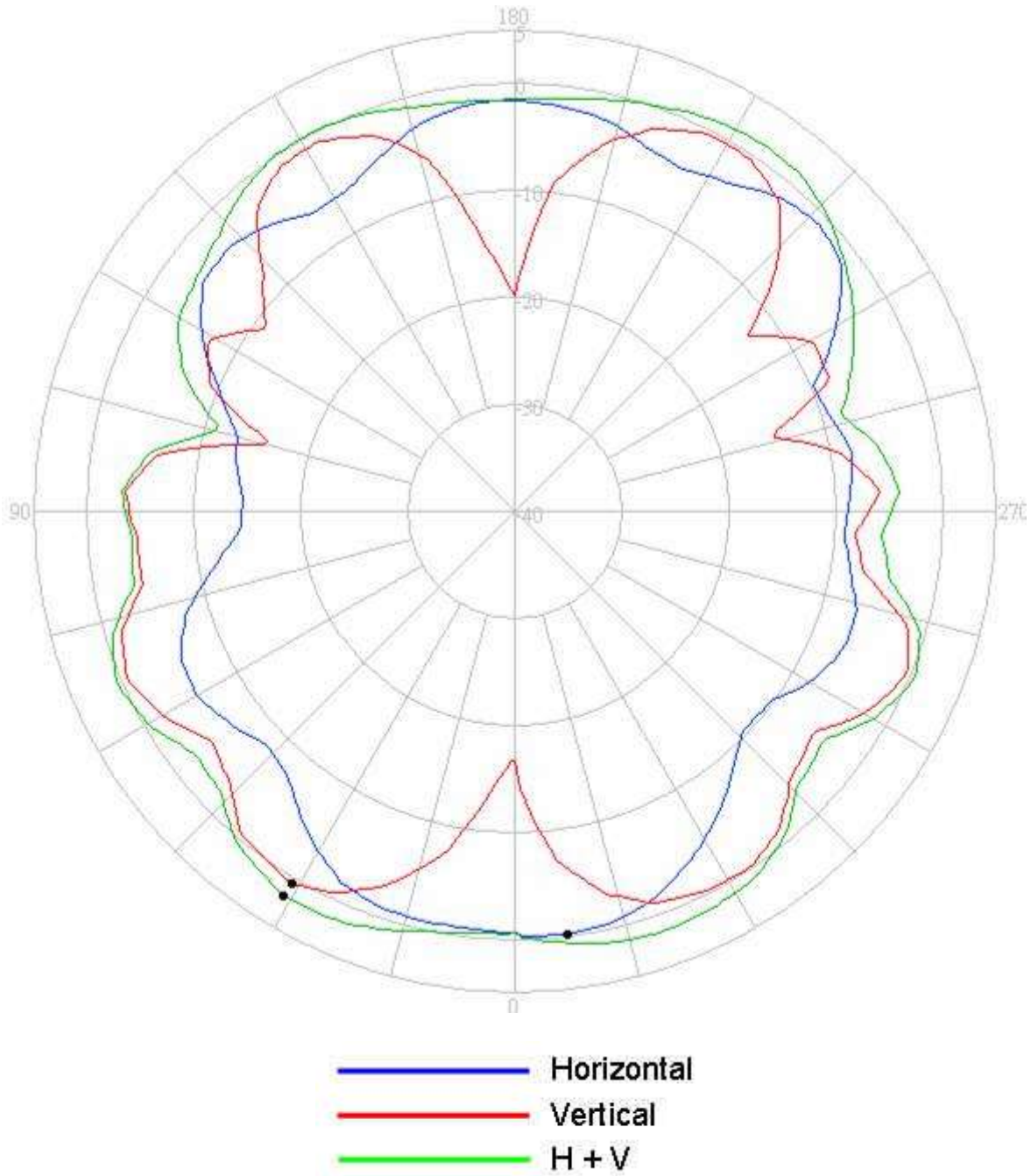

Center Frequency	2400 MHz
Horizontal (dBi) Peak	-0.13
Vertical (dBi) Peak	0.55

MIMO Antenna antenna: 2450 MHz

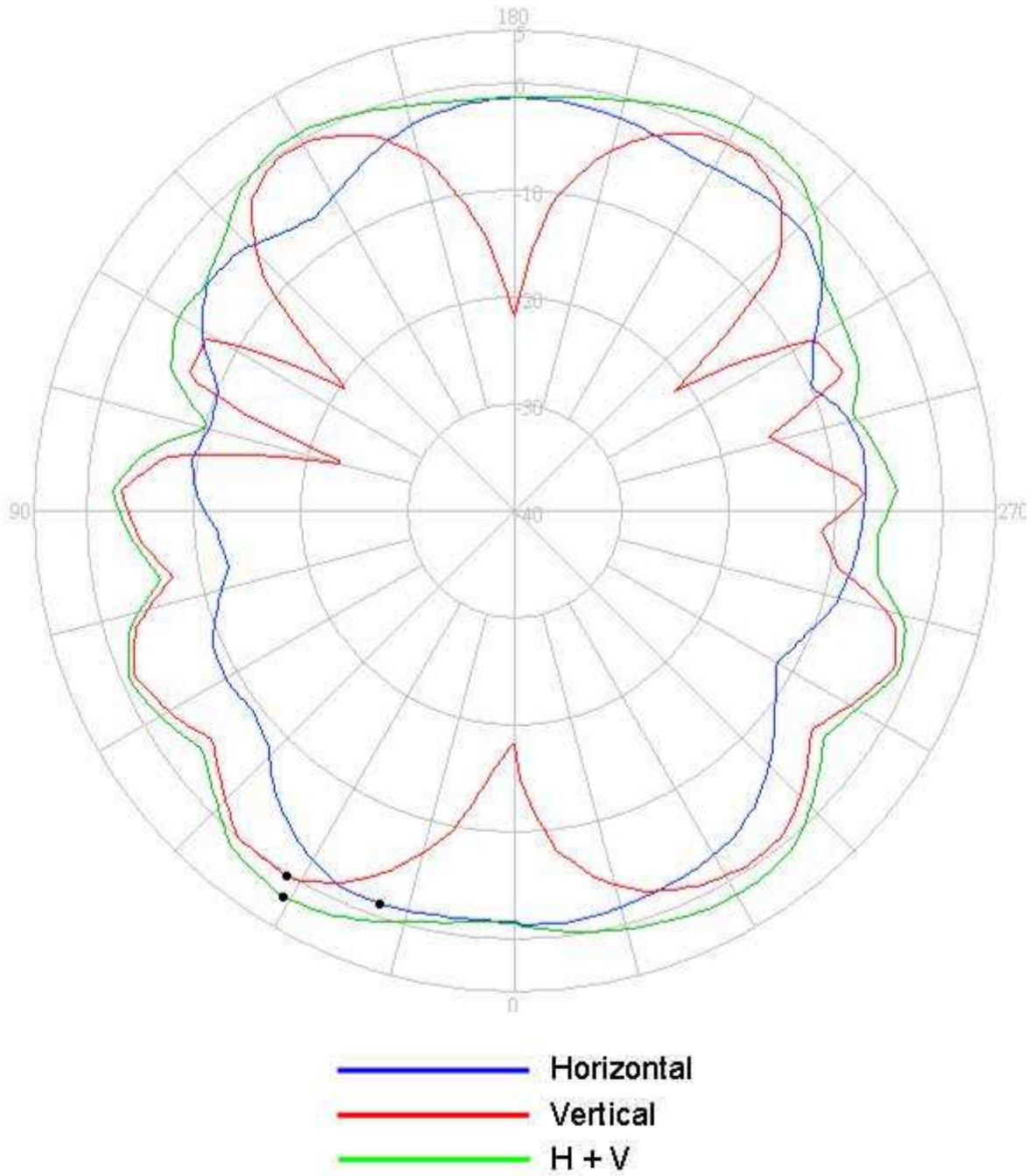

Center Frequency	2450 MHz
Horizontal (dBi) Peak	-1.09
Vertical (dBi) Peak	0.27

MIMO Antenna antenna: 2500 MHz

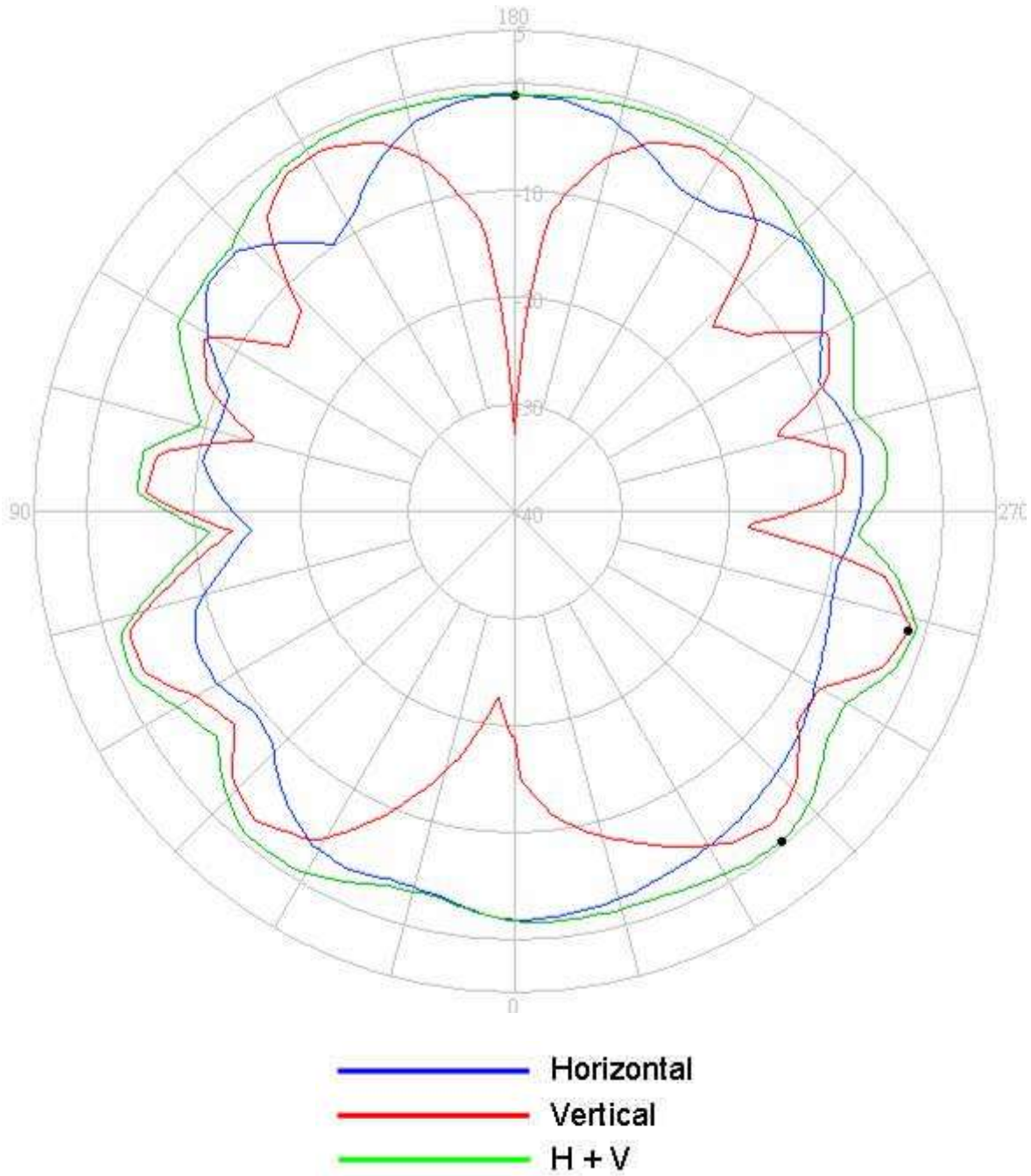

Center Frequency	2500 MHz
Horizontal (dBi) Peak	-1.01
Vertical (dBi) Peak	-1.58

2490-2700MHz radiation characteristic

WLAN_Main Antenna antenna: 2501MHz

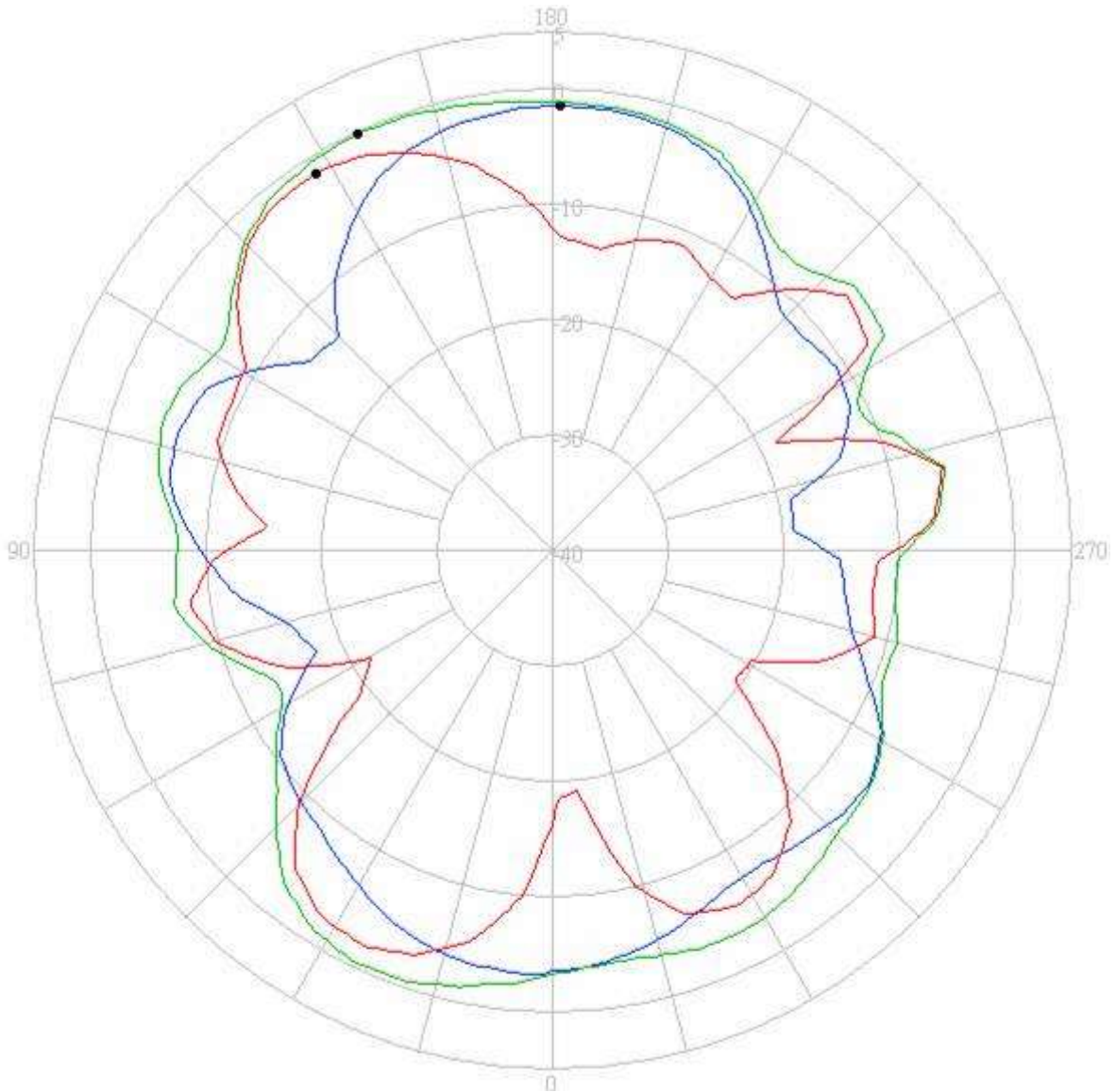

- Horizontal
- Vertical
- H + V

Center Frequency	2501 MHz
Horizontal (dBi) Peak	-1.43
Vertical (dBi) Peak	-1.39

WLAN_Main Antenna antenna: 2593MHz

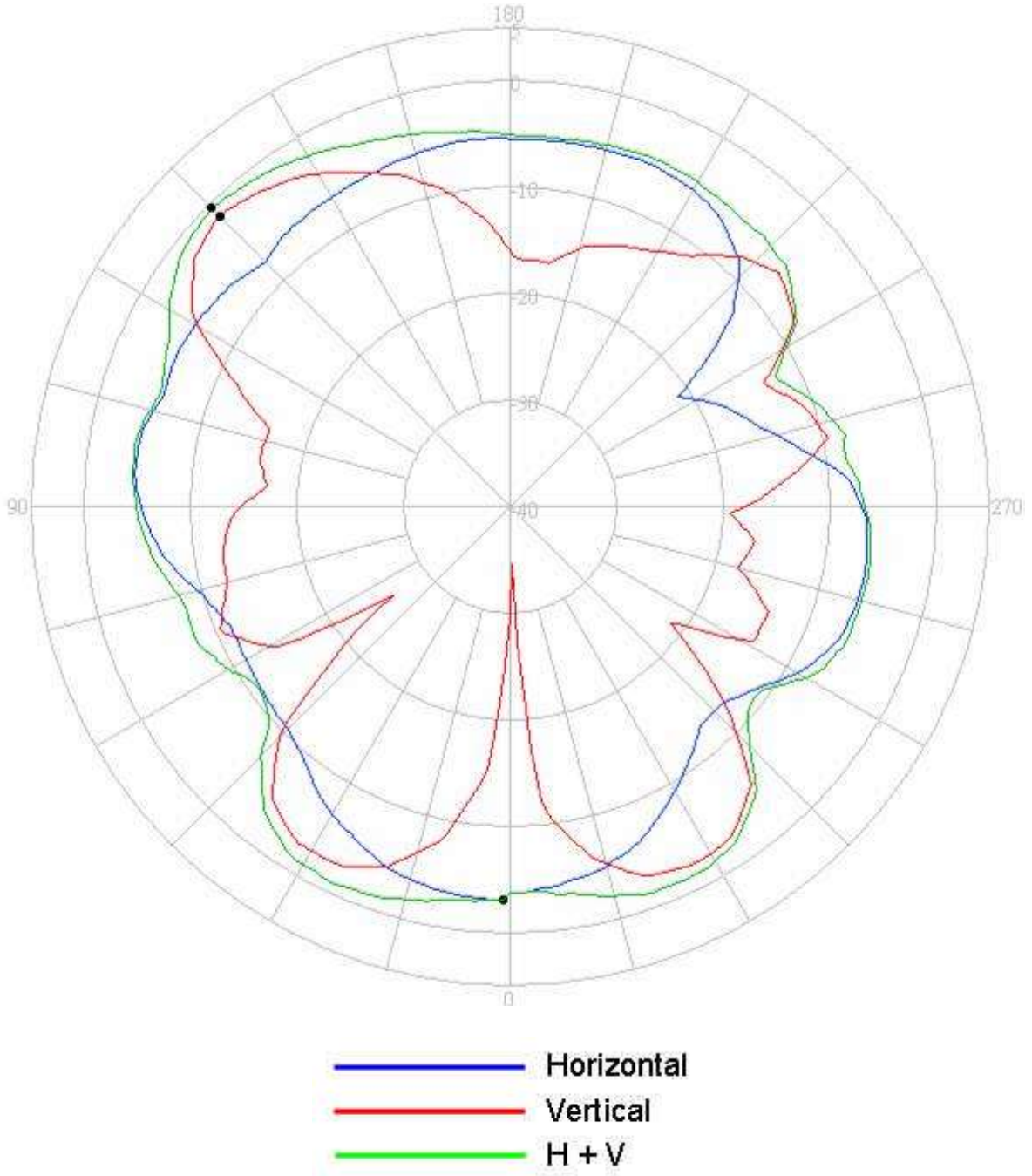

Center Frequency	2593 MHz
Horizontal (dBi) Peak	-3.05
Vertical (dBi) Peak	-1.35

WLAN_Main Antenna antenna: 2685 MHz

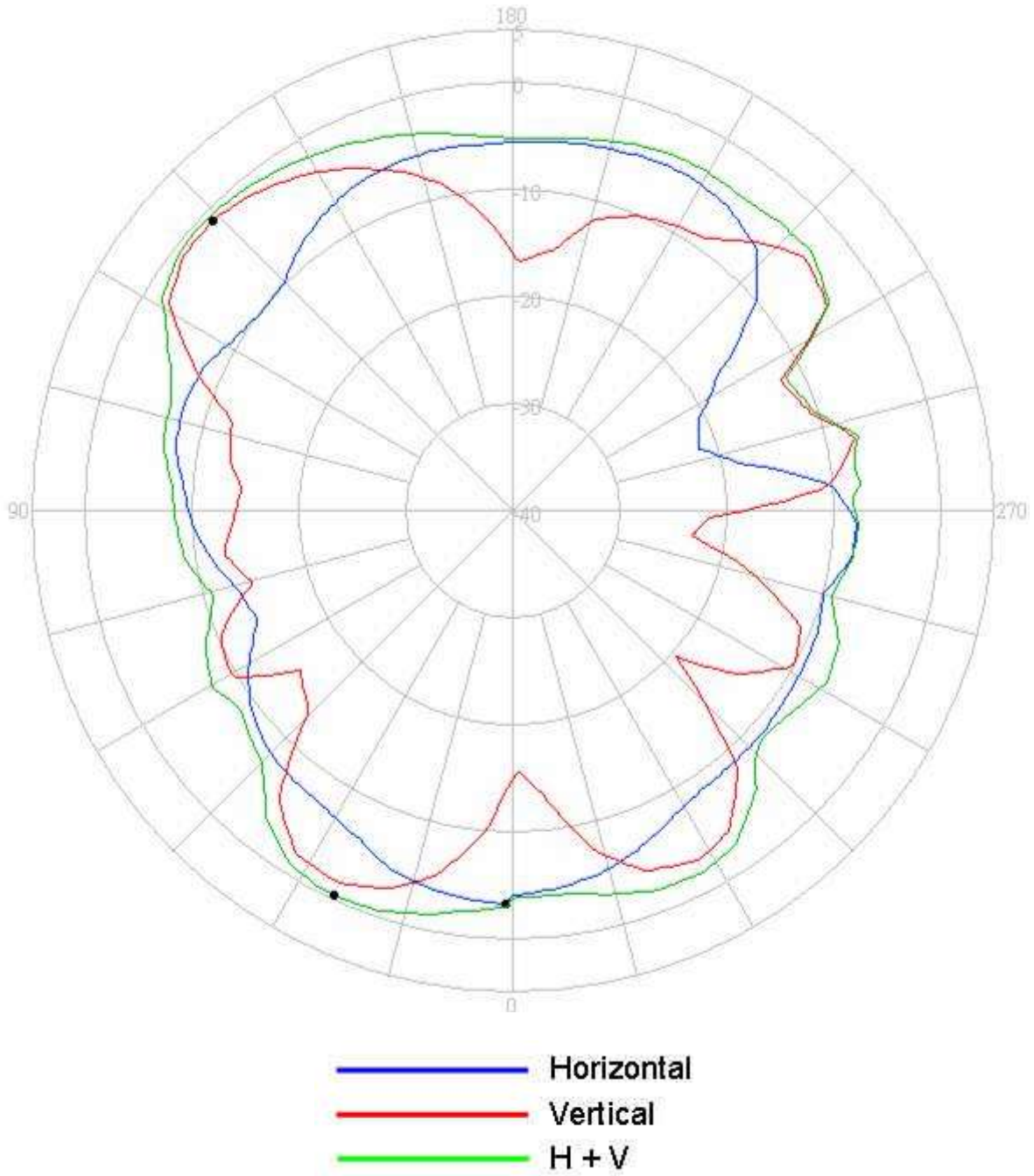

Center Frequency	2685 MHz
Horizontal (dBi) Peak	-3.21
Vertical (dBi) Peak	-0.98

WLAN_Aux Antenna antenna: 2501MHz

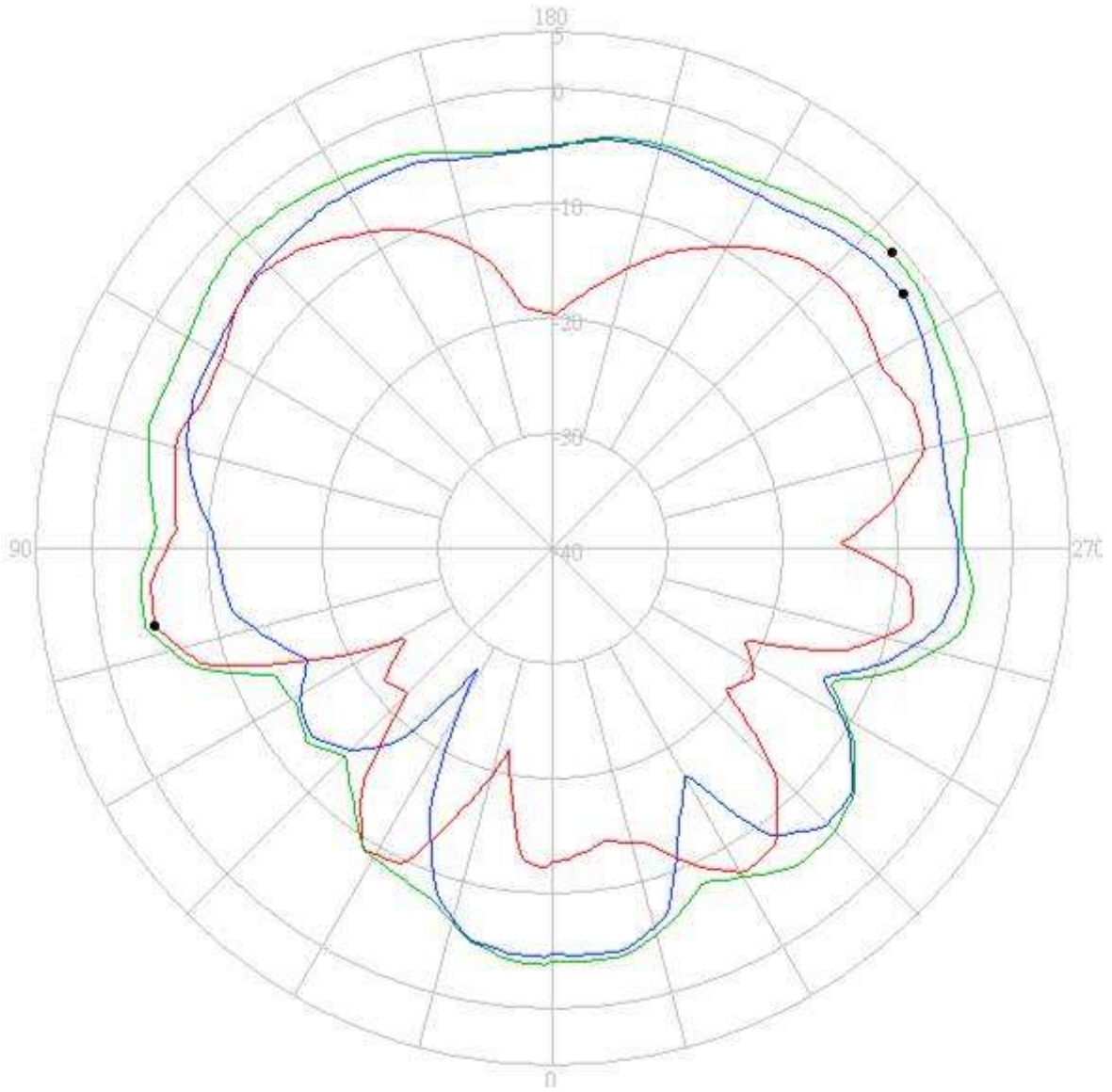

- Horizontal
- Vertical
- H + V

Center Frequency	2501 MHz
Horizontal (dBi) Peak	-2.32
Vertical (dBi) Peak	-4.70

WLAN_Aux Antenna antenna: 2593MHz

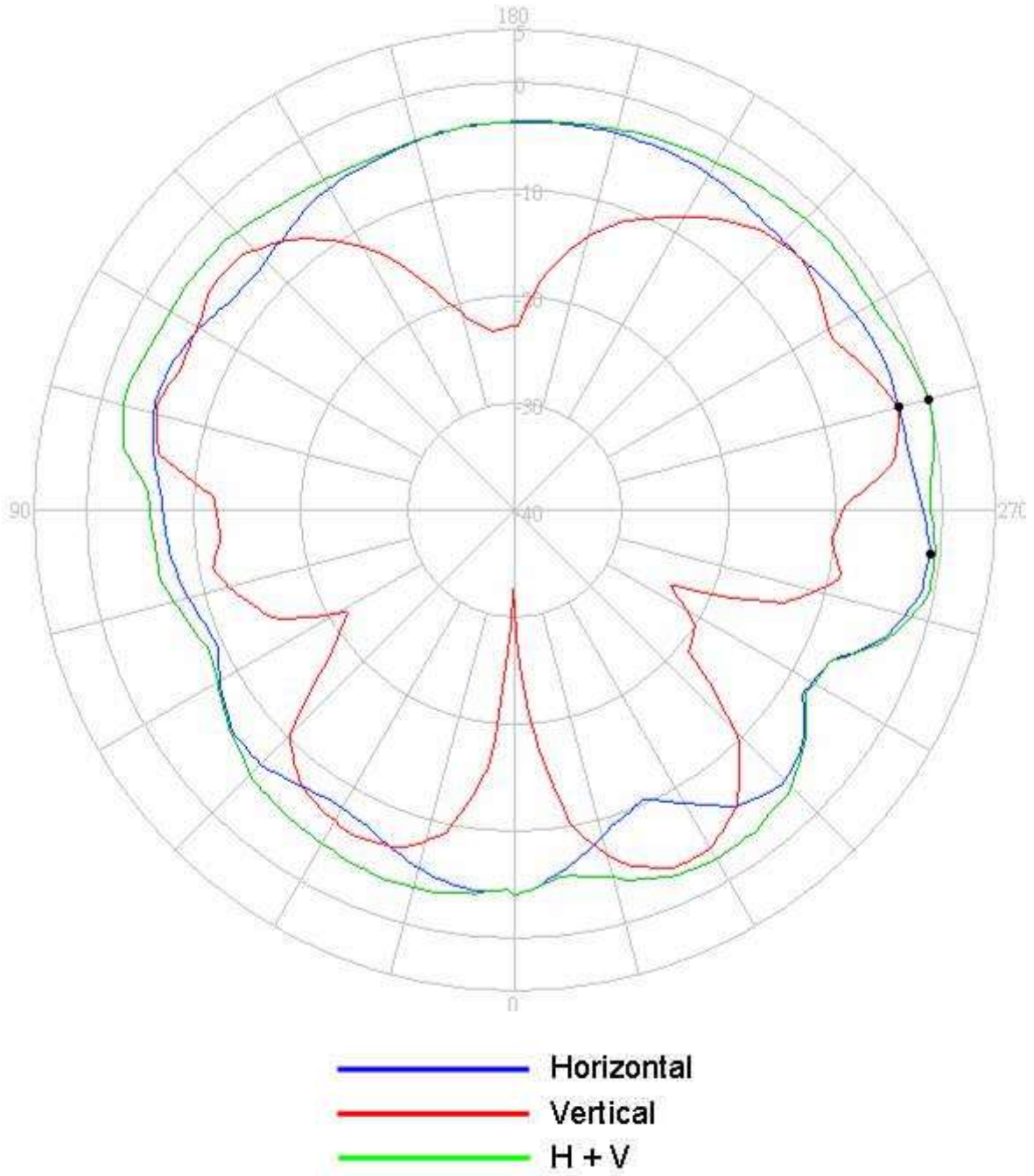

Center Frequency	2593 MHz
Horizontal (dBi) Peak	-0.94
Vertical (dBi) Peak	-2.84

WLAN_Aux Antenna antenna: 2685 MHz

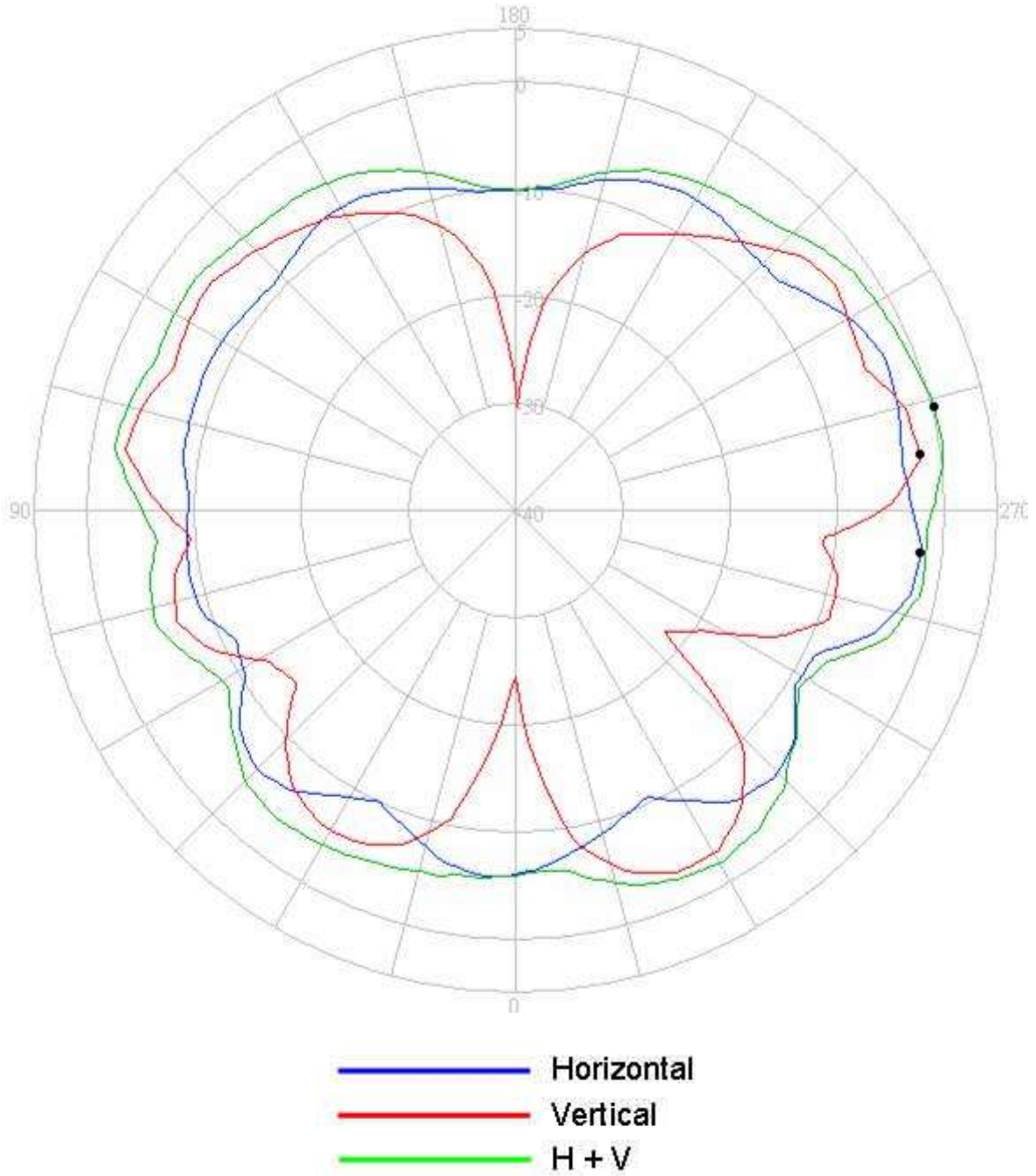

Center Frequency	2685 MHz
Horizontal (dBi) Peak	-1.94
Vertical (dBi) Peak	-1.93

MIMO Antenna antenna: 2501MHz

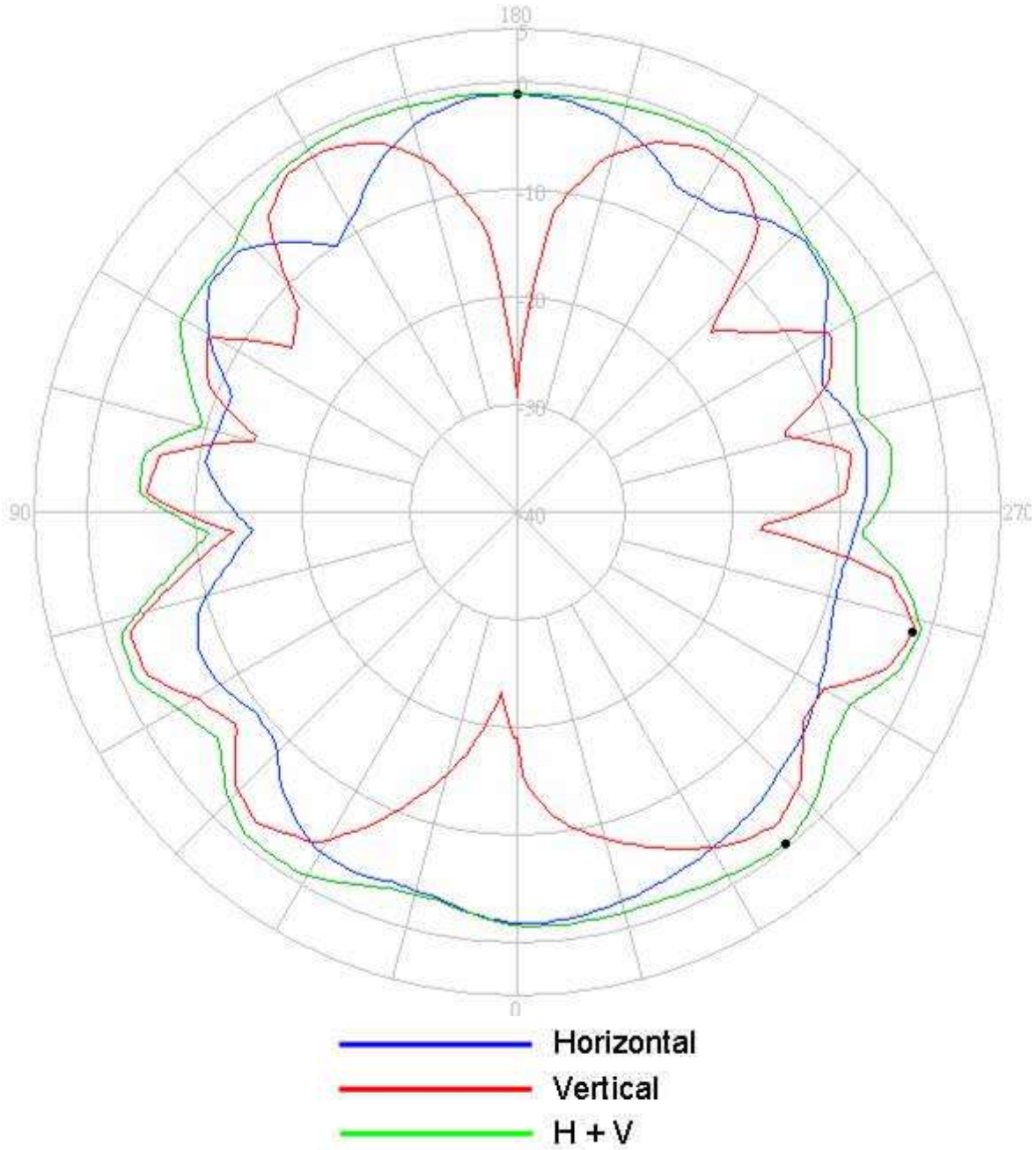

Center Frequency	2501 MHz
Horizontal (dBi) Peak	-1.04
Vertical (dBi) Peak	-1.55

MIMO Antenna antenna: 2593MHz

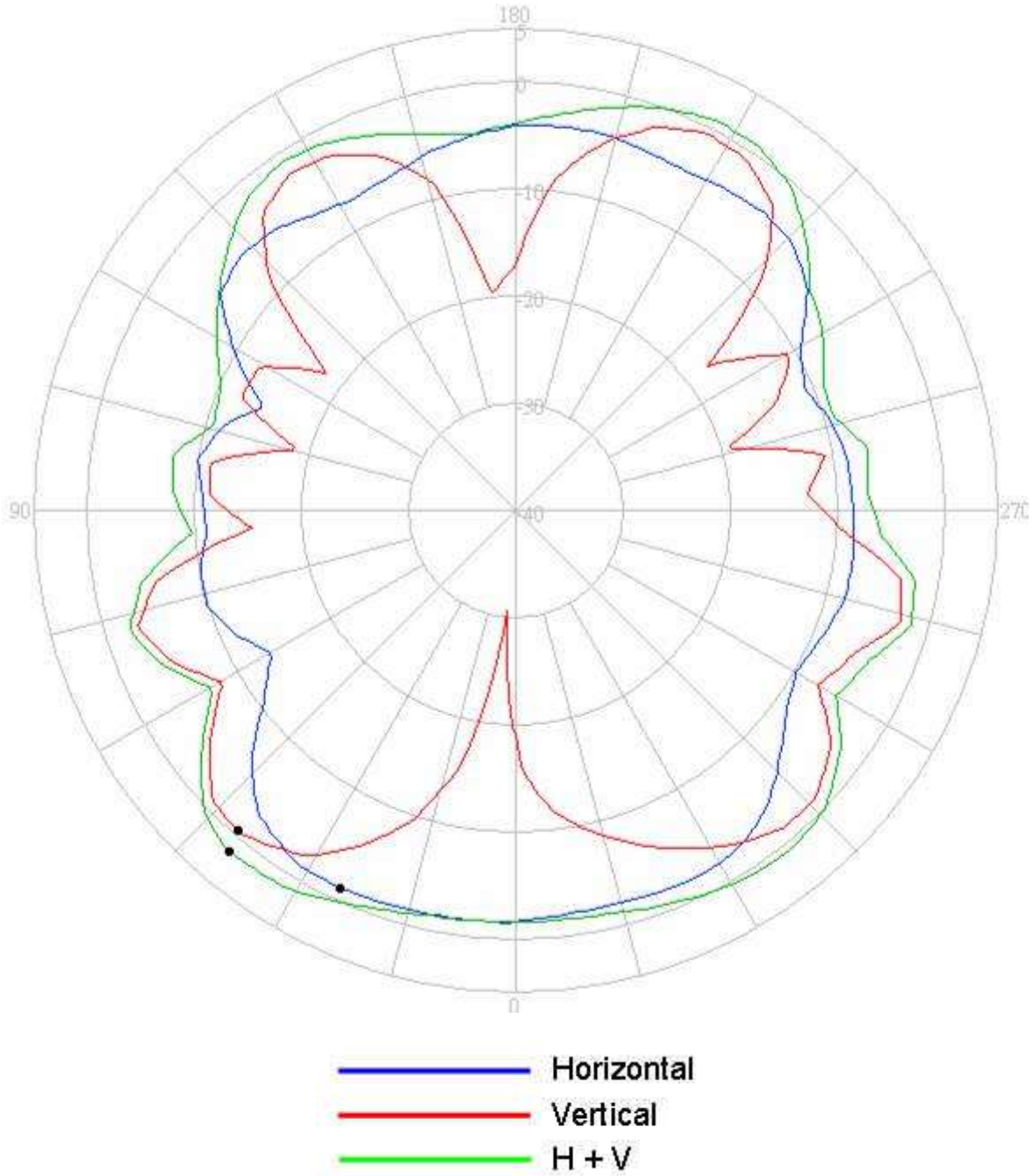

Center Frequency	2593 MHz
Horizontal (dBi) Peak	-1.10
Vertical (dBi) Peak	-0.36

MIMO Antenna antenna: 2685MHz

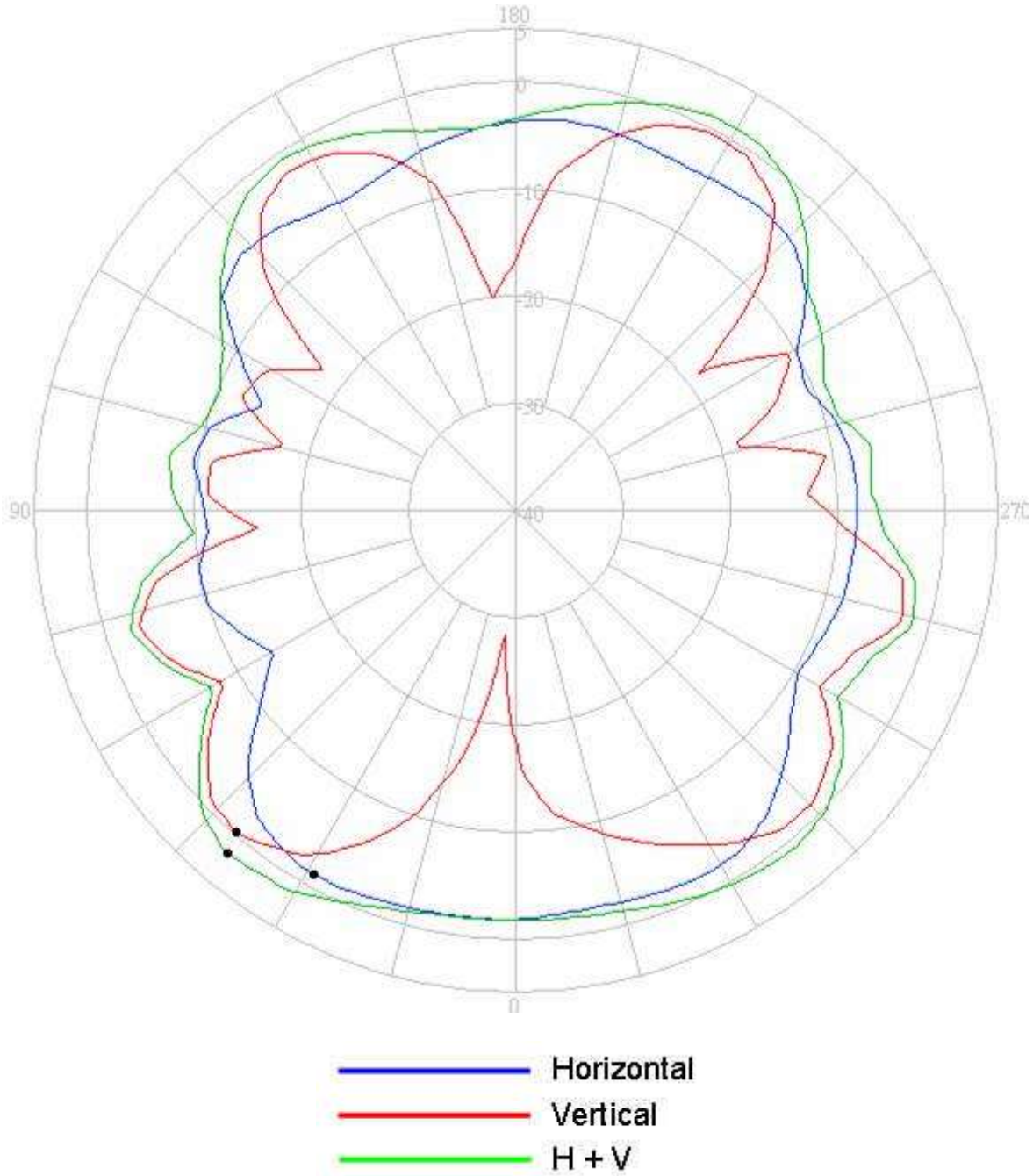

Center Frequency	2685 MHz
Horizontal (dBi) Peak	-2.48
Vertical (dBi) Peak	-0.15

5150-5350 MHz radiation characteristic

WLAN_Main Antenna antenna: 5150 MHz

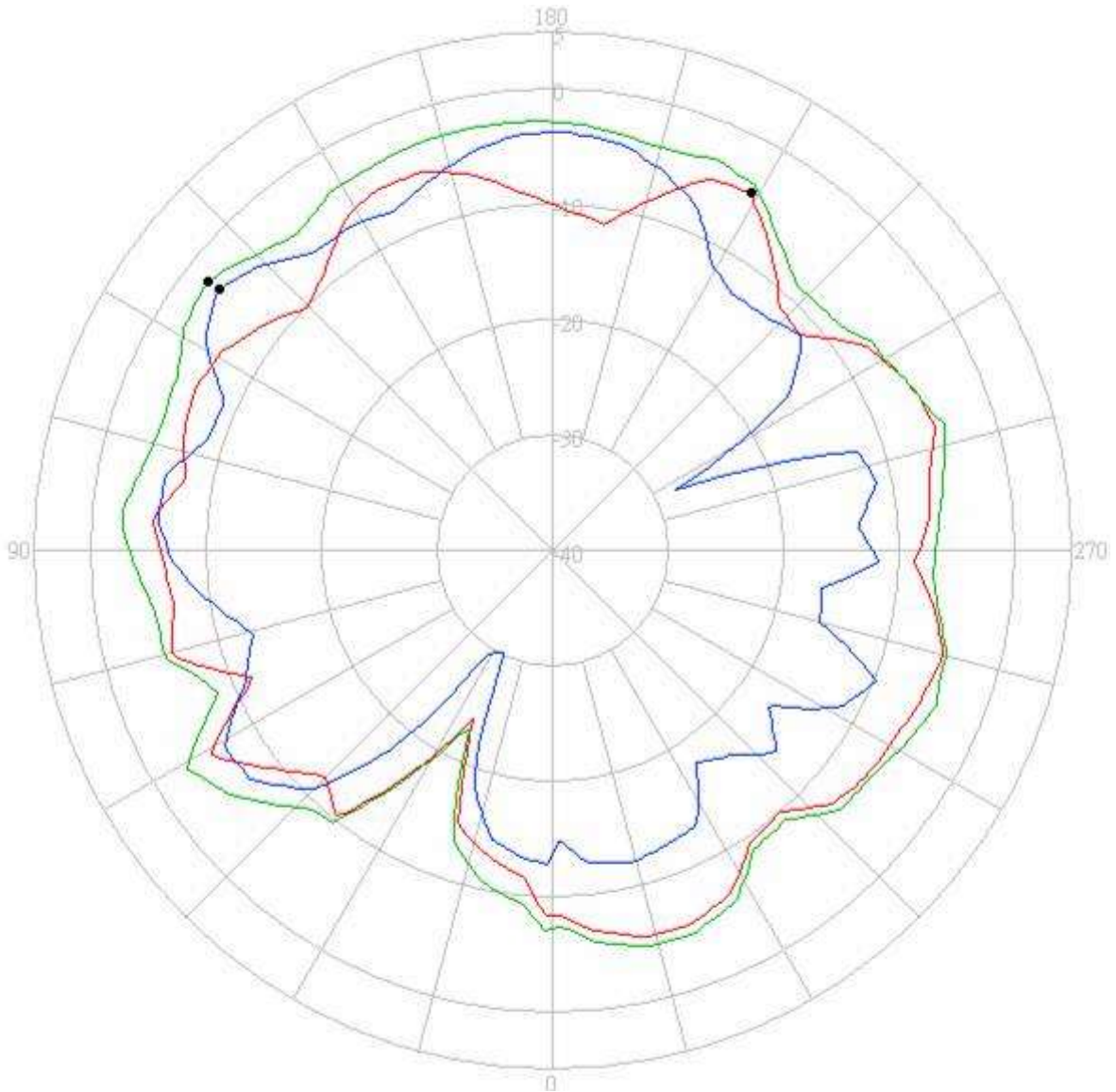

- Horizontal
- Vertical
- H + V

Center Frequency	5150 MHz
Horizontal (dBi) Peak	-3.25
Vertical (dBi) Peak	-4.56

WLAN_Main Antenna antenna: 5250 MHz

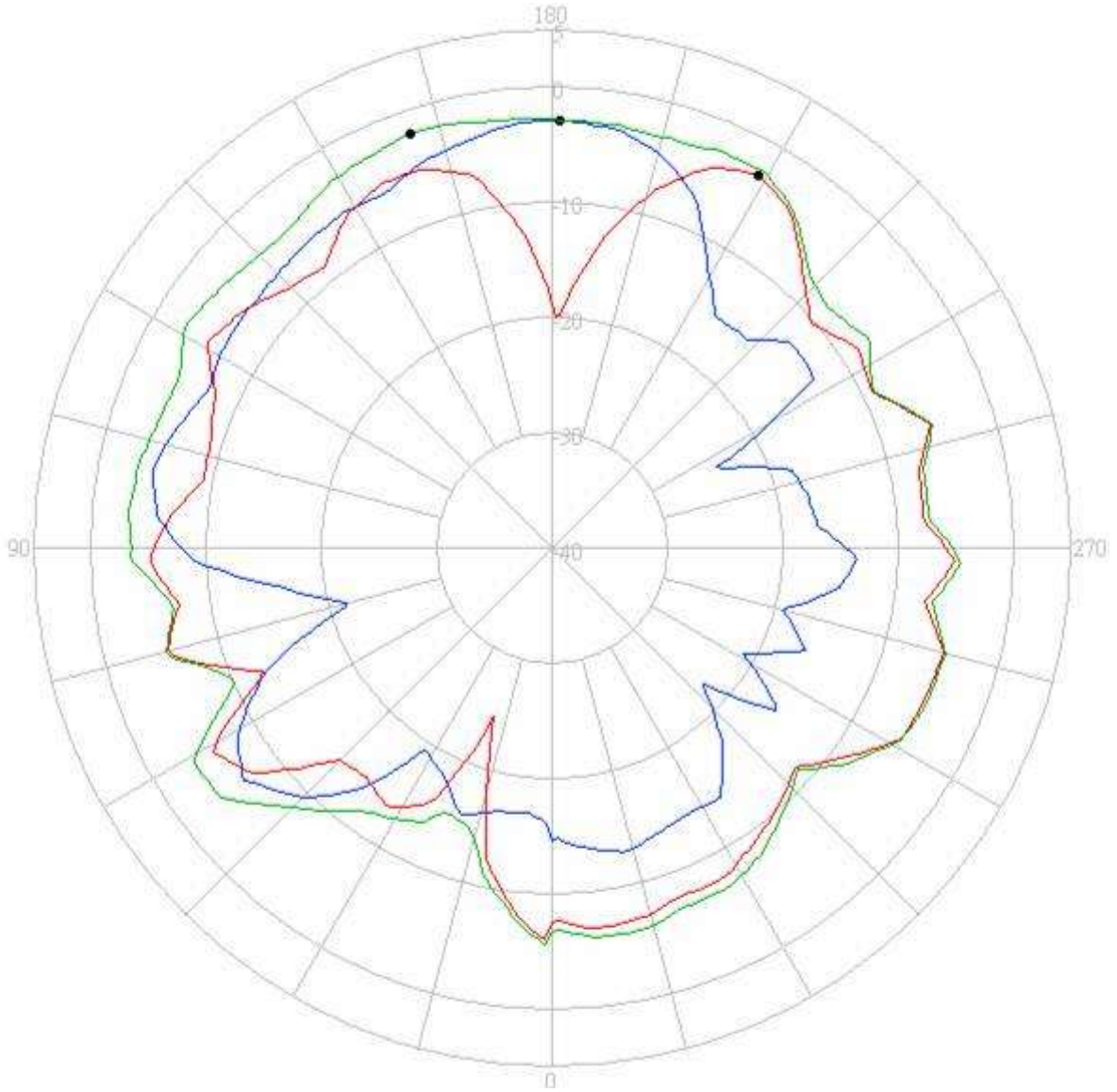

- Horizontal
- Vertical
- H + V

Center Frequency	5250 MHz
Horizontal (dBi) Peak	-2.88
Vertical (dBi) Peak	-2.92

WLAN_Main Antenna antenna: 5350 MHz

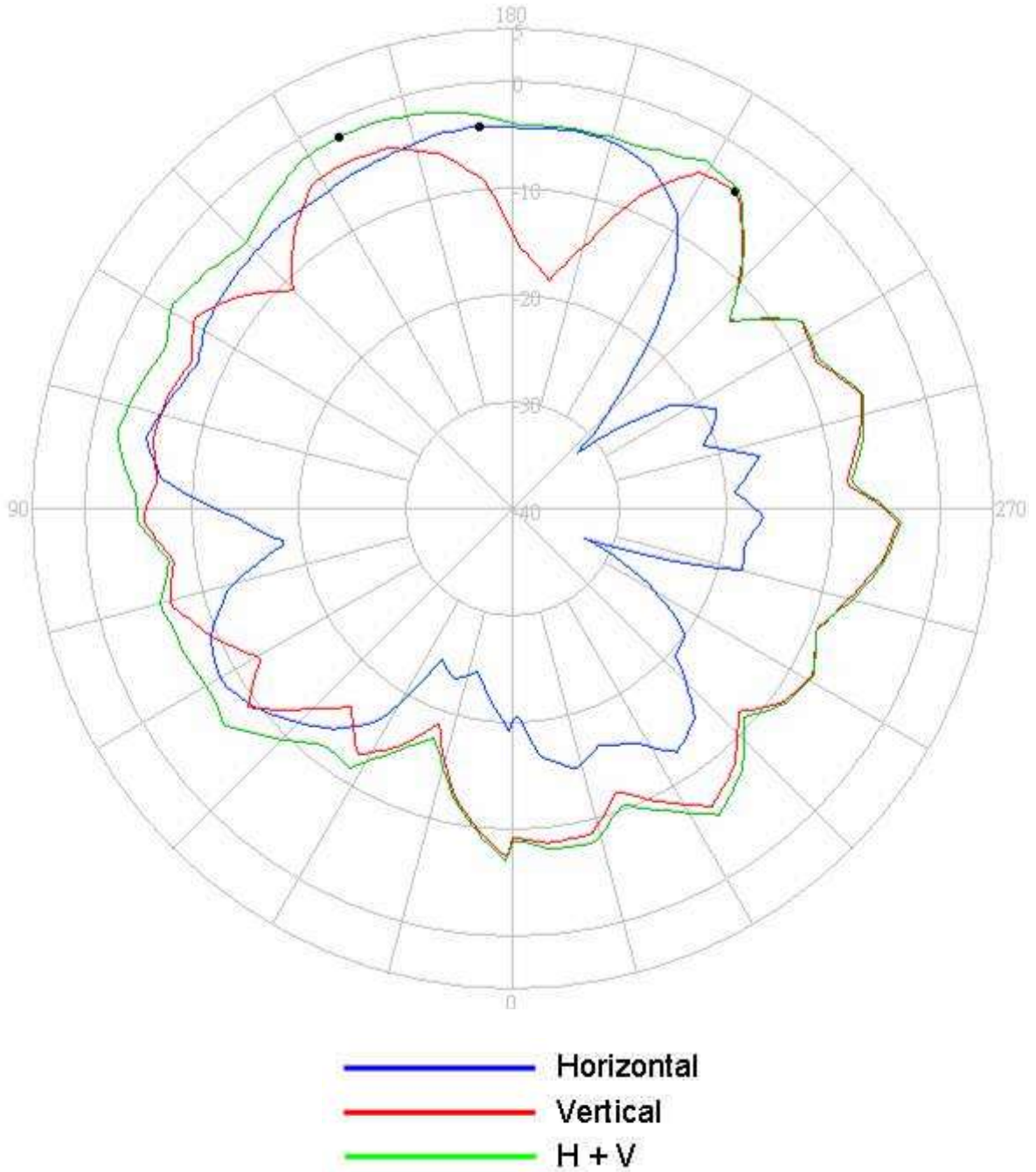

Center Frequency	5350 MHz
Horizontal (dBi) Peak	-4.01
Vertical (dBi) Peak	-3.63

WLAN_Aux Antenna antenna: 5150 MHz

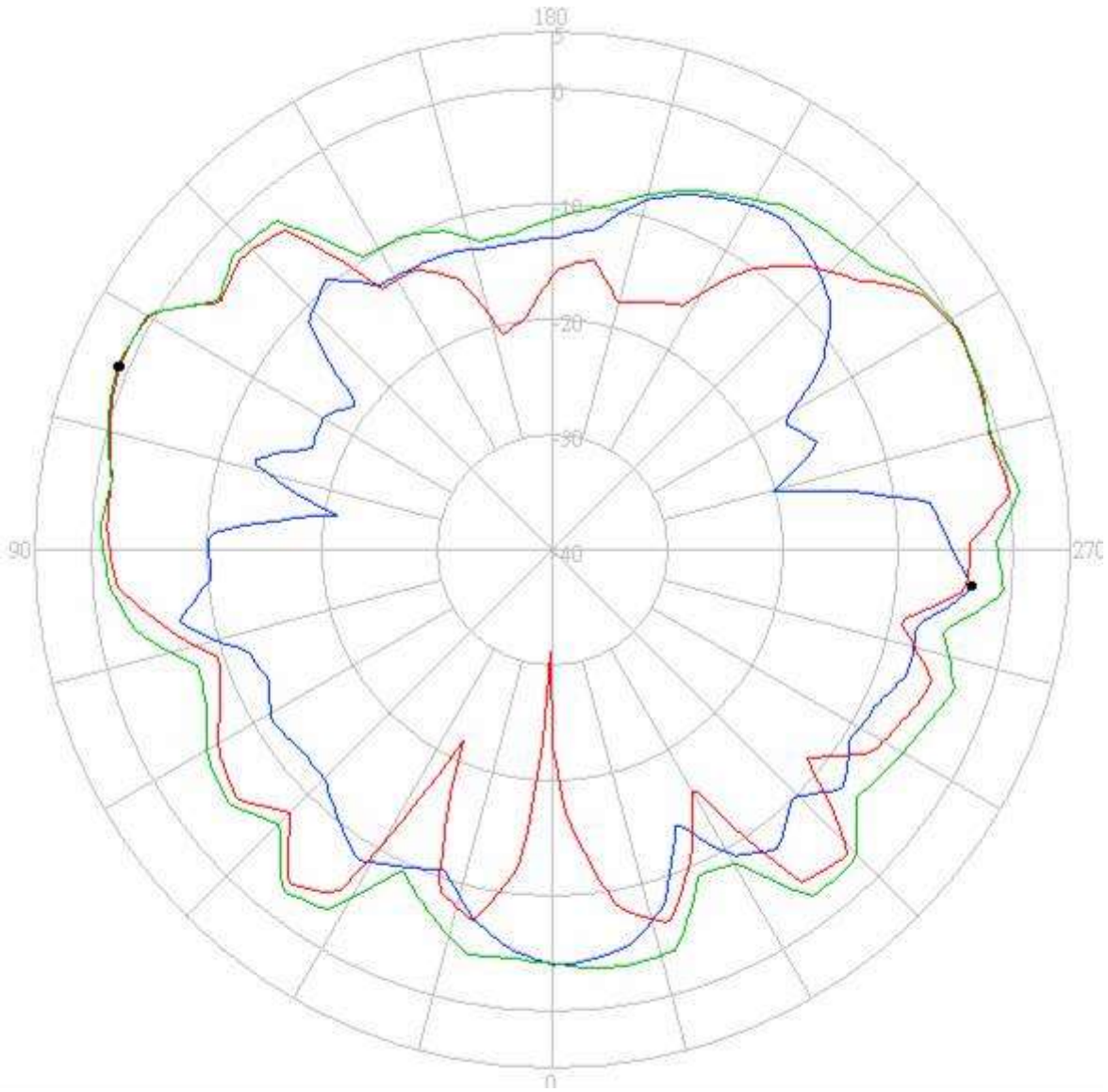

- Horizontal
- Vertical
- H + V

Center Frequency	5150 MHz
Horizontal (dBi) Peak	-3.48
Vertical (dBi) Peak	0.90

WLAN_Aux Antenna antenna: 5250 MHz

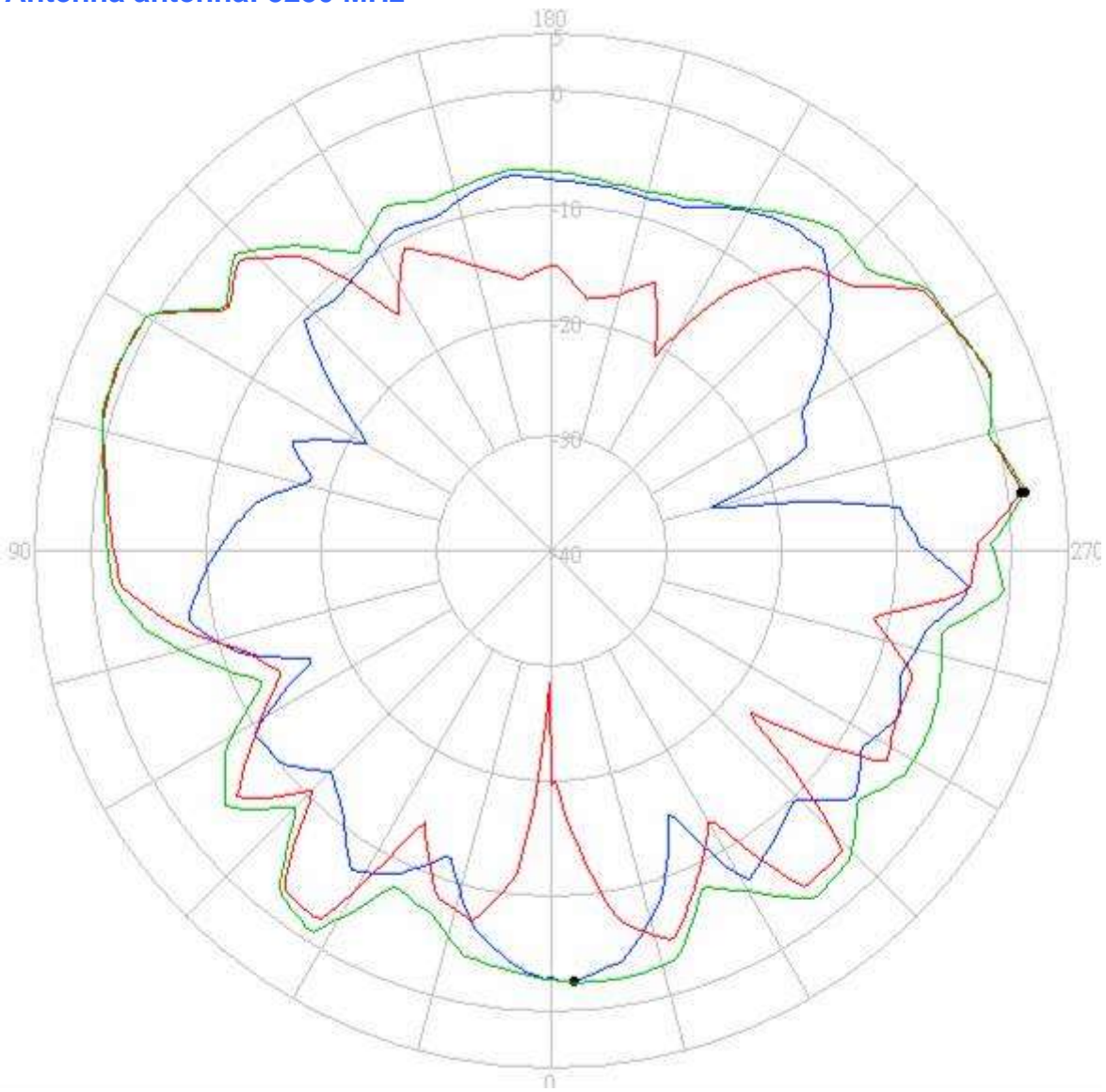

- Horizontal
- Vertical
- H + V

WLAN_Aux Antenna antenna: 5350 MHz

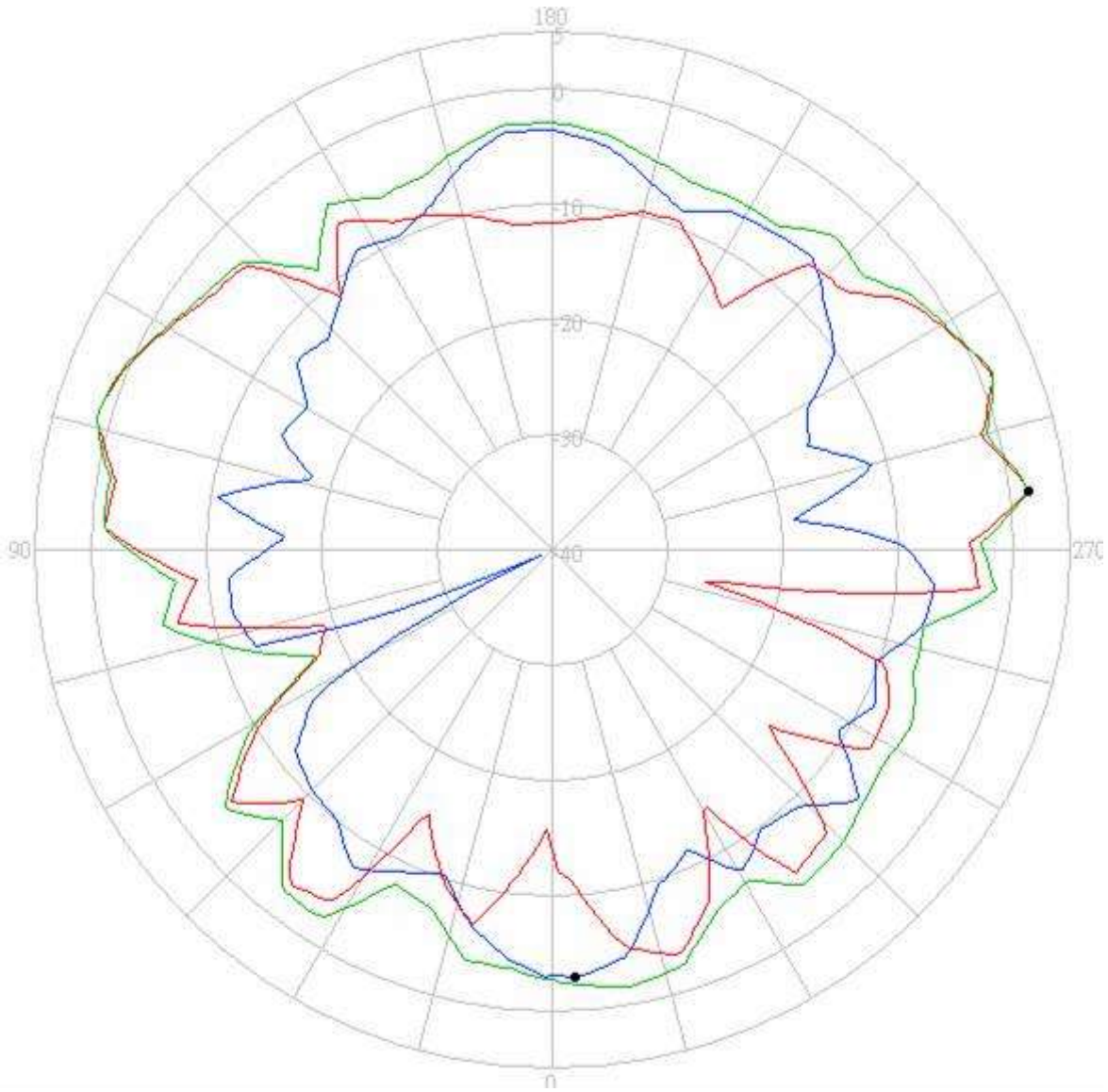

- Horizontal
- Vertical
- H + V

Center Frequency	5350 MHz
Horizontal (dBi) Peak	-2.80
Vertical (dBi) Peak	1.63

MIMO Antenna antenna: 5150 MHz

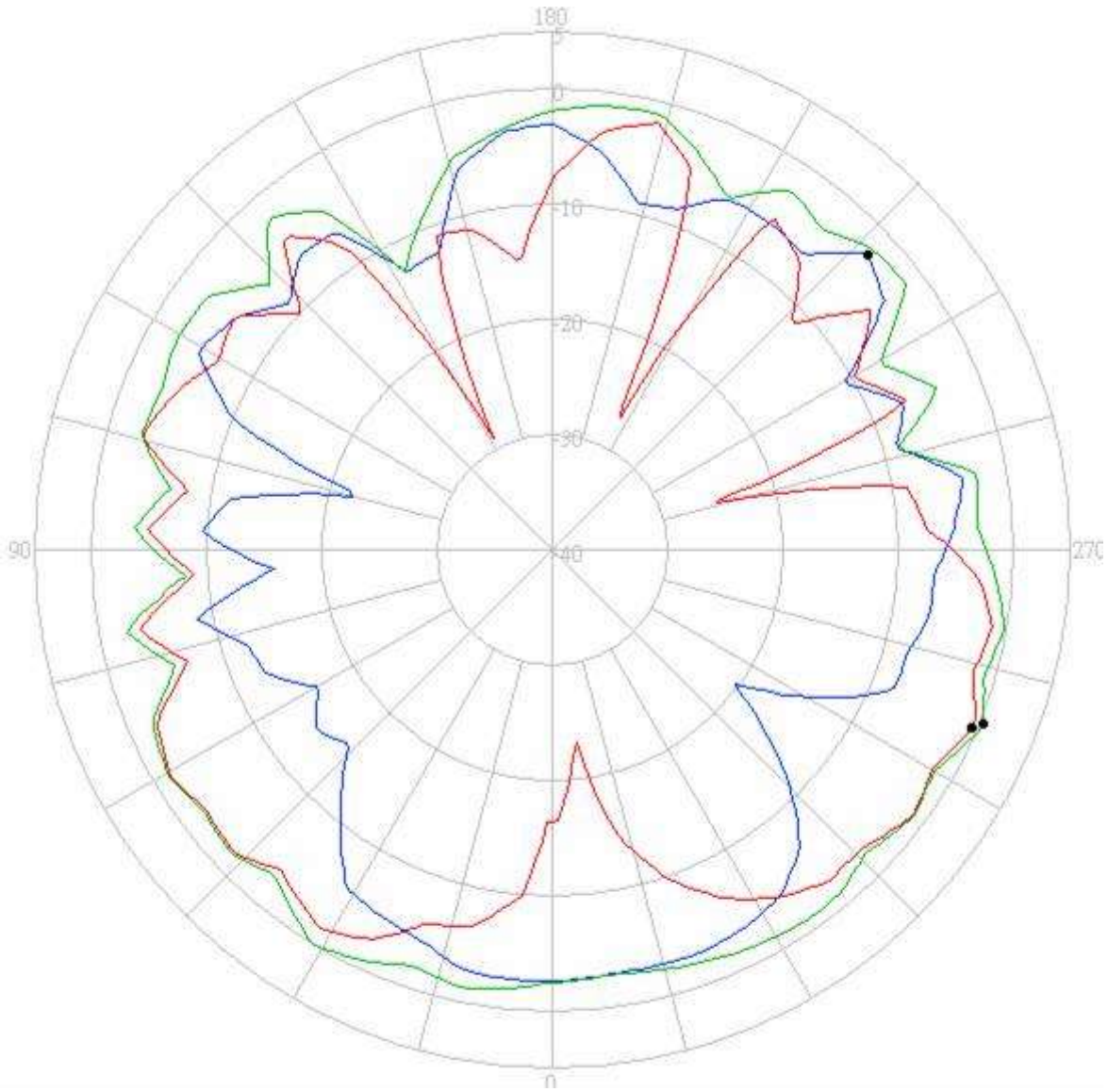

- Horizontal
- Vertical
- H + V

Center Frequency	5150 MHz
Horizontal (dBi) Peak	-2.43
Vertical (dBi) Peak	-0.36

MIMO Antenna antenna: 5250 MHz

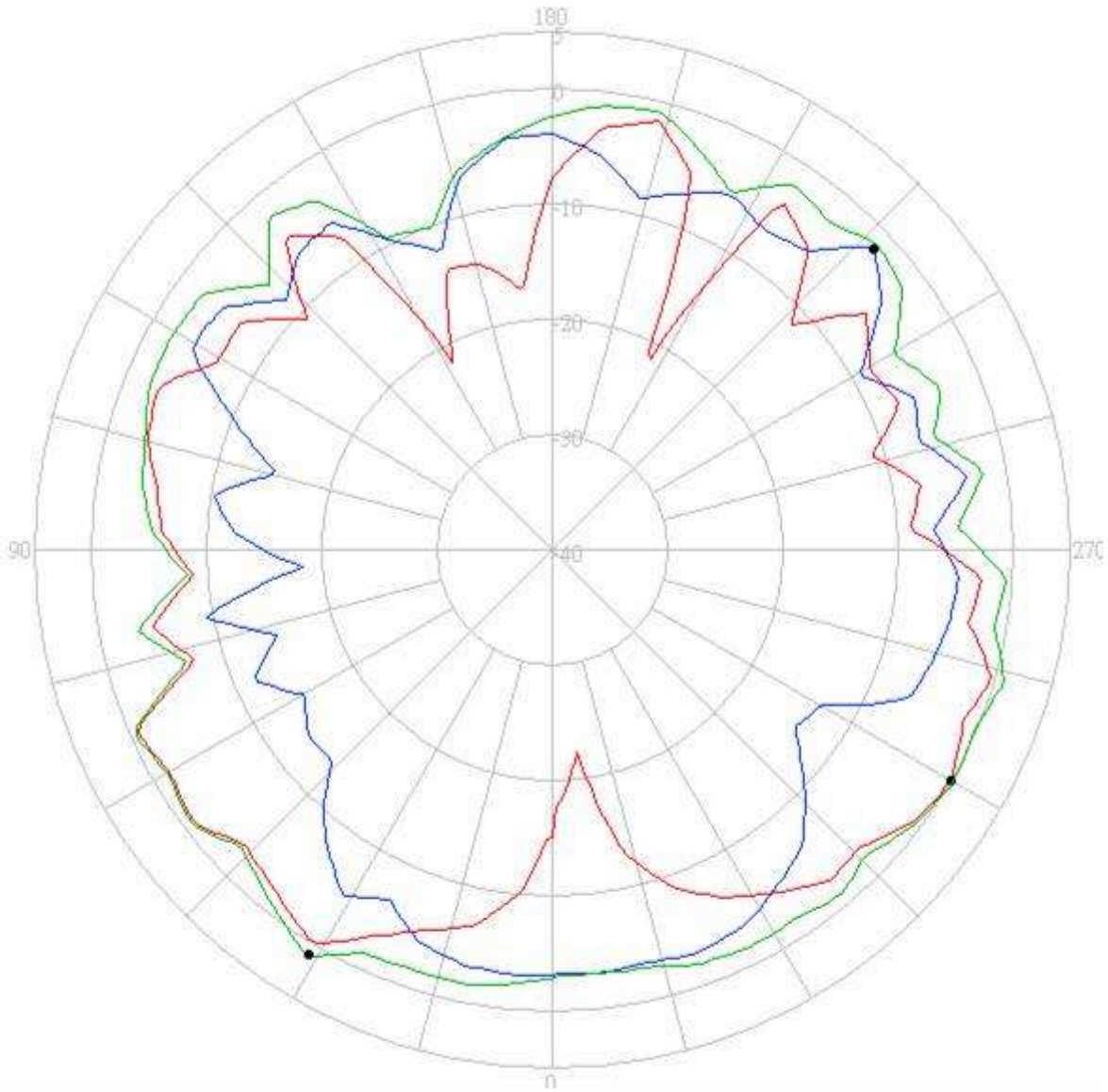

- Horizontal
- Vertical
- H + V

Center Frequency	5250 MHz
Horizontal (dBi) Peak	-1.80
Vertical (dBi) Peak	0.03

MIMO Antenna antenna: 5350 MHz

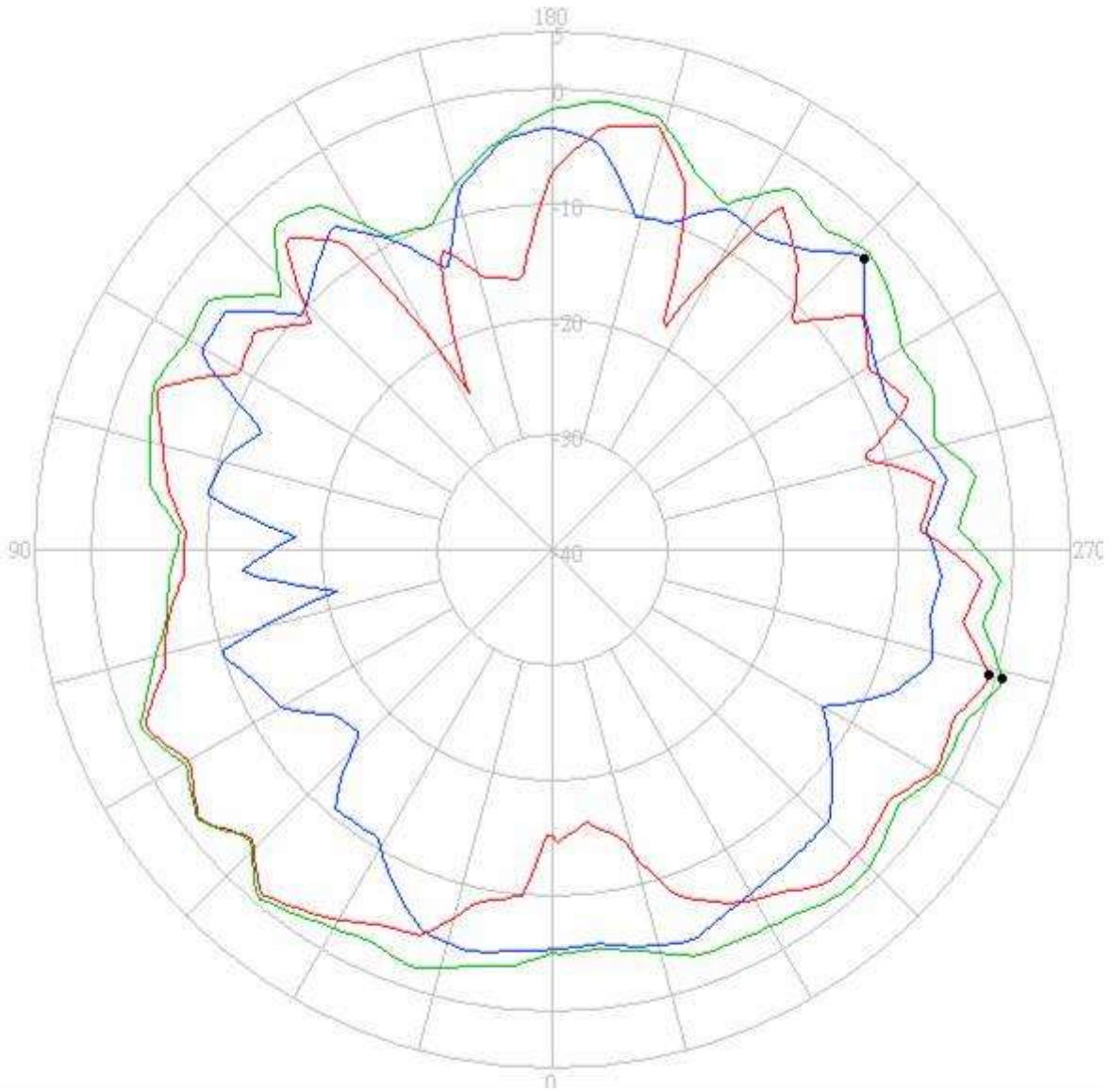

- Horizontal
- Vertical
- H + V

Center Frequency	5350 MHz
Horizontal (dBi) Peak	-2.91
Vertical (dBi) Peak	-0.45

5470-5725MHz radiation characteristic

WLAN_Main Antenna antenna: 5470 MHz

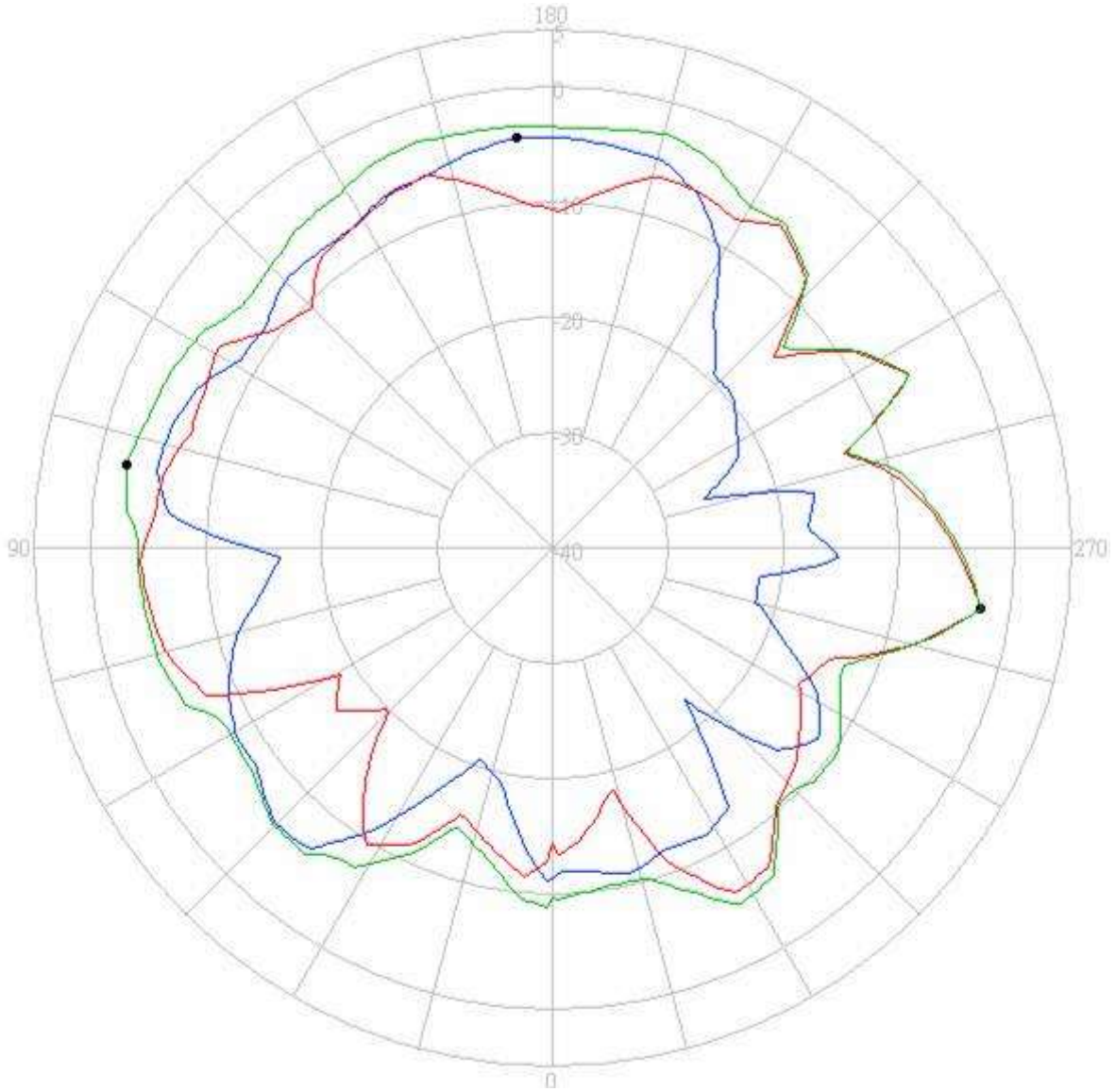

- Horizontal
- Vertical
- H + V

Center Frequency	5470 MHz
Horizontal (dBi) Peak	-4.29
Vertical (dBi) Peak	-2.46

WLAN_Main Antenna antenna: 5600 MHz

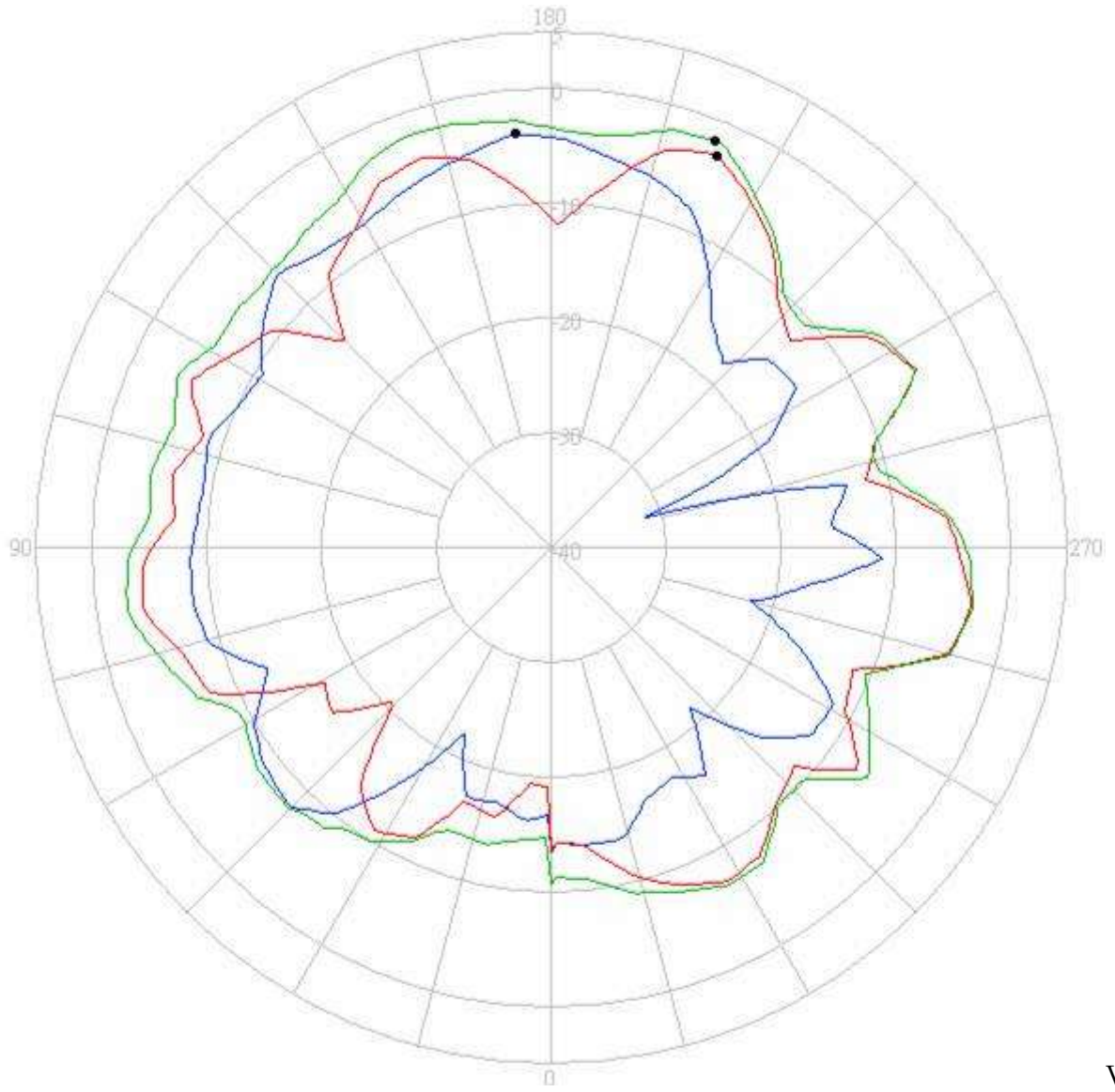

V

- Horizontal
- Vertical
- H + V

Center Frequency	5600 MHz
Horizontal (dBi) Peak	-3.81
Vertical (dBi) Peak	-2.87

WLAN_Main Antenna antenna: 5725 MHz

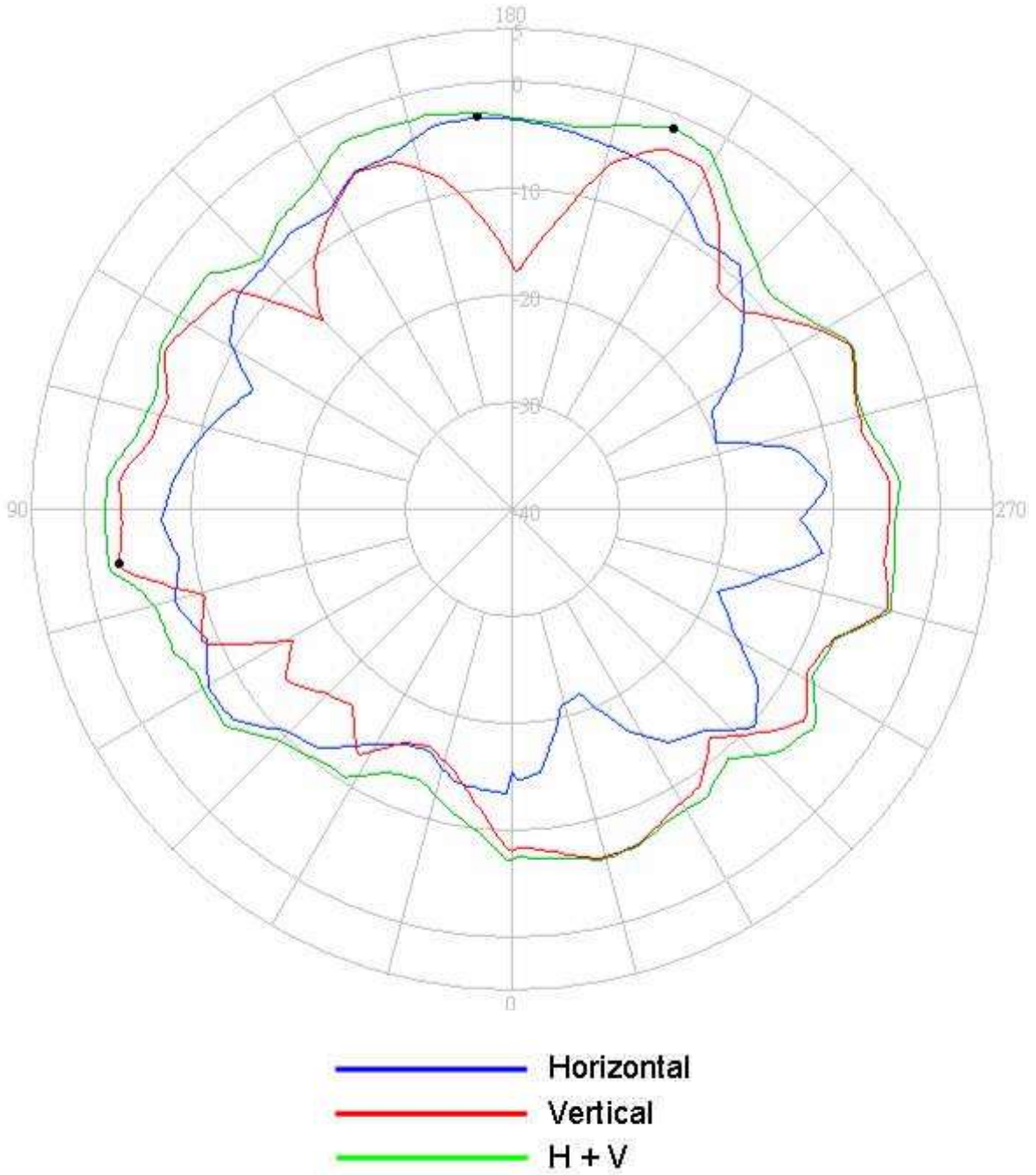

Center Frequency	5725 MHz
Horizontal (dBi) Peak	-3.14
Vertical (dBi) Peak	-2.91

WLAN_Aux Antenna antenna: 5470 MHz

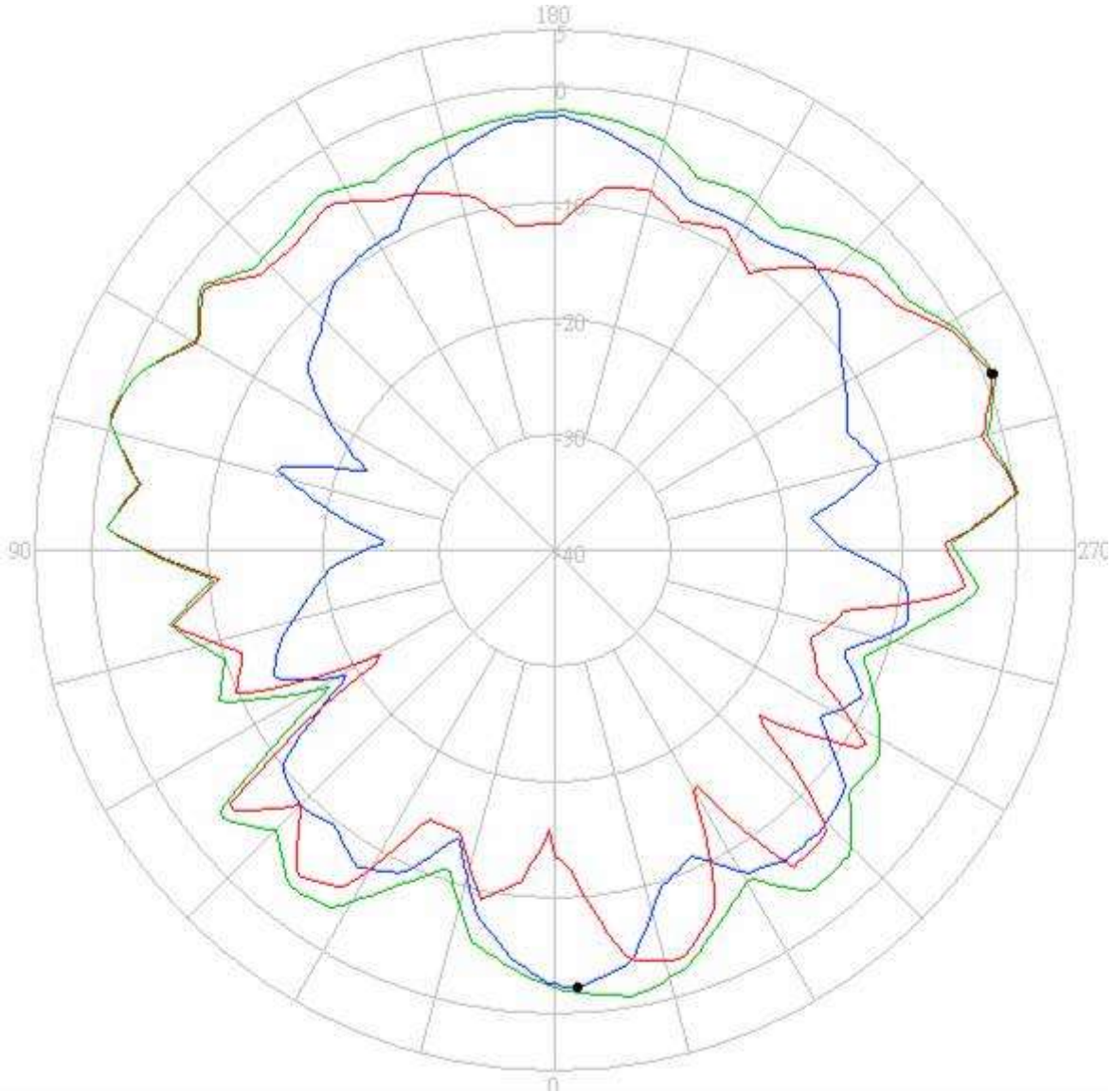

- Horizontal
- Vertical
- H + V

Center Frequency	5470 MHz
Horizontal (dBi) Peak	-2.15
Vertical (dBi) Peak	0.79

WLAN_Aux Antenna antenna: 5600 MHz

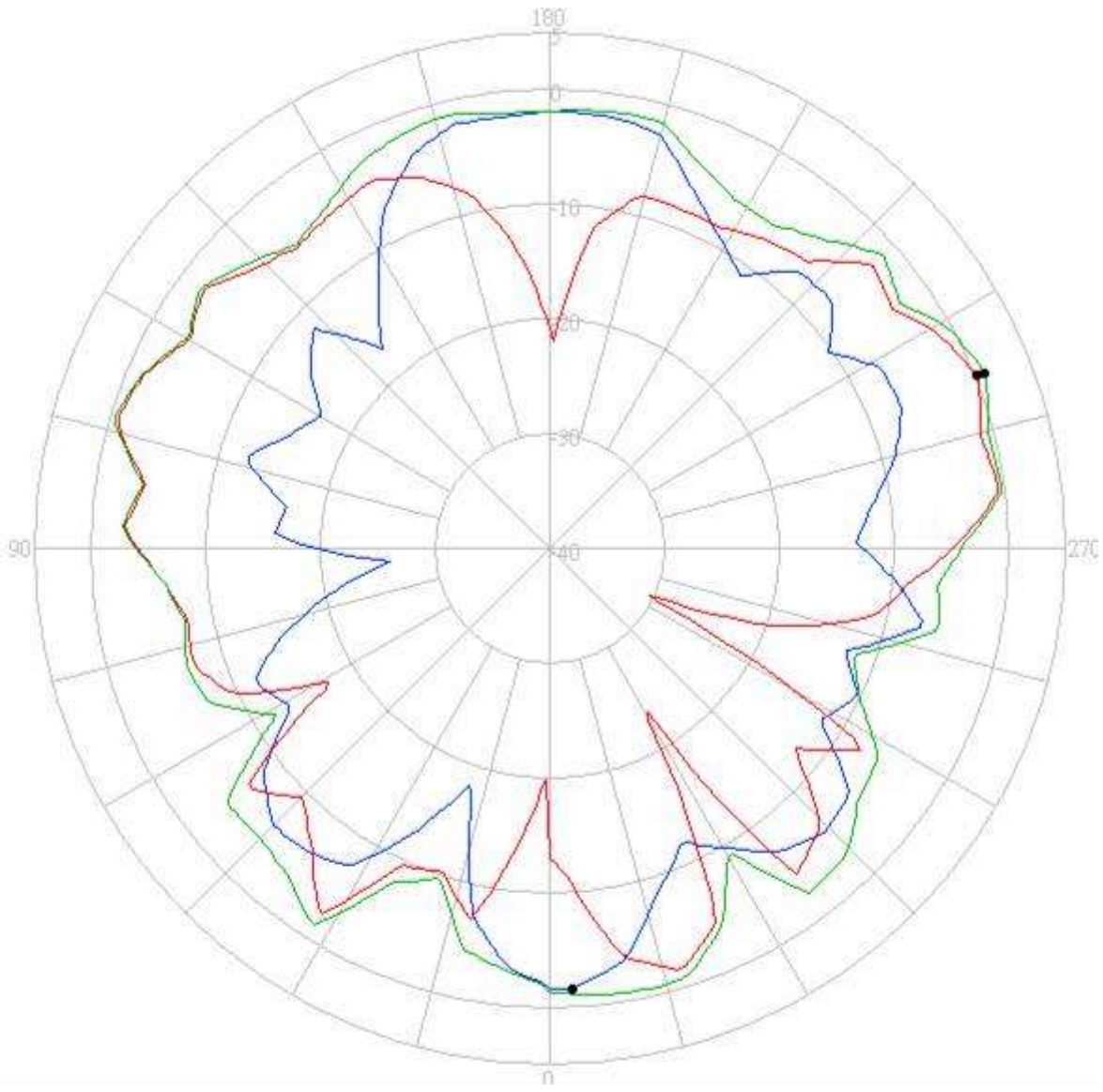

- Horizontal
- Vertical
- H + V

Center Frequency	5600 MHz
Horizontal (dBi) Peak	-1.51
Vertical (dBi) Peak	0.19

WLAN_Aux Antenna antenna: 5725 MHz

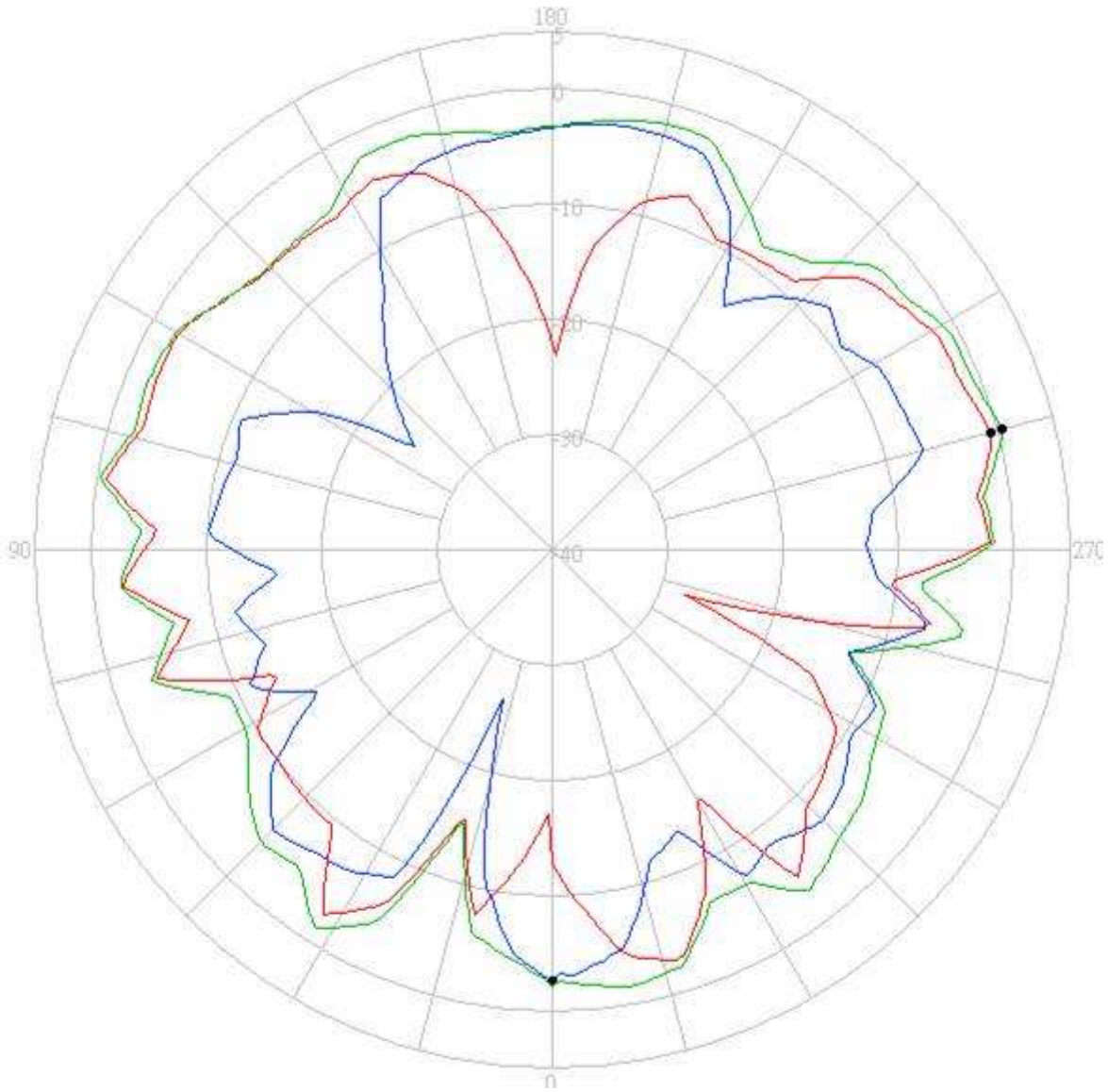

- Horizontal
- Vertical
- H + V

Center Frequency	5725 MHz
Horizontal (dBi) Peak	-2.53
Vertical (dBi) Peak	-0.51

MIMO Antenna antenna: 5470 MHz

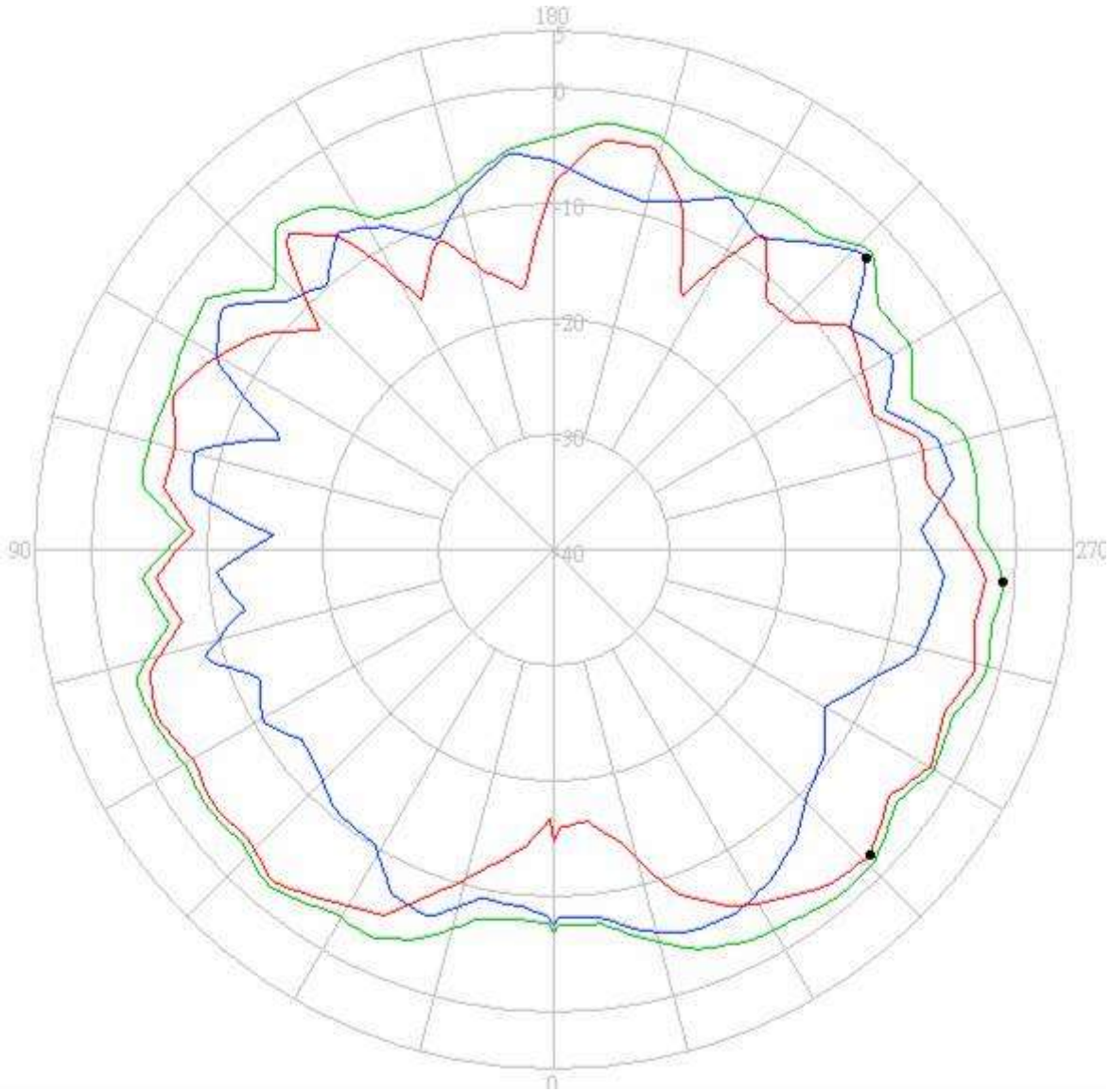

- Horizontal
- Vertical
- H + V

Center Frequency	5470 MHz
Horizontal (dBi) Peak	-2.88
Vertical (dBi) Peak	-1.97

MIMO Antenna antenna: 5600 MHz

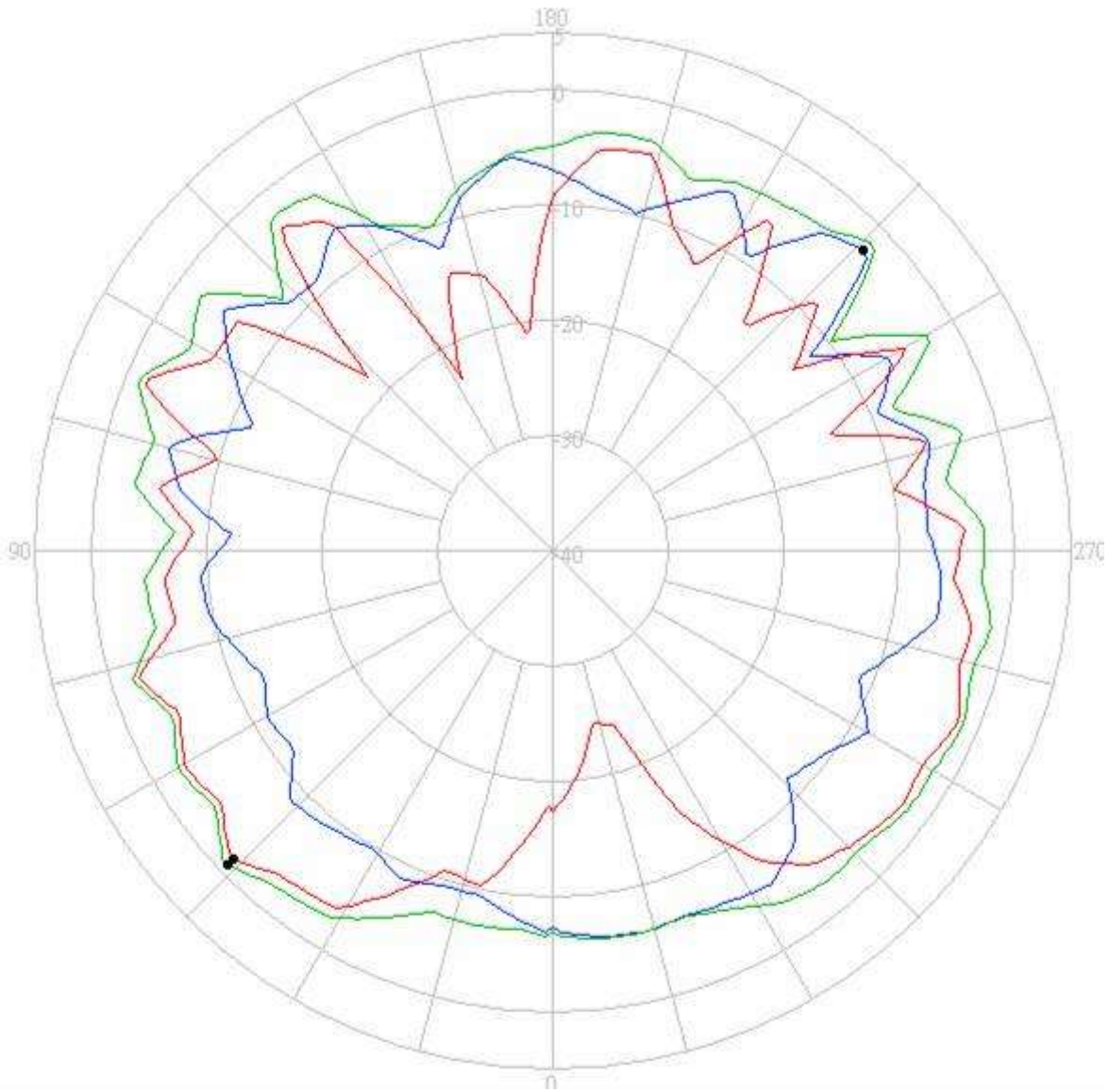

- Horizontal
- Vertical
- H + V

Center Frequency	5600 MHz
Horizontal (dBi) Peak	-2.45
Vertical (dBi) Peak	-1.40

MIMO Antenna antenna: 5725 MHz

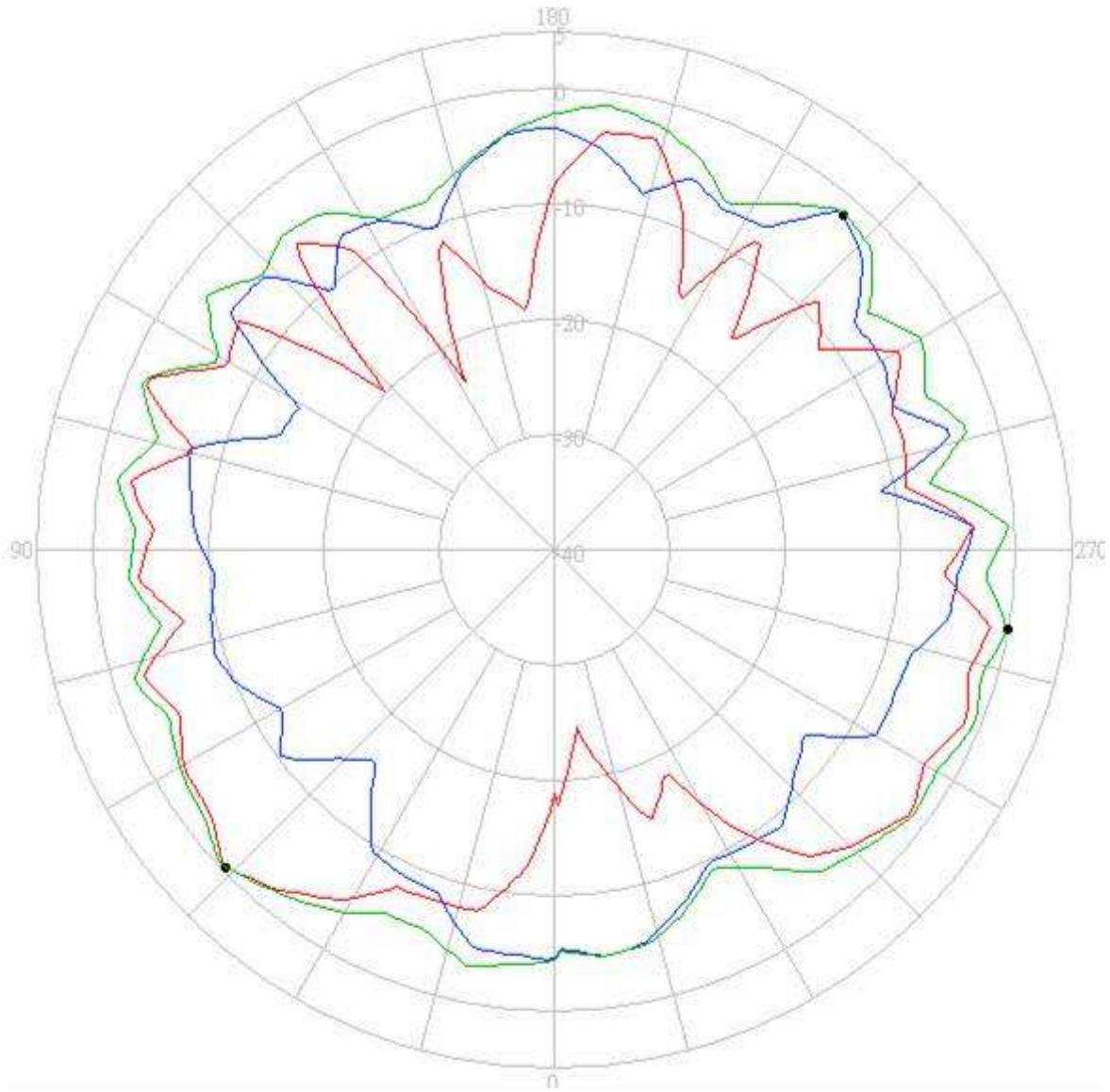

- Horizontal
- Vertical
- H + V

Center Frequency	5725 MHz
Horizontal (dBi) Peak	-1.58
Vertical (dBi) Peak	-0.37

5725-5850 MHz radiation characteristic

WLAN_Main Antenna antenna: 5725 MHz

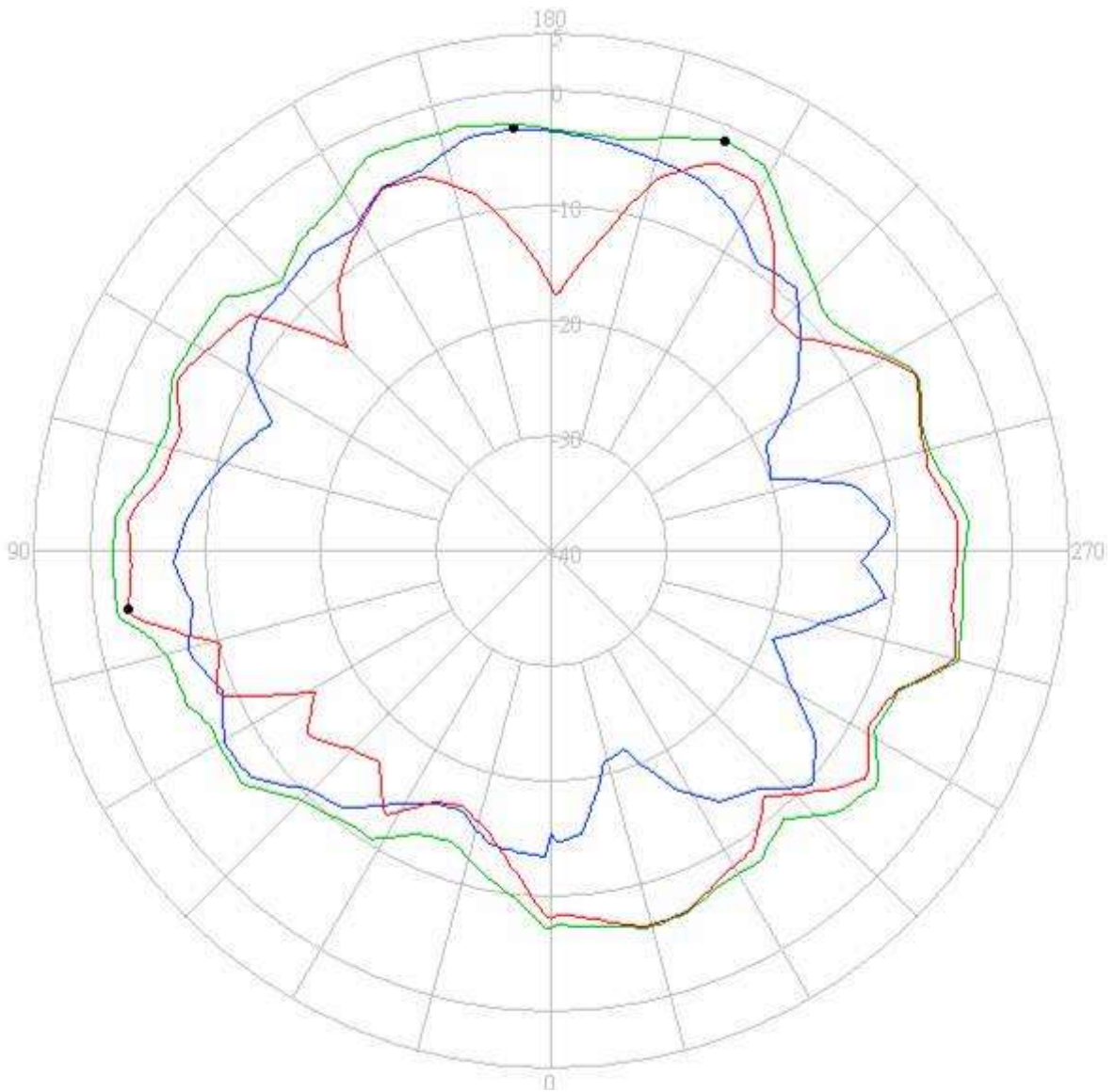

- Horizontal
- Vertical
- H + V

Center Frequency	5725 MHz
Horizontal (dBi) Peak	-3.14
Vertical (dBi) Peak	-2.91

WLAN_Main Antenna antenna: 5785 MHz

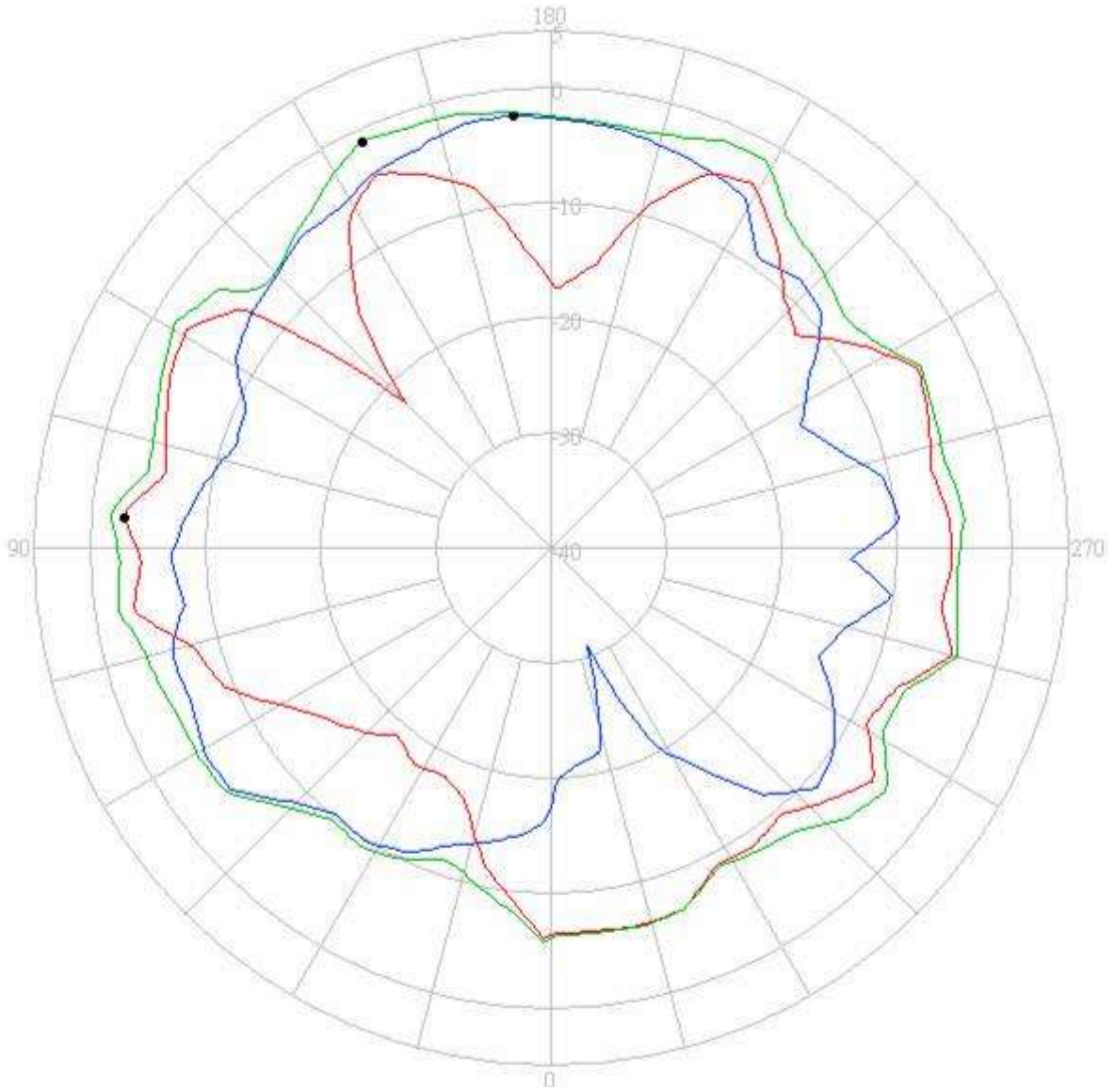

- Horizontal
- Vertical
- H + V

Center Frequency	5785 MHz
Horizontal (dBi) Peak	-2.23
Vertical (dBi) Peak	-2.83

WLAN_Main Antenna antenna: 5850 MHz

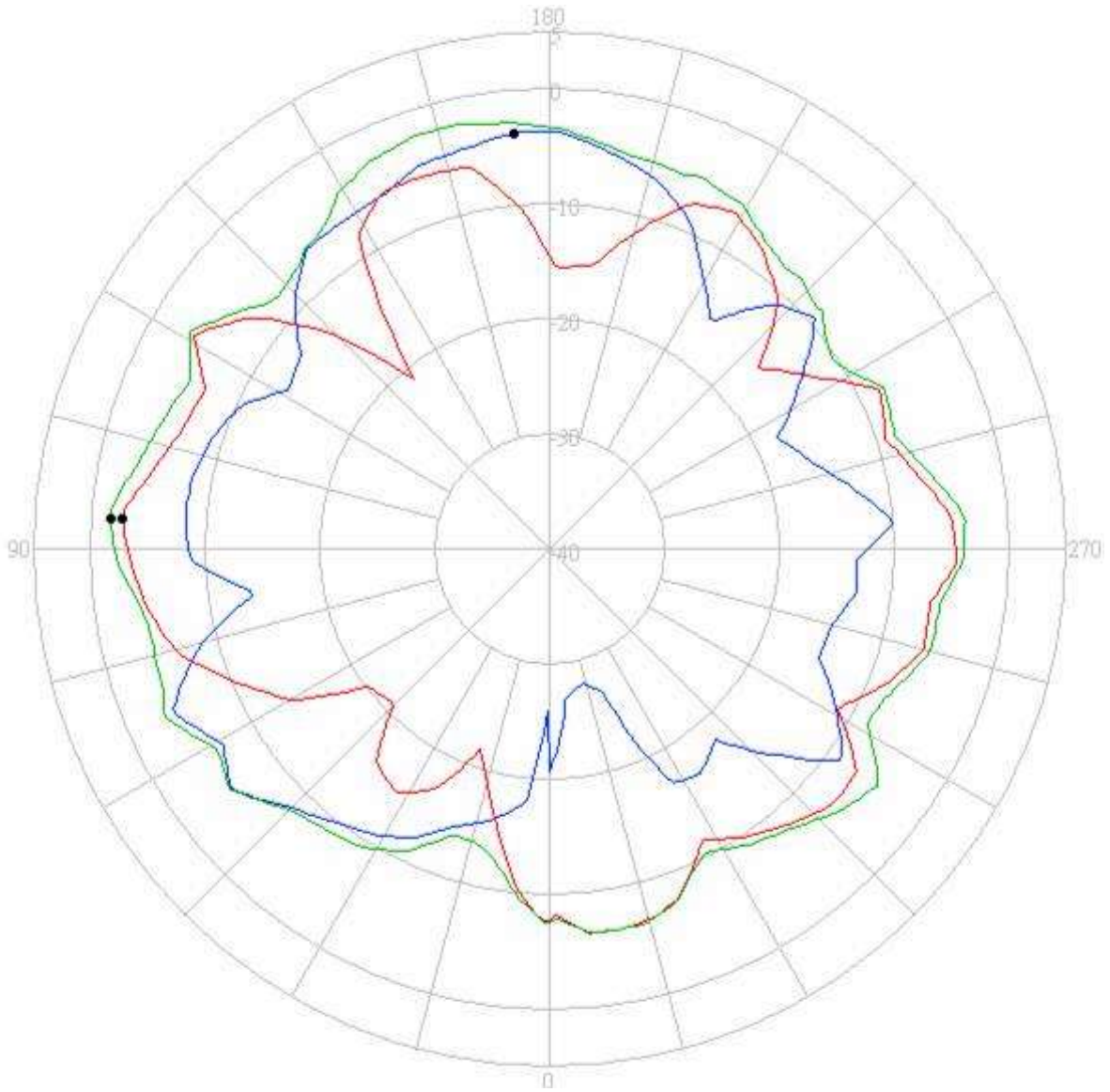

- Horizontal
- Vertical
- H + V

Center Frequency	5850 MHz
Horizontal (dBi) Peak	-3.65
Vertical (dBi) Peak	-2.66

WLAN_Aux Antenna antenna: 5725 MHz

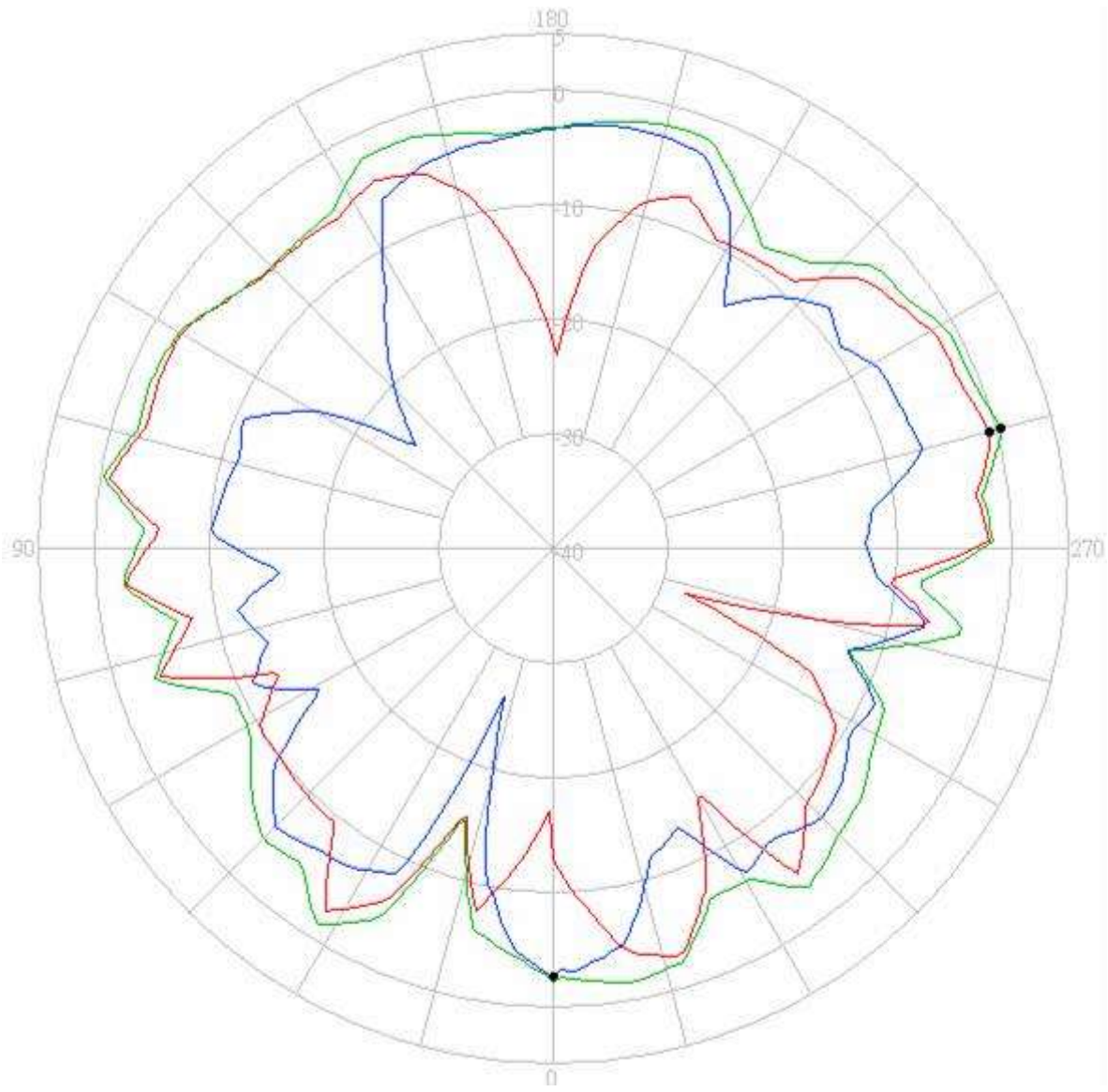

- Horizontal
- Vertical
- H + V

Center Frequency	5725 MHz
Horizontal (dBi) Peak	-2.53
Vertical (dBi) Peak	-0.51

WLAN_Aux Antenna antenna: 5785 MHz

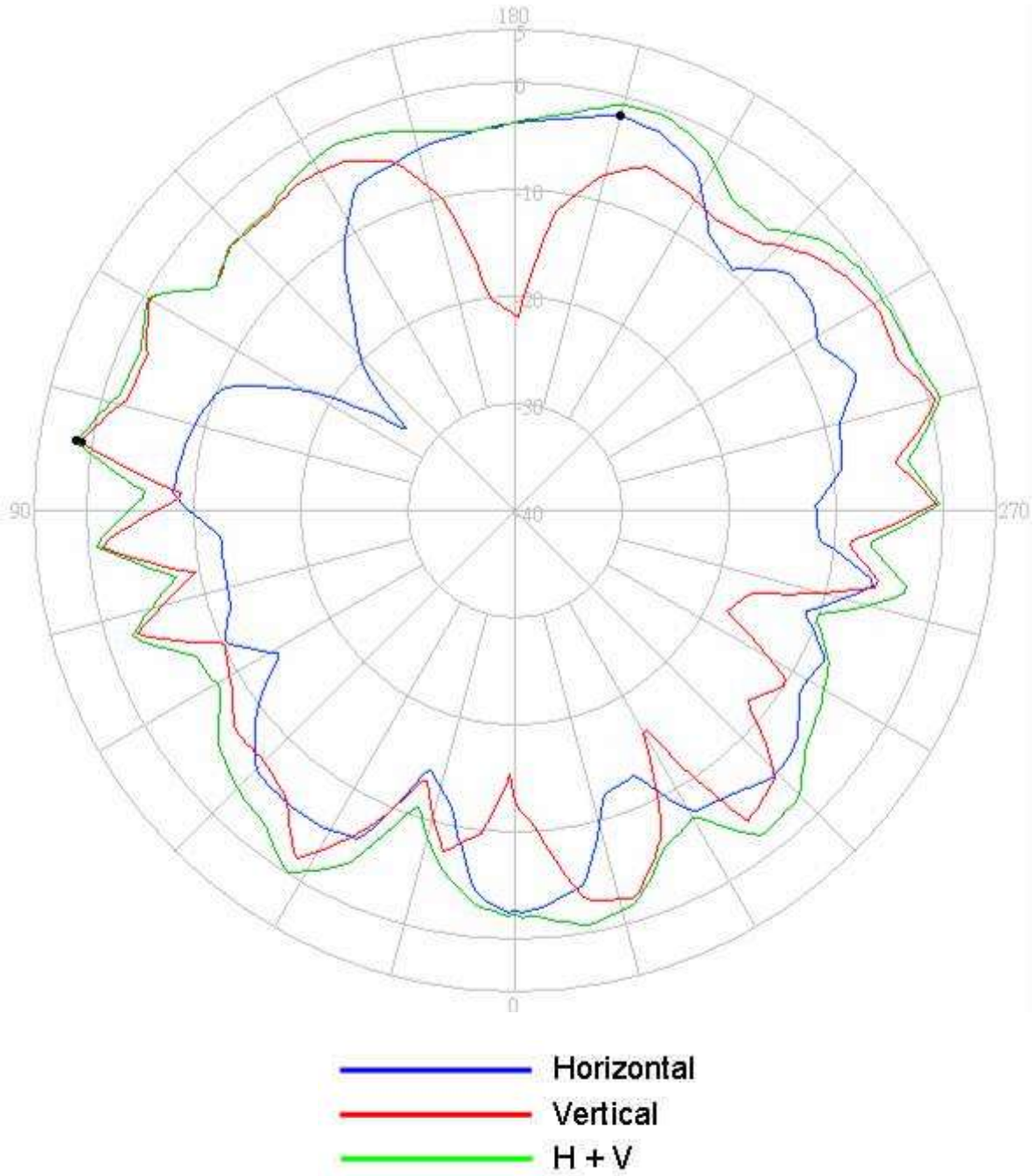

Center Frequency	5785 MHz
Horizontal (dBi) Peak	-1.82
Vertical (dBi) Peak	1.08

WLAN_Aux Antenna antenna: 5850 MHz

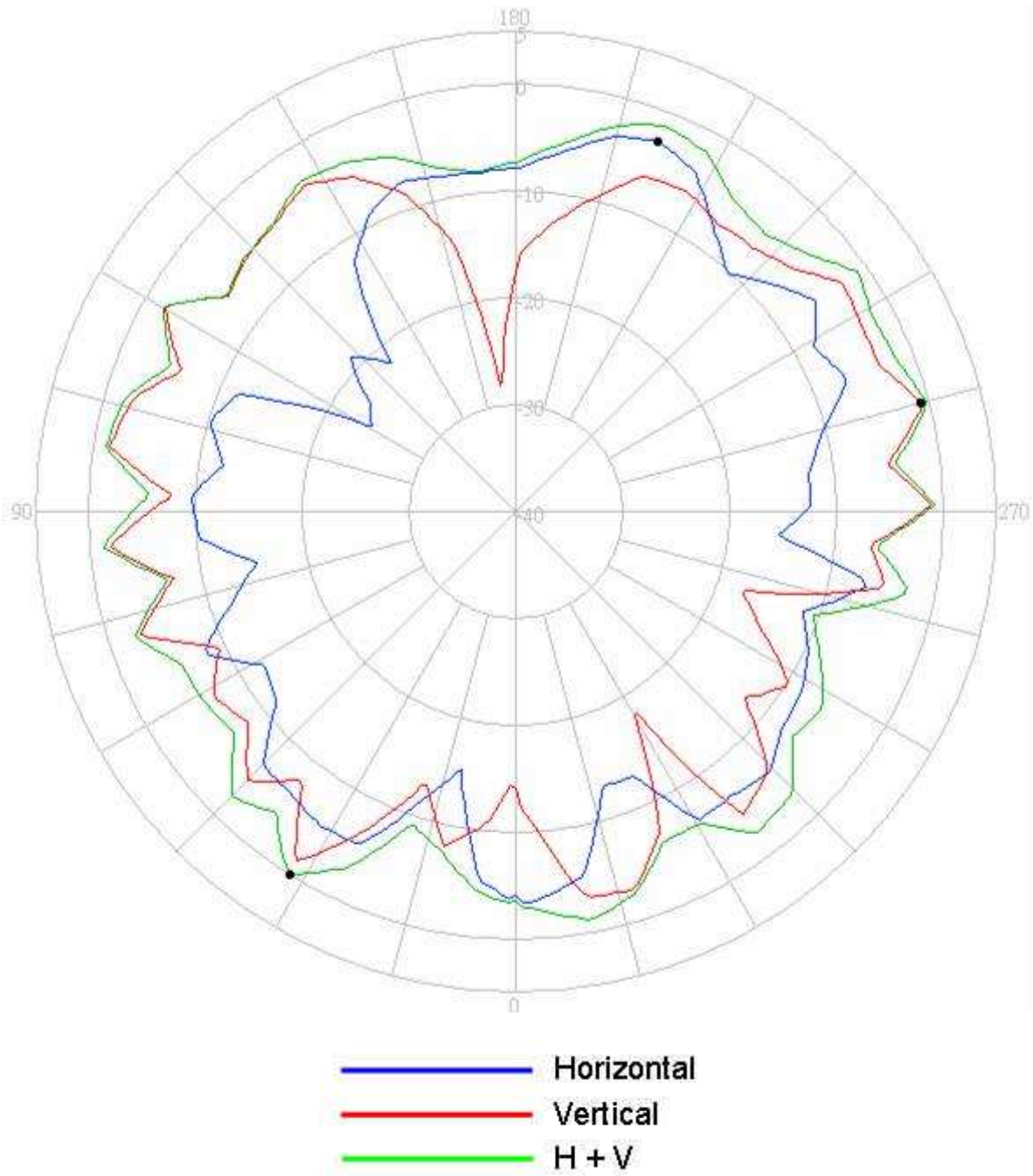

Center Frequency	5850 MHz
Horizontal (dBi) Peak	-2.85
Vertical (dBi) Peak	-0.69

MIMO Antenna antenna: 5725 MHz

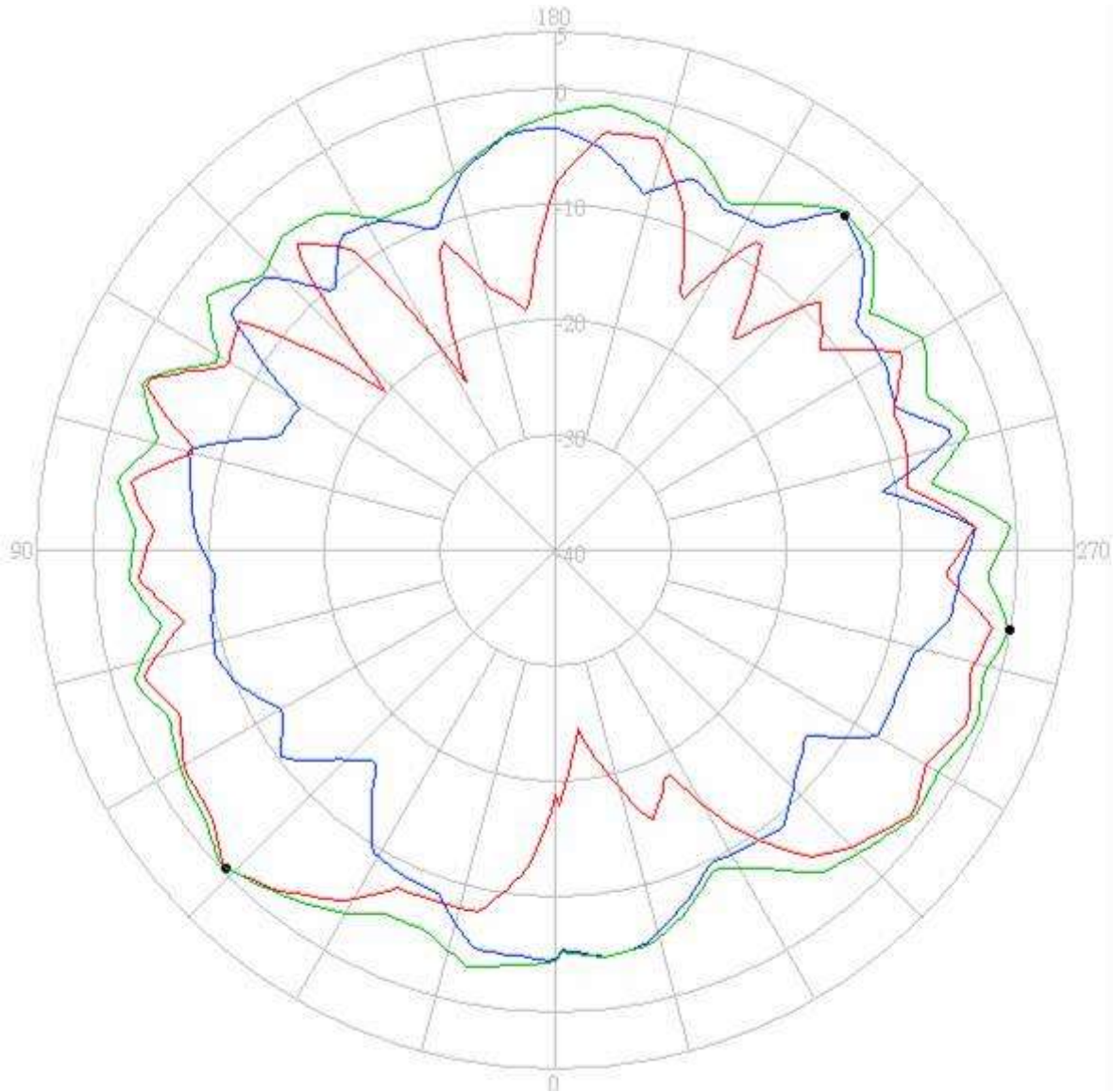

- Horizontal
- Vertical
- H + V

Center Frequency	5725 MHz
Horizontal (dBi) Peak	-1.58
Vertical (dBi) Peak	-0.37

MIMO Antenna antenna: 5785 MHz

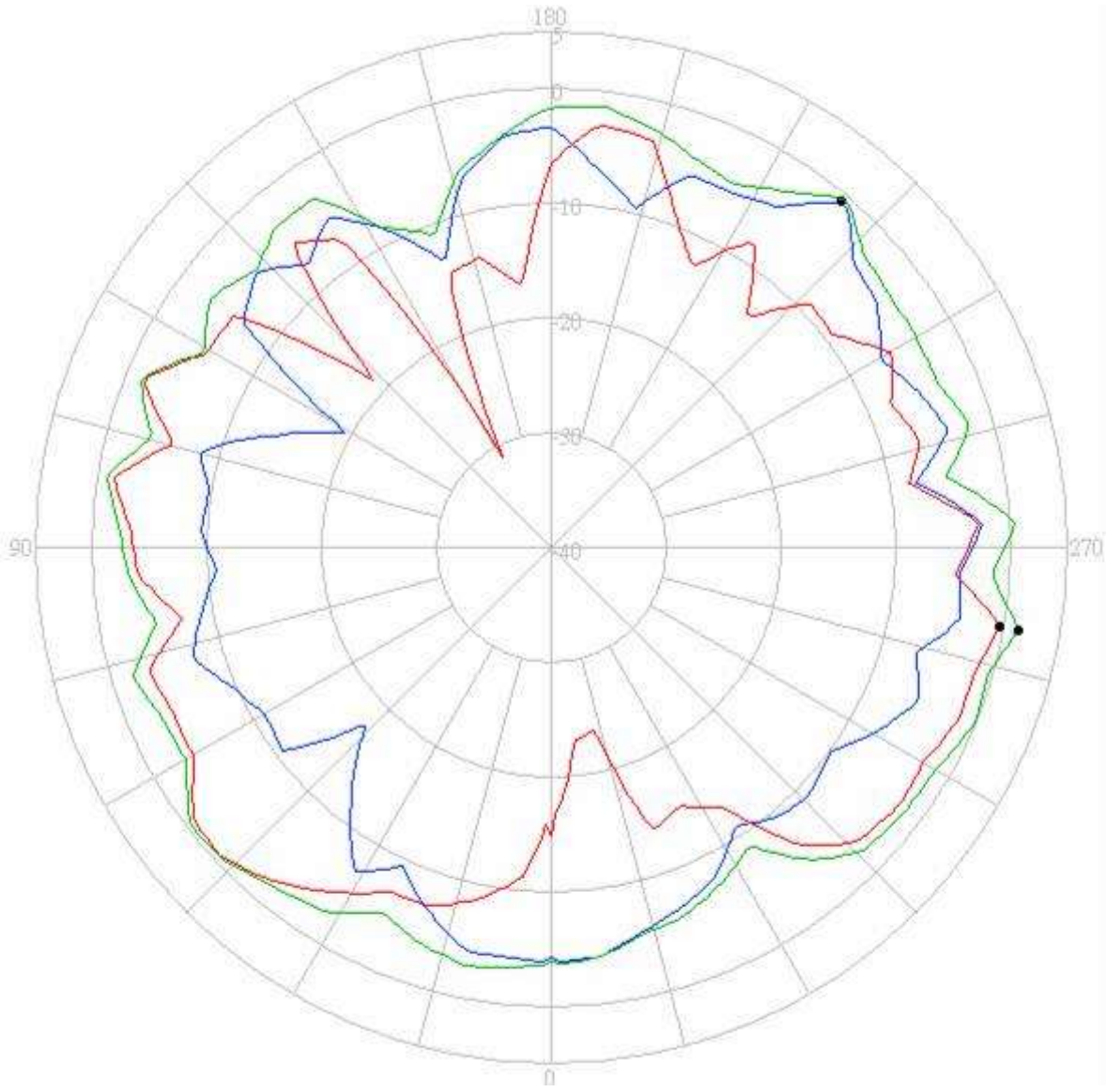

- Horizontal
- Vertical
- H + V

Center Frequency	5785 MHz
Horizontal (dBi) Peak	-0.65
Vertical (dBi) Peak	-0.31

MIMO Antenna antenna: 5850 MHz

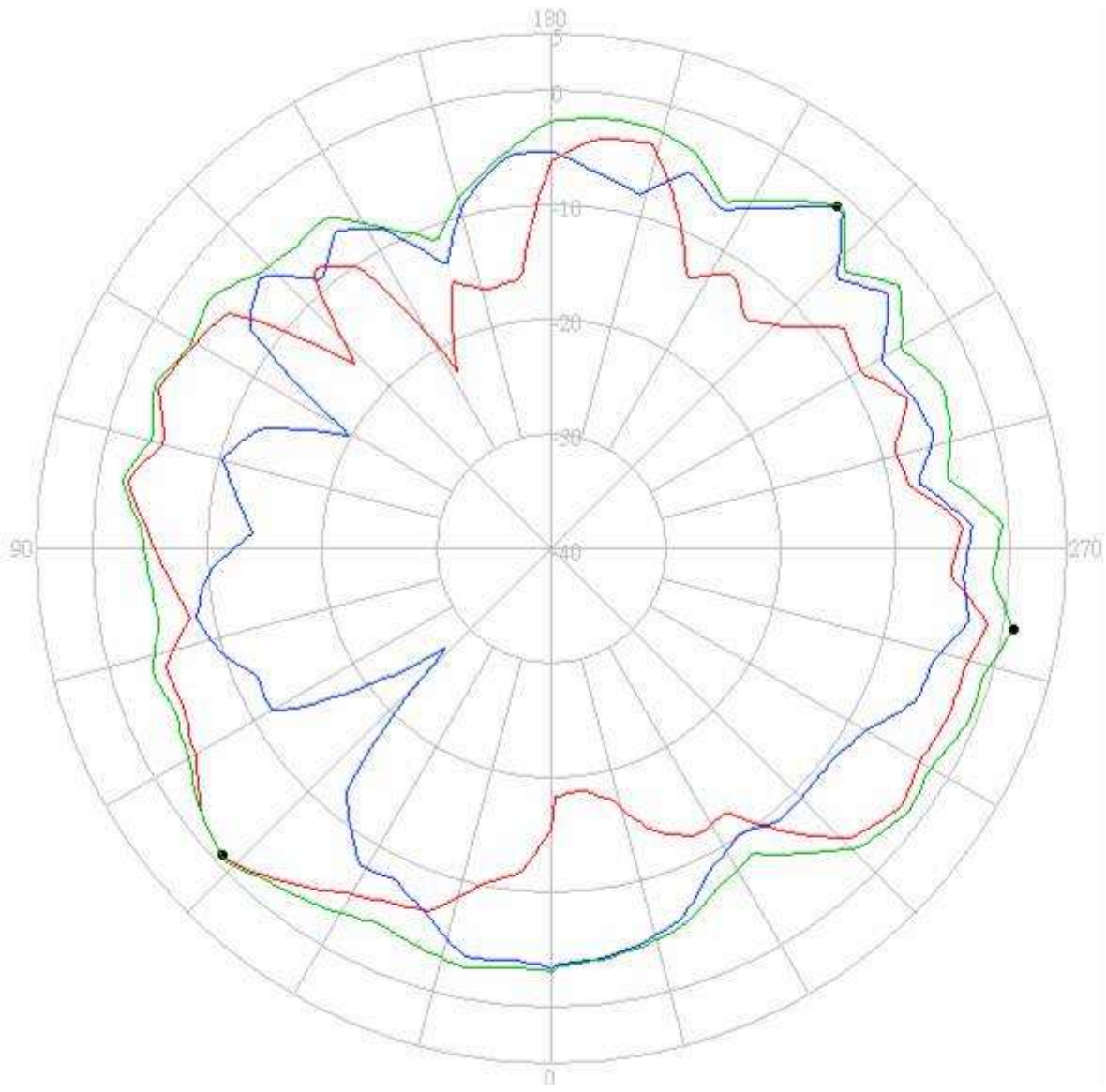

- Horizontal
- Vertical
- H + V

Center Frequency	5850 MHz
Horizontal (dBi) Peak	-1.04
Vertical (dBi) Peak	-0.63

Section 4. Host Platform Information

OEM / ODM Host platform: AMG Non_bump (PC Mode) platform correlated to antenna data

Rating Label Photo:

Section 5. Antenna Host Platform Location Information

Include a **dimensioned photo** or **dimensioned drawing** of WLAN_Main Antenna, WLAN_Aux Antenna and MIMO Antenna placements (measurements are not required for receive-only antenna).

Any antenna that transmits must show dimensions to bottom of laptop.

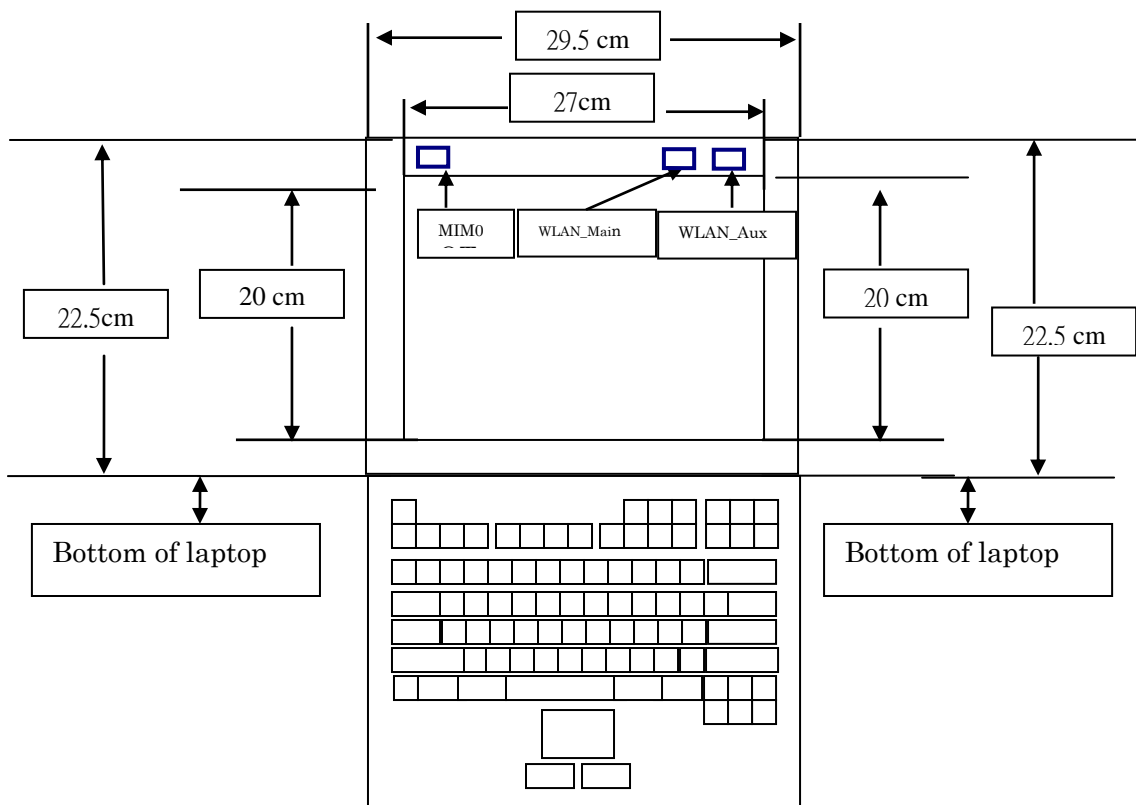

Section 6. Antenna dimensional information for SAR evaluation

Include a **dimensioned photo** or **dimensioned drawing** showing the distance (mm) between the transmit antennas and the user (excluding hands, wrist, feet, lap/ thigh, and ankle)

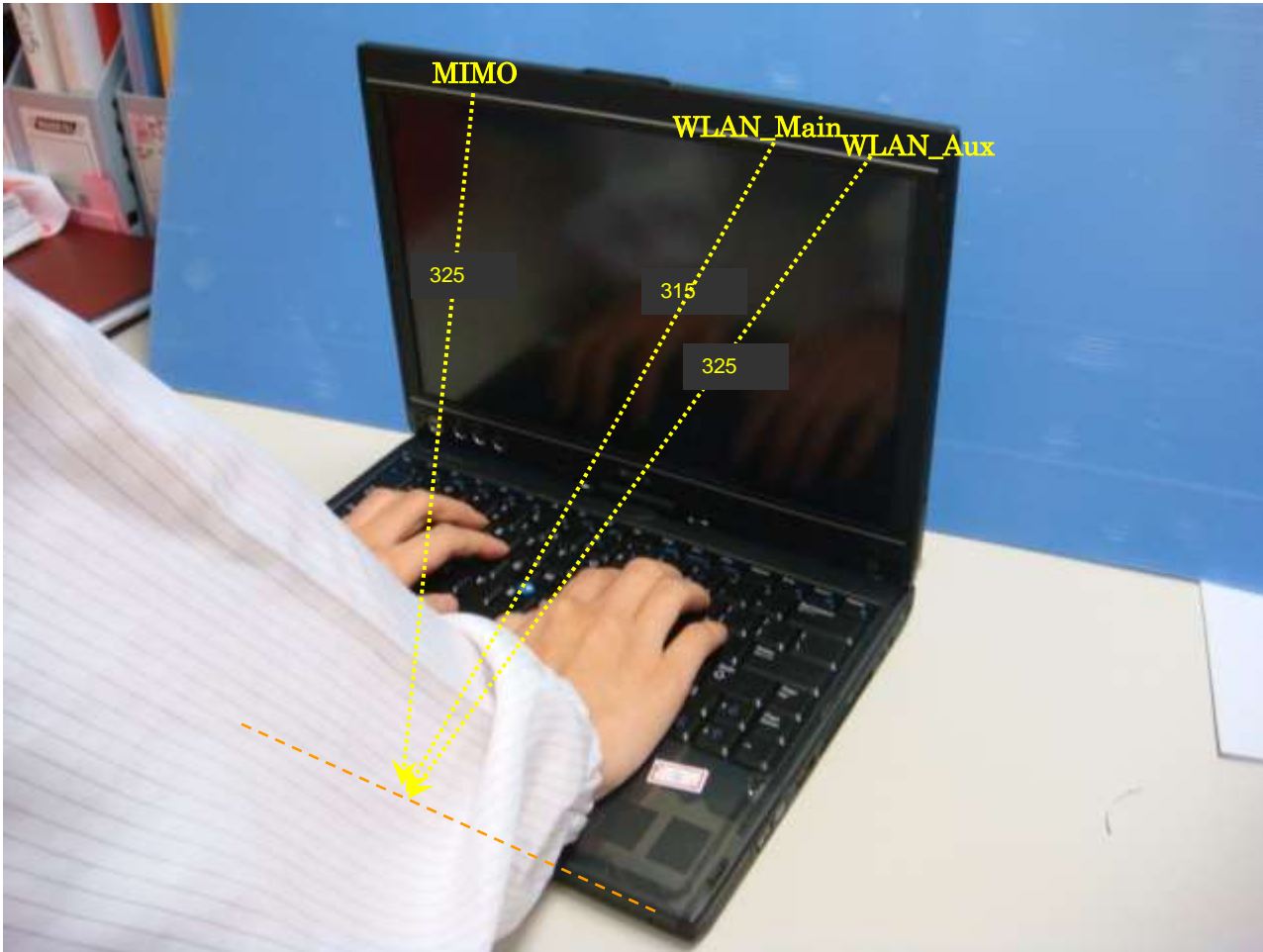

Section 7. Diagram Example of Co-Location Antenna Separation

Include a **dimensioned photo or dimensioned drawing** showing the distance (mm) between all WLAN transmit antennas and other co-located radiator transmit antenna such as Bluetooth, WWAN,..

(Note: Due to the evolving rules regarding co-location, each platform will need to be reviewed on a case by case basis)

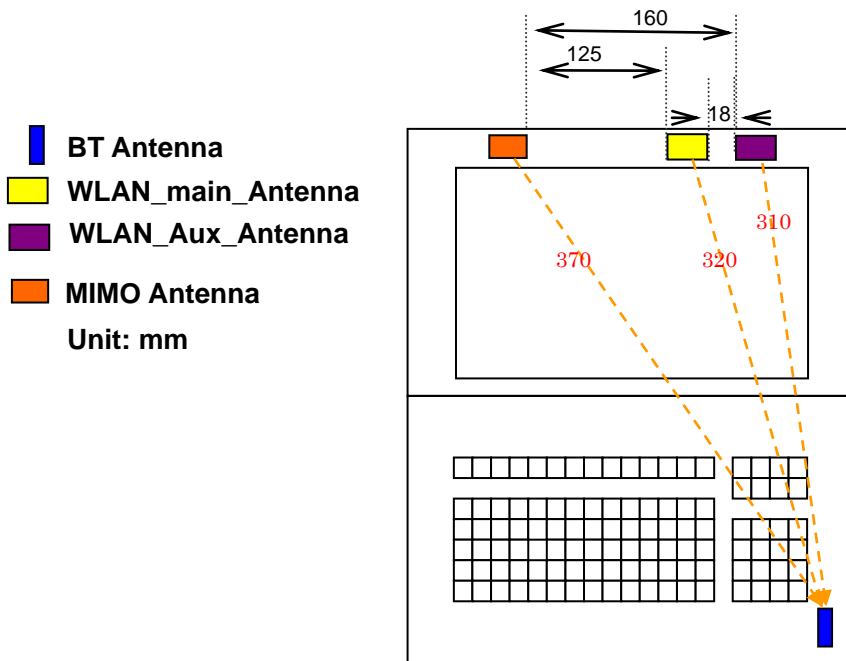

Section 8. Local representative contact information

Local representative contact information is required for regulatory support for target countries below.

	Local company name	Contact name	Phone number	FAX Number	e-Mail Address	Notes
Argentina						
Brazil						
Indonesia						
Israel						
Malaysia						
Mexico						
Singapore						Telecommunication Equipment Dealer License Required
South Africa						
USA, Canada						