

Regulatory WLAN Antenna Information

2.4/5GHz Mini Cooper Series Multiple Band Antennas with Cable & Connector For IEEE802.11 a/g/n

(English Language Required for Intel Regulatory Review / Approval)

Platform	
Platform Owner	Compal Inc.
Brand Name	Dell
Model Name	Mini Cooper
ODM	
Target Launch Date	(YYYY/ MM/ DD)
Antenna	
Brand Name	Tyco Electronics
Part Number	<input checked="" type="checkbox"/> Tx1 Antenna: 2023987-1
	<input checked="" type="checkbox"/> Tx2 (or Rx2) Antenna (Rx2 for 512 family ONLY) 2023986-1
	<input checked="" type="checkbox"/> Tx3 (or Rx3) Antenna (Rx3 for 4965AGN ONLY) 2023987-1
Module	
With WLAN Module	
(Check Box)	
	<input type="checkbox"/> 533ANX Family
	<input type="checkbox"/> 512ANX Family
	<input type="checkbox"/> 533AN Family
	<input type="checkbox"/> 512AN Family

Antenna Sample / Antenna Data Requirements for worldwide regulatory approval

Section	Description of Required OEM / ODM Antenna Information	US / IC	EU	Japan	Taiwan	S.Korea
1A	Part Number for Antenna only	Required	Required	Required	Required	Required
1B	Antenna Manufacturer Name	Required	Required	Required	Required	Required
1C	Description of Antenna Type	Required	N/A	N/A	N/A	N/A
1D	Part number of Antenna Assembly / cable impedance, length & diameter.	Required	Desired	Desired	Desired	Desired
1E	Tx1, Tx2 & Tx3 antenna (Peak Gain W/ cable loss) *	Required	Required	Required	Required	Required
	1E OR 1F, 1G, 1H					
1F	Tx1, Tx2 & Tx3 antenna (Peak Gain only) *	Required	Required	Required	Required	Required
1G	VSWR of cable including connector	Required	Required	Required	Required	Required
1H	Tx1, Tx2 & Tx3 antenna (Cable loss W/ connector) *	Required	Required	Required	Required	Required
2	Dimensioned Photographs <u>and</u> Drawings of Tx1, Tx2, and Tx3 (or Rx3) antennas	Required	Required	Required	Required	Required
3	Radiation patterns of antennas loaded in the host platform.	Required	Desired	Required	N/A	Required
4	Platform model name / number - correlated to antenna manufacturer and antenna part number	Required	Required	Desired	Required	Desired
5	Photograph(s) or Drawings showing location of antennas in platform. <u>(S. Korea requires photographs of antennas for approval submission). Taiwan requires pictures of each antenna type shown in the system.</u>	Required	Required	Desired	<u>Required (Photos)</u>	<u>Required (Photos)</u>
6	Mech. drawings / photos with dimensions of antenna locations and distance from end-user (For evaluation of SAR testing requirement).	Required	N/A	N/A	N/A	N/A
7	Photograph(s) or Drawings showing the location of all antennas (WLAN, other) and distance between those transmitting antennas. Information will be used to evaluate whether co-location testing is required.	Required	N/A	N/A	N/A	N/A
8	Local representative contact information for LMA/ PARS process.	Required	N/A	N/A	N/A	N/A

NOTE:

(*) if 3rd antenna is Rx only (e.g. receive only for 4965AGN) then peak gain and cable loss not required

Antenna Information

Section 1. Antenna Assembly Specifications

Antenna Assembly Summary:

1A Antenna Part Number	1B Manufacture	1C Antenna Type	1D Cable Assembly Part Number and Information	1E *Peak Gain W/ Cable loss (dBi)	1F Peak Gain w/o Cable Loss (dBi)	1G VSWR	1H Cable Loss (dBi)
(P/N:2023987-1) Tx1 antenna	Example: TYCO Corporation	Example: PIFA	Example: (P/N: U.FL-2LP-XXX) 50 ohm Coaxial. length: 46.5cm diameter: 1.1mm Connector: U.FL	2400-2500MHz -2.2 dBi (peak) *	2400-2500MHz -1 dBi (peak) *	2400-2500MHz 1.35 max *	2400-2500MHz 1.2 dBi (peak) *
				2496-2690MHz -2.06 dBi (peak) *	2496-2690MHz -0.81 dBi (peak) *	2496-2690MHz 2.47 max *	2496-2690MHz 1.25 dBi (peak) *
				5150-5350MHz -0.83 dBi (peak) *	5150-5350MHz 0.93 dBi (peak) *	5150-5350MHz 1.47 max *	5150-5350MHz 1.76 dBi (peak) *
				5470-5725MHz -1.18 dBi (peak) *	5470-5725MHz 0.63 dBi (peak) *	5470-5725MHz 2.08 max *	5470-5725MHz 1.81 dBi (peak) *
				5725-5850MHz -2.88 dBi (peak) *	5725-5850MHz -0.98 dBi (peak) *	5725-5850MHz 2.71 max *	5725-5850MHz 1.9 dBi (peak) *
(P/N: 2023986-1) Tx2 (or Rx2 for 512 family) antenna	Example: TYCO Corporation	Example: PIFA	Example: (P/N: U.FL-2LP-XXX) 50 ohm Coaxial. length:29,7cm diameter: 1.1mm Connector: U.FL	2400-2500MHz -0.98 dBi (peak) *	2400-2500MHz -0.21dBi (peak) *	2400-2500MHz 2.21 max	2400-2500MHz 0.77 dBi (peak) *
				2496-2690MHz -0.69 dBi (peak) *	2496-2690MHz 0.11 dBi (peak) *	2496-2690MHz 1.84 max	2496-2690MHz 0.8dBi (peak) *
				5150-5350MHz -0.04 dBi (peak) *	5150-5350MHz 1.08 dBi (peak) *	5150-5350MHz 1.88 max	5150-5350MHz 1.12 dBi (peak) *
				5470-5725MHz 0.71 dBi (peak) *	5470-5725MHz 1.86 dBi (peak) *	5470-5725MHz 2.05 max	5470-5725MHz 1.15 dBi (peak) *
				5725-5850MHz 0 dBi (peak) *	5725-5850MHz 1.21 dBi (peak) *	5725-5850MHz 2.84 max	5725-5850MHz 1.21dBi (peak) *
(P/N: 2023987-1) Tx3 (or Rx3 for 512 family) antenna	Example: TYCO Corporation	Example: PIFA	Example: (P/N: U.FL-2LP-XXX) 50 ohm Coaxial. length: 53.4cm diameter: 1.1mm Connector: U.FL	2400-2500MHz -2.16 dBi (peak) *	2400-2500MHz -0.7 dBi (peak) *	2400-2500MHz 2.05 max *	2400-2500MHz 1.43 dBi (peak) *
				2496-2690MHz 0.08 dBi (peak) *	2496-2690MHz 1.53 dBi (peak) *	2496-2690MHz 2.07 max *	2496-2690MHz 1.45 dBi (peak) *
				5150-5350MHz 1.15 dBi (peak) *	5150-5350MHz 3.18dBi (peak) *	5150-5350MHz 1.62 max *	5150-5350MHz 2.03 dBi (peak) *
				5470-5725MHz -2.13 dBi (peak) *	5470-5725MHz -0.02 dBi (peak) *	5470-5725MHz 1.58 max *	5470-5725MHz 2.11 dBi (peak) *
				5725-5850MHz -0.49 dBi (peak) *	5725-5850MHz 1.7 dBi (peak) *	5725-5850MHz 1.63 max *	5725-5850MHz 2.19 dBi (peak) *

NOTE:

(* If Rx2/Rx3 only (2nd or 3rd antenna receives only, e.g. for 512 family & 4965AGN) then the information marked with * is not required

Antenna Peak Gain Table:

Frequency (MHz)	Tx1 antenna		Tx2 (or Rx2) Antenna		Tx3 (or Rx3) Antenna	
	Horizontal (dBi)	Vertical (dBi)	Horizontal (dBi)	Vertical (dBi)	Horizontal (dBi)	Vertical (dBi)
2400	-4.95	-3.04	-1.7	-1.75	-5.62	-3.57
2450	-4.23	-3.03	-1.61	-1.45	-4.23	-2.18
2500	-3.21	-2.2	-1.7	-0.98	-2.82	-2.16
2501	-3.94	-2.06	-1.18	-0.69	-2.95	0.08
2593	-3.07	-4.2	-2.61	-3.26	-2.83	-0.22
2685	-5.01	-4.94	-5.15	-4.35	-2.8	-0.57
5150	-1.12	-2.77	-2.59	-0.89	0.32	-0.99
5250	-0.83	-2.41	-1.75	-1.78	1.15	-1.2
5350	-1.26	-3.86	-2.17	-0.04	0.7	-0.66
5470	-1.82	-4.33	-4.25	0.71	-3.9	-2.73
5600	-1.18	-4.02	-4.23	-1.54	-4.96	-2.15
5725	-3.59	-5.08	-3.83	0	-4.93	-2.13
5785	-3.48	-3.03	-4.26	-2.56	-0.49	-0.65
5850	-2.88	-4.31	-4.15	-1.45	-1.75	-1.78

- Antenna Peak Gain required being test in system basis.
- 1E frame contend absolutely peak antenna gain include H/V
- If Rx2 only (2nd antenna receives only, e.g. for 512 family) then the information is not required for Rx2.
- If Rx3 only (3rd antenna receives only, e.g. for 4965AGN) then the information is not required for Rx3.

Section 2. Dimensioned Photos or Drawings of Antennas

Include a dimensioned photo and dimensioned drawing of Tx1 antenna here.

Tx1 Antenna Dimensioned Drawing:

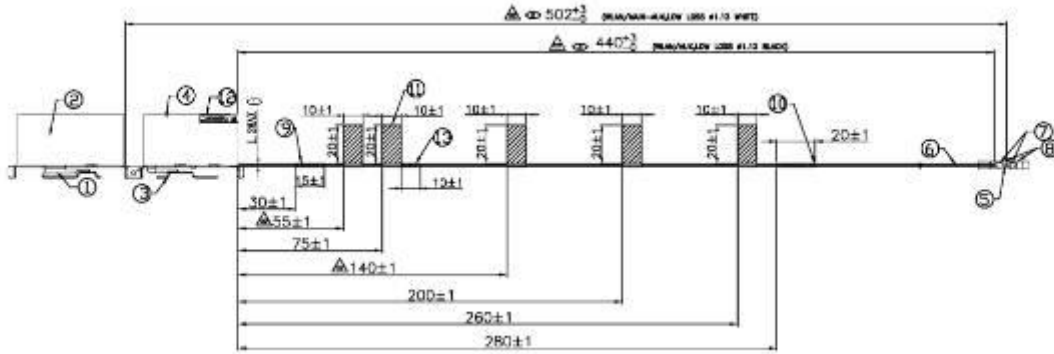

Tx1 Antenna Photo:

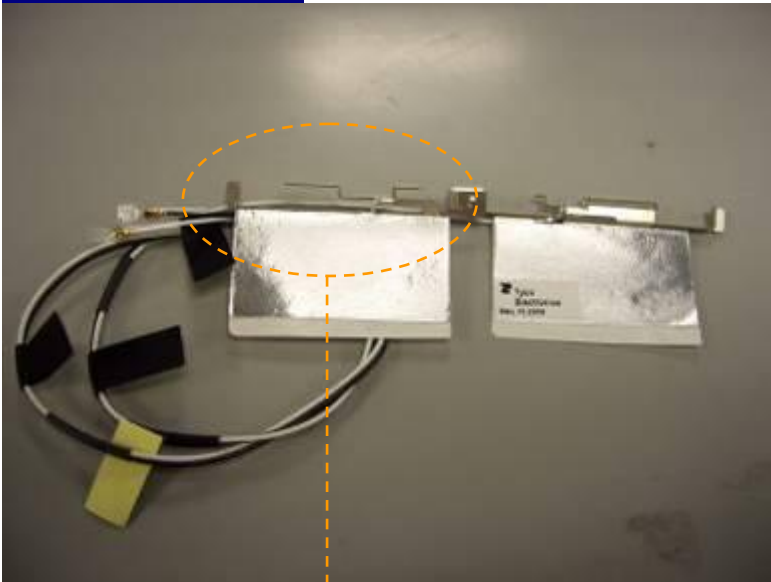

TX1
antenna

Include a dimensioned photo and dimensioned drawing of Tx2 (or Rx2) antenna here.

Tx2 (or Rx2) Antenna Dimensioned Drawing:

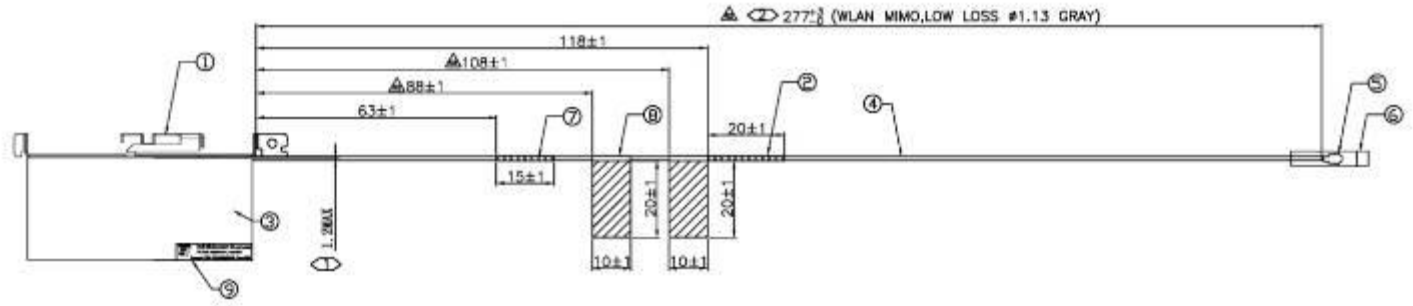

Tx2 (or Rx2) Antenna Photo:

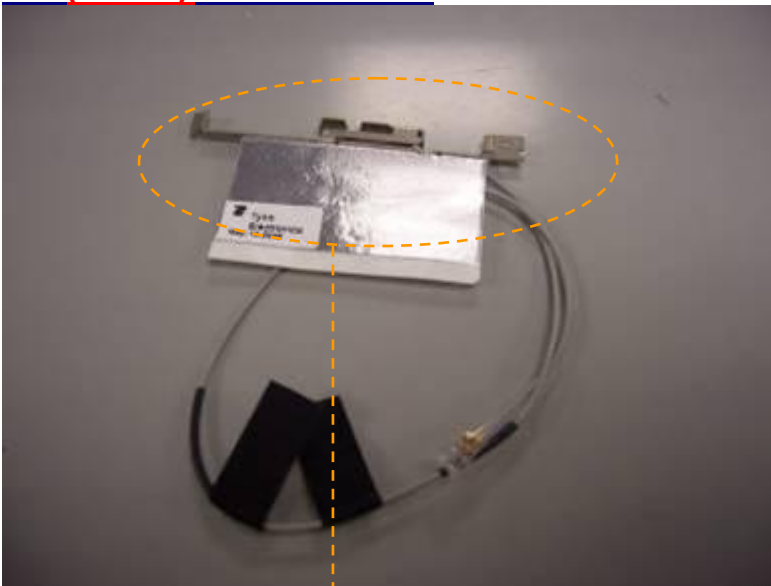

Tx2 antenna

Include a dimensioned photo and dimensioned drawing of Tx3 (or Rx3) antenna here.

Tx3 (or Rx3) Antenna Dimensioned Drawing:

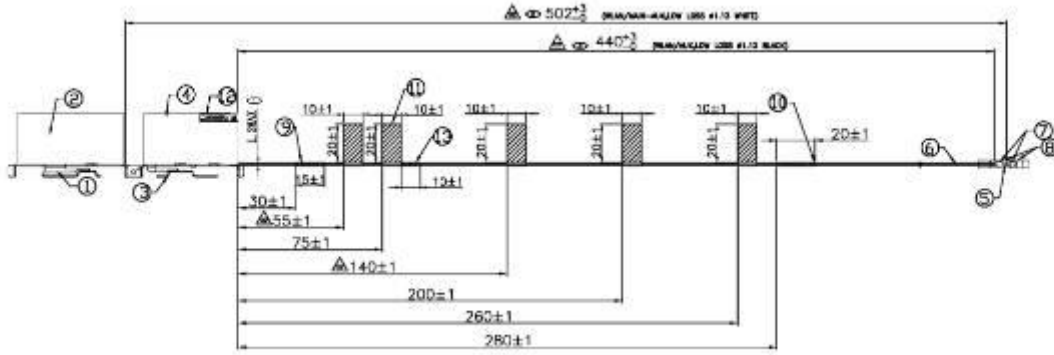

Tx3 (or Rx3) Antenna Photo:

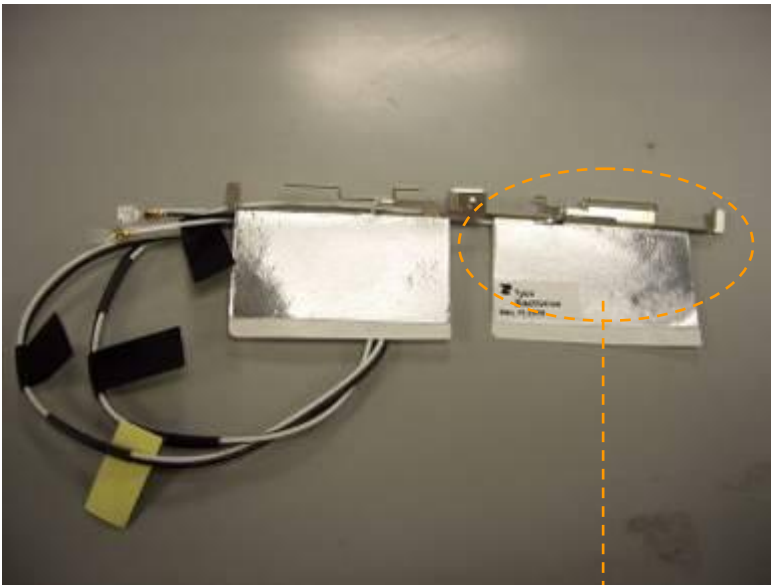

TX3 antenna

Include front view photo of all 3 antennas here.

Antenna Manufacturer: TYCO

Antenna Part Number: 2023987 (Tx1), 2023986 (Tx2 or Rx2),



Include back view photo of all 3 antennas here.

Antenna Manufacturer: TYCO

Antenna Part Number: 2023987 (Tx1), 2023986 (Tx2 or Rx2),

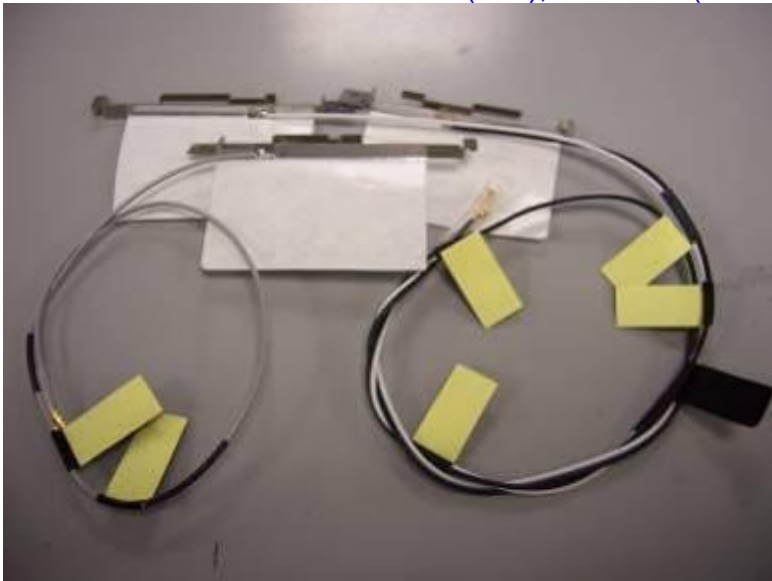

Section 3. Radiation characteristics of antennae Loaded in Host Platform

2400-2500MHz radiation characteristic

TX1 antenna: 2400 MHz

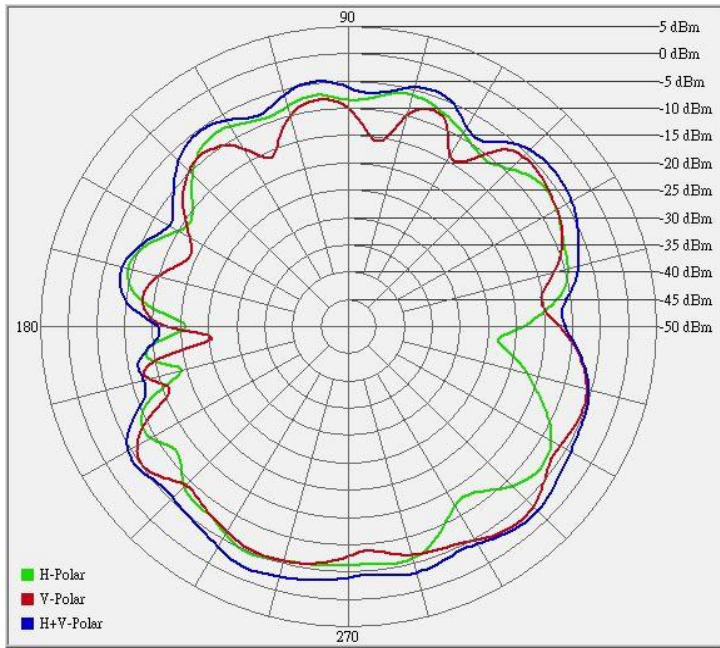

Center Frequency	2400 MHz
Horizontal (dBi) peak	-4.95
Vertical (dBi) peak	-3.04

TX1 antenna: 2450 MHz

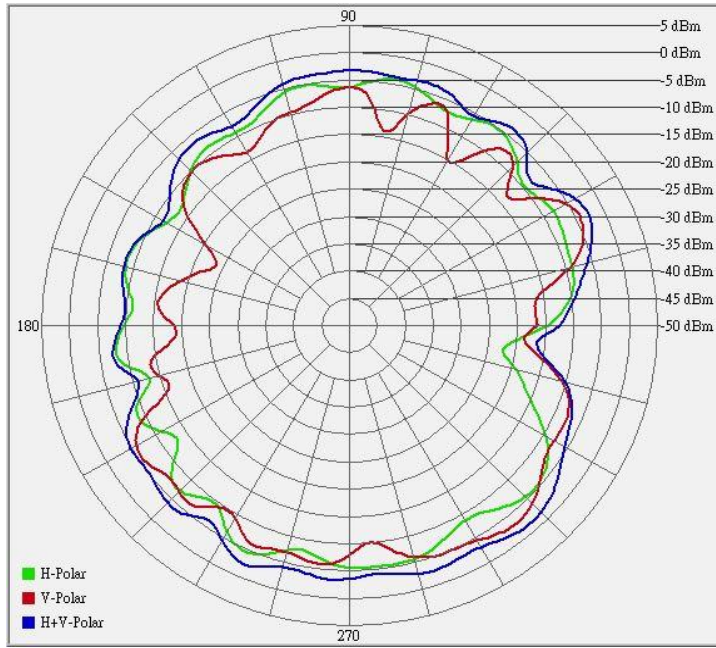

Center Frequency	2450 MHz
Horizontal (dBi) peak	-4.23
Vertical (dBi) peak	-3.03

TX1 main antenna: 2500 MHz

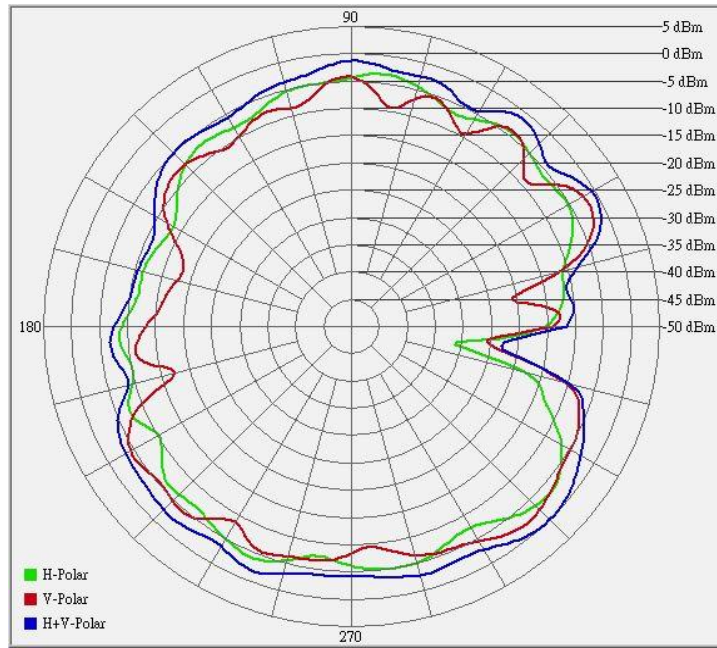

Center Frequency	2500 MHz
Horizontal (dBi) peak	-3.21
Vertical (dBi) peak	-2.2

Tx2 (or Rx2) antenna: 2400 MHz (Plot is not required if 2nd Antenna is receive only e.g. Rx2 for 512 family)

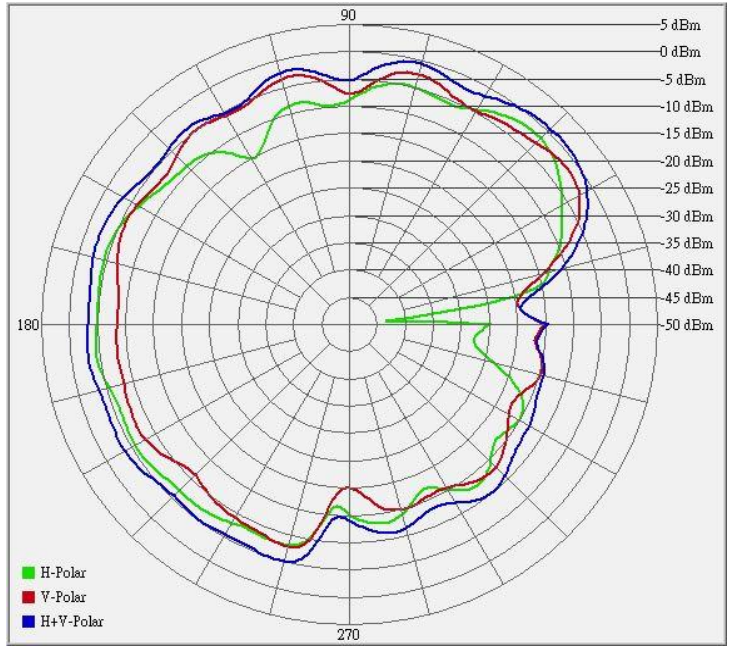

Center Frequency	2400 MHz
Horizontal (dBi) peak	-1.7
Vertical (dBi) peak	-1.75

Tx2 (or Rx2) antenna: 2450 MHz (Plot is not required if 2nd Antenna is receive only e.g. Rx2 for 512 family)

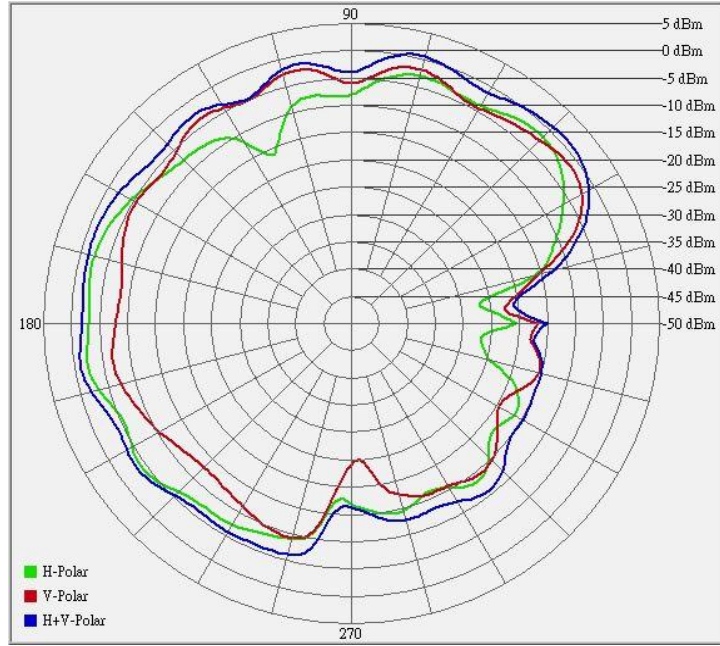

Center Frequency	2450 MHz
Horizontal (dBi) peak	-1.61
Vertical (dBi) peak	-1.45

Tx2 (or Rx2) antenna: 2500 MHz (Plot is not required if 2nd Antenna is receive only e.g. Rx2 for 512 family)

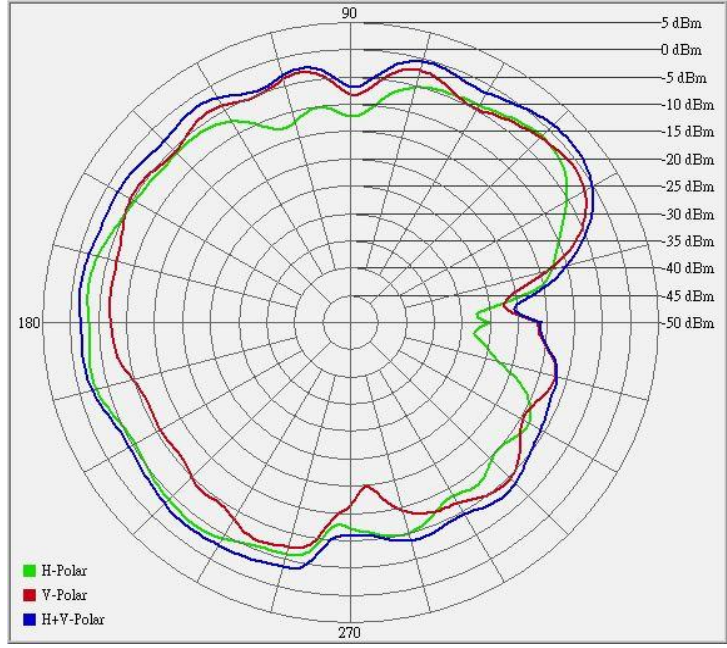

Center Frequency	2500 MHz
Horizontal (dBi) peak	-1.7
Vertical (dBi) peak	-0.98

Tx3 (or Rx3) antenna: 2400 MHz (Plot is not required if 3rd Antenna is receive only e.g. Rx3 for 4965AGN)

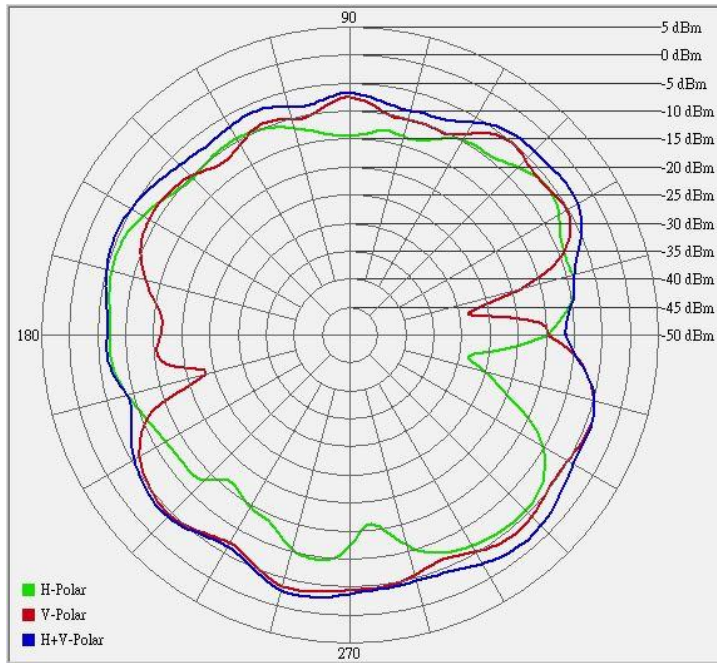

Center Frequency	2400 MHz
Horizontal (dBi) peak	-5.62
Vertical (dBi) peak	-3.57

Tx3 (or Rx3) antenna: 2450 MHz (Plot is not required if 3rd Antenna is receive only e.g. Rx3 for 4965AGN)

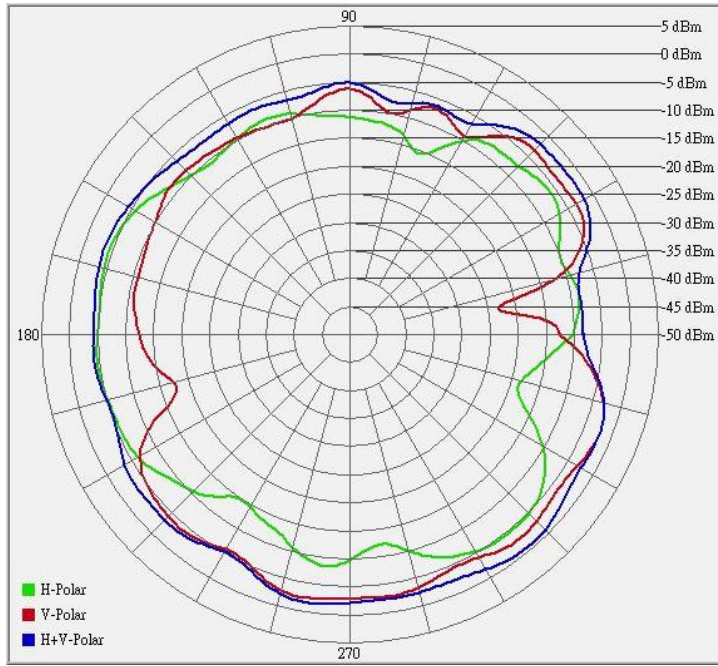

Center Frequency	2450 MHz
Horizontal (dBi) peak	-4.23
Vertical (dBi) peak	-2.18

Tx3 (or Rx3) antenna: 2500 MHz (Plot is not required if 3rd Antenna is receive only e.g. Rx3 for 4965AG)

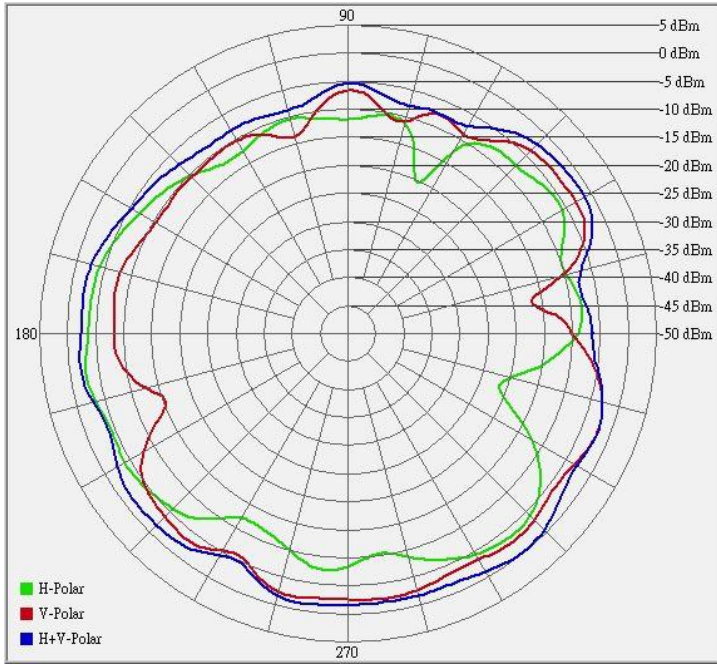

Center Frequency	2500 MHz
Horizontal (dBi) peak	-2.82
Vertical (dBi) peak	-2.16

2490-2700MHz radiation characteristic
TX1 antenna: 2501MHz

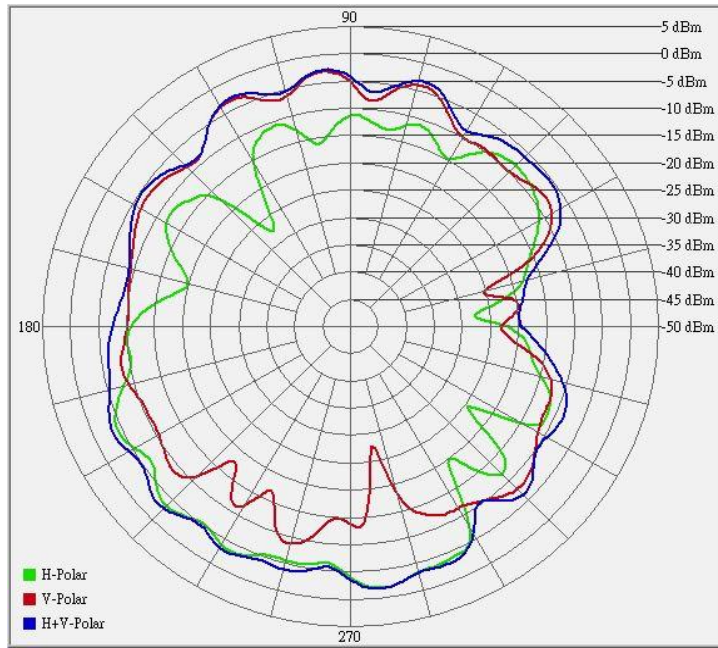

Center Frequency	2501 MHz
Horizontal (dBi) peak	-3.94
Vertical (dBi) peak	-2.06

TX1 antenna: 2593MHz

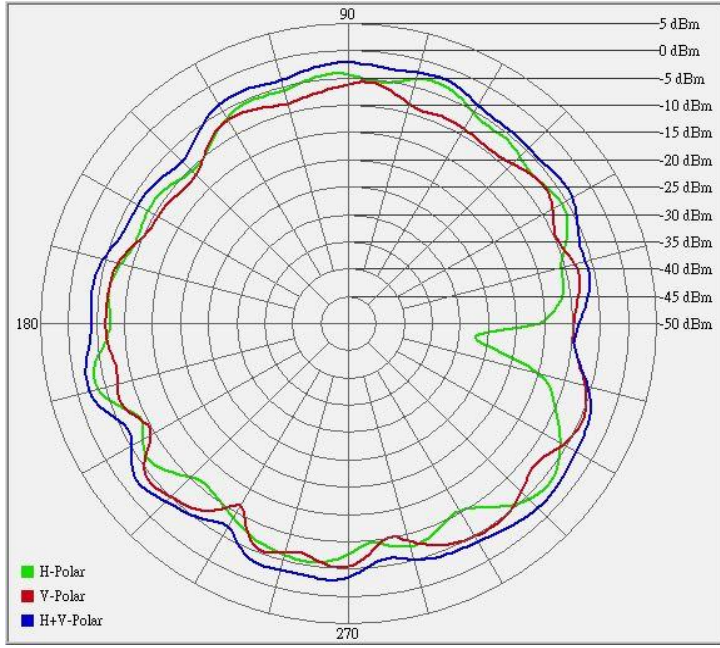

Center Frequency	2593 MHz
Horizontal (dBi) peak	-3.07
Vertical (dBi) peak	-4.2

TX1 antenna: 2683 MHz

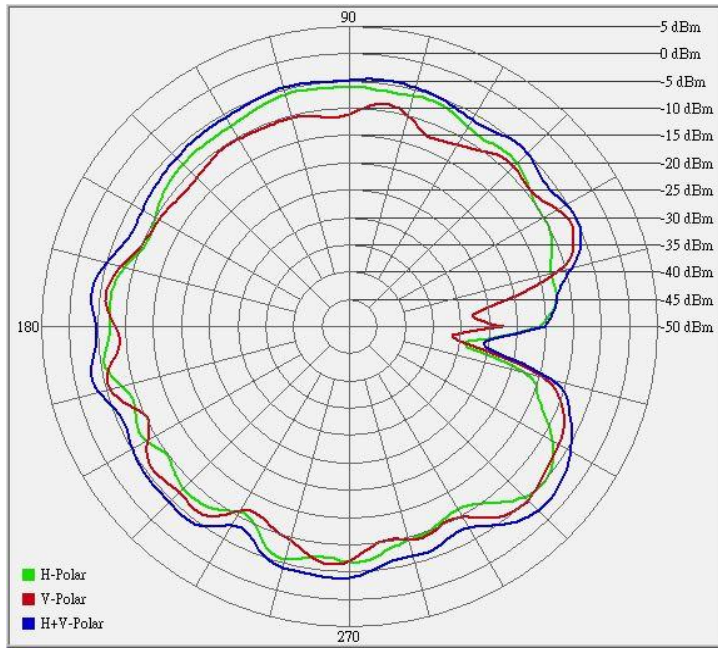

Center Frequency	2685 MHz
Horizontal (dBi) peak	-5.01
Vertical (dBi) peak	-4.94

Tx2 (or Rx2) antenna: 2501MHz (Plot is not required if 2nd Antenna is receive only e.g. Rx2 for 512 family)

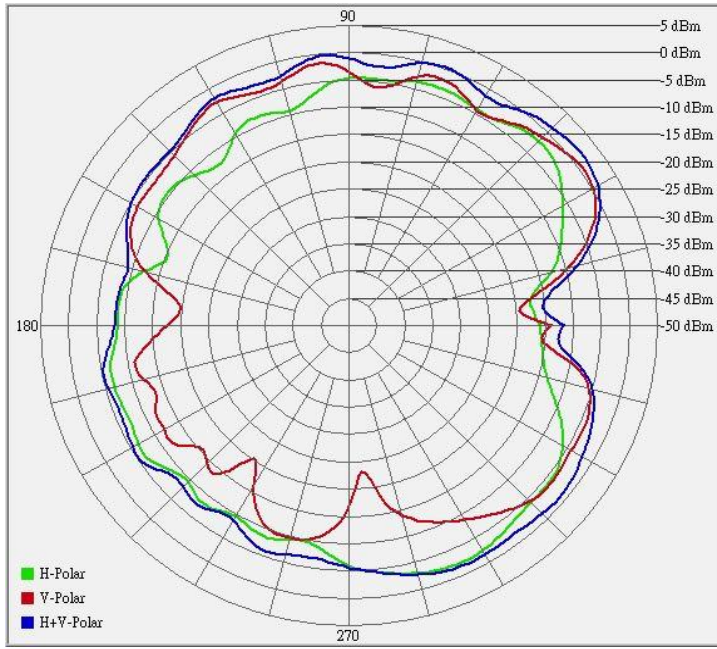

Center Frequency	2501 MHz
Horizontal (dBi) peak	-1.18
Vertical (dBi) peak	-0.69

Tx2 (or Rx2) antenna: 2593MHz (Plot is not required if 2nd Antenna is receive only e.g. Rx2 for 512 family)

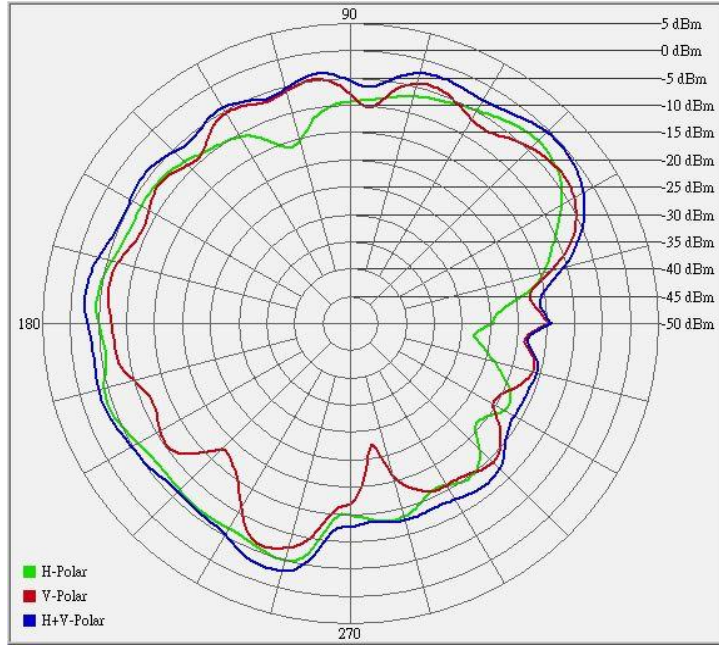

Center Frequency	2593 MHz
Horizontal (dBi) peak	-2.61
Vertical (dBi) peak	-3.26

Tx2 (or Rx2) antenna: 2685 MHz (Plot is not required if 2nd Antenna is receive only e.g. Rx2 for 512 family)

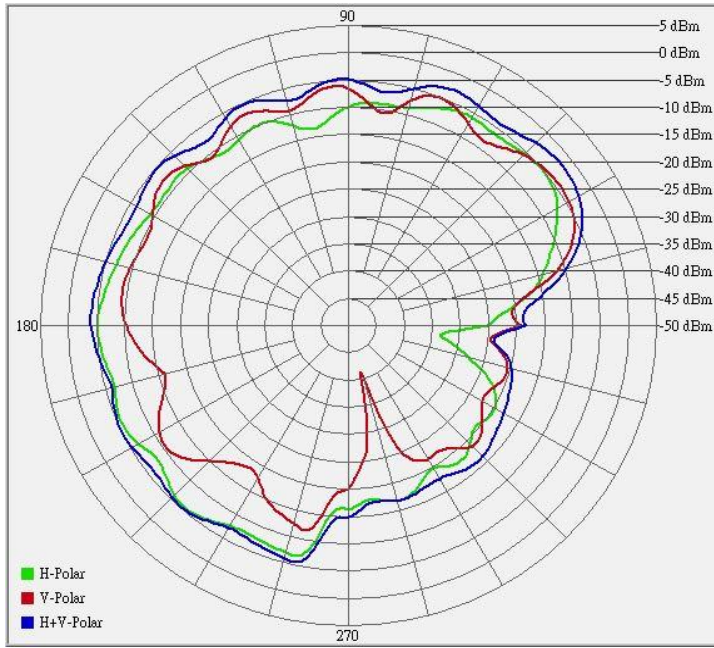

Center Frequency	2685 MHz
Horizontal (dBi) peak	-5.15
Vertical (dBi) peak	-4.35

Tx3 (or Rx3) antenna: 2501 MHz (Plot is not required if 3rd Antenna is receive only e.g. Rx3 for 4965AGN)

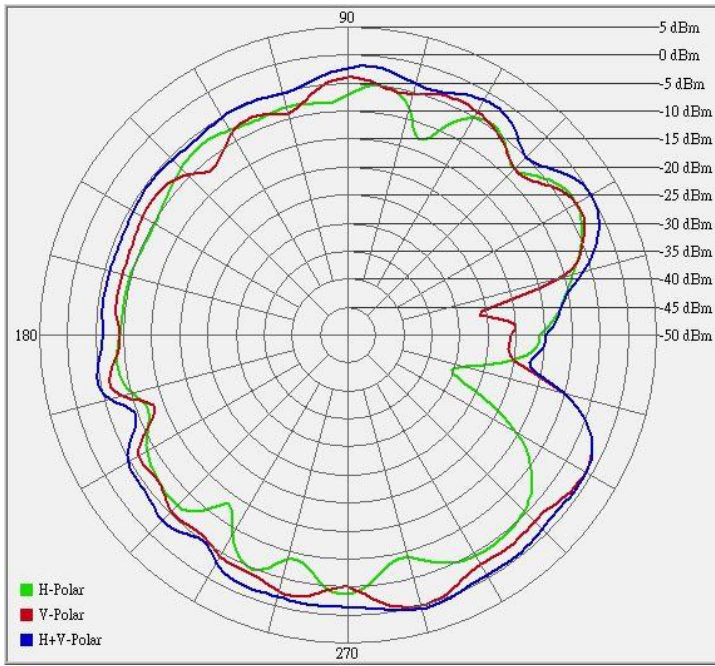

Center Frequency	2501 MHz
Horizontal (dBi) peak	-2.95
Vertical (dBi) peak	0.08

Tx3 (or Rx3) antenna: 2593MHz (Plot is not required if 3rd Antenna is receive only e.g. Rx3 for 4965AGN)

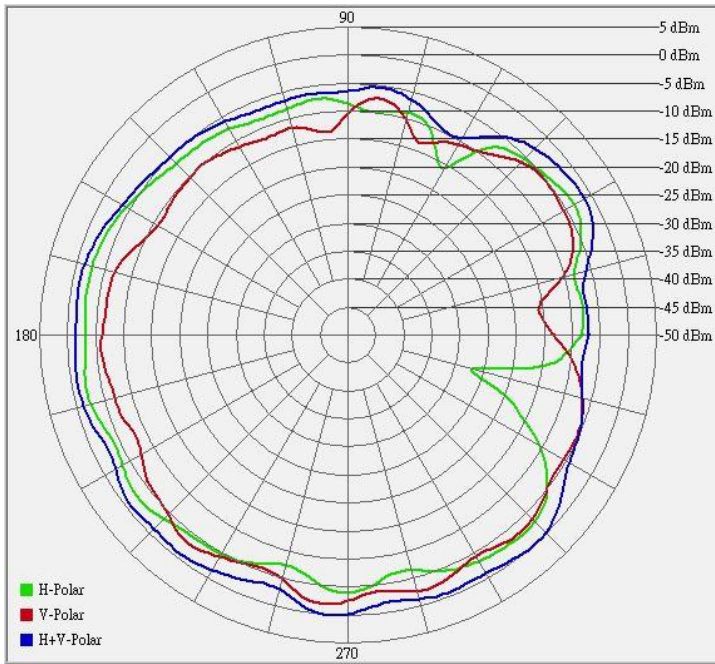

Center Frequency	2593 MHz
Horizontal (dBi) peak	-2.83
Vertical (dBi) peak	-0.22

Tx3 (or Rx3) antenna: 2685 MHz (Plot is not required if 3rd Antenna is receive only e.g. Rx3 for 4965AGN)

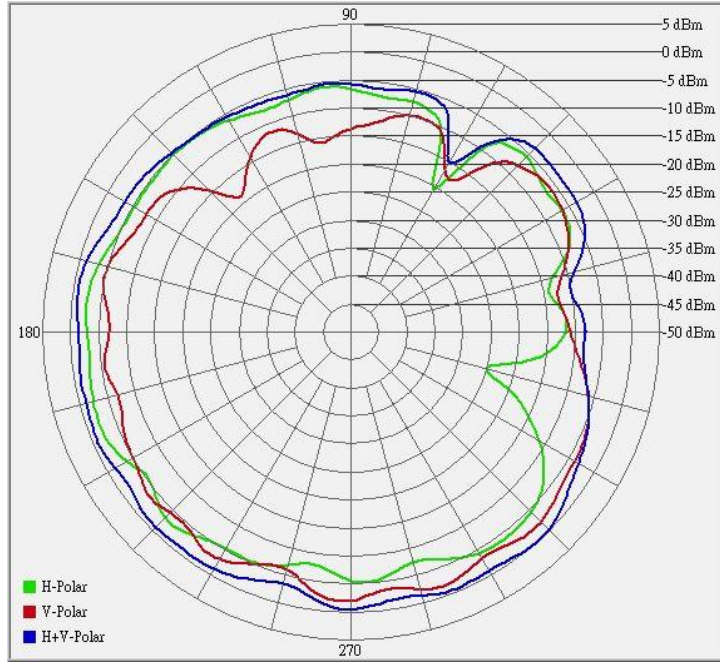

Center Frequency	2685 MHz
Horizontal (dBi) peak	-2.8
Vertical (dBi) peak	-0.57

5150-5350 MHz radiation characteristic

TX1 antenna: 5150 MHz

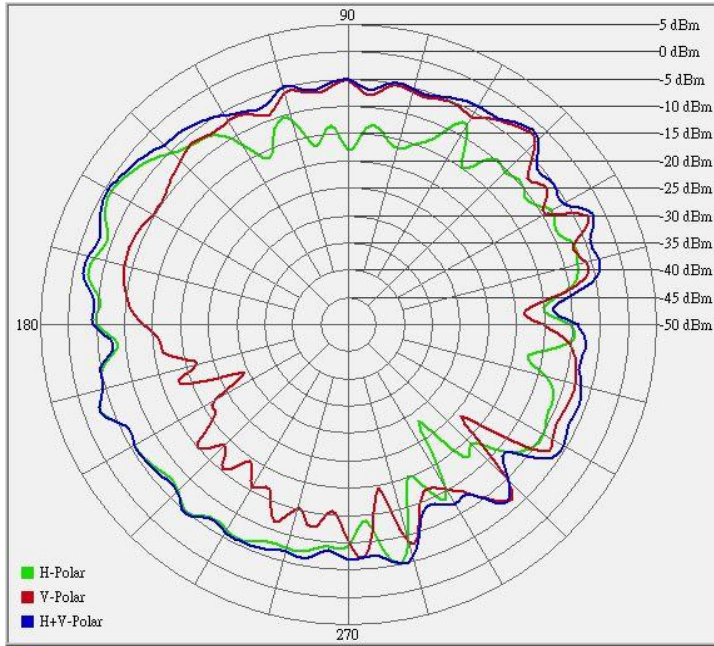

Center Frequency	5150 MHz
Horizontal (dBi) peak	-1.12
Vertical (dBi) peak	-2.77

TX1 antenna: 5250 MHz

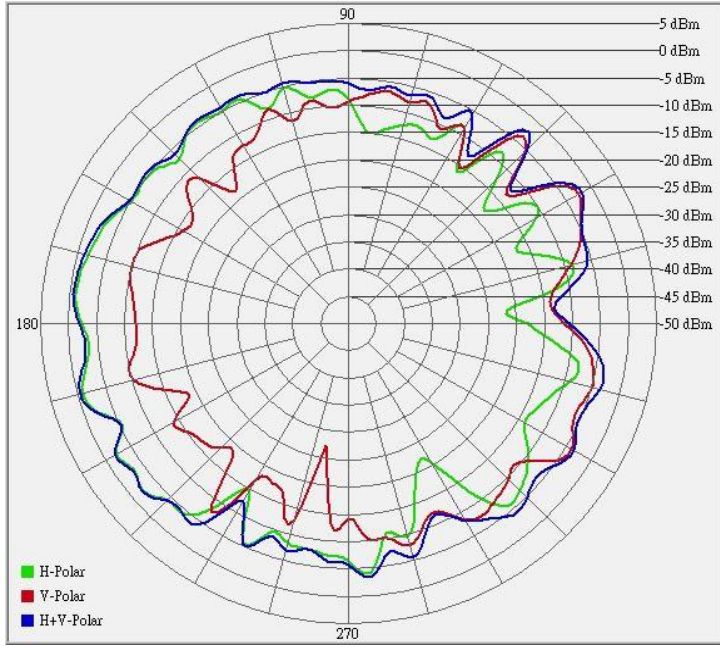

Center Frequency	5250 MHz
Horizontal (dBi) peak	-0.83
Vertical (dBi) peak	-2.41