



SAR & HAC Instruments for Wireless • Consulting • Research • Standards • Compliance • Training

**Applicant Name:** Intel Corporation  
**Applicant Address:** Intel Corporation  
 2111 Ne 25<sup>th</sup> Avenue JF3-3-G14,  
 Hillsboro, OR 97124  
**Project Number:** ITLB-Hawke-WNC-5307  
**Test/Analysis Date:** 6<sup>th</sup> through 10<sup>th</sup> September 2007



<b>DUT Type</b>	4965AGN
<b>Antenna Type</b>	WNC
<b>Project Name</b>	Hawke
<b>Received Status</b>	Pre Production Model
<b>DUT Serial Number</b>	PS069891
<b>Experimental/Compliance</b>	Compliance-FCC
<b>Tx Frequency</b>	2412MHz to 2462MHz 802.11bg(n) 5180MHz to 5320MHz 802.11a(n)* 5745MHz to 5825MHz 802.11a(n)**
<b>Max Tx Power</b>	802.11bg = 16.9dBm 2450n = 17.66dBm 802.11a = 17.74dBm 802.11an = 17.66dBm
<b>Conservative Averaged SAR (RF Exposure)</b>	<b>802.11b =0.454 W/kg</b> 802.11g =0.590 W/kg <b>802.11gn =0.441 W/kg</b> 802.11gMIMO =0.294 W/kg <b>802.11a* =0.370 W/kg</b> 802.11an* =0.832 W/kg <b>802.11an Wide* =0.535 W/kg</b> 802.11aMIMO* =0.452 W/kg <b>802.11a** =0.446 W/kg</b> 802.11an** =0.392 W/kg <b>802.11an Wide** =0.442 W/kg</b> 802.11aMIMO** =0.264 W/kg <b>NOTE: &gt;5GHz tested @ 6mm separation</b>

We the undersigned of APREL Laboratories, located at 17 Bentley Ave, Ottawa, Ontario, Canada, K2E 6T7, on the date indicated attest that the Device Under Test as detailed within this test report has been tested and found to be compliant with the Uncontrolled Environment RF exposure rules and regulations as defined by the methodologies, procedures, and standards as described in this document.

Document Issued & Digitally Signed on 3<sup>rd</sup> October 2007

APREL Laboratories are an ISO 17025 accredited facility registered under Standards Council Canada lab 48.

  
 Art Brennan  
 Document Control

  
 Stuart Nicol,  
 Director Product Development

  
 Dr Jacek J. Wojcik,  
 P. Engineer





SAR & HAC Instruments for Wireless • Consulting • Research • Standards • Compliance • Training

Table of Contents

- 1.0 Introduction ..... 2**
- 2.0 Applicable Documents ..... 2**
- 3.0 ALSAS-10U System Description ..... 2**
- 3.1 Applications ..... 2**
- 3.2 Visualisation and reporting ..... 2**
- 3.3 Field scans ..... 2**
- 3.3.1 Area Scans ..... 2**
- 3.3.2 Zoom Scan (Cube Scan Averaging) ..... 2**
- 3.4 Operator settings ..... 2**
- 3.5 ALSAS-10U Interpolation and Extrapolation Uncertainty ..... 2**
- 4.0 ALSAS-10U Hardware ..... 2**
- 4.1 Isotropic E-Field Probe ..... 2**
- 4.2 Isotropic E-Field Probe Specification ..... 2**
- 4.3 Boundary Detection Unit and Probe Mounting Device ..... 2**
- 4.4 Daq-Paq (Analog to Digital Electronics) ..... 2**
- 4.5 Axis Articulated Robot ..... 2**
- 4.6 ALSAS Universal Workstation ..... 2**
- 4.7 Universal Device Positioner ..... 2**
- 4.8 Phantom Types ..... 2**
- 4.8.1 APREL SAM Phantoms ..... 2**
- 4.8.2 APREL Laboratories Universal Phantom ..... 2**
- 4.9 Validation Dipoles ..... 2**
- 5.0 Tissue Simulation Fluid ..... 2**
- 5.1 Tissue Calibration Procedure Using a Coaxial Probe ..... 2**
- 5.2 Tissue Calibration Results ..... 2**
- 6.0 System Validation ..... 2**
- 6.1 Experimental Results Summary ..... 2**
- 6.2 SAR Measurement Procedure ..... 2**
- 6.3 SAR Exposure Limits ..... 2**
- 6.4 Equipment List ..... 2**
- 6.5 SAR Measurement Results ..... 2**
- Appendix A SAR Plots ..... 2**



## 1.0 Introduction

Tests were conducted at APREL Laboratories within the ISO 17025 accredited SAR facility to establish the conservative exposure value associated with the Device Under Test as detailed within this test report. Assessments were made in line with the guidelines contained in the reference documents. The method used for assessment was the ALSAS-10U (APREL Laboratories SAR Assessment System-10 Universal). All practices along with standards and scientific methodologies which have been utilized during the assessment of the Device Under Test (DUT) are detailed within this test report.

APREL Laboratories employees currently hold senior and executive positions in multiple international standards organizations, including IEC, IEEE, among others, and work closely with several national regulators, including the FCC. Through the IEC, we have a liaison with CENELEC, and informal links to other national and international standards organizations.

## 1.2 Device Description

The Device Under Test (DUT) is the Intel® 4965AGN Network Connection card located inside a Dell M1530 laptop computer which utilises a set of WNC antennas. The card was connected to the antennas with the DUT set to transmit at the maximum power as defined by the manufacturer and analysis was ran to determine the antenna and location which showed the highest SAR. The card was operated utilizing proprietary software and each channel was measured using a broadband power meter to determine the maximum average power. The tests conducted do not represent every conceivable application or use but do represent a WORST CASE user exposure condition when the DUT is used in conjunction with the antenna listed. The device was also tested using MIMO methods and worst case conditions have been assessed on both channels. The SAR has not been summed to provide conservative values due to a separation distance of greater than 15cm from each transmitting antenna. It was also observed that the SAR measured for the secondary antenna was more than 20% lower than that assessed at the position where the conservative SAR was assessed.



NOTE: The laptop was tested with 6mm separation distance for frequencies above 5GHz. It was also found that when the DUT was tested with the underside flat against the phantom the SAR was considerably less than that recorded in the test report due to a separation distance of greater than 30mm from the physical antenna location applicable to when the unit is positioned on the lap of the user. Additional analysis was made based on the Bluetooth module where the SAR was summed with the converted MPE value as recorded by another test laboratory and it was found that the device still complied with the expectations of the FCC under the co-located requirements.

### 1.3 Antenna Locations

The antennas on the Dell M1530 laptop with the Intel® WM3945ABG card installed are located within the chassis as identified in the images below. Both antenna locations were assessed for SAR and it was found that the antenna which was located at the back of the laptop yielded the conservative SAR as listed and recorded in this test report.



**LCD Top LHS**



**Back of Laptop (location for conservative SAR)**

## 2.0 Applicable Documents

ANSI/IEEE C95.1-1999, IEEE Standard for Safety Levels with Respect to Human Exposure to Radio Frequency Electromagnetic Fields, 3 kHz to 300 GHz.

ANSI/IEEE C95.3-1992, IEEE Recommended Practice for the Measurement of Potentially Hazardous Electromagnetic Fields – RF and Microwave.

OET Bulletin 65 (Edition 97-01) Supplement C (Edition 01-01), “Evaluating Compliance with FCC Guidelines for Human Exposure to Radio Frequency Electromagnetic Fields”.

IEEE 1528 “Recommended Practice for Determining the Peak Spatial Average Specific Absorption Rate (SAR) in the Human Body Due to Wireless Communication Devices: Experimental Techniques.”

ICNIRP Guidelines “GUIDELINES FOR LIMITING EXPOSURE TO TIME-VARYING ELECTRIC, MAGNETIC, AND ELECTROMAGNETIC FIELDS (UP TO 300 GHz)”

IEC-62209 “Human exposure to radio frequency fields from hand-held and body-mounted wireless communication devices – Human models, instrumentation, and procedures”  
 Part 1: “Procedure to determine the Specific Absorption Rate (SAR) for hand-held devices used in close proximity of the ear (frequency range of 300 MHz to 3 GHz)”

IEC-62209 “Human exposure to radio frequency fields from hand-held and body-mounted wireless communication devices – Human models, instrumentation, and procedures”  
 Part 2 *Draft*: “Procedure to determine the Specific Absorption Rate (SAR) for hand-held devices used in close proximity of the ear (frequency range of 30 MHz to 6 GHz)”

### 3.0 ALSAS-10U System Description

**APREL Laboratories ALSAS-10-U (APREL Laboratories SAR Assessment System)** is fully optimized for the dosimetric evaluation of a broad range of wireless transceivers and antennas. It is an easy-to-use development and compliance tool, which provides excellent application flexibility. Developed in line with the latest methodologies it is fully compliant with the technical and scientific requirements of IEEE 1528, IEC 62212, CENELEC, ARIB, ACA, and the Federal Communications Commission. The system comprises of a six axes articulated robot which utilizes a dedicated controller.

ALSAS-10U has been developed with a strong engineering focus, and with custom modular software/hardware for the broadest range of applications, including dosimetry research and measurements in various Phantoms – SAM Phantom, UniPhantom™ Universal Phantom, Universal Flat Phantom and others.

Free space E-Field measurements of mobile devices and base station antennas can also be executed using ALSAS. With the current ALSAS configuration, several phantoms and setups can be arranged around the system – and since the phantoms are designed to be light and easy to move for interchanging between test frequencies.

ALSAS-10U has been developed using the latest methodologies and FDTD modeling to provide a platform which is repeatable with minimum uncertainty.

The ongoing commitment from APREL Laboratories to the field of Dosimetric research and development will ensure that the ALSAS-10-U measurement system can easily be upgraded to accommodate changes to wireless technologies, and scientific methodologies.



### 3.1 Applications

Predefined measurement procedures compliant with the guidelines of CENELEC, IEEE, IEC, FCC, etc are utilized during the assessment for the device. Automatic detection for all SAR maxima are embedded within the core architecture for the system, ensuring that peak locations used for centering the zoom scan are within a 1mm resolution and a 0.05mm repeatable position. A little less than 10 min per device position measurement completion time, (depending of DUT size) ensures minimum power drift during the assessment. No user interaction is required during the measurement processes: area scan, evaluation of cube maximal search, fine cube measurements and device power drift measurement. System operation range currently available up-to 6 GHz in simulated tissue.

ALSAS-10U can be used for all analog and digital devices, including wideband, spread spectrum and pulsed systems, etc.: handsets, handhelds, wireless data, electronic article surveillance, accessories, wireless access points, WLAN, cordless, radio, etc.

### 3.2 Visualization and reporting

2/3D isoline distribution, scatter graphics, polar graphics, and vector reproduction. Device representation and phantom visualization in 2/3D graphics with measurement data overlaid (in color plot format). Freely configurable output graphic formats with automatic title, data and legend generation which includes all relevant information relating to the measurement process. Uncertainty analysis and budget calculated and reported drawing on active device drift assessment, and tissue simulation values.

### 3.3 Field scans

ALSAS-10U can provide multiple scan types including Measurements along lines (X, Y, Z), multiple planes, curved surfaces (normalize probe to surface), volumes in free space or restricted volumes (phantoms). Cube measurements with surface extrapolation and spatial SAR evaluation for 1g and/or 10g. Time measurements (source power drift). Probe rotation measurements (isotropy) and many others in line with the requirements of any given standard or procedure.

#### 3.3.1 Area Scans

Area scans are defined prior to the measurement process being executed with a user defined variable spacing between each measurement point (integral) allowing low uncertainty measurements to be conducted. Scans defined for FCC applications utilize a 10mm<sup>2</sup> step integral, with 1mm interpolation used to locate the peak SAR area used for zoom scan assessments.

A maximum area scan size is set at 280mm x 200mm which can be changed to a smaller size dependent on the filed distribution of the device under test. The area scan size is documented within the SAR report which is delivered by the SAR system software.

Where the system identifies multiple SAR peaks (which are within 2dB of each peak value) the system will provide the user with the option of assessing each peak location individually for zoom scan averaging.



### 3.3.2 Zoom Scan (Cube Scan Averaging)

The averaging zoom scan volume utilized in the ALSAS-10U software is in the shape of a cube and the side dimension of a 1 g or 10 g mass is dependent on the density of the liquid representing the simulated tissue. A density of 1 000 kg/m<sup>3</sup> is used to represent the head and body tissue density and not the phantom liquid density, in order to be consistent with the definition of the liquid dielectric properties, i.e. the side length of the 1 g cube is 10mm, with the side length of the 10 g cube 21,5mm.

When the cube intersects with the surface of the phantom, it is oriented so that 3 vertices touch the surface of the shell or the centre of a face is tangent to the surface. The face of the cube closest to the surface is modified in order to conform to the tangent surface. The centre of the cube and the tangential angle associated defines each face of the cube so that all transitional points follow this tangential angle.

The zoom scan integer steps can be user defined so as to reduce uncertainty, but normal practice for typical test applications (including FCC) utilize a physical step of 5x5x9 (8mmx8mmx4mm Fx <3GHz) and 9x9x17 (4mmx4mmx2mm Fx >3GHz) providing a volume of 32mm in the X & Y axis, and 32mm in the Z axis. All points remain tangential to the surface by utilizing the normalize (probe tilt) feature so as to reduce measurement uncertainty.

### 3.4 Operator settings

Multiple access levels (password protected) for parametric modifications/test scenarios in line with selected standards, including the FCC. Any number of predefined settings (probes, phantoms, liquids, devices, measurement procedures, etc.) can be stored for future use and repeatable assessments.

### 3.5 ALSAS-10U Interpolation and Extrapolation Uncertainty

The overall uncertainty for the methodology and algorithms that are used during the SAR calculation was evaluated using the data from IEEE 1528 based on the example f3 algorithm:

$$f_3(x, y, z) = A \frac{a^2}{\frac{a^2}{4} + x'^2 + y'^2} \cdot \left( e^{-\frac{2z}{a}} + \frac{a^2}{2(a + 2z)^2} \right)$$

## 4.0 ALSAS-10U Hardware

The ALSAS-10U comprises of hardware designed exclusively by APREL Laboratories based on methodologies presented in IEEE 1528, IEC 62212, CENELEC and FCC supplement C OET bulletin 65.

### 4.1 Isotropic E-Field Probe

The isotropic E-Field probe used by APREL Laboratories, has been fully calibrated and assessed for isotropicity, and boundary effect within a controlled environment. Depending on the frequency for which the probe is calibrated the method utilized for calibration will change. APREL Laboratories utilize a number of methods for calibrating probes, and these are outlined in the table below.

Calibration Frequency (MHz)	Air Calibration	Tissue Calibration
300	TEM Cell	Temperature
450	TEM Cell	Temperature
835	TEM Cell	Temperature
900	TEM Cell	Temperature
1800	TEM Cell	Temperature
1900	TEM Cell	Temperature
2450	Waveguide	Waveguide
5200	Waveguide	Waveguide
5600	Waveguide	Waveguide
5800	Waveguide	Waveguide

The APREL Laboratories E-Field probe utilizes a triangular sensor arrangement as detailed in the diagram below.

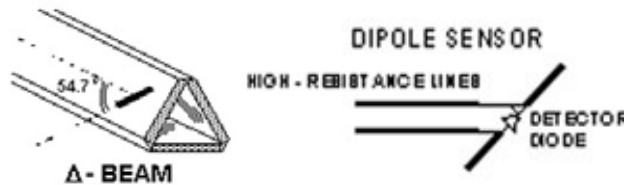

SAR is assessed with a calibrated probe which moves at a default height of 5mm from the centre of the diode, which is mounted to the sensor, to the phantom surface (in the Z Axis). The 5mm offset height has been selected so as to minimize any resultant boundary effect due to the probe being in close proximity to the phantom surface.

The following algorithm is an example of the function used by the system for linearization of the output from the probe when measuring complex modulation schemes.

$$V_i = U_i + U_i^2 \cdot \frac{cf}{dcp_i}$$

### 4.2 Isotropic E-Field Probe Specification

<b>Calibration in Air</b>	Frequency Dependent Below 2GHz Calibration in air performed in a TEM Cell Above 2GHz Calibration in air performed in waveguide
<b>Sensitivity</b>	0.60 $\mu\text{V}/(\text{V}/\text{m})^2$ to 1.25 $\mu\text{V}/(\text{V}/\text{m})^2$
<b>Dynamic Range</b>	0.01 W/kg to 100 W/kg
<b>Isotropic Response</b>	Better than 0.2dB in air Better than 0.05dB in tissue
<b>Diode Compression Point (DCP)</b>	Calibrated for Specific Frequency typically 95mV +/- 10%
<b>Probe Tip Radius</b>	<2.9mm
<b>Sensor Offset</b>	1.56 (+/-0.02mm)
<b>Probe Length</b>	290mm
<b>Video Bandwidth</b>	@ 500 Hz: 1 dB @ 1.02 KHz: 3 dB
<b>Boundary Effect</b>	Less than 2% for distances greater than 1.4mm
<b>Spatial Resolution</b>	Better than 1mm

### 4.3 Boundary Detection Unit and Probe Mounting Device

ALSAS-10U incorporates a boundary detection unit with a sensitivity of 0.05mm for detecting all types of surfaces. The robust design allows for detection during probe tilt (probe normalize) exercises, and utilizes a second stage emergency stop. The signal electronics are fed directly into the robot controller for high accuracy surface detection in lateral and axial detection modes (X, Y, & Z).

The probe is mounted directly onto the Boundary Detection unit for accurate tooling and displacement calculations controlled by the robot kinematics. The probe is connect to an isolated probe interconnect where the output stage of the probe is fed directly into the amplifier stage of the Daq-Paq.

### 4.4 Daq-Paq (Analog to Digital Electronics)

ALSAS-10U incorporates a fully calibrated Daq-Paq (analog to digital conversion system) which has a 4 channel input stage, sent into an amplifier module. The input signal is amplified accordingly so as to offer a dynamic range from 5 $\mu\text{V}$  to 800mV. Integration of the fields measured is carried out at board level utilizing a Co-Processor which then sends the measured fields down into the main computational module in digitized form via an RS232 communications port. Probe linearization and duty cycle compensation is carried out within the main Daq-Paq module.

<b>ADC</b>	16 Bit
<b>Amplifier Range</b>	30 $\mu\text{V}$ to +200 mV (16 bit resolution: 4 $\mu\text{V}$ , 400mV)
<b>Field Integration</b>	Local Co-Processor utilizing proprietary integration algorithms
<b>Number of Input Channels</b>	4 in total 3 dedicated and 1 spare
<b>Communication</b>	Packet data via RS232



#### 4.5 Axis Articulated Robot



ALSAS-10U utilizes a six axis articulated robot, which is controlled using a Pentium based real-time movement controller. The movement kinematics engine utilizes proprietary (Thermo CRS) interpolation and extrapolation algorithms, which allow full freedom of movement for each of the six joints within the working envelope. Utilization of joint 6 allows for full probe rotation with a tolerance better than 0.05mm around the central axis.

<b>Robot/Controller Manufacturer</b>	Thermo CRS
<b>Number of Axis</b>	Six independently controlled axis
<b>Positioning Repeatability</b>	0.05mm
<b>Controller Type</b>	Single phase Pentium based C500C
<b>Robot Reach</b>	710mm
<b>Communication</b>	RS232 and LAN compatible

#### 4.6 ALSAS Universal Workstation

ALSAS Universal workstation was developed with a strong engineering focus taking into consideration flexibility and engineering needs, and the necessity to have integrated system which will allow for repeatability and fast adaptability. ALSAS workstation technology is stable and robust in structure, but at the same time flexible so that users can do calibration, testing and measurements using different types of phantoms with one set up, which significantly speeds up the measurement process.

The workstation incorporates a modular structure which can be easily adapted to specific engineering requirements and needs. Phantoms which are self contained modular units are easily located, removable and swappable. Three fully configurable shelves allow for setting up of a test device in a way which can either utilize the APREL Laboratories device positioner, or custom designed units. When using the modular shelf for positioning of a device, additional loading characteristics have been avoided.

The workstation has been constructed entirely out of composite wood and Canadian maple, with all metallic fasteners kept at a compliant distance from the Device under test.



## 4.7 Universal Device Positioner



The APREL Laboratories universal device positioner has been developed so as to allow complete freedom of movement of the DUT. Developed to hold a DUT in a free-space scenario any additional loading attributable to the material used in the construction of the positioner has been eliminated. Repeatability has been enhanced through the linear scales which form the design used to indicate positioning for any given test scenario in all major axes. A 15° tilt indicator has been included for the of aid cheek to tilt movements for head SAR analysis. Overall uncertainty for measurements have been reduced due to the design of the Universal device positioner, which allows positioning of a device in as near to a free-space scenario as possible, and by providing the means for complete repeatability.



<b>Length</b>	201mm
<b>Width</b>	140mm
<b>Height</b>	222mm
<b>Weight</b>	1.97kg
<b>Number of Axis</b>	6 axis freedom of movement
<b>Translation Along MB Line</b>	+/- 76.2mm
<b>Translation Along NF Line</b>	+/- 38.1mm
<b>Translation Along Z Axis</b>	+/- 25.4mm (expandable to 500mm)
<b>Rotation Around MB Line (yaw)</b>	+/- 10°
<b>Rotation Around NF Line (pitch)</b>	+/- 30°
<b>Rotation Around Z Axis (roll)</b>	360° full circle
<b>Minimum Grip Range</b>	0mm
<b>Maximum Grip</b>	152mm
<b>Maximum Distance from Device to Positioner</b>	40mm
<b>Material</b>	
<b>Tilt Movement</b>	Full movement with predefined 15° guide

## 4.8 Phantom Types

The ALSAS-10U has been designed so as to allow the integration of multiple phantom types. This includes but is not limited to the APREL Laboratories SAM Phantoms fully compliant with IEEE 1528, Universal Phantom, and Universal Flat.

### 4.8.1 APREL SAM Phantoms

The APREL Laboratories SAM phantoms have been designed so as to aid repeatability and positioning for any DUT. Developed using the IEEE SAM CAD file they are fully compliant with the requirements for both IEEE 1528 and FCC Supplement C. Both the left and right SAM phantoms are interchangeable, transparent and include the IEEE 1528 grid with visible NF and MB lines.

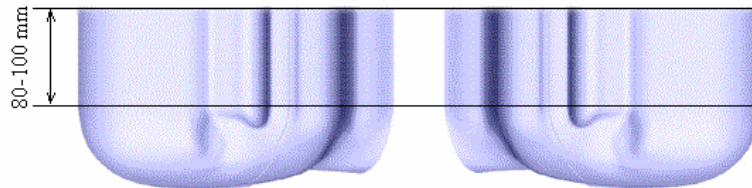

<b>Compliant Standards</b>	IEEE-1528, IEC 62212, CENELEC, and others
<b>Manufacturing Process</b>	Injection molded
<b>Material</b>	Composite urethane
<b>Manufacturing Tolerance</b>	+/- 0.2mm
<b>Frame Material</b>	Corian
<b>Tissue Simulation Volume</b>	7 ltr with 15cm tissue
<b>Thickness</b>	2mm nominally 6mm at NF/MB intersection
<b>Loss Tangent</b>	<0.05
<b>Relative Permittivity</b>	<5
<b>Resistant to Solvents</b>	Resistant to all solvents detailed in IEEE 1528
<b>Load Deflection</b>	<1mm with sugar water compositions

#### 4.8.2 APREL Laboratories Universal Phantom



The APREL Laboratories Universal Phantom has been developed as an engineering tool for both compliance and development. It is also used on the ALSAS-10U as a system validation phantom. The unique design allows repeatable measurements for all devices, including handsets, PDA units, laptop computers, and validation dipoles. The APREL Laboratories Universal Phantom has been fully validated both experimentally from 800MHz to 6GHz and numerically using XFDTD numerical software. The shell thickness is 2mm overall, with a 4mm spacer located at the NF/MB intersection providing an overall thickness of 6mm in line with the requirements of IEEE-1528. The design allows for fast and accurate measurements, of handsets, by allowing the conservative SAR to be evaluated at on frequency for

both left and right head experiments in one measurement. The phantom is surrounded by a Corian frame, which adds additional support and load bearing characteristics.

<b>Compliant Standards</b>	IEEE-1528, IEC 62212, CENELEC, and others
<b>Frequency Range</b>	800MHz to 6GHz
<b>Material</b>	Vivac
<b>Manufacturing Tolerance</b>	+/- 0.2mm
<b>Frame Material</b>	Corian
<b>Tissue Simulation Volume</b>	8 ltr with 15cm tissue
<b>Thickness</b>	2mm nominally 6mm at NF/MB intersection
<b>Loss Tangent</b>	<0.05
<b>Relative Permittivity</b>	<5
<b>Resistant to Solvents</b>	Resistant to all solvents detailed in IEEE 1528
<b>Load Deflection</b>	<1% Length with sugar water compositions
<b>Dimensions</b>	Length 220mm x breadth 170mm



## 4.9 Validation Dipoles

APREL Laboratories utilize dipoles based on the IEEE-1528 standard, and have ensured that they comply with mechanical and electrical specifications in line with the requirements of both IEEE and FCC Supplement C. The table below provides details for the mechanical and electrical specifications for the dipoles used by APREL Laboratories.

Body validation target numbers have been derived using XFDTD numerical software, and validated experimentally.

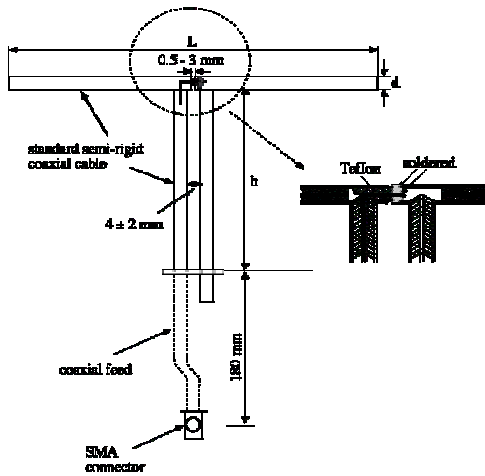

APREL Laboratories have developed high frequency dipoles based on current scientific research carried both experimentally and numerically here at the APREL Laboratories site. Mechanical and electrical parameters for the dipoles have been established using experimental and numerical techniques, and target SAR values have been established following IEC methodologies. The results of the experimental and numerical research have been published and released for peer review.

Frequency (MHz)	L (mm)	h (mm)	d (mm)
300	396.0	250.0	6.0
450	270.0	166.7	6.0
835	161.0	89.8	3.6
900	149.0	83.3	3.6
1450	89.1	51.7	3.6
1800	72.0	41.7	3.6
1900	68.0	39.5	3.6
2000	64.5	37.5	3.6
2450	51.5	30.4	3.6
3000	41.5	25.0	3.6
5200	23.6	14	3.6
5800	21.6	13	3.6
5190-5900	23.1	20.7	3.6



### 5.0 Tissue Simulation Fluid

Tissue simulation fluids in the frequency range of 450MHz to 2450MHz are based on IEEE-1528 and FCC Supplement C guidelines. All fluids meet the dielectric specifications as outlined in the above standards (within allowable tolerances) and are calibrated on a regular basis, to maintain stability. The recipes used along with the dielectric target values are included in the table below.

Ingredients (% Weight)	450 MHz Head	835 MHz Head	915 MHz Head	1900 MHz Head	2450 MHz Head
Water	38.56	41.45	41.05	54.9	62.7
Salt	3.95	1.45	1.35	0.18	0.5
Sugar	56.32	56.0	56.5	x	x
HEC	0.98	1.0	1.0	x	x
Bactericide	0.19	0.1	0.1	0.1	X
Triton-X	X	X	X	X	36.8
DGBE	X	X	X	44.92	x
$\epsilon^r$	43.42	42.54	42.0	39.9	39.8
$\delta$	0.85	0.91	1.0	1.42	1.88

Ingredients (% Weight)	450 MHz Body	835 MHz Body	915 MHz Body	1900 MHz Body	2450 MHz Body
Water	51.16	52.4	56.0	40.4	73.2
Salt	1.49	1.4	0.76	0.5	0.04
Sugar	46.78	45.0	41.76	58.0	X
HEC	0.52	1.0	1.21	1.0	X
Bactericide	0.05	0.1	0.27	0.1	X
Triton-X	X	X	X	X	X
DGBE	X	X	X	X	26.7
$\epsilon^r$	58.0	56.1	56.8	54.0	52.5
$\delta$	0.83	0.95	1.07	1.45	1.97

NOTE. Recipes are based on those presented in FCC Supplement C Page 36.

For frequencies above 2450MHz recipes will be presented as and when requested by a designated body.

Ingredients (% Weight)	5200 MHz Body	5600 MHz Body	5800 MHz Body
Water	x	x	x
Salt	x	x	x
Sugar	x	x	x
HEC	x	x	x
Bactericide	x	x	x
Triton-X	x	x	x
DGBE	x	x	x
$\epsilon^r$	48.9	x	48.2
$\delta$	5.35	x	6.00



## 5.1 Tissue Calibration Procedure Using a Coaxial Probe

The VNA (Vector Network Analyzer) is configured and calibrated for the frequency of the simulated tissue which has to be assessed. The Coaxial probe is then calibrated in line with the tissue frequency using an open, short, and De-Ionized water routine. The sample of simulated tissue is placed into a non-metallic container for use during the calibration. The temperature of the simulated tissue sample is measured. The probe head is then completely immersed in the simulated tissue sample (the probe is held in place using a non metallic probe holder). The simulated tissue sample is then measured to assess the permittivity and conductivity.

## 5.2 Tissue Calibration Results



Tissue used during the SAR assessment is calibrated prior to use in the measurement process. APREL Laboratories use the co-axial probe method for all tissue calibration exercises. Tissue which is being used over a period of 24 hours is re-calibrated to ensure that no change to the dielectric properties will affect the SAR measurement process. The table below provides details of the results from the tissue equivalent dielectric calibration. This project was conducted over a period of 6 days and the tissues were calibrated daily to ensure that they met the values presented below.

Calibrated By	Calibration Date	Frequency MHz	Tissue Type	Epsilon ( $\epsilon'$ )	Sigma ( $\delta$ )
Maryna. N	Daily	2450	Body	50.7	1.97
Maryna. N	Daily	5200	Head	47.39	5.41
Maryna. N	Daily	5800	Head	45.77	6.11

Variation to the tissue was maintained daily to be less than 2%.

## 6.0 System Validation

ALSAS-10U is fully validated prior to the SAR assessment of the DUT following methodologies presented in IEEE-1528 section 8. The system is validated using tissue which has been calibrated within a 24 hour period. When the measurement process exceeds a 24 hour period a secondary system validation is executed and the results presented within this test report. The graphic plots resulting from the system validation are included in Appendix A SAR plots.

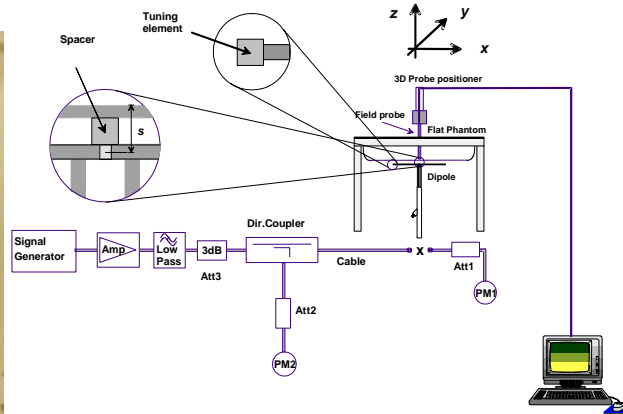

Date	Validation Frequency (MHZ)	Dipole Separation Distance mm	Power W	Dipole	SAR 1g W/kg	Target 1g W/kg
Daily	2450	10	1.0	AL-CD10	52.2	52.9
Daily	5200	10	1.0	Broad-band	57.2	58.8
Daily	5800	10	1.0	Broad-band	50.0	49.1

Currently no standards are in place for validating a system while using body tissue. System validation and values are based on current guidance coming from the FCC and utilize the APREL Laboratories dipoles for frequencies above 5GHz. This project was conducted over a period of several working days and when necessary system validations were repeated when the test completion was greater than a 24 hour period. Where the system validation was greater than 2% from those presented above the tissue was then reassessed and brought back to within 2% of initial dielectric values to show consistency throughout the measurement cycle.

### 6.1 Experimental Results Summary

The results for each experimental assessment are contained within this section. Where any deviation has been made from the given procedures contained within IEEE-1528 or FCC Supplement C this has been described accordingly.

### 6.2 SAR Measurement Procedure

The ALSAS-10U calculates SAR using the following equation,

$$SAR = \frac{\sigma |E|^2}{\rho}$$

$\sigma$ : represents the simulated tissue conductivity  
 $\rho$ : represents the tissue density

The DUT is set to transmit at the required power in line with product specification, at each frequency relating to the LOW, MID, and HIGH channel settings.

Pre-scans are made on the device to establish the location for the transmitting antenna, using a large area scan in either air or tissue simulation fluid.

The DUT is placed against the Universal Phantom where the maximum area scan dimensions are larger than the physical size of the resonating antenna. When the scan size is not large enough to cover the peak SAR distribution, it is modified by either extending the area scan size in both the X and Y directions, or the device is shifted within the predefined area.

The area scan is then run to establish the peak SAR location (interpolated resolution set at 1mm<sup>2</sup>) which is then used to orient the center of the zoom scan. The zoom scan is then executed and the 1g and 10g averages are derived from the zoom scan volume (interpolated resolution set at 1mm<sup>3</sup>).

### 6.3 SAR Exposure Limits

SAR assessments have been made in line with the requirements of the documents listed in section 2 of this report.

Type of Exposure	Uncontrolled Environment Limit
Spatial Peak SAR (1g cube tissue for brain or body)	1.60 W/kg
Spatial Average SAR (whole body)	0.08 W/kg
Spatial Peak SAR (10g for hands, feet, ankles and wrist)	4.00 W/kg



## 6.4 Equipment List

APREL Laboratories utilize the following equipment.

Equipment Description	Asset/Serial Number	Calibration Date
ALSAS-10U	301571	Prior to Test
Boundary Detection Unit	301572	Calibrated Once
Daq-Paq	301573	January 2007
Pentium 4 Workstation	301574	Not Required
Signal Generator	301468	September 2007
Gigatronics Power Meter	301393	August 2007
Gigatronics Broad Band Power Sensor	301394	August 2007
HP-Directional Coupler	100251	September 2007
APREL Laboratories 800-4200MHz 12W Amplifier	301577	Prior to Test
APREL Laboratories 2450MHz Validation Dipole	301581	November 2006
APREL Laboratories E-020 E-Field Probe	226	May 2007
40MHz -20GHz VNA	301382	August 2006
TRL Calibration Kit	301582	January 2007
APREL Laboratories Coaxial Probe (Dielectric Probe Kit)	100757	Prior to Test
APREL Laboratories Universal Phantom	301511	Calibrated Once
APREL Laboratories SAM Phantom LHS	301500	Calibrated Once
APREL Laboratories SAM Phantom RHS	301501	Calibrated Once
APREL Laboratories 15mm Dipole Separation Kit	301546	Calibrated Once
APREL Laboratories 10mm Dipole Separation Kit	301547	Calibrated Once
APREL Laboratories 5-6GHz 2 W Amplifier	NYA	March 2007
APREL Laboratories MMW Directional Coupler	NYA	March 2007
APREL Laboratories 5240MHz Validation Dipole	301460	March 2007
APREL Laboratories 5800MHz Validation Dipole	PT-015-a	March 2007
ALSAS-10 Device Positioner	ALS-H-E-SET-2-	Not Required
ALS-H-E-SET-2	LAB1	

## 6.5 SAR Measurement Results

Intel® 4965AGN Network Connection with WNC Antennas **802.11b MODE**



<b>Power</b>	16.9dBm
<b>DUT Position</b>	Back of DUT
<b>Separation</b>	0mm
<b>Antenna Type</b>	IFA
<b>Antenna Manufacturer</b>	WNC
<b>Antenna Location</b>	Off Centre
<b>Power Mode</b>	Battery
<b>Tx Frequency</b>	2412-2462MHz
<b>Duty Cycle</b>	100%
<b>Epsilon</b>	50.7
<b>Sigma</b>	1.97
<b>Tissue Depth</b>	15cm
<b>Phantom Type</b>	Universal
<b>DUT Workstation Location</b>	Centre
<b>Device Positioner</b>	Not Needed
<b>Test Date</b>	September 2007
<b>Test Engineer</b>	Maryna. N

Mode	Separation Distance (mm)	Channel	Frequency MHz	1g SAR W/kg
802.11b	0	1	2412	0.454
802.11b	0	6	2437	0.386
802.11b	0	11	2462	0.392

<b>SAR Limit</b>	<b>Conservative Measured SAR</b>
1.6 W/kg 1gram Average Maximum	0.454 W/kg 1gram Average

**SAR Plot for Conservative SAR Included in Appendix A.**



Intel® 4965AGN Network Connection with WNC Antennas **802.11g MODE**



<b>Power</b>	16.9dBm
<b>DUT Position</b>	Back of DUT
<b>Separation</b>	0mm
<b>Antenna Type</b>	IFA
<b>Antenna Manufacturer</b>	WNC
<b>Antenna Location</b>	Off Centre
<b>Power Mode</b>	Battery
<b>Tx Frequency</b>	2412-2462MHz
<b>Duty Cycle</b>	100%
<b>Epsilon</b>	50.7
<b>Sigma</b>	1.97
<b>Tissue Depth</b>	15cm
<b>Phantom Type</b>	Universal
<b>DUT Workstation Location</b>	Centre
<b>Device Positioner</b>	Not Needed
<b>Test Date</b>	September 2007
<b>Test Engineer</b>	Maryna. N

Mode	Separation Distance (mm)	Channel	Frequency MHz	1g SAR W/kg
802.11g	0	1	2412	0.250
802.11g	0	6	2437	0.590
802.11g	0	11	2462	0.476

<b>SAR Limit</b>	<b>Conservative Measured SAR</b>
1.6 W/kg 10gram Average Maximum	0.590 W/kg 1gram Average

**SAR Plot for Conservative SAR Included in Appendix A.**



Intel® 4965AGN Network Connection with WNC Antennas **2450n MODE**



<b>Power</b>	16.9dBm
<b>DUT Position</b>	Back of DUT
<b>Separation</b>	0mm
<b>Antenna Type</b>	IFA
<b>Antenna Manufacturer</b>	WNC
<b>Antenna Location</b>	Off Centre
<b>Power Mode</b>	Battery
<b>Tx Frequency</b>	2412-2462MHz
<b>Duty Cycle</b>	100%
<b>Epsilon</b>	50.7
<b>Sigma</b>	1.97
<b>Tissue Depth</b>	15cm
<b>Phantom Type</b>	Universal
<b>DUT Workstation Location</b>	Centre
<b>Device Positioner</b>	Not Needed
<b>Test Date</b>	September 2007
<b>Test Engineer</b>	Maryna. N

Mode	Separation Distance (mm)	Channel	Frequency MHz	1g SAR W/kg
802.11n	0	1	2412	0.353
802.11n	0	6	2437	0.441
802.11n	0	11	2462	0.406

<b>SAR Limit</b>	<b>Conservative Measured SAR</b>
1.6 W/kg 1gram Average Maximum	0.406 W/kg 1gram Average

**SAR Plot for Conservative SAR Included in Appendix A.**





Intel® 4965AGN Network Connection with WNC Antennas **2450 MIMO MODE**



<b>Power</b>	16.9dBm
<b>DUT Position</b>	Back of DUT
<b>Separation</b>	0mm
<b>Antenna Type</b>	IFA
<b>Antenna Manufacturer</b>	WNC
<b>Antenna Location</b>	Off Centre
<b>Power Mode</b>	Battery
<b>Tx Frequency</b>	2412-2462MHz
<b>Duty Cycle</b>	100%
<b>Epsilon</b>	50.7
<b>Sigma</b>	1.97
<b>Tissue Depth</b>	15cm
<b>Phantom Type</b>	Universal
<b>DUT Workstation Location</b>	Centre
<b>Device Positioner</b>	Not Needed
<b>Test Date</b>	September 2007
<b>Test Engineer</b>	Maryna. N

Mode	Separation Distance (mm)	Channel	Frequency MHz	1g SAR W/kg
802.11n 20MHz	0	1	2412	0.294
802.11n 20MHz	0	6	2437	0.240
802.11n 20MHz	0	11	2462	0.157

<b>SAR Limit</b>	<b>Conservative Measured SAR</b>
1.6 W/kg 1gram Average Maximum	0.294 W/kg 1gram Average

**SAR Plot for Conservative SAR Included in Appendix A.**



Intel® 4965AGN Network Connection with WNC Antennas **802.11a Low Band MODE**



<b>Power</b>	17.74dBm
<b>DUT Position</b>	Back of DUT
<b>Separation</b>	6mm
<b>Antenna Type</b>	IFA
<b>Antenna Manufacturer</b>	WNC
<b>Antenna Location</b>	Off Centre
<b>Power Mode</b>	Battery
<b>Tx Frequency</b>	5180-5320MHz
<b>Duty Cycle</b>	100%
<b>Epsilon</b>	47.39
<b>Sigma</b>	5.41
<b>Tissue Depth</b>	15cm
<b>Phantom Type</b>	Universal
<b>DUT Workstation Location</b>	Centre
<b>Device Positioner</b>	Not Needed
<b>Test Date</b>	September 2007
<b>Test Engineer</b>	Maryna. N

Mode	Separation Distance (mm)	Channel	Frequency MHz	1g SAR W/kg
802.11a	6	36	5180	0.178
802.11a	6	52	5260	0.317
802.11a	6	64	5320	0.370

<b>SAR Limit</b>	<b>Conservative Measured SAR</b>
1.6 W/kg 1gram Average Maximum	0.370 W/kg 1gram Average

**SAR Plot for Conservative SAR Included in Appendix A.**



Intel® 4965AGN Network Connection with WNC Antennas **802.11n Low Band MODE**



<b>Power</b>	17.74dBm
<b>DUT Position</b>	Back of DUT
<b>Separation</b>	6mm
<b>Antenna Type</b>	IFA
<b>Antenna Manufacturer</b>	WNC
<b>Antenna Location</b>	Off Centre
<b>Power Mode</b>	Battery
<b>Tx Frequency</b>	5180-5320MHz
<b>Duty Cycle</b>	100%
<b>Epsilon</b>	47.39
<b>Sigma</b>	5.41
<b>Tissue Depth</b>	15cm
<b>Phantom Type</b>	Universal
<b>DUT Workstation Location</b>	Centre
<b>Device Positioner</b>	Not Needed
<b>Test Date</b>	September 2007
<b>Test Engineer</b>	Maryna. N

Mode	Separation Distance (mm)	Channel	Frequency MHz	1g SAR W/kg
802.11n	6	36	5180	0.438
802.11n	6	52	5260	0.832
802.11n	6	64	5320	0.671

<b>SAR Limit</b>	<b>Conservative Measured SAR</b>
1.6 W/kg 1gram Average Maximum	0.832 W/kg 1gram Average

**SAR Plot for Conservative SAR Included in Appendix A.**



Intel® 4965AGN Network Connection with WNC Antennas **802.11n 40MHz Low Band MODE**



<b>Power</b>	17.74dBm
<b>DUT Position</b>	Back of DUT
<b>Separation</b>	6mm
<b>Antenna Type</b>	IFA
<b>Antenna Manufacturer</b>	WNC
<b>Antenna Location</b>	Off Centre
<b>Power Mode</b>	Battery
<b>Tx Frequency</b>	5180-5320MHz
<b>Duty Cycle</b>	100%
<b>Epsilon</b>	47.39
<b>Sigma</b>	5.41
<b>Tissue Depth</b>	15cm
<b>Phantom Type</b>	Universal
<b>DUT Workstation Location</b>	Centre
<b>Device Positioner</b>	Not Needed
<b>Test Date</b>	September 2007
<b>Test Engineer</b>	Maryna. N

Mode	Separation Distance (mm)	Channel	Frequency MHz	1g SAR W/kg
802.11n 40MHz	6	38f	5190	0.436
802.11n 40MHz	6	46f	5270	0.484
802.11n 40MHz	6	62f	5310	0.535

<b>SAR Limit</b>	<b>Conservative Measured SAR</b>
1.6 W/kg 1gram Average Maximum	0.535 W/kg 1gram Average

**SAR Plot for Conservative SAR Included in Appendix A.**



## Intel® 4965AGN Network Connection with WNC Antennas **802.11an 20MHz Low Band MIMO MODE**



<b>Power</b>	17.74dBm
<b>DUT Position</b>	Back of DUT
<b>Separation</b>	6mm
<b>Antenna Type</b>	IFA
<b>Antenna Manufacturer</b>	WNC
<b>Antenna Location</b>	Off Centre
<b>Power Mode</b>	Battery
<b>Tx Frequency</b>	5180-5320MHz
<b>Duty Cycle</b>	100%
<b>Epsilon</b>	47.39
<b>Sigma</b>	5.41
<b>Tissue Depth</b>	15cm
<b>Phantom Type</b>	Universal
<b>DUT Workstation Location</b>	Centre
<b>Device Positioner</b>	Not Needed
<b>Test Date</b>	September 2007
<b>Test Engineer</b>	Maryna. N

Mode	Separation Distance (mm)	Channel	Frequency MHz	1g SAR W/kg
802.11n 20MHz	6	36	5180	0.418
802.11n 20MHz	6	52	5260	0.388
802.11n 20MHz	6	64	5320	0.452

SAR Limit	Conservative Measured SAR
1.6 W/kg 1gram Average Maximum	0.452 W/kg 1gram Average

**SAR Plot for Conservative SAR Included in Appendix A.**



Intel® 4965AGN Network Connection with WNC Antennas **802.11a MIMO Low Band MODE Wide**



<b>Power</b>	17.74dBm
<b>DUT Position</b>	Back of DUT
<b>Separation</b>	6mm
<b>Antenna Type</b>	IFA
<b>Antenna Manufacturer</b>	WNC
<b>Antenna Location</b>	Off Centre
<b>Power Mode</b>	Battery
<b>Tx Frequency</b>	5180-5320MHz
<b>Duty Cycle</b>	100%
<b>Epsilon</b>	47.39
<b>Sigma</b>	5.41
<b>Tissue Depth</b>	15cm
<b>Phantom Type</b>	Universal
<b>DUT Workstation Location</b>	Centre
<b>Device Positioner</b>	Not Needed
<b>Test Date</b>	September 2007
<b>Test Engineer</b>	Maryna. N

Mode	Separation Distance (mm)	Channel	Frequency MHz	1g SAR W/kg
802.11n 40MHz	6	38	5190	0.264
802.11n 40MHz	6	46	5230	0.400
802.11n 40MHz	6	62	5310	0.470

<b>SAR Limit</b>	<b>Conservative Measured SAR</b>
1.6 W/kg 1gram Average Maximum	0.470 W/kg 1gram Average

**SAR Plot for Conservative SAR Included in Appendix A.**



Intel® 4965AGN Network Connection with WNC Antennas **802.11a High Band MODE**



<b>Power</b>	17.74dBm
<b>DUT Position</b>	Back of DUT
<b>Separation</b>	6mm
<b>Antenna Type</b>	IFA
<b>Antenna Manufacturer</b>	WNC
<b>Antenna Location</b>	Off Centre
<b>Power Mode</b>	Battery
<b>Tx Frequency</b>	5745-5825MHz
<b>Duty Cycle</b>	100%
<b>Epsilon</b>	45.77
<b>Sigma</b>	6.11
<b>Tissue Depth</b>	15cm
<b>Phantom Type</b>	Universal
<b>DUT Workstation Location</b>	Centre
<b>Device Positioner</b>	Not Needed
<b>Test Date</b>	September 2007
<b>Test Engineer</b>	Maryna. N

Mode	Separation Distance (mm)	Channel	Frequency MHz	1g SAR W/kg
802.11a	6	149	5745	0.446
802.11a	6	157	5785	0.140
802.11a	6	165	5825	0.382

<b>SAR Limit</b>	<b>Conservative Measured SAR</b>
1.6 W/kg 1gram Average Maximum	0.446 W/kg 1gram Average

**SAR Plot for Conservative SAR Included in Appendix A.**



Intel® 4965AGN Network Connection with WNC Antennas **802.11n High Band MODE**



<b>Power</b>	17.74dBm
<b>DUT Position</b>	Back of DUT
<b>Separation</b>	6mm
<b>Antenna Type</b>	IFA
<b>Antenna Manufacturer</b>	WNC
<b>Antenna Location</b>	Off Centre
<b>Power Mode</b>	Battery
<b>Tx Frequency</b>	5745-5825MHz
<b>Duty Cycle</b>	100%
<b>Epsilon</b>	45.77
<b>Sigma</b>	6.11
<b>Tissue Depth</b>	15cm
<b>Phantom Type</b>	Universal
<b>DUT Workstation Location</b>	Centre
<b>Device Positioner</b>	Not Needed
<b>Test Date</b>	September 2007
<b>Test Engineer</b>	Maryna. N

Mode	Separation Distance (mm)	Channel	Frequency MHz	1g SAR W/kg
802.11n	6	149	5745	0.392
802.11n	6	157	5785	0.370
802.11n	6	165	5825	0.334

<b>SAR Limit</b>	<b>Conservative Measured SAR</b>
1.6 W/kg 1gram Average Maximum	0.392 W/kg 1gram Average

**SAR Plot for Conservative SAR Included in Appendix A.**





## Intel® 4965AGN Network Connection with WNC Antennas **802.11 Wide High Band MODE**



<b>Power</b>	17.74dBm
<b>DUT Position</b>	Back of DUT
<b>Separation</b>	6mm
<b>Antenna Type</b>	IFA
<b>Antenna Manufacturer</b>	WNC
<b>Antenna Location</b>	Off Centre
<b>Power Mode</b>	Battery
<b>Tx Frequency</b>	5745-5825MHz
<b>Duty Cycle</b>	100%
<b>Epsilon</b>	45.77
<b>Sigma</b>	6.11
<b>Tissue Depth</b>	15cm
<b>Phantom Type</b>	Universal
<b>DUT Workstation Location</b>	Centre
<b>Device Positioner</b>	Not Needed
<b>Test Date</b>	September 2007
<b>Test Engineer</b>	Maryna. N

Mode	Separation Distance (mm)	Channel	Frequency MHz	1g SAR W/kg
802.11anf	6	151f	5755	0.433
802.11anf	6	159f	5795	0.442

<b>SAR Limit</b>	<b>Conservative Measured SAR</b>
1.6 W/kg 1gram Average Maximum	0.442 W/kg 1gram Average

**SAR Plot for Conservative SAR Included in Appendix A.**



Intel® 4965AGN Network Connection with WNC Antennas **802.11a MIMO High Band MODE**



<b>Power</b>	17.74dBm
<b>DUT Position</b>	Back of DUT
<b>Separation</b>	6mm
<b>Antenna Type</b>	IFA
<b>Antenna Manufacturer</b>	WNC
<b>Antenna Location</b>	Off Centre
<b>Power Mode</b>	Battery
<b>Tx Frequency</b>	5745-5825MHz
<b>Duty Cycle</b>	100%
<b>Epsilon</b>	45.77
<b>Sigma</b>	6.11
<b>Tissue Depth</b>	15cm
<b>Phantom Type</b>	Universal
<b>DUT Workstation Location</b>	Centre
<b>Device Positioner</b>	Not Needed
<b>Test Date</b>	September 2007
<b>Test Engineer</b>	Maryna. N

Mode	Separation Distance (mm)	Channel	Frequency MHz	1g SAR W/kg
802.11anf 20MHz	6	149	5745	0.229
802.11anf 20MHz	6	157	5785	0.229
802.11anf 20MHz	6	165	5825	0.215

<b>SAR Limit</b>	<b>Conservative Measured SAR</b>
1.6 W/kg 1gram Average Maximum MIMO	0.229 W/kg 1gram Average

**SAR Plot for Conservative SAR Included in Appendix A.**



Intel® 4965AGN Network Connection with WNC Antennas **802.11a MIMO High Band MODE Wide**



<b>Power</b>	17.74dBm
<b>DUT Position</b>	Back of DUT
<b>Separation</b>	6mm
<b>Antenna Type</b>	IFA
<b>Antenna Manufacturer</b>	WNC
<b>Antenna Location</b>	Off Centre
<b>Power Mode</b>	Battery
<b>Tx Frequency</b>	5745-5825MHz
<b>Duty Cycle</b>	100%
<b>Epsilon</b>	45.77
<b>Sigma</b>	6.11
<b>Tissue Depth</b>	15cm
<b>Phantom Type</b>	Universal
<b>DUT Workstation Location</b>	Centre
<b>Device Positioner</b>	Not Needed
<b>Test Date</b>	September 2007
<b>Test Engineer</b>	Maryna. N

Mode	Separation Distance (mm)	Channel	Frequency MHz	1g SAR W/kg
802.11anf 40MHz	6	151	5755	0.264
802.11anf 40MHz	6	159	5795	0.226

SAR Limit	Conservative Measured SAR
1.6 W/kg 1gram Average Maximum MIMO	0.264 W/kg 1gram Average

**SAR Plot for Conservative SAR Included in Appendix A.**



## 6.6 Additional Information

The Intel® WM3945ABG Network Connection card located inside a Dell M1530 laptop computer was tested in other positions with respect to general user scenarios, where the SAR was found to be less than 30% lower than the highest value recorded in this report for the antenna which was located at the back of the laptop. The following images represent the full exposure conditions in which the DUT was assessed.





# APREL *Laboratories*

SAR & HAC Instruments for Wireless • Consulting • Research • Standards • Compliance • Training



# APREL Laboratories

SAR & HAC Instruments for Wireless • Consulting • Research • Standards • Compliance • Training

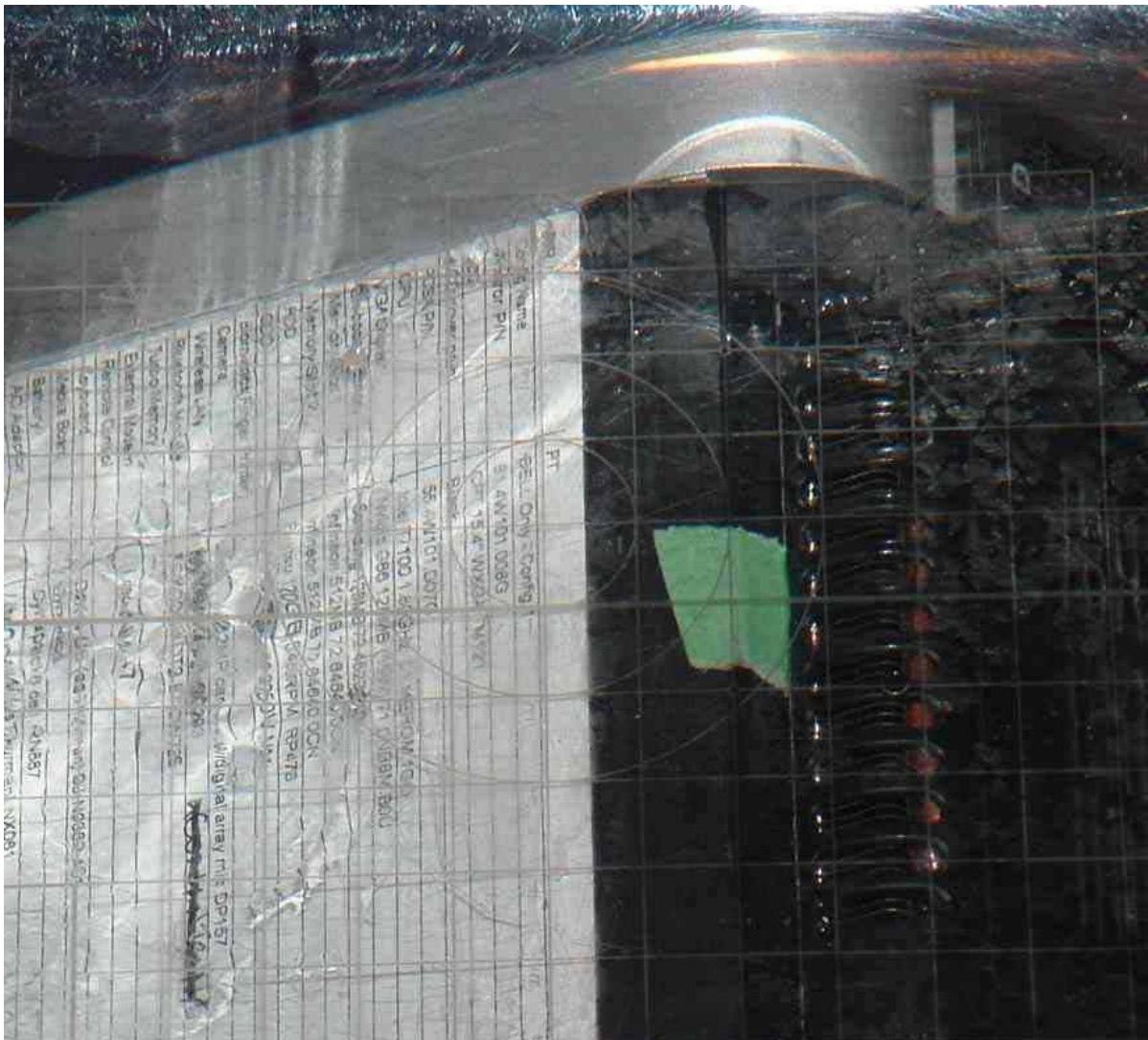

# APREL *Laboratories*

SAR & HAC Instruments for Wireless • Consulting • Research • Standards • Compliance • Training

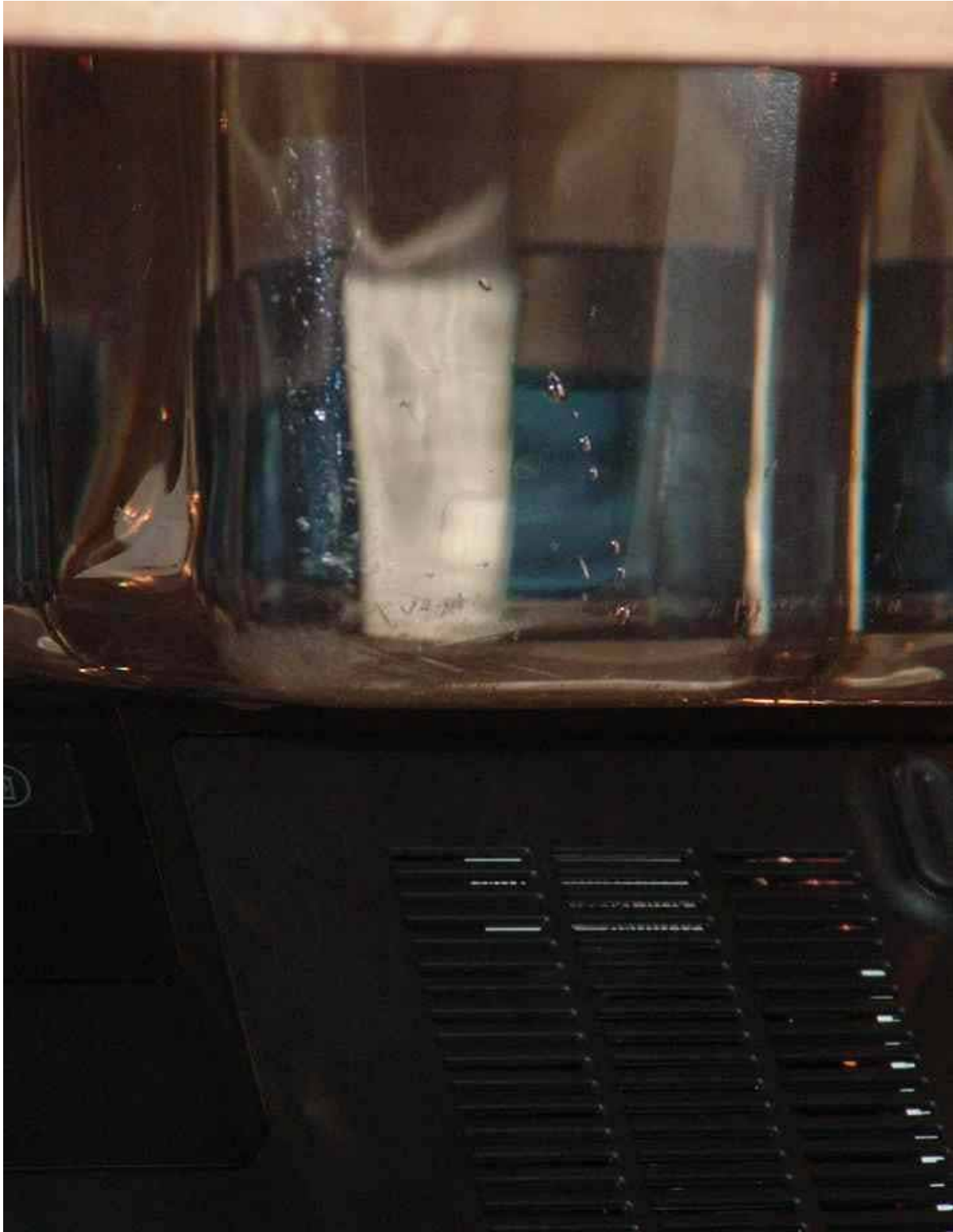



# APREL *Laboratories*

SAR & HAC Instruments for Wireless • Consulting • Research • Standards • Compliance • Training



# APREL *Laboratories*

SAR & HAC Instruments for Wireless • Consulting • Research • Standards • Compliance • Training

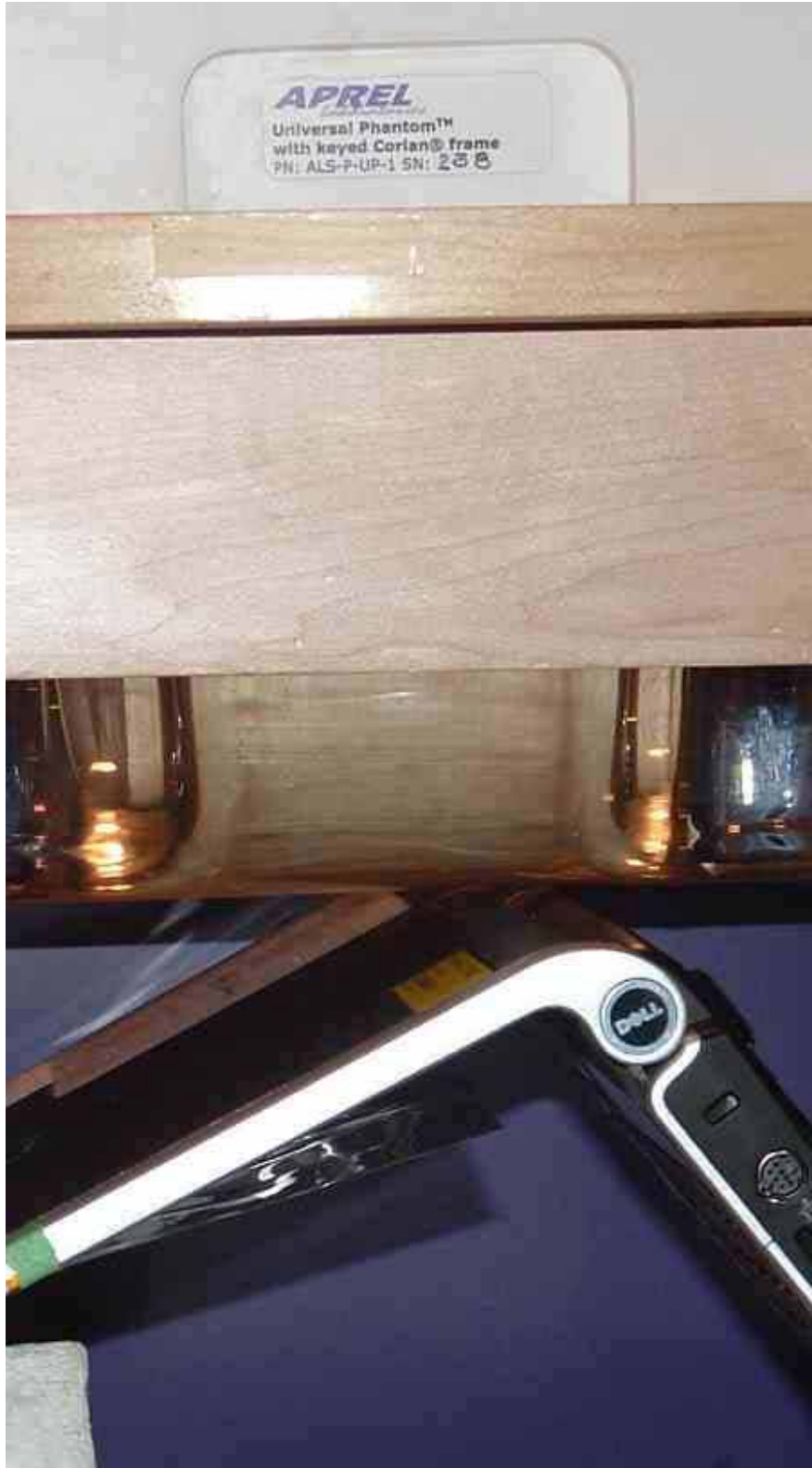



SAR & HAC Instruments for Wireless • Consulting • Research • Standards • Compliance • Training

## Appendix A SAR Plots



## SAR Test Report

Report Date : 06-Sep-2007  
 By Operator : 123  
 Measurement Date : 06-Sep-2007  
 Starting Time : 06-Sep-2007 10:50:42 AM  
 End Time : 06-Sep-2007 11:10:32 AM  
 Scanning Time : 1190 secs

Product Data  
 Device Name : Dell Hawk-2  
 Serial No. : PS069891  
 Type : Other  
 Model : HAW-E2-C1  
 Frequency : 2450.00 MHz  
 Max. Transmit Pwr : 0.05 W  
 Drift Time : 0 min(s)  
 Length : 110 mm  
 Width : 46 mm  
 Depth : 0 mm  
 Antenna Type : Internal  
 Orientation : Touch  
 Power Drift-Start : 0.201 W/kg  
 Power Drift-Finish : 0.215 W/kg  
 Power Drift (%) : 7.219  
 Picture : C:\alsas\bitmap\Dell-Hawk-Back.bmp

Phantom Data  
 Name : APREL-Uni  
 Type : Uni-Phantom  
 Size (mm) : 280 x 280 x 200  
 Serial No. : User Define  
 Location : Center  
 Description : U

Tissue Data  
 Type : BODY  
 Serial No. : 2450B  
 Frequency : 2450.00 MHz  
 Last Calib. Date : 05-Sep-2007  
 Temperature : 21.00 °C  
 Ambient Temp. : 23.00 °C  
 Humidity : 35.00 RH%  
 Epsilon : 50.70 F/m  
 Sigma : 1.97 S/m  
 Density : 1000.00 kg/cu. m



## Probe Data

Name : APREL  
 Model : E-020  
 Type : E-Field Triangle  
 Serial No. : 225  
 Last Calib. Date : 03-May-2007  
 Frequency : 2450.00 MHz  
 Duty Cycle Factor: 1  
 Conversion Factor: 4.4  
 Probe Sensitivity: 1.20 1.20 1.20  $\mu\text{V}/(\text{V}/\text{m})^2$   
 Compression Point: 95.00 mV  
 Offset : 1.56 mm

## Measurement Data

Crest Factor : 1  
 Scan Type : Complete  
 Tissue Temp. : 21.00 °C  
 Ambient Temp. : 21.00 °C  
 Set-up Date : 06-Sep-2007  
 Set-up Time : 10:47:10 AM  
 Area Scan : 10x7x1 : Measurement x=10mm, y=10mm, z=4mm  
 Zoom Scan : 5x5x8 : Measurement x=8mm, y=8mm, z=4mm

## Other Data

DUT Position : Touch  
 Separation : 0  
 Channel : Low



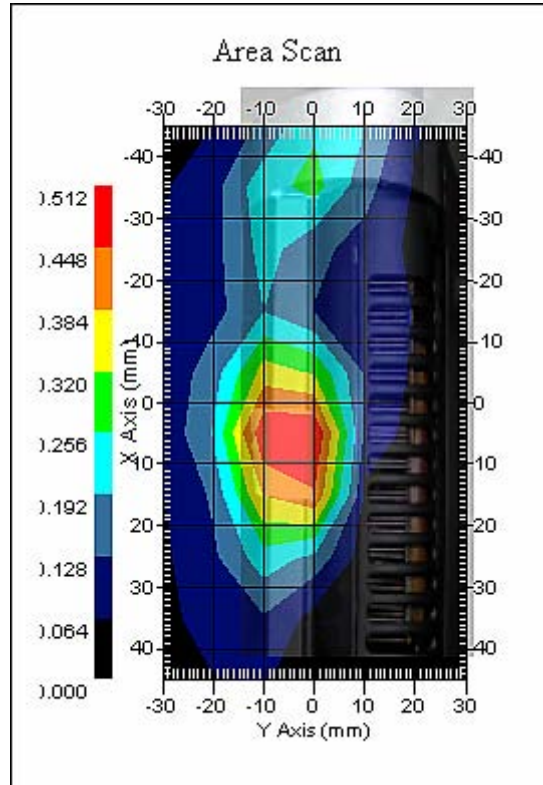

1 gram SAR value : 0.454 W/kg  
 Zoom Scan Peak SAR : 0.990 W/kg





SAR & HAC Instruments for Wireless • Consulting • Research • Standards • Compliance • Training

**Exposure Assessment Measurement Uncertainty**

Source of Uncertainty	Tolerance Value	Probability Distribution	Divisor	$c_i^1$ (1-g)	$c_i^1$ (10-g)	Standard Uncertainty (1-g) %	Standard Uncertainty (10-g) %
Measurement System							
Probe Calibration	3.5	normal	1	1	1	3.5	3.5
Axial Isotropy	3.7	rectangular	•3	$(1-cp)^{1/2}$	$(1-cp)^{1/2}$	1.5	1.5
Hemispherical Isotropy	10.9	rectangular	•3	•cp	•cp	4.4	4.4
Boundary Effect	1.0	rectangular	•3	1	1	0.6	0.6
Linearity	4.7	rectangular	•3	1	1	2.7	2.7
Detection Limit	1.0	rectangular	•3	1	1	0.6	0.6
Readout Electronics	1.0	normal	1	1	1	1.0	1.0
Response Time	0.8	rectangular	•3	1	1	0.5	0.5
Integration Time	1.7	rectangular	•3	1	1	1.0	1.0
RF Ambient Condition	3.0	rectangular	•3	1	1	1.7	1.7
Probe Positioner Mech.	0.4	rectangular	•3	1	1	0.2	0.2
Restriction							
Probe Positioning with respect to Phantom Shell	2.9	rectangular	•3	1	1	1.7	1.7
Extrapolation and Integration	3.7	rectangular	•3	1	1	2.1	2.1
Test Sample Positioning	4.0	normal	1	1	1	4.0	4.0
Device Holder Uncertainty	2.0	normal	1	1	1	2.0	2.0
Drift of Output Power	7.2	rectangular	•3	1	1	4.2	4.2
Phantom and Setup							
Phantom Uncertainty (shape & thickness tolerance)	3.4	rectangular	•3	1	1	2.0	2.0
Liquid Conductivity (target)	5.0	rectangular	•3	0.7	0.5	2.0	1.4
Liquid Conductivity (meas.)	1.0	normal	1	0.7	0.5	0.7	0.5
Liquid Permittivity (target)	5.0	rectangular	•3	0.6	0.5	1.7	1.4
Liquid Permittivity (meas.)	3.8	normal	1	0.6	0.5	2.3	1.9
Combined Uncertainty		RSS				10.4	10.2
Combined Uncertainty (coverage factor=2)		Normal (k=2)				20.8	20.4



## SAR-Z Axis at Hotspot x:20.26 y:-8.15

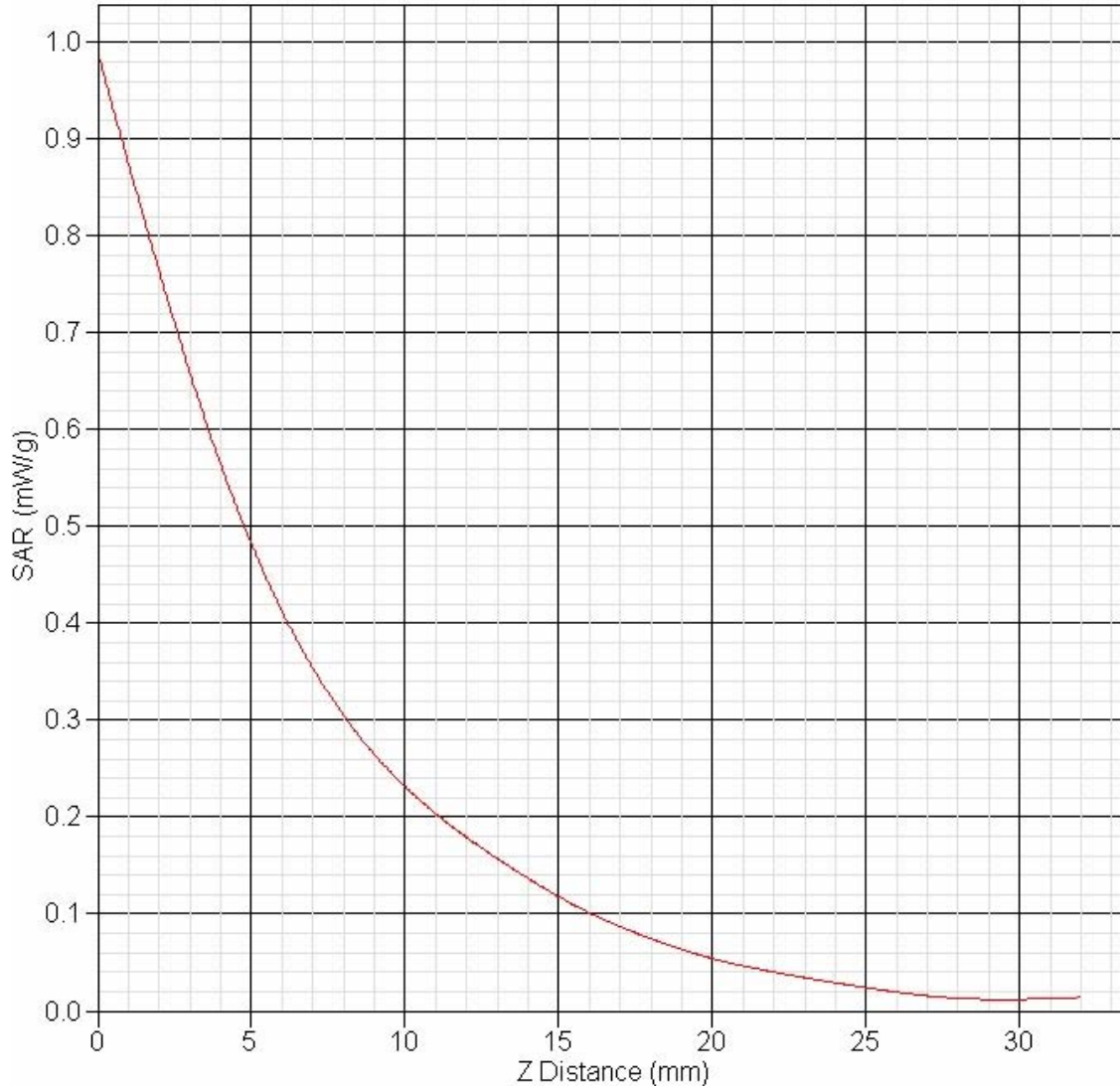



## SAR Test Report

Report Date : 06-Sep-2007  
 By Operator : 123  
 Measurement Date : 06-Sep-2007  
 Starting Time : 06-Sep-2007 12:53:56 PM  
 End Time : 06-Sep-2007 01:13:55 PM  
 Scanning Time : 1199 secs

Product Data  
 Device Name : Dell Hawk-2  
 Serial No. : PS069891  
 Type : Other  
 Model : HAW-E2-C1  
 Frequency : 2450.00 MHz  
 Max. Transmit Pwr : 0.05 W  
 Drift Time : 0 min(s)  
 Length : 110 mm  
 Width : 46 mm  
 Depth : 0 mm  
 Antenna Type : Internal  
 Orientation : Touch  
 Power Drift-Start : 0.284 W/kg  
 Power Drift-Finish: 0.278 W/kg  
 Power Drift (%) : -1.980  
 Picture : C:\alsas\bitmap\Dell-Hawk-Back.bmp

Phantom Data  
 Name : APREL-Uni  
 Type : Uni-Phantom  
 Size (mm) : 280 x 280 x 200  
 Serial No. : User Define  
 Location : Center  
 Description : U

Tissue Data  
 Type : BODY  
 Serial No. : 2450B  
 Frequency : 2450.00 MHz  
 Last Calib. Date : 05-Sep-2007  
 Temperature : 21.00 °C  
 Ambient Temp. : 23.00 °C  
 Humidity : 35.00 RH%  
 Epsilon : 50.70 F/m  
 Sigma : 1.97 S/m  
 Density : 1000.00 kg/cu. m



## Probe Data

Name : APREL  
 Model : E-020  
 Type : E-Field Triangle  
 Serial No. : 225  
 Last Calib. Date : 03-May-2007  
 Frequency : 2450.00 MHz  
 Duty Cycle Factor: 1  
 Conversion Factor: 4.4  
 Probe Sensitivity: 1.20 1.20 1.20  $\mu\text{V}/(\text{V}/\text{m})^2$   
 Compression Point: 95.00 mV  
 Offset : 1.56 mm

## Measurement Data

Crest Factor : 1  
 Scan Type : Complete  
 Tissue Temp. : 21.00 °C  
 Ambient Temp. : 21.00 °C  
 Set-up Date : 06-Sep-2007  
 Set-up Time : 12:53:23 PM  
 Area Scan : 10x7x1 : Measurement x=10mm, y=10mm, z=4mm  
 Zoom Scan : 5x5x8 : Measurement x=8mm, y=8mm, z=4mm

## Other Data

DUT Position : Touch  
 Separation : 0  
 Channel : Mid



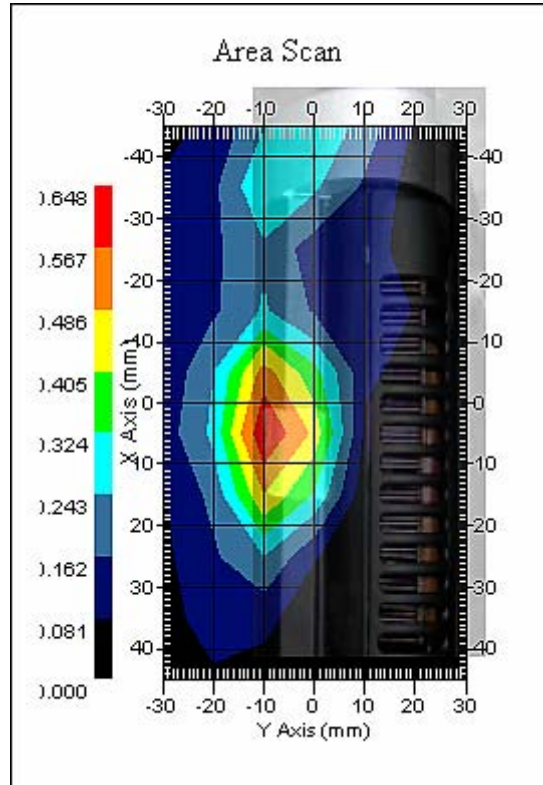

1 gram SAR value : 0.590 W/kg  
Zoom Scan Peak SAR : 1.171 W/kg





SAR & HAC Instruments for Wireless • Consulting • Research • Standards • Compliance • Training

**Exposure Assessment Measurement Uncertainty**

Source of Uncertainty	Tolerance Value	Probability Distribution	Divisor	$c_i^1$ (1-g)	$c_i^1$ (10-g)	Standard Uncertainty (1-g) %	Standard Uncertainty (10-g) %
Measurement System							
Probe Calibration	3.5	normal	1	1	1	3.5	3.5
Axial Isotropy	3.7	rectangular	•3	$(1-cp)^{1/2}$	$(1-cp)^{1/2}$	1.5	1.5
Hemispherical Isotropy	10.9	rectangular	•3	•cp	•cp	4.4	4.4
Boundary Effect	1.0	rectangular	•3	1	1	0.6	0.6
Linearity	4.7	rectangular	•3	1	1	2.7	2.7
Detection Limit	1.0	rectangular	•3	1	1	0.6	0.6
Readout Electronics	1.0	normal	1	1	1	1.0	1.0
Response Time	0.8	rectangular	•3	1	1	0.5	0.5
Integration Time	1.7	rectangular	•3	1	1	1.0	1.0
RF Ambient Condition	3.0	rectangular	•3	1	1	1.7	1.7
Probe Positioner Mech.	0.4	rectangular	•3	1	1	0.2	0.2
Restriction							
Probe Positioning with respect to Phantom Shell	2.9	rectangular	•3	1	1	1.7	1.7
Extrapolation and Integration	3.7	rectangular	•3	1	1	2.1	2.1
Test Sample Positioning	4.0	normal	1	1	1	4.0	4.0
Device Holder Uncertainty	2.0	normal	1	1	1	2.0	2.0
Drift of Output Power	1.0	rectangular	•3	1	1	1.0	1.0
Phantom and Setup							
Phantom Uncertainty (shape & thickness tolerance)	3.4	rectangular	•3	1	1	2.0	2.0
Liquid Conductivity (target)	5.0	rectangular	•3	0.7	0.5	2.0	1.4
Liquid Conductivity (meas.)	1.0	normal	1	0.7	0.5	0.7	0.5
Liquid Permittivity (target)	5.0	rectangular	•3	0.6	0.5	1.7	1.4
Liquid Permittivity (meas.)	3.8	normal	1	0.6	0.5	2.3	1.9
Combined Uncertainty		RSS				10.4	10.2
Combined Uncertainty (coverage factor=2)		Normal (k=2)				20.8	20.4

