



SAR & HAC Instruments for Wireless • Consulting • Research • Standards • Compliance • Training

## Appendices

Calibration documents

Antenna Information



# NCL CALIBRATION LABORATORIES

Calibration File No: DC-789  
Project Number: APREL-ALSAS10U

## CERTIFICATE OF CALIBRATION

It is certified that the equipment identified below has been calibrated in the  
**NCL CALIBRATION LABORATORIES** by qualified personnel following recognized  
procedures and using transfer standards traceable to NRC/NIST.

APREL Validation Dipole

Manufacturer: APREL Laboratories

Part number: ALS-D-5200-S-2

Frequency: 5200 MHz

Serial No: 301460

Customer: APREL

Calibrated: 1<sup>st</sup> March 2007  
Released on: 1<sup>st</sup> March 2007

Released By: \_\_\_\_\_

### **NCL** CALIBRATION LABORATORIES

51 SPECTRUM WAY  
NEPEAN, ONTARIO  
CANADA K2R 1E6

Division of APREL Lab.  
TEL: (613) 820-4988  
FAX: (613) 820-4162

## **Conditions**

Dipole 301460 was new and taken from stock prior to calibration.

**Ambient Temperature of the Laboratory:** 22 °C +/- 0.5°C

**Temperature of the Tissue:** 21 °C +/- 0.5°C

**We the undersigned attest that to the best of our knowledge the calibration of this device has been accurately conducted and that all information contained within this report has been reviewed for accuracy.**

-----  
**Stuart Nicol**

-----  
**C. Teodorian**

## Calibration Results Summary

The following results relate the Calibrated Dipole and should be used as a quick reference for the user.

### Mechanical Dimensions

**Length:** 23.6 mm  
**Height:** 14.0 mm

### Electrical Specification

**SWR:** 1.12 U  
**Return Loss:** -24.9 dB  
**Impedance:** 55.8  $\Omega$

### System Validation Results

Frequency	1 Gram	10 Gram	Peak
5200 MHz	58.8	x	223.1

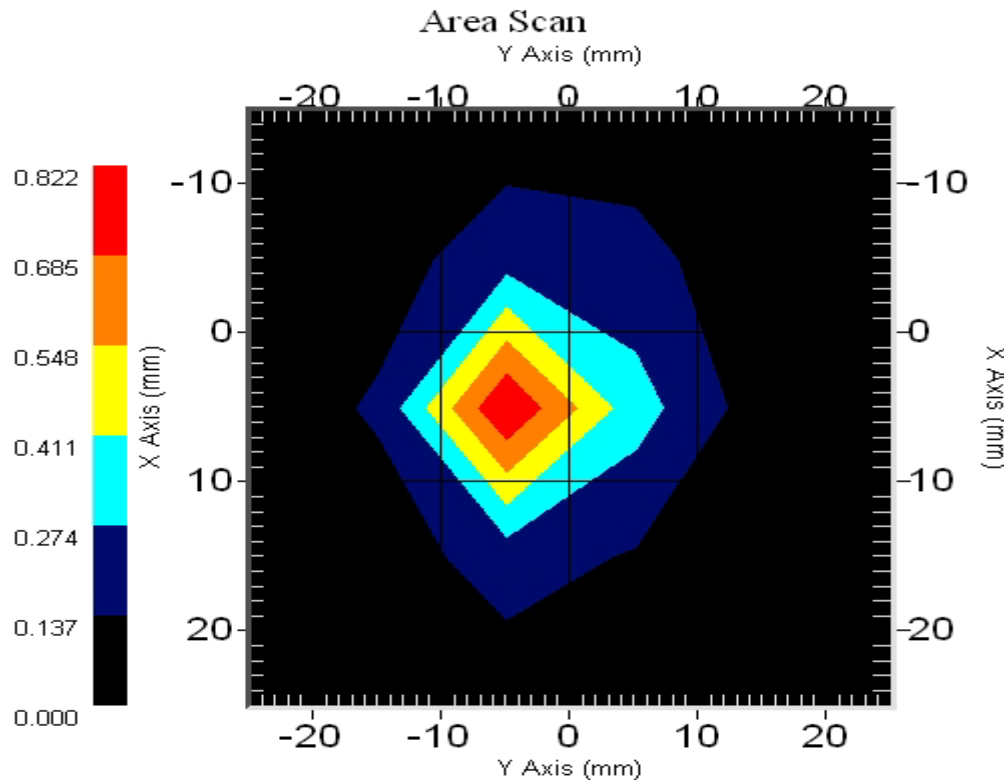

## **Introduction**

This Calibration Report has been produced in line with the SSI Dipole Calibration Procedure SSI-TP-018-ALSAS. The results contained within this report are for Validation Dipole 301460. The calibration routine consisted of a three-step process. Step 1 was a mechanical verification of the dipole to ensure that it meets the mechanical specifications. Step 2 was an Electrical Calibration for the Validation Dipole, where the SWR, Impedance, and the Return loss were assessed. Step 3 involved a System Validation using the ALSAS-10U, along with APREL E-020 130 MHz to 26 GHz E-Field Probe Serial Number 212.

## **References**

SSI-TP-018-ALSAS Dipole Calibration Procedure

SSI-TP-016 Tissue Calibration Procedure

IEEE 1528 “Recommended Practice for Determining the Peak Spatial-Average Specific Absorption Rate (SAR) in the Human Body Due to Wireless Communications Devices: Experimental Techniques”

IEC-62209 “Human exposure to radio frequency fields from hand-held and body-mounted wireless communication devices – Human models, instrumentation, and procedures”

Part 1: “Procedure to determine the Specific Absorption Rate (SAR) for hand-held devices used in close proximity of the ear (frequency range of 300 MHz to 3 GHz)”

IEC-62209 “Human exposure to radio frequency fields from hand-held and body-mounted wireless communication devices – Human models, instrumentation, and procedures”

Part 2 *Draft*: “Procedure to determine the Specific Absorption Rate (SAR) for hand-held devices used in close proximity of the ear (frequency range of 30 MHz to 6 GHz)”

## **Conditions**

Dipole 301460 was new taken from stock.

**Ambient Temperature of the Laboratory:** 22 °C +/- 0.5°C

**Temperature of the Tissue:** 20 °C +/- 0.5°C

## Dipole Calibration Results

### Mechanical Verification

<b>APREL Length</b>	<b>APREL Height</b>	<b>Measured Length</b>	<b>Measured Height</b>
23.6 mm	14.0 mm	23.4 mm	16.6 mm

### Tissue Validation

<b>Head Tissue 5200 MHz</b>	<b>Measured</b>
<b>Dielectric constant, <math>\epsilon_r</math></b>	49.0
<b>Conductivity, <math>\sigma</math> [S/m]</b>	5.4

**Electrical Calibration**

Test	Result
S11 R/L	-24.9 dB
SWR	1.12 U
Impedance	55.8 $\Omega$

The Following Graphs are the results as displayed on the Vector Network Analyzer.

**S11 Parameter Return Loss**

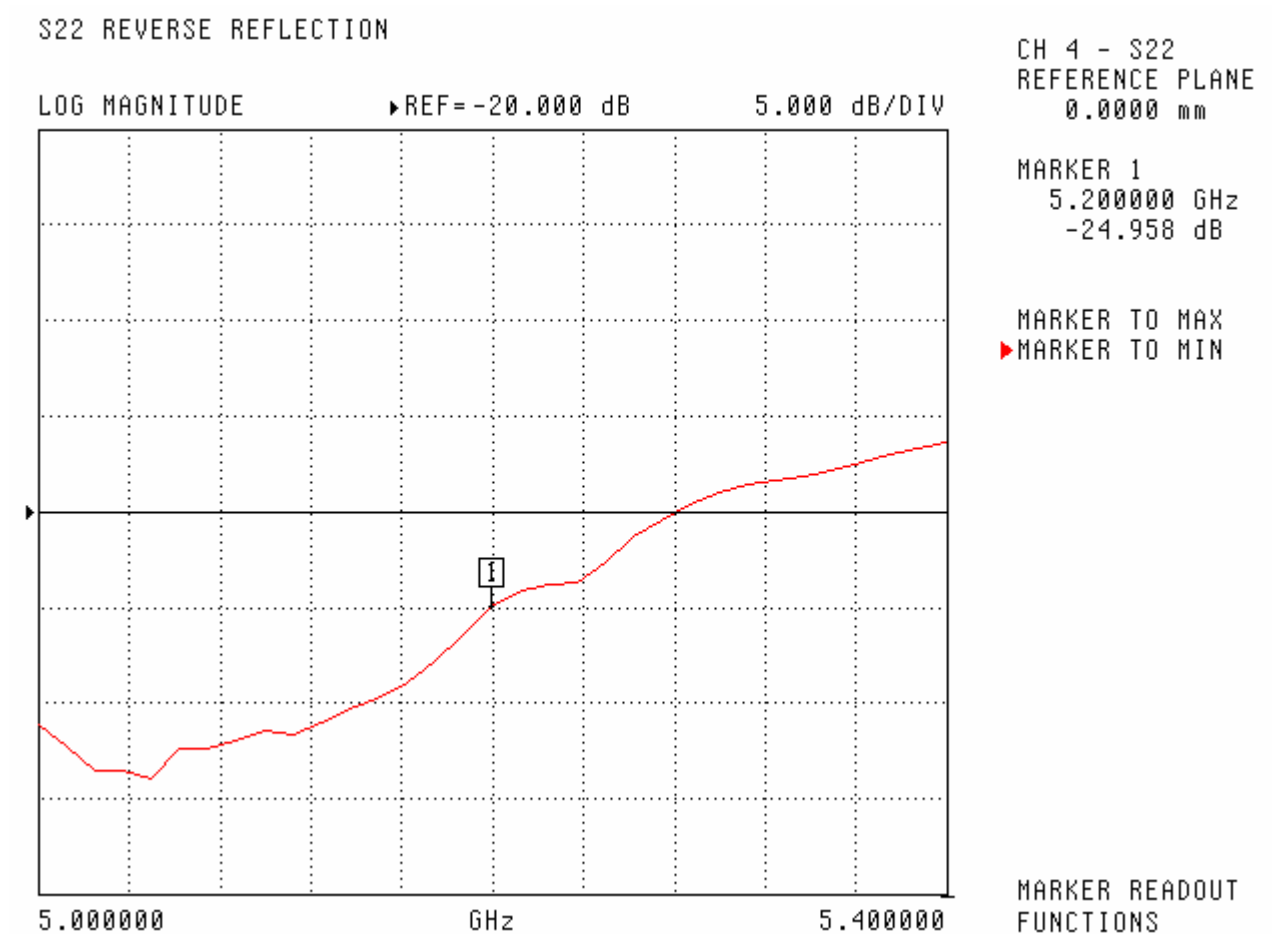

SWR

S22 REVERSE REFLECTION

SWR

REF=1.200 U

50.000 mU/DIV

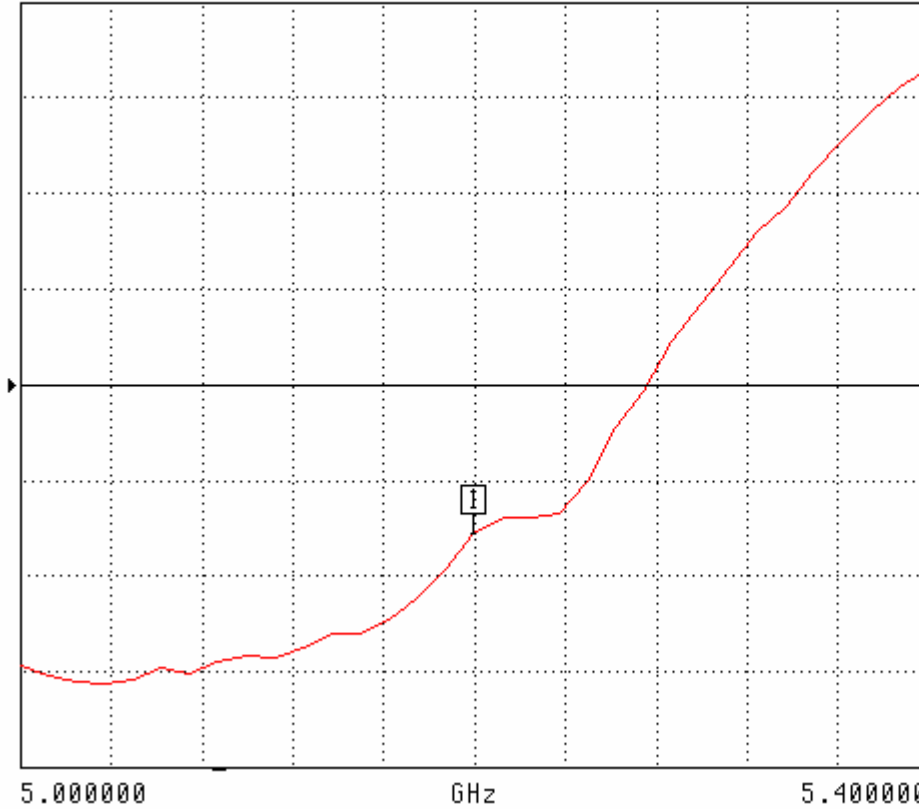

CH 4 - S22  
REFERENCE PLANE  
0.0000 mm

MARKER 1  
5.200000 GHz  
1.122 U

MARKER TO MAX  
▶ MARKER TO MIN

MARKER READOUT  
FUNCTIONS



### Smith Chart Dipole Impedance

S22 REVERSE REFLECTION  
IMPEDANCE

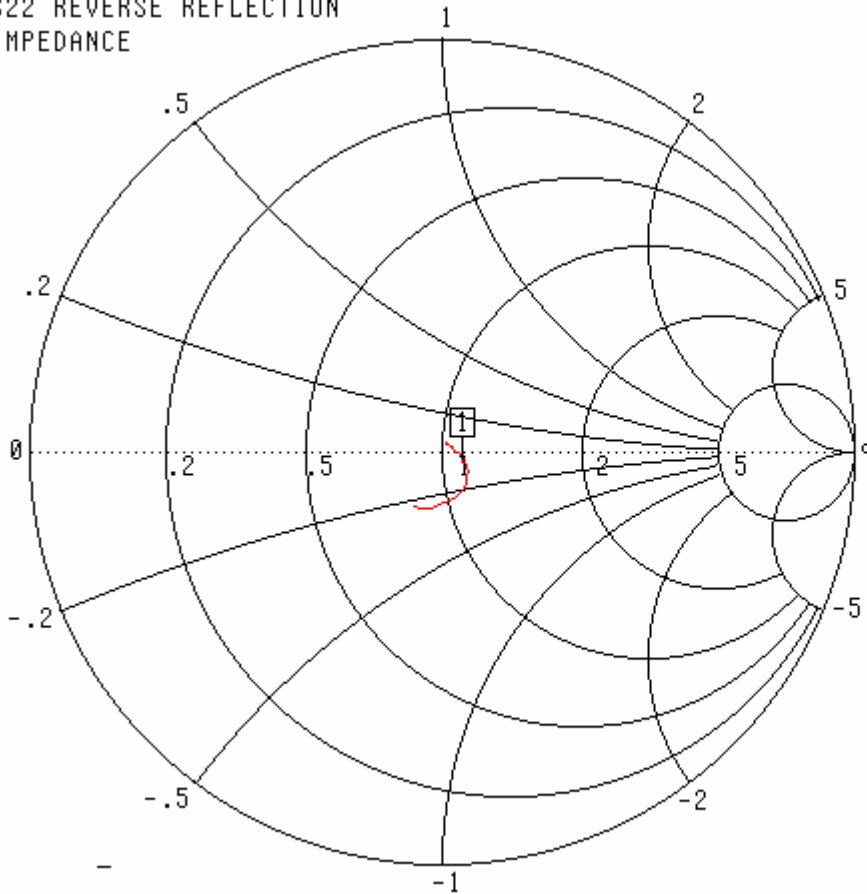

5.000000 - 5.400000 GHz

CH 4 - S22  
REFERENCE PLANE  
0.0000 mm

MARKER 1  
5.200000 GHz  
55.763  $\Omega$   
-1.570  $j\Omega$

MARKER TO MAX  
▶ MARKER TO MIN

MARKER READOUT  
FUNCTIONS

**System Validation Results Using the Electrically Calibrated Dipole**

Head Tissue Frequency	1 Gram	10 Gram	Peak Above Feed Point
5200 MHz	58.8	x	223.1

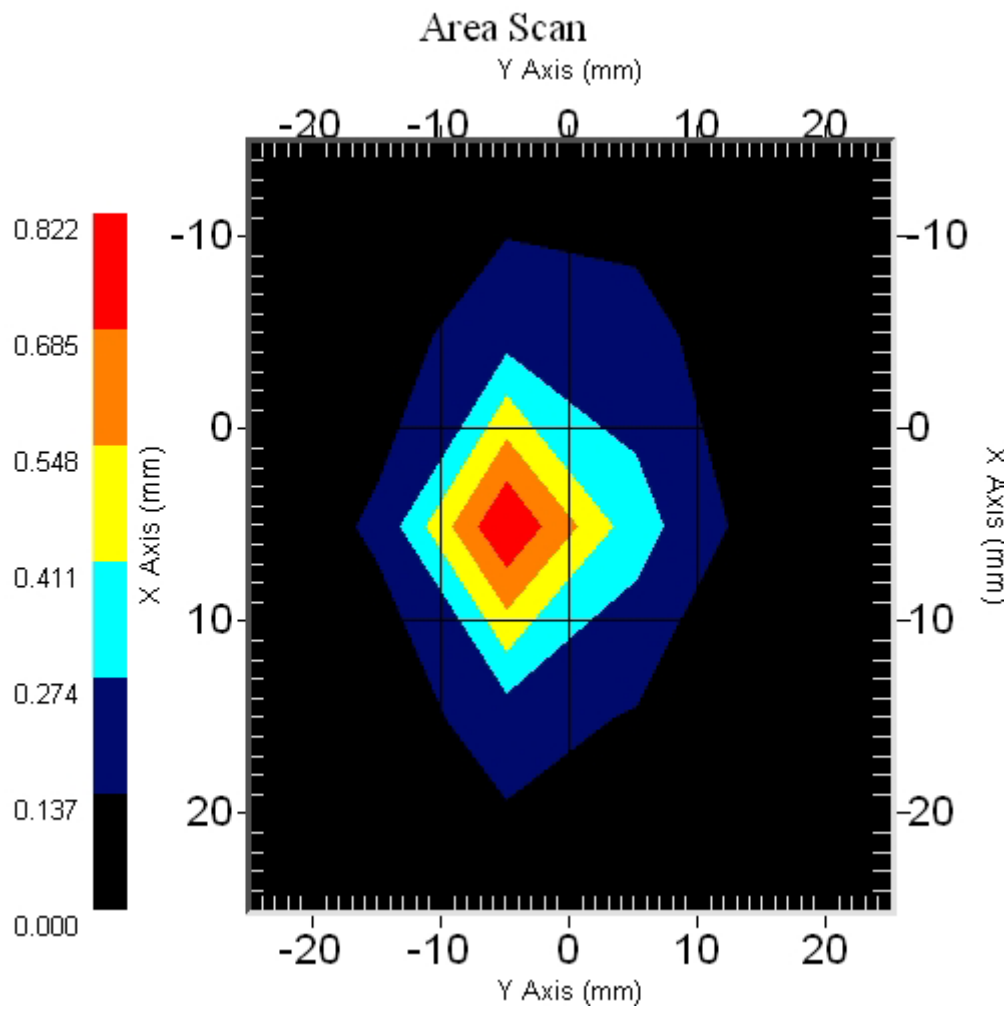

## **Test Equipment**

The test equipment used during Probe Calibration, manufacturer, model number and, current calibration status are listed and located on the main APREL server R:\NCL\Calibration Equipment\Instrument List May 2007.

# NCL CALIBRATION LABORATORIES

Calibration File No: DC-788  
Project Number: APREL-ALSAS10U

## C E R T I F I C A T E   O F   C A L I B R A T I O N

It is certified that the equipment identified below has been calibrated in the  
**NCL CALIBRATION LABORATORIES** by qualified personnel following recognized  
procedures and using transfer standards traceable to NRC/NIST.

APREL Validation Dipole

Manufacturer: APREL Laboratories

Part number: ALS-D-2450-S-2

Frequency: 2450 MHz

Serial No: 301581

Customer: APREL

Calibrated: 11<sup>th</sup> November 2006  
Released on: 11<sup>th</sup> November 2006

Released By: \_\_\_\_\_

### **NCL** CALIBRATION LABORATORIES

51 SPECTRUM WAY  
NEPEAN, ONTARIO  
CANADA K2R 1E6

Division of APREL Lab.  
TEL: (613) 820-4988  
FAX: (613) 820-4162

## **Conditions**

Dipole 301581 was new and taken from stock prior to calibration.

**Ambient Temperature of the Laboratory:** 22 °C +/- 0.5°C

**Temperature of the Tissue:** 21 °C +/- 0.5°C

**We the undersigned attest that to the best of our knowledge the calibration of this device has been accurately conducted and that all information contained within this report has been reviewed for accuracy.**

-----  
**Stuart Nicol**  
**Director Product Development**

-----  
**D. Brooks**  
**Member of Engineering Staff**  
**(Calibration Engineer)**

## Calibration Results Summary

The following results relate the Calibrated Dipole and should be used as a quick reference for the user.

### Mechanical Dimensions

**Length:** 52.4 mm  
**Height:** 30.3 mm

### Electrical Specification

**SWR:** 1.056 U  
**Return Loss:** -32.0 dB  
**Impedance:** 50.2  $\Omega$

### System Validation Results

Frequency	1 Gram	10 Gram	Peak
2450 MHz	53.1	24.4	101.8

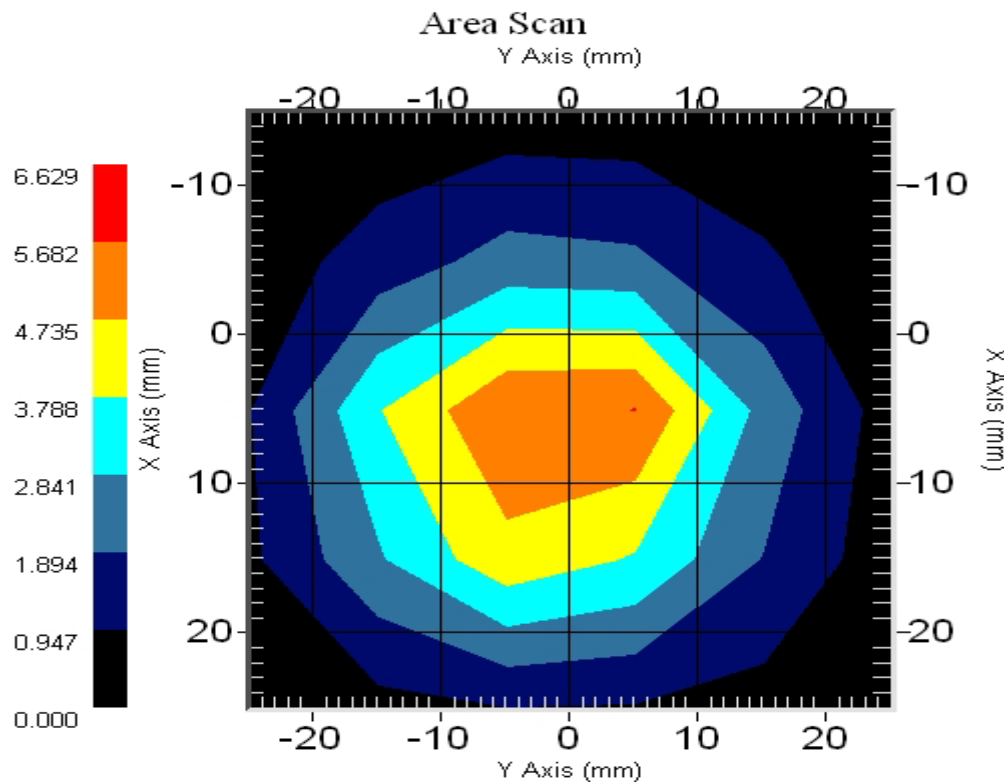

## **Introduction**

This Calibration Report has been produced in line with the SSI Dipole Calibration Procedure SSI-TP-018-ALSAS. The results contained within this report are for Validation Dipole 301581. The calibration routine consisted of a three-step process. Step 1 was a mechanical verification of the dipole to ensure that it meets the mechanical specifications. Step 2 was an Electrical Calibration for the Validation Dipole, where the SWR, Impedance, and the Return loss were assessed. Step 3 involved a System Validation using the ALSAS-10U, along with APREL E-020 130 MHz to 26 GHz E-Field Probe Serial Number 212.

## **References**

SSI-TP-018-ALSAS Dipole Calibration Procedure

SSI-TP-016 Tissue Calibration Procedure

IEEE 1528 “Recommended Practice for Determining the Peak Spatial-Average Specific Absorption Rate (SAR) in the Human Body Due to Wireless Communications Devices: Experimental Techniques”

IEC-62209 “Human exposure to radio frequency fields from hand-held and body-mounted wireless communication devices – Human models, instrumentation, and procedures”

Part 1: “Procedure to determine the Specific Absorption Rate (SAR) for hand-held devices used in close proximity of the ear (frequency range of 300 MHz to 3 GHz)”

IEC-62209 “Human exposure to radio frequency fields from hand-held and body-mounted wireless communication devices – Human models, instrumentation, and procedures”

Part 2 *Draft*: “Procedure to determine the Specific Absorption Rate (SAR) for hand-held devices used in close proximity of the ear (frequency range of 30 MHz to 6 GHz)”

## **Conditions**

Dipole 301581 was new taken from stock.

**Ambient Temperature of the Laboratory:** 22 °C +/- 0.5°C

**Temperature of the Tissue:** 20 °C +/- 0.5°C

## Dipole Calibration Results

### Mechanical Verification

<b>APREL Length</b>	<b>APREL Height</b>	<b>Measured Length</b>	<b>Measured Height</b>
51.5 mm	30.4 mm	52.4 mm	30.3 mm

### Tissue Validation

<b>Head Tissue 2450 MHz</b>	<b>Measured</b>
<b>Dielectric constant, <math>\epsilon_r</math></b>	39.2
<b>Conductivity, <math>\sigma</math> [S/m]</b>	1.80



**Electrical Calibration**

Test	Result
S11 R/L	-32.0 dB
SWR	1.05 U
Impedance	50.2 $\Omega$

The Following Graphs are the results as displayed on the Vector Network Analyzer.

**S11 Parameter Return Loss**

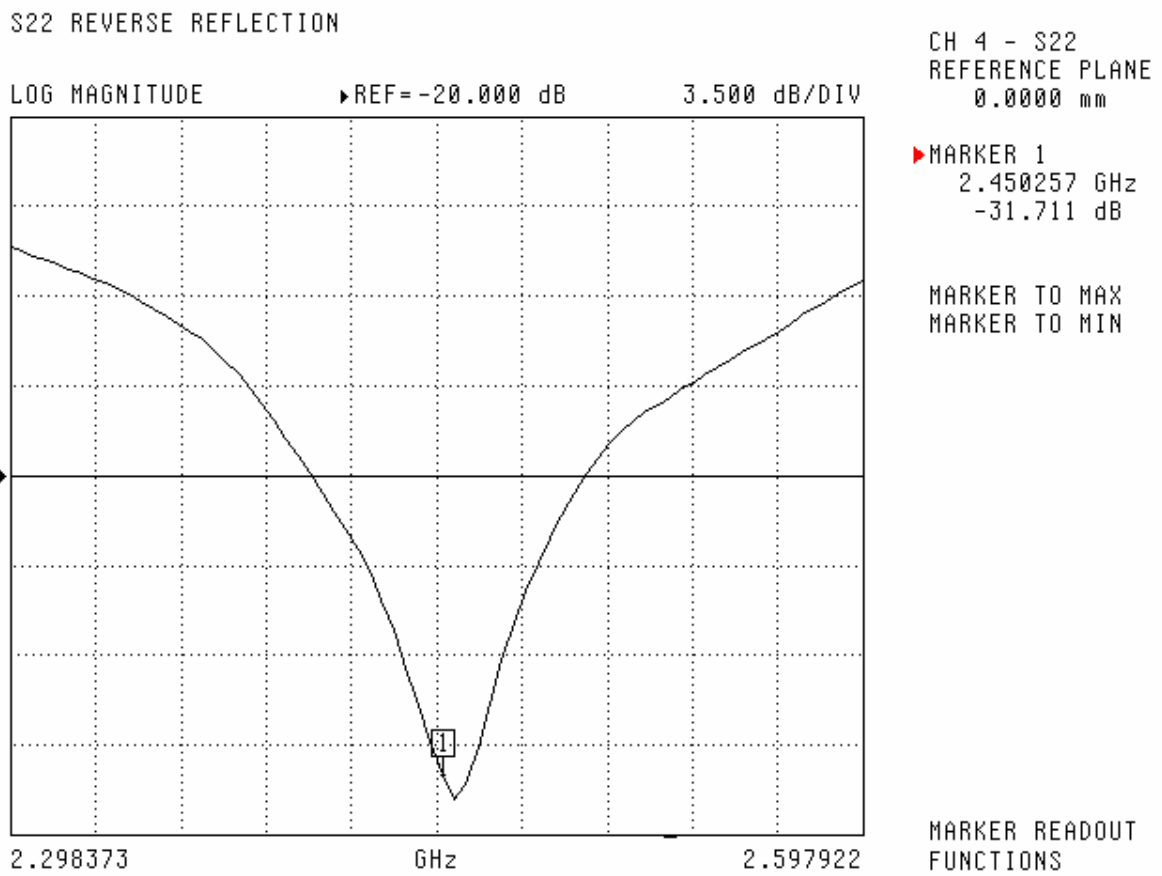

SWR

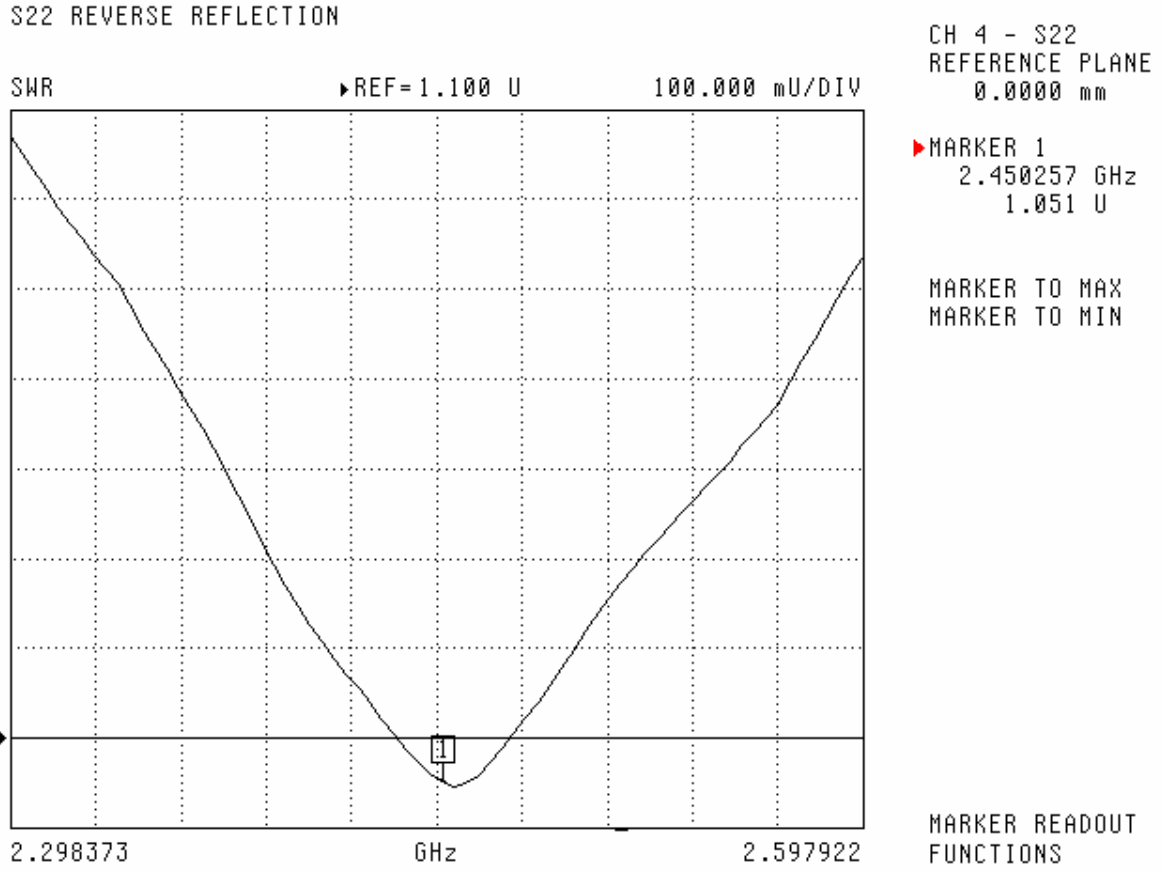

### Smith Chart Dipole Impedance

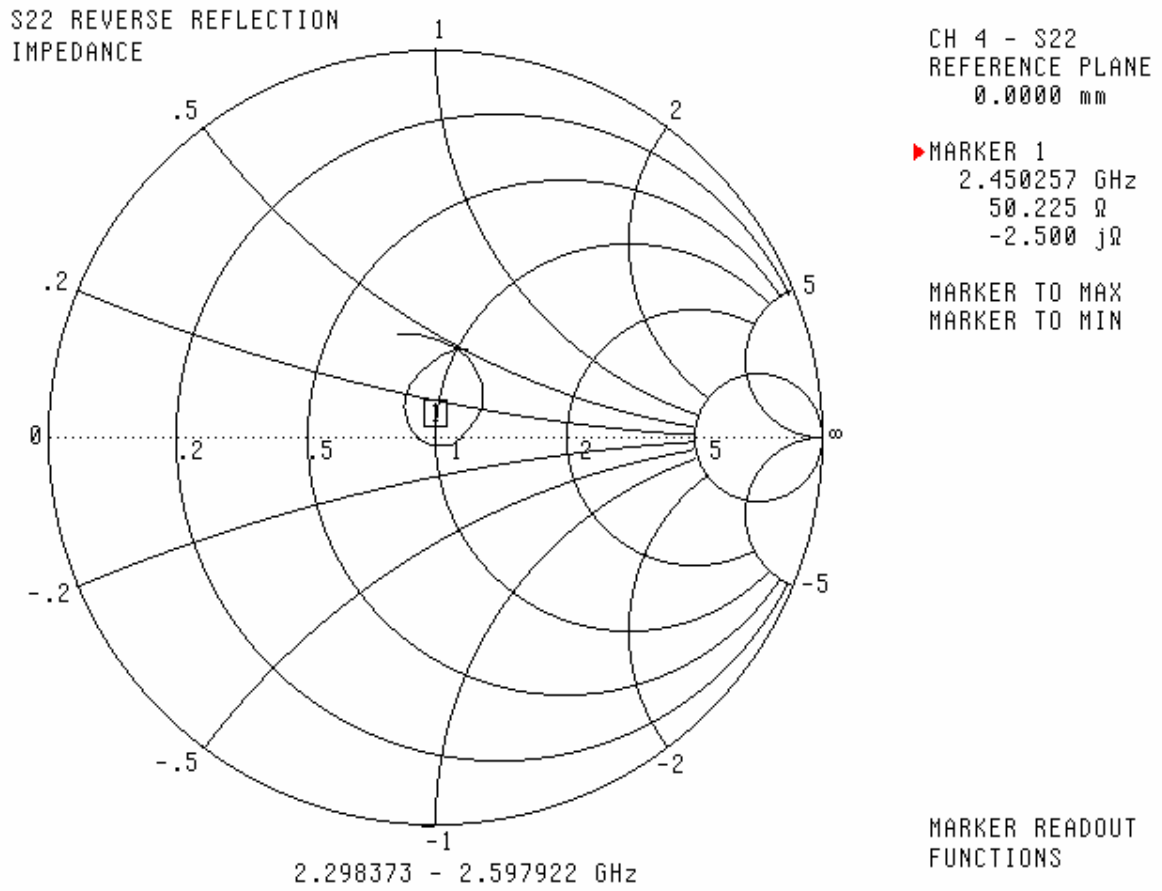

System Validation Results Using the Electrically Calibrated Dipole

Frequency	1 Gram	10 Gram	Peak
2450 MHz	53.1	24.4	101.8

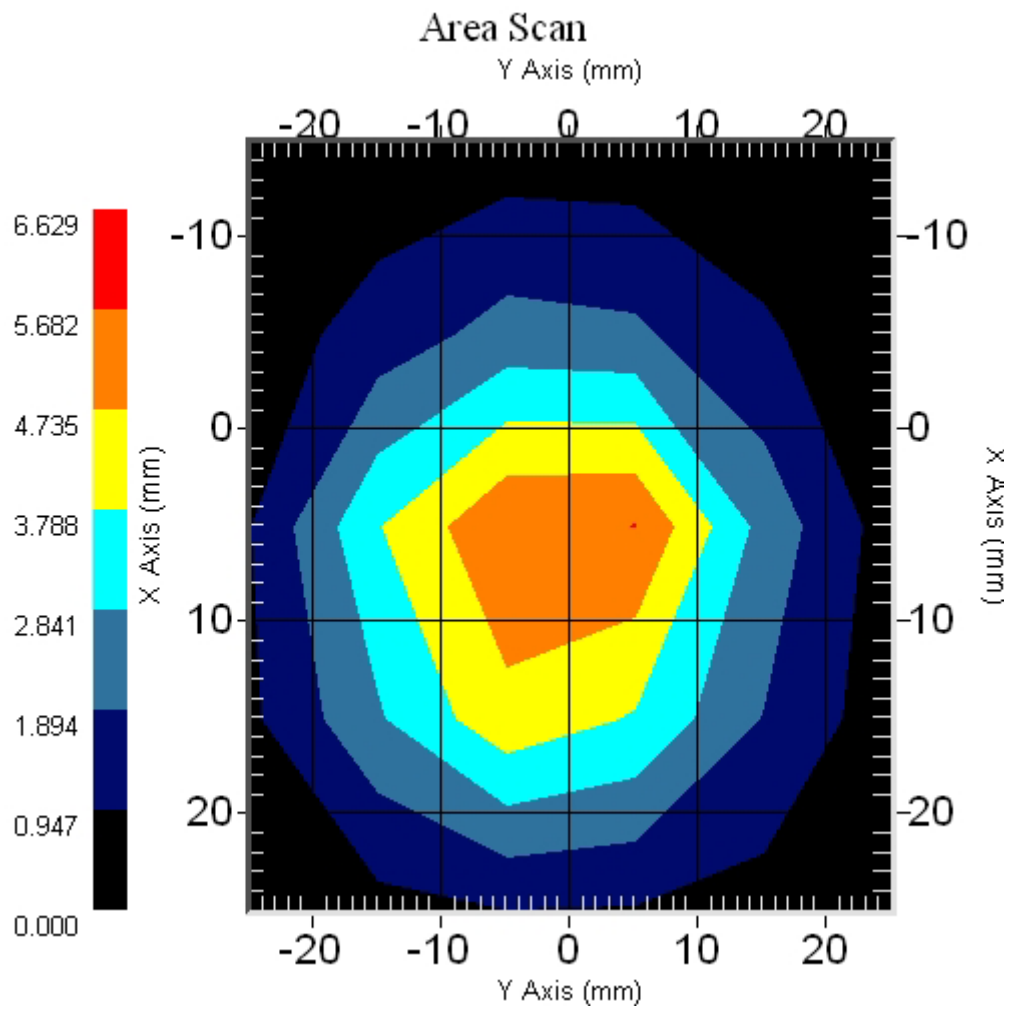

## **Test Equipment**

The test equipment used during Probe Calibration, manufacturer, model number and, current calibration status are listed and located on the main APREL server R:\NCL\Calibration Equipment\Instrument List May 2004

# NCL CALIBRATION LABORATORIES

Calibration File No.: CP-787

Client.: APREL

## CERTIFICATE OF CALIBRATION

It is certified that the equipment identified below has been calibrated in the  
**NCL CALIBRATION LABORATORIES** by qualified personnel following recognized  
procedures and using transfer standards traceable to NRC/NIST.

Equipment: Miniature Isotropic RF Probe 5800 MHz

Manufacturer: APREL Laboratories

Model No.: E-020

Serial No.: 226

Calibration in Body Tissue

Calibration Procedure: SSI/DRB-TP-D01-032-E020-V2

Project No: Internal APREL

Calibrated: 3<sup>rd</sup> May 2007  
Released on: 3<sup>rd</sup> May 2007

This Calibration Certificate is Incomplete Unless Accompanied with the Calibration Results Summary

Released By: \_\_\_\_\_

**NCL** CALIBRATION LABORATORIES

51 SPECTRUM WAY  
NEPEAN, ONTARIO  
CANADA K2R 1E6

Division of APREL Lab.  
TEL: (613) 820-4988  
FAX: (613) 820-4161

## Introduction

This Calibration Report reproduces the results of the calibration performed in line with the SSI/DRB-TP-D01-032-E020-V2 E-Field Probe Calibration Procedure. The results contained within this report are for APREL E-Field Probe E-020 226.

## References

SSI/DRB-TP-D01-032-E020-V2 E-Field Probe Calibration Procedure  
IEEE 1528 "Recommended Practice for Determining the Peak Spatial-Average Specific Absorption Rate (SAR) in the Human Body Due to Wireless Communications Devices: Experimental Techniques"  
SSI-TP-011 Tissue Calibration Procedure

## Conditions

Probe 226 was a new probe taken from stock prior to calibration.

**Ambient Temperature of the Laboratory:** 22 °C +/- 0.5°C  
**Temperature of the Tissue:** 21 °C +/- 0.5°C

**We the undersigned attest that to the best of our knowledge the calibration of this probe has been accurately conducted and that all information contained within this report has been reviewed for accuracy.**

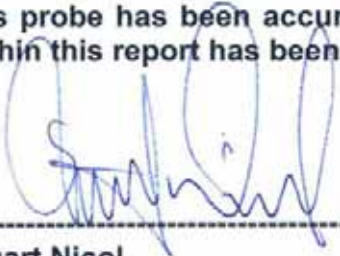

-----  
**Stuart Nicol**



-----  
**Jesse Hones**

## Calibration Results Summary

<b>Probe Type:</b>	E-Field Probe E-020
<b>Serial Number:</b>	226
<b>Frequency:</b>	5800 MHz
<b>Sensor Offset:</b>	1.56 mm
<b>Sensor Length:</b>	2.5 mm
<b>Tip Enclosure:</b>	Ertalyte*
<b>Tip Diameter:</b>	<2.9 mm
<b>Tip Length:</b>	60 mm
<b>Total Length:</b>	290 mm

\*Resistive to recommended tissue recipes per IEEE-1528

## Sensitivity in Air

<b>Channel X:</b>	1.2 $\mu\text{V}/(\text{V}/\text{m})^2$
<b>Channel Y:</b>	1.2 $\mu\text{V}/(\text{V}/\text{m})^2$
<b>Channel Z:</b>	1.2 $\mu\text{V}/(\text{V}/\text{m})^2$
<b>Diode Compression Point:</b>	95 mV



## **Sensitivity in Body Tissue**

**Frequency:** 5800 MHz

**Epsilon:** 48.2 (+/-10%)      **Sigma:** 6.0 S/m (+/-10%)

### **ConvF**

**Channel X:** 4.01

**Channel Y:** 4.01

**Channel Z:** 4.01

Tissue sensitivity values were calculated using the load impedance of the APREL Laboratories Daq-Paq.

### **Boundary Effect:**

Uncertainty resulting from the boundary effect is less than 2% for the distance between the tip of the probe and the tissue boundary, when less than 2.44mm.

### **Spatial Resolution:**

The measured probe tip diameter is 2.9 mm (+/- 0.01 mm) and therefore meets the requirements of SSI/DRB-TP-D01-032 for spatial resolution.

## Receiving Pattern 5800 MHz (Air)

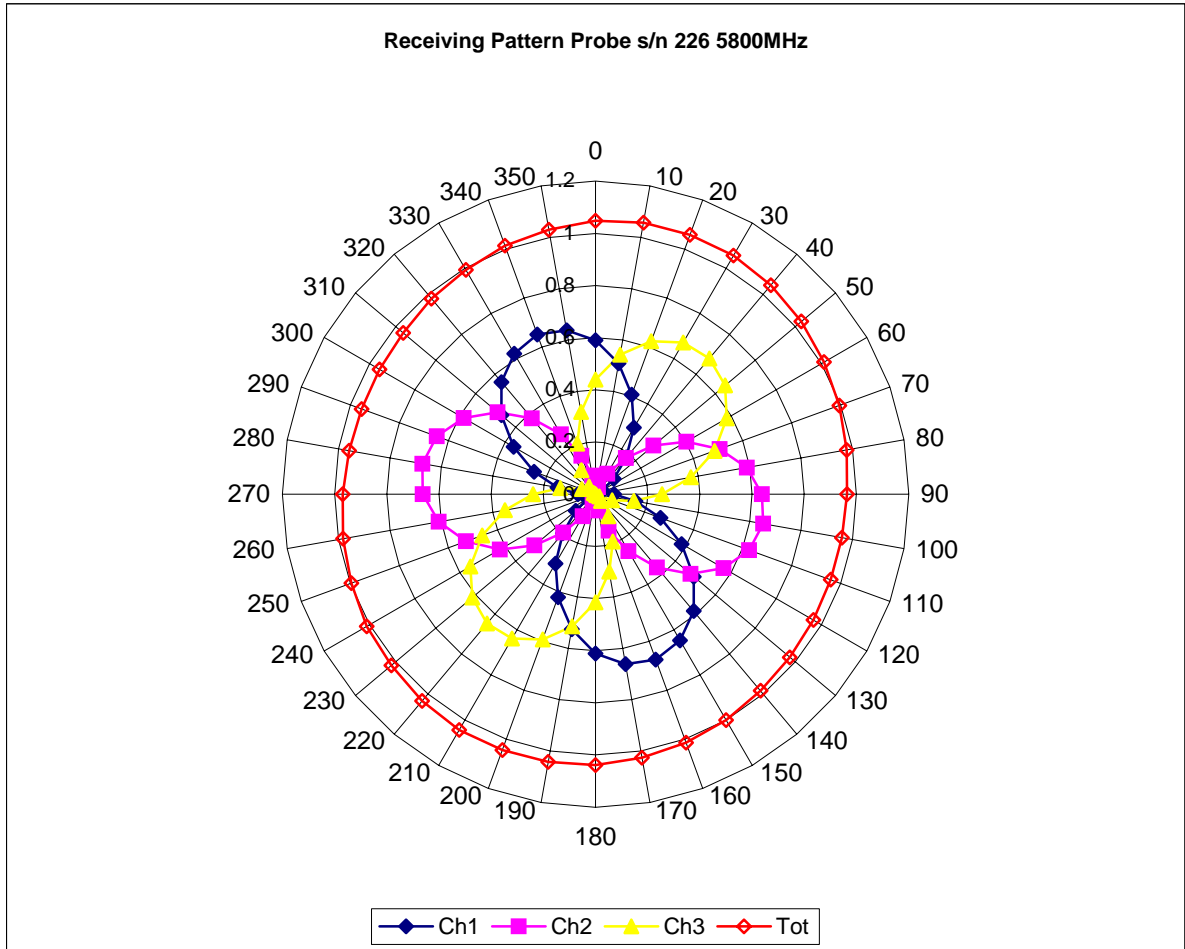

### Isotropy Error 5800 MHz (Air)

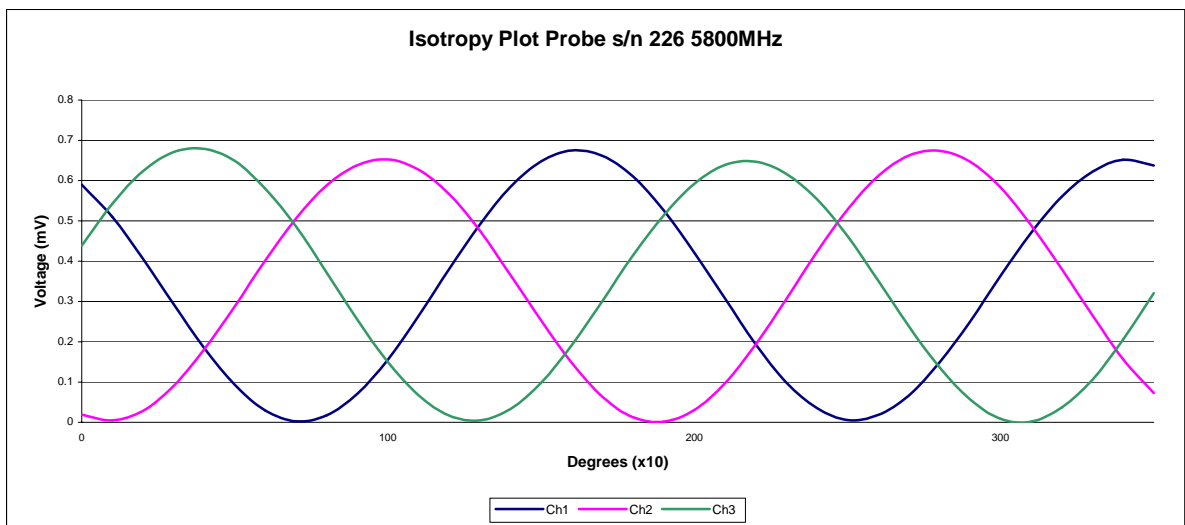
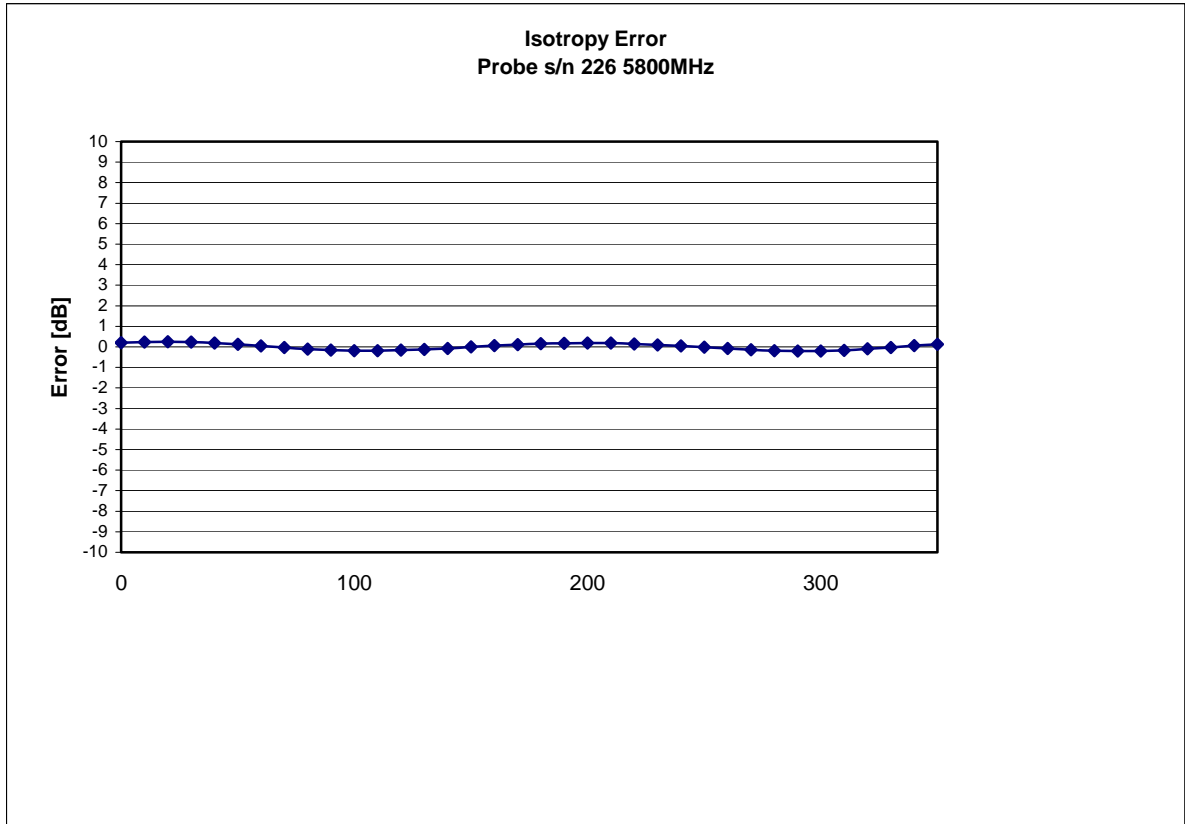

Isotropicity in Tissue:

0.10 dB

## Dynamic Range

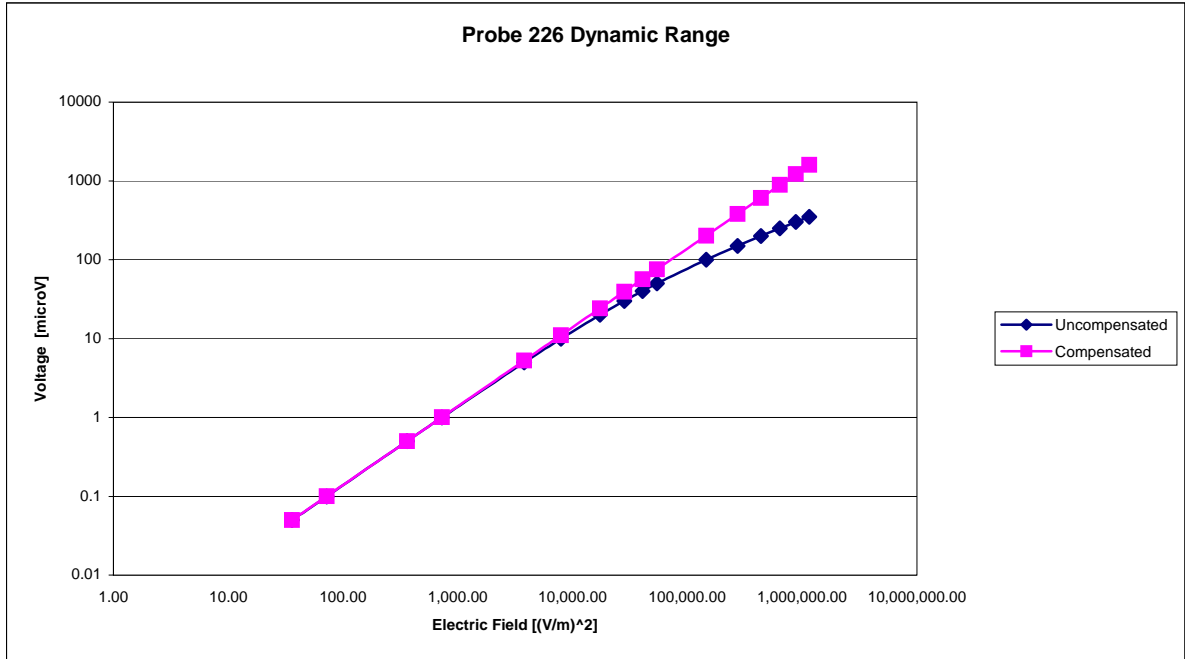

## Video Bandwidth

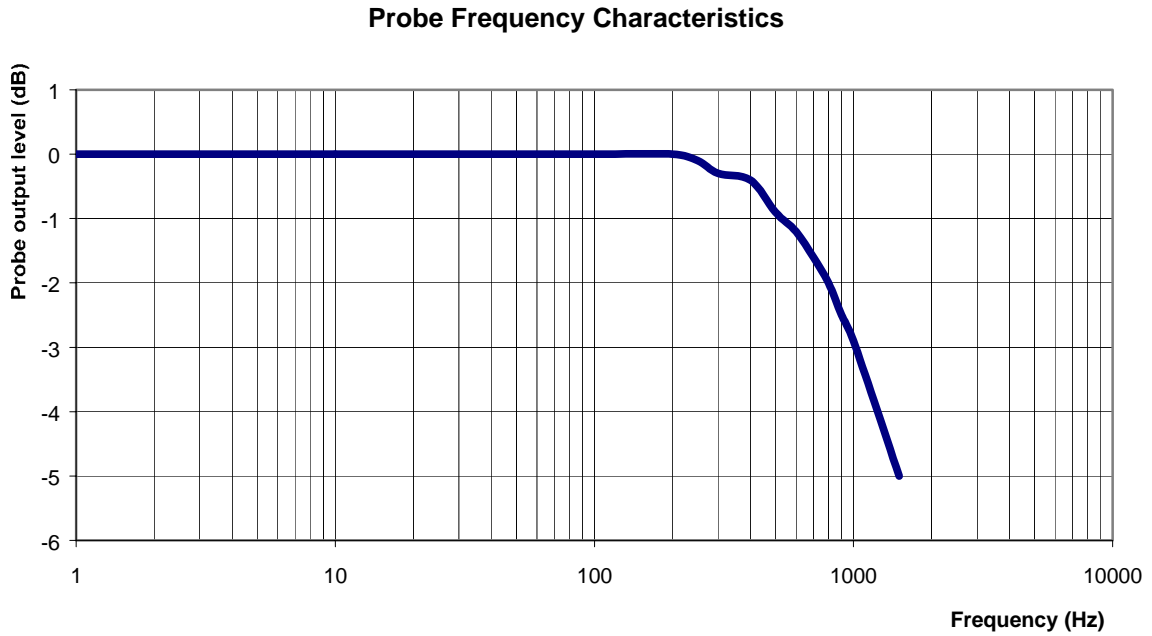

**Video Bandwidth at 500 Hz**                      1 dB  
**Video Bandwidth at 1.02 KHz:**                3 dB

## **Conversion Factor Uncertainty Assessment**

**Frequency:** 5800MHz  
**Epsilon:** 48.2 (+/-10%)      **Sigma:** 6.0 S/m (+/-10%)

### **ConvF**

**Channel X:** 4.01      7%(K=2)

**Channel Y:** 4.01      7%(K=2)

**Channel Z:** 4.01      7%(K=2)

To minimize the uncertainty calculation all tissue sensitivity values were calculated using a load impedance of 5 MΩ.

### **Boundary Effect:**

For a distance of 1.4mm the evaluated uncertainty (increase in the probe sensitivity) is less than 2%.

## **Test Equipment**

The test equipment used during Probe Calibration, manufacturer, model number and, current calibration status are listed and located on the main APREL server R:\NCL\Calibration Equipment\Instrument List May 2007.

# NCL CALIBRATION LABORATORIES

Calibration File No.: CP-786

Client.: APREL

## CERTIFICATE OF CALIBRATION

It is certified that the equipment identified below has been calibrated in the **NCL CALIBRATION LABORATORIES** by qualified personnel following recognized procedures and using transfer standards traceable to NRC/NIST.

Equipment: Miniature Isotropic RF Probe 5200 MHz

Manufacturer: APREL Laboratories

Model No.: E-020

Serial No.: 226

Calibration in Body Tissue

Calibration Procedure: SSI/DRB-TP-D01-032-E020-V2

Project No: Internal APREL

Calibrated: 3<sup>rd</sup> May 2007

Released on: 3<sup>rd</sup> May 2007

This Calibration Certificate is Incomplete Unless Accompanied with the Calibration Results Summary

Released By: \_\_\_\_\_

**NCL** CALIBRATION LABORATORIES

51 SPECTRUM WAY  
NEPEAN, ONTARIO  
CANADA K2R 1E6

Division of APREL Lab.  
TEL: (613) 820-4988  
FAX: (613) 820-4161



## Introduction

This Calibration Report reproduces the results of the calibration performed in line with the SSI/DRB-TP-D01-032-E020-V2 E-Field Probe Calibration Procedure. The results contained within this report are for APREL E-Field Probe E-020 226.

## References

SSI/DRB-TP-D01-032-E020-V2 E-Field Probe Calibration Procedure  
IEEE 1528 "Recommended Practice for Determining the Peak Spatial-Average Specific Absorption Rate (SAR) in the Human Body Due to Wireless Communications Devices: Experimental Techniques"  
SSI-TP-011 Tissue Calibration Procedure

## Conditions

Probe 226 was a new probe taken from stock prior to calibration.

**Ambient Temperature of the Laboratory:** 22 °C +/- 0.5°C  
**Temperature of the Tissue:** 21 °C +/- 0.5°C

**We the undersigned attest that to the best of our knowledge the calibration of this probe has been accurately conducted and that all information contained within this report has been reviewed for accuracy.**

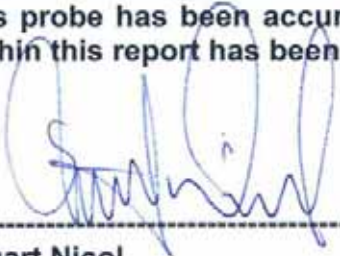

-----  
**Stuart Nicol**



-----  
**Jesse Hones**

## Calibration Results Summary

<b>Probe Type:</b>	E-Field Probe E-020
<b>Serial Number:</b>	226
<b>Frequency:</b>	5200 MHz
<b>Sensor Offset:</b>	1.56 mm
<b>Sensor Length:</b>	2.5 mm
<b>Tip Enclosure:</b>	Ertalyte*
<b>Tip Diameter:</b>	<2.9 mm
<b>Tip Length:</b>	60 mm
<b>Total Length:</b>	290 mm

\*Resistive to recommended tissue recipes per IEEE-1528

## Sensitivity in Air

<b>Channel X:</b>	1.2 $\mu\text{V}/(\text{V}/\text{m})^2$
<b>Channel Y:</b>	1.2 $\mu\text{V}/(\text{V}/\text{m})^2$
<b>Channel Z:</b>	1.2 $\mu\text{V}/(\text{V}/\text{m})^2$
<b>Diode Compression Point:</b>	95 mV

## **Sensitivity in Body Tissue**

**Frequency:** 5200 MHz

**Epsilon:** 43.0 (+/-10%)      **Sigma:** 5.75 S/m (+/-10%)

### **ConvF**

**Channel X:** 3.5

**Channel Y:** 3.5

**Channel Z:** 3.5

Tissue sensitivity values were calculated using the load impedance of the APREL Laboratories Daq-Paq.

### **Boundary Effect:**

Uncertainty resulting from the boundary effect is less than 2% for the distance between the tip of the probe and the tissue boundary, when less than 2.44mm.

### **Spatial Resolution:**

The measured probe tip diameter is 2.9 mm (+/- 0.01 mm) and therefore meets the requirements of SSI/DRB-TP-D01-032 for spatial resolution.

## Receiving Pattern 5200 MHz (Air)

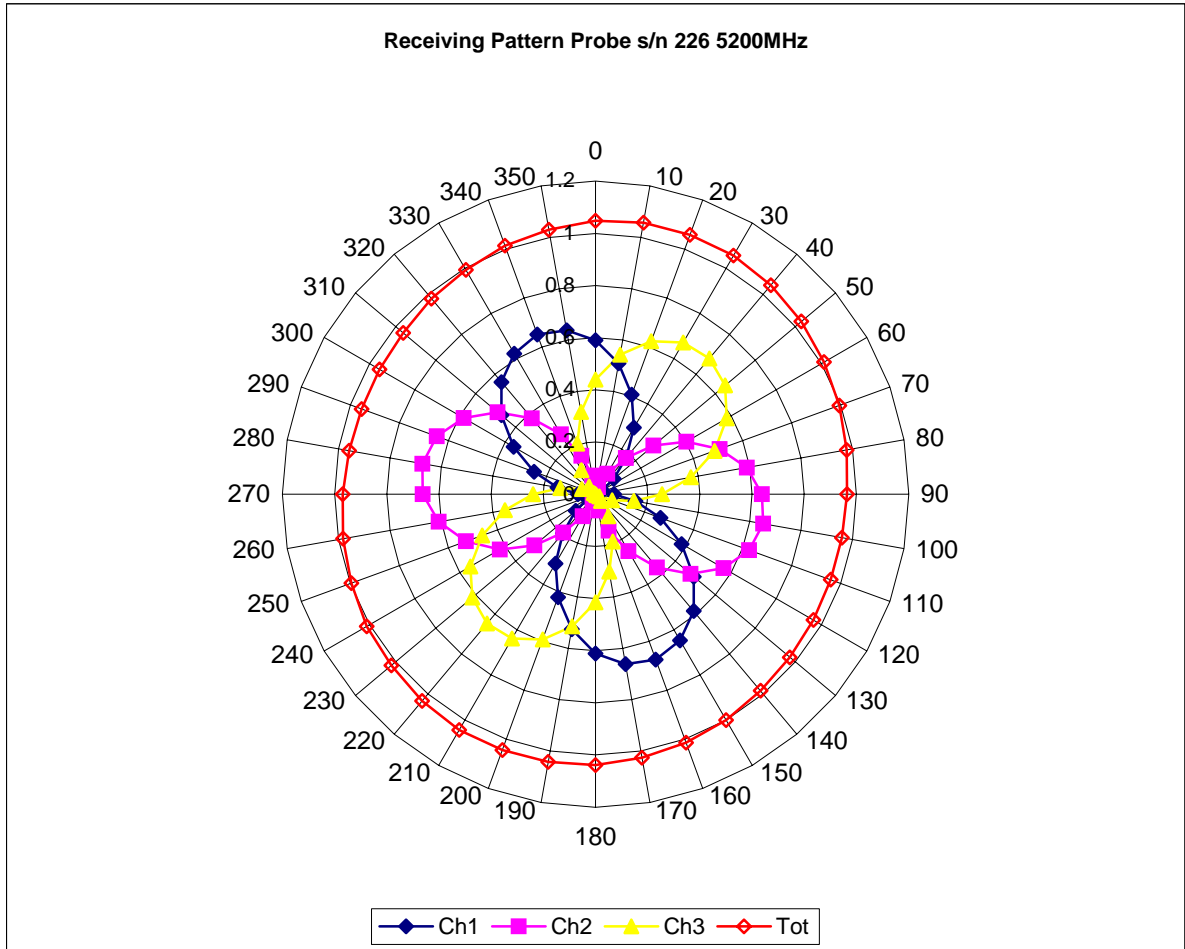

### Isotropy Error 5200 MHz (Air)

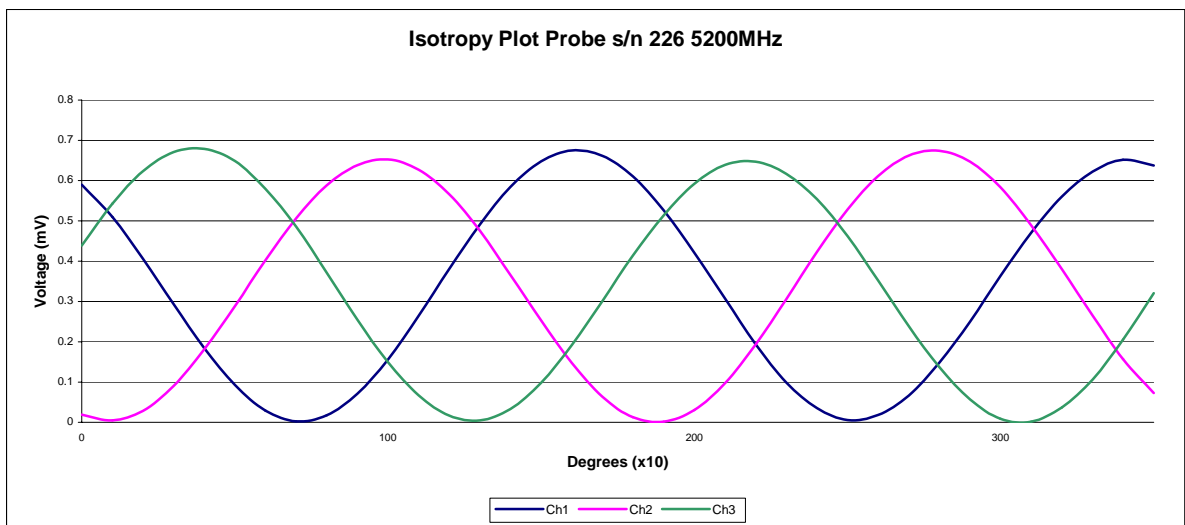
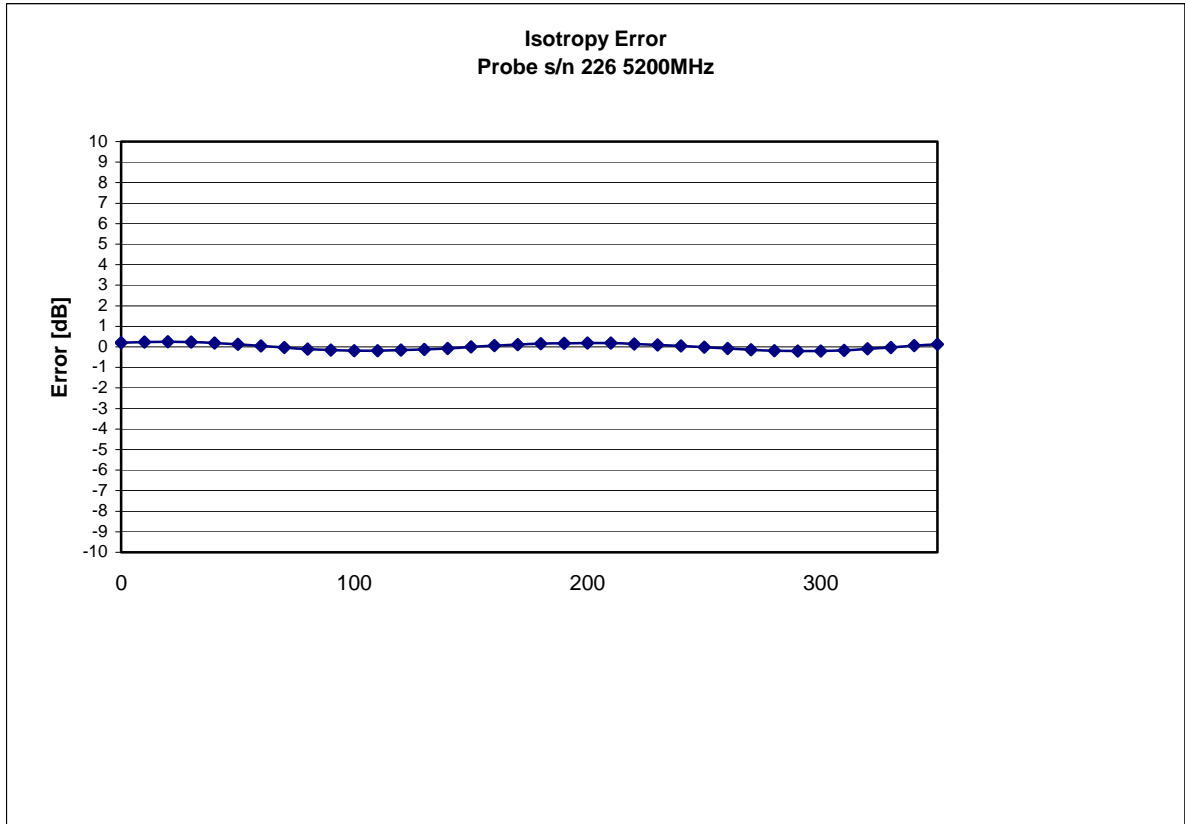

Isotropicity in Tissue:

0.10 dB

## Dynamic Range

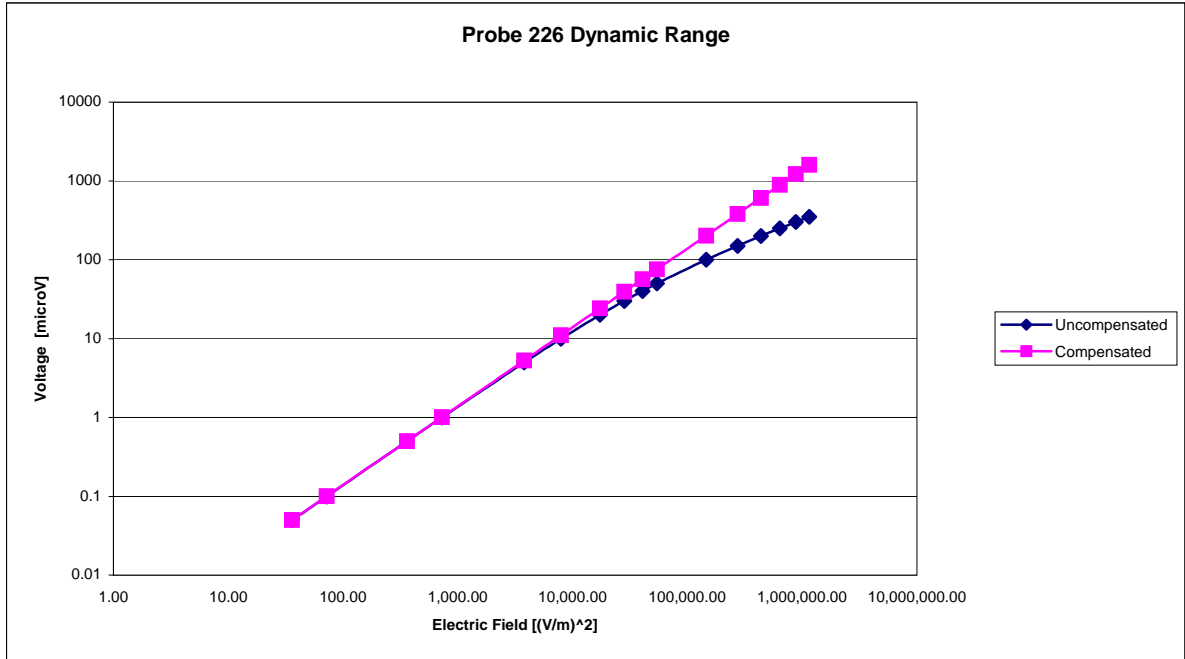

## Video Bandwidth

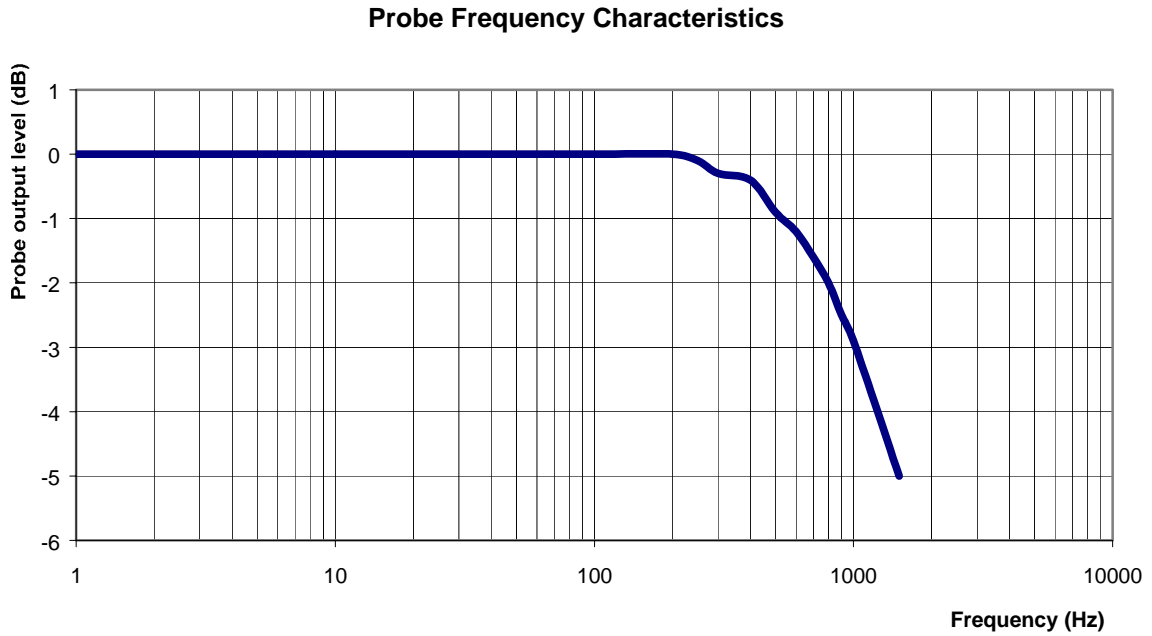

**Video Bandwidth at 500 Hz**                      1 dB  
**Video Bandwidth at 1.02 KHz:**                3 dB

## **Conversion Factor Uncertainty Assessment**

**Frequency:** 5200MHz  
**Epsilon:** 43.0 (+/-10%)      **Sigma:** 5.75 S/m (+/-10%)

### **ConvF**

**Channel X:** 3.5      7%(K=2)  
**Channel Y:** 3.5      7%(K=2)  
**Channel Z:** 3.5      7%(K=2)

To minimize the uncertainty calculation all tissue sensitivity values were calculated using a load impedance of 5 MΩ.

### **Boundary Effect:**

For a distance of 1.4mm the evaluated uncertainty (increase in the probe sensitivity) is less than 2%.



## **Test Equipment**

The test equipment used during Probe Calibration, manufacturer, model number and, current calibration status are listed and located on the main APREL server R:\NCL\Calibration Equipment\Instrument List May 2007.

# NCL CALIBRATION LABORATORIES

Calibration File No.: CP-785

Client.: APREL

## CERTIFICATE OF CALIBRATION

It is certified that the equipment identified below has been calibrated in the  
**NCL CALIBRATION LABORATORIES** by qualified personnel following recognized  
procedures and using transfer standards traceable to NRC/NIST.

Equipment: Miniature Isotropic RF Probe 2450 MHz

Manufacturer: APREL Laboratories

Model No.: E-020

Serial No.: 226

Calibration in Body Tissue

Calibration Procedure: SSI/DRB-TP-D01-032-E020-V2

Project No: Internal APREL

Calibrated: 3<sup>rd</sup> May 2007  
Released on: 3<sup>rd</sup> May 2007

This Calibration Certificate is Incomplete Unless Accompanied with the Calibration Results Summary

Released By: \_\_\_\_\_

**NCL** CALIBRATION LABORATORIES

51 SPECTRUM WAY  
NEPEAN, ONTARIO  
CANADA K2R 1E6

Division of APREL Lab.  
TEL: (613) 820-4988  
FAX: (613) 820-4161

## Introduction

This Calibration Report reproduces the results of the calibration performed in line with the SSI/DRB-TP-D01-032-E020-V2 E-Field Probe Calibration Procedure. The results contained within this report are for APREL E-Field Probe E-020 226.

## References

SSI/DRB-TP-D01-032-E020-V2 E-Field Probe Calibration Procedure  
IEEE 1528 "Recommended Practice for Determining the Peak Spatial-Average Specific Absorption Rate (SAR) in the Human Body Due to Wireless Communications Devices: Experimental Techniques"  
SSI-TP-011 Tissue Calibration Procedure

## Conditions

Probe 226 was a new probe taken from stock prior to calibration.

**Ambient Temperature of the Laboratory:** 22 °C +/- 0.5°C  
**Temperature of the Tissue:** 21 °C +/- 0.5°C

**We the undersigned attest that to the best of our knowledge the calibration of this probe has been accurately conducted and that all information contained within this report has been reviewed for accuracy.**

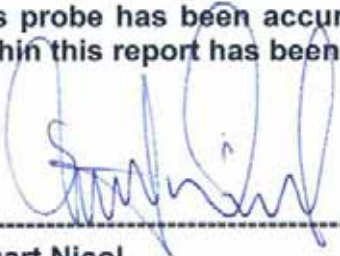

-----  
**Stuart Nicol**



-----  
**Jesse Hones**

## Calibration Results Summary

<b>Probe Type:</b>	E-Field Probe E-020
<b>Serial Number:</b>	226
<b>Frequency:</b>	2450 MHz
<b>Sensor Offset:</b>	1.56 mm
<b>Sensor Length:</b>	2.5 mm
<b>Tip Enclosure:</b>	Ertalyte*
<b>Tip Diameter:</b>	<2.9 mm
<b>Tip Length:</b>	60 mm
<b>Total Length:</b>	290 mm

\*Resistive to recommended tissue recipes per IEEE-1528

## Sensitivity in Air

<b>Channel X:</b>	1.2 $\mu\text{V}/(\text{V}/\text{m})^2$
<b>Channel Y:</b>	1.2 $\mu\text{V}/(\text{V}/\text{m})^2$
<b>Channel Z:</b>	1.2 $\mu\text{V}/(\text{V}/\text{m})^2$
<b>Diode Compression Point:</b>	95 mV

## **Sensitivity in Body Tissue**

**Frequency:** 2450 MHz

**Epsilon:** 52.7 (+/-5%)                      **Sigma:** 1.95 S/m (+/-5%)

### **ConvF**

**Channel X:** 4.4

**Channel Y:** 4.4

**Channel Z:** 4.4

Tissue sensitivity values were calculated using the load impedance of the APREL Laboratories Daq-Paq.

### **Boundary Effect:**

Uncertainty resulting from the boundary effect is less than 2% for the distance between the tip of the probe and the tissue boundary, when less than 1.44mm.

### **Spatial Resolution:**

The measured probe tip diameter is 2.9 mm (+/- 0.01 mm) and therefore meets the requirements of SSI/DRB-TP-D01-032 for spatial resolution.

## Receiving Pattern 2450 MHz (Air)

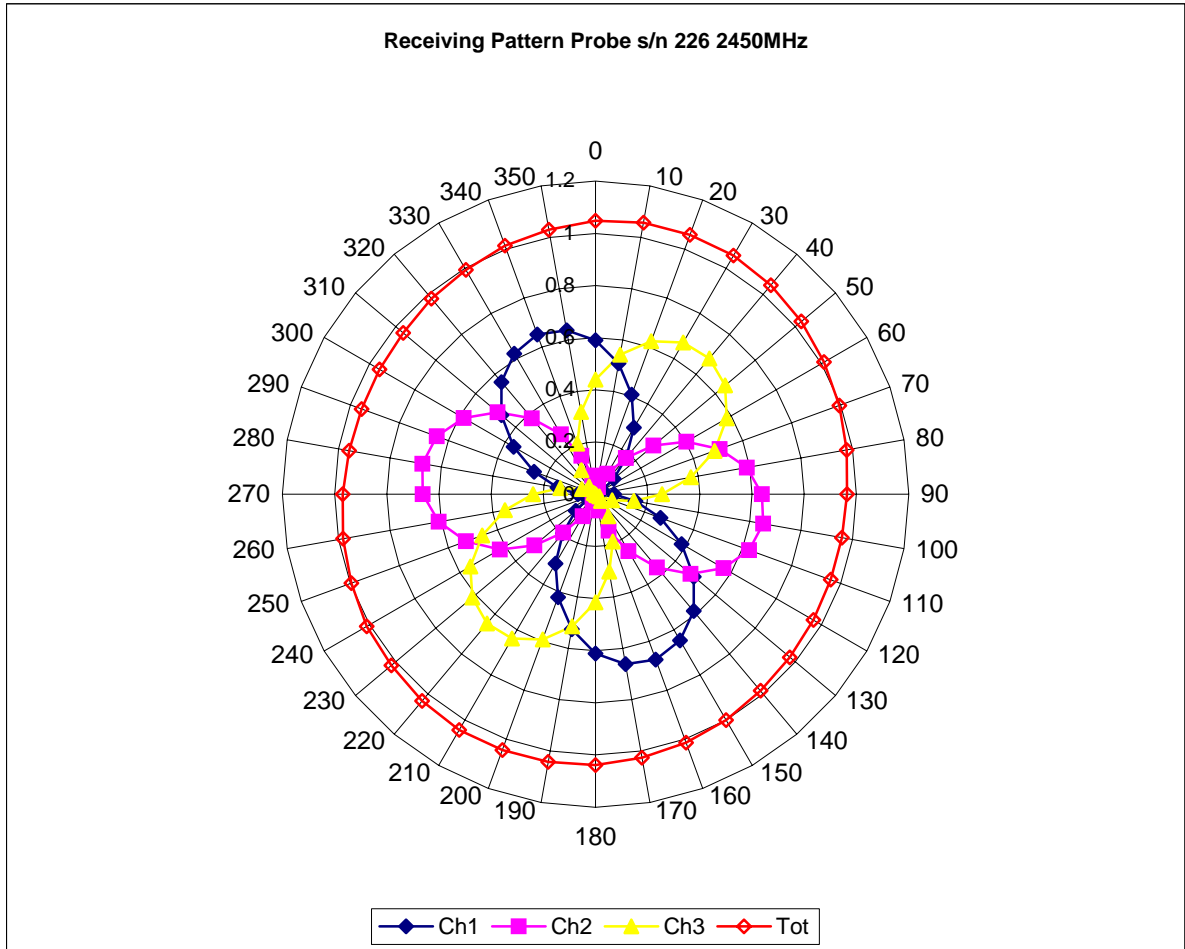

### Isotropy Error 2450 MHz (Air)

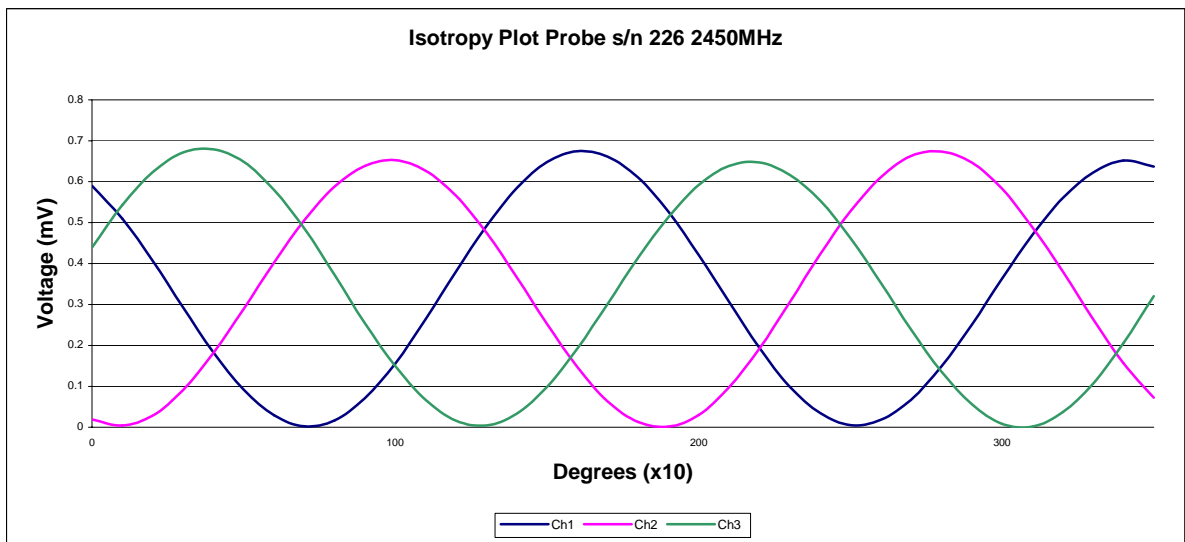
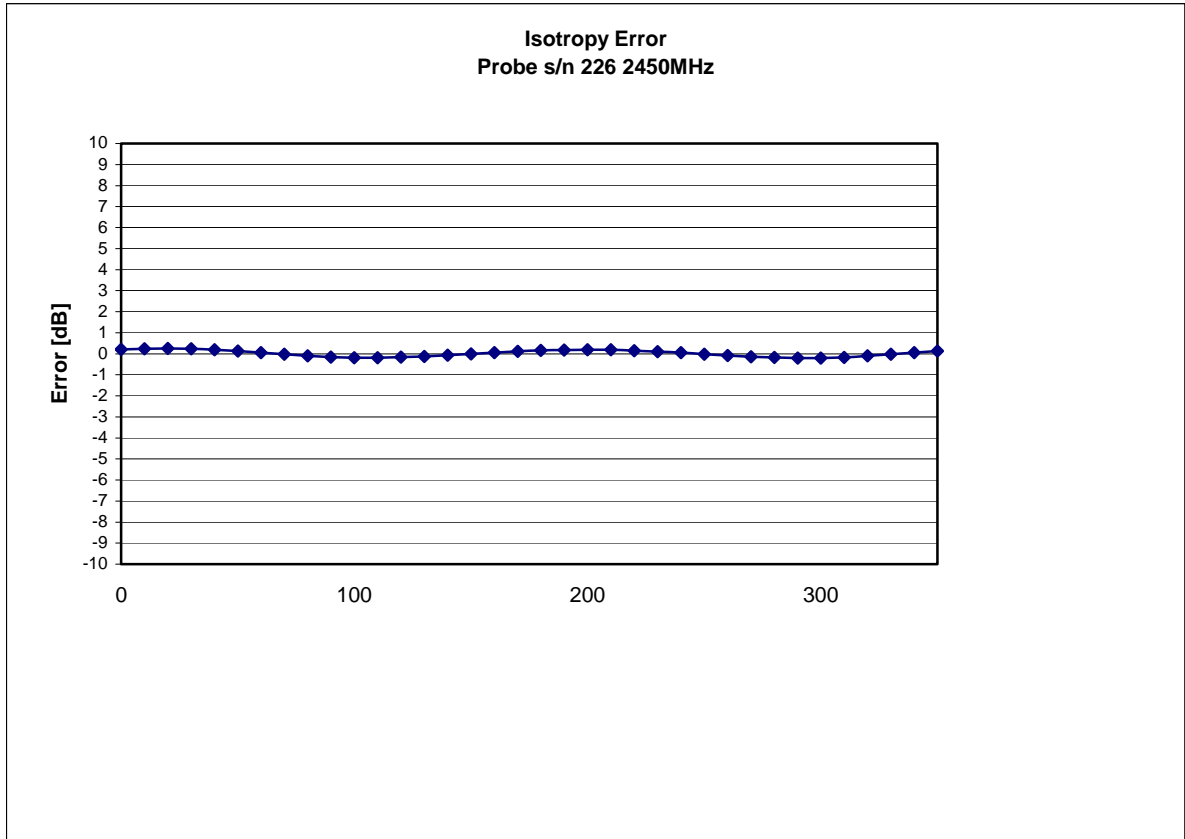

Isotropicity in Tissue:

0.10 dB

## Dynamic Range

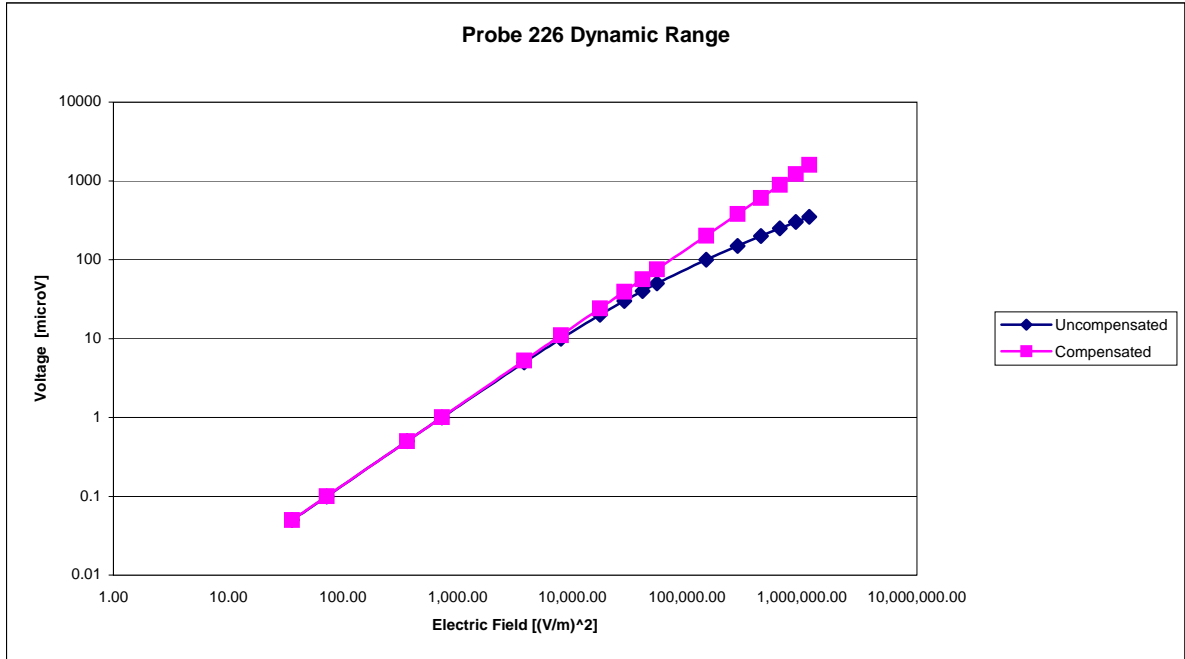



## Video Bandwidth

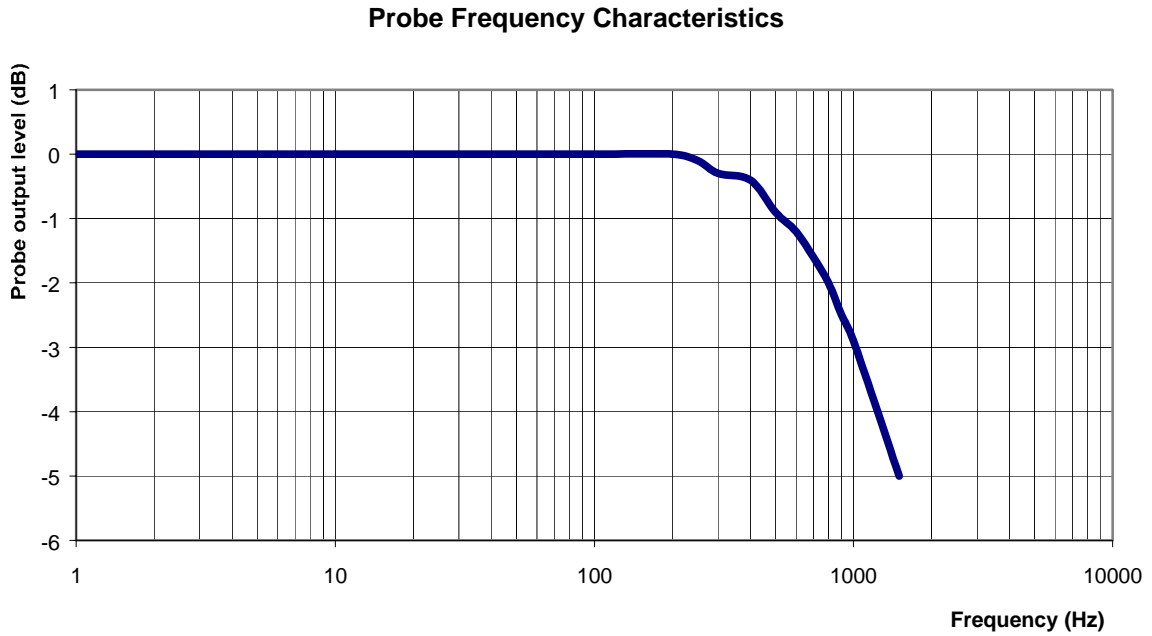

**Video Bandwidth at 500 Hz**                      1 dB  
**Video Bandwidth at 1.02 KHz:**                3 dB

## **Conversion Factor Uncertainty Assessment**

**Frequency:** 2450MHz  
**Epsilon:** 52.7 (+/-5%)      **Sigma:** 1.95 S/m (+/-5%)

### **ConvF**

**Channel X:** 4.4      7%(K=2)

**Channel Y:** 4.4      7%(K=2)

**Channel Z:** 4.4      7%(K=2)

To minimize the uncertainty calculation all tissue sensitivity values were calculated using a load impedance of 5 MΩ.

### **Boundary Effect:**

For a distance of 1.4mm the evaluated uncertainty (increase in the probe sensitivity) is less than 2%.

## **Test Equipment**

The test equipment used during Probe Calibration, manufacturer, model number and, current calibration status are listed and located on the main APREL server R:\NCL\Calibration Equipment\Instrument List May 2007.

# NCL CALIBRATION LABORATORIES

Calibration File No: DC-790  
Project Number: APREL-ALSAS10U

## C E R T I F I C A T E   O F   C A L I B R A T I O N

It is certified that the equipment identified below has been calibrated in the  
**NCL CALIBRATION LABORATORIES** by qualified personnel following recognized  
procedures and using transfer standards traceable to NRC/NIST.

APREL Validation Dipole

Manufacturer: APREL Laboratories

Part number: ALS-D-5800-S-2

Frequency: 5800 MHz

Serial No: PT-015-a

Customer: APREL

Calibrated: 1<sup>st</sup> March 2007  
Released on: 1<sup>st</sup> March 2007

Released By: \_\_\_\_\_

### **NCL** CALIBRATION LABORATORIES

51 SPECTRUM WAY  
NEPEAN, ONTARIO  
CANADA K2R 1E6

Division of APREL Lab.  
TEL: (613) 820-4988  
FAX: (613) 820-4162

## **Conditions**

Dipole PT-015-a was new and taken from stock prior to calibration.

**Ambient Temperature of the Laboratory:** 22 °C +/- 0.5°C

**Temperature of the Tissue:** 21 °C +/- 0.5°C

**We the undersigned attest that to the best of our knowledge the calibration of this device has been accurately conducted and that all information contained within this report has been reviewed for accuracy.**

-----  
**Stuart Nicol**

-----  
**C. Teodorian**

## Calibration Results Summary

The following results relate the Calibrated Dipole and should be used as a quick reference for the user.

### Mechanical Dimensions

**Length:** 21.6 mm  
**Height:** 12.6 mm

### Electrical Specification

**SWR:** 1.37 U  
**Return Loss:** -16.2 dB  
**Impedance:** 62.5  $\Omega$

### System Validation Results

Frequency	1 Gram	10 Gram	Peak
5800 MHz	49.1	x	207.1

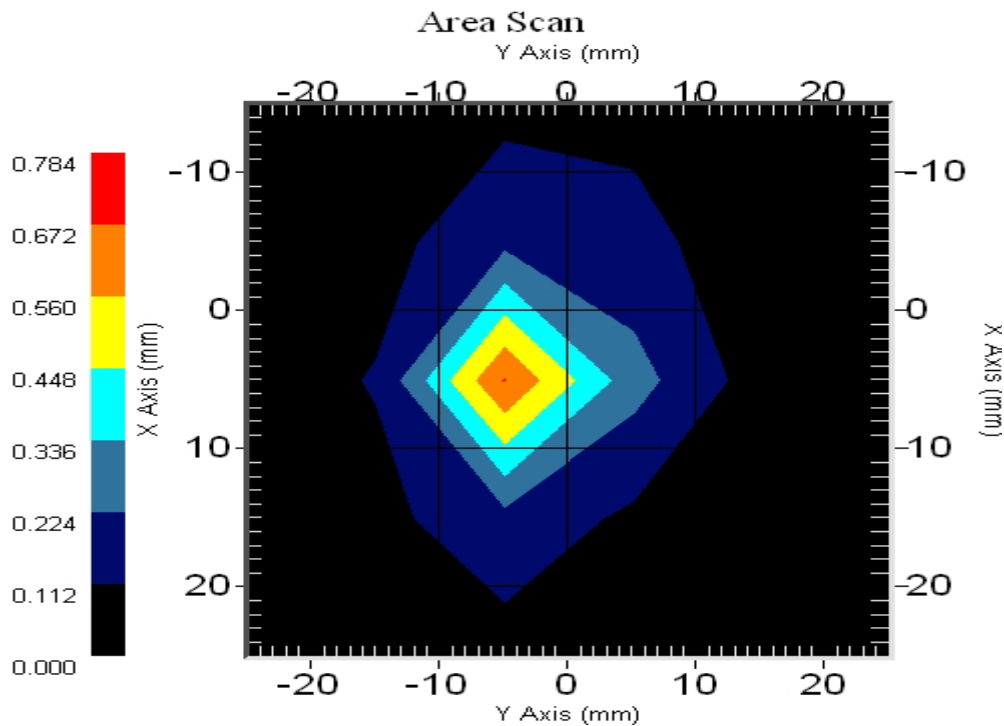

## **Introduction**

This Calibration Report has been produced in line with the SSI Dipole Calibration Procedure SSI-TP-018-ALSAS. The results contained within this report are for Validation Dipole PT-015-a. The calibration routine consisted of a three-step process. Step 1 was a mechanical verification of the dipole to ensure that it meets the mechanical specifications. Step 2 was an Electrical Calibration for the Validation Dipole, where the SWR, Impedance, and the Return loss were assessed. Step 3 involved a System Validation using the ALSAS-10U, along with APREL E-020 130 MHz to 26 GHz E-Field Probe Serial Number 212.

## **References**

SSI-TP-018-ALSAS Dipole Calibration Procedure

SSI-TP-016 Tissue Calibration Procedure

IEEE 1528 “Recommended Practice for Determining the Peak Spatial-Average Specific Absorption Rate (SAR) in the Human Body Due to Wireless Communications Devices: Experimental Techniques”

IEC-62209 “Human exposure to radio frequency fields from hand-held and body-mounted wireless communication devices – Human models, instrumentation, and procedures”

Part 1: “Procedure to determine the Specific Absorption Rate (SAR) for hand-held devices used in close proximity of the ear (frequency range of 300 MHz to 3 GHz)”

IEC-62209 “Human exposure to radio frequency fields from hand-held and body-mounted wireless communication devices – Human models, instrumentation, and procedures”

Part 2 *Draft*: “Procedure to determine the Specific Absorption Rate (SAR) for hand-held devices used in close proximity of the ear (frequency range of 30 MHz to 6 GHz)”

## **Conditions**

Dipole PT-015-a was new taken from stock.

**Ambient Temperature of the Laboratory:** 22 °C +/- 0.5°C

**Temperature of the Tissue:** 20 °C +/- 0.5°C

## Dipole Calibration Results

### Mechanical Verification

<b>APREL Length</b>	<b>APREL Height</b>	<b>Measured Length</b>	<b>Measured Height</b>
21.6 mm	12.6 mm	21.6 mm	16.0 mm

### Tissue Validation

<b>Head Tissue 5800 MHz</b>	<b>Measured</b>
<b>Dielectric constant, <math>\epsilon_r</math></b>	45.0
<b>Conductivity, <math>\sigma</math> [S/m]</b>	6.32



**Electrical Calibration**

Test	Result
S11 R/L	-16.2 dB
SWR	1.37 U
Impedance	62.5 $\Omega$

The Following Graphs are the results as displayed on the Vector Network Analyzer.

**S11 Parameter Return Loss**

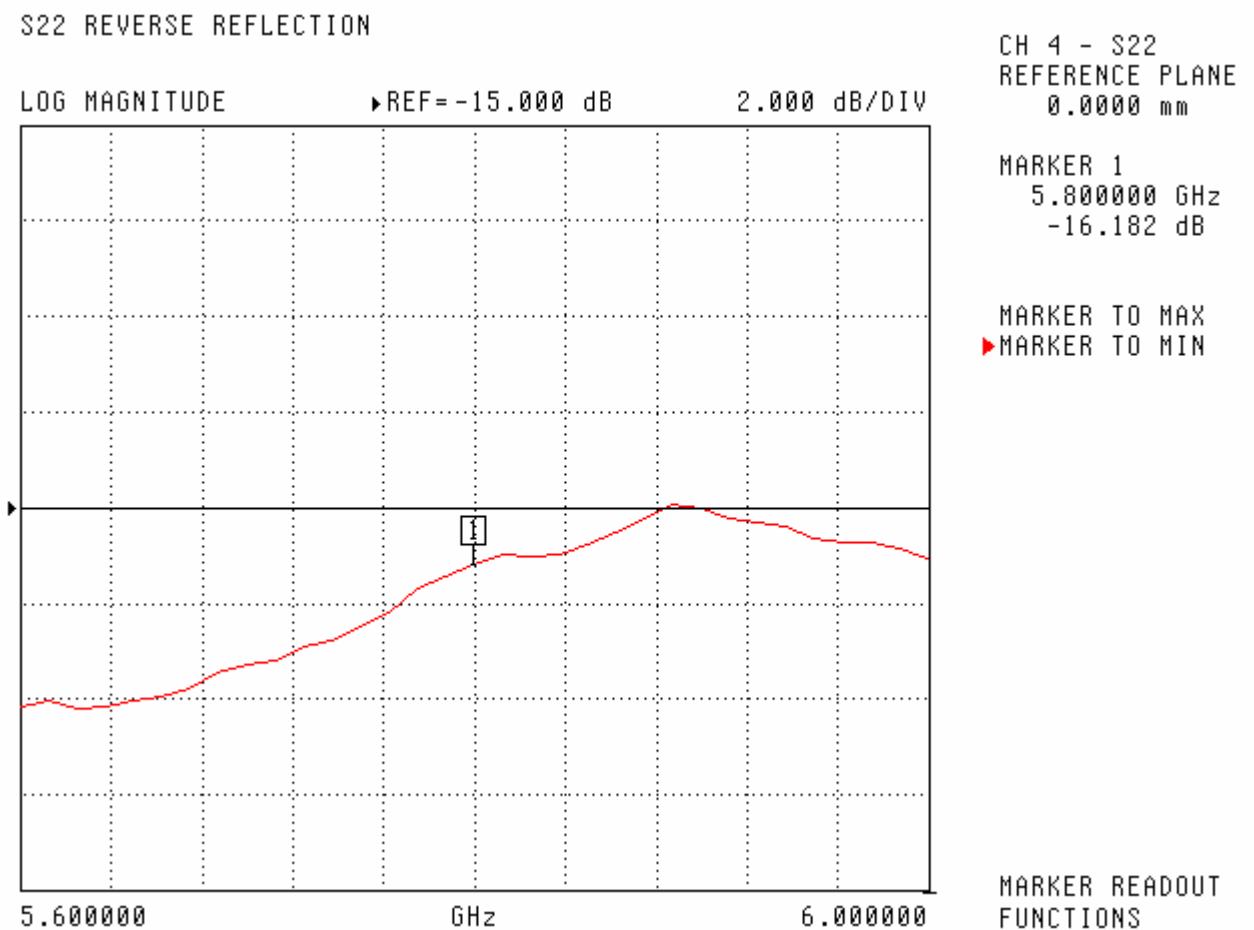

SWR

S22 REVERSE REFLECTION

SWR                      ▶REF= 1.500 U                      100.000 mU/DIV

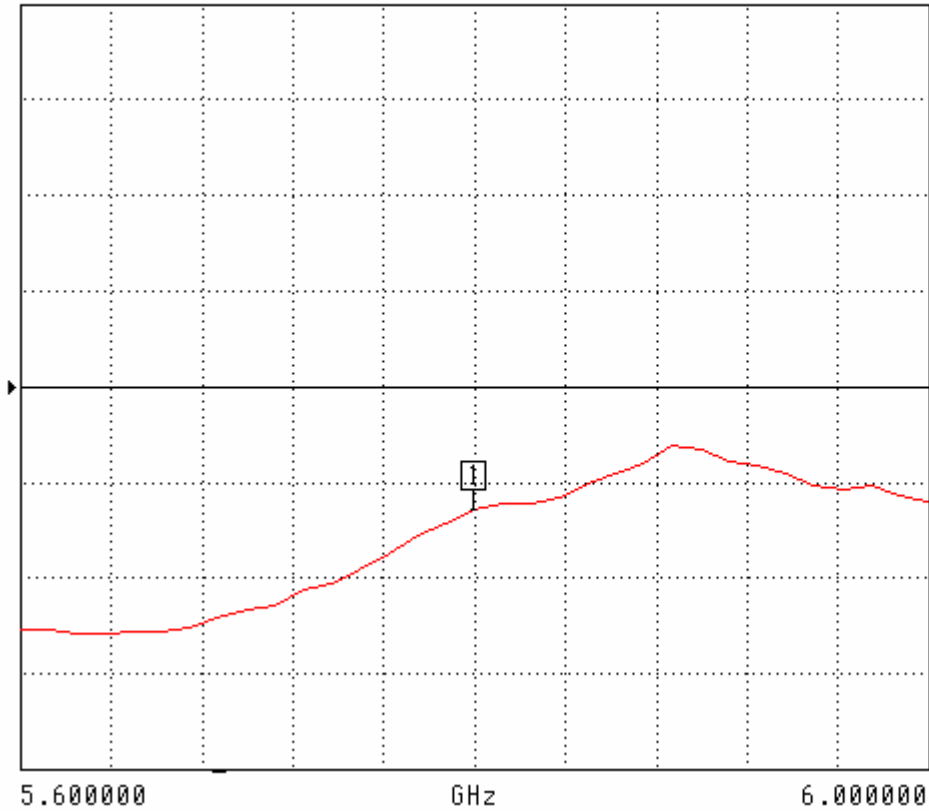

CH 4 - S22  
REFERENCE PLANE  
0.0000 mm

MARKER 1  
5.800000 GHz  
1.370 U

MARKER TO MAX  
▶ MARKER TO MIN

MARKER READOUT  
FUNCTIONS

## Smith Chart Dipole Impedance

S22 REVERSE REFLECTION  
IMPEDANCE

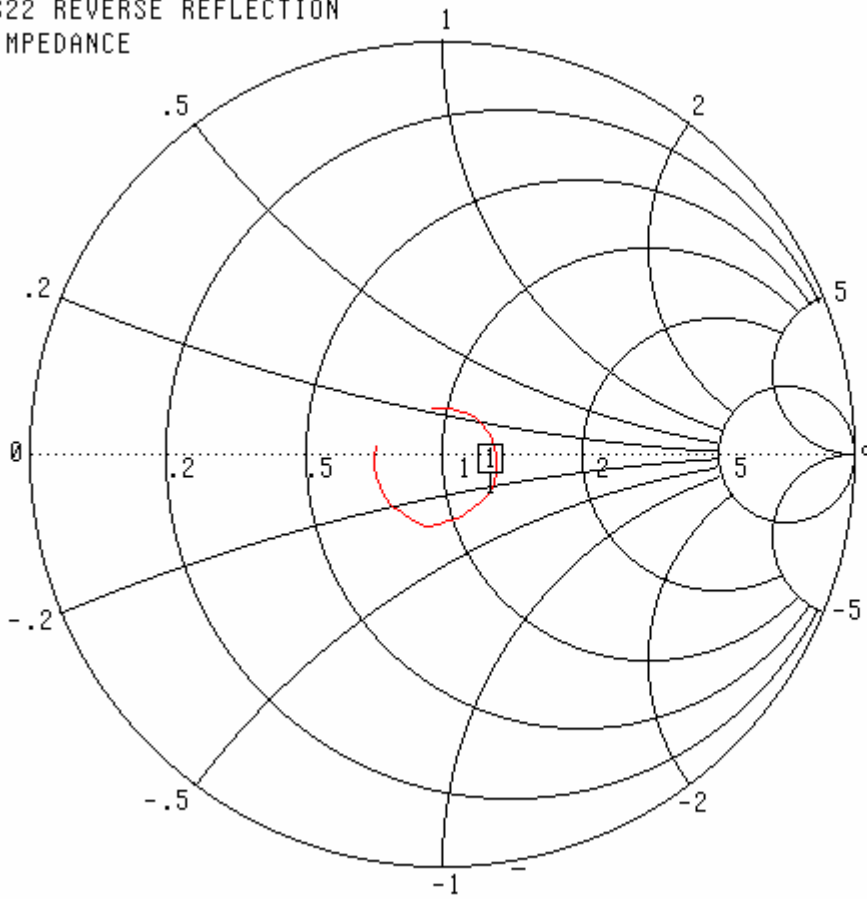

CH 4 - S22  
REFERENCE PLANE  
0.0000 mm

MARKER 1  
5.800000 GHz  
62.491  $\Omega$   
-12.202  $j\Omega$

MARKER TO MAX  
▶ MARKER TO MIN

5.600000 - 6.000000 GHz

MARKER READOUT  
FUNCTIONS

**System Validation Results Using the Electrically Calibrated Dipole**

Head Tissue Frequency	1 Gram	10 Gram	Peak Above Feed Point
5800 MHz	49.1	x	207.1

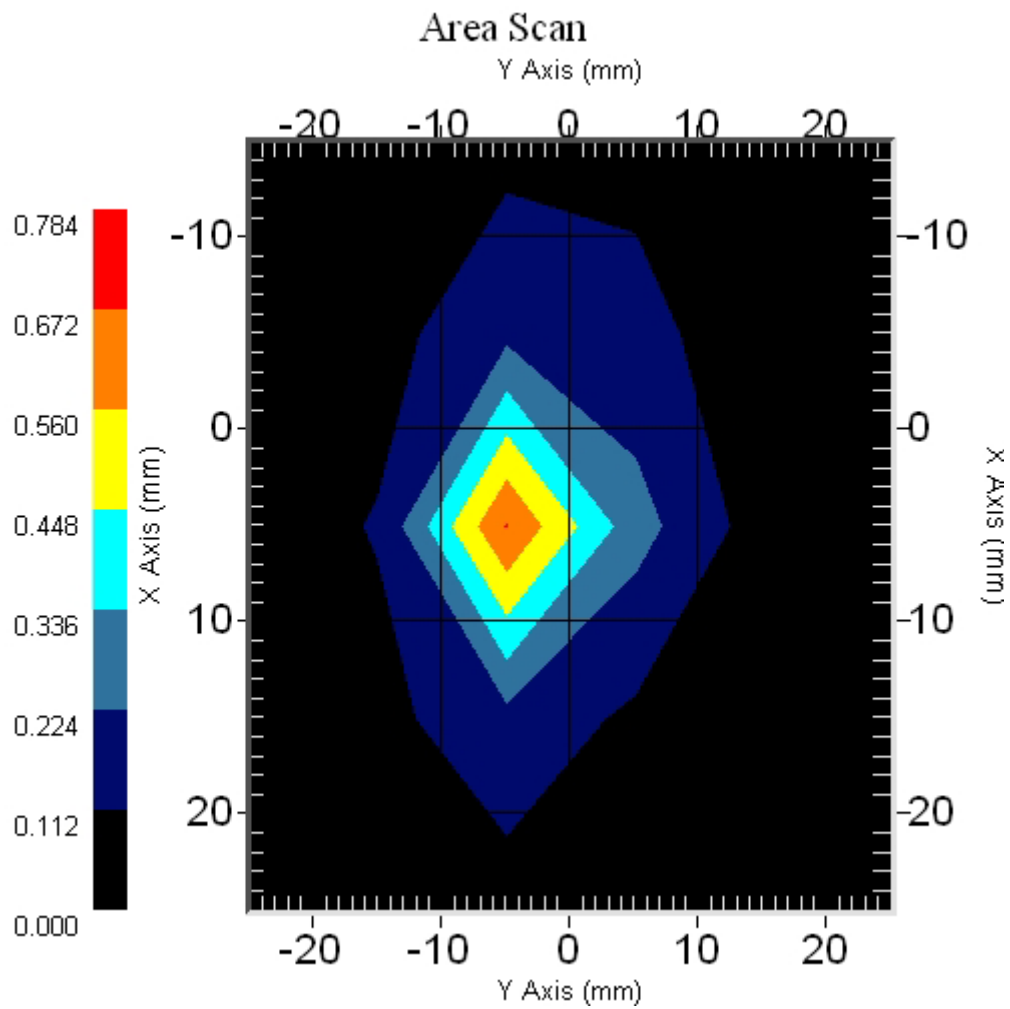

## **Test Equipment**

The test equipment used during Probe Calibration, manufacturer, model number and, current calibration status are listed and located on the main APREL server R:\NCL\Calibration Equipment\Instrument List May 2007.

# Regulatory WLAN Antenna Information

Hawke – WNC – 2007/07/02

<b>Platform</b>	Hawke
Platform Owner	
Brand Name	Dell
Model Name	PP28L
ODM	Wistron
Target Launch Date	(2007/ 11/07)
<b>Antenna</b>	
Brand Name	Wistron NeWeb Corporation
Part Number	<input checked="" type="checkbox"/> Tx1 Antenna: <b>81.EG515.001</b>
	<input checked="" type="checkbox"/> Tx2 Antenna: <b>81.EG515.003</b>
	<input checked="" type="checkbox"/> Tx3 (or Rx3) Antenna: <b>81.EG515.004</b>
<b>Module</b>	
With WLAN Module	<input type="checkbox"/> WM3B2200BG
(Check Box)	<input type="checkbox"/> WM3B2915ABG
	<input checked="" type="checkbox"/> WM3945ABG
	<input checked="" type="checkbox"/> 4965AGN

## Antenna Sample / Antenna Data Requirements for worldwide regulatory approval

Section	Description of Required OEM / ODM Antenna Information	US / IC	EU	Japan	Taiwan	S.Korea
1A	Part Number for Antenna only	Required	Required	Required	Required	Required
1B	Antenna Manufacturer Name	Required	Required	Required	Required	Required
1C	Description of Antenna Type	Required	N/A	N/A	N/A	N/A
1D	Part number of Antenna Assembly / cable impedance, length & diameter.	Required	Desired	Desired	Desired	Desired
1E	Tx1, Tx2 & Tx3 antenna (Peak Gain W/ cable loss) *	Required	Required	Required	Required	Required
	1E OR 1F, 1G, 1H					
1F	Tx1, Tx2 & Tx3 antenna (Peak Gain only) *	Required	Required	Required	Required	Required
1G	VSWR of cable including connector	Required	Required	Required	Required	Required
1H	Tx1, Tx2 & Tx3 antenna (Cable loss W/ connector) *	Required	Required	Required	Required	Required
2	Dimensioned Photographs <b>and</b> Drawings of Tx1, Tx2, and Tx3 (or Rx3) antennas	Required	Required	Required	Required	Required
3	Radiation patterns of antennas loaded in the host platform.	Required	Desired	Required	N/A	Required
4	Platform model name / number - correlated to antenna manufacturer and antenna part number	Required	Required	Desired	Required	Desired
5	Photograph(s) or Drawings showing location of antennas in platform. <b>(S. Korea requires photographs of antennas for approval submission). Taiwan requires pictures of each antenna type shown in the system.</b>	Required	Required	Desired	Required <b>(Photos)</b>	Required <b>(Photos)</b>
6	Mech. drawings / photos with dimensions of antenna locations and distance from end-user (For evaluation of SAR testing requirement).	Required	N/A	N/A	N/A	N/A
7	Photograph(s) or Drawings showing the location of all antennas (WLAN, other) and distance between those transmitting antennas. Information will be used to evaluate whether co-location testing is required.	Required	N/A	N/A	N/A	N/A
8	Local representative contact information for LMA/ PARS process.	Required	N/A	N/A	N/A	N/A

## NOTE:

(\*) if 3<sup>rd</sup> antenna is Rx only (e.g. receive only for 4965AGN) then peak gain and cable loss not required

# Antenna Information

## Section 1. Antenna Assembly Specifications

### Antenna Assembly Summary:

1A Antenna Part Number	1B Manufacture	1C Antenna Type	1D Cable Assembly Part Number and Information	1E *Peak Gain W/ Cable loss (dBi)	1F Peak Gain w/o Cable Loss (dBi)	1G VSWR	1H Cable Loss (dBi)
(P/N: <b>81.EG515.0</b> <b>01</b> Tx1 antenna	Wistron NeWeb Corporation	Stamped Metal, Inverted-F Antenna (IFA)	Color: White OD: 1.32~1.37 mm Length: 635 mm Vendor: Golden Bridge or equivalent Connector: Hirose U.FL-LP-88 or IPEX 20308-111R-32/20363-111R-37 or equivalent connector	2400-2500MHz 0.16 dBi (peak)	2400-2500MHz 2.38 dBi (peak)	2400-2500MHz 2.0 max	2400-2500MHz 2.22 dB (peak)
				5150-5350MHz 0.31 dBi (peak)	5150-5350MHz 3.71 dBi (peak)	5150-5350MHz 2.0 max	5150-5350MHz 3.40 dB (peak)
				5470-5725MHz 0.34 dBi (peak)	5470-5725MHz 3.74 dBi (peak)	5470-5725MHz 2.0 max	5470-5725MHz 3.40 dB (peak)
				5725-5850MHz 0.61 dBi (peak)	5725-5850MHz 4.01 dBi (peak)	5725-5850MHz 2.0 max	5725-5850MHz 3.40 dB (peak)
(P/N: <b>81.EG515.0</b> <b>03</b> Tx2 antenna	Wistron NeWeb Corporation	Stamped Metal, Inverted-F Antenna (IFA)	Color: Black OD: 1.32~1.37 mm Length: 520 mm Vendor: Golden Bridge or equivalent Connector: Hirose U.FL-LP-88 or IPEX 20308-111R-32/20363-111R-37 or equivalent connector	2400-2500MHz -0.18 dBi (peak)	2400-2500MHz 1.67 dBi (peak)	2400-2500MHz 2.0 max	2400-2500MHz 1.85 dB (peak)
				5150-5350MHz -0.99 dBi (peak)	5150-5350MHz 1.93 dBi (peak)	5150-5350MHz 2.0 max	5150-5350MHz 2.92 dB (peak)
				5470-5725MHz -0.87 dBi (peak)	5470-5725MHz 2.05 dBi (peak)	5470-5725MHz 2.0 max	5470-5725MHz 2.92 dB (peak)
				5725-5850MHz -2.00 dBi (peak)	5725-5850MHz 0.92 dBi (peak)	5725-5850MHz 2.0 max	5725-5850MHz 2.92 dB (peak)
(P/N: <b>81.EG515.0</b> <b>04</b> Tx3 (or Rx3) antenna	Wistron NeWeb Corporation	Stamped Metal, Inverted-F Antenna (IFA)	Color: Gray OD: 1.32~1.37 mm Length: 405 mm Vendor: Golden Bridge or equivalent Connector: Hirose U.FL-LP-88 or IPEX 20308-111R-32/20363-111R-37 or equivalent connector	2400-2500MHz 2.49 dBi (peak) *	2400-2500MHz 3.98 dBi (peak) *	2400-2500MHz 2.0 max *	2400-2500MHz 1.49 dB (peak) *
				5150-5350MHz 0.37 dBi (peak) *	5150-5350MHz 2.70 dBi (peak) *	5150-5350MHz 2.0 max *	5150-5350MHz 2.33 dB (peak) *
				5470-5725MHz 0.52 dBi (peak) *	5470-5725MHz 2.85 dBi (peak) *	5470-5725MHz 2.0 max *	5470-5725MHz 2.33 dB (peak) *
				5725-5850MHz 0.52 dBi (peak) *	5725-5850MHz 2.85 dBi (peak) *	5725-5850MHz 2.0 max *	5725-5850MHz 2.33 dB (peak) *

#### NOTE:

(\*) If Rx3 only (3<sup>rd</sup> antenna receives only, e.g. for 4965AGN) then the information marked with \* is not required



**Antenna Peak Gain Table:**

Frequency (MHz)	Tx1 antenna		Tx2 Antenna		Tx3 (or Rx3) Antenna	
	Horizontal (dBi)	Vertical (dBi)	Horizontal (dBi)	Vertical (dBi)	Horizontal (dBi)	Vertical (dBi)
2412	0.16	-1.25	-0.18	-0.31	2.49	0.88
2437	-0.39	-1.13	-1.75	-0.75	2.25	-0.05
2462	-0.73	-1.32	-1.93	-2.14	1.67	-0.42
4900	0.31	-2.09	-2.44	-3.01	-0.50	-3.46
5150	0.16	-0.84	-1.74	-1.71	0.37	-1.53
5350	-0.16	-0.75	-2.44	-0.99	0.02	-2.05
5470	0.02	-0.70	-3.23	-0.87	0.41	-2.27
5725	0.34	0.32	-3.72	-2.00	0.52	0.52
5875	0.61	-1.96	-2.64	-2.01	-1.03	-2.01

- Antenna Peak Gain required being test in system basis.
- 1E frame contend absolutely peak antenna gain include H/V
- If Rx3 only (3<sup>rd</sup> antenna receives only, e.g. for 4965AGN) then the information is not required for Rx3.

**Section 2. Dimensioned Photos or Drawings of Antennas**

Include a dimensioned photo and dimensioned drawing of Tx1 antenna here.

**Tx1 Antenna Dimensioned Drawing:**

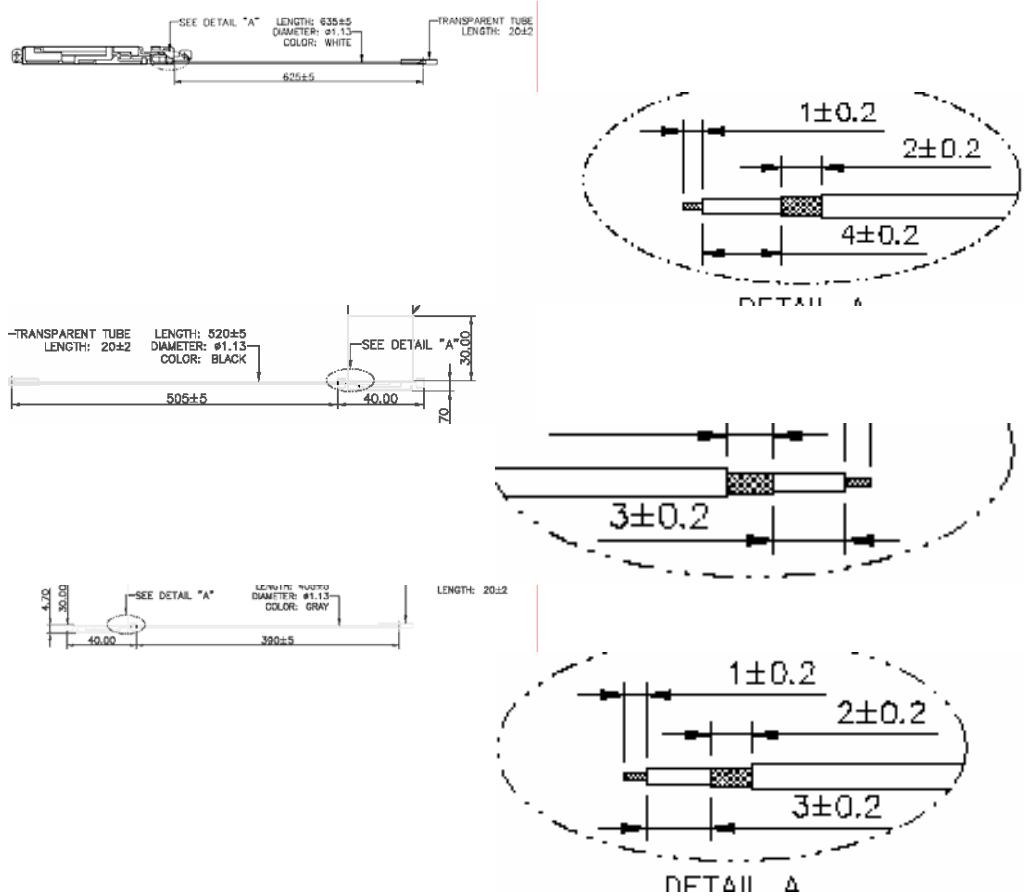

**Tx1 Antenna Photo:**



WLAN Main



WLAN Aux

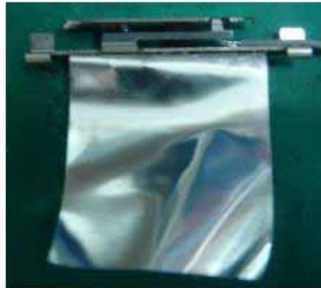

MIMO

**Include a dimensioned photo and dimensioned drawing of Tx2 antenna here.**

**Tx2 Antenna Dimensioned Drawing:**

See TX1 Drawing

**Tx2 Antenna Photo:**

See TX1 Photo

**Include a dimensioned photo and dimensioned drawing of Tx3 (or Rx3) antenna here.**

**Tx3 (or Rx3) Antenna Dimensioned Drawing:**

See TX1 Drawing

**Tx3 (or Rx3) Antenna Photo:**

See TX1 Photo

## Section 3. Radiation characteristics of antennae Loaded in Host Platform

### 2400-2500MHz radiation characteristic

#### Tx1 antenna:

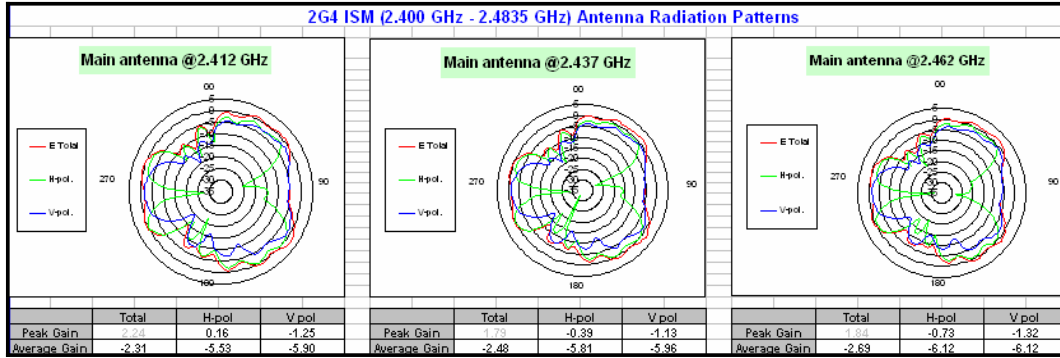

#### Tx2 antenna:

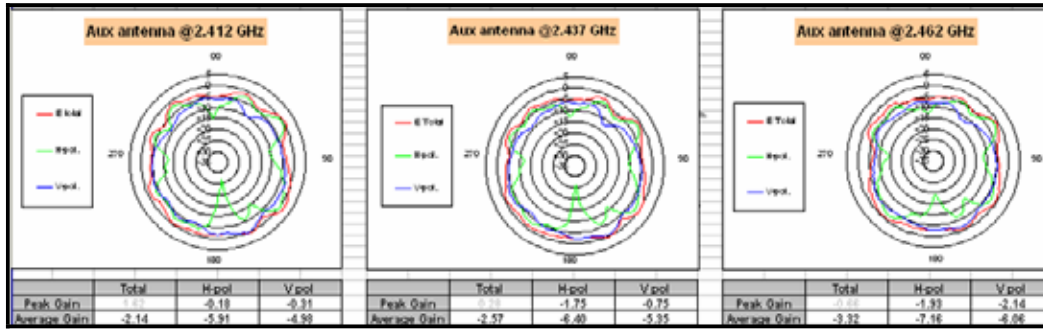

#### Tx3 (or Rx3) antenna:

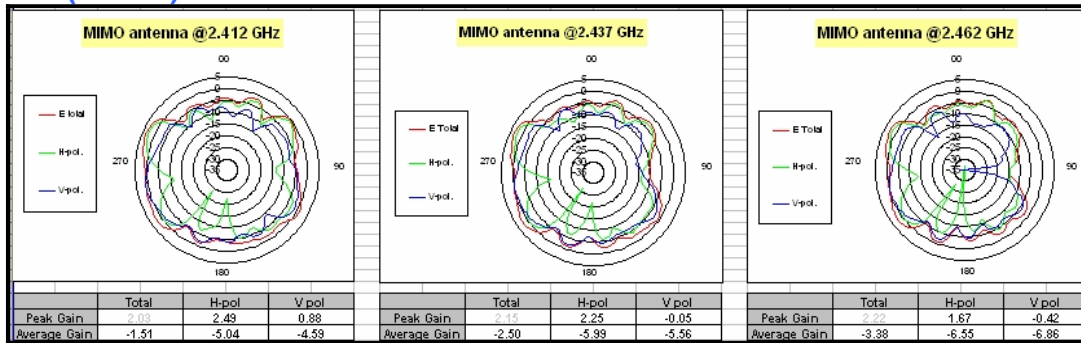

**4900-5875 MHz radiation characteristic**

**Tx1 antenna:**

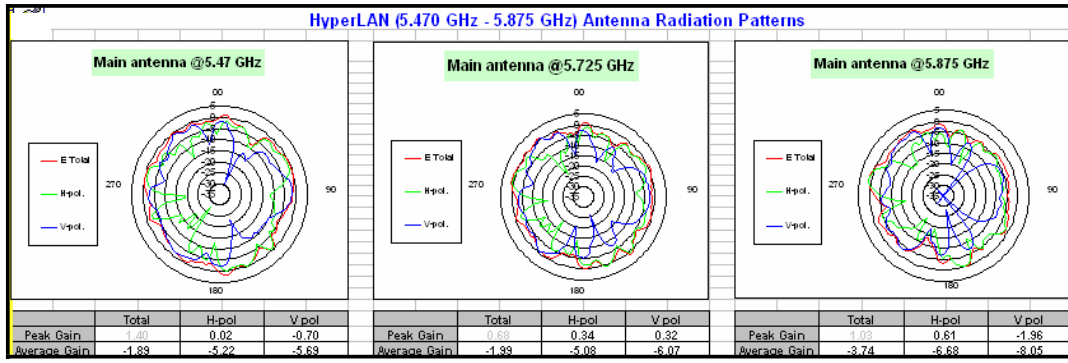
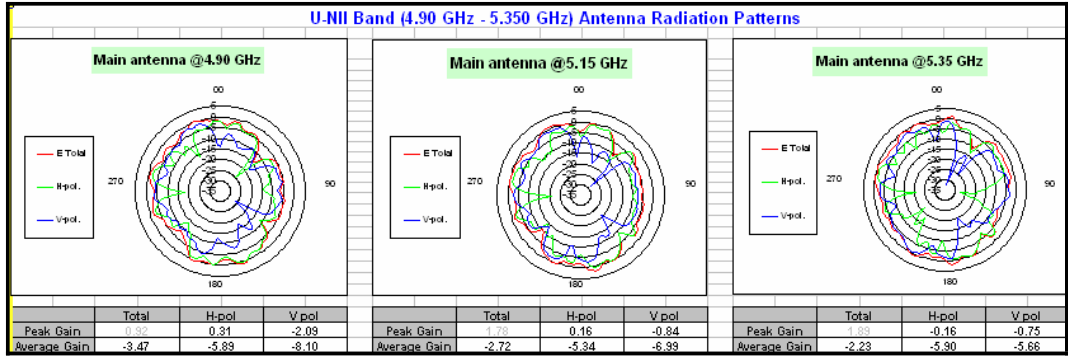

**Tx2 antenna:**

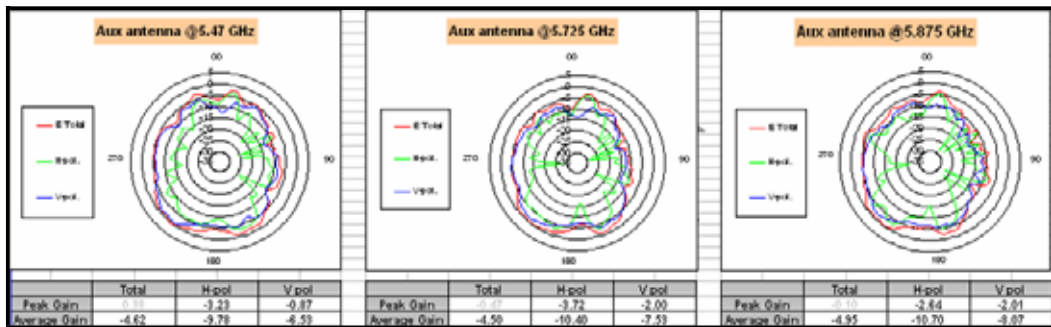
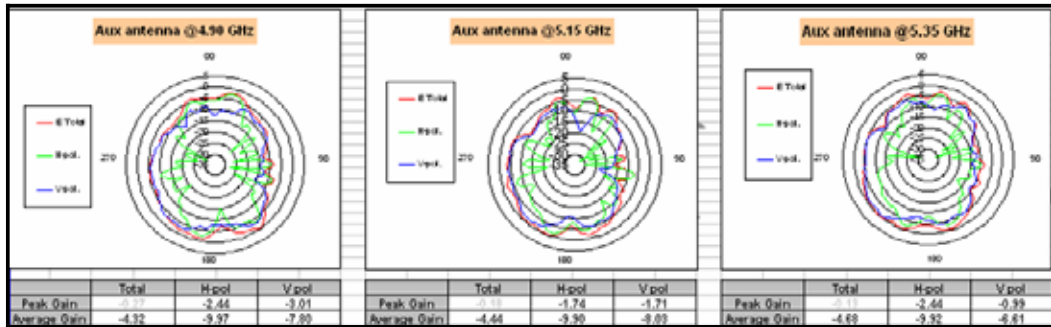

**Tx3 (or Rx3) antenna:**

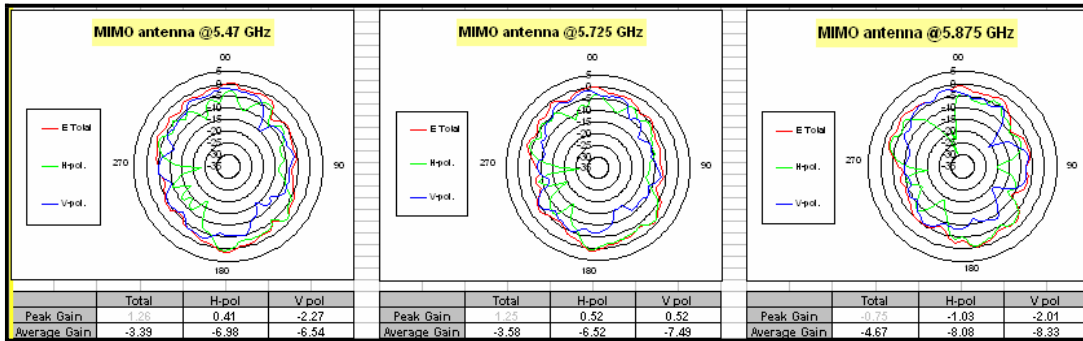
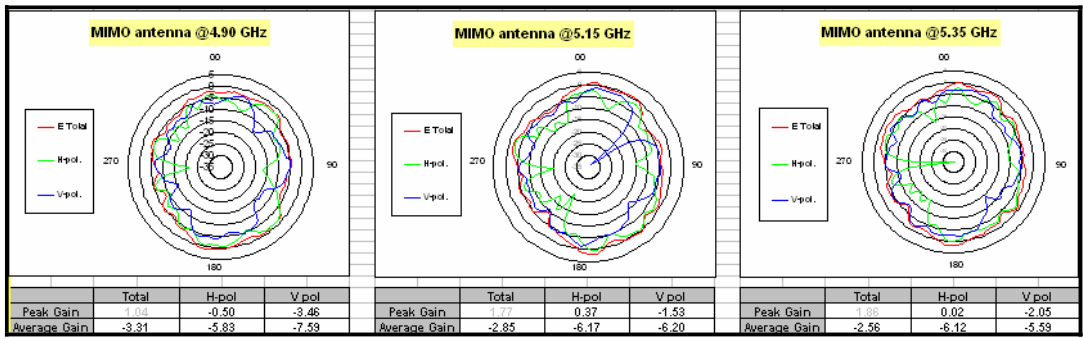

## Section 4. Host Platform Information

OEM / ODM Host platform: (XXXXXXX) platform correlated to antenna data  
Rating Label Photo:

## Section 5. Antenna Host Platform Location Information

Include a **dimensioned photo or dimensioned drawing** of Tx1, Tx2 and Tx3 antenna placements. (Not applicable for receive-only antenna e.g. Rx3 for 4965AGN)

**Main Antenna**



**Aux Antenna**

**MIMO Antenna**



## Section 6. Antenna dimensional information for SAR evaluation

Include a **dimensioned photo or dimensioned drawing** showing the distance (mm) between the transmit antennas and the user (excluding hands, wrist, feet, lap/ thigh, and ankle)

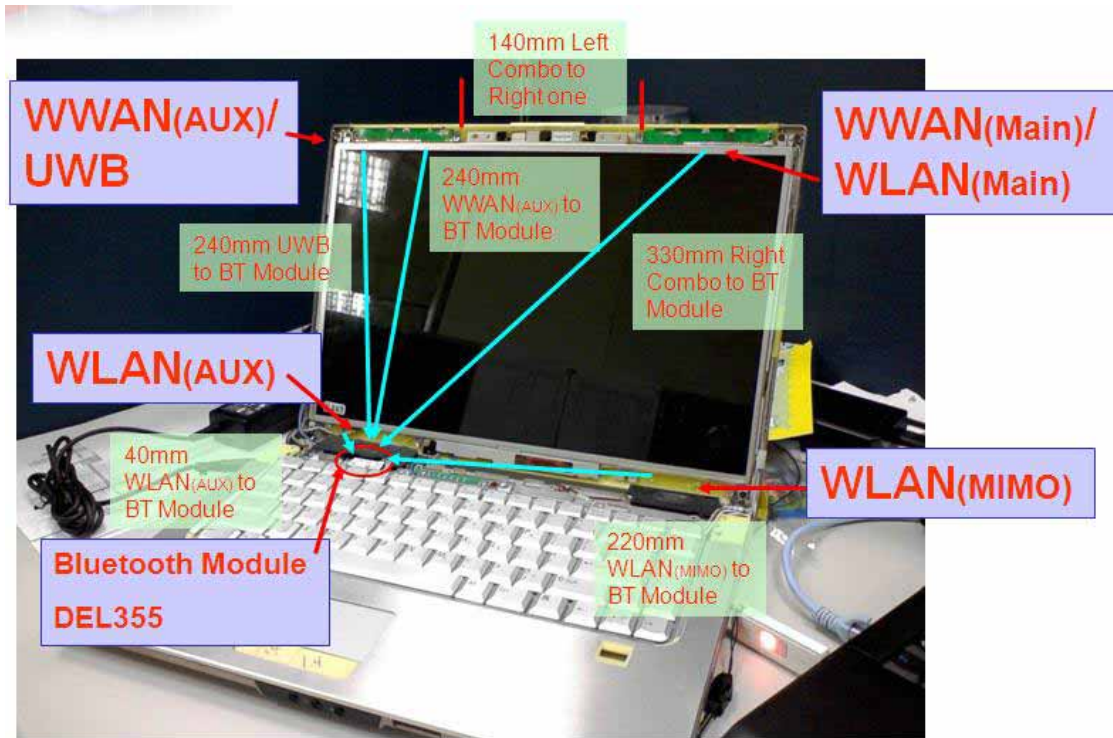
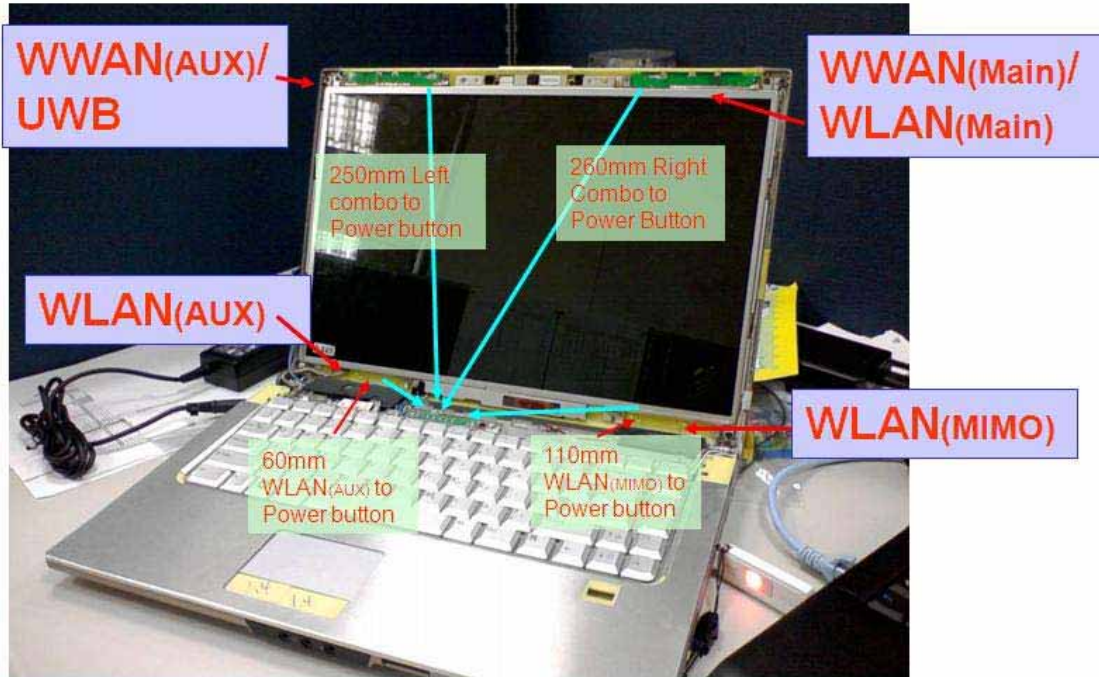



## **Section 7. Diagram Example of Co-Location Antenna Separation**

Include a **dimensioned photo or dimensioned drawing** showing the distance (mm) between **all WLAN transmit antennas** and other co-located radiator transmit antenna such as Bluetooth, WWAN,..

**(Note: Due to the evolving rules regarding co-location, each platform will need to be reviewed on a case by case basis)**

See section 6 – Note that a WWAN antenna is co-located with the Tx1 WLAN antenna.

## Section 8. Local representative contact information

Local representative contact information is required for regulatory support for target countries below.

	Local company name	Contact name	Phone number	FAX Number	e-Mail Address	Notes
<b>Argentina</b>	DELL COMPUTER DE CHILE	Hermann Obermoller	(562) 685 6803	(562) 232-4290	Hermann_Obermoller@dell.com	
<b>Brazil</b>		Rodrigo Sagredo	+55 (019) 252-8170		rodrigossagredo@mpc.com.br	
<b>Indonesia</b>	Dell Asia Pacific Sdn.	Catherine Mulia			Indonesia Representative Office Wisma GKBI 39 Floor, Suite 3901 Jl. Jend. Sudirman No. 28 Jakarta 10210, Indonesia.	
<b>Israel</b>	Dell	Raanan Biber	+972-(0)3-767 4001	+972-(0)3-644 4106	raanan_biber@dell.com	
<b>Malaysia</b>	Dell Asia Pacific Sdn.	Lily Wong	6-04-504-4670	6-04-633-8670	Lily_Wong@dell.com	
<b>Mexico</b>	DELL Computer	Maria Garcia	011-5255-5081-8849		Maria_Garcia@dell.com	
<b>Singapore</b>	Dell Computer Asia Pte Ltd	Doreen Koh	65-335-3282		Doreen_Koh@dell.com	Telecommunication Equipment Dealer License Required
<b>South Africa</b>	Dell South Africa	Leigh Hancock	+44 1344 372 647		Leigh_Hancock@dell.com	
<b>USA, Canada</b>	DELL CANADA INC.	KRISTIAN KOT	416-773-5095		Kristian_kot@dell.com	