

Regulatory WLAN Antenna Information

Hawke – Acon – 2007/07/02

Platform	Hawke
Platform Owner	
Brand Name	Dell
Model Name	PP28L
ODM	Wistron
Target Launch Date	(2007/ 11/07)
Antenna	
Brand Name	ADVANCED-CONNECTEK INC.
Part Number	<input checked="" type="checkbox"/> Tx1 Antenna: APP8P-700001
	<input checked="" type="checkbox"/> Tx2 Antenna: APM6P-700026
	<input checked="" type="checkbox"/> Tx3 (or Rx3) Antenna: APM6P-700027
Module	
With WLAN Module	<input type="checkbox"/> WM3B2200BG
(Check Box)	<input type="checkbox"/> WM3B2915ABG
	<input checked="" type="checkbox"/> WM3945ABG
	<input checked="" type="checkbox"/> 4965AGN

Antenna Sample / Antenna Data Requirements for worldwide regulatory approval

Section	Description of Required OEM / ODM Antenna Information	US / IC	EU	Japan	Taiwan	S.Korea
1A	Part Number for Antenna only	Required	Required	Required	Required	Required
1B	Antenna Manufacturer Name	Required	Required	Required	Required	Required
1C	Description of Antenna Type	Required	N/A	N/A	N/A	N/A
1D	Part number of Antenna Assembly / cable impedance, length & diameter.	Required	Desired	Desired	Desired	Desired
1E	Tx1, Tx2 & Tx3 antenna (Peak Gain W/ cable loss) *	Required	Required	Required	Required	Required
	1E OR 1F, 1G, 1H					
1F	Tx1, Tx2 & Tx3 antenna (Peak Gain only) *	Required	Required	Required	Required	Required
1G	VSWR of cable including connector	Required	Required	Required	Required	Required
1H	Tx1, Tx2 & Tx3 antenna (Cable loss W/ connector) *	Required	Required	Required	Required	Required
2	Dimensioned Photographs and Drawings of Tx1, Tx2, and Tx3 (or Rx3) antennas	Required	Required	Required	Required	Required
3	Radiation patterns of antennas loaded in the host platform.	Required	Desired	Required	N/A	Required
4	Platform model name / number - correlated to antenna manufacturer and antenna part number	Required	Required	Desired	Required	Desired
5	Photograph(s) or Drawings showing location of antennas in platform. (S. Korea requires photographs of antennas for approval submission). Taiwan requires pictures of each antenna type shown in the system.	Required	Required	Desired	Required (Photos)	Required (Photos)
6	Mech. drawings / photos with dimensions of antenna locations and distance from end-user (For evaluation of SAR testing requirement).	Required	N/A	N/A	N/A	N/A
7	Photograph(s) or Drawings showing the location of all antennas (WLAN, other) and distance between those transmitting antennas. Information will be used to evaluate whether co-location testing is required.	Required	N/A	N/A	N/A	N/A
8	Local representative contact information for LMA/ PARS process.	Required	N/A	N/A	N/A	N/A

NOTE:

(*) if 3rd antenna is Rx only (e.g. receive only for 4965AGN) then peak gain and cable loss not required

Antenna Information

Section 1. Antenna Assembly Specifications

Antenna Assembly Summary:

1A Antenna Part Number	1B Manufacture	1C Antenna Type	1D Cable Assembly Part Number and Information	1E *Peak Gain W/ Cable loss (dBi)	1F Peak Gain w/o Cable Loss (dBi)	1G VSWR	1H Cable Loss (dBi)
(P/N: APP8P-70 0001) Tx1 antenna	ADVANCED-C ONNECTEK INC.	PCB, Inverted-F Antenna (IFA)	Color: White OD: 1.13 mm (low loss) Length: 625 mm Vendor: Kurabe/Hitachi/S umitomo Connector: IPEX 20278-111R-13	2400-2500MHz 0.10 dBi (peak)	2400-2500MHz 1.90 dBi (peak)	2400-2500MHz 2.0 max	2400-2500MHz 1.8 dB (peak)
				5150-5350MHz -2.20 dBi (peak)	5150-5350MHz 0.40 dBi (peak)	5150-5350MHz 2.0 max	5150-5350MHz 2.6 dB (peak)
				5470-5725MHz -2.80 dBi (peak)	5470-5725MHz -0.20 dBi (peak)	5470-5725MHz 2.0 max	5470-5725MHz 2.6 dB (peak)
				5725-5850MHz -3.00 dBi (peak)	5725-5850MHz -0.40 dBi (peak)	5725-5850MHz 2.0 max	5725-5850MHz 2.6 dB (peak)
(P/N: APM6P-7 00026) Tx2 antenna	ADVANCED-C ONNECTEK INC.	PCB, Inverted-F Antenna (IFA)	Color: Black OD: 1.13 mm (low loss) Length: 505 mm Vendor: Kurabe/Hitachi/S umitomo Connector: IPEX 20278-111R-13	2400-2500MHz -1.30 dBi (peak)	2400-2500MHz 0.20 dBi (peak)	2400-2500MHz 2.0 max	2400-2500MHz 1.5 dB (peak)
				5150-5350MHz -0.20 dBi (peak)	5150-5350MHz 2.00 dBi (peak)	5150-5350MHz 2.0 max	5150-5350MHz 2.2 dB (peak)
				5470-5725MHz -0.80 dBi (peak)	5470-5725MHz 1.40 dBi (peak)	5470-5725MHz 2.0 max	5470-5725MHz 2.2 dB (peak)
				5725-5850MHz -0.20 dBi (peak)	5725-5850MHz 2.00 dBi (peak)	5725-5850MHz 2.0 max	5725-5850MHz 2.2 dB (peak)
(P/N: APM6P-7 00027) Tx3 (or Rx3) antenna	ADVANCED-C ONNECTEK INC.	PCB, Inverted-F Antenna (IFA)	Color: Gray OD: 390 mm (low loss) Length: 355 mm Vendor: Kurabe/Hitachi/S umitomo Connector: IPEX 20278-111R-13	2400-2500MHz 1.60 dBi (peak) *	2400-2500MHz 2.70 dBi (peak) *	2400-2500MHz 2.0 max *	2400-2500MHz 1.1 dB (peak) *
				5150-5350MHz -1.30 dBi (peak) *	5150-5350MHz 0.20 dBi (peak) *	5150-5350MHz 2.0 max *	5150-5350MHz 1.5 dB (peak) *
				5470-5725MHz -1.00 dBi (peak) *	5470-5725MHz 0.50 dBi (peak) *	5470-5725MHz 2.0 max *	5470-5725MHz 1.5 dB (peak) *
				5725-5850MHz -0.50 dBi (peak) *	5725-5850MHz 1.00 dBi (peak) *	5725-5850MHz 2.0 max *	5725-5850MHz 1.5 dB (peak) *

NOTE:

(*) If Rx3 only (3rd antenna receives only, e.g. for 4965AGN) then the information marked with * is not required

Antenna Peak Gain Table:

Frequency (MHz)	Tx1 antenna		Tx2 Antenna		Tx3 (or Rx3) Antenna	
	Horizontal (dBi)	Vertical (dBi)	Horizontal (dBi)	Vertical (dBi)	Horizontal (dBi)	Vertical (dBi)
2412	-0.80	-0.20	-2.00	-1.70	-3.10	0.20
2437	0.10	-0.10	-1.60	-1.70	-3.10	0.80
2462	-0.40	-0.30	-1.30	-2.00	-2.50	1.60
4900	-3.20	-2.20	-0.20	-3.30	-1.60	-2.10
5150	-5.00	-3.30	-0.90	-3.30	-2.00	-2.00
5350	-4.20	-3.90	-1.90	-4.70	-1.40	-1.30
5470	-3.80	-2.80	-0.80	-5.30	-1.90	-1.50
5725	-3.30	-3.70	-1.00	-4.30	-1.90	-1.00
5875	-3.00	-3.60	-0.20	-2.80	-0.90	-0.50

- Antenna Peak Gain required being test in system basis.
- 1E frame contend absolutely peak antenna gain include H/V
- If Rx3 only (3rd antenna receives only, e.g. for 4965AGN) then the information is not required for Rx3.

Section 2. Dimensioned Photos or Drawings of Antennas

Include a dimensioned photo and dimensioned drawing of Tx1 antenna here.

Tx1 Antenna Dimensioned Drawing:

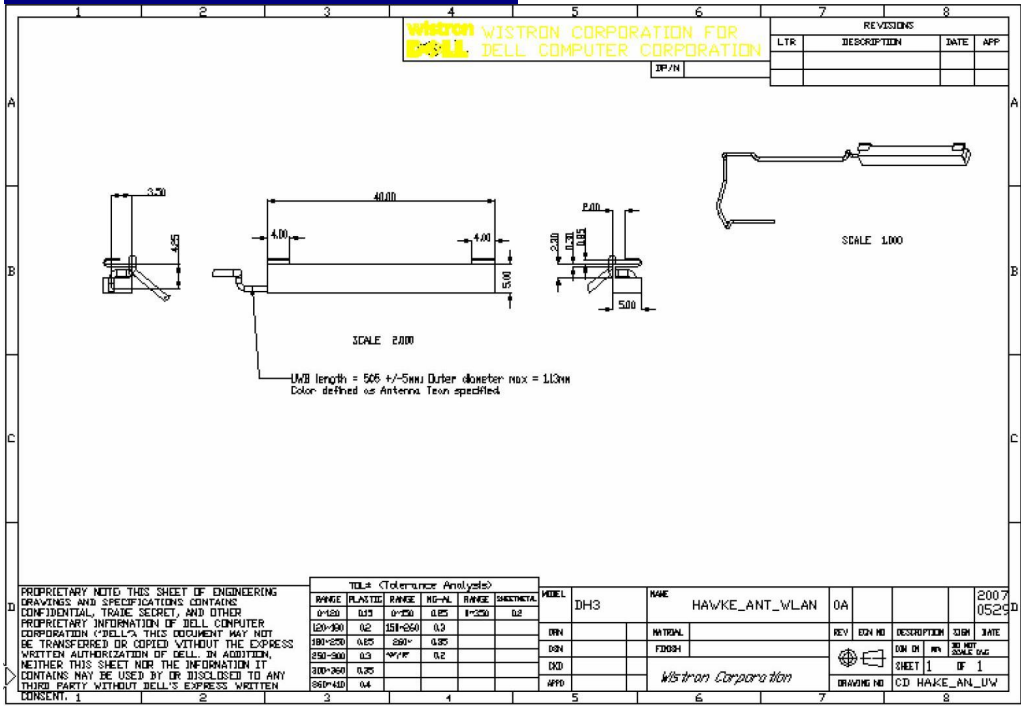

Tx1 Antenna Photo:



Main Antenna

Aux Antenna

MIMO Antenna

Include a dimensioned photo and dimensioned drawing of Tx2 antenna here.

Tx2 Antenna Dimensioned Drawing:

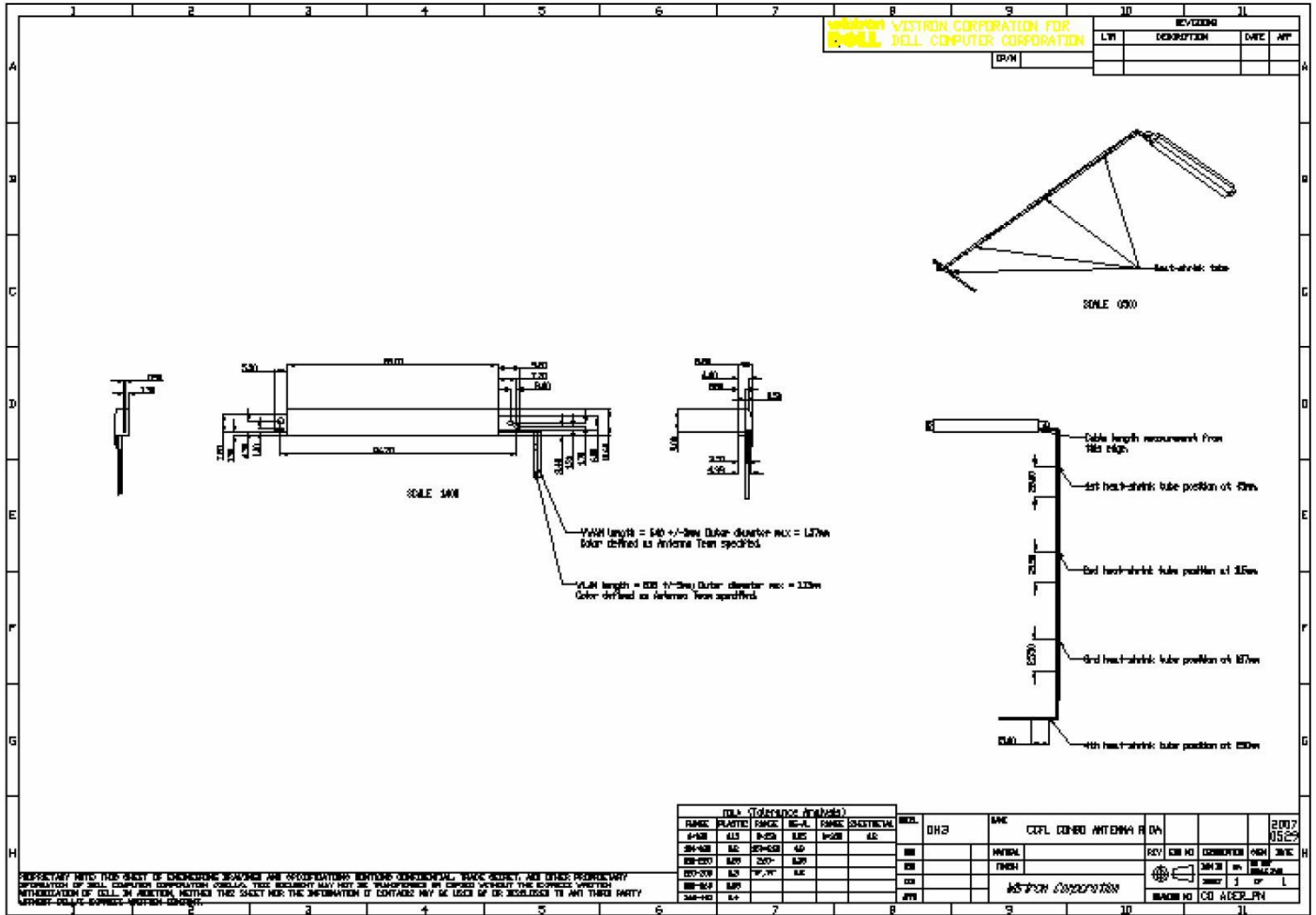

Tx2 Antenna Photo:

See TX1 Photo

Include a dimensioned photo and dimensioned drawing of Tx3 (or Rx3) antenna here.

Tx3 (or Rx3) Antenna Dimensioned Drawing:

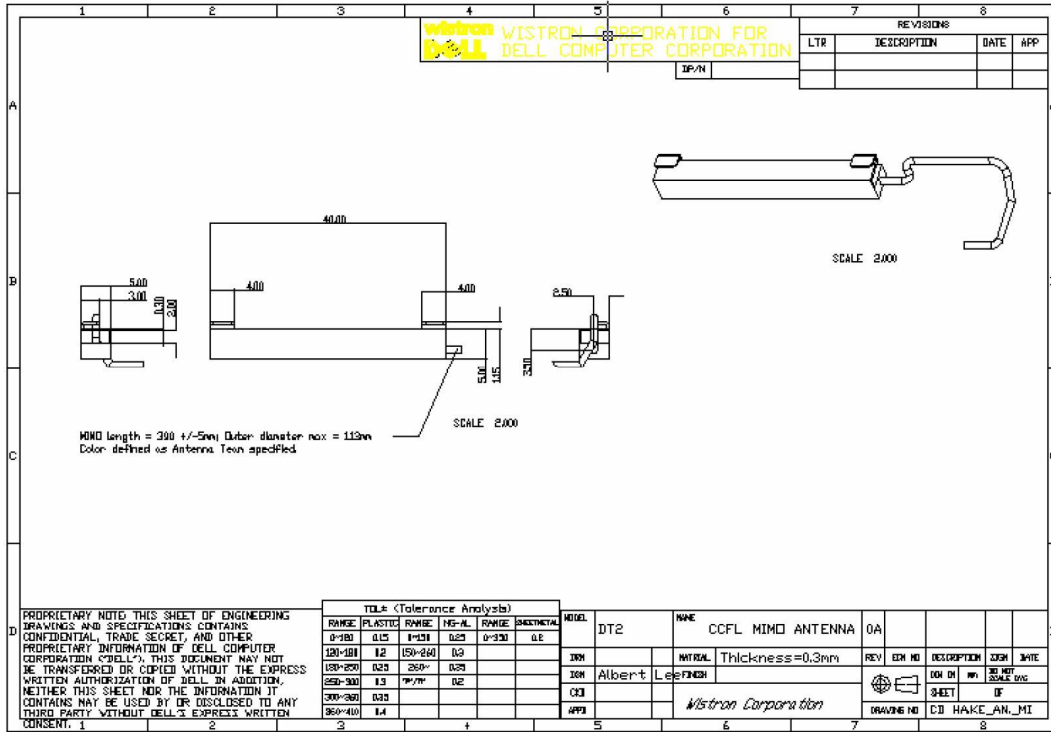

Tx3 (or Rx3) Antenna Photo:

See TX1 Photo

Section 3. Radiation characteristics of antennae Loaded in Host Platform

2400-2500MHz radiation characteristic

Tx1 antenna:

- Main Antenna



Fre. = 2412 MHz

Fre. = 2437 MHz

Fre. = 2462 MHz

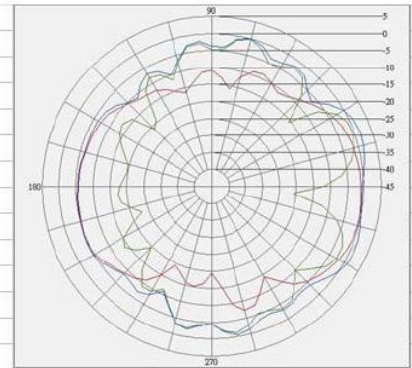
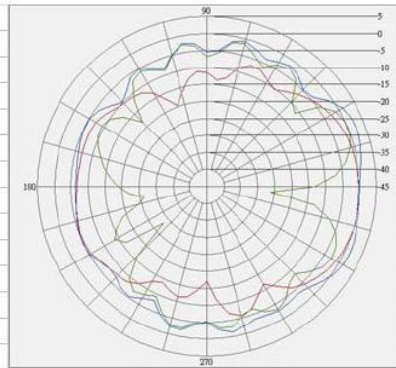
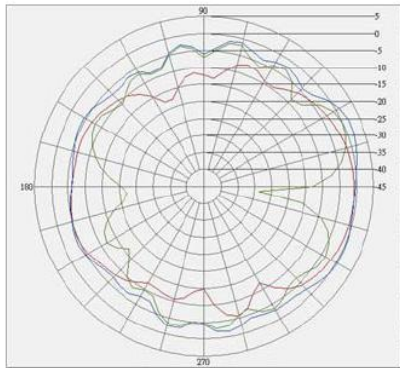

H-Pol. (Peak.)	-0.8	dBi	H-Pol. (Peak.)	0.1	dBi	H-Pol. (Peak.)	-0.4	dBi
V-Pol. (Peak.)	-0.2	dBi	V-Pol. (Peak.)	-0.1	dBi	V-Pol. (Peak.)	-0.3	dBi
H+V. (Peak.)	1.8	dBi	H+V. (Peak.)	2.3	dBi	H+V. (Peak.)	1.7	dBi
H-Pol. (Avg.)	-5.6	dBi	H-Pol. (Avg.)	-5.4	dBi	H-Pol. (Avg.)	-6	dBi
V-Pol. (Avg.)	-5.9	dBi	V-Pol. (Avg.)	-5.7	dBi	V-Pol. (Avg.)	-5.7	dBi
H+V. (Avg.)	-2.7	dBi	H+V. (Avg.)	-2.5	dBi	H+V. (Avg.)	-2.8	dBi

Tx2 antenna:

Fre. = 2412 MHz

Fre. = 2437 MHz

Fre. = 2462 MHz

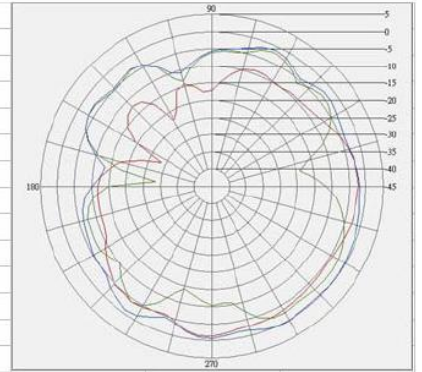
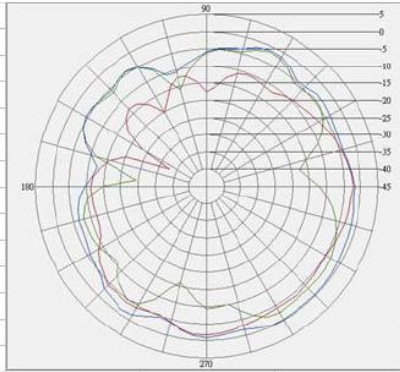
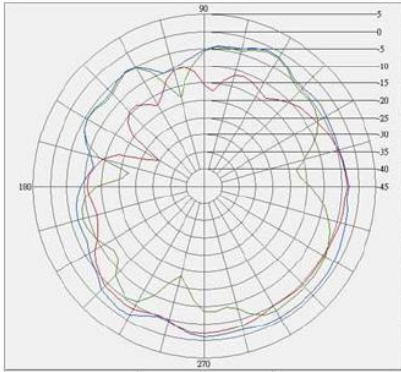

H-Pol. (Peak.)	-2	dB
V-Pol. (Peak.)	-1.7	dB
H+V. (Peak.)	-0.9	dB
H-Pol. (Avg.)	-6.5	dB
V-Pol. (Avg.)	-6.8	dB
H+V. (Avg.)	-3.6	dB

H-Pol. (Peak.)	-1.6	dB
V-Pol. (Peak.)	-1.7	dB
H+V. (Peak.)	-0.3	dB
H-Pol. (Avg.)	-6.3	dB
V-Pol. (Avg.)	-6.3	dB
H+V. (Avg.)	-3.3	dB

H-Pol. (Peak.)	-1.3	dB
V-Pol. (Peak.)	-2	dB
H+V. (Peak.)	0	dB
H-Pol. (Avg.)	-6.1	dB
V-Pol. (Avg.)	-5.8	dB
H+V. (Avg.)	-2.9	dB

Tx3 (or Rx3) antenna:

Fre. = 2412 MHz

Fre. = 2437 MHz

Fre. = 2462 MHz

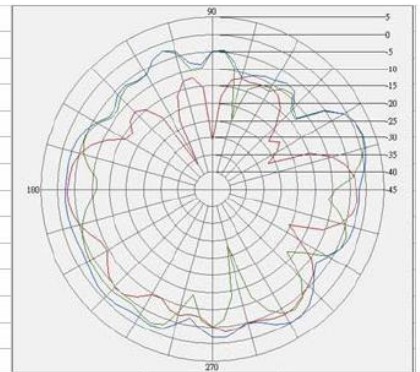
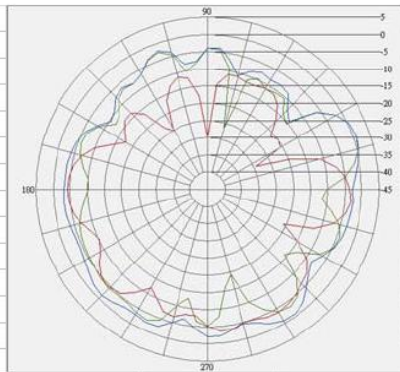
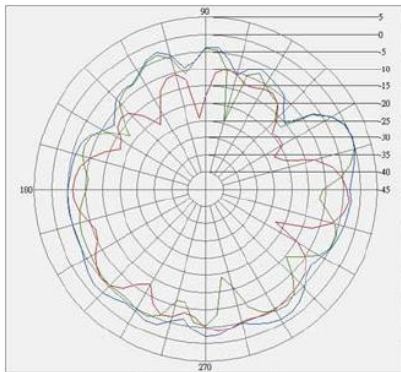

H-Pol. (Peak.)	-3.1	dB
V-Pol. (Peak.)	0.2	dB
H+V. (Peak.)	0.2	dB
H-Pol. (Avg.)	-8.4	dB
V-Pol. (Avg.)	-6.5	dB
H+V. (Avg.)	-4.3	dB

H-Pol. (Peak.)	-3.1	dB
V-Pol. (Peak.)	0.8	dB
H+V. (Peak.)	0.9	dB
H-Pol. (Avg.)	-7.9	dB
V-Pol. (Avg.)	-5.8	dB
H+V. (Avg.)	-3.7	dB

H-Pol. (Peak.)	-2.5	dB
V-Pol. (Peak.)	1.6	dB
H+V. (Peak.)	1.7	dB
H-Pol. (Avg.)	-7.2	dB
V-Pol. (Avg.)	-5.2	dB
H+V. (Avg.)	-3.1	dB

4900-5875 MHz radiation characteristic

Tx1 antenna:

Fre. = 4900 MHz

Fre. = 5150 MHz

Fre. = 5350 MHz

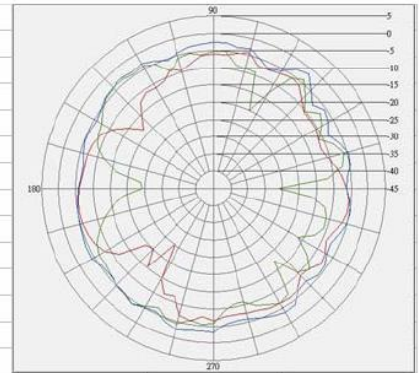
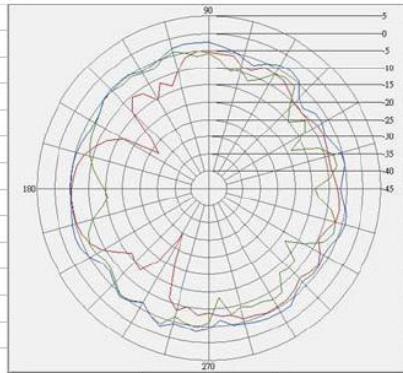
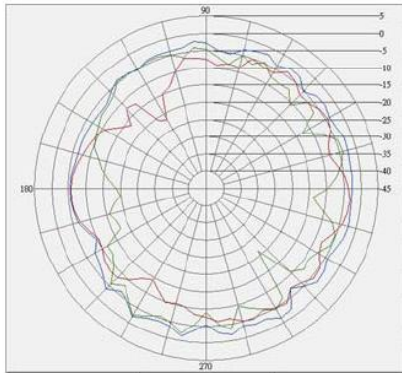

H-Pol. (Peak.)	-3.2	dBi
V-Pol. (Peak.)	-2.2	dBi
H+V. (Peak.)	-1.5	dBi
H-Pol. (Avg.)	-7	dBi
V-Pol. (Avg.)	-6.9	dBi
H+V. (Avg.)	-3.9	dBi

H-Pol. (Peak.)	-5	dBi
V-Pol. (Peak.)	-3.3	dBi
H+V. (Peak.)	-2.6	dBi
H-Pol. (Avg.)	-8.1	dBi
V-Pol. (Avg.)	-7.7	dBi
H+V. (Avg.)	-4.9	dBi

H-Pol. (Peak.)	-4.2	dBi
V-Pol. (Peak.)	-3.9	dBi
H+V. (Peak.)	-1.8	dBi
H-Pol. (Avg.)	-7.9	dBi
V-Pol. (Avg.)	-7.5	dBi
H+V. (Avg.)	-4.7	dBi

Fre. = 5470 MHz

Fre. = 5725 MHz

Fre. = 5875 MHz

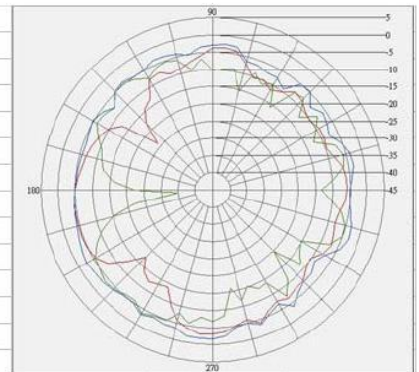
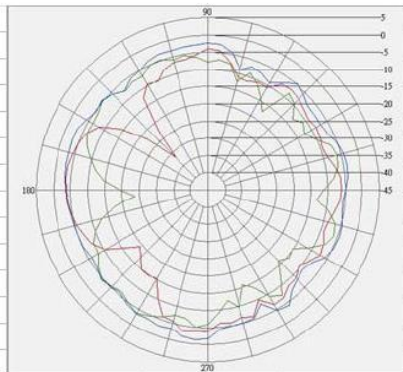
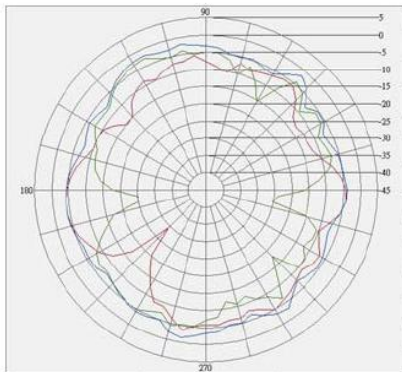

H-Pol. (Peak.)	-3.8	dBi
V-Pol. (Peak.)	-2.8	dBi
H+V. (Peak.)	-1.5	dBi
H-Pol. (Avg.)	-7.6	dBi
V-Pol. (Avg.)	-7.7	dBi
H+V. (Avg.)	-4.6	dBi

H-Pol. (Peak.)	-3.3	dBi
V-Pol. (Peak.)	-3.7	dBi
H+V. (Peak.)	-1.4	dBi
H-Pol. (Avg.)	-7.3	dBi
V-Pol. (Avg.)	-7.9	dBi
H+V. (Avg.)	-4.6	dBi

H-Pol. (Peak.)	-3	dBi
V-Pol. (Peak.)	-3.6	dBi
H+V. (Peak.)	-1.6	dBi
H-Pol. (Avg.)	-7.1	dBi
V-Pol. (Avg.)	-8	dBi
H+V. (Avg.)	-4.5	dBi

Tx2 antenna:

Fre. = 4900 MHz

Fre. = 5150 MHz

Fre. = 5350 MHz

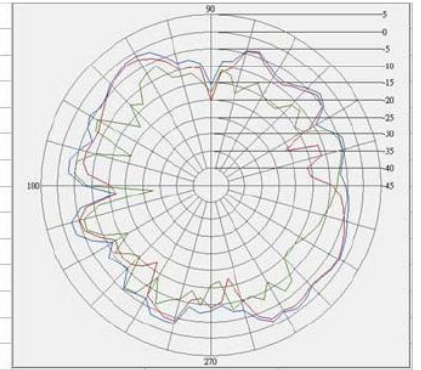
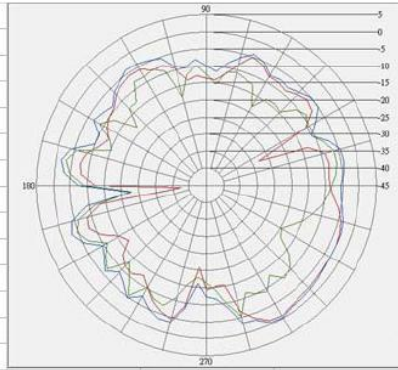
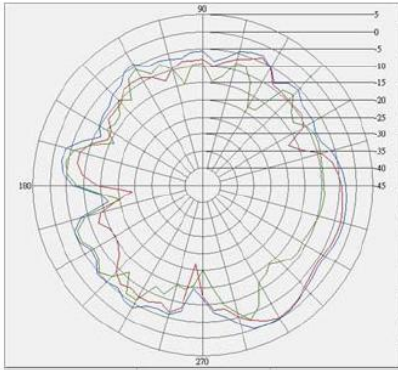

H-Pol. (Peak.)	-0.2	dBi
V-Pol. (Peak.)	-3.3	dBi
H+V. (Peak.)	0.1	dBi
H-Pol. (Avg.)	-6.7	dBi
V-Pol. (Avg.)	-9.1	dBi
H+V. (Avg.)	-4.8	dBi

H-Pol. (Peak.)	-0.9	dBi
V-Pol. (Peak.)	-3.3	dBi
H+V. (Peak.)	-0.3	dBi
H-Pol. (Avg.)	-7.1	dBi
V-Pol. (Avg.)	-9.6	dBi
H+V. (Avg.)	-5.1	dBi

H-Pol. (Peak.)	-1.9	dBi
V-Pol. (Peak.)	-4.7	dBi
H+V. (Peak.)	-0.8	dBi
H-Pol. (Avg.)	-6.2	dBi
V-Pol. (Avg.)	-9.7	dBi
H+V. (Avg.)	-4.6	dBi

Fre. = 5470 MHz

Fre. = 5725 MHz

Fre. = 5875 MHz

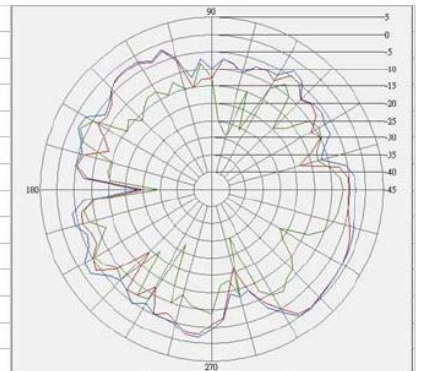
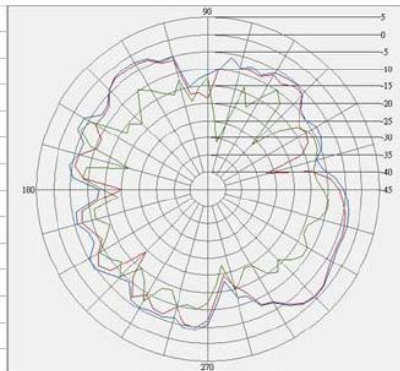
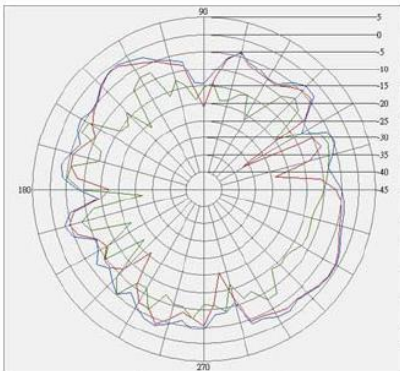

H-Pol. (Peak.)	-0.8	dBi
V-Pol. (Peak.)	-5.3	dBi
H+V. (Peak.)	-0.6	dBi
H-Pol. (Avg.)	-5.8	dBi
V-Pol. (Avg.)	-10.4	dBi
H+V. (Avg.)	-4.5	dBi

H-Pol. (Peak.)	-1	dBi
V-Pol. (Peak.)	-4.3	dBi
H+V. (Peak.)	-0.9	dBi
H-Pol. (Avg.)	-6.7	dBi
V-Pol. (Avg.)	-12	dBi
H+V. (Avg.)	-5.6	dBi

H-Pol. (Peak.)	-0.2	dBi
V-Pol. (Peak.)	-2.8	dBi
H+V. (Peak.)	0.1	dBi
H-Pol. (Avg.)	-5.5	dBi
V-Pol. (Avg.)	-10.4	dBi
H+V. (Avg.)	-4.3	dBi

Tx3 (or Rx3) antenna:

Fre. = 4900 MHz

Fre. = 5150 MHz

Fre. = 5350 MHz

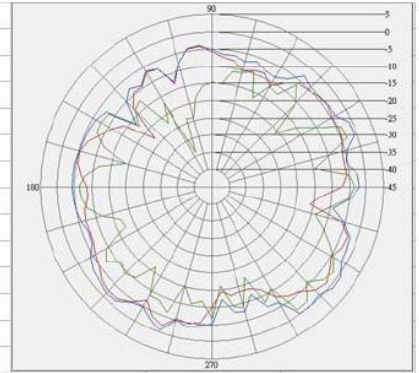
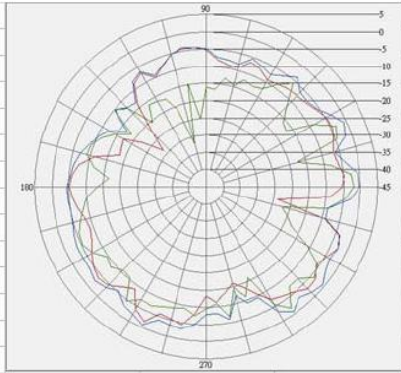
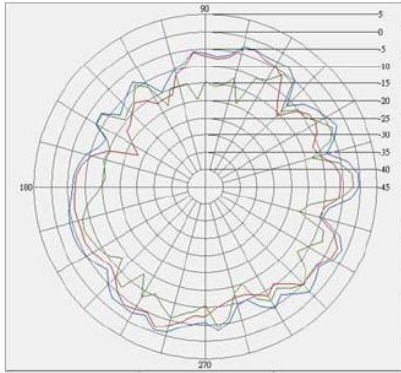

H-Pol. (Peak.)	-1.6	dBi
V-Pol. (Peak.)	-2.1	dBi
H+V. (Peak.)	-0.5	dBi
H-Pol. (Avg.)	-7.1	dBi
V-Pol. (Avg.)	-8.7	dBi
H+V. (Avg.)	-4.9	dBi

H-Pol. (Peak.)	-2	dBi
V-Pol. (Peak.)	-2	dBi
H+V. (Peak.)	-0.4	dBi
H-Pol. (Avg.)	-6.7	dBi
V-Pol. (Avg.)	-8.6	dBi
H+V. (Avg.)	-4.6	dBi

H-Pol. (Peak.)	-1.4	dBi
V-Pol. (Peak.)	-1.3	dBi
H+V. (Peak.)	0.9	dBi
H-Pol. (Avg.)	-6.1	dBi
V-Pol. (Avg.)	-8.4	dBi
H+V. (Avg.)	-4.1	dBi

Fre. = 5470 MHz

Fre. = 5725 MHz

Fre. = 5875 MHz

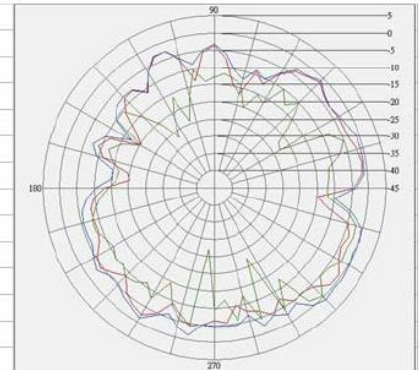
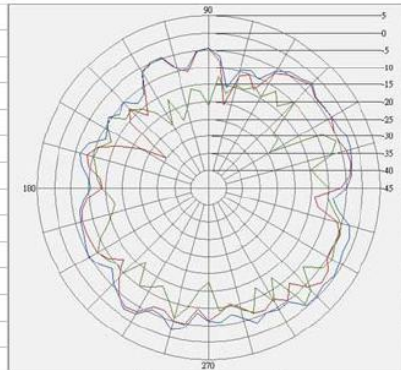
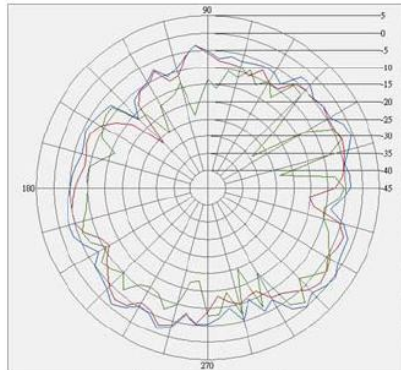

H-Pol. (Peak.)	-1.9	dBi
V-Pol. (Peak.)	-1.5	dBi
H+V. (Peak.)	0.4	dBi
H-Pol. (Avg.)	-6.4	dBi
V-Pol. (Avg.)	-8.6	dBi
H+V. (Avg.)	-4.3	dBi

H-Pol. (Peak.)	-1.9	dBi
V-Pol. (Peak.)	-1	dBi
H+V. (Peak.)	-0.3	dBi
H-Pol. (Avg.)	-6.5	dBi
V-Pol. (Avg.)	-9.6	dBi
H+V. (Avg.)	-4.8	dBi

H-Pol. (Peak.)	-0.9	dBi
V-Pol. (Peak.)	-0.5	dBi
H+V. (Peak.)	1.1	dBi
H-Pol. (Avg.)	-5.6	dBi
V-Pol. (Avg.)	-8.4	dBi
H+V. (Avg.)	-3.7	dBi

Section 4. Host Platform Information

OEM / ODM Host platform: (XXXXXXX) platform correlated to antenna data

Rating Label Photo:

Section 5. Antenna Host Platform Location Information

Include a **dimensioned photo or dimensioned drawing** of Tx1, Tx2 and Tx3 antenna placements. (Not applicable for receive-only antenna e.g. Rx3 for 4965AGN)

Main Antenna

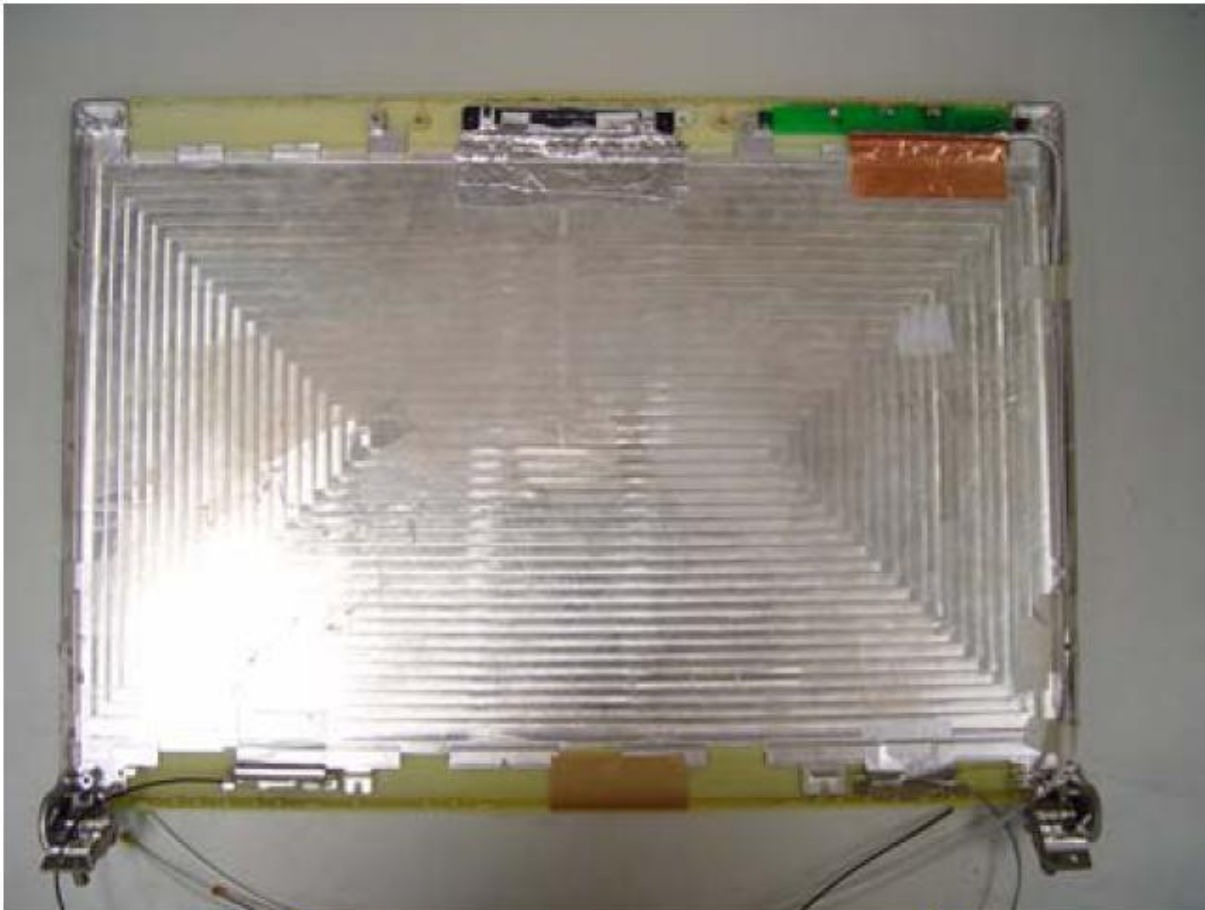

Aux Antenna



MIMO Antenna

Section 6. Antenna dimensional information for SAR evaluation

Include a **dimensioned photo or dimensioned drawing** showing the distance (mm) between the transmit antennas and the user (excluding hands, wrist, feet, lap/ thigh, and ankle)

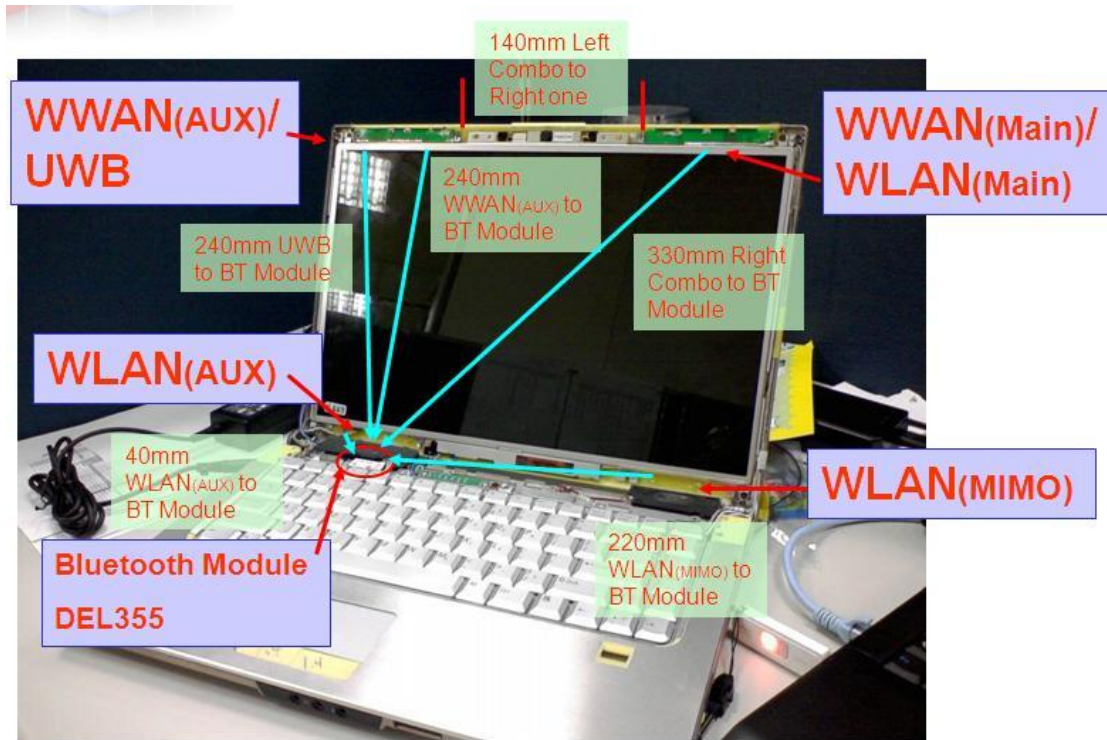
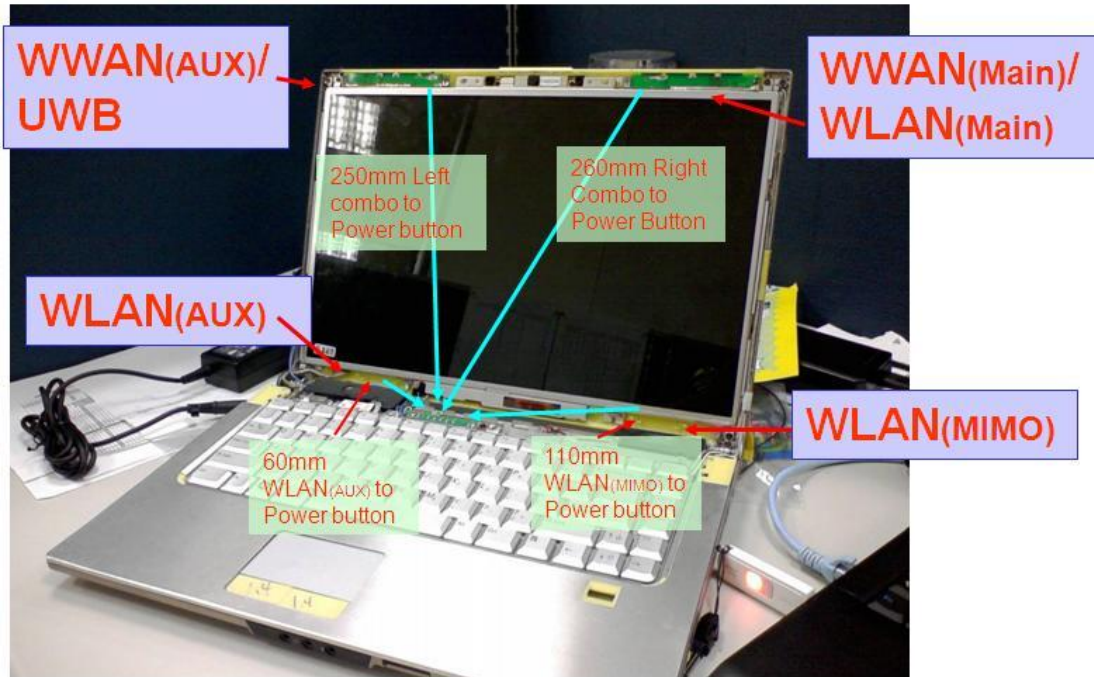

Section 7. Diagram Example of Co-Location Antenna Separation

Include a **dimensioned photo or dimensioned drawing** showing the distance (mm) between all WLAN transmit antennas and other co-located radiator transmit antenna such as Bluetooth, WWAN,..

(Note: Due to the evolving rules regarding co-location, each platform will need to be reviewed on a case by case basis)

See section 6 . Note that a WWAN antenna is co-located with the Tx1 WLAN antenna.

Section 8. Local representative contact information

Local representative contact information is required for regulatory support for target countries below.

	Local company name	Contact name	Phone number	FAX Number	e-Mail Address	Notes
Argentina	DELL COMPUTER DE CHILE	Hermann Obermoller	(562) 685 6803	(562) 232-4290	Hermann_Obermoller@dell.com	
Brazil		Rodrigo Sagredo	+55 (019) 252-8170		rodrigossagredo@mpc.com.br	
Indonesia	Dell Asia Pacific Sdn.	Catherine Mulia			Indonesia Representative Office Wisma GKBI 39 Floor, Suite 3901 Jl. Jend. Sudirman No. 28 Jakarta 10210, Indonesia.	
Israel	Dell	Raanan Biber	+972-(0)3-767 4001	+972-(0)3-644 4106	raanan_biber@dell.com	
Malaysia	Dell Asia Pacific Sdn.	Lily Wong	6-04-504-4670	6-04-633-8670	Lily_Wong@dell.com	
Mexico	DELL Computer	Maria Garcia	011-5255-5081-8849		Maria_Garcia@dell.com	
Singapore	Dell Computer Asia Pte Ltd	Doreen Koh	65-335-3282		Doreen_Koh@dell.com	Telecommunication Equipment Dealer License Required
South Africa	Dell South Africa	Leigh Hancock	+44 1344 372 647		Leigh_Hancock@dell.com	
USA, Canada	DELL CANADA INC.	KRISTIAN KOT	416-773-5095		Kristian_kot@dell.com	