

Regulatory WLAN Antenna Information for Gilbert

Hitachi Cable, Ltd

1-6-1, Otemachi, Chiyoda-ku, Tokyo, Japan

Antenna Specifications

Antenna Type (Material, Technology)	Monopole Type
Antenna Model Number	HFT17-DL03
Operating Frequency Range(s)	2.40 – 2.4835 GHz / 4.90 – 5.875 GHz
Peak Gain (802.11b/g / 2.4GHz Band) (dBi)	Main 1.5 / Aux 0.5
Peak Gain (802.11a / 5GHz Band) (dBi)	Main 5.1 / Aux 4.4
Radio Connector Type	Micro Coaxial Connector
Mid-Line Connector Type (If Applicable)	N/A

Note: Peak Gain should include all system losses (connector, cable, etc)

Cable Specifications

Cable Parameters	Main			Aux		
	LCD Side	Base Side	Total	LCD Side	Base Side	Total
Length (mm)	N/A	N/A	375	N/A	N/A	490
Loss (Including Connectors) (dB) 2.4 GHz / 5 GHz			1.0/1.6			1.3/2.2
Description (Color, Diameter, Manufacturer)	White ϕ 1.37 mm Hitachi Cable			Black ϕ 1.37 mm Hitachi Cable		

Note: For single cable assembly (no mid-line connector), use the 'Total' column for each cable length and list N/A in the 'LCD' and 'Base' fields

Cable Loss should be reported for the total cable assembly (for both Main and Aux antennas)



Picture of Antenna installed in the notebook



Picture of Antenna

EH3850816

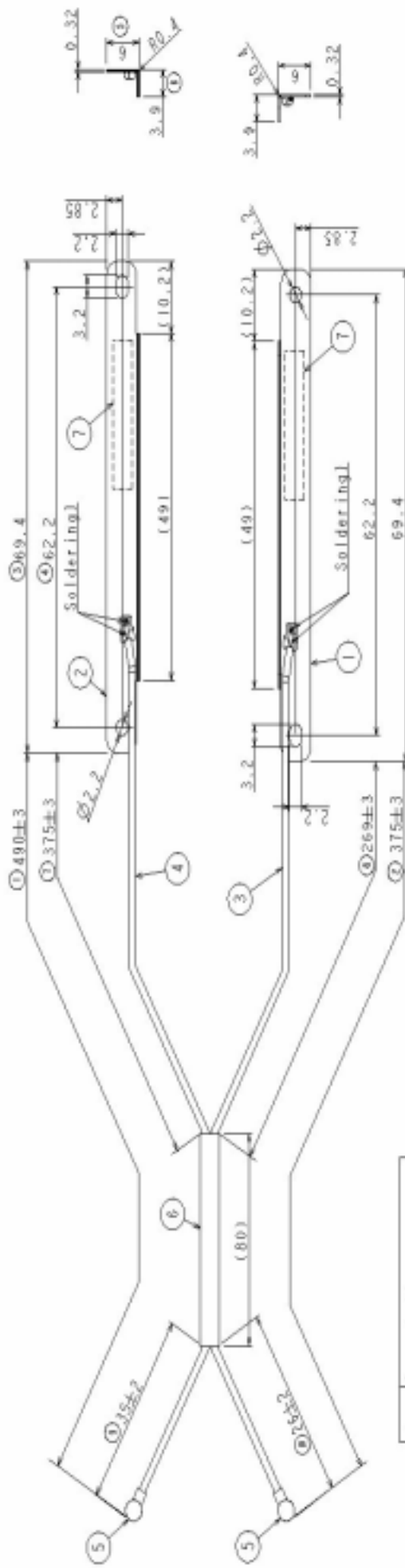
MARK
[A]REVISION
Radiator changedDATE NAME CHK'D.
M.15.15 K. ENDO R. SATO

No.	Description
1	Main Antenna
2	Aux Antenna
3	Coaxial Cable(White)
4	Coaxial Cable(Black)
5	mPCL connector
6	Nanometer Tape
7	Product Label
8	Protection tube

Note
 1. The dimensions on this drawing are numbered 1-10.
 2. The connector shall be covered with protection tube.

Note2: Protection Tube

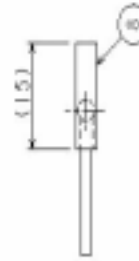

Customer P/N		TITLE	
DWN.	K. ENDO	04.05.25	
CHKD.	R. SATO	REGD. PROJ.	
APPD.	H. TATE		
SCALE	N.T.S		

TOLERANCES OF DIMENSIONS	
Dimension	Tolerance
6	±0.1
30	±0.3

HFT17-DL03

EH3850816

Hitachi Cable, Ltd.
Hitaka Works

CAD008: EH3850816RA CAD0088: MODEL NAME EPA-9-17: DRAFT

Main Antenna (1)

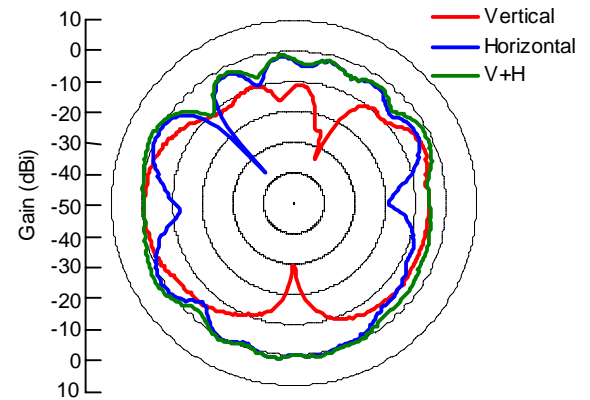
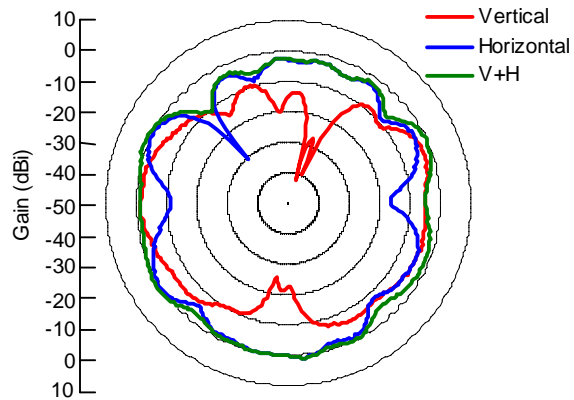
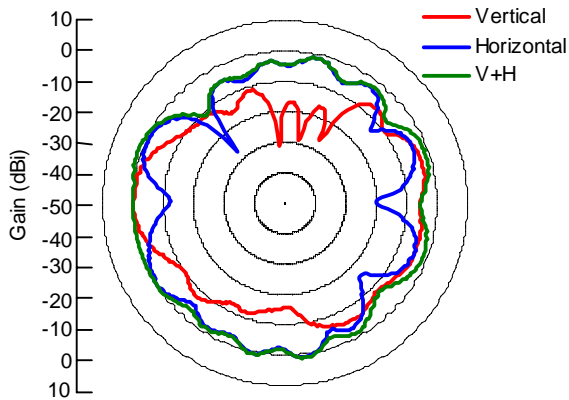

Frequency (MHz)	2400
Vertical Peak Gain (dBi)	-2.7
Horizontal Peak Gain (dBi)	1.2
V + H Peak Gain (dBi)	1.5

Frequency (MHz)	2442
Vertical Peak Gain (dBi)	-2.4
Horizontal Peak Gain (dBi)	1.2
V + H Peak Gain (dBi)	1.6

Frequency (MHz)	2484
Vertical Peak Gain (dBi)	-3.7
Horizontal Peak Gain (dBi)	1.5
V + H Peak Gain (dBi)	2.5

Main Antenna (2)

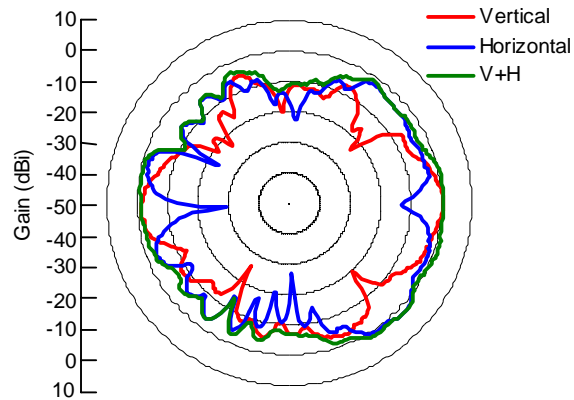

Frequency (MHz)	4900
Vertical Peak Gain (dBi)	0.8
Horizontal Peak Gain (dBi)	2.4
V + H Peak Gain (dBi)	2.6

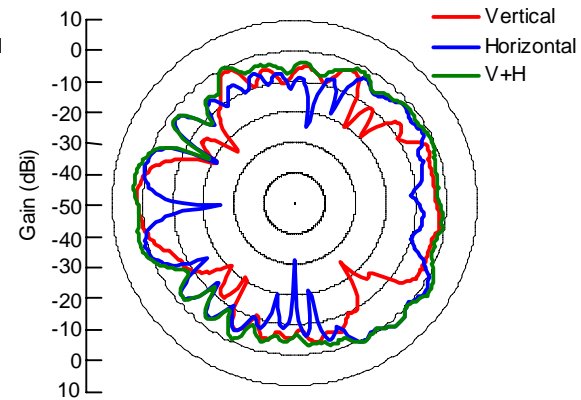

Frequency (MHz)	5150
Vertical Peak Gain (dBi)	2.1
Horizontal Peak Gain (dBi)	2.8
V + H Peak Gain (dBi)	3.6

Main Antenna (3)

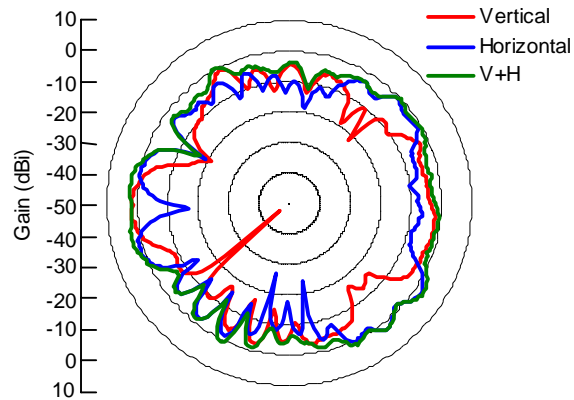

Frequency (MHz)	5250
Vertical Peak Gain (dBi)	1.9
Horizontal Peak Gain (dBi)	2.7
V + H Peak Gain (dBi)	3.4

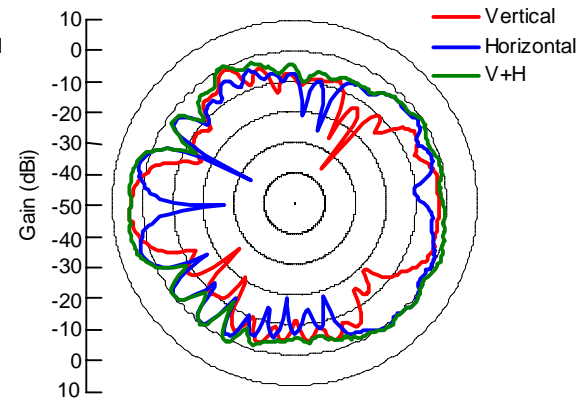

Frequency (MHz)	5350
Vertical Peak Gain (dBi)	4.4
Horizontal Peak Gain (dBi)	3.1
V + H Peak Gain (dBi)	5.1

Main Antenna (4)

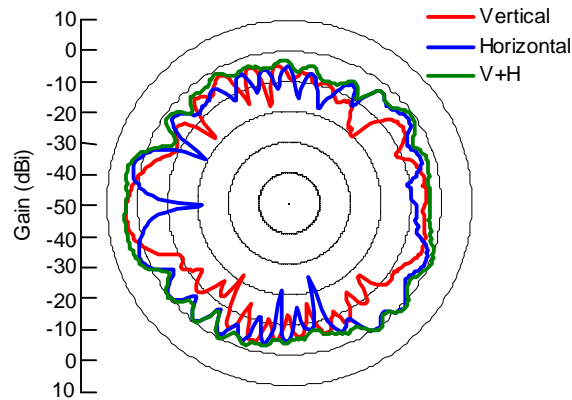

Frequency (MHz)	5470
Vertical Peak Gain (dBi)	4.1
Horizontal Peak Gain (dBi)	2.9
V + H Peak Gain (dBi)	4.7

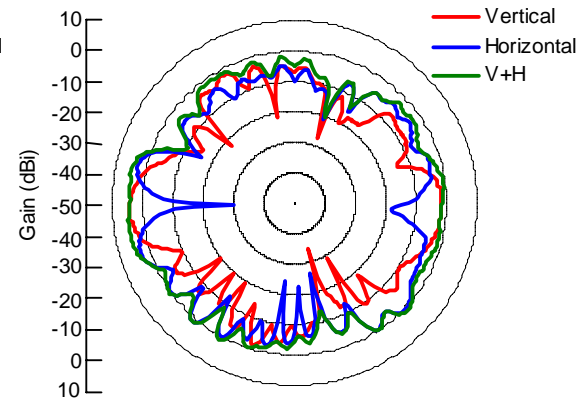

Frequency (MHz)	5598
Vertical Peak Gain (dBi)	4.5
Horizontal Peak Gain (dBi)	3.4
V + H Peak Gain (dBi)	5.3

Main Antenna (5)

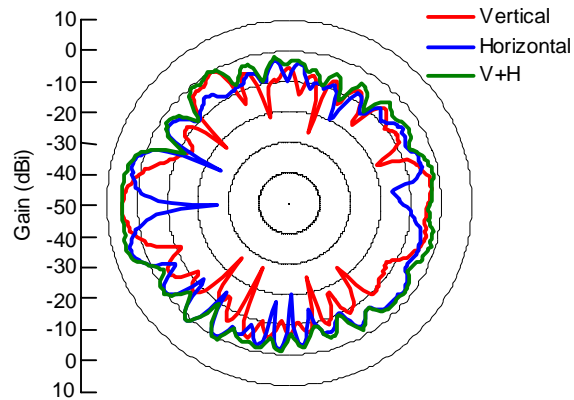

Frequency (MHz)	5725
Vertical Peak Gain (dBi)	5.1
Horizontal Peak Gain (dBi)	4.8
V + H Peak Gain (dBi)	5.7

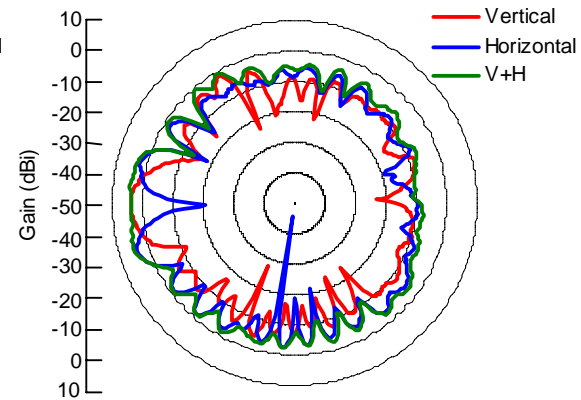

Frequency (MHz)	5850
Vertical Peak Gain (dBi)	4.1
Horizontal Peak Gain (dBi)	4.3
V + H Peak Gain (dBi)	5.3

Aux Antenna (1)

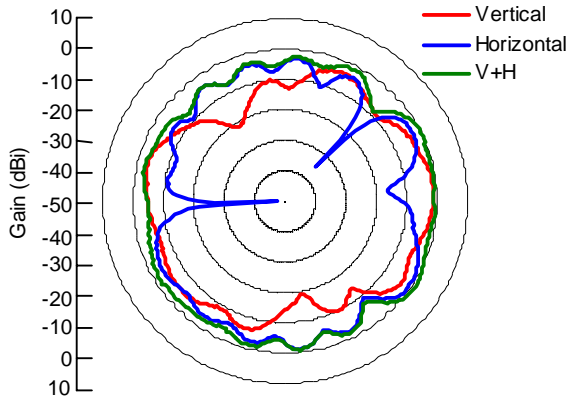

Frequency (MHz)	2400
Vertical Peak Gain (dBi)	-0.8
Horizontal Peak Gain (dBi)	-0.2
V + H Peak Gain (dBi)	1.6

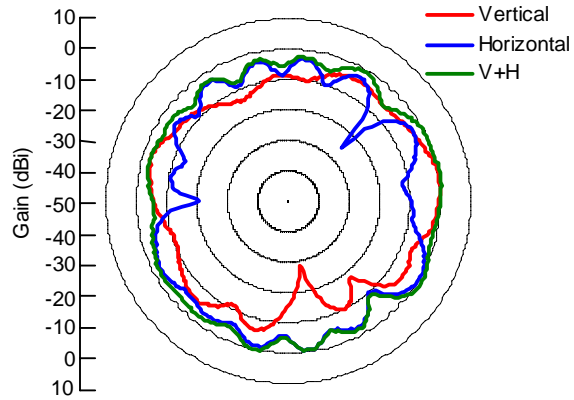

Frequency (MHz)	2442
Vertical Peak Gain (dBi)	0.4
Horizontal Peak Gain (dBi)	0.4
V + H Peak Gain (dBi)	1.6

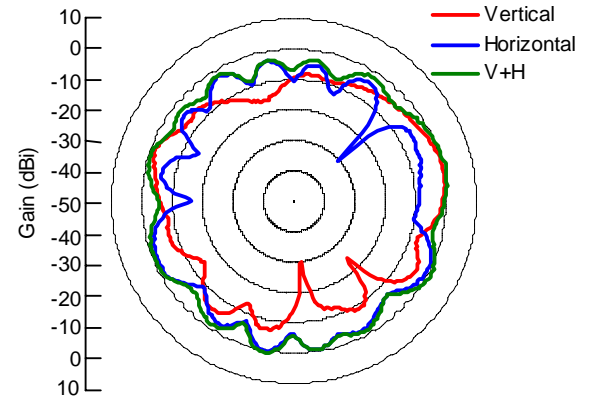

Frequency (MHz)	2484
Vertical Peak Gain (dBi)	0.5
Horizontal Peak Gain (dBi)	0.3
V + H Peak Gain (dBi)	1.3

Aux Antenna (2)

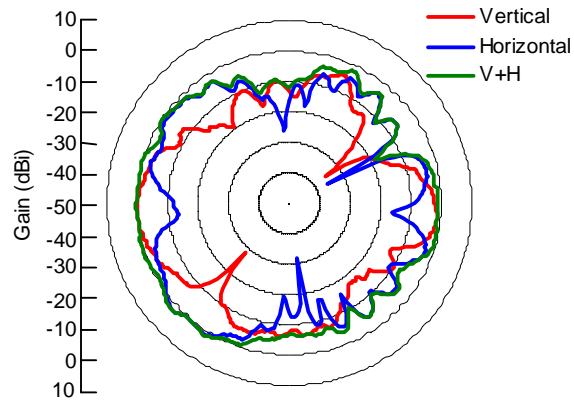

Frequency (MHz)	4900
Vertical Peak Gain (dBi)	0.3
Horizontal Peak Gain (dBi)	2.0
V + H Peak Gain (dBi)	2.4

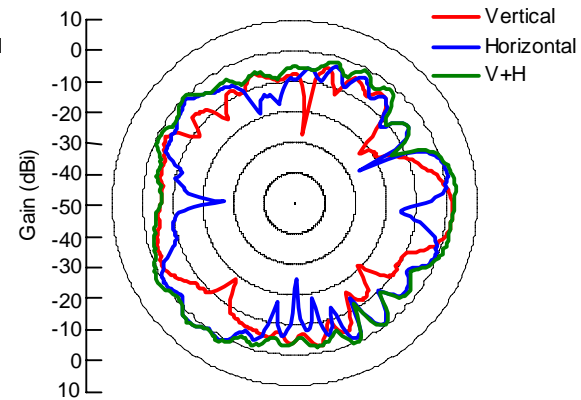

Frequency (MHz)	5150
Vertical Peak Gain (dBi)	2.3
Horizontal Peak Gain (dBi)	2.9
V + H Peak Gain (dBi)	3.2

Aux Antenna (3)

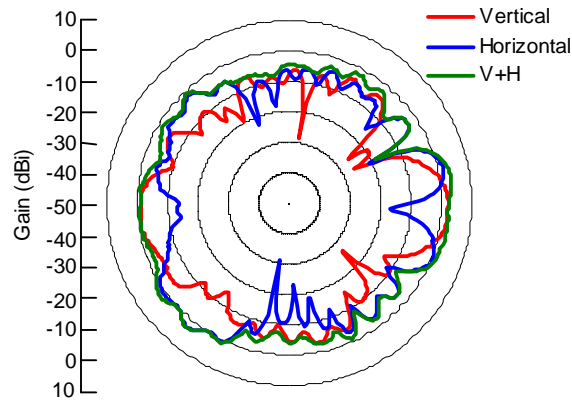

Frequency (MHz)	5250
Vertical Peak Gain (dBi)	2.4
Horizontal Peak Gain (dBi)	3.1
V + H Peak Gain (dBi)	3.9

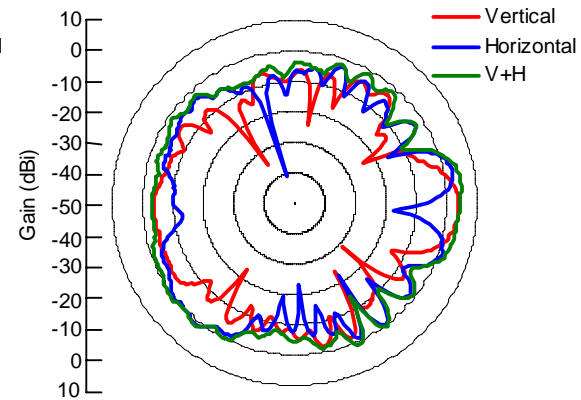

Frequency (MHz)	5350
Vertical Peak Gain (dBi)	4.2
Horizontal Peak Gain (dBi)	3.1
V + H Peak Gain (dBi)	5.2

Aux Antenna (4)

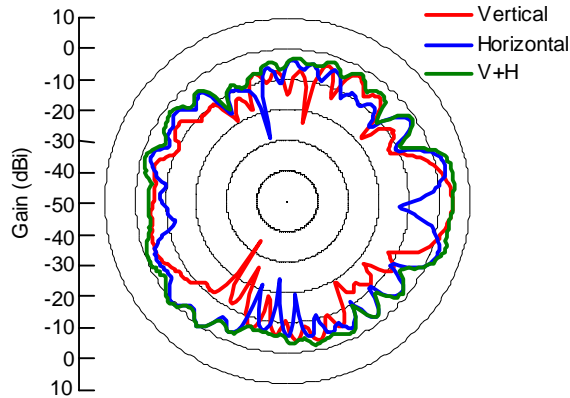

Frequency (MHz)	5470
Vertical Peak Gain (dBi)	4.4
Horizontal Peak Gain (dBi)	3.3
V + H Peak Gain (dBi)	5.4

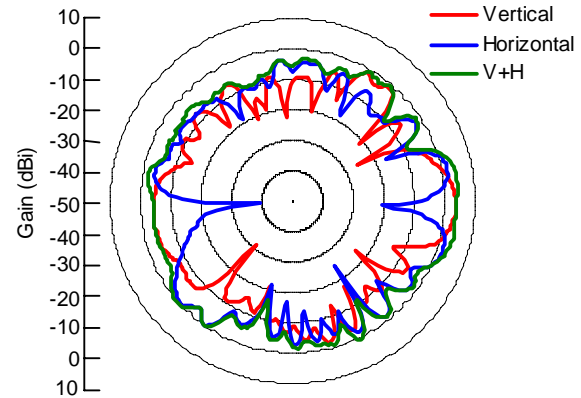

Frequency (MHz)	5598
Vertical Peak Gain (dBi)	3.8
Horizontal Peak Gain (dBi)	2.4
V + H Peak Gain (dBi)	4.8

Aux Antenna (5)

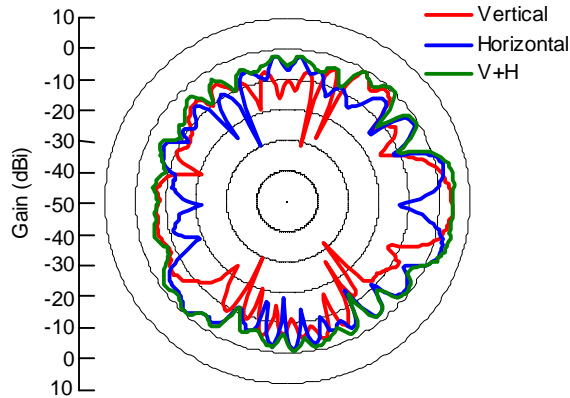

Frequency (MHz)	5725
Vertical Peak Gain (dBi)	4.4
Horizontal Peak Gain (dBi)	3.6
V + H Peak Gain (dBi)	5.1

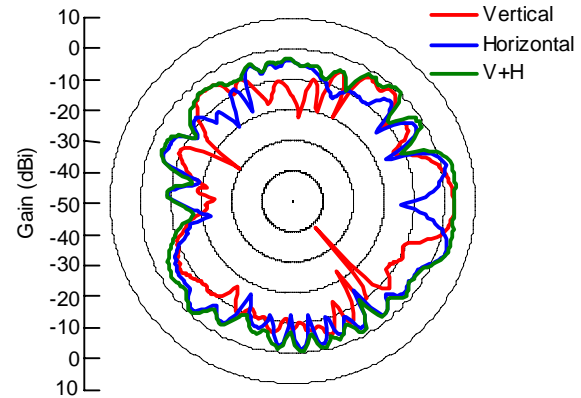

Frequency (MHz)	5850
Vertical Peak Gain (dBi)	3.5
Horizontal Peak Gain (dBi)	3.4
V + H Peak Gain (dBi)	4.1