



AEGIS LABS INC.



Class II Permissive Change
Test Report
And Application for Grant of Equipment Authorization

Pertaining To:

EUT	FCC ID:
Latitude D810 Notebook Computer, MN: PP15L	E2K24CLNS

Configuration
Tested with an Intel PRO/Wireless 2100 Network Connection, MN: WM3A2100 With a set of Foxconn and Hitachi Antennas

MEASUREMENTS PERFORMED IN ACCORDANCE WITH

Regulatory Standard(s)
47 CFR Part 15, Subpart C Section 15.247
Test Method: ANSI C63.4: 2001 American National Standard for Methods of Measurement of Radio-Noise Emissions from Low-Voltage Electrical and Electronic Equipment in the Range of 9 kHz to 40 GHz



Certificate Number: 1111.01

APPLICANT:

Dell Computer Corporation
One Dell Way
Round Rock, TX 78682

Contact(s): Mr. Jason Limoges

PREPARED BY:

Aegis Labs, Inc.
22431 Antonio Parkway B160-417
Rancho S. Margarita, CA 92688

Agent(s): Mr. Steve Kuiper
Mr. Rick Candelas
Mr. Johnny Candelas

Test Report #: INTEL-040915F
Test Report Revision: None

	REPORT BODY	APPENDICES	TOTAL PAGES
		<i>A</i>	
PAGES	16	39	55

The contents of this report shall not be reproduced except in full, without the written approval of Aegis Labs, Inc.

Page 1 of 16
Report Number: INTEL-040915F
FCC ID: E2K24CLNS



TABLE OF CONTENTS

SECTION	TITLE	PAGE
	COVER SHEET.....	01
	TABLE OF CONTENTS.....	02
1.0	CERTIFICATION OF TEST DATA.....	03
2.0	SUMMARY OF TEST RESULTS.....	04
3.0	ADMINISTRATIVE DATA AND TEST DESCRIPTION.....	05
4.0	DESCRIPTION OF EUT.....	06
4.1	EUT Description.....	06
4.1.1	Channel Number and Frequencies.....	07
4.2	EUT Configuration.....	08
4.3	List of EUT Sub-Assemblies and Host Equipment.....	09
4.4	I/O Cabling Diagram and Description.....	10
5.0	TEST EQUIPMENT AND TEST SETUPS.....	11
5.1	AC Power Line Conducted Emissions.....	11
5.2	Spurious Radiated Emissions.....	12
5.3	Conducted Emissions At The Antenna Port.....	12
5.4	Test and Measurement Equipment Used.....	13
6.0	SAMPLE CALCULATIONS.....	14
7.0	MODIFICATIONS AND RECOMMENDATIONS.....	16

APPENDICES

A	Test Data
---	-----------



AEGIS LABS INC.

1.0 CERTIFICATION OF TEST DATA

Aegis Labs, Inc. operates as both a Nevada and California Corporation with no organizational or financial relationship with any company, institution, or private individual.

Testing and engineering functions provided by Aegis Labs are furnished through the use of part-time, full-time or consulting engineers with the appropriate qualifications to carry out their duties. The intended purpose of this test report is to describe the measurement procedure and to determine whether the equipment under test "EUT" complies with both the conducted and radiated limits. Limits for emissions testing are described under Subpart C of Part 15 of the FCC rules.

The data, data evaluation and equipment configuration represented herein are a true and accurate representation of the Equipment Under Test (EUT) under the requirements specified in the emissions standard as described below. The test results contained in this report are only representative of the test sample tested as described in Section 3.0 of this report. Certification of the EUT is required as a prerequisite to marketing as defined in Part 2 of the FCC Rules.

Prepared By:

Johnny Candelas
Test Technician
Aegis Labs, Inc.

11/23/04

Date:

Reviewed By:

Rick Candelas
Lab Manager
Aegis Labs, Inc.

11/23/04

Date:

Report Approved By:

Steve J. Kuiper
Quality Assurance Manager
Aegis Labs, Inc.

11/23/04

Date:



AEGIS LABS INC.

2.0 SUMMARY OF TEST RESULTS

The test results provided within this report, indicate that the EUT has been found to be in **COMPLIANCE** with the test specifications based upon the following RF compliance standards:

Pass/Fail determination is based upon the nominal values of the test data.

EMISSIONS STANDARD			
FCC Part 15 Section	Description	Results	Comments
15.247(a)(2)	The minimum 6dB bandwidth shall be at least 500 kHz.	PASSED	2412 MHz = 12.58 MHz 2437 MHz = 12.50 MHz 2462 MHz = 12.67 MHz
15.247(b)(1)	The maximum peak output power of the intentional radiator shall not exceed 1 watt.	PASSED	2412 MHz = 16.40 dBm = 43.65 mW 2437 MHz = 16.10 dBm = 40.74 mW 2462 MHz = 16.15 dBm = 41.21 mW
15.247(b)(4)	The intentional radiator shall be operated in a manner that ensures that the public is not exposed to radio frequency energy levels in excess of the FCC guidelines per Section 1.1307(b)(1).	PASSED	Refer to SAR Test Reports
15.247(c)	In any 100 kHz bandwidth outside the frequency band in which the spread spectrum intentional radiator is operating, the radio frequency power that is produced by the intentional radiator shall be at least 20 dB below that in the 100 kHz bandwidth within the band that contains the highest level of the desired power.	PASSED	See Data Sheets
15.247(c)	Radiated emissions, which fall in the restricted bands, as defined in Sec. 15.205(a), must also comply with the radiated emission limits specified in Sec. 15.209(a). All others must be < -20dBc.	PASSED	See Data Sheets
15.247(d)	The peak power spectral density conducted from the intentional radiator to the antenna shall not be greater than 8 dBm in any 3 kHz band during any time interval of continuous transmission.	PASSED	2412 MHz = -7.00 dB 2437 MHz = -6.33 dB 2462 MHz = -6.83 dB
15.207	AC Conducted Emissions	PASSED	See Data Sheets
15.209	Radiated Emissions (30-1000 MHz)	PASSED	See Data Sheets

Page 4 of 16

Report Number: INTEL-040915F

FCC ID: E2K24CLNS



AEGIS LABS INC.

3.0 ADMINISTRATIVE DATA AND TEST DESCRIPTION

DEVICE TESTED:	ITE Type: Latitude D810 Notebook Computer Model Number(s): PP15L Serial Number: GVQKT41 FCC ID: E2K24CLNS
TEST DATE (S):	September 8-14, 2004
DATE EUT RECEIVED:	July 28, 2004
ORIGIN OF TEST SAMPLE(S):	Production Unit
RESPONSIBLE PARTY:	Dell Computer Corporation One Dell Way Round Rock, TX 78682
CLIENT CONTACT:	Mr. Jason Limoges
MANUFACTURER:	Dell Computer Corporation
TEST LOCATION:	Aegis Labs, Inc. 32231 Trabuco Creek Road Trabuco Canyon, CA 92678 Conducted Site #2 Radiated Site #2
A2LA CERTIFICATE:	1111.01, Valid through February 28, 2006
PURPOSE OF TEST:	To demonstrate compliance with the relevant standards described in Section 2.0 of this report.
TEST(S) PERFORMED:	Refer to Table in Section 2.0 of this report.

All calibration vendors were responsible for certifying Aegis Labs, Inc. test equipment as per the manufacturer's specifications and that the equipment is calibrated using instruments and standards where the accuracy is traceable to the National Institute of Standards and Technology (NIST). Calibration of all test equipment conforms to ANSI/NCSL Z540-1 and ISO 10012-1 and/or ISO/IEC Guide 17025 compliance (Additionally, other pertinent test equipment will carry MIL-STD-45662A). All calibration documents are on file with Aegis Labs, Inc., with copies provided upon request.

Page 5 of 16
Report Number: INTEL-040915F
FCC ID: E2K24CLNS



4.0 DESCRIPTION OF EUT

4.1 EUT Description

Equipment Under Test (EUT)		
Trade Name:	Latitude D810 Notebook Computer	
Model Number:	PP15L tested with an Intel PRO/Wireless 2100 Network Connection, MN: WM3A2100	
Frequency Range:	802.11b = 2412 – 2462MHz	
Type of Transmission:	Direct Sequence Spread Spectrum	
Transfer Rate:	1/5.5/11 Mbps for 802.11b mode	
Number of Channels:	802.11b mode (2400-2483.5 MHz) = 11	
Modulation Type:	DBPSK, DQPSK, CCK, OFDM	
Antenna Type:	<u>Hitachi:</u> Monopole (Main/Aux)	<u>Foxconn:</u> PIFA (Main/Aux)
Antenna Gain (See Note 2):	<u>Hitachi:</u> 2.4 GHz = 1.90 dBi	<u>Foxconn:</u> 2.4 GHz = 2.60 dBi
Transmit Output Power:	16.5 dBm (Typical) for 802.11b mode Please see Appendix A (Data Sheets) for actual output power.	
Power Supply:	3.3VDC from computer MPCPI slot.	
Number of External Test Ports Exercised:	2 Antenna Ports (1 Main & 1 Auxiliary)	

The Latitude | D810 Notebook Computer was tested with an Intel PRO/Wireless 2100 Network Connection as an embedded 2.4 GHz Wireless Local Area Network Mini-PCI adapter. The Mini-PCI Type 3A form factor is designed for notebook computer systems where overall thickness must be kept to an absolute minimum and connect to antennas internal to the notebook computer. It is capable of a data rate of up to 11 Mbps.

NOTE 1: For a more detailed description, please refer to the manufacture’s specifications or User’s Manual.

NOTE 2: The EUT was tested with a set of antennas. (Refer to the antenna specifications exhibits).



4.1.1 Channel Number and Frequencies

802.11b Mode	
Channel	Frequency (MHz)
1	2412
2	2417
3	2422
4	2427
5	2432
6	2437
7	2442
8	2447
9	2452
10	2457
11	2462



AEGIS LABS INC.

4.2 EUT Configuration

The EUT was tested with an Intel PRO/Wireless 2100 Network Connection installed in its mini PCI slot and was connected to a set of Foxconn, & Hitachi triple band antennas via its main and auxiliary antenna ports. Data can be found in Appendix A.

For conducted emissions at the AC mains port and radiated emissions, the EUT was connected to a Dell monitor and Logitech mouse via its video and USB ports respectively.

The low, middle, and high channels were tested in 802.11b mode. Also, the EUT was tested once transmitting from the MAIN antenna port and once transmitting from the AUX antenna port. The EUT was placed in either continuous transmit or continuous receive mode by a program provided by the manufacturer (*CRTU Version 1.2.0.3000*).



AEGIS LABS INC.

4.3 List of EUT, Sub-Assemblies, and Host Equipment

LIST OF EUT AND SUB-ASSEMBLIES			
Equipment Name	Manufacturer	Model Number	Serial Number
Latitude D810 Notebook Computer	Dell Computer Corporation	PP15L	GVQKT41
EUT Sub-Assemblies			
Intel PRO/Wireless 2100 Network Connection	Intel Corporation	WM3A2100	CN-09Y200-48112-3BJ-DTQA
Auxiliary Triple Band Antenna	Hitachi	HFT17-DL01	N/A
Main Triple Band Antenna	Hitachi	HFT17-DL01	N/A
Auxiliary Triple Band Antenna	Foxconn	WDAN-DCDA Q001	N/A
Main Triple Band Antenna	Foxconn	WDAN-DCDA Q001	N/A

HOST EQUIPMENT LIST			
Equipment Name	Manufacturer	Model Number	Serial Number
LCD Monitor	Dell	E151FPp	CN-06R644-47804-34R-LATL
Mouse	Logitech	M-BJ58	LNA22802012

NOTE: All the power cords of the above support equipment are standard non-shielded, 1.8 meters long.

Page 9 of 16
Report Number: INTEL-040915F
FCC ID: E2K24CLNS



4.4 I/O Cabling Diagram and Description

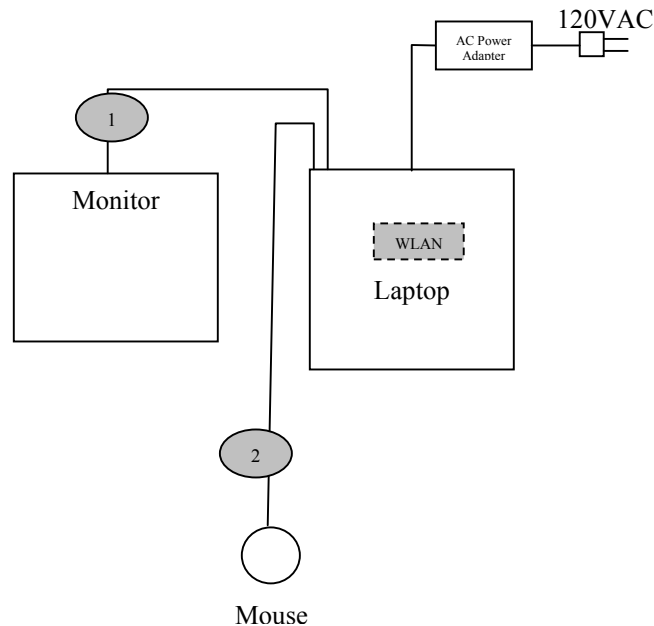

- Cable 1: This is a 6-foot braid and foil shielded round cable connecting the Latitude | D810 Notebook Computer with the Dell LCD monitor. It has metallic DB-15 type connector at the computer end and is hardwired to the monitor. The cable is bundled to a length of one meter and the shield of the cable is grounded to the chassis of both devices via the connector shells.
- Cable 2: This is a 6-foot braid and foil shielded round cable connecting the Latitude | D810 Notebook Computer to the Logitech mouse. It has a metallic USB-B type connector at the computer end and is hardwired to the mouse. The shield of the cable is grounded to the chassis of the computer via the connector shell.



AEGIS LABS INC.

5.0 TEST EQUIPMENT AND TEST SETUPS

The test equipment settings and functions are selected using the guidance of ANSI C63.4-1992. All test equipment setups and operations during conducted and radiated emissions testing are in accordance with this reference document.

5.1 AC Power Line Conducted Emissions

During conducted emissions measurements, a spectrum analyzer was used as the measuring instrument along with a preselector and quasi-peak detector. A 10 dB attenuation pad was used for the protection of the spectrum analyzer input stage. The conducted emissions from the EUT in the frequency range from 150 kHz to 30 MHz were captured for graphical display through the use of automated LABVIEW EMI measurement software. All graphical readings were measured in the “Peak” mode only to reduce testing time. Upon completion of the graphical scan, the test lab personnel performed the conducted measurement scan manually using the spectrum analyzer front panel keys. All peak measurements coming within 3 dB of the limit line were “Averaged” and/or “Quasi-Peaked” and denoted appropriately in the EXCEL spreadsheet.

The Equipment Under Test (EUT) was configured as a system with peripherals connected, so that at least one interface port of each type is connected to one external peripheral when tested for conducted emissions according to ANSI C63.4: 2001. Excess power cord length was wrapped in a bundle 30 to 40 centimeters in length near the center of the cord. The EUT was tested in a tabletop configuration.

The emission readings for Line 1 and Line 2 are highlighted on the data sheets in Appendix A. The graphical scans only reflect peak readings while the tabulated data sheets reflect peak, average, and/or quasi-peak readings which ever applies.



AEGIS LABS INC.

5.2 Spurious Radiated Emissions

A spectrum analyzer was used as the measuring instrumentation along with a preselector and quasi-peak-detector. The pre-amplifiers were used to increase the sensitivity of the instrument. The spectrum analyzer was used in the peak detector mode with the “max-hold” feature activated and in Positive Peak mode. In this mode, the spectrum analyzer records the highest measured reading over all the sweeps. The quasi-peak detector was used only for those readings, which are marked accordingly in the data sheet. The effective measurement bandwidth used for the radiated emissions test was 120 kHz for (30 MHz- 1000 MHz). The spectrum analyzer operated such that the modulation of the signal was filtered out to set the analyzer in linear mode. For testing beyond 1000 MHz a spectrum analyzer capable of taking reading above 1000 MHz was connected to the high frequency amplifier, where these measurement readings were taken with the transducer placed at a 3-meter test distance from the EUT.

The Open Area Test Sites (OATS) was used for radiated emission testing. These test sites are designed according to ANSI C63.4: 2001 and ANSI C63.7: 1992 guidelines. The Measurements were conducted in accordance with ANSI C63.4: 2001 and ANSI C63.7: 1992 requirements.

Broadband biconical, log periodic, and horn antennas were used as transducers during the measurement reading phase. The frequency spans were wide (30 MHz-88 MHz, 88 MHz- 216 MHz, 216 MHz- 300 MHz, and 300 MHz- 1000 MHz). After 1000 MHz the horn antenna was used to measure emissions. The emission readings in both horizontal and vertical polarities are highlighted on the data sheets in Appendix A.

5.3 Conducted Emissions at the Antenna Port

A spectrum analyzer or power meter was used as the measuring instrumentation along with an attenuator and/or filter connected to the EUT antenna port. The attenuator and filters are used to ensure that the front end of the measurement instrument is not overloaded by the fundamental transmission. . The instruments recorded the measured readings with the bandwidths (video and resolution) set in accordance with the FCC Rules and regulations.

For the power out measurements in 802.11b and 802.11g modes a peak power meter was used along with a peak power sensor with a wide enough bandwidth to capture the entire fundamental transmission

The measured readings are on the data sheets in Appendix A.

Page 12 of 16

Report Number: INTEL-040915F

FCC ID: E2K24CLNS



AEGIS LABS INC.

5.4 Test and Measurement Equipment Used

TEST EQUIPMENT USED					
Equipment Name	Manufacturer	Model Number	Serial Number	Calibration Due Date	Calibration Cycle
EMI Receiver - RF Section	Hewlett Packard	85462A	3325A00137	03/29/05	1 Year
EMI Receiver – RF Filter Section	Hewlett Packard	85460A	3330A00138	03/29/05	1 Year
Attenuator - 5W-10dB	Pasternack	PE7014-10	N/A	11/03/04	1 Year
LISN (EUT)	FCC	FCC-LISN-50-25-2	9931	02/06/05	1 Year
LISN (Access)	Com-Power	LI-200	12019	01/25/05	1 Year
LISN (Access)	Com-Power	LI-200	12018	01/25/05	1 Year
Spectrum Analyzer	Agilent	8564EC	4046A00387	02/06/06	2 Years
Preamplifier	Miteq	JS42-01001800-25-10P	815980 & 884968 & 885090	12/09/04	2 Years
2400-2483.5 MHz Notch Filter	Micro-Tronics	BRM50702-02	003	04/21/06	2 Years
5725-5850 MHz Notch Filter	Microwave Circuits, Inc.	N0257881	3173-01	06/27/05	2 Years
Antenna - Biconical	EMCO	3110	9108-1421	02/11/05	1 Year
Antenna - Log Periodic	EMCO	3148	4947	02/11/05	1 Year
1-18 GHz Antenna - Horn	Com-Power	AH-118	10069	12/09/04	2 Years
18-26.5 GHz Preamplified Antenna – Horn	Custom Microwave	H042	001	11/04/04	1 Year
26.5-40 GHz Preamplified Antenna – Horn	Custom Microwave	H028	GM1260-10	11/04/04	1 Year
Power Meter	Anritsu	ML2487A	6K00001785	04/05/05	2 Years
Wide Bandwidth Sensor	Anritsu	MA2491A	31193	04/05/05	2 Years

Page 13 of 16
 Report Number: INTEL-040915F
 FCC ID: E2K24CLNS



6.0 SAMPLE CALCULATIONS

If a preamplifier is used during the Radiated Emissions Testing, it is required that the amplifier gain be subtracted from the Spectrum Analyzer (Meter) Reading. In addition, a correction factor for the antenna, cable and a distance factor, if any, must be applied to the Meter Reading before a true field strength reading can be obtained. In the Automatic Mode of A.R.M.S. measurements, these considerations are automatically presented as a part of the printout. In the case of manual measurements and for greater efficiency and convenience, usage of the calibration correction factors in the Appendices is necessary to calculate the Corrected Meter Reading. These correlation factors for each meter reading, shall be modified to reflect these correlation factors at each frequency value so that the meter readings can be compared directly to the modified specification limit. This modified specification limit is referred to as the “Corrected Meter Reading Limit” (CML).

The equation shall be derived in the following manner:

$$\text{Corrected Meter Reading} = \text{Meter Reading} + F + C - G - D$$

Where, F = Antenna Factor

C = Cable Factor

G = Amplifier Gain

D = Distance Factor

Therefore, the equation for determining the Corrected Meter Reading Limit (CML) is:

$$\text{CML} = \text{Specification Limit} - F - C + G + D$$

For the manual mode of measurement, a table of corrected meter reading limits shall be used to permit immediate comparison of the meter reading to determine if the measured emission amplitude exceeded the specification limit at that specific frequency. There shall be two calculation sheets done, one for three meter and one for ten-meter measurement distances, where applicable. The correction factors for the antenna and the amplifier gain are attached in the Appendices.



AEGIS LABS INC.

6.0 Sample Calculations (Continued)

Peak Transmit Power Output:

A correction factor for the cable must be applied to the Conducted Power before a true power reading can be obtained. This is referred to as the “Corrected Power” (CP).

The equation shall be derived in the following manner:

$$\text{Corrected Power Reading} = \text{Conducted Power Reading} + C$$

Where, C = Cable Factor

The conducted power is taken in units of dBm. To obtain units of mW the following equation is used:

$$\text{mW} = 10^{(\text{dBm}/10)}$$



AEGIS LABS INC.

7.0 MODIFICATIONS AND RECOMMENDATIONS

No modifications were made to the EUT.

Page 16 of 16
Report Number: INTEL-040915F
FCC ID: E2K24CLNS



AEGIS LABS INC.

APPENDIX A

TEST DATA

Page 1 of 39 (Appendix A)
Report Number: INTEL-040915F
FCC ID: E2K24CLNS



AEGIS LABS INC.

AC POWER LINE CONDUCTED EMISSIONS TEST RESULTS

CLIENT:	Dell Computer Corporation	DATE:	10/22/04
EUT:	Latitude D810 Notebook Computer	PROJECT NUMBER:	INTEL-040908-14
MODEL NUMBER:	PP15L	TEST ENGINEER:	JC
SERIAL NUMBER:	GVQKT41	SITE #:	1
CONFIGURATION:	Tested with an Intel PRO/Wireless 2100 Network Connection installed in its mini PCI slot and connected to a set of Hitachi antennas.	TEMPERATURE:	20 C
		HUMIDITY:	33% RH
		TIME:	10:00 AM

Standard:	FCC CFR 47, Part 15.207
Description:	AC Power Line Conducted Emissions
Results:	Passes the conducted limits by -4.23@ 3.900 MHz

Conducted Limits		
Frequency (MHz)	Quasi-Peak Limit (dBuV)	Average Limit (dBuV)
0.15-0.5	66 to 56*	56 to 46*
0.5-5	56	46
5-30	60	50

*Decreases with the logarithm of the frequency.

NOTE: During preliminary scans, there wasn't any difference which channel or data rate was used with the EUT; therefore only Channel 1 at a data rate of 1 Mbps was used for final testing. Also, the scan was only done with the Hitachi set of antennas.

Page 2 of 39 (Appendix A)
Report Number: INTEL-040915F
FCC ID: E2K24CLNS



AC Power Line Conducted Emissions Test Results (Continued)

CONDUCTED EMISSIONS – LINE 1						
Freq. (MHz)	Meter Reading (dBuV)	Detector (PK/QP/AV)	Average Limit (dBuV)	Average Delta (dB)	Quasi-Peak Limit (dBuV)	Quasi-Peak Delta (dB)
0.1500	53.89	PK	58.39	-4.50	68.39	-14.50
0.1600	50.25	PK	58.31	-8.06	68.31	-18.06
0.1700	48.96	PK	58.23	-9.27	68.23	-19.27
0.1900	49.31	PK	58.07	-8.76	68.07	-18.76
0.4600	41.24	PK	55.92	-14.68	65.92	-24.68
2.3900	40.46	PK	46.00	-5.54	56.00	-15.54

09:37:14 OCT 22, 2004
 14:52:53 APR 14, 2003 11:58:46 SEP 23, 2004
 ACTV DET: PEAK
 MEAS DET: PEAK QP AVG
 MKR 150 kHz
 53.89 dBuV

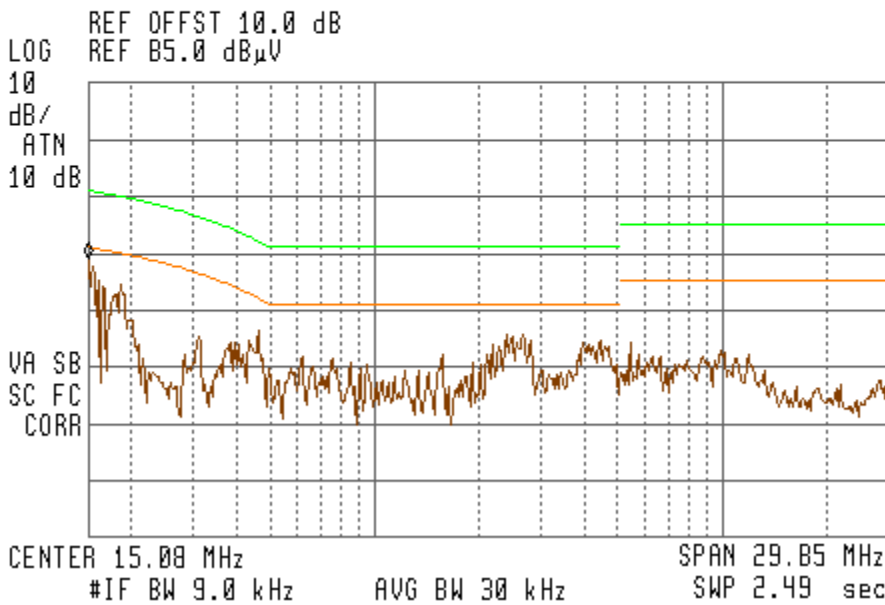

RBW = 100 kHz, VBW = 100 kHz



AC Power Line Conducted Emissions Test Results (Continued)

CONDUCTED EMISSIONS - LINE 2						
Freq. (MHz)	Meter Reading (dBuV)	Detector (PK/QP/AV)	Average Limit (dBuV)	Average Delta (dB)	Quasi-Peak Limit (dBuV)	Quasi-Peak Delta (dB)
0.1500	53.70	PK	58.39	-4.69	68.39	-14.69
0.1800	45.60	PK	58.15	-12.55	68.15	-22.55
0.2100	45.41	PK	57.91	-12.50	67.91	-22.50
2.1600	40.30	PK	46.00	-5.70	56.00	-15.70
3.4200	40.90	PK	46.00	-5.10	56.00	-15.10
3.9000	41.77	PK	46.00	-4.23	56.00	-14.23

09:43:13 OCT 22, 2004
 14:52:53 APR 14, 2003 11:58:46 SEP 23, 2004
 ACTV DET: PEAK
 MEAS DET: PEAK QP AVG
 MKR 150 kHz
 53.70 dBuV

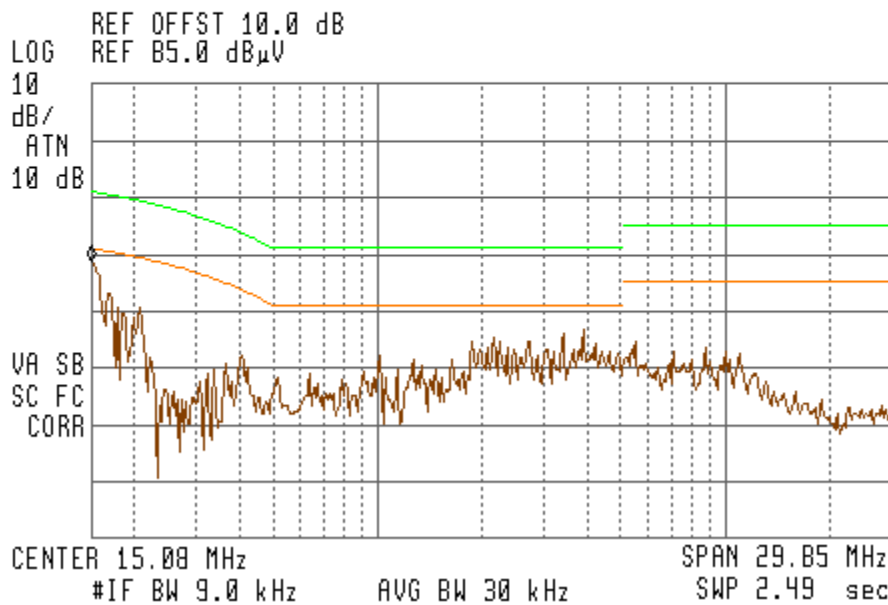

RBW = 100 kHz, VBW = 100 kHz



AEGIS LABS INC.

SPURIOUS RADIATED EMISSIONS TEST RESULTS

CLIENT:	Dell Computer Corporation	DATE:	10/25/04
EUT:	Latitude D810 Notebook Computer	PROJECT NUMBER:	INTEL-040908-15
MODEL NUMBER:	PP15L	TEST ENGINEER:	JC
SERIAL NUMBER:	GVQKT41	SITE #:	1
CONFIGURATION:	Tested with an Intel PRO/Wireless 2100 Network Connection installed in its mini PCI slot and connected to a set of Hitachi antennas.	TEMPERATURE:	13 C
		HUMIDITY:	81% RH
		TIME:	8:30 AM

Standard:	FCC Pt. 15.209
Description:	Unwanted emissions below 1 GHz must comply with the general field strength limits set forth in Sec. 15.209.
Results:	Passes the radiated limits by $-3.02@ 464.00\text{MHz}$ (Horizontal antenna polarization)

Radiated Limits	
Frequency (MHz)	Quasi-Peak Limit (dBuV) @ 10m
30-88	40
88-216	43.5
216-960	46
960-1000	54

NOTE 1: During preliminary scans, there wasn't any difference which channel or data rate was used with the EUT; therefore only Channel 1 at a data rate of 1 Mbps was used for final testing. Also, the scan was only done with the Hitachi set of antennas.

NOTE 2: RBW/VBW = 1 MHz

Page 5 of 39 (Appendix A)
Report Number: INTEL-040915F
FCC ID: E2K24CLNS



Spurious Radiated Emissions Test Results (Continued)

RADIATED EMISSIONS - Horizontal Antenna Polarization

Freq. (MHz)	Meter Reading (dBuV)	Antenna Height (cm)	Azimuth (degrees)	Peak, Quasi pk or AVG (dBuV)	Preamp Factor (dB)	Cable Factor (dB)	Ant. Factor (dB)	10 Meter Distance Factor (dB)	Corrected Reading (dBuV)	Limits (dBuV)	Diff (dB) +=FAIL
79.19	5.23	400	0		0.00	1.39	9.32	10.46	26.41	40.00	-13.59
83.96	6.87	400	45		0.00	1.44	9.38	10.46	28.15	40.00	-11.85
137.66	10.59	400	45		0.00	1.90	11.85	10.46	34.80	43.50	-8.70
147.07	8.74	400	45		0.00	1.90	12.18	10.46	33.28	43.50	-10.22
159.97	9.21	400	90		0.00	2.00	12.80	10.46	34.47	43.50	-9.03
243.93	7.30	400	135		0.00	2.73	17.11	10.46	37.59	46.00	-8.41
263.97	5.49	350	270		0.00	2.80	18.42	10.46	37.17	46.00	-8.83
281.98	4.78	300	45		0.00	2.83	19.55	10.46	37.62	46.00	-8.38
305.95	5.10	250	135		0.00	2.94	16.24	10.46	34.73	46.00	-11.27
335.98	8.13	250	45		0.00	3.12	17.09	10.46	38.79	46.00	-7.21
347.66	6.26	300	45		0.00	3.19	17.18	10.46	37.09	46.00	-8.91
375.03	6.73	250	0		0.00	3.35	17.65	10.46	38.19	46.00	-7.81
399.99	8.65	250	180		0.00	3.50	17.20	10.46	39.81	46.00	-6.19
464.00	10.12	200	45		0.00	3.78	18.62	10.46	42.98	46.00	-3.02
500.29	7.20	200	315		0.00	4.00	20.30	10.46	41.96	46.00	-4.04

RADIATED EMISSIONS - Vertical Antenna Polarization

Freq. (MHz)	Meter Reading (dBuV)	Antenna Height (cm)	Azimuth (degrees)	Peak, Quasi pk or AVG (dBuV)	Preamp Factor (dB)	Cable Factor (dB)	Ant. Factor (dB)	10 Meter Distance Factor (dB)	Corrected Reading (dBuV)	Limits (dBuV)	Diff (dB) +=FAIL
33.29	11.79	100	135		0.00	0.87	12.84	10.46	35.96	40.00	-4.04
80.00	10.46	100	90		0.00	1.40	9.60	10.46	31.92	40.00	-8.08
138.85	8.52	100	225		0.00	1.90	10.73	10.46	31.61	43.50	-11.89
162.53	11.13	100	45		0.00	2.02	12.95	10.46	36.56	43.50	-6.94
244.07	6.99	100	90		0.00	2.73	18.15	10.46	38.33	46.00	-7.67
281.99	8.24	100	45		0.00	2.83	20.30	10.46	41.83	46.00	-4.17
300.01	8.36	100	135		0.00	2.90	16.40	10.46	38.12	46.00	-7.88
319.97	9.81	100	90		0.00	3.02	16.88	10.46	40.17	46.00	-5.83
335.98	11.27	100	45		0.00	3.12	17.09	10.46	41.93	46.00	-4.07
375.01	5.94	100	45		0.00	3.35	17.60	10.46	37.35	46.00	-8.65
383.99	7.71	100	135		0.00	3.40	17.67	10.46	39.25	46.00	-6.75
399.98	9.05	100	180		0.00	3.50	17.80	10.46	40.81	46.00	-5.19
406.54	8.95	100	135		0.00	3.53	17.73	10.46	40.67	46.00	-5.33
432.00	8.69	100	135		0.00	3.63	17.84	10.46	40.62	46.00	-5.38
500.40	7.34	100	180		0.00	4.00	19.61	10.46	41.42	46.00	-4.58
572.35	8.03	100	135		0.00	4.19	20.27	10.46	42.95	46.00	-3.05

NOTE: The measurements were taken at 10 meters and extrapolated to 3 meters.

NOTE 2: The measurements are Peak readings unless otherwise specified.



AEGIS LABS INC.

Spurious Radiated Emissions Test Results (Continued)

CLIENT:	Dell Computer Corporation	DATE:	09/15/04
EUT:	Latitude D810 Notebook Computer	PROJECT NUMBER:	INTEL-040915
MODEL NUMBER:	PP15L	TEST ENGINEER:	JC
SERIAL NUMBER:	GVQKT41	SITE #:	2
CONFIGURATION:	Tested with an Intel PRO/Wireless 2100 Network Connection installed in its mini PCI slot and connected to a set of Foxconn antennas in 802.11b (2412-2462 MHz) mode.	TEMPERATURE:	28 C
		HUMIDITY:	42% RH
		TIME:	2:30 PM

Standard:	FCC CFR 47, Part 15.247(c)
Description:	Radiated emissions, which fall in the restricted bands, as defined in Sec. 15.205(a), must also comply with the radiated emission limits specified in Sec. 15.209(a). All others must be < -20dBc.
Results:	Passes (See Data Sheets)

Unwanted Spurious Emissions Limits			
Frequency (MHz)	Field Strength (uV/m)	Field Strength (dBuV/m) (Emissions in the restricted bands)	Field Strength (dBm/MHz) (Emissions outside the restricted bands)
Above 960	500	54.00 (Average) 74.00 (Peak)	< -20 dBc

Page 7 of 39 (Appendix A)
Report Number: INTEL-040915F
FCC ID: E2K24CLNS



Spurious Radiated Emissions Test Results (Continued)

*Fundamental Measurements in 802.11b mode (2412-2462 MHz)
 Channels 1, 6, & 11
 Continuous TX at MAIN Antenna port with Foxconn Antennas
 Aegis Labs, Inc. File #: INTEL-040915-04*

RADIATED EMISSIONS - Horizontal Antenna Polarization											
<i>Freq. (MHz)</i>	<i>Meter Reading (dBuV)</i>	<i>Antenna Height (cm)</i>	<i>Azimuth (degrees)</i>	<i>Quasi pk or AVG (dBuV)</i>		<i>Preamp Factor (dB)</i>	<i>Cable Factor (dB)</i>	<i>Ant. Factor (dB)</i>	<i>Corrected Reading (dBuV)</i>	<i>Limits (dBuV)</i>	<i>Diff (dB) +=FAIL</i>
2412.00	70.17	100	315				3.30	31.11	104.58		
2412.00				66.49	A		3.30	31.11	100.90		
2437.00	69.83	100	315				3.32	31.05	104.20		
2437.00				66.30	A		3.32	31.05	100.67		
2462.00	69.33	100	315				3.34	30.99	103.66		
2462.00				65.84	A		3.34	30.99	100.17		

RADIATED EMISSIONS – Vertical Antenna Polarization											
<i>Freq. (MHz)</i>	<i>Meter Reading (dBuV)</i>	<i>Antenna Height (cm)</i>	<i>Azimuth (degrees)</i>	<i>Quasi pk or AVG (dBuV)</i>		<i>Preamp Factor (dB)</i>	<i>Cable Factor (dB)</i>	<i>Ant. Factor (dB)</i>	<i>Corrected Reading (dBuV)</i>	<i>Limits (dBuV)</i>	<i>Diff (dB) +=FAIL</i>
2412.00	68.83	100	45				3.30	31.24	103.37		
2412.00				65.19	A		3.30	31.24	99.73		
2437.00	68.00	100	45				3.32	31.20	102.52		
2437.00				64.62	A		3.32	31.20	99.14		
2462.00	66.83	100	45				3.34	31.16	101.33		
2462.00				63.59	A		3.34	31.16	98.09		

NOTE: Fundamental signals measured to calculate the band edge field strengths using the “Marker Delta Method”.



Spurious Radiated Emissions Test Results (Continued)

Band Edge Field Strength Measurements in 802.11b mode (2412-2462 MHz)
Channels 1, 6, & 11
Continuous TX at MAIN Antenna port with Foxconn Antennas
Aegis Labs, Inc. File #: INTEL-040915-04

RADIATED EMISSIONS - Horizontal Antenna Polarization										
Freq. (MHz)	Meter Reading (dBuV)	Antenna Height (cm)	Azimuth (degrees)	Quasi pk or AVG (dBuV)	Preamp Factor (dB)	Cable Factor (dB)	Ant. Factor (dB)	Corrected Reading (dBuV)	Limits (dBuV)	Diff (dB) +=FAIL
2390.00								49.58	74.00	-24.42
2390.00								41.40	54.00	-12.60
2388.00								49.91	74.00	-24.09
2388.00								41.73	54.00	-12.27
2400.00	31.83	100	315			3.29	31.14	66.26	84.58	-18.32
2483.50								48.99	74.00	-25.01
2483.50								40.50	54.00	-13.50
2487.00								49.49	74.00	-24.51
2487.00								41.50	54.00	-12.50

RADIATED EMISSIONS – Vertical Antenna Polarization										
Freq. (MHz)	Meter Reading (dBuV)	Antenna Height (cm)	Azimuth (degrees)	Quasi pk or AVG (dBuV)	Preamp Factor (dB)	Cable Factor (dB)	Ant. Factor (dB)	Corrected Reading (dBuV)	Limits (dBuV)	Diff (dB) +=FAIL
2390.00								48.37	74.00	-25.63
2390.00								40.23	54.00	-13.77
2388.00								48.70	74.00	-25.30
2388.00								40.56	54.00	-13.44
2400.00	30.83	100	45			3.29	31.26	65.38	83.37	-17.99
2483.50								46.66	74.00	-27.34
2483.50								38.42	54.00	-15.58
2487.00								47.16	74.00	-26.84
2487.00								39.42	54.00	-14.58

NOTE: The “Band Edge Field Strength” was calculated using the “Fundamental” and “Conducted Band Edge” measurements per the “Marker-Delta Method” with the following formula:

BE = Fm – Δm

Where

BE = Band Edge Field Strength

Fm = Measured Fundamental (Peak or Average)

Δm = Measured Conducted Band Edge Delta (Peak or Average)



AEGIS LABS INC.

Spurious Radiated Emissions Test Results (Continued)

Plots Showing Out-Of-Band Emissions (Peak RBW=VBW=1MHz; Average RBW = 1MHz, VBW = 10Hz)

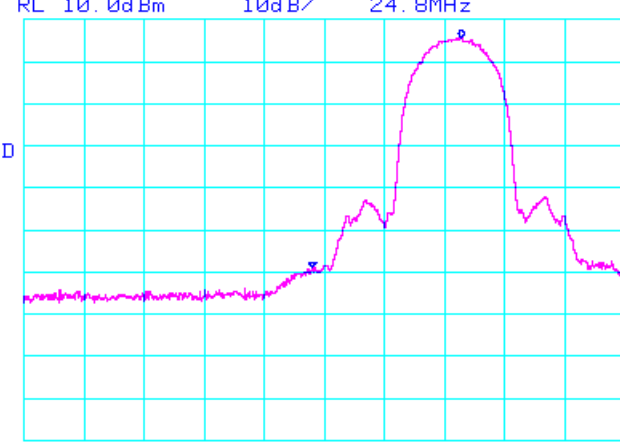
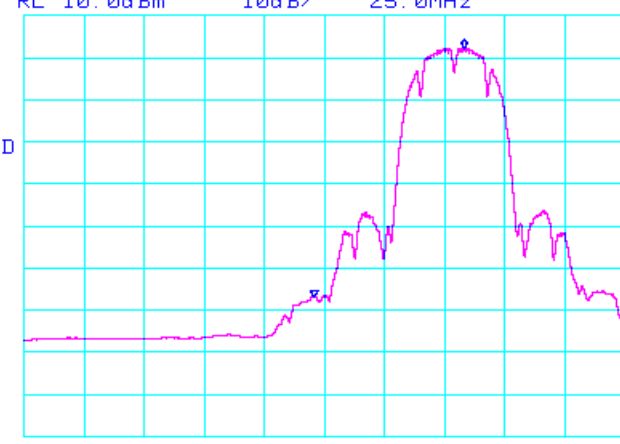

Test Date	Data	Test Eng.
09/15/04	2.412 GHz band edge PEAK DELTA (INTEL-040915-02a01)	JC
<p>*ATTEN 20dB RL 10.0dBm 10dB/ ΔMKR 54.67dB 24.8MHz</p>  <p>CENTER 2.3900GHz SPAN 100.0MHz *RBW 1.0MHz *VBW 1.0MHz SWP 50.0ms</p>		
Test Date	Data	Test Eng.
09/15/04	2.412 GHz band edge AVERAGE DELTA (INTEL-040915-02a02)	JC
<p>*ATTEN 20dB RL 10.0dBm 10dB/ ΔMKR 59.16dB 25.0MHz</p>  <p>CENTER 2.3900GHz SPAN 100.0MHz *RBW 1.0MHz *VBW 10Hz SWP 37.0sec</p>		

Page 10 of 39 (Appendix A)
Report Number: INTEL-040915F
FCC ID: E2K24CLNS

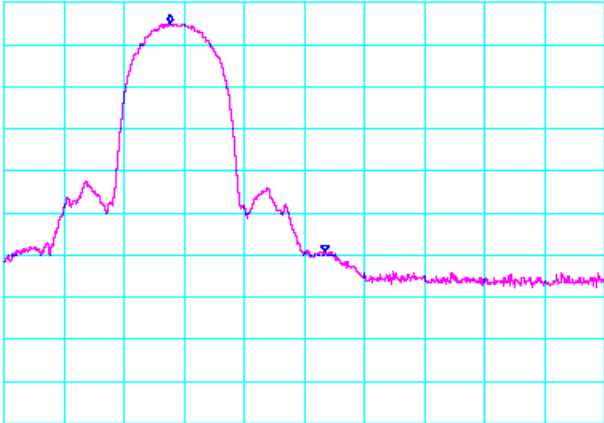

Spurious Radiated Emissions Test Results (Continued)

Plots Showing Out-Of-Band Emissions (Peak RBW=VBW=1MHz; Average RBW = 1MHz, VBW = 10Hz)

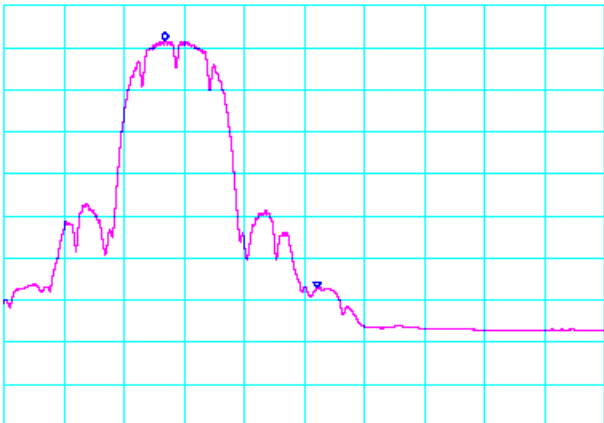
Test Date	Data	Test Eng.
09/15/04	2.462 GHz band edge PEAK DELTA (INTEL-040915-02a03)	JC
<div style="display: flex; justify-content: space-between;"> <div data-bbox="321 451 487 499"> <p>*ATTEN 20dB RL 10.0dBm</p> </div> <div data-bbox="560 472 641 499"> <p>10dB/</p> </div> <div data-bbox="690 451 868 499"> <p>ΔMKR 54.17dB -25.8MHz</p> </div> <div data-bbox="1291 462 1364 535" style="text-align: right;">  </div> </div> <div style="text-align: center; margin: 10px 0;">  </div> <div style="display: flex; justify-content: space-between;"> <div data-bbox="321 928 576 976"> <p>CENTER 2.4835GHz *RBW 1.0MHz</p> </div> <div data-bbox="738 928 933 976"> <p>SPAN 100.0MHz SWP 50.0ms</p> </div> </div>		
Test Date	Data	Test Eng.
09/15/04	2.462 GHz band edge AVERAGE DELTA (INTEL-040915-02a04)	JC
<div style="display: flex; justify-content: space-between;"> <div data-bbox="321 1096 487 1144"> <p>*ATTEN 20dB RL 10.0dBm</p> </div> <div data-bbox="560 1117 641 1144"> <p>10dB/</p> </div> <div data-bbox="690 1096 868 1144"> <p>ΔMKR 58.67dB -25.3MHz</p> </div> <div data-bbox="1291 1106 1364 1180" style="text-align: right;">  </div> </div> <div style="text-align: center; margin: 10px 0;">  </div> <div style="display: flex; justify-content: space-between;"> <div data-bbox="321 1575 576 1623"> <p>CENTER 2.4835GHz *RBW 1.0MHz</p> </div> <div data-bbox="738 1575 933 1623"> <p>SPAN 100.0MHz SWP 37.0sec</p> </div> </div>		



Spurious Radiated Emissions Test Results (Continued)

*Spurious Emissions Measurements in 802.11b mode (2412-2462 MHz)
Channels 1, 6, & 11
Continuous TX at MAIN Antenna port with Foxconn Antennas
Aegis Labs, Inc. File #: INTEL-040915-05*

RADIATED EMISSIONS - Horizontal Antenna Polarization											
<i>Freq. (MHz)</i>	<i>Meter Reading (dBuV)</i>	<i>Antenna Height (cm)</i>	<i>Azimuth (degrees)</i>	<i>Quasi pk or AVG (dBuV)</i>		<i>Preamp Factor (dB)</i>	<i>Cable Factor (dB)</i>	<i>Ant. Factor (dB)</i>	<i>Corrected Reading (dBuV)</i>	<i>Limits (dBuV)</i>	<i>Diff (dB) +=FAIL</i>
EUT in Continuous Transmit Mode on Channel 1 (2.412 GHz)											
4824.00	49.50	100	225			43.27	4.73	34.53	45.49	74.00	-28.51
4824.00				38.36	A	43.27	4.73	34.53	34.35	54.00	-19.65
9648.01	50.33	100	135			43.22	6.95	38.88	52.94	84.58	-31.64
EUT in Continuous Transmit Mode on Channel 6 (2.437 GHz)											
4873.99	48.67	100	225			43.29	4.77	34.72	44.87	74.00	-29.13
4873.99				36.78	A	43.29	4.77	34.72	32.98	54.00	-21.02
9747.96	50.50	100	135			43.25	6.99	39.00	53.23	84.20	-30.97
EUT in Continuous Transmit Mode on Channel 11 (2.462 GHz)											
4924.00	50.33	100	180			43.30	4.81	34.91	46.74	74.00	-27.26
4924.00				39.93	A	43.30	4.81	34.91	36.34	54.00	-17.66
9848.01	50.83	100	135			43.29	7.03	39.12	53.69	83.66	-29.97



Spurious Radiated Emissions Test Results (Continued)

RADIATED EMISSIONS - Vertical Antenna Polarization											
<i>Freq. (MHz)</i>	<i>Meter Reading (dBuV)</i>	<i>Antenna Height (cm)</i>	<i>Azimuth (degrees)</i>	<i>Quasi pk or AVG (dBuV)</i>		<i>Preamp Factor (dB)</i>	<i>Cable Factor (dB)</i>	<i>Ant. Factor (dB)</i>	<i>Corrected Reading (dBuV)</i>	<i>Limits (dBuV)</i>	<i>Diff (dB) +=FAIL</i>
EUT in Continuous Transmit Mode on Channel 1 (2.412 GHz)											
4823.96	49.67	100	135			43.27	4.73	34.53	45.66	74.00	-28.34
4823.96				38.73	A	43.27	4.73	34.53	34.72	54.00	-19.28
9647.97	50.67	100	135			43.22	6.95	38.97	53.37	83.37	-30.00
EUT in Continuous Transmit Mode on Channel 6 (2.437 GHz)											
4874.01	48.83	100	135			43.29	4.77	34.72	45.03	74.00	-28.97
4874.01				36.97	A	43.29	4.77	34.72	33.17	54.00	-20.83
9748.04	50.00	100	135			43.25	6.99	39.15	52.88	82.52	-29.64
EUT in Continuous Transmit Mode on Channel 11 (2.462 GHz)											
4924.00	49.83	100	135			43.30	4.81	34.91	46.24	74.00	-27.76
4924.00				38.91	A	43.30	4.81	34.91	35.32	54.00	-18.68
9847.96	50.17	100	135			43.29	7.03	39.33	53.24	81.33	-28.09



Spurious Radiated Emissions Test Results (Continued)

*Spurious Emissions Measurements in 802.11b mode (2412-2462 MHz)
 Channels 1, 6, & 11
 Continuous RX at MAIN Antenna port with Foxconn Antennas
 Aegis Labs, Inc. File #: INTEL-040915-05*

RADIATED EMISSIONS - Horizontal Antenna Polarization											
<i>Freq. (MHz)</i>	<i>Meter Reading (dBuV)</i>	<i>Antenna Height (cm)</i>	<i>Azimuth (degrees)</i>	<i>Quasi pk or AVG (dBuV)</i>		<i>Preamp Factor (dB)</i>	<i>Cable Factor (dB)</i>	<i>Ant. Factor (dB)</i>	<i>Corrected Reading (dBuV)</i>	<i>Limits (dBuV)</i>	<i>Diff (dB) +=FAIL</i>
EUT in Continuous Receive Mode on Channel 1 (2.412 GHz)											
1608.01	49.33	100	225			42.54	2.71	29.36	38.86	80.00	-41.14
1608.01				37.15	A	42.54	2.71	29.36	26.68	60.00	-33.32
9648.00	50.50	100	135			43.22	6.95	38.88	53.11	80.00	-26.89
9648.00				38.79	A	43.22	6.95	38.88	41.40	60.00	-18.60
EUT in Continuous Receive Mode on Channel 6 (2.437 GHz)											
1624.66	49.67	100	225			42.54	2.72	29.47	39.33	80.00	-40.67
1624.66				37.43	A	42.54	2.72	29.47	27.09	60.00	-32.91
9747.98	50.33	100	135			43.25	6.99	39.00	53.06	80.00	-26.94
9747.98				38.58	A	43.25	6.99	39.00	41.31	60.00	-18.69
EUT in Continuous Receive Mode on Channel 11 (2.462 GHz)											
1641.35	49.50	100	225			42.55	2.74	29.59	39.28	80.00	-40.72
1641.35				37.19	A	42.55	2.74	29.59	26.97	60.00	-33.03
9848.01	50.00	100	135			43.29	7.03	39.12	52.86	80.00	-27.14
9848.01				38.06	A	43.29	7.03	39.12	40.92	60.00	-19.08



Spurious Radiated Emissions Test Results (Continued)

RADIATED EMISSIONS - Vertical Antenna Polarization											
<i>Freq. (MHz)</i>	<i>Meter Reading (dBuV)</i>	<i>Antenna Height (cm)</i>	<i>Azimuth (degrees)</i>	<i>Quasi pk or AVG (dBuV)</i>		<i>Preamp Factor (dB)</i>	<i>Cable Factor (dB)</i>	<i>Ant. Factor (dB)</i>	<i>Corrected Reading (dBuV)</i>	<i>Limits (dBuV)</i>	<i>Diff (dB) +=FAIL</i>
EUT in Continuous Receive Mode on Channel 1 (2.412 GHz)											
1608.00	49.83	100	135			42.54	2.71	29.39	39.40	80.00	-40.60
1608.00				37.10	A	42.54	2.71	29.39	26.67	60.00	-33.33
9648.02	50.67	100	135			43.22	6.95	38.97	53.37	80.00	-26.63
9648.02				38.83	A	43.22	6.95	38.97	41.53	60.00	-18.47
EUT in Continuous Receive Mode on Channel 6 (2.437 GHz)											
1624.68	49.83	100	135			42.54	2.72	29.50	39.51	80.00	-40.49
1624.68				37.36	A	42.54	2.72	29.50	27.04	60.00	-32.96
9748.00	50.50	100	135			43.25	6.99	39.15	53.38	80.00	-26.62
9748.00				38.50	A	43.25	6.99	39.15	41.38	60.00	-18.62
EUT in Continuous Receive Mode on Channel 11 (2.462 GHz)											
1641.32	50.17	100	135			42.55	2.74	29.60	39.96	80.00	-40.04
1641.32				37.79	A	42.55	2.74	29.60	27.58	60.00	-32.42
9847.98	50.33	100	135			43.29	7.03	39.33	53.40	80.00	-26.60
9847.98				38.26	A	43.29	7.03	39.33	41.33	60.00	-18.67



AEGIS LABS INC.

Spurious Radiated Emissions Test Results (Continued)

CLIENT:	Dell Computer Corporation	DATE:	09/16/04
EUT:	Latitude D810 Notebook Computer	PROJECT NUMBER:	INTEL-040915
MODEL NUMBER:	PP15L	TEST ENGINEER:	JC
SERIAL NUMBER:	GVQKT41	SITE #:	2
CONFIGURATION:	Tested with an Intel PRO/Wireless 2100 Network Connection installed in its mini PCI slot and connected to a set of Hitachi antennas in 802.11b (2412-2462 MHz) mode.	TEMPERATURE:	29 C
		HUMIDITY:	45% RH
		TIME:	1:20 PM

Standard:	FCC CFR 47, Part 15.247(c)
Description:	Radiated emissions, which fall in the restricted bands, as defined in Sec. 15.205(a), must also comply with the radiated emission limits specified in Sec. 15.209(a). All others must be < -20dBc.
Results:	Passes (See Data Sheets)

Unwanted Spurious Emissions Limits			
Frequency (MHz)	Field Strength (uV/m)	Field Strength (dBuV/m) (Emissions in the restricted bands)	Field Strength (dBm/MHz) (Emissions outside the restricted bands)
Above 960	500	54.00 (Average) 74.00 (Peak)	< -20 dBc

Page 16 of 39 (Appendix A)
Report Number: INTEL-040915F
FCC ID: E2K24CLNS



Spurious Radiated Emissions Test Results (Continued)

*Fundamental Measurements in 802.11b mode (2412-2462 MHz)
Channels 1, 6, & 11
Continuous TX at MAIN Antenna port with Hitachi Antennas
Aegis Labs, Inc. File #: INTEL-040915-06*

RADIATED EMISSIONS - Horizontal Antenna Polarization											
<i>Freq. (MHz)</i>	<i>Meter Reading (dBuV)</i>	<i>Antenna Height (cm)</i>	<i>Azimuth (degrees)</i>	<i>Quasi pk or AVG (dBuV)</i>		<i>Preamp Factor (dB)</i>	<i>Cable Factor (dB)</i>	<i>Ant. Factor (dB)</i>	<i>Corrected Reading (dBuV)</i>	<i>Limits (dBuV)</i>	<i>Diff (dB) +=FAIL</i>
2412.00	69.33	100	45				3.30	31.11	103.74		
2412.00				65.62	A		3.30	31.11	100.03		
2437.00	70.00	100	45				3.32	31.05	104.37		
2437.00				66.49	A		3.32	31.05	100.86		
2462.00	69.17	100	45				3.34	30.99	103.50		
2462.00				65.73	A		3.34	30.99	100.06		

RADIATED EMISSIONS – Vertical Antenna Polarization											
<i>Freq. (MHz)</i>	<i>Meter Reading (dBuV)</i>	<i>Antenna Height (cm)</i>	<i>Azimuth (degrees)</i>	<i>Quasi pk or AVG (dBuV)</i>		<i>Preamp Factor (dB)</i>	<i>Cable Factor (dB)</i>	<i>Ant. Factor (dB)</i>	<i>Corrected Reading (dBuV)</i>	<i>Limits (dBuV)</i>	<i>Diff (dB) +=FAIL</i>
2412.00	68.00	100	135				3.30	31.24	102.54		
2412.00				64.20	A		3.30	31.24	98.74		
2437.00	68.33	100	135				3.32	31.20	102.85		
2437.00				64.96	A		3.32	31.20	99.48		
2462.00	67.00	100	135				3.34	31.16	101.50		
2462.00				63.33	A		3.34	31.16	97.83		

NOTE: Fundamental signals measured to calculate the band edge field strengths using the “Marker Delta Method”.



Spurious Radiated Emissions Test Results (Continued)

Band Edge Field Strength Measurements in 802.11b mode (2412-2462 MHz)
Channels 1, 6, & 11
Continuous TX at MAIN Antenna port with Hitachi Antennas
Aegis Labs, Inc. File #: INTEL-040915-06

RADIATED EMISSIONS - Horizontal Antenna Polarization										
Freq. (MHz)	Meter Reading (dBuV)	Antenna Height (cm)	Azimuth (degrees)	Quasi pk or AVG (dBuV)	Preamp Factor (dB)	Cable Factor (dB)	Ant. Factor (dB)	Corrected Reading (dBuV)	Limits (dBuV)	Diff (dB) +=FAIL
2390.00								48.74	74.00	-25.26
2390.00								40.53	54.00	-13.47
2388.00								49.07	74.00	-24.93
2388.00								40.86	54.00	-13.14
2400.00	32.50	100	45			3.29	31.14	66.93	83.74	-16.81
2483.50								48.83	74.00	-25.17
2483.50								40.39	54.00	-13.61
2487.00								49.33	74.00	-24.67
2487.00								41.39	54.00	-12.61
RADIATED EMISSIONS - Vertical Antenna Polarization										
Freq. (MHz)	Meter Reading (dBuV)	Antenna Height (cm)	Azimuth (degrees)	Quasi pk or AVG (dBuV)	Preamp Factor (dB)	Cable Factor (dB)	Ant. Factor (dB)	Corrected Reading (dBuV)	Limits (dBuV)	Diff (dB) +=FAIL
2390.00								47.54	74.00	-26.46
2390.00								39.24	54.00	-14.76
2388.00								47.87	74.00	-26.13
2388.00								39.57	54.00	-14.43
2400.00	31.83	100	135			3.29	31.26	66.38	82.54	-16.16
2483.50								46.83	74.00	-27.17
2483.50								38.16	54.00	-15.84
2487.00								47.33	74.00	-26.67
2487.00								39.16	54.00	-14.84

NOTE: The "Band Edge Field Strength" was calculated using the "Fundamental" and "Conducted Band Edge" measurements per the "Marker-Delta Method" with the following formula:

BE = Fm - Δm

Where

BE = Band Edge Field Strength

Fm = Measured Fundamental (Peak or Average)

Δm = Measured Conducted Band Edge Delta (Peak or Average)



Spurious Radiated Emissions Test Results (Continued)

Plots Showing Out-Of-Band Emissions (Peak RBW=VBW=1MHz; Average RBW = 1MHz, VBW = 10Hz)

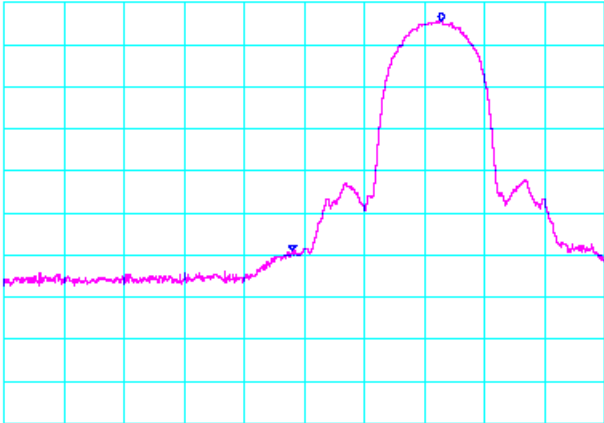
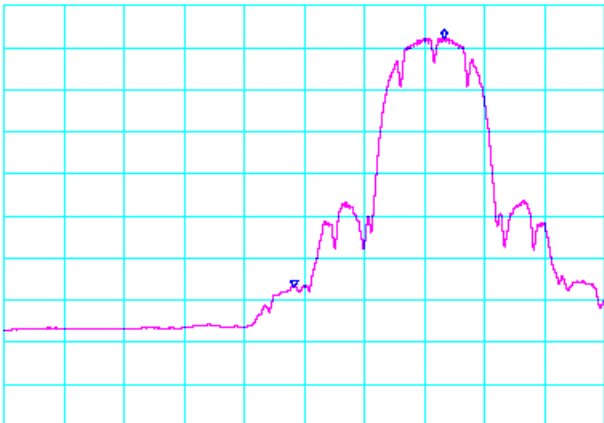
Test Date	Data	Test Eng.
09/15/04	2.412 GHz band edge PEAK DELTA (INTEL-040915-02a01)	JC
<div style="display: flex; justify-content: space-between;"> <div data-bbox="321 451 487 499"> <p>*ATTEN 20dB RL 10.0dBm</p> </div> <div data-bbox="560 472 641 499"> <p>10dB/</p> </div> <div data-bbox="690 451 868 499"> <p>ΔMKR 54.67dB 24.8MHz</p> </div> <div data-bbox="1291 462 1364 535" data-label="Image"></div> </div>  <div style="display: flex; justify-content: space-between; margin-top: 10px;"> <div data-bbox="321 928 576 976"> <p>CENTER 2.3900GHz *RBW 1.0MHz</p> </div> <div data-bbox="738 928 933 976"> <p>SPAN 100.0MHz SWP 50.0ms</p> </div> </div>		
Test Date	Data	Test Eng.
09/15/04	2.412 GHz band edge AVERAGE DELTA (INTEL-040915-02a02)	JC
<div style="display: flex; justify-content: space-between;"> <div data-bbox="321 1096 487 1144"> <p>*ATTEN 20dB RL 10.0dBm</p> </div> <div data-bbox="560 1117 641 1144"> <p>10dB/</p> </div> <div data-bbox="690 1096 868 1144"> <p>ΔMKR 59.16dB 25.0MHz</p> </div> <div data-bbox="1291 1106 1364 1180" data-label="Image"></div> </div>  <div style="display: flex; justify-content: space-between; margin-top: 10px;"> <div data-bbox="321 1572 576 1621"> <p>CENTER 2.3900GHz *RBW 1.0MHz</p> </div> <div data-bbox="738 1572 933 1621"> <p>SPAN 100.0MHz SWP 37.0sec</p> </div> </div>		



AEGIS LABS INC.

Spurious Radiated Emissions Test Results (Continued)

Plots Showing Out-Of-Band Emissions (Peak RBW=VBW=1MHz; Average RBW = 1MHz, VBW = 10Hz)

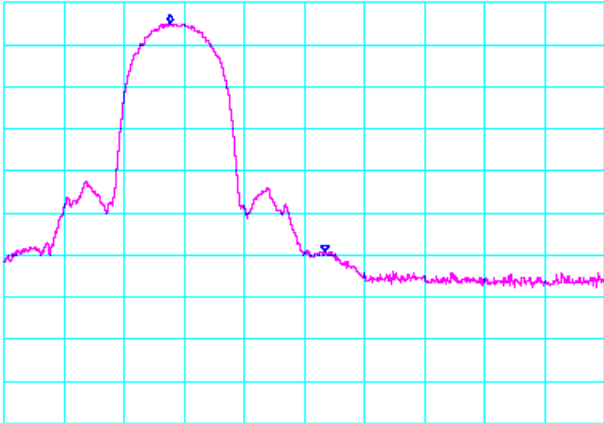
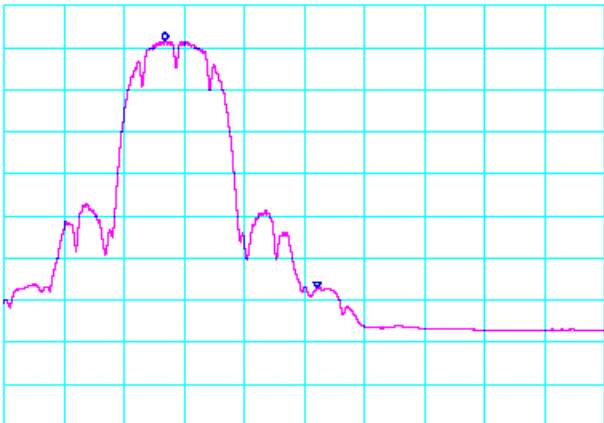
Test Date	Data	Test Eng.
09/15/04	2.462 GHz band edge PEAK DELTA (INTEL-040915-02a03)	JC
<div style="display: flex; justify-content: space-between;"> <div data-bbox="321 451 487 499"> <p>*ATTEN 20dB RL 10.0dBm</p> </div> <div data-bbox="560 472 641 499"> <p>10dB/</p> </div> <div data-bbox="690 451 868 499"> <p>ΔMKR 54.17dB -25.8MHz</p> </div> <div data-bbox="1291 462 1364 535" data-label="Image"></div> </div>  <div style="display: flex; justify-content: space-between; margin-top: 10px;"> <div data-bbox="321 928 690 976"> <p>CENTER 2.4835GHz *RBW 1.0MHz *VBW 1.0MHz</p> </div> <div data-bbox="738 928 933 976"> <p>SPAN 100.0MHz SWP 50.0ms</p> </div> </div>		
Test Date	Data	Test Eng.
09/15/04	2.462 GHz band edge AVERAGE DELTA (INTEL-040915-02a04)	JC
<div style="display: flex; justify-content: space-between;"> <div data-bbox="321 1096 487 1144"> <p>*ATTEN 20dB RL 10.0dBm</p> </div> <div data-bbox="560 1117 641 1144"> <p>10dB/</p> </div> <div data-bbox="690 1096 868 1144"> <p>ΔMKR 58.67dB -25.3MHz</p> </div> <div data-bbox="1291 1106 1364 1180" data-label="Image"></div> </div>  <div style="display: flex; justify-content: space-between; margin-top: 10px;"> <div data-bbox="321 1572 665 1621"> <p>CENTER 2.4835GHz *RBW 1.0MHz *VBW 10Hz</p> </div> <div data-bbox="738 1572 933 1621"> <p>SPAN 100.0MHz SWP 37.0sec</p> </div> </div>		

Page 20 of 39 (Appendix A)
Report Number: INTEL-040915F
FCC ID: E2K24CLNS



Spurious Radiated Emissions Test Results (Continued)

*Spurious Emissions Measurements in 802.11b mode (2412-2462 MHz)
Channels 1, 6, & 11
Continuous TX at MAIN Antenna port with Hitachi Antennas
Aegis Labs, Inc. File #: INTEL-040915-07*

RADIATED EMISSIONS - Horizontal Antenna Polarization											
<i>Freq. (MHz)</i>	<i>Meter Reading (dBuV)</i>	<i>Antenna Height (cm)</i>	<i>Azimuth (degrees)</i>	<i>Quasi pk or AVG (dBuV)</i>		<i>Preamp Factor (dB)</i>	<i>Cable Factor (dB)</i>	<i>Ant. Factor (dB)</i>	<i>Corrected Reading (dBuV)</i>	<i>Limits (dBuV)</i>	<i>Diff (dB) +=FAIL</i>
EUT in Continuous Transmit Mode on Channel 1 (2.412 GHz)											
4823.98	49.83	100	135			43.27	4.73	34.53	45.82	74.00	-28.18
4823.98				40.56	A	43.27	4.73	34.53	36.55	54.00	-17.45
9648.00	50.50	100	135			43.22	6.95	38.88	53.11	83.74	-30.63
EUT in Continuous Transmit Mode on Channel 6 (2.437 GHz)											
4873.99	49.67	100	135			43.29	4.77	34.72	45.87	74.00	-28.13
4873.99				39.69	A	43.29	4.77	34.72	35.89	54.00	-18.11
9747.96	50.17	100	135			43.25	6.99	39.00	52.90	84.37	-31.47
EUT in Continuous Transmit Mode on Channel 11 (2.462 GHz)											
4924.00	49.50	100	225			43.30	4.81	34.91	45.91	74.00	-28.09
4924.00				38.90	A	43.30	4.81	34.91	35.31	54.00	-18.69
9848.01	50.33	100	135			43.29	7.03	39.12	53.19	83.50	-30.31



AEGIS LABS INC.

Spurious Radiated Emissions Test Results (Continued)

RADIATED EMISSIONS - Vertical Antenna Polarization											
<i>Freq. (MHz)</i>	<i>Meter Reading (dBuV)</i>	<i>Antenna Height (cm)</i>	<i>Azimuth (degrees)</i>	<i>Quasi pk or AVG (dBuV)</i>		<i>Preamp Factor (dB)</i>	<i>Cable Factor (dB)</i>	<i>Ant. Factor (dB)</i>	<i>Corrected Reading (dBuV)</i>	<i>Limits (dBuV)</i>	<i>Diff (dB) +=FAIL</i>
EUT in Continuous Transmit Mode on Channel 1 (2.412 GHz)											
4823.96	50.17	100	180			43.27	4.73	34.53	46.16	74.00	-27.84
4823.96				38.98	A	43.27	4.73	34.53	34.97	54.00	-19.03
9647.97	50.00	100	135			43.22	6.95	38.97	52.70	82.54	-29.84
EUT in Continuous Transmit Mode on Channel 6 (2.437 GHz)											
4874.01	49.50	100	135			43.29	4.77	34.72	45.70	74.00	-28.30
4874.01				37.56	A	43.29	4.77	34.72	33.76	54.00	-20.24
9748.02	50.33	100	135			43.25	6.99	39.15	53.21	82.85	-29.64
EUT in Continuous Transmit Mode on Channel 11 (2.462 GHz)											
4924.00	49.17	100	180			43.30	4.81	34.91	45.58	74.00	-28.42
4924.00				38.13	A	43.30	4.81	34.91	34.54	54.00	-19.46
9847.96	50.50	100	135			43.29	7.03	39.33	53.57	81.50	-27.93



Spurious Radiated Emissions Test Results (Continued)

*Spurious Emissions Measurements in 802.11b mode (2412-2462 MHz)
Channels 1, 6, & 11
Continuous RX at MAIN Antenna port with Hitachi Antennas
Aegis Labs, Inc. File #: INTEL-040915-07*

RADIATED EMISSIONS - Horizontal Antenna Polarization											
<i>Freq. (MHz)</i>	<i>Meter Reading (dBuV)</i>	<i>Antenna Height (cm)</i>	<i>Azimuth (degrees)</i>	<i>Quasi pk or AVG (dBuV)</i>	<i>Preamp Factor (dB)</i>	<i>Cable Factor (dB)</i>	<i>Ant. Factor (dB)</i>	<i>Corrected Reading (dBuV)</i>	<i>Limits (dBuV)</i>	<i>Diff (dB)</i>	<i>+ = FAIL</i>
EUT in Continuous Receive Mode on Channel 1 (2.412 GHz)											
1608.00	49.17	100	225			42.54	2.71	29.36	38.70	80.00	-41.30
1608.00				36.92	A	42.54	2.71	29.36	26.45	60.00	-33.55
9647.97	50.00	100	135			43.22	6.95	38.88	52.61	80.00	-27.39
9647.97				37.68	A	43.22	6.95	38.88	40.29	60.00	-19.71
EUT in Continuous Receive Mode on Channel 6 (2.437 GHz)											
1624.68	49.67	100	225			42.54	2.72	29.47	39.33	80.00	-40.67
1624.68				37.00	A	42.54	2.72	29.47	26.66	60.00	-33.34
9748.00	50.17	100	90			43.25	6.99	39.00	52.90	80.00	-27.10
9748.00				38.23	A	43.25	6.99	39.00	40.96	60.00	-19.04
EUT in Continuous Receive Mode on Channel 11 (2.462 GHz)											
1641.32	50.00	100	225			42.55	2.74	29.59	39.78	80.00	-40.22
1641.32				37.36	A	42.55	2.74	29.59	27.14	60.00	-32.86
9847.98	50.33	100	135			43.29	7.03	39.12	53.19	80.00	-26.81
9847.98				38.41	A	43.29	7.03	39.12	41.27	60.00	-18.73



Spurious Radiated Emissions Test Results (Continued)

RADIATED EMISSIONS - Vertical Antenna Polarization											
<i>Freq. (MHz)</i>	<i>Meter Reading (dBuV)</i>	<i>Antenna Height (cm)</i>	<i>Azimuth (degrees)</i>	<i>Quasi pk or AVG (dBuV)</i>		<i>Preamp Factor (dB)</i>	<i>Cable Factor (dB)</i>	<i>Ant. Factor (dB)</i>	<i>Corrected Reading (dBuV)</i>	<i>Limits (dBuV)</i>	<i>Diff (dB) +=FAIL</i>
EUT in Continuous Receive Mode on Channel 1 (2.412 GHz)											
1608.00	49.50	100	135			42.54	2.71	29.39	39.07	80.00	-40.93
1608.00				37.39	A	42.54	2.71	29.39	26.96	60.00	-33.04
9647.97	49.83	100	135			43.22	6.95	38.97	52.53	80.00	-27.47
9647.97				37.98	A	43.22	6.95	38.97	40.68	60.00	-19.32
EUT in Continuous Receive Mode on Channel 6 (2.437 GHz)											
1624.68	50.00	100	135			42.54	2.72	29.50	39.68	80.00	-40.32
1624.68				38.13	A	42.54	2.72	29.50	27.81	60.00	-32.19
9748.00	50.50	100	135			43.25	6.99	39.15	53.38	80.00	-26.62
9748.00				38.78	A	43.25	6.99	39.15	41.66	60.00	-18.34
EUT in Continuous Receive Mode on Channel 11 (2.462 GHz)											
1641.32	49.67	100	135			42.55	2.74	29.60	39.46	80.00	-40.54
1641.32				37.83	A	42.55	2.74	29.60	27.62	60.00	-32.38
9847.98	50.00	100	135			43.29	7.03	39.33	53.07	80.00	-26.93
9847.98				38.29	A	43.29	7.03	39.33	41.36	60.00	-18.64



AEGIS LABS INC.

PEAK TRANSMIT POWER

CLIENT:	Dell Computer Corporation	DATE:	09/15/04
EUT:	Latitude D810 Notebook Computer	PROJECT NUMBER:	INTEL-040915-01
MODEL NUMBER:	PP15L	TEST ENGINEER:	JC
SERIAL NUMBER:	GVQKT41	SITE #:	2
CONFIGURATION:	Tested with an Intel PRO/Wireless 2100 Network Connection installed in its mini PCI slot.	TEMPERATURE:	25 C
		HUMIDITY:	51% RH
		TIME:	11:30 AM

Standard:	FCC CFR 47, Part 15.247(b)(1)
Description:	The maximum peak output power of the intentional radiator shall not exceed 1 watt.
Results:	See Data Sheet

Peak Transmit Power Limits	
Frequency (MHz)	Output Power (W)
2412-2462	1

Page 25 of 39 (Appendix A)
Report Number: INTEL-040915F
FCC ID: E2K24CLNS



Peak Transmit Power (Continued)

Mode	Channel	Frequency (MHz)	Rate (Mbps)	Conducted Power (dBm)	Power (mW)
802.11b	1	2412	1	16.40	43.65
802.11b	1	2412	5.5	16.35	43.15
802.11b	1	2412	11	16.25	42.17
802.11b	6	2437	1	16.10	40.74
802.11b	6	2437	5.5	16.40	43.65
802.11b	6	2437	11	15.95	39.36
802.11b	11	2462	1	16.15	41.21
802.11b	11	2462	5.5	16.20	41.69
802.11b	11	2462	11	16.15	41.21

NOTE: The output power measurement is conducted.



AEGIS LABS INC.

6 dB EMISSIONS BANDWIDTH

CLIENT:	Dell Computer Corporation	DATE:	09/15/04
EUT:	Latitude D810 Notebook Computer	PROJECT NUMBER:	INTEL-040915
MODEL NUMBER:	PP15L	TEST ENGINEER:	JC
SERIAL NUMBER:	GVQKT41	SITE #:	2
CONFIGURATION:	Tested with an Intel PRO/Wireless 2100 Network Connection installed in its mini PCI slot.	TEMPERATURE:	23 C
		HUMIDITY:	35% RH
		TIME:	3:30 PM

Standard:	FCC CFR 47, Part 15.247(a)(2)
Description:	The minimum 6dB bandwidth shall be at least 500 kHz.
Results:	See Data Sheets

*Page 27 of 39 (Appendix A)
Report Number: INTEL-040915F
FCC ID: E2K24CLNS*



AEGIS LABS INC.

6 dB Emissions Bandwidth (Continued)

802.11b Mode

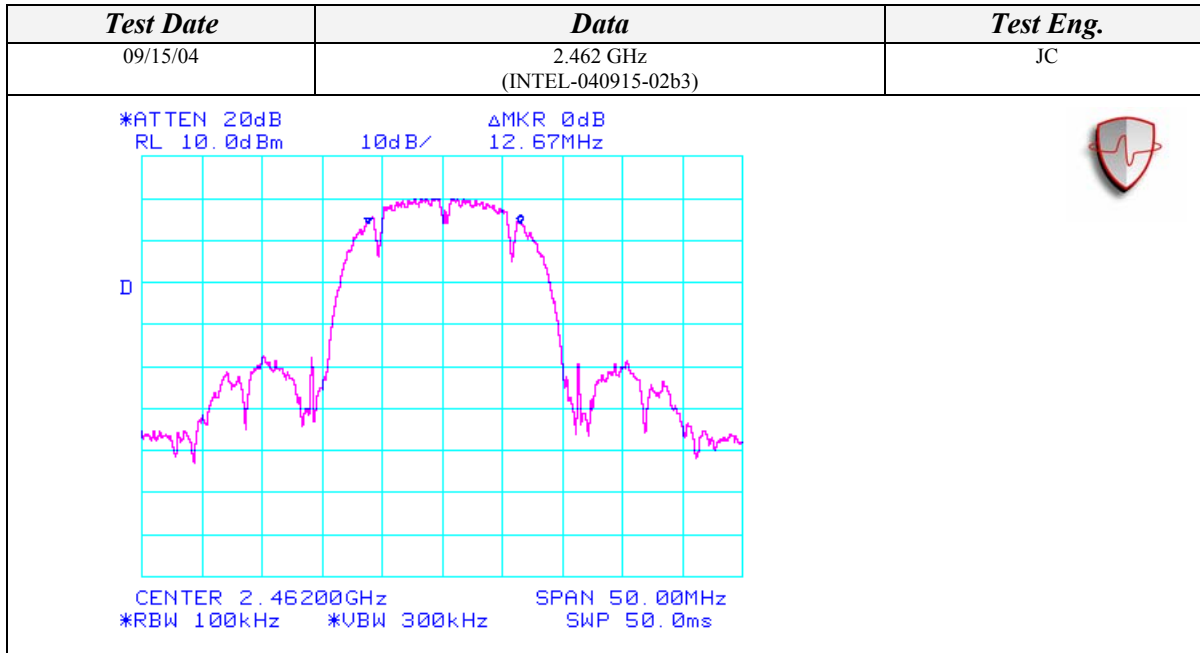



AEGIS LABS INC.

PEAK POWER SPECTRAL DENSITY

CLIENT:	Dell Computer Corporation	DATE:	09/15/04
EUT:	Latitude D810 Notebook Computer	PROJECT NUMBER:	INTEL-040915
MODEL NUMBER:	PP15L	TEST ENGINEER:	JC
SERIAL NUMBER:	GVQKT41	SITE #:	2
CONFIGURATION:	Tested with an Intel PRO/Wireless 2100 Network Connection installed in its mini PCI slot.	TEMPERATURE:	23 C
		HUMIDITY:	35% RH
		TIME:	3:30 PM

Standard:	FCC CFR 47, Part 15.247(d)
Description:	The peak power spectral density conducted from the intentional radiator to the antenna shall not be greater than 8 dBm in any 3 kHz band during any time interval of continuous transmission.
Results:	See Data Sheets

Peak Power Spectral Density Limits	
Frequency (MHz)	Limit (dBm)
2412-2462	8

Page 30 of 39 (Appendix A)
Report Number: INTEL-040915F
FCC ID: E2K24CLNS



AEGIS LABS INC.

Peak Power Spectral Density (Continued)

802.11b Mode

Test Date	Data	Test Eng.
09/15/04	2.412 GHz (INTEL-040915-02d1)	JC

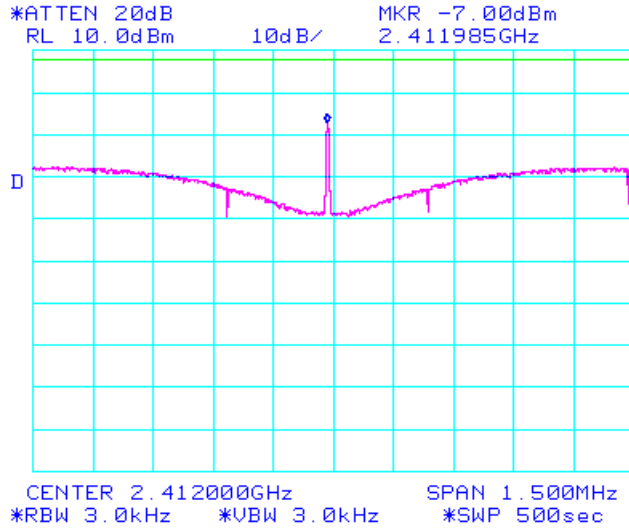

Test Date	Data	Test Eng.
09/15/04	2.437 GHz (INTEL-040915-02d2)	JC

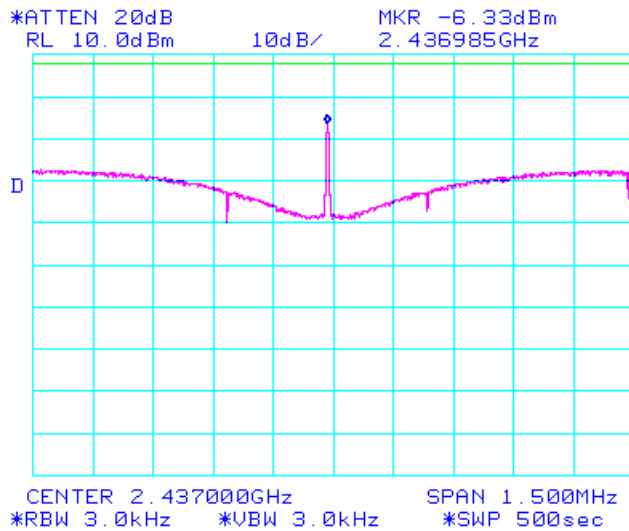



AEGIS LABS INC.

Peak Power Spectral Density (Continued)

802.11b Mode

Test Date	Data	Test Eng.
09/15/04	2.462 GHz (INTEL-040915-02d3)	JC

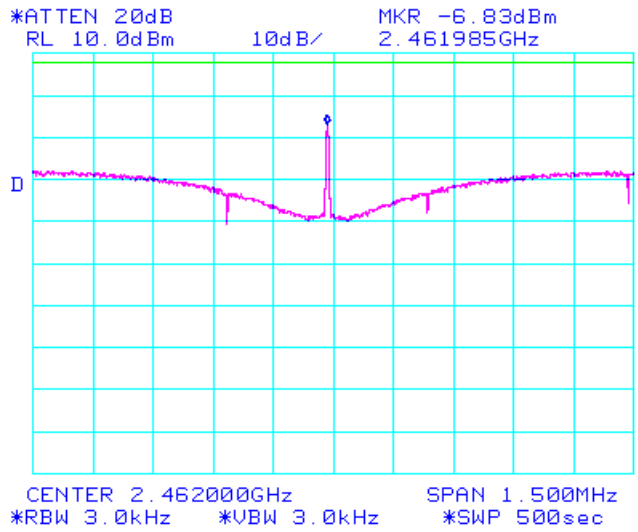



AEGIS LABS INC.

CONDUCTED OUT OF BAND EMISSIONS

CLIENT:	Dell Computer Corporation	DATE:	09/15/04
EUT:	Latitude D810 Notebook Computer	PROJECT NUMBER:	INTEL-040915
MODEL NUMBER:	PP15L	TEST ENGINEER:	JC
SERIAL NUMBER:	GVQKT41	SITE #:	2
CONFIGURATION:	Tested with an Intel PRO/Wireless 2100 Network Connection installed in its mini PCI slot.	TEMPERATURE:	23 C
		HUMIDITY:	35% RH
		TIME:	3:30 PM

Standard:	FCC CFR 47, Part 15.247(c)
Description:	In any 100 kHz bandwidth outside the frequency band in which the spread spectrum intentional radiator is operating, the radio frequency power that is produced by the intentional radiator shall be at least 20 dB below that in the 100 kHz bandwidth within the band that contains the highest level of the desired power.

Page 33 of 39 (Appendix A)
Report Number: INTEL-040915F
FCC ID: E2K24CLNS



Conducted Out Of Band Emissions (Continued)

802.11b Mode

Test Date	Data	Test Eng.
09/15/04	2.412 GHz (INTEL-040915-02e01)	JC

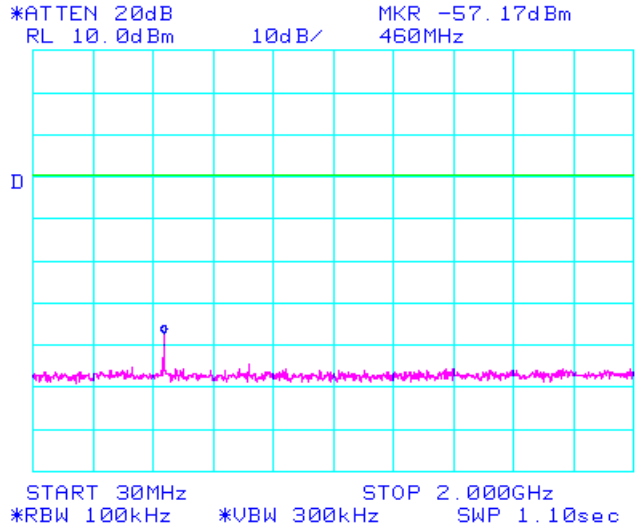

Test Date	Data	Test Eng.
09/15/04	2.412 GHz (INTEL-040915-02e02)	JC

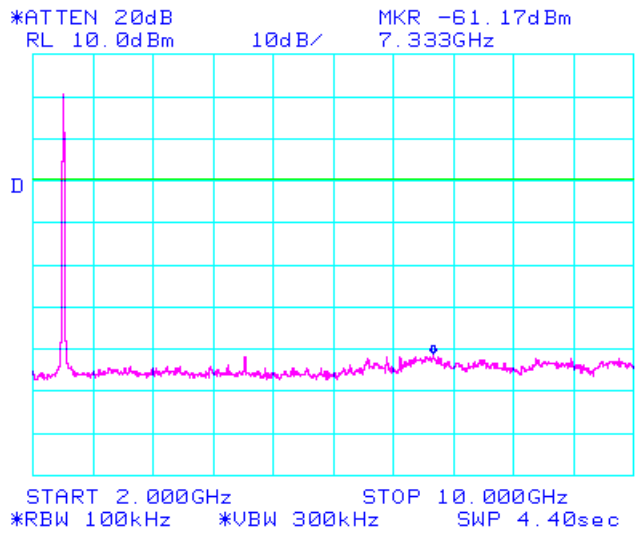



Conducted Out Of Band Emissions (Continued)

802.11b Mode

Test Date	Data	Test Eng.
09/15/04	2.412 GHz (INTEL-040915-02e03)	JC
<p>*ATTEN 20dB MKR -59.67dBm RL 10.0dBm 10dB/ 13.33GHz</p> <p>START 10.00GHz STOP 20.00GHz *RBW 100kHz *UBW 300kHz SWP 5.50sec</p>		
Test Date	Data	Test Eng.
09/15/04	2.412 GHz (INTEL-040915-02e04)	JC
<p>*ATTEN 20dB MKR -56.50dBm RL 10.0dBm 10dB/ 24.510GHz</p> <p>START 20.000GHz STOP 26.000GHz *RBW 100kHz *UBW 300kHz SWP 3.30sec</p>		



AEGIS LABS INC.

Conducted Out Of Band Emissions (Continued)

802.11b Mode

Test Date	Data	Test Eng.
09/15/04	2.437 GHz (INTEL-040915-02e05)	JC

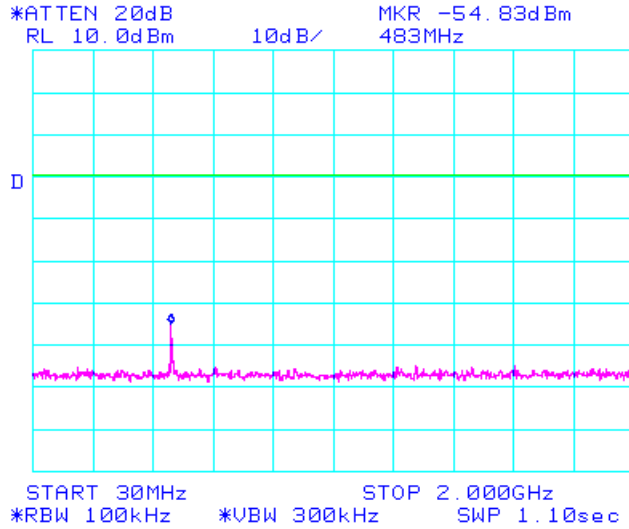

Test Date	Data	Test Eng.
09/15/04	2.437 GHz (INTEL-040915-02e06)	JC

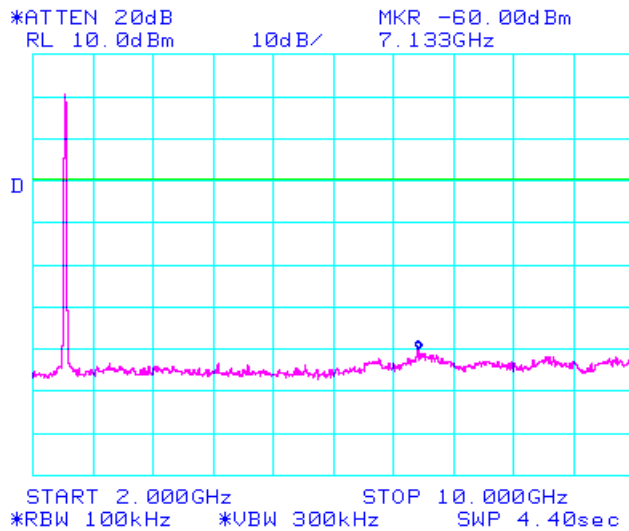



Conducted Out Of Band Emissions (Continued)

802.11b Mode

Test Date	Data	Test Eng.
09/15/04	2.437 GHz (INTEL-040915-02e07)	JC

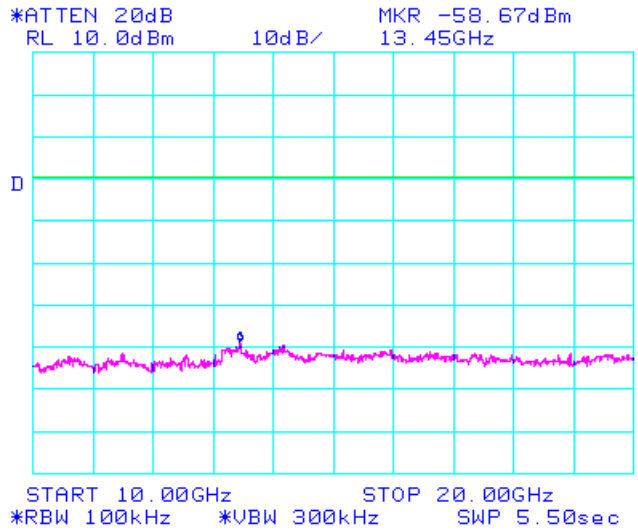

Test Date	Data	Test Eng.
09/15/04	2.437 GHz (INTEL-040915-02e08)	JC

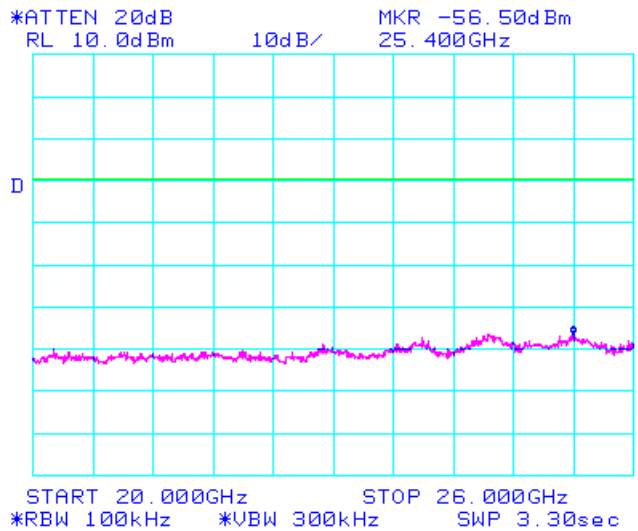



AEGIS LABS INC.

Conducted Out Of Band Emissions (Continued)

802.11b Mode

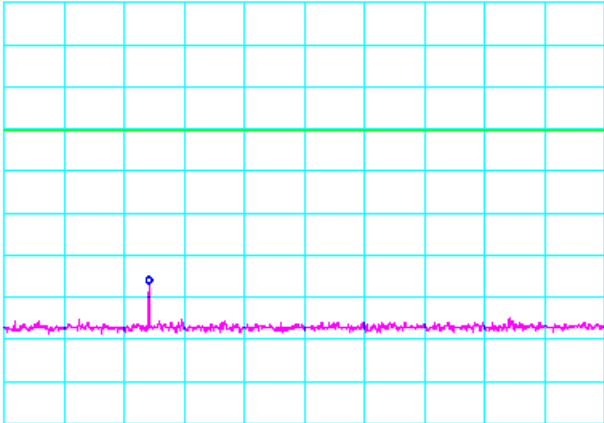
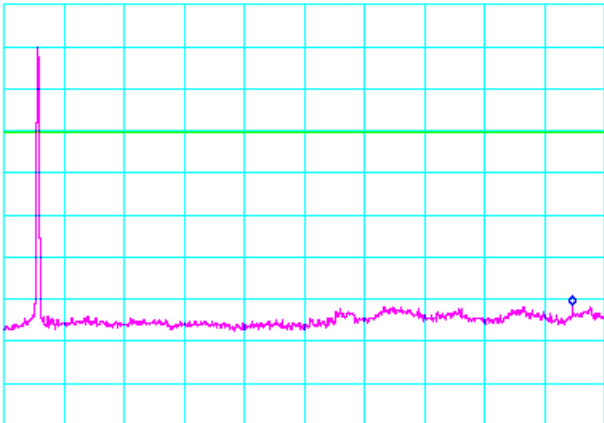
Test Date	Data	Test Eng.
09/15/04	2.462 GHz (INTEL-040915-02e09)	JC
<p>*ATTEN 20dB RL 10.0dBm 10dB/ MKR -57.00dBm 506MHz</p>  <p>START 30MHz STOP 2.000GHz *RBW 100kHz *UBW 300kHz SWP 1.10sec</p>		
Test Date	Data	Test Eng.
09/15/04	2.462 GHz (INTEL-040915-02e10)	JC
<p>*ATTEN 20dB RL 10.0dBm 10dB/ MKR -61.33dBm 9.573GHz</p>  <p>START 2.000GHz STOP 10.000GHz *RBW 100kHz *UBW 300kHz SWP 4.40sec</p>		



AEGIS LABS INC.

Conducted Out Of Band Emissions (Continued)

802.11b Mode

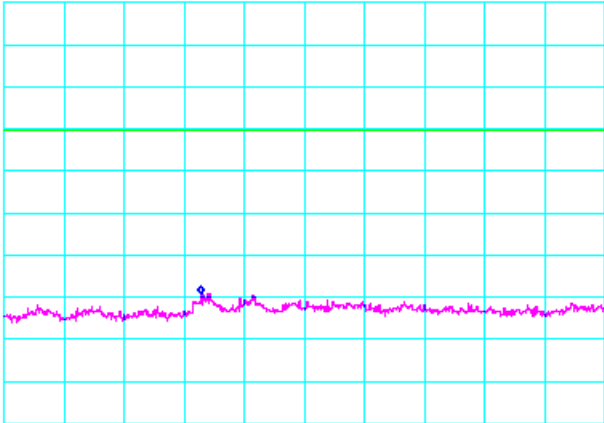
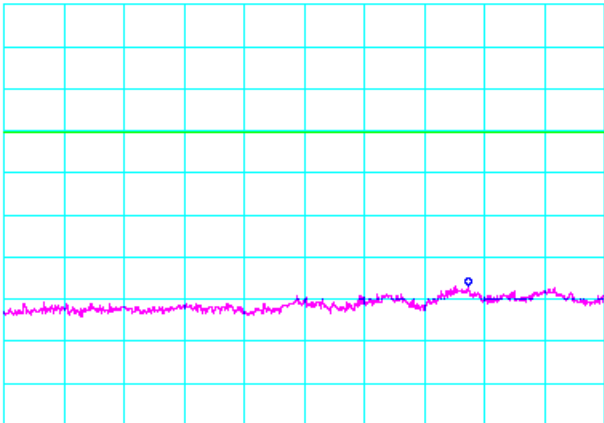
Test Date	Data	Test Eng.
09/15/04	2.462 GHz (INTEL-040915-02e11)	JC
<p>*ATTEN 20dB RL 10.0dBm 10dB/ MKR -59.33dBm 13.28GHz</p>  <p>START 10.00GHz STOP 20.00GHz *RBW 100kHz *UBW 300kHz SWP 5.50sec</p>		
Test Date	Data	Test Eng.
09/15/04	2.462 GHz (INTEL-040915-02e12)	JC
<p>*ATTEN 20dB RL 10.0dBm 10dB/ MKR -56.83dBm 24.640GHz</p>  <p>START 20.000GHz STOP 26.000GHz *RBW 100kHz *UBW 300kHz SWP 3.30sec</p>		