

Applicant Name: Intel Corporation
Applicant Address: Intel Corporation
 Evening Creek Drive,
 San Diego CA, 92128



FCC ID: E2K24CLNS
Project Number: ITLB-WM3A2200B-MINI-PCI-Card-DELL-Abacus-H-(FCC)-5001
Test/Analysis Date: 16th February 2004

DUT Type	Laptop computer with 802.11b WLAN
Antenna Type	Internal WNC
Model Number	WM3A2100
Project Name	Dell Abacus
Received Status	Production Model
DUT Serial Number	CN-0W0941-12961-3A3-5558
Experimental/Compliance	Compliance (FCC)
Tx Frequency	2412MHz to 2462MHz
Max Tx Power	802.11b 16.5dB
Conservative Averaged SAR (RF Exposure)	802.11b 1.43 W/kg

We the undersigned of APREL Laboratories, located at 51 Spectrum Way, Ottawa, Ontario, Canada, K2R-1E6, on the date indicated attest that the Device Under Test as detailed within this test report has been tested and found to be compliant with the Uncontrolled Environment RF exposure rules and regulations as defined by the methodologies, procedures, and standards as described in this document.

APREL Laboratories are an ISO 17025 accredited facility.

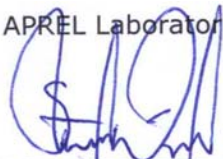
 4th March 04

 Stuart Nicol, Date
 Director Product Development

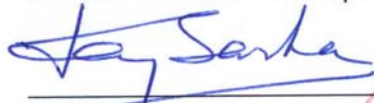
 March 4, 2004

 Jay Sarkar, Date
 Director Standards & Certification

 March 8/04

 Dr Jacek J. Wojcik, Date
 P. Engineer



Project number: ITLB-Dell-5001
 FCC ID: ID:E2K24CLNS



Table of Contents

1.0 Introduction..... 3

2.0 Applicable Documents 3

3.0 ALSAS-10U System Description 3

3.1 Applications 3

3.2 Visualisation and reporting 3

3.3 Field scans 3

3.3.1 Area Scans 3

3.3.2 Zoom Scan (Cube Scan Averaging) 3

3.4 Operator settings 3

3.5 ALSAS-10U Interpolation and Extrapolation Uncertainty 3

4.0 ALSAS-10U Hardware 3

4.1 Isotropic E-Field Probe 3

4.2 Isotropic E-Field Probe Specification 3

4.3 Boundary Detection Unit and Probe Mounting Device 3

4.4 Daq-Paq (Analog to Digital Electronics) 3

4.5 Axis Articulated Robot 3

4.6 ALSAS Universal Workstation 3

4.7 Universal Device Positioner 3

4.8 Phantom Types 3

4.8.1 APREL SAM Phantoms 3

4.8.2 APREL Laboratories Universal Phantom..... 3

4.9 Validation Dipoles 3

5.0 Tissue Simulation Fluid 3

5.1 Tissue Calibration Procedure Using a Coaxial Probe..... 3

5.2 Tissue Calibration Results 3

6.0 System Validation 3

6.1 Experimental Results Summary 3

6.2 SAR Measurement Procedure 3

6.3 SAR Exposure Limits 3

6.4 Equipment List 3

6.5 SAR Measurement Results 3

7.0 Measurement Uncertainty 3

Appendix A SAR Plots..... 3

Appendix B Probe Calibration Certificate 3

Appendix C Dipole Calibration Certificate 3



1.0 Introduction

Tests were conducted at APREL Laboratories within the ISO 17025 accredited SAR facility to establish the conservative exposure value associated with the Device Under Test as detailed within this test report. Assessments were made in line with the guidelines contained in the reference documents. The method used for assessment was the ALSAS-10U (APREL Laboratories SAR Assessment System-10 Universal). All practices along with standards and scientific methodologies which have been utilized during the assessment of the Device Under Test (DUT) are detailed within this test report.

APREL Laboratories employees currently hold senior and executive positions in multiple international standards organizations, including IEC, IEEE, among others, and work closely with several national regulators, including the FCC. Through the IEC, we have a liaison with CENELEC, and informal links to other national and international standards organizations.

2.0 Applicable Documents

EN-50371 TITLE "Generic Standard to Demonstrate the Compliance of low power electronic and electrical apparatus with the basic restrictions related to human exposure to electromagnetic fields (10MHz-300GHz) general public"

2) DIRECTIVE 1999/5/EC OF THE EUROPEAN PARLIAMENT AND OF THE COUNCIL of 9 March 1999 on radio equipment and telecommunications terminal equipment and the mutual recognition of their conformity

ANSI/IEEE C95.1-1999, IEEE Standard for Safety Levels with Respect to Human Exposure to Radio Frequency Electromagnetic Fields, 3 kHz to 300 GHz.

FCC 96-326, Guidelines for Evaluating the Environmental Effects of Radio-Frequency Radiation.

ANSI/IEEE C95.3-1992, IEEE Recommended Practice for the Measurement of Potentially Hazardous Electromagnetic Fields – RF and Microwave.

OET Bulletin 65 (Edition 97-01) Supplement C (Edition 01-01), "Evaluating Compliance with FCC Guidelines for Human Exposure to Radio Frequency Electromagnetic Fields".

IEEE 1528 "Recommended Practice for Determining the Peak Spatial Average Specific Absorption Rate (SAR) in the Human Body Due to Wireless Communication Devices: Experimental Techniques."

3.0 ALSAS-10U System Description

APREL Laboratories ALSAS-10-U (APREL Laboratories SAR Assessment System) is fully optimized for the dosimetric evaluation of a broad range of wireless transceivers and antennas. It is an easy-to-use development and compliance tool, which provides excellent application flexibility. Developed in line with the latest methodologies it is fully compliant with the technical and scientific requirements of IEEE 1528, IEC 62209, CENELEC, ARIB, ACA, and the Federal Communications Commission. The system comprises of a six axes articulated robot which utilizes a dedicated controller.

ALSAS-10U has been developed with a strong engineering focus, and with custom modular software/hardware for the broadest range of applications, including dosimetry research and measurements in various Phantoms – SAM Phantom, UniPhantom™ Universal Phantom, Universal Flat Phantom and others.

Free space E-Field measurements of mobile devices and base station antennas can also be executed using ALSAS. With the current ALSAS configuration, several phantoms and setups can be arranged around the system – and since the phantoms are designed to be light and easy to move for interchanging between test frequencies.

ALSAS-10U has been developed using the latest methodologies and FDTD modeling to provide a platform which is repeatable with minimum uncertainty.

The ongoing commitment from APREL Laboratories to the field of Dosimetric research and development will ensure that the ALSAS-10-U measurement system can easily be upgraded to accommodate changes to wireless technologies, and scientific methodologies.



3.1 Applications

Predefined measurement procedures compliant with the guidelines of CENELEC, IEEE, IEC, FCC, etc are utilized during the assessment for the device. Automatic detection for all SAR maxima are embedded within the core architecture for the system, ensuring that peak locations used for centering the zoom scan are within a 1mm resolution and a 0.05mm repeatable position. A little less than 10 min per device position measurement completion time, (depending of DUT size) ensures minimum power drift during the assessment. No user interaction is required during the measurement processes: area scan, evaluation of cube maximal search, fine cube measurements and device power drift measurement. System operation range currently available up-to 6 GHz in simulated tissue.

ALSAS-10U can be used for all analog and digital devices, including wideband, spread spectrum and pulsed systems, etc.: handsets, handhelds, wireless data, electronic article surveillance, accessories, wireless access points, WLAN, cordless, radio, etc.

3.2 Visualisation and reporting

2/3D isoline distribution, scatter graphics, polar graphics, and vector reproduction. Device representation and phantom visualization in 2/3D graphics with measurement data overlaid (in color plot format). Freely configurable output graphic formats with automatic title, data and legend generation which includes all relevant information relating to the measurement process. Uncertainty analysis and budget calculated and reported drawing on active device drift assessment, and tissue simulation values.

3.3 Field scans

ALSAS-10U can provide multiple scan types including Measurements along lines (X, Y, Z), multiple planes, curved surfaces, volumes in free space or restricted volumes (phantoms). Cube measurements with surface extrapolation and spatial SAR evaluation for 1g and/or 10g. Time measurements (source power drift). Probe rotation measurements (isotropy) and many others in line with the requirements of any given standard or procedure.

3.3.1 Area Scans

Area scans are defined prior to the measurement process being executed with a user defined variable spacing between each measurement point (integral) allowing low uncertainty measurements to be conducted. Scans defined for FCC applications utilize a 10mm² step integral, with 1mm interpolation used to locate the peak SAR area used for zoom scan assessments.

Where the system identifies multiple SAR peaks (which are within 25% of peak value) the system will provide the user with the option of assessing each peak location individually for zoom scan averaging.

3.3.2 Zoom Scan (Cube Scan Averaging)

The averaging zoom scan volume utilized in the ALSAS-10U software is in the shape of a cube and the side dimension of a 1 g or 10 g mass is dependent on the density of the liquid representing the simulated tissue. A density of 1 000 kg/m³ is used to represent the head and body tissue density and not the phantom liquid density, in order to be consistent with the definition of the liquid dielectric properties, i.e. the side length of the 1 g cube is 10mm, with the side length of the 10 g cube 21,5mm.

When the cube intersects with the surface of the phantom, it is oriented so that 3 vertices touch the surface of the shell or the centre of a face is tangent to the surface. The face of the cube closest to the surface is modified in order to conform to the tangent surface.

The zoom scan integer steps can be user defined so as to reduce uncertainty, but normal practice for typical test applications (including FCC) utilize a physical step of 5x5x8 (8mmx8mmx5mm) providing a volume of 32mm in the X & Y axis, and 35mm in the Z axis.

3.4 Operator settings

Multiple access levels (password protected) for parametric modifications/test scenarios in line with selected standards, including the FCC. Any number of predefined settings (probes, phantoms, liquids, devices, measurement procedures, etc.) can be stored for future use and repeatable assessments.

3.5 ALSAS-10U Interpolation and Extrapolation Uncertainty

The overall uncertainty for the methodology and algorithms the used during the SAR calculation was evaluated using the data from IEEE 1528 based on the example f3 algorithm:

$$f_3(x, y, z) = A \frac{a^2}{\frac{a^2}{4} + x'^2 + y'^2} \cdot \left(e^{-\frac{2z}{a}} + \frac{a^2}{2(a + 2z)^2} \right)$$

4.0 ALSAS-10U Hardware

The ALSAS-10U comprises of hardware designed exclusively by APREL Laboratories based on methodologies presented in IEEE 1528, IEC 62209, CENELEC and FCC supplement C OET bulletin 65.

4.1 Isotropic E-Field Probe

The isotropic E-Field probe used by APREL Laboratories, has been fully calibrated and assessed for isotropicity, and boundary effect within a controlled environment. Depending on the frequency for which the probe is calibrated the method utilized for calibration will change. APREL Laboratories utilize a number of methods for calibrating probes, and these are outlined in the table below.

Calibration Frequency (MHz)	Air Calibration	Tissue Calibration
300	TEM Cell	Temperature
450	TEM Cell	Temperature
835	TEM Cell	Temperature
900	TEM Cell	Temperature
1800	TEM Cell	Temperature
1900	TEM Cell	Temperature
2450	Waveguide	Temperature
5200	Waveguide	Waveguide
5800	Waveguide	Waveguide

The APREL Laboratories E-Field probe utilizes a triangular sensor arrangement as detailed in the diagram below.



SAR is assessed with a calibrated probe which moves at a default height of 5mm from the centre of the diode, which is mounted to the sensor, to the phantom surface (in the Z Axis). The 5mm offset height has been selected so as to minimize any resultant boundary effect due to the probe being in close proximity to the phantom surface.

The following algorithm is an example of the function used by the system for linearization of the output from the probe when measuring complex modulation schemes.

$$V_i = U_i + U_i^2 \cdot \frac{cf}{dcp_i}$$

4.2 Isotropic E-Field Probe Specification

Calibration in Air	Frequency Dependent Below 2GHz Calibration in air performed in a TEM Cell Above 2GHz Calibration in air performed in waveguide
Sensitivity	0.70 $\mu\text{V}/(\text{V}/\text{m})^2$ to 0.85 $\mu\text{V}/(\text{V}/\text{m})^2$
Dynamic Range	0.01 W/kg to 100 W/kg
Isotropic Response	Better than 0.2dB
Diode Compression Point (DCP)	Calibrated for Specific Frequency
Probe Tip Radius	<5mm
Sensor Offset	1.56 (+/-0.02mm)
Probe Length	290mm
Video Bandwidth	@ 500 Hz: 1 dB @ 1.02 KHz: 3 dB
Boundary Effect	Less than 2% for distances greater than 2.4mm
Spatial Resolution	Diameter less than 5mm Compliant with Standards

4.3 Boundary Detection Unit and Probe Mounting Device

ALSAS-10U incorporates a boundary detection unit with a sensitivity of 0.05mm for detecting all types of surfaces. The robust design allows for detection during probe tilt (probe normalize) exercises, and utilizes a second stage emergency stop. The signal electronics are fed directly into the robot controller for high accuracy surface detection in lateral and axial detection modes (X, Y, & Z).

The probe is mounted directly onto the Boundary Detection unit for accurate tooling and displacement calculations controlled by the robot kinematics. The probe is connect to an isolated probe interconnect where the output stage of the probe is fed directly into the amplifier stage of the Daq-Paq.

4.4 Daq-Paq (Analog to Digital Electronics)

ALSAS-10U incorporates a fully calibrated Daq-Paq (analog to digital conversion system) which has a 4 channel input stage, sent via a 2 stage auto-set amplifier module. The input signal is amplified accordingly so as to offer a dynamic range from 5 μV to 800mV. Integration of the fields measured is carried out at board level utilizing a Co-Processor which then sends the measured fields down into the main computational module in digitized form via an RS232 communications port. Probe linearization and duty cycle compensation is carried out within the main Daq-Paq module.

ADC	12 Bit
Amplifier Range	20mV to 200mV and 150mV to 800mV
Field Integration	Local Co-Processor utilizing proprietary integration algorithms
Number of Input Channels	4 in total 3 dedicated and 1 spare
Communication	Packet data via RS232

4.5 Axis Articulated Robot



ALSAS-10U utilizes a six axis articulated robot, which is controlled using a Pentium based real-time movement controller. The movement kinematics engine utilizes proprietary (Thermo CRS) interpolation and extrapolation algorithms, which allow full freedom of movement for each of the six joints within the working envelope. Utilization of joint 6 allows for full probe rotation with a tolerance better than 0.05mm around the central axis.

Robot/Controller Manufacturer	Thermo CRS
Number of Axis	Six independently controlled axis
Positioning Repeatability	0.05mm
Controller Type	Single phase Pentium based C500C
Robot Reach	710mm
Communication	RS232 and LAN compatible

4.6 ALSAS Universal Workstation

ALSAS Universal workstation was developed with a strong engineering focus taking into consideration flexibility and engineering needs, and the necessity to have integrated system which will allow for repeatability and fast adaptability. ALSAS workstation technology is stable and robust in structure, but at the same time flexible so that users can do calibration, testing and measurements using different types of phantoms with one set up, which significantly speeds up the measurement process.

The workstation incorporates a modular structure which can be easily adapted to specific engineering requirements and needs. Phantoms which are self contained modular units are easily located, removable and swappable. Three fully configurable shelves allow for setting up of a test device in a way which can either utilize the APREL Laboratories device positioner, or custom designed units. When using the modular shelf for positioning of a device, additional loading characteristics have been avoided.

The workstation has been constructed entirely out of composite wood and Canadian maple, with all metallic fasteners kept at a compliant distance from the Device under test.

4.7 Universal Device Positioner



The APREL Laboratories universal device positioner has been developed so as to allow complete freedom of movement of the DUT. Developed to hold a DUT in a free-space scenario any additional loading attributable to the material used in the construction of the positioner has been eliminated. Repeatability has been enhanced through the linear scales which form the design used to indicate positioning for any given test scenario in all major axes. A 15° tilt indicator has been included for the of aid cheek to tilt movements for head SAR analysis. Overall uncertainty for measurements have been reduced due to the design of the Universal device positioner, which allows positioning of a device in as near to a free-space scenario as possible, and by providing the means for complete repeatability.



Length	201mm
Width	140mm
Height	222mm
Weight	1.95kg
Number of Axis	6 axis freedom of movement
Translation Along MB Line	+/- 76.2mm
Translation Along NF Line	+/- 38.1mm
Translation Along Z Axis	+/- 25.4mm (expandable to 500mm)
Rotation Around MB Line (yaw)	+/- 10°
Rotation Around NF Line (pitch)	+/- 30°
Rotation Around Z Axis (roll)	360° full circle
Minimum Grip Range	0mm
Maximum Grip	152mm
Maximum Distance from Device to Positioner Material	40mm
Tilt Movement	Full movement with predefined 15° guide

4.8 Phantom Types

The ALSAS-10U has been designed so as to allow the integration of multiple phantom types. This includes but is not limited to the APREL Laboratories SAM Phantoms fully compliant with IEEE 1528, Universal Phantom, and Universal Flat.

4.8.1 APREL SAM Phantoms

The APREL Laboratories SAM phantoms have been designed so as to aid repeatability and positioning for any DUT. Developed using the IEEE SAM CAD file they are fully compliant with the requirements for both IEEE 1528 and FCC Supplement C. Both the left and right SAM phantoms are interchangeable, transparent and include the IEEE 1528 grid with visible NF and MB lines.

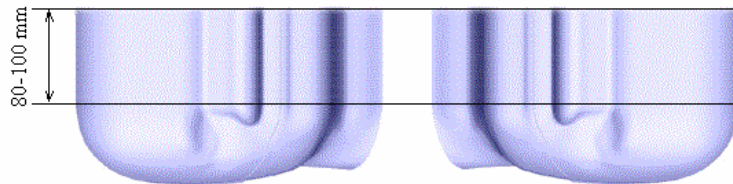

Compliant Standards	IEEE-1528, IEC 62209, CENELEC, and others
Manufacturing Process	Injection molded
Material	Composite urethane
Manufacturing Tolerance	+/- 0.2mm
Frame Material	Corian
Tissue Simulation Volume	7 ltr with 15cm tissue
Thickness	2mm nominally 6mm at NF/MB intersection
Loss Tangent	<0.05
Relative Permittivity	<5
Resistant to Solvents	Resistant to all solvents detailed in IEEE 1528
Load Deflection	<1mm with sugar water compositions

4.8.2 APREL Laboratories Universal Phantom



The APREL Laboratories Universal Phantom has been developed as an engineering tool for both compliance and development. It is also used on the ALSAS-10U as a system validation phantom. The unique design allows repeatable measurements for all devices, including handsets, PDA units, laptop computers, and validation dipoles. The APREL Laboratories Universal Phantom has been fully validated both experimentally from 800MHz to 6GHz and numerically using XFDTD numerical software. The shell thickness is 2mm overall, with a 4mm spacer located at the NF/MB intersection providing an overall thickness of 6mm in line with the requirements of IEEE-1528. The design allows for fast and accurate measurements, of handsets, by allowing the conservative SAR to be evaluated at on frequency for both left and right head experiments in one measurement. The phantom is surrounded by a Corian frame, which adds additional support and load bearing characteristics.

Compliant Standards	IEEE-1528, IEC 62209, CENELEC, and others
Frequency Range	800MHz to 6GHz
Material	Vivac
Manufacturing Tolerance	+/- 0.2mm
Frame Material	Corian
Tissue Simulation Volume	8 ltr with 15cm tissue
Thickness	2mm nominally 6mm at NF/MB intersection
Loss Tangent	<0.05
Relative Permittivity	<5
Resistant to Solvents	Resistant to all solvents detailed in IEEE 1528
Load Deflection	<1% Length with sugar water compositions
Dimensions	Length 220mm x breadth 170mm

4.9 Validation Dipoles

APREL Laboratories utilize dipoles based on the IEEE-1528 standard, and have ensured that they comply with mechanical and electrical specifications in line with the requirements of both IEEE and FCC Supplement C. The table below provides details for the mechanical and electrical specifications for the dipoles used by APREL Laboratories.

Body validation target numbers have been derived using XFDTD numerical software, and validated experimentally.

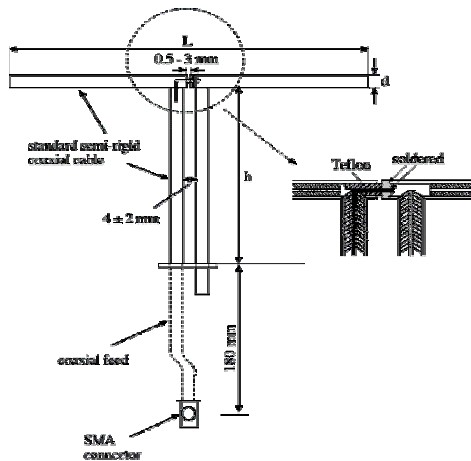

APREL Laboratories have developed high frequency dipoles based on current scientific research carried both experimentally and numerically here at the APREL Laboratories site. Mechanical and electrical parameters for the dipoles have been established using experimental and numerical techniques, and target SAR values have been established following IEC methodologies. The results of the experimental and numerical research have been published and released for peer review.

Frequency (MHz)	L (mm)	h (mm)	d (mm)
300	396.0	250.0	6.0
450	270.0	166.7	6.0
835	161.0	89.8	3.6
900	149.0	83.3	3.6
1450	89.1	51.7	3.6
1800	72.0	41.7	3.6
1900	68.0	39.5	3.6
2000	64.5	37.5	3.6
2450	51.5	30.4	3.6
3000	41.5	25.0	3.6
5200	X	X	X
5800	X	X	x

5.0 Tissue Simulation Fluid

Tissue simulation fluids in the frequency range of 450MHz to 2450MHz are based on IEEE-1528 and FCC Supplement C guidelines. All fluids meet the dielectric specifications as outlined in the above standards (within allowable tolerances) and are calibrated on a regular basis, to maintain stability. The recipes used along with the dielectric target values are included in the table below.

Ingredients (% Weight)	450 MHz Head	835 MHz Head	915 MHz Head	1900 MHz Head	2450 MHz Head
Water	38.56	41.45	41.05	54.9	62.7
Salt	3.95	1.45	1.35	0.18	0.5
Sugar	56.32	56.0	56.5	x	x
HEC	0.98	1.0	1.0	x	x
Bactericide	0.19	0.1	0.1	0.1	X
Triton-X	X	X	X	X	36.8
DGBE	X	X	X	44.92	x
ϵ^r	43.42	42.54	42.0	39.9	39.8
δ	0.85	0.91	1.0	1.42	1.88

Ingredients (% Weight)	450 MHz Body	835 MHz Body	915 MHz Body	1900 MHz Body	2450 MHz Body
Water	51.16	52.4	56.0	40.4	73.2
Salt	1.49	1.4	0.76	0.5	0.04
Sugar	46.78	45.0	41.76	58.0	X
HEC	0.52	1.0	1.21	1.0	X
Bactericide	0.05	0.1	0.27	0.1	X
Triton-X	X	X	X	X	X
DGBE	X	X	X	X	26.7
ϵ^r	58.0	56.1	56.8	54.0	52.5
δ	0.83	0.95	1.07	1.45	1.78

NOTE. Recipes are based on those presented in FCC Supplement C Page 36.

For frequencies above 2450MHz recipes are presented in a separate appendix.

5.1 Tissue Calibration Procedure Using a Coaxial Probe

The VNA (Vector Network Analyzer) is configured and calibrated for the frequency of the simulated tissue which has to be assessed. The Coaxial probe is then calibrated in line with the tissue frequency using an open, short, and De-Ionized water routine. The sample of simulated tissue is placed into a non-metallic container for use during the calibration. The temperature of the simulated tissue sample is measured. The probe head is then completely immersed in the simulated tissue sample (the probe is held in place using a non metallic probe holder). The simulated tissue sample is then measured to assess the permittivity and conductivity.

5.2 Tissue Calibration Results

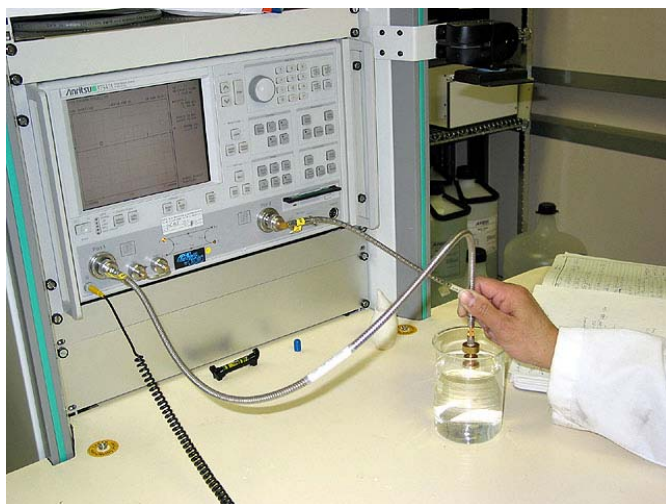

Tissue used during the SAR assessment is calibrated prior to use in the measurement process. APREL Laboratories use the co-axial probe method for all tissue calibration exercises. Tissue which is being used over a period of 24 hours is re-calibrated to ensure that no change to the dielectric properties will affect the SAR measurement process. The table below provides details of the results from the tissue equivalent dielectric calibration.

Calibrated By	Calibration Date	Frequency MHz	Tissue Type	Epsilon (ϵ')	Sigma (δ)
A. Beaudry	16-02-04	2450	Body	52.46	2.02

6.0 System Validation

ALSAS-10U is fully validated prior to the SAR assessment of the DUT following methodologies presented in IEEE-1528 section 8. The system is validated using tissue which has been calibrated within a 24 hour period. When the measurement process exceeds a 24 hour period a secondary system validation is executed and the results presented within this test report. The graphic plots resulting from the system validation are included in Appendix A SAR plots.

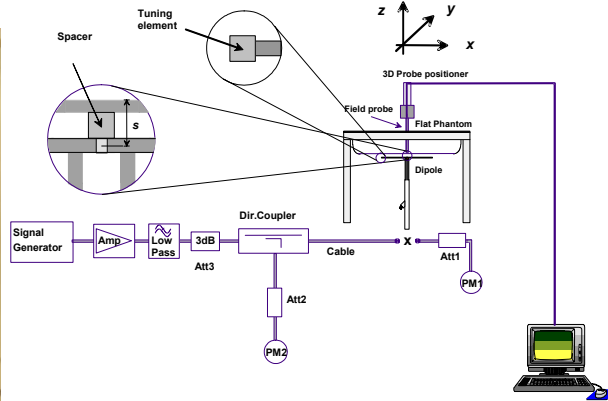

Date	Validation Frequency (MHZ)	Dipole Separation Distance mm	Power W	Dipole	SAR 1g W/kg	Target 1g W/kg	Delta %
23-12-03	2450	10	1.0	AL-CD10	52.9	52.4	1

Currently no standards are in place for validating a system while using body tissue. APREL Laboratories have conducted research using XFDTD to assess the target validation numbers while using body tissue. It should be noted that the target validation numbers presented in IEEE-1528 have been derived using FDTD methodologies.



6.1 Experimental Results Summary

The results for each experimental assessment are contained within this section. Where any deviation has been made from the given procedures contained within IEEE-1528 or FCC Supplement C this has been described accordingly.

6.2 SAR Measurement Procedure

The ALSAS-10U calculates SAR using the following equation,

$$SAR = \frac{\sigma |E|^2}{\rho}$$

σ: represents the simulated tissue conductivity
 ρ: represents the tissue density

The DUT is set to transmit at the required power in line with product specification, at each frequency relating to the LOW, MID, and HIGH channel settings.

Pre-scans are made on the device to establish the location for the transmitting antenna, using a large area scan in either air or tissue simulation fluid.

The DUT is placed against the Universal Phantom where the maximum area scan dimensions are larger than the physical size of the resonating antenna. When the scan size is not large enough to cover the peak SAR distribution, it is modified by either extending the area scan size in both the X and Y directions, or the device is shifted within the predefined area.

The area scan is then run to establish the peak SAR location (interpolated resolution set at 1mm²) which is then used to orient the center of the zoom scan. The zoom scan is then executed and the 1g and 10g averages are derived from the zoom scan volume (interpolated resolution set at 1mm³).

6.3 SAR Exposure Limits

SAR assessments have been made in line with the requirements of IEEE-1528, FCC Supplement C, and comply with ANSI/IEEE C95.1-1992 “Uncontrolled Environments” limits. These limits apply to a location which is deemed as “Uncontrolled Environment” which can be described as a situation where the general public may be exposed to an RF source with no prior knowledge or control over their exposure.

Type of Exposure	Uncontrolled Environment Limit
Spatial Peak SAR (1g cube tissue for brain or body)	1.60 W/kg
Spatial Average SAR (whole body)	0.08 W/kg
Spatial Peak SAR (10g for hands, feet, ankles and wrist)	4.00 W/kg



6.4 Equipment List

APREL Laboratories utilize the following equipment.

Equipment Description	Asset/Serial Number	Calibration Due Date
ALSAS-10U	301571	Prior to Test
Boundary Detection Unit	301572	Calibrated Once
Daq-Paq	301573	6 Jan 2005
Pentium 4 Workstation	301574	Not Required
Signal Generator	301468	September 2004
Gigatronics Power Meter	301393	October 2004
Gigatronics Broad Band Power Sensor	301394	October 2004
HP-Directional Coupler	100251	October 2004
APREL Laboratories 800-4200MHz 12W Amplifier	301577	Prior to Test
APREL Laboratories 2450MHz Validation Dipole	301581	November 2004
APREL Laboratories E-020 E-Field Probe	209	January 2005
40MHz -20GHz VNA	301382	January 2005
TRL Calibration Kit	301582	January 2006
APREL Laboratories Coaxial Probe (Dielectric Probe Kit)	100757	Prior to Test
APREL Laboratories Universal Phantom	301511	Calibrated Once
APREL Laboratories SAM Phantom LHS	301500	Calibrated Once
APREL Laboratories SAM Phantom RHS	301501	Calibrated Once
APREL Laboratories 15mm Dipole Separation Kit	301546	Calibrated Once
APREL Laboratories 10mm Dipole Separation Kit	301547	Calibrated Once



6.5 SAR Measurement Results

DELL Abacus PP08I

Intel PRO/Wireless 802.11b Mini-PCI type 3B WLAN Adapter

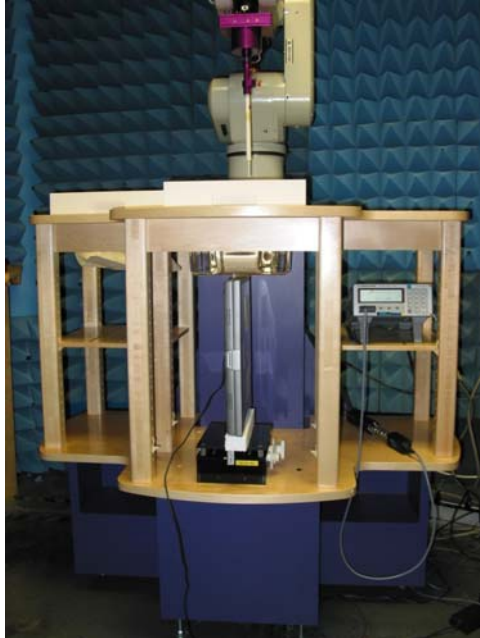

Power	16.5db 802.11b
DUT Position	Right hand side LCD Closed
Separation	0mm
Antenna Type	Internal
Antenna Manufacturer	WNC
Antenna Location	Right hand side towards LCD
Power Mode	Mains A/C
Tx Frequency	2412-2462MHz
Duty Cycle	100%
Epsilon	52.46
Sigma	2.02
Tissue Depth	15cm
Phantom Type	Universal
DUT Workstation Location	Centre
Device Positioner	HESET1
Test Date	16-03-04
Test Engineer	E. Payapaya

Mode	Channel	Frequency MHz	1g SAR W/kg
801.11b	1	2412	0.82
802.11b	6	2437	1.44
802.11b	12	2462	1.10

SAR Limit	Conservative Measured SAR
1.6 W/kg 1gram Average Maximum	1.44 W/kg 1gram Average

SAR Plot for Conservative SAR I Included in Appendix A.

DELL Abacus PP08I
Intel PRO/Wireless 802.11b Mini-PCI type 3B WLAN Adapter

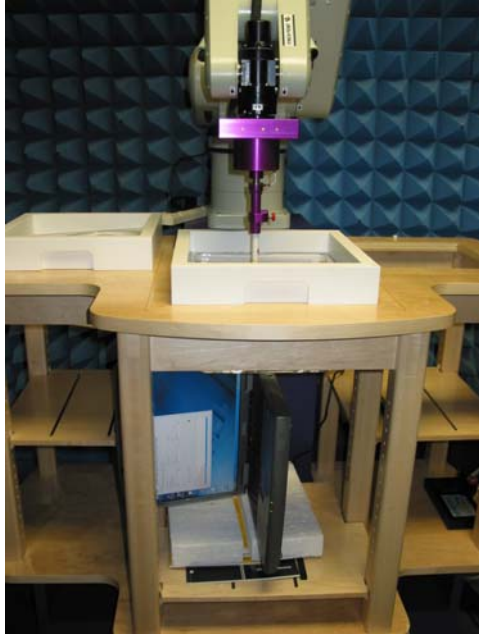

Power	16.5db 802.11b
DUT Position	Right hand side near LCD
Separation	0mm
Antenna Type	Internal
Antenna Manufacturer	WNC
Antenna Location	Right hand side towards LCD
Power Mode	Mains A/C
Tx Frequency	2412-2462MHz
Duty Cycle	100%
Epsilon	52.46
Sigma	2.02
Tissue Depth	15cm
Phantom Type	Universal
DUT Workstation Location	Centre
Device Positioner	HESET1
Test Date	16-02-04
Test Engineer	E. Payapaya

Mode	Channel	Frequency MHz	1g SAR W/kg
801.11b	1	2412	0.74
802.11b	6	2437	1.02
802.11b	12	2462	0.99

SAR Limit	Conservative Measured SAR
1.6 W/kg 1gram Average Maximum	1.02 W/kg 1gram Average

SAR Plot for Conservative SAR Included in Appendix A.

DELL Abacus PP08I
Intel PRO/Wireless 802.11b Mini-PCI type 3B WLAN Adapter



Power	16.5db 802.11g
DUT Position	Front right hand side near hinge
Separation	0mm
Antenna Type	Internal
Antenna Manufacturer	WNC
Antenna Location	Right hand side towards LCD
Power Mode	Mains A/C
Tx Frequency	2412-2462MHz
Duty Cycle	100%
Epsilon	52.46
Sigma	2.02
Tissue Depth	15cm
Phantom Type	Universal
DUT Workstation Location	Centre
Device Positioner	HESET1
Test Date	16-02-04
Test Engineer	E. Payapaya

Mode	Channel	Frequency MHz	1g SAR W/kg
801.11b	1	2412	0.11
802.11b	6	2437	0.15
802.11b	12	2462	0.15

SAR Limit	Conservative Measured SAR
1.6 W/kg 1gram Average Maximum	0.15 W/kg 1gram Average

SAR Plot for Conservative SAR Included in Appendix A.

7.0 Measurement Uncertainty

SAR measurement uncertainty has been calculated using the uncertainty table below, based on that which is presented in IEEE-1528.

All uncertainty calculations are included in the SAR test report.



Appendix A
SAR Plots

Project number: ITLB-Dell-5001
FCC ID: ID:E2K24CLNS

51 Spectrum Way
Nepean, Ontario
Canada K2R 1E6
© 2004 APREL Laboratories



Page 23 of 23

Tel: (613) 820-2730
Fax: (613) 820-4161
Info@aprel.com
www.aprel.com

SAR Test Report

Operator : 111
 Validation Date : 16-Feb-2004
 Measurement Date : 16-Feb-2004
 Starting Time : 16-Feb-2004 03:19:26 PM
 End Time : 16-Feb-2004 03:24:10 PM
 Scanning Time : 284 secs

Product Data
 Device Name : Dell_abacus_WNC_RSide_Close
 Serial No. : CH-0W0941-12961-3A3-4424
 Type : Other
 Model : WNC
 Frequency : 2437.00 MHz
 Max. Transmit Pwr : 0.05 W
 Drift Time : 0 min(s)
 Length : 200
 Width : 50
 Depth : 20
 Antenna Type : Internal
 Power Drift-Start : 0.48
 Power Drift-Finish : 0.41
 Power Drift : 0.07

Phantom Data
 Name : APREL-Uni
 Type : Uni-Phantom
 Size : 280 x 280 x 200
 Serial No. : Default
 Location : Center
 Description : Test

Tissue Data
 Type : Body
 Serial No. : 2004_1
 Frequency : 2450 MHz
 Calibration Date : 02-Dec-2004
 Temperature : 23 °C
 Ambient Temp. : 23 °C
 Humidity : 50 RH%
 Epsilon : 52.46 F/m
 Sigma : 2.02 S/m
 Density : 1000 kg/cu. m

Probe Data
 Name : SAR Probe
 Model : E-020
 Type : E-Field Triangle
 Serial No. : 209
 Calibration Date : 29-Jan-2004
 Frequency : 2450 MHz
 Duty Cycle Factor: 1
 Conversion Factor: 4.1
 Probe Sensitivity: 0.72 0.72 0.72 $\mu\text{V}/(\text{V}/\text{sq. m})$
 Compression Point: 98
 Offset : 1.56



Measurement Data

Crest Factor : 1
Scan Type : Complete
Set-up Date : 16-Feb-2004
Set-up Time : 3:10:45 PM

Other Data

DUT Position : Touch
Separation : 0
Channel : Mid - 2437

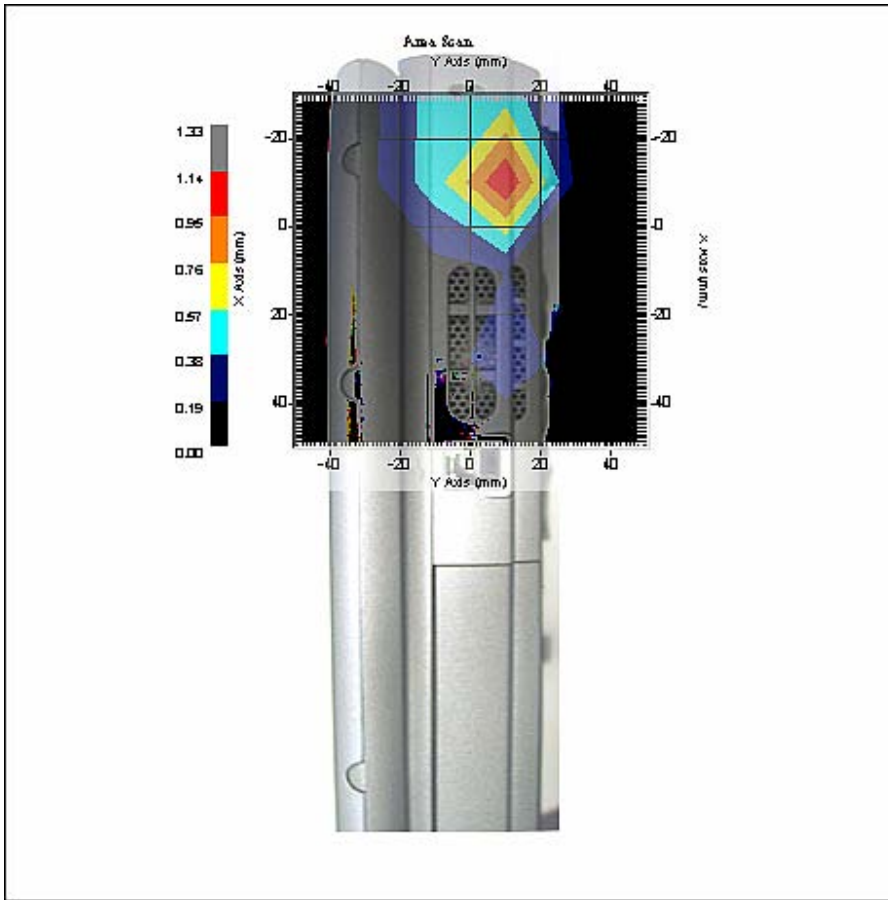

1 gram SAR value : 1.44 W/kg
10 gram SAR value : 0.62 W/kg
Area Scan Peak SAR : 1.14
Zoom Scan Peak SAR : 3.91

Exposure Assessment Measurement Uncertainty

Source of Uncertainty	Tolerance Value	Probability Distribution	Divisor	c_i^1 (1-g)	c_i^1 (10-g)	Standard Uncertainty (1-g)	Standard Uncertainty (10-g)
Measurement System							
Probe Calibration	3.5	normal	1	1	1	3.5	3.5
Axial Isotropy	3.7	rectangular	$\sqrt{3}$	$(1 - \frac{cp}{2})^{1/2}$	$(1 - \frac{cp}{2})^{1/2}$	1.5	1.5
Hemispherical Isotropy	10.9	rectangular	$\sqrt{3}$	\sqrt{cp}	\sqrt{cp}	4.4	4.4
Boundary Effect	1.0	rectangular	$\sqrt{3}$	1	1	0.6	0.6
Linearity	4.7	rectangular	$\sqrt{3}$	1	1	2.7	2.7
Detection Limit	1.0	rectangular	$\sqrt{3}$	1	1	0.6	0.6
Readout Electronics	1.0	normal	1	1	1	1.0	1.0
Response Time	0.8	rectangular	$\sqrt{3}$	1	1	0.5	0.5
Integration Time	1.7	rectangular	$\sqrt{3}$	1	1	1.0	1.0
RF Ambient Condition	3.0	rectangular	$\sqrt{3}$	1	1	1.7	1.7
Probe Positioner Mech.	0.4	rectangular	$\sqrt{3}$	1	1	0.2	0.2
Restriction							
Probe Positioning with respect to Phantom Shell	2.9	rectangular	$\sqrt{3}$	1	1	2.1	2.1
Extrapolation and Integration	3.7	rectangular	$\sqrt{3}$	1	1	2.1	2.1
Test Sample Positioning	4.0	normal	1	1	1	4.0	4.0
Device Holder Uncertainty	2.0	normal	1	1	1	2.0	2.0
Drift of Output Power	0.1	rectangular	$\sqrt{3}$	1	1	0.0	0.0
Phantom and Setup							
Phantom Uncertainty (shape & thickness tolerance)	3.4	rectangular	$\sqrt{3}$	1	1	2.0	2.0
Liquid Conductivity (target)	13.0	rectangular	$\sqrt{3}$	0.7	0.5	5.3	3.8
Liquid Conductivity (meas.)	0.2	rectangular	$\sqrt{3}$	0.7	0.5	0.1	0.1
Liquid Permittivity (target)	2.0	rectangular	$\sqrt{3}$	0.6	0.5	0.8	0.6
Liquid Permittivity (meas.)	5.2	rectangular	$\sqrt{3}$	0.6	0.5	1.8	1.5
Combined Uncertainty		RSS				10.3	9.5
Combined Uncertainty (coverage factor=2)		Normal (k=2)				20.6	19.1

Z-Axis Plot

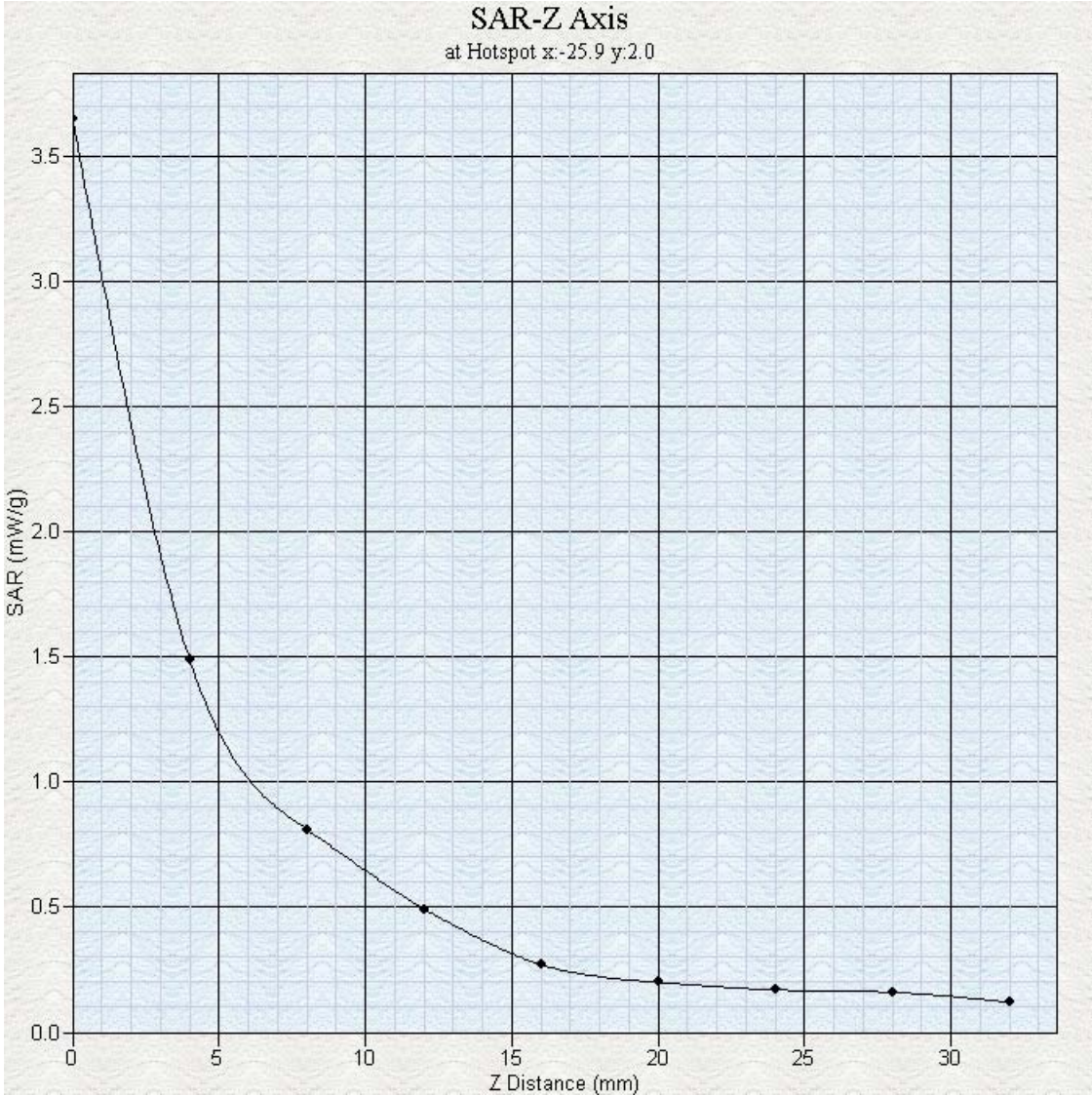

SAR Test Report

Operator : 111
 Validation Date : 16-Feb-2004
 Measurement Date : 16-Feb-2004
 Starting Time : 16-Feb-2004 03:03:45 PM
 End Time : 16-Feb-2004 03:08:28 PM
 Scanning Time : 283 secs

Product Data
 Device Name : Dell_abacus_WNC_RSide_Close
 Serial No. : CH-0W0941-12961-3A3-4424
 Type : Other
 Model : WNC
 Frequency : 2412.00 MHz
 Max. Transmit Pwr : 0.05 W
 Drift Time : 0 min(s)
 Length : 200
 Width : 50
 Depth : 20
 Antenna Type : Internal
 Power Drift-Start : 0.70
 Power Drift-Finish : 0.56
 Power Drift : 0.14

Phantom Data
 Name : APREL-Uni
 Type : Uni-Phantom
 Size : 280 x 280 x 200
 Serial No. : Default
 Location : Center
 Description : Test

Tissue Data
 Type : Body
 Serial No. : 2004_1
 Frequency : 2450 MHz
 Calibration Date : 02-Dec-2004
 Temperature : 23 °C
 Ambient Temp. : 23 °C
 Humidity : 50 RH%
 Epsilon : 52.46 F/m
 Sigma : 2.02 S/m
 Density : 1000 kg/cu. m

Probe Data
 Name : SAR Probe
 Model : E-020
 Type : E-Field Triangle
 Serial No. : 209
 Calibration Date : 29-Jan-2004
 Frequency : 2450 MHz
 Duty Cycle Factor: 1
 Conversion Factor: 4.1
 Probe Sensitivity: 0.72 0.72 0.72 $\mu\text{V}/(\text{V}/\text{sq. m})$
 Compression Point: 98
 Offset : 1.56



Measurement Data

Crest Factor : 1
Scan Type : Complete
Set-up Date : 16-Feb-2004
Set-up Time : 2:56:43 PM

Other Data

DUT Position : Touch
Separation : 0
Channel : Low - 2412

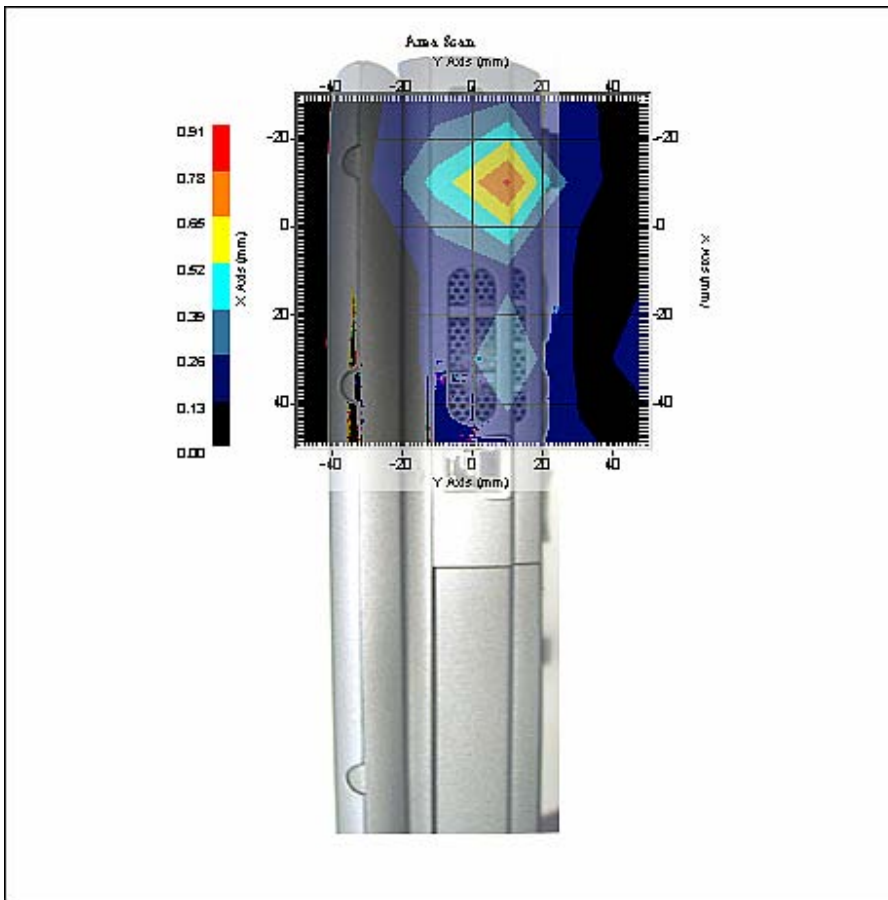

1 gram SAR value : 0.82 W/kg
10 gram SAR value : 0.40 W/kg
Area Scan Peak SAR : 0.80
Zoom Scan Peak SAR : 2.13

Exposure Assessment Measurement Uncertainty

Source of Uncertainty	Tolerance Value	Probability Distribution	Divisor	c_i^1 (1-g)	c_i^1 (10-g)	Standard Uncertainty (1-g)	Standard Uncertainty (10-g)
Measurement System							
Probe Calibration	3.5	normal	1	1	1	3.5	3.5
Axial Isotropy	3.7	rectangular	$\sqrt{3}$	$(\frac{1-cp}{2})^{1/2}$	$(\frac{1-cp}{2})^{1/2}$	1.5	1.5
Hemispherical Isotropy	10.9	rectangular	$\sqrt{3}$	\sqrt{cp}	\sqrt{cp}	4.4	4.4
Boundary Effect	1.0	rectangular	$\sqrt{3}$	1	1	0.6	0.6
Linearity	4.7	rectangular	$\sqrt{3}$	1	1	2.7	2.7
Detection Limit	1.0	rectangular	$\sqrt{3}$	1	1	0.6	0.6
Readout Electronics	1.0	normal	1	1	1	1.0	1.0
Response Time	0.8	rectangular	$\sqrt{3}$	1	1	0.5	0.5
Integration Time	1.7	rectangular	$\sqrt{3}$	1	1	1.0	1.0
RF Ambient Condition	3.0	rectangular	$\sqrt{3}$	1	1	1.7	1.7
Probe Positioner Mech.	0.4	rectangular	$\sqrt{3}$	1	1	0.2	0.2
Restriction							
Probe Positioning with respect to Phantom Shell	2.9	rectangular	$\sqrt{3}$	1	1	2.1	2.1
Extrapolation and Integration	3.7	rectangular	$\sqrt{3}$	1	1	2.1	2.1
Test Sample Positioning	4.0	normal	1	1	1	4.0	4.0
Device Holder Uncertainty	2.0	normal	1	1	1	2.0	2.0
Drift of Output Power	0.1	rectangular	$\sqrt{3}$	1	1	0.1	0.1
Phantom and Setup							
Phantom Uncertainty(shape & thickness tolerance)	3.4	rectangular	$\sqrt{3}$	1	1	2.0	2.0
Liquid Conductivity(target)	13.0	rectangular	$\sqrt{3}$	0.7	0.5	5.3	3.8
Liquid Conductivity(meas.)	0.2	rectangular	$\sqrt{3}$	0.7	0.5	0.1	0.1
Liquid Permittivity(target)	2.0	rectangular	$\sqrt{3}$	0.6	0.5	0.8	0.6
Liquid Permittivity(meas.)	5.2	rectangular	$\sqrt{3}$	0.6	0.5	1.8	1.5
Combined Uncertainty		RSS				10.3	9.5
Combined Uncertainty (coverage factor=2)		Normal (k=2)				20.6	19.1



SAR Test Report

Operator : 111
 Validation Date : 16-Feb-2004
 Measurement Date : 16-Feb-2004
 Starting Time : 16-Feb-2004 03:40:24 PM
 End Time : 16-Feb-2004 03:45:13 PM
 Scanning Time : 289 secs

Product Data
 Device Name : Dell_abacus_WNC_RSide_Close
 Serial No. : CH-0W0941-12961-3A3-4424
 Type : Other
 Model : WNC
 Frequency : 2462.00 MHz
 Max. Transmit Pwr : 0.05 W
 Drift Time : 0 min(s)
 Length : 200
 Width : 50
 Depth : 20
 Antenna Type : Internal
 Power Drift-Start : 0.60
 Power Drift-Finish : 0.90
 Power Drift : 0.30

Phantom Data
 Name : APREL-Uni
 Type : Uni-Phantom
 Size : 280 x 280 x 200
 Serial No. : Default
 Location : Center
 Description : Test

Tissue Data
 Type : Body
 Serial No. : 2004_1
 Frequency : 2450 MHz
 Calibration Date : 02-Dec-2004
 Temperature : 23 °C
 Ambient Temp. : 23 °C
 Humidity : 50 RH%
 Epsilon : 52.46 F/m
 Sigma : 2.02 S/m
 Density : 1000 kg/cu. m

Probe Data
 Name : SAR Probe
 Model : E-020
 Type : E-Field Triangle
 Serial No. : 209
 Calibration Date : 29-Jan-2004
 Frequency : 2450 MHz
 Duty Cycle Factor: 1
 Conversion Factor: 4.1
 Probe Sensitivity: 0.72 0.72 0.72 $\mu\text{V}/(\text{V}/\text{sq. m})$
 Compression Point: 98
 Offset : 1.56



Measurement Data

Crest Factor : 1
Scan Type : Complete
Set-up Date : 16-Feb-2004
Set-up Time : 3:40:17 PM

Other Data

DUT Position : Touch
Separation : 0
Channel : High - 2462

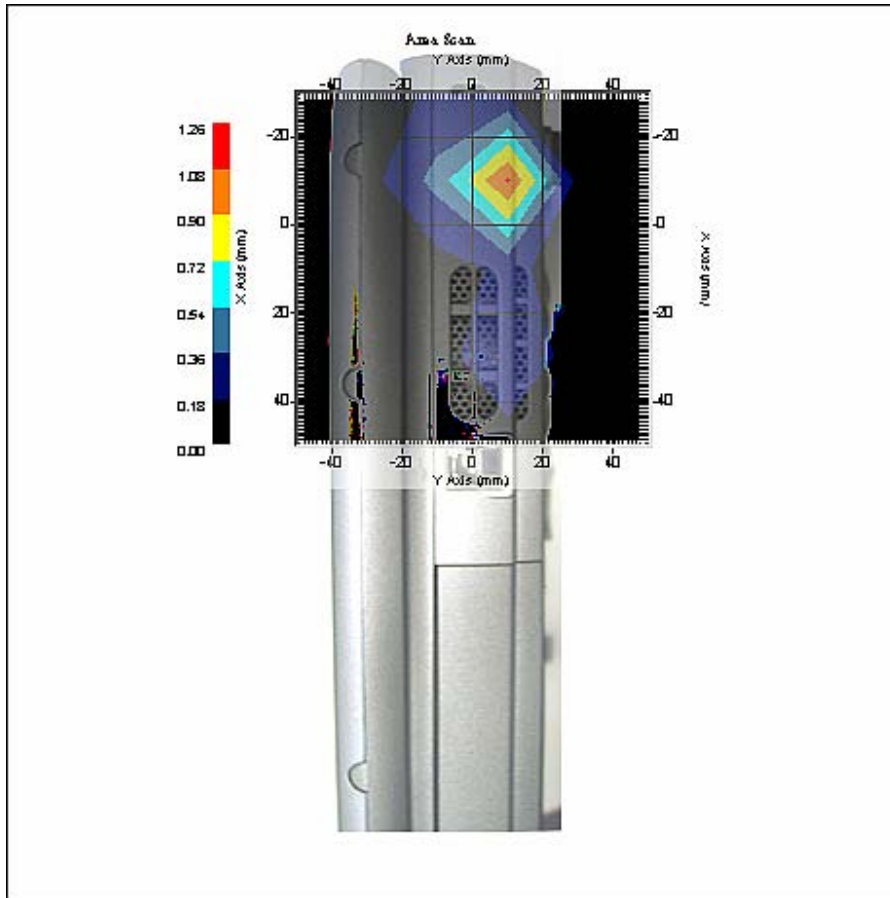

1 gram SAR value : 1.10 W/kg
10 gram SAR value : 0.50 W/kg
Area Scan Peak SAR : 1.10
Zoom Scan Peak SAR : 2.63

Exposure Assessment Measurement Uncertainty

Source of Uncertainty	Tolerance Value	Probability Distribution	Divisor	c_i^1 (1-g)	c_i^1 (10-g)	Standard Uncertainty (1-g)	Standard Uncertainty (10-g)
Measurement System							
Probe Calibration	3.5	normal	1	1	1	3.5	3.5
Axial Isotropy	3.7	rectangular	$\sqrt{3}$	$(1-\frac{cp}{2})^{1/2}$	$(1-\frac{cp}{2})^{1/2}$	1.5	1.5
Hemispherical Isotropy	10.9	rectangular	$\sqrt{3}$	\sqrt{cp}	\sqrt{cp}	4.4	4.4
Boundary Effect	1.0	rectangular	$\sqrt{3}$	1	1	0.6	0.6
Linearity	4.7	rectangular	$\sqrt{3}$	1	1	2.7	2.7
Detection Limit	1.0	rectangular	$\sqrt{3}$	1	1	0.6	0.6
Readout Electronics	1.0	normal	1	1	1	1.0	1.0
Response Time	0.8	rectangular	$\sqrt{3}$	1	1	0.5	0.5
Integration Time	1.7	rectangular	$\sqrt{3}$	1	1	1.0	1.0
RF Ambient Condition	3.0	rectangular	$\sqrt{3}$	1	1	1.7	1.7
Probe Positioner Mech.	0.4	rectangular	$\sqrt{3}$	1	1	0.2	0.2
Restriction							
Probe Positioning with respect to Phantom Shell	2.9	rectangular	$\sqrt{3}$	1	1	2.1	2.1
Extrapolation and Integration	3.7	rectangular	$\sqrt{3}$	1	1	2.1	2.1
Test Sample Positioning	4.0	normal	1	1	1	4.0	4.0
Device Holder Uncertainty	2.0	normal	1	1	1	2.0	2.0
Drift of Output Power	0.3	rectangular	$\sqrt{3}$	1	1	0.2	0.2
Phantom and Setup							
Phantom Uncertainty(shape & thickness tolerance)	3.4	rectangular	$\sqrt{3}$	1	1	2.0	2.0
Liquid Conductivity(target)	13.0	rectangular	$\sqrt{3}$	0.7	0.5	5.3	3.8
Liquid Conductivity(meas.)	0.2	rectangular	$\sqrt{3}$	0.7	0.5	0.1	0.1
Liquid Permittivity(target)	2.0	rectangular	$\sqrt{3}$	0.6	0.5	0.8	0.6
Liquid Permittivity(meas.)	5.2	rectangular	$\sqrt{3}$	0.6	0.5	1.8	1.5
Combined Uncertainty		RSS				10.3	9.5
Combined Uncertainty (coverage factor=2)		Normal (k=2)				20.6	19.1

SAR Test Report

Operator : 111
 Validation Date : 16-Feb-2004
 Measurement Date : 16-Feb-2004
 Starting Time : 16-Feb-2004 02:28:09 PM
 End Time : 16-Feb-2004 02:32:52 PM
 Scanning Time : 283 secs

Product Data
 Device Name : Dell_abacus_WNC_RSide_Open
 Serial No. : CH-0W0941-12961-3A3-4424
 Type : Other
 Model : WNC
 Frequency : 2437.00 MHz
 Max. Transmit Pwr : 0.05 W
 Drift Time : 0 min(s)
 Length : 200
 Width : 60
 Depth : 20
 Antenna Type : Internal
 Power Drift-Start : 0.97
 Power Drift-Finish : 0.76
 Power Drift : 0.21

Phantom Data
 Name : APREL-Uni
 Type : Uni-Phantom
 Size : 280 x 280 x 200
 Serial No. : Default
 Location : Center
 Description : Test

Tissue Data
 Type : Body
 Serial No. : 2004_1
 Frequency : 2450 MHz
 Calibration Date : 02-Dec-2004
 Temperature : 23 °C
 Ambient Temp. : 23 °C
 Humidity : 50 RH%
 Epsilon : 52.46 F/m
 Sigma : 2.02 S/m
 Density : 1000 kg/cu. m

Probe Data
 Name : SAR Probe
 Model : E-020
 Type : E-Field Triangle
 Serial No. : 209
 Calibration Date : 29-Jan-2004
 Frequency : 2450 MHz
 Duty Cycle Factor: 1
 Conversion Factor: 4.1
 Probe Sensitivity: 0.72 0.72 0.72 $\mu\text{V}/(\text{V}/\text{sq. m})$
 Compression Point: 98
 Offset : 1.56



Measurement Data

Crest Factor : 1
Scan Type : Complete
Set-up Date : 16-Feb-2004
Set-up Time : 2:18:14 PM

Other Data

DUT Position : Touch
Separation : 0
Channel : Mid - 2437

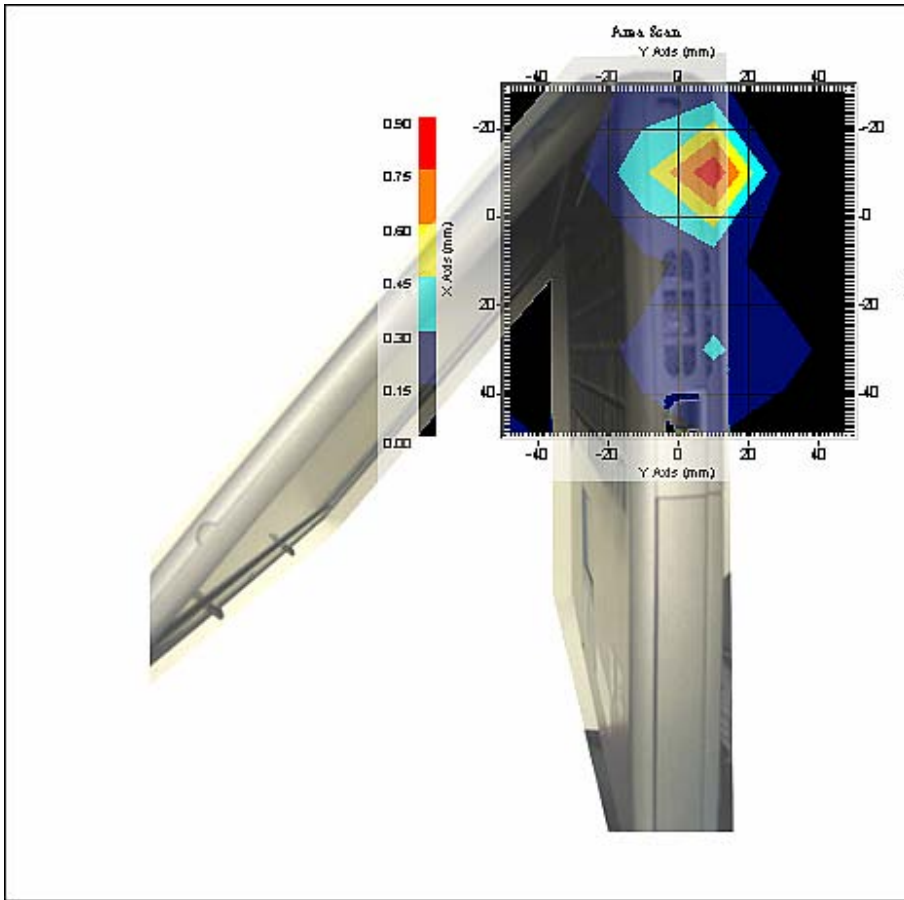

1 gram SAR value : 1.02 W/kg
10 gram SAR value : 0.48 W/kg
Area Scan Peak SAR : 0.87
Zoom Scan Peak SAR : 2.35

Exposure Assessment Measurement Uncertainty

Source of Uncertainty	Tolerance Value	Probability Distribution	Divisor	c_i^{-1} (1-g)	c_i^{-1} (10-g)	Standard Uncertainty (1-g)	Standard Uncertainty (10-g)
Measurement System							
Probe Calibration	3.5	normal	1	1	1	3.5	3.5
Axial Isotropy	3.7	rectangular	$\sqrt{3}$	$(\frac{1-cp}{2})^{1/2}$	$(\frac{1-cp}{2})^{1/2}$	1.5	1.5
Hemispherical Isotropy	10.9	rectangular	$\sqrt{3}$	\sqrt{cp}	\sqrt{cp}	4.4	4.4
Boundary Effect	1.0	rectangular	$\sqrt{3}$	1	1	0.6	0.6
Linearity	4.7	rectangular	$\sqrt{3}$	1	1	2.7	2.7
Detection Limit	1.0	rectangular	$\sqrt{3}$	1	1	0.6	0.6
Readout Electronics	1.0	normal	1	1	1	1.0	1.0
Response Time	0.8	rectangular	$\sqrt{3}$	1	1	0.5	0.5
Integration Time	1.7	rectangular	$\sqrt{3}$	1	1	1.0	1.0
RF Ambient Condition	3.0	rectangular	$\sqrt{3}$	1	1	1.7	1.7
Probe Positioner Mech.	0.4	rectangular	$\sqrt{3}$	1	1	0.2	0.2
Restriction							
Probe Positioning with respect to Phantom Shell	2.9	rectangular	$\sqrt{3}$	1	1	2.1	2.1
Extrapolation and Integration	3.7	rectangular	$\sqrt{3}$	1	1	2.1	2.1
Test Sample Positioning	4.0	normal	1	1	1	4.0	4.0
Device Holder Uncertainty	2.0	normal	1	1	1	2.0	2.0
Drift of Output Power	0.2	rectangular	$\sqrt{3}$	1	1	0.1	0.1
Phantom and Setup							
Phantom Uncertainty(shape & thickness tolerance)	3.4	rectangular	$\sqrt{3}$	1	1	2.0	2.0
Liquid Conductivity(target)	13.0	rectangular	$\sqrt{3}$	0.7	0.5	5.3	3.8
Liquid Conductivity(meas.)	0.2	rectangular	$\sqrt{3}$	0.7	0.5	0.1	0.1
Liquid Permittivity(target)	2.0	rectangular	$\sqrt{3}$	0.6	0.5	0.8	0.6
Liquid Permittivity(meas.)	5.2	rectangular	$\sqrt{3}$	0.6	0.5	1.8	1.5
Combined Uncertainty		RSS				10.3	9.5
Combined Uncertainty (coverage factor=2)		Normal(k=2)				20.6	19.1



SAR Test Report

Operator : 111
 Validation Date : 16-Feb-2004
 Measurement Date : 16-Feb-2004
 Starting Time : 16-Feb-2004 02:10:11 PM
 End Time : 16-Feb-2004 02:14:54 PM
 Scanning Time : 283 secs

Product Data
 Device Name : Dell_abacus_WNC_RSide_Open
 Serial No. : CH-0W0941-12961-3A3-4424
 Type : Other
 Model : WNC
 Frequency : 2421.00 MHz
 Max. Transmit Pwr : 0.05 W
 Drift Time : 0 min(s)
 Length : 200
 Width : 60
 Depth : 20
 Antenna Type : Internal
 Power Drift-Start : 0.66
 Power Drift-Finish : 0.54
 Power Drift : 0.12

Phantom Data
 Name : APREL-Uni
 Type : Uni-Phantom
 Size : 280 x 280 x 200
 Serial No. : Default
 Location : Center
 Description : Test

Tissue Data
 Type : Body
 Serial No. : 2004_1
 Frequency : 2450 MHz
 Calibration Date : 02-Dec-2004
 Temperature : 23 °C
 Ambient Temp. : 23 °C
 Humidity : 50 RH%
 Epsilon : 52.46 F/m
 Sigma : 2.02 S/m
 Density : 1000 kg/cu. m

Probe Data
 Name : SAR Probe
 Model : E-020
 Type : E-Field Triangle
 Serial No. : 209
 Calibration Date : 29-Jan-2004
 Frequency : 2450 MHz
 Duty Cycle Factor: 1
 Conversion Factor: 4.1
 Probe Sensitivity: 0.72 0.72 0.72 $\mu\text{V}/(\text{V}/\text{sq. m})$
 Compression Point: 98
 Offset : 1.56



Measurement Data

Crest Factor : 1
Scan Type : Complete
Set-up Date : 16-Feb-2004
Set-up Time : 2:00:46 PM

Other Data

DUT Position : Touch
Separation : 0
Channel : Low - 2412

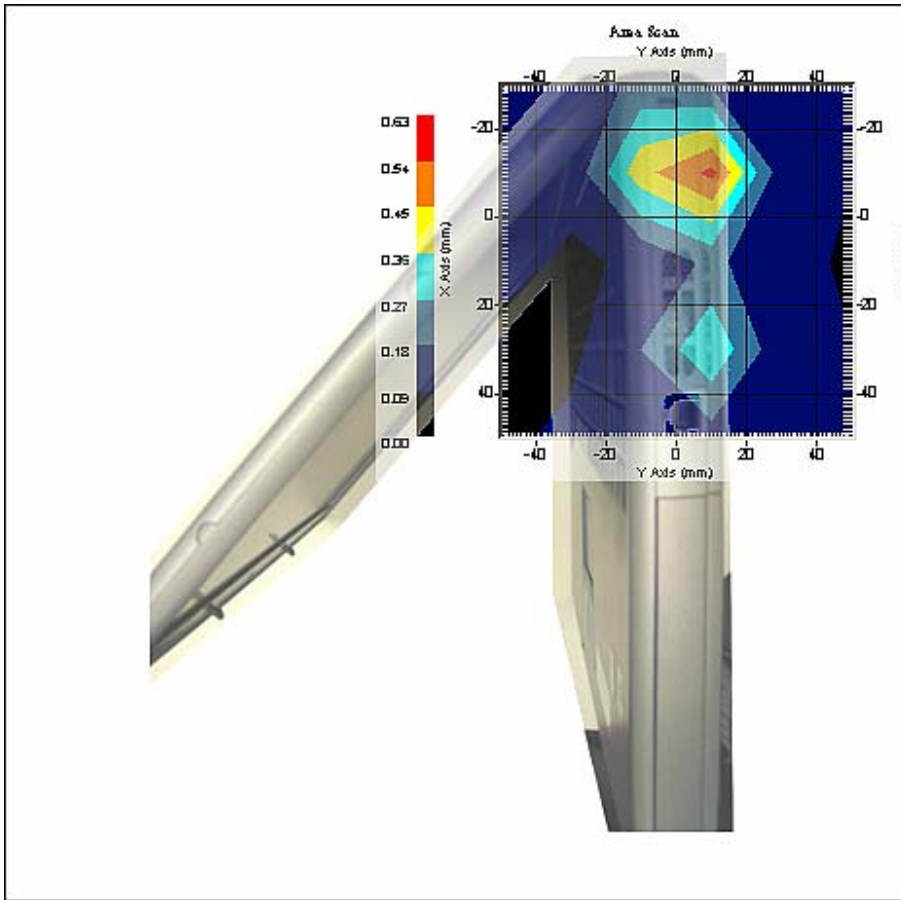

1 gram SAR value : 0.74 W/kg
10 gram SAR value : 0.36 W/kg
Area Scan Peak SAR : 0.56
Zoom Scan Peak SAR : 1.79

Exposure Assessment Measurement Uncertainty

Source of Uncertainty	Tolerance Value	Probability Distribution	Divisor	c_i^1 (1-g)	c_i^1 (10-g)	Standard Uncertainty (1-g)	Standard Uncertainty (10-g)
Measurement System							
Probe Calibration	3.5	normal	1	1	1	3.5	3.5
Axial Isotropy	3.7	rectangular	$\sqrt{3}$	$(1-\frac{cp}{2})^{1/2}$	$(1-\frac{cp}{2})^{1/2}$	1.5	1.5
Hemispherical Isotropy	10.9	rectangular	$\sqrt{3}$	\sqrt{cp}	\sqrt{cp}	4.4	4.4
Boundary Effect	1.0	rectangular	$\sqrt{3}$	1	1	0.6	0.6
Linearity	4.7	rectangular	$\sqrt{3}$	1	1	2.7	2.7
Detection Limit	1.0	rectangular	$\sqrt{3}$	1	1	0.6	0.6
Readout Electronics	1.0	normal	1	1	1	1.0	1.0
Response Time	0.8	rectangular	$\sqrt{3}$	1	1	0.5	0.5
Integration Time	1.7	rectangular	$\sqrt{3}$	1	1	1.0	1.0
RF Ambient Condition	3.0	rectangular	$\sqrt{3}$	1	1	1.7	1.7
Probe Positioner Mech.	0.4	rectangular	$\sqrt{3}$	1	1	0.2	0.2
Restriction							
Probe Positioning with respect to Phantom Shell	2.9	rectangular	$\sqrt{3}$	1	1	2.1	2.1
Extrapolation and Integration	3.7	rectangular	$\sqrt{3}$	1	1	2.1	2.1
Test Sample Positioning	4.0	normal	1	1	1	4.0	4.0
Device Holder Uncertainty	2.0	normal	1	1	1	2.0	2.0
Drift of Output Power	0.1	rectangular	$\sqrt{3}$	1	1	0.1	0.1
Phantom and Setup							
Phantom Uncertainty(shape & thickness tolerance)	3.4	rectangular	$\sqrt{3}$	1	1	2.0	2.0
Liquid Conductivity(target)	13.0	rectangular	$\sqrt{3}$	0.7	0.5	5.3	3.8
Liquid Conductivity(meas.)	0.2	rectangular	$\sqrt{3}$	0.7	0.5	0.1	0.1
Liquid Permittivity(target)	2.0	rectangular	$\sqrt{3}$	0.6	0.5	0.8	0.6
Liquid Permittivity(meas.)	5.2	rectangular	$\sqrt{3}$	0.6	0.5	1.8	1.5
Combined Uncertainty		RSS				10.3	9.5
Combined Uncertainty (coverage factor=2)		Normal (k=2)				20.6	19.1

SAR Test Report

Operator : 111
 Validation Date : 16-Feb-2004
 Measurement Date : 16-Feb-2004
 Starting Time : 16-Feb-2004 02:44:42 PM
 End Time : 16-Feb-2004 02:49:25 PM
 Scanning Time : 283 secs

Product Data
 Device Name : Dell_abacus_WNC_RSide_Open
 Serial No. : CH-0W0941-12961-3A3-4424
 Type : Other
 Model : WNC
 Frequency : 2462.00 MHz
 Max. Transmit Pwr : 0.05 W
 Drift Time : 0 min(s)
 Length : 200
 Width : 60
 Depth : 20
 Antenna Type : Internal
 Power Drift-Start : 1.00
 Power Drift-Finish: 0.74
 Power Drift : 0.26

Phantom Data
 Name : APREL-Uni
 Type : Uni-Phantom
 Size : 280 x 280 x 200
 Serial No. : Default
 Location : Center
 Description : Test

Tissue Data
 Type : Body
 Serial No. : 2004_1
 Frequency : 2450 MHz
 Calibration Date : 02-Dec-2004
 Temperature : 23 °C
 Ambient Temp. : 23 °C
 Humidity : 50 RH%
 Epsilon : 52.46 F/m
 Sigma : 2.02 S/m
 Density : 1000 kg/cu. m

Probe Data
 Name : SAR Probe
 Model : E-020
 Type : E-Field Triangle
 Serial No. : 209
 Calibration Date : 29-Jan-2004
 Frequency : 2450 MHz
 Duty Cycle Factor: 1
 Conversion Factor: 4.1
 Probe Sensitivity: 0.72 0.72 0.72 $\mu\text{V}/(\text{V}/\text{sq. m})$
 Compression Point: 98
 Offset : 1.56



Measurement Data

Crest Factor : 1
Scan Type : Complete
Set-up Date : 16-Feb-2004
Set-up Time : 2:35:17 PM

Other Data

DUT Position : Touch
Separation : 0
Channel : High - 2462

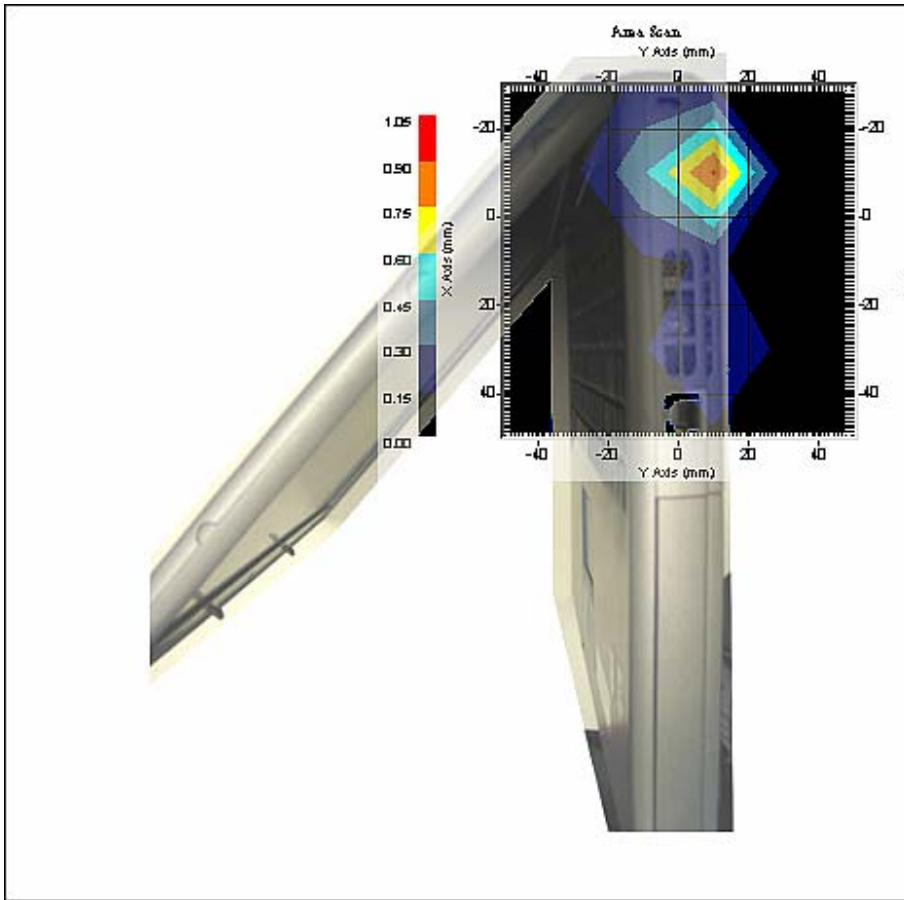

1 gram SAR value : 0.99 W/kg
10 gram SAR value : 0.47 W/kg
Area Scan Peak SAR : 0.92
Zoom Scan Peak SAR : 2.33

Exposure Assessment Measurement Uncertainty

Source of Uncertainty	Tolerance Value	Probability Distribution	Divisor	c_i^1 (1-g)	c_i^1 (10-g)	Standard Uncertainty (1-g)	Standard Uncertainty (10-g)
Measurement System							
Probe Calibration	3.5	normal	1	1	1	3.5	3.5
Axial Isotropy	3.7	rectangular	$\sqrt{3}$	$(1-\frac{cp}{2})^{1/2}$	$(1-\frac{cp}{2})^{1/2}$	1.5	1.5
Hemispherical Isotropy	10.9	rectangular	$\sqrt{3}$	\sqrt{cp}	\sqrt{cp}	4.4	4.4
Boundary Effect	1.0	rectangular	$\sqrt{3}$	1	1	0.6	0.6
Linearity	4.7	rectangular	$\sqrt{3}$	1	1	2.7	2.7
Detection Limit	1.0	rectangular	$\sqrt{3}$	1	1	0.6	0.6
Readout Electronics	1.0	normal	1	1	1	1.0	1.0
Response Time	0.8	rectangular	$\sqrt{3}$	1	1	0.5	0.5
Integration Time	1.7	rectangular	$\sqrt{3}$	1	1	1.0	1.0
RF Ambient Condition	3.0	rectangular	$\sqrt{3}$	1	1	1.7	1.7
Probe Positioner Mech.	0.4	rectangular	$\sqrt{3}$	1	1	0.2	0.2
Restriction							
Probe Positioning with respect to Phantom Shell	2.9	rectangular	$\sqrt{3}$	1	1	2.1	2.1
Extrapolation and Integration	3.7	rectangular	$\sqrt{3}$	1	1	2.1	2.1
Test Sample Positioning	4.0	normal	1	1	1	4.0	4.0
Device Holder Uncertainty	2.0	normal	1	1	1	2.0	2.0
Drift of Output Power	0.3	rectangular	$\sqrt{3}$	1	1	0.2	0.2
Phantom and Setup							
Phantom Uncertainty(shape & thickness tolerance)	3.4	rectangular	$\sqrt{3}$	1	1	2.0	2.0
Liquid Conductivity(target)	13.0	rectangular	$\sqrt{3}$	0.7	0.5	5.3	3.8
Liquid Conductivity(meas.)	0.2	rectangular	$\sqrt{3}$	0.7	0.5	0.1	0.1
Liquid Permittivity(target)	2.0	rectangular	$\sqrt{3}$	0.6	0.5	0.8	0.6
Liquid Permittivity(meas.)	5.2	rectangular	$\sqrt{3}$	0.6	0.5	1.8	1.5
Combined Uncertainty		RSS				10.3	9.5
Combined Uncertainty (coverage factor=2)		Normal (k=2)				20.6	19.1

SAR Test Report

Operator : 111
 Validation Date : 16-Feb-2004
 Measurement Date : 16-Feb-2004
 Starting Time : 16-Feb-2004 04:43:23 PM
 End Time : 16-Feb-2004 04:48:35 PM
 Scanning Time : 312 secs

Product Data
 Device Name : Dell_abacus_WNC_RTop
 Serial No. : CH-0W0941-12961-3A3-4424
 Type : Other
 Model : WNC
 Frequency : 2462.00 MHz
 Max. Transmit Pwr : 0.05 W
 Drift Time : 0 min(s)
 Length : 180
 Width : 150
 Depth : 20
 Antenna Type : Internal
 Power Drift-Start : 0.03
 Power Drift-Finish : 0.06
 Power Drift : 0.03

Phantom Data
 Name : APREL-Uni
 Type : Uni-Phantom
 Size : 280 x 280 x 200
 Serial No. : Default
 Location : Center
 Description : Test

Tissue Data
 Type : Body
 Serial No. : 2004_1
 Frequency : 2450 MHz
 Calibration Date : 02-Dec-2004
 Temperature : 23 °C
 Ambient Temp. : 23 °C
 Humidity : 50 RH%
 Epsilon : 52.46 F/m
 Sigma : 2.02 S/m
 Density : 1000 kg/cu. m

Probe Data
 Name : SAR Probe
 Model : E-020
 Type : E-Field Triangle
 Serial No. : 209
 Calibration Date : 29-Jan-2004
 Frequency : 2450 MHz
 Duty Cycle Factor: 1
 Conversion Factor: 4.1
 Probe Sensitivity: 0.72 0.72 0.72 $\mu\text{V}/(\text{V}/\text{sq. m})$
 Compression Point: 98
 Offset : 1.56



Measurement Data

Crest Factor : 1
Scan Type : Complete
Set-up Date : 16-Feb-2004
Set-up Time : 4:41:28 PM

Other Data

DUT Position : Touch
Separation : 0
Channel : High - 2462

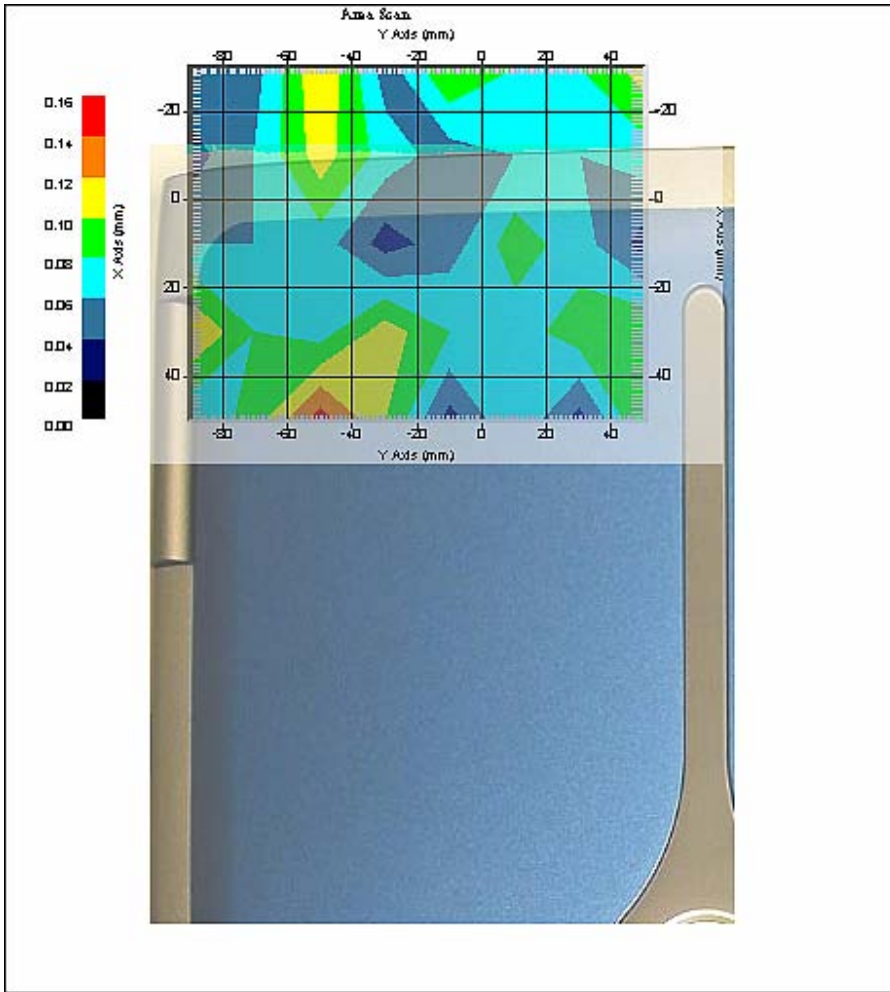

1 gram SAR value : 0.15 W/kg
10 gram SAR value : 0.12 W/kg
Area Scan Peak SAR : 0.15
Zoom Scan Peak SAR : 0.43

Exposure Assessment Measurement Uncertainty

Source of Uncertainty	Tolerance Value	Probability Distribution	Divisor	c_i^1 (1-g)	c_i^1 (10-g)	Standard Uncertainty (1-g)	Standard Uncertainty (10-g)
Measurement System							
Probe Calibration	3.5	normal	1	1	1	3.5	3.5
Axial Isotropy	3.7	rectangular	$\sqrt{3}$	$(1-\frac{cp}{2})^{1/2}$	$(1-\frac{cp}{2})^{1/2}$	1.5	1.5
Hemispherical Isotropy	10.9	rectangular	$\sqrt{3}$	\sqrt{cp}	\sqrt{cp}	4.4	4.4
Boundary Effect	1.0	rectangular	$\sqrt{3}$	1	1	0.6	0.6
Linearity	4.7	rectangular	$\sqrt{3}$	1	1	2.7	2.7
Detection Limit	1.0	rectangular	$\sqrt{3}$	1	1	0.6	0.6
Readout Electronics	1.0	normal	1	1	1	1.0	1.0
Response Time	0.8	rectangular	$\sqrt{3}$	1	1	0.5	0.5
Integration Time	1.7	rectangular	$\sqrt{3}$	1	1	1.0	1.0
RF Ambient Condition	3.0	rectangular	$\sqrt{3}$	1	1	1.7	1.7
Probe Positioner Mech.	0.4	rectangular	$\sqrt{3}$	1	1	0.2	0.2
Restriction							
Probe Positioning with respect to Phantom Shell	2.9	rectangular	$\sqrt{3}$	1	1	2.1	2.1
Extrapolation and Integration	3.7	rectangular	$\sqrt{3}$	1	1	2.1	2.1
Test Sample Positioning	4.0	normal	1	1	1	4.0	4.0
Device Holder Uncertainty	2.0	normal	1	1	1	2.0	2.0
Drift of Output Power	0.0	rectangular	$\sqrt{3}$	1	1	0.0	0.0
Phantom and Setup							
Phantom Uncertainty(shape & thickness tolerance)	3.4	rectangular	$\sqrt{3}$	1	1	2.0	2.0
Liquid Conductivity(target)	13.0	rectangular	$\sqrt{3}$	0.7	0.5	5.3	3.8
Liquid Conductivity(meas.)	0.2	rectangular	$\sqrt{3}$	0.7	0.5	0.1	0.1
Liquid Permittivity(target)	2.0	rectangular	$\sqrt{3}$	0.6	0.5	0.8	0.6
Liquid Permittivity(meas.)	5.2	rectangular	$\sqrt{3}$	0.6	0.5	1.8	1.5
Combined Uncertainty		RSS				10.3	9.5
Combined Uncertainty (coverage factor=2)		Normal (k=2)				20.6	19.1

SAR Test Report

Operator : 111
 Validation Date : 16-Feb-2004
 Measurement Date : 16-Feb-2004
 Starting Time : 16-Feb-2004 05:12:10 PM
 End Time : 16-Feb-2004 05:17:22 PM
 Scanning Time : 312 secs

Product Data
 Device Name : Dell_abacus_WNC_RTop
 Serial No. : CH-0W0941-12961-3A3-4424
 Type : Other
 Model : WNC
 Frequency : 2412.00 MHz
 Max. Transmit Pwr : 0.05 W
 Drift Time : 0 min(s)
 Length : 180
 Width : 150
 Depth : 20
 Antenna Type : Internal
 Power Drift-Start : 0.02
 Power Drift-Finish : 0.05
 Power Drift : 0.03

Phantom Data
 Name : APREL-Uni
 Type : Uni-Phantom
 Size : 280 x 280 x 200
 Serial No. : Default
 Location : Center
 Description : Test

Tissue Data
 Type : Body
 Serial No. : 2004_1
 Frequency : 2450 MHz
 Calibration Date : 02-Dec-2004
 Temperature : 23 °C
 Ambient Temp. : 23 °C
 Humidity : 50 RH%
 Epsilon : 52.46 F/m
 Sigma : 2.02 S/m
 Density : 1000 kg/cu. m

Probe Data
 Name : SAR Probe
 Model : E-020
 Type : E-Field Triangle
 Serial No. : 209
 Calibration Date : 29-Jan-2004
 Frequency : 2450 MHz
 Duty Cycle Factor: 1
 Conversion Factor: 4.1
 Probe Sensitivity: 0.72 0.72 0.72 $\mu\text{V}/(\text{V}/\text{sq. m})$
 Compression Point: 98
 Offset : 1.56



Measurement Data

Crest Factor : 1
Scan Type : Complete
Set-up Date : 16-Feb-2004
Set-up Time : 5:10:09 PM

Other Data

DUT Position : Touch
Separation : 0
Channel : Low - 2412

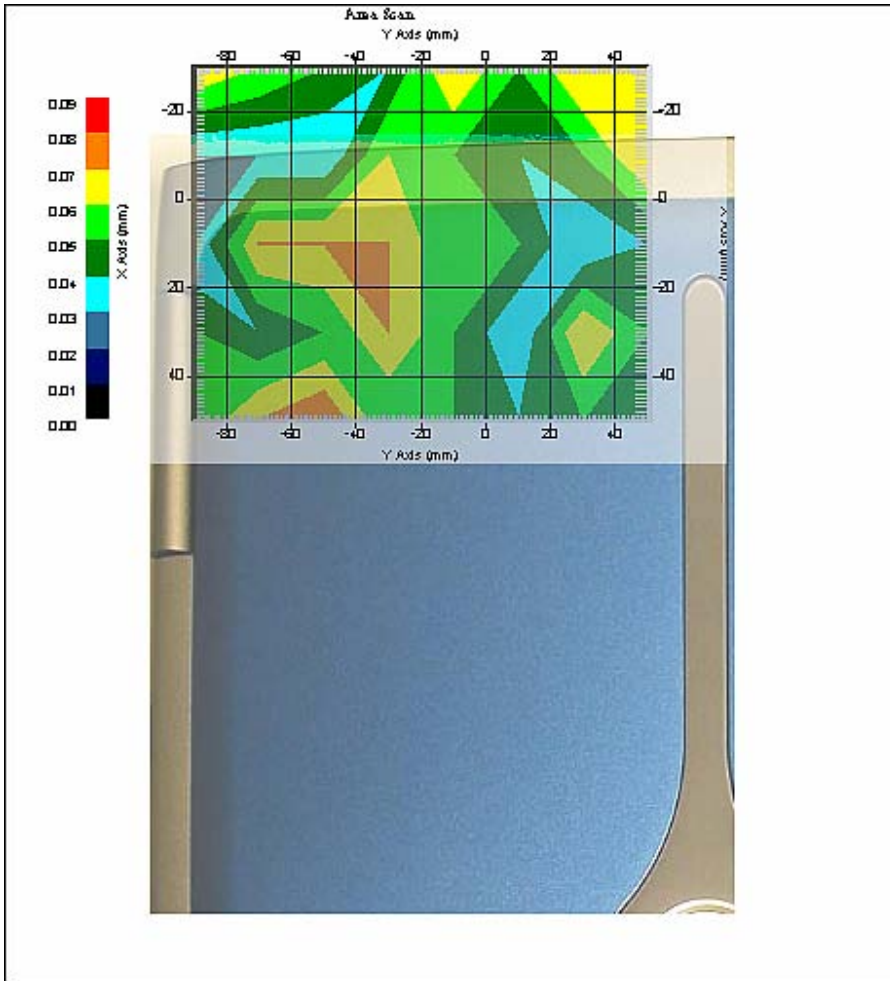

1 gram SAR value : 0.11 W/kg
10 gram SAR value : 0.09 W/kg
Area Scan Peak SAR : 0.08
Zoom Scan Peak SAR : 0.29



Exposure Assessment Measurement Uncertainty

Source of Uncertainty	Tolerance Value	Probability Distribution	Divisor	c_i^1 (1-g)	c_i^1 (10-g)	Standard Uncertainty (1-g)	Standard Uncertainty (10-g)
Measurement System							
Probe Calibration	3.5	normal	1	1	1	3.5	3.5
Axial Isotropy	3.7	rectangular	$\sqrt{3}$	$(1-\frac{cp}{2})^{1/2}$	$(1-\frac{cp}{2})^{1/2}$	1.5	1.5
Hemispherical Isotropy	10.9	rectangular	$\sqrt{3}$	\sqrt{cp}	\sqrt{cp}	4.4	4.4
Boundary Effect	1.0	rectangular	$\sqrt{3}$	1	1	0.6	0.6
Linearity	4.7	rectangular	$\sqrt{3}$	1	1	2.7	2.7
Detection Limit	1.0	rectangular	$\sqrt{3}$	1	1	0.6	0.6
Readout Electronics	1.0	normal	1	1	1	1.0	1.0
Response Time	0.8	rectangular	$\sqrt{3}$	1	1	0.5	0.5
Integration Time	1.7	rectangular	$\sqrt{3}$	1	1	1.0	1.0
RF Ambient Condition	3.0	rectangular	$\sqrt{3}$	1	1	1.7	1.7
Probe Positioner Mech.	0.4	rectangular	$\sqrt{3}$	1	1	0.2	0.2
Restriction							
Probe Positioning with respect to Phantom Shell	2.9	rectangular	$\sqrt{3}$	1	1	2.1	2.1
Extrapolation and Integration	3.7	rectangular	$\sqrt{3}$	1	1	2.1	2.1
Test Sample Positioning	4.0	normal	1	1	1	4.0	4.0
Device Holder Uncertainty	2.0	normal	1	1	1	2.0	2.0
Drift of Output Power	0.0	rectangular	$\sqrt{3}$	1	1	0.0	0.0
Phantom and Setup							
Phantom Uncertainty(shape & thickness tolerance)	3.4	rectangular	$\sqrt{3}$	1	1	2.0	2.0
Liquid Conductivity(target)	13.0	rectangular	$\sqrt{3}$	0.7	0.5	5.3	3.8
Liquid Conductivity(meas.)	0.2	rectangular	$\sqrt{3}$	0.7	0.5	0.1	0.1
Liquid Permittivity(target)	2.0	rectangular	$\sqrt{3}$	0.6	0.5	0.8	0.6
Liquid Permittivity(meas.)	5.2	rectangular	$\sqrt{3}$	0.6	0.5	1.8	1.5
Combined Uncertainty		RSS				10.3	9.5
Combined Uncertainty (coverage factor=2)		Normal (k=2)				20.6	19.1

SAR Test Report

Operator : 111
 Validation Date : 16-Feb-2004
 Measurement Date : 16-Feb-2004
 Starting Time : 16-Feb-2004 04:26:18 PM
 End Time : 16-Feb-2004 04:31:36 PM
 Scanning Time : 318 secs

Product Data
 Device Name : Dell_abacus_WNC_RTop
 Serial No. : CH-0W0941-12961-3A3-4424
 Type : Other
 Model : WNC
 Frequency : 2437.00 MHz
 Max. Transmit Pwr : 0.05 W
 Drift Time : 0 min(s)
 Length : 180
 Width : 150
 Depth : 20
 Antenna Type : Internal
 Power Drift-Start : 0.03
 Power Drift-Finish : 0.10
 Power Drift : 0.07

Phantom Data
 Name : APREL-Uni
 Type : Uni-Phantom
 Size : 280 x 280 x 200
 Serial No. : Default
 Location : Center
 Description : Test

Tissue Data
 Type : Body
 Serial No. : 2004_1
 Frequency : 2450 MHz
 Calibration Date : 02-Dec-2004
 Temperature : 23 °C
 Ambient Temp. : 23 °C
 Humidity : 50 RH%
 Epsilon : 52.46 F/m
 Sigma : 2.02 S/m
 Density : 1000 kg/cu. m

Probe Data
 Name : SAR Probe
 Model : E-020
 Type : E-Field Triangle
 Serial No. : 209
 Calibration Date : 29-Jan-2004
 Frequency : 2450 MHz
 Duty Cycle Factor: 1
 Conversion Factor: 4.1
 Probe Sensitivity: 0.72 0.72 0.72 $\mu\text{V}/(\text{V}/\text{sq. m})$
 Compression Point: 98
 Offset : 1.56



Measurement Data

Crest Factor : 1
Scan Type : Complete
Set-up Date : 16-Feb-2004
Set-up Time : 4:26:13 PM

Other Data

DUT Position : Touch
Separation : 0
Channel : Mid - 2437

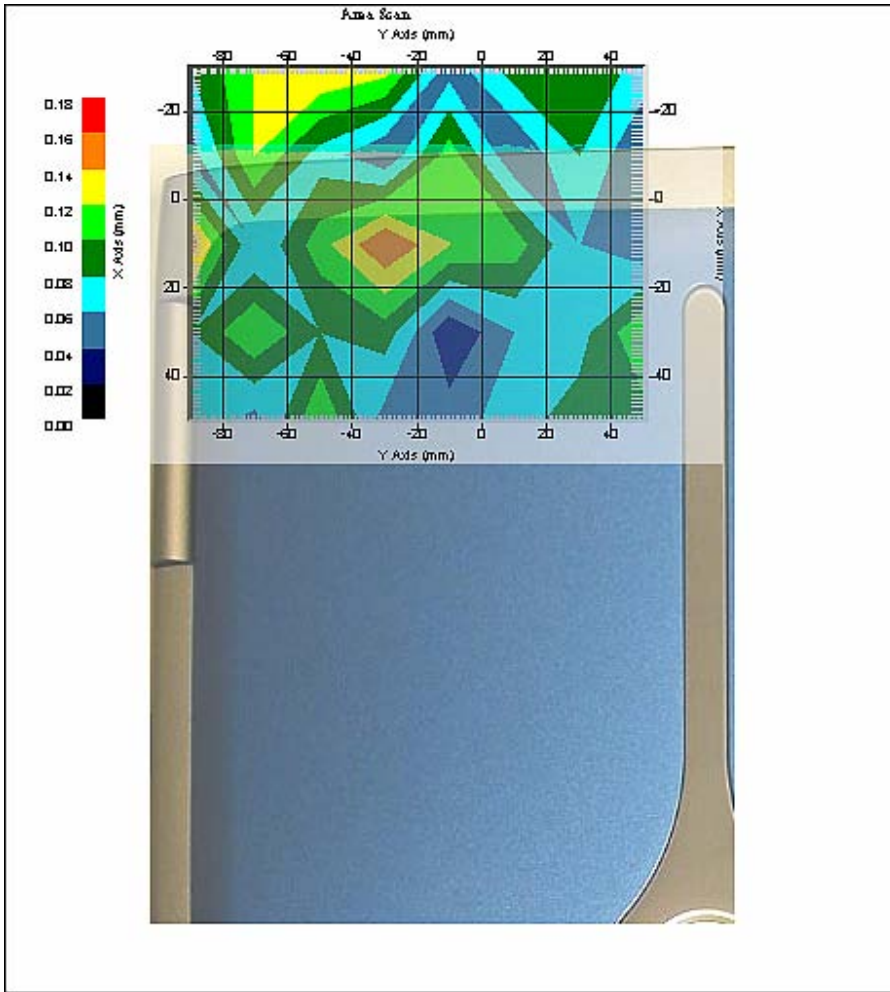

1 gram SAR value : 0.15 W/kg
10 gram SAR value : 0.10 W/kg
Area Scan Peak SAR : 0.16
Zoom Scan Peak SAR : 0.49



Exposure Assessment Measurement Uncertainty

Source of Uncertainty	Tolerance Value	Probability Distribution	Divisor	c_i^1 (1-g)	c_i^1 (10-g)	Standard Uncertainty (1-g)	Standard Uncertainty (10-g)
Measurement System							
Probe Calibration	3.5	normal	1	1	1	3.5	3.5
Axial Isotropy	3.7	rectangular	$\sqrt{3}$	$(1-\frac{cp}{2})^{1/2}$	$(1-\frac{cp}{2})^{1/2}$	1.5	1.5
Hemispherical Isotropy	10.9	rectangular	$\sqrt{3}$	\sqrt{cp}	\sqrt{cp}	4.4	4.4
Boundary Effect	1.0	rectangular	$\sqrt{3}$	1	1	0.6	0.6
Linearity	4.7	rectangular	$\sqrt{3}$	1	1	2.7	2.7
Detection Limit	1.0	rectangular	$\sqrt{3}$	1	1	0.6	0.6
Readout Electronics	1.0	normal	1	1	1	1.0	1.0
Response Time	0.8	rectangular	$\sqrt{3}$	1	1	0.5	0.5
Integration Time	1.7	rectangular	$\sqrt{3}$	1	1	1.0	1.0
RF Ambient Condition	3.0	rectangular	$\sqrt{3}$	1	1	1.7	1.7
Probe Positioner Mech.	0.4	rectangular	$\sqrt{3}$	1	1	0.2	0.2
Restriction							
Probe Positioning with respect to Phantom Shell	2.9	rectangular	$\sqrt{3}$	1	1	2.1	2.1
Extrapolation and Integration	3.7	rectangular	$\sqrt{3}$	1	1	2.1	2.1
Test Sample Positioning	4.0	normal	1	1	1	4.0	4.0
Device Holder Uncertainty	2.0	normal	1	1	1	2.0	2.0
Drift of Output Power	0.1	rectangular	$\sqrt{3}$	1	1	0.0	0.0
Phantom and Setup							
Phantom Uncertainty(shape & thickness tolerance)	3.4	rectangular	$\sqrt{3}$	1	1	2.0	2.0
Liquid Conductivity(target)	13.0	rectangular	$\sqrt{3}$	0.7	0.5	5.3	3.8
Liquid Conductivity(meas.)	0.2	rectangular	$\sqrt{3}$	0.7	0.5	0.1	0.1
Liquid Permittivity(target)	2.0	rectangular	$\sqrt{3}$	0.6	0.5	0.8	0.6
Liquid Permittivity(meas.)	5.2	rectangular	$\sqrt{3}$	0.6	0.5	1.8	1.5
Combined Uncertainty		RSS				10.3	9.5
Combined Uncertainty (coverage factor=2)		Normal (k=2)				20.6	19.1

Appendix B
Probe Calibration Certificate

Project number: ITLB-Dell-5001
FCC ID: ID:E2K24CLNS

51 Spectrum Way
Nepean, Ontario
Canada K2R 1E6
© 2004 APREL Laboratories

AL-065



Page 52 of 52

Tel: (613) 820-2730
Fax: (613) 820-4161
Info@aprel.com
www.aprel.com

This report shall not be reproduced, except in full, without written approval of APREL Laboratories

NCL CALIBRATION LABORATORIES

Calibration File No.: CP-339

Client.: APREL

C E R T I F I C A T E O F C A L I B R A T I O N

It is certified that the equipment identified below has been calibrated in the **NCL CALIBRATION LABORATORIES** by qualified personnel following recognized procedures and using transfer standards traceable to NRC/NIST.

Equipment: Miniature Isotropic RF Probe 2450 MHz

Manufacturer: APREL Laboratories

Model No.: E-020

Serial No.: 209

BODY Calibration

Calibration Procedure: SSI/DRB-TP-D01-032-E020

Project No: Internal

Calibrated: 3rd November 2003

Released on: 4th November 2003

This Calibration Certificate is Incomplete Unless Accompanied with the Calibration Results Summary

Released By: _____

NCL CALIBRATION LABORATORIES

51 SPECTRUM WAY
NEPEAN, ONTARIO
CANADA K2R 1E6

Division of APREL Lab.
TEL: (613) 820-4988
FAX: (613) 820-4161



Introduction

This Calibration Report reproduces the results of the calibration performed in line with the SSI/DRB-TP-D01-032-E020 E-Field Probe Calibration Procedure. The results contained within this report are for APREL E-Field Probe E-020 209.

References

SSI/DRB-TP-D01-032-E020 E-Field Probe Calibration Procedure
IEEE 1528 "Recommended Practice for Determining the Peak Spatial-Average Specific Absorption Rate (SAR) in the Human Body Due to Wireless Communications Devices: Experimental Techniques"
SSI-TP-011 Tissue Calibration Procedure

Conditions

Probe 209 was a new probe taken from stock prior to calibration.

Ambient Temperature of the Laboratory: 22 °C +/- 0.5°C
Temperature of the Tissue: 21 °C +/- 0.5°C

Calibration Results Summary

Probe Type:	E-Field Probe E-020
Serial Number:	209
Frequency:	2450 MHz
Sensor Offset:	1.56 mm
Sensor Length:	2.5 mm
Tip Enclosure:	Ertalyte*
Tip Diameter:	5 mm
Tip Length:	60 mm
Total Length:	290 mm

*Resistive to recommended tissue recipes per IEEE-1528

Sensitivity in Air

Channel X:	0.72 $\mu\text{V}/(\text{V}/\text{m})^2$
Channel Y:	0.72 $\mu\text{V}/(\text{V}/\text{m})^2$
Channel Z:	0.72 $\mu\text{V}/(\text{V}/\text{m})^2$
Diode Compression Point:	98 mV



Sensitivity in Body Tissue

Frequency: 2450 MHz
Epsilon: 50.6 (+/-5%) **Sigma:** 1.98 S/m (+/-10%)

ConvF

Channel X: 4.60
Channel Y: 4.60
Channel Z: 4.60

Tissue sensitivity values were calculated using the load impedance of the APREL Laboratories Daq-Paq.

Boundary Effect:

Uncertainty resulting from the boundary effect is less than 2% for the distance between the tip of the probe and the tissue boundary, when less than 2.4mm.

Spatial Resolution:

The measured probe tip diameter is 5 mm (+/- 0.01 mm) and therefore meets the requirements of SSI/DRB-TP-D01-032 for spatial resolution.



Receiving Pattern 2450 MHz (Air)

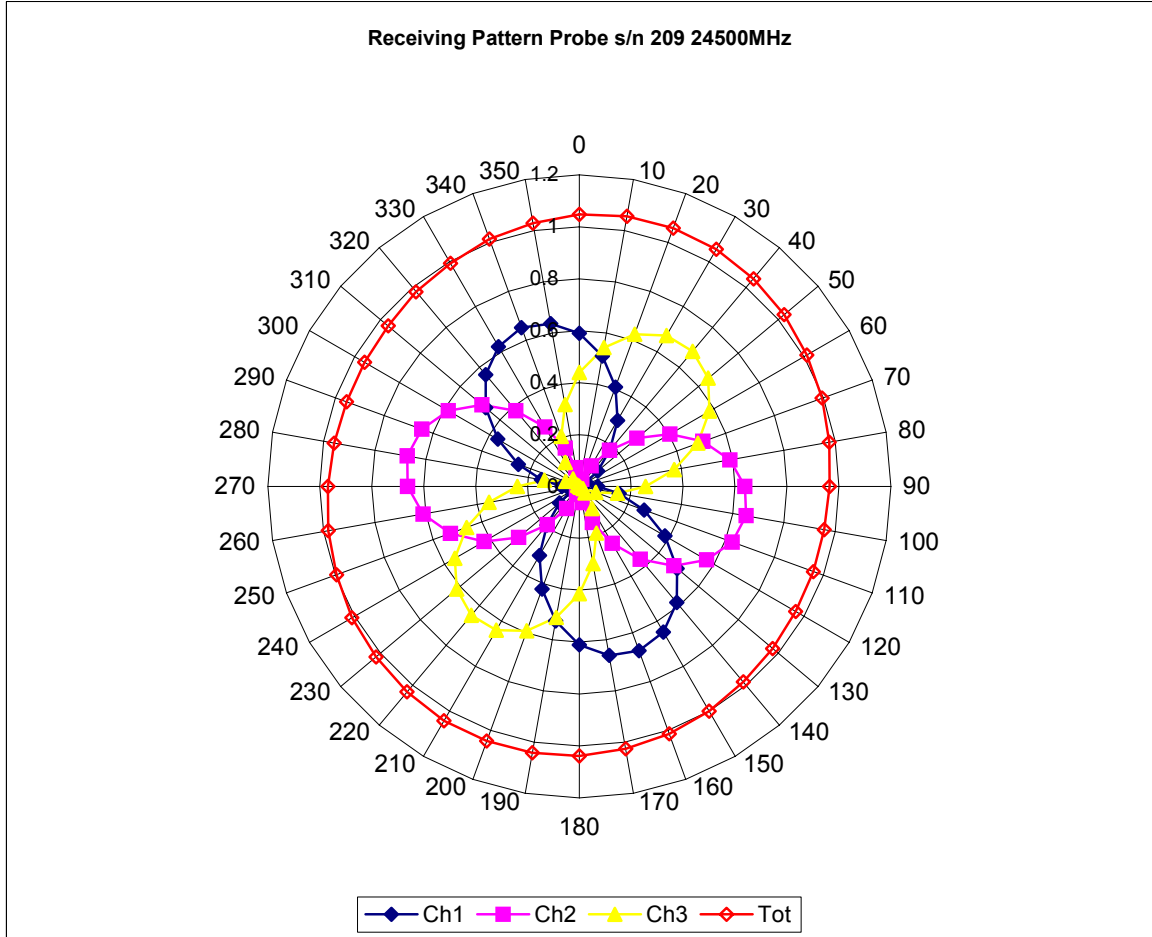

Isotropy Error 2450 MHz (Air)

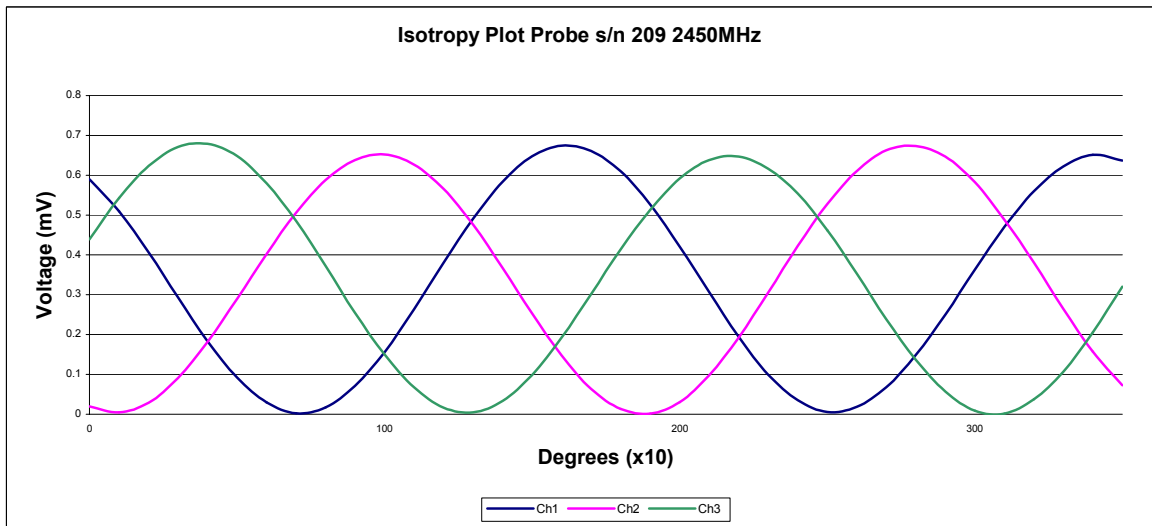
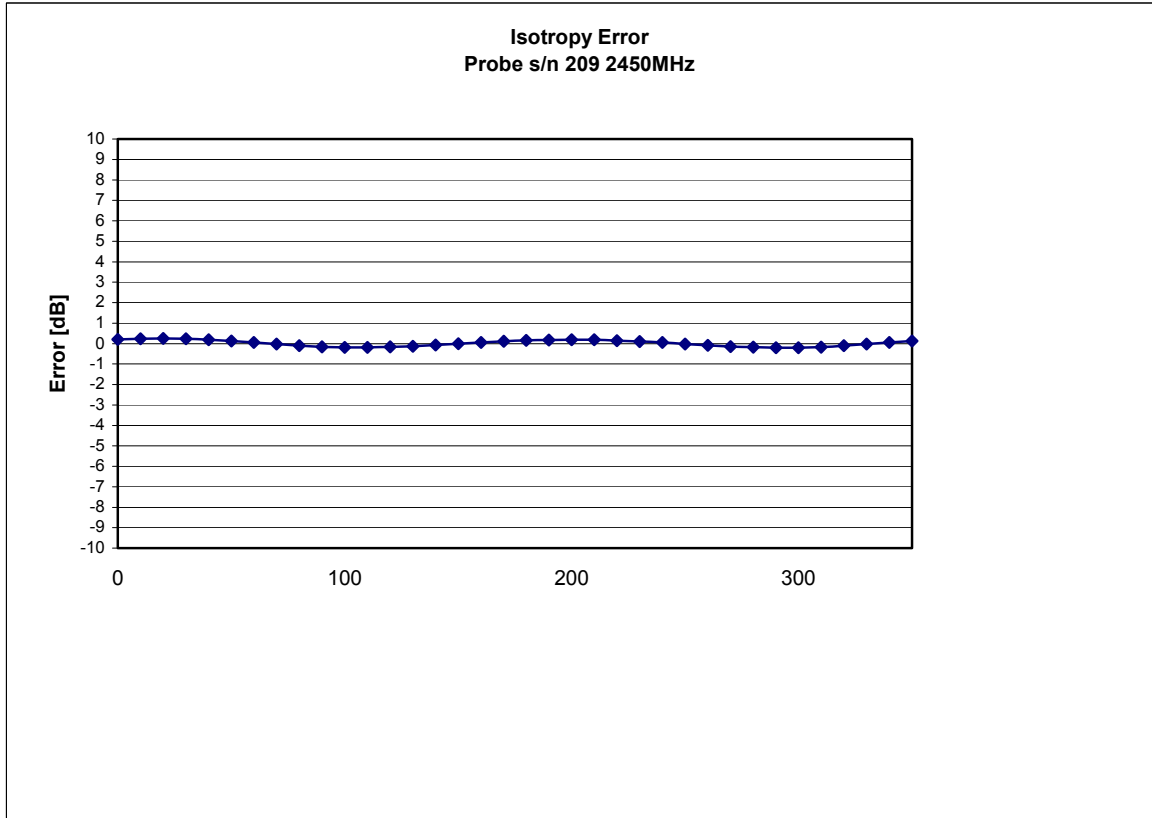

Isotropicity:

0.10 dB



Dynamic Range

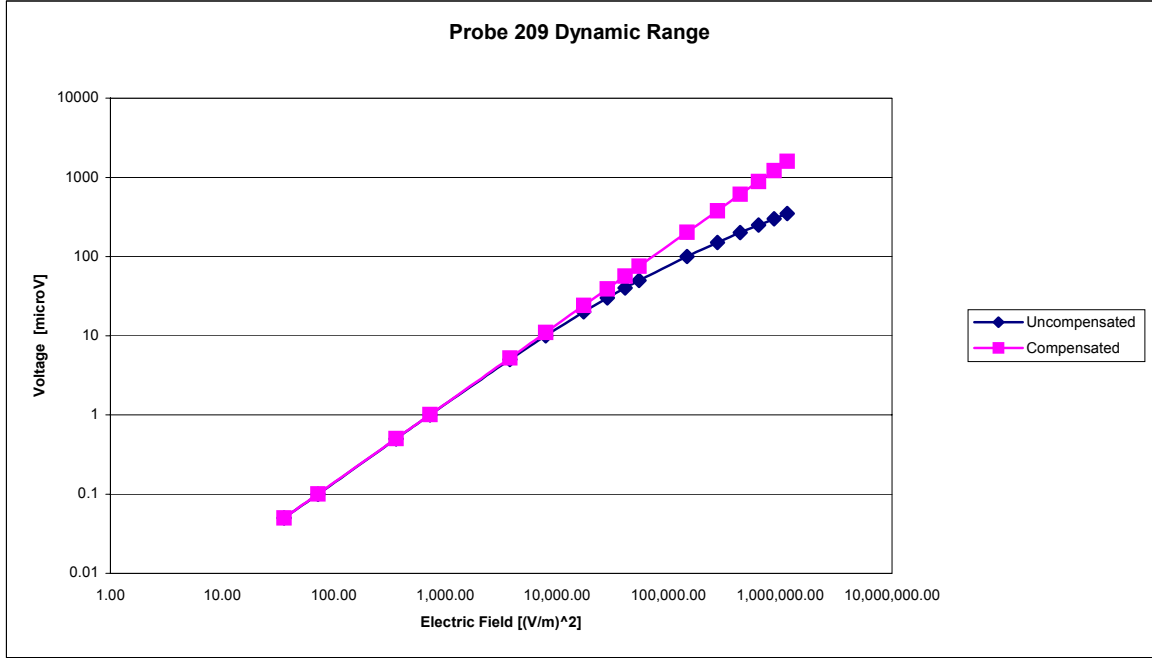

Video Bandwidth

Probe Frequency Characteristics

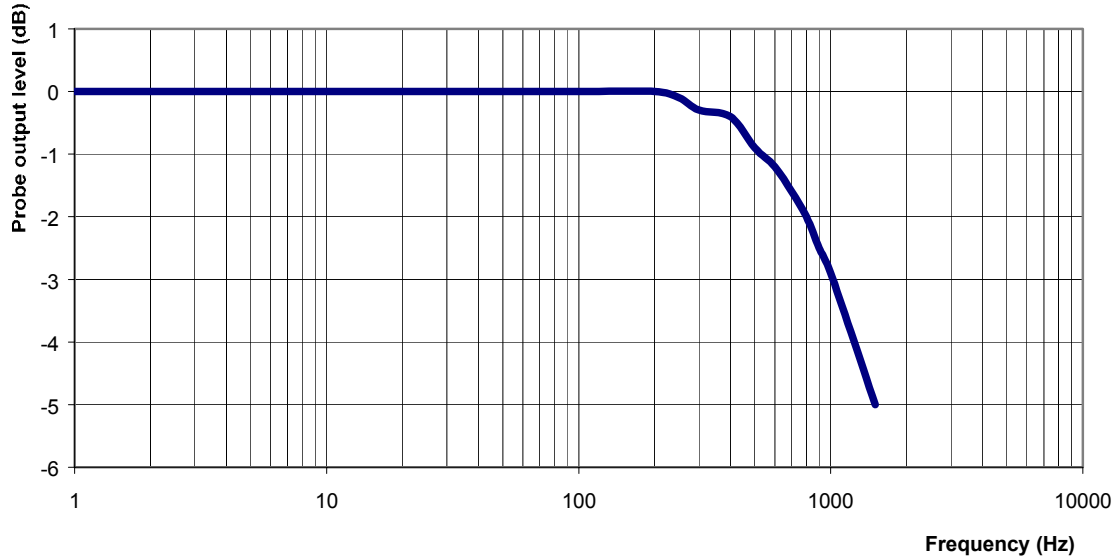

Video Bandwidth at 500 Hz 1 dB
Video Bandwidth at 1.02 KHz: 3 dB



Conversion Factor Uncertainty Assessment

Frequency: 2450MHz

Epsilon: 50.6 (+/-5%)

Sigma: 1.98 S/m (+/-10%)

ConvF

Channel X: 4.60 7%(K=2)

Channel Y: 4.60 7%(K=2)

Channel Z: 4.60 7%(K=2)

To minimize the uncertainty calculation all tissue sensitivity values were calculated using a load impedance of 5 MΩ.

Boundary Effect:

For a distance of 2.4mm the evaluated uncertainty (increase in the probe sensitivity) is less than 2%.

Test Equipment

The test equipment used during Probe Calibration, manufacturer, model number and, current calibration status are listed and located on the main APREL server R:\NCL\Calibration Equipment\Instrument List May 2003.



Appendix C
Dipole Calibration Certificate

Project number: ITLB-Dell-5001
FCC ID: ID:E2K24CLNS

51 Spectrum Way
Nepean, Ontario
Canada K2R 1E6
© 2004 APREL Laboratories



Page 63 of 63

Tel: (613) 820-2730
Fax: (613) 820-4161
Info@aprel.com
www.aprel.com

NCL CALIBRATION LABORATORIES

Calibration File No: DC-0265
Project Number: Internal

C E R T I F I C A T E O F C A L I B R A T I O N

It is certified that the equipment identified below has been calibrated in the **NCL CALIBRATION LABORATORIES** by qualified personnel following recognized procedures and using transfer standards traceable to NRC/NIST.

APREL Validation Dipole

Manufacturer: APREL Laboratories
Part number: D-2450-S-1
Frequency: 2.45 GHz
Serial No: ALCD-10

Customer: APREL

Calibrated: 14 November 2003
Released on: 15 November 2003

Released By: _____

NCL CALIBRATION LABORATORIES

51 SPECTRUM WAY
NEPEAN, ONTARIO
CANADA K2R 1E6

Division of APREL Lab.
TEL: (613) 820-4988
FAX: (613) 820-4161



Calibration Results Summary

The following results relate the Calibrated Dipole and should be used as a quick reference for the user.

Mechanical Dimensions

Length: 51.7 mm
Height: 30.8 mm

Electrical Specification

SWR: 1.181U
Return Loss: -21.4 dB
Impedance: 46.175

System Validation Results

Frequency	1 Gram	10 Gram	Peak
2.45 GHz	52.45	22.91	102.91

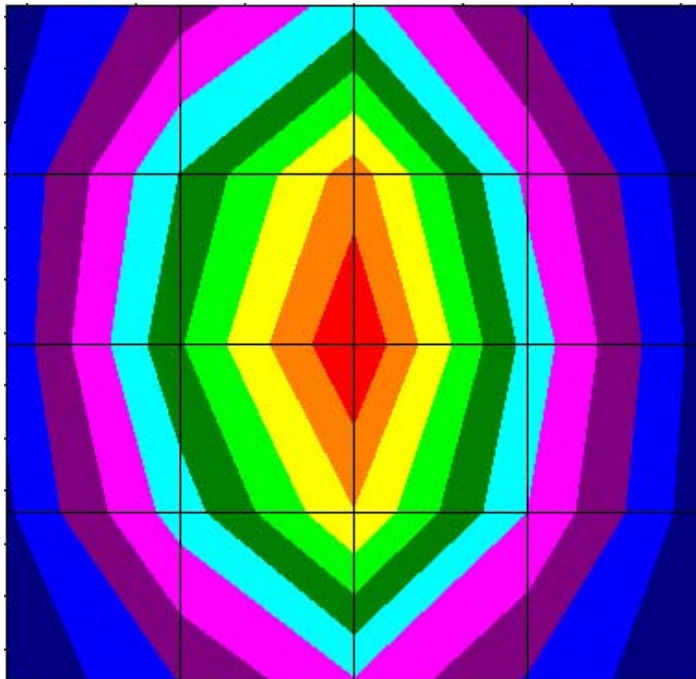

Introduction

This Calibration Report has been produced in line with the SSI Dipole Calibration Procedure SSI-TP-018. The results contained within this report are for Validation Dipole ALCD-10 at 2.45 GHz. The calibration routine consisted of a three-step process. Step 1 was a mechanical verification of the dipole to ensure that it meets the IEEE mechanical specification. Step 2 was an Electrical Calibration for the Validation Dipole, where the SWR, Impedance, and the Return loss were assessed. Step 3 involved a System Validation using the ALIDX-500, along with the APREL Reference E-010 130 MHz to 26 GHz E-Field Probe Serial Number 163.

References

SSI-TP-018 Dipole Calibration Procedure
SSI-TP-016 Tissue Calibration Procedure
IEEE 1528 *DRAFT* "Recommended Practice for Determining the Peak Spatial-Average Specific Absorption Rate (SAR) in the Human Body Due to Wireless Communications Devices: Experimental Techniques"

Conditions

Dipole ALCD-10 was a new Dipole taken from stock prior to calibration.

Ambient Temperature of the Laboratory: 24 °C +/- 0.5°C
Temperature of the Tissue: 20 °C +/- 0.5°C

Dipole Calibration Results

Mechanical Verification

IEEE Length	IEEE Height	Measured Length	Measured Height
51.5 mm	30.4 mm	51.7 mm	30.8 mm

Tissue Validation

Head Tissue 2450 MHz	Measured
Dielectric constant, ϵ_r	39.2
Conductivity, σ [S/m]	1.82
Tissue Conversion Factor,	4.61



Electrical Calibration

Test	Result	IEEE Value
S11 R/L	-21.4	-21 dB
SWR	1.181U	-
Impedance	46.175 Ω	

The Following Graphs are the results as displayed on the Vector Network Analyzer.

S11 Parameter Return Loss

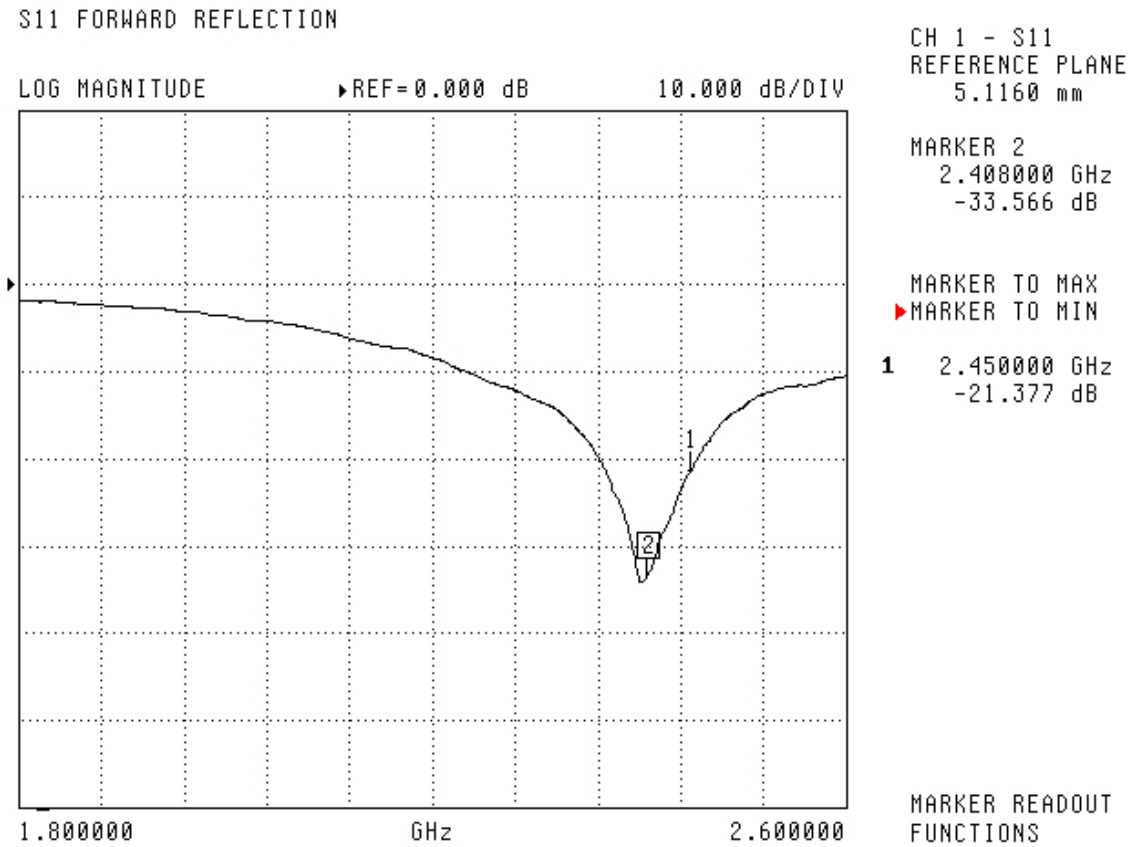

SWR

S11 FORWARD REFLECTION

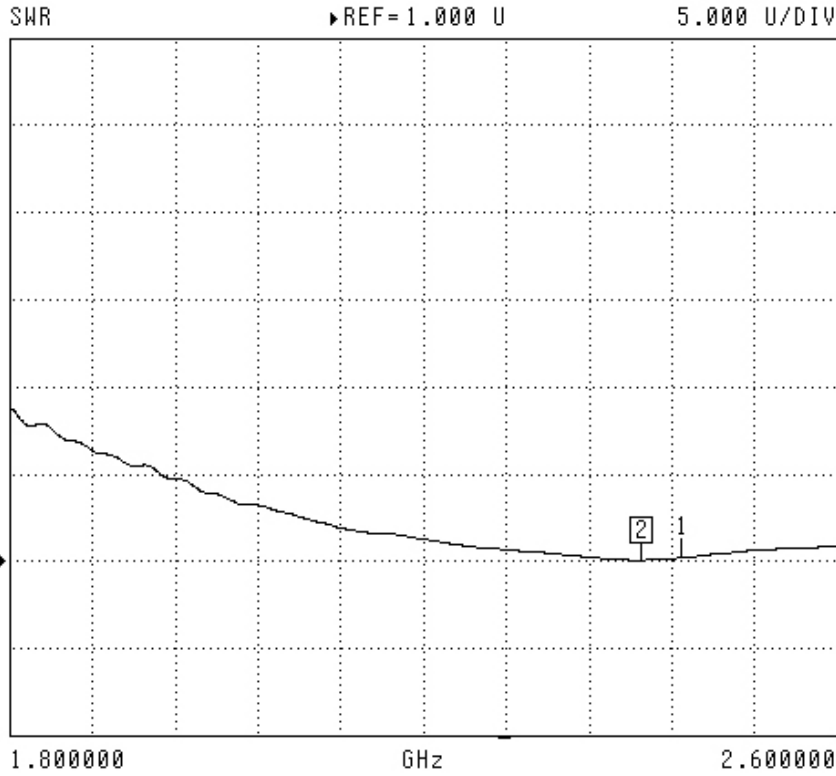

CH 1 - S11
REFERENCE PLANE
5.1160 mm

MARKER 2
2.411000 GHz
1.049 U

MARKER TO MAX
▶ MARKER TO MIN

1 2.450000 GHz
1.181 U

MARKER READOUT
FUNCTIONS



Smith Chart Dipole Impedance

S11 FORWARD REFLECTION
IMPEDANCE

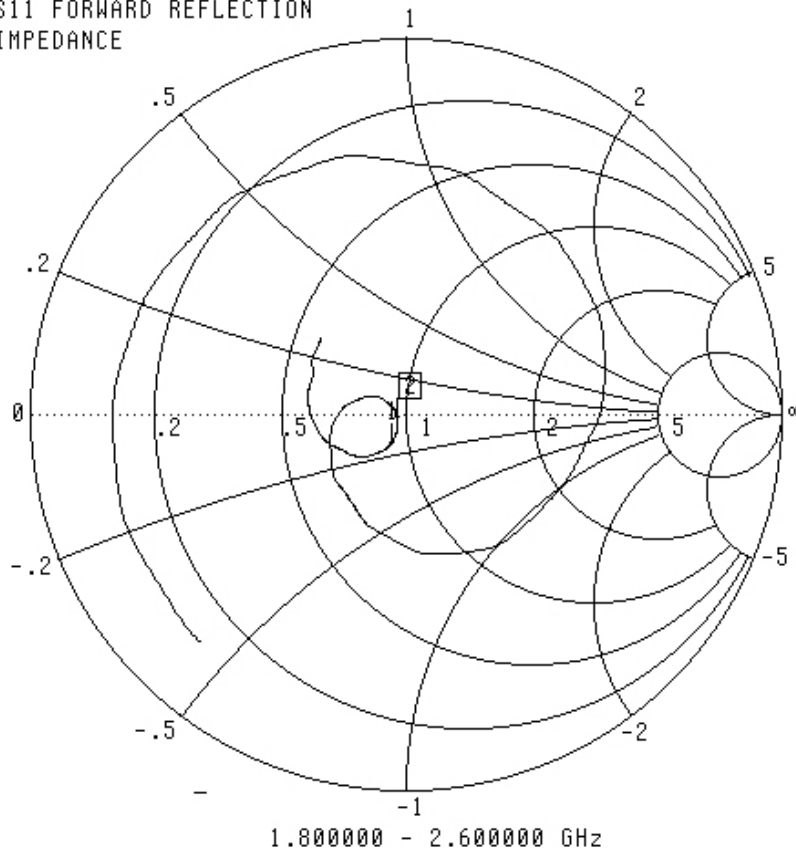

CH 1 - S11
REFERENCE PLANE
5.1160 mm

MARKER 2
2.411000 GHz
48.080 Ω
-1.171 $j\Omega$

MARKER TO MAX
▶ MARKER TO MIN

1 2.450000 GHz
46.175 Ω
-7.199 $j\Omega$

MARKER READOUT
FUNCTIONS

System Validation Results Using the Electrically Calibrated Dipole

Frequency	1 Gram	10 Gram	Peak Above Feed Point
2.45 GHz	52.45	22.91	102.91

The following Graphic Plot is the splined measurement result for the course scan.

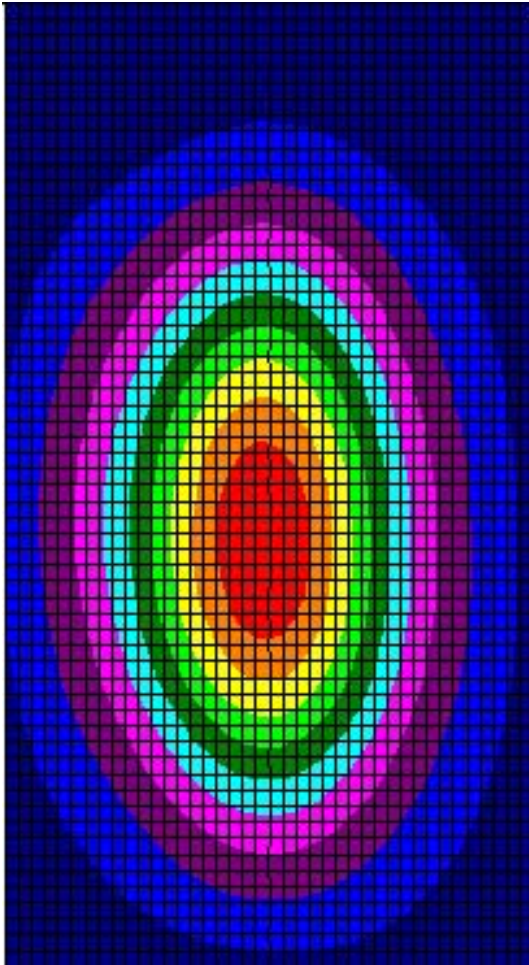

Test Equipment

The test equipment used during Probe Calibration, manufacturer, model number and, current calibration status are listed and located on the main APREL server R:\NCL\Calibration Equipment\Instrument List May 2003

