

Experimental Analysis SAR Report

Subject: **Specific Absorption Rate (SAR) Hand and Body Report**

Product: Dell Laptop

Model: PP10L

Client: Dell Computer Corporation

Applicant: Intel Corporation
Evening Creek Drive,
San Diego CA, 92128

Manufacturer: Dell

Project #: ITLB-Dell PP10L Laptop - 4054

Prepared by: APREL Laboratories
51 Spectrum Way
Nepean, Ontario
K2R 1E6

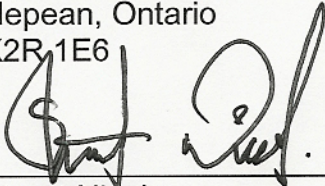
Approved by 
Stuart Nicol
Director Product Development, Dosimetric R&D

Date: 18 SEPTEMBER -03

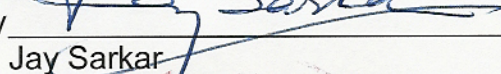
Submitted by 
Jay Sarkar
Technical Director of Standards & Certification

Date: Sept. 18, 2003

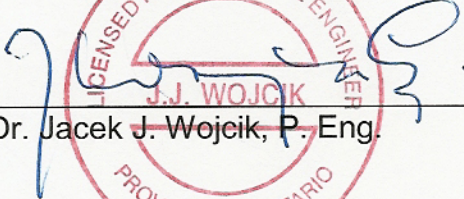
Released by 
Dr. Jacek J. Wojcik, P. Eng.

Date: Sept 18/03

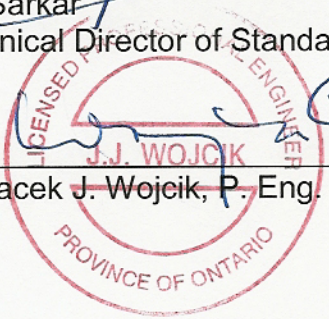

Applicant: Intel Corporation
Manufacturer: Dell Computer Corporation
FCC ID: E2K24CLNS
Equipment: Intel Mini PCI Type 3A 802.11b Wireless LAN Adapter model WM3A2100 located inside the Dell PP10L laptop
Model: Dell PP10L
Serial Number: CRW3800124
Received Status: Production Unit Pre-release
Standard: FCC 96-326, Guidelines for Evaluating the Environmental Effects of Radio-Frequency Radiation

ENGINEERING SUMMARY

This report contains the results of the engineering evaluation performed on the Intel Mini PCI Type 3A 802.11b Wireless LAN Adapter model WM3A2100 located inside the Dell PP10L laptop. The analysis was carried out in accordance with the requirements of FCC 96-326, "Guidelines for Evaluating the Environmental Effects of Radio-Frequency Radiation" in accordance with Supplement C and, using methodologies contained within IEEE 1528. The Intel Mini PCI Type 3A 802.11b Wireless LAN Adapter model WM3A2100 located inside the Dell PP10L laptop was evaluated for compliance to the RF exposure requirements contained in section 2 "Applicable Documents". The Intel Mini PCI Type 3A 802.11b Wireless LAN Adapter model WM3A2100 while located inside the Dell PP10L laptop was assessed for SAR at the **maximum power level set** at 16.5dBm while operating with the **duty cycle set at 100%**.

The Intel Mini PCI Type 3A 802.11b Wireless LAN Adapter model WM3A2100 is located inside the Dell PP10L laptop and utilizes a Mini PCI type A form factor. The Intel Mini PCI Type 3A 802.11b Wireless LAN Adapter model WM3A2100 located inside the Dell PP10L laptop has been assessed for body, bystander, and direct contact SAR.

Intel provided APREL laboratories with one pre-production model of the Dell PP10L laptop. The Dell PP10L laptop can transmit while in normal laptop mode and when the LCD is closed.

The Dell PP10L laptop has an internal set of diverse antennas which are located at the top of the LCD. The main transmitting antenna is located at the **TOP Left hand Side of the LCD**. The antennas are 2.45/5GHz multi band antennas manufactured by Yageo/Phycomp Electronics (China) Co, Ltd.



For the purpose of the SAR analysis executed and subsequent report the Intel Mini PCI Type 3A 802.11b Wireless LAN Adapter model WM3A2100 located inside Dell PP10L laptop will not be labeled as the DUT (Device Under Test). **The DUT is the Dell PP10L laptop.**

The Intel Mini PCI Type 3A 802.11b Wireless LAN Adapter model WM3A2100 located inside the Dell PP10L laptop was evaluated for both body exposure and direct contact SAR (for extremities) at low (ch#1), middle (ch#6) and high (ch#11) for the frequency range of 2412MHz to 2462MHz. Tests were executed at zero mm separation distance, for both direct contact SAR (for extremities) and body SAR analysis.

The conservative 10g average for direct contact SAR for the DUT was found to be **0.40 W/kg for the peak RF output power of the mid channel (ch#6, f=2437MHz)** at the Front side of the DUT with the Laptop closed, with the front side of Laptop facing up against the phantom at 0mm separation. For body SAR analysis the conservative 1 g SAR was found to be **0.99 W/kg for the peak RF output power of the mid channel (ch#6, f=2437MHz)** at the Front side of the DUT with the Laptop closed, with the front side of Laptop facing up against the phantom at 0mm separation.

Evaluation data and graphs are presented in this report. All analysis conducted and documented in this report were performed while the Intel Mini PCI Type 3A 802.11b Wireless LAN Adapter model WM3A2100 was located inside the Dell PP10L laptop.

For the purpose of the SAR assessment the AC power source was used, and the conservative SAR position and frequency for each of the Test Case Scenarios was reassessed using the battery supply. It was found that the conservative SAR presented in this report was measured while using the AC supply.

Based on the measured results and on how the Intel Mini PCI Type 3A 802.11b Wireless LAN Adapter model WM3A2100 while located inside the Dell PP10L laptop will be marketed and used, it is certified that the DUT meets the requirements as set forth in the specifications, for the RF exposure environment contained within this report.

The results presented in this report relate only to the sample evaluated.



TABLE OF CONTENTS

ENGINEERING SUMMARY 2

1. Introduction 5

2. Applicable Documents 5

3. Test Case Scenarios..... 6

4. Test Equipment..... 9

 4.1 E-010 Isotropic E-Field Probe 10

5. SET Up 9

6. Test Results..... 9

 6.1. TRANSMITTER CHARACTERISTICS..... 9

 6.2. SAR MEASUREMENTS 9

 6.3. DIRECT CONTACT SAR..... 9

 6.4. BODY EXPOSURE..... 9

7. Conclusions 9

Appendix A: Graphic Plots FROM SAR Measurements 24

Appendix B: Pictures of the evaluation setup 49

Appendix C: Validation Scan 56

Appendix D: Uncertainty Budget..... 59

Appendix E: Probe Calibration Certificate 60

Appendix F: Dipole Calibration Certificate 71



1. INTRODUCTION

Tests were conducted to determine the Specific Absorption Rate (SAR) for a sample Intel Mini PCI Type 3A 802.11b Wireless LAN Adapter model WM3A2100 located inside the Dell PP10L laptop. These tests were conducted at APREL Laboratories facility located at 51 Spectrum Way, Nepean, Ontario, Canada.

2. APPLICABLE DOCUMENTS

The following documents are applicable to the evaluation performed:

- 1) FCC 96-326, Guidelines for Evaluating the Environmental Effects of Radio-Frequency Radiation
- 2) ANSI/IEEE C95.1-1999, IEEE Standard for Safety Levels with Respect to Human Exposure to Radio Frequency Electromagnetic Fields, 3 kHz to 300 GHz.
- 3) ANSI/IEEE C95.3-1992, IEEE Recommended Practice for the Measurement of Potentially Hazardous Electromagnetic Fields – RF and Microwave.
- 4) OET Bulletin 65 (Edition 97-01) Supplement C (Edition 01-01), “Evaluating Compliance with FCC Guidelines for Human Exposure to Radio Frequency Electromagnetic Fields”.
- 5) IEEE 1528 “Recommended Practice for Determining the Peak Spatial Average Specific Absorption Rate (SAR) in the Human Body Due to Wireless Communication Devices: Experimental Techniques.”



3. Test Case Scenarios

Intel provided APREL Laboratories with a sample Dell PP10L laptop which acts as the host for the Intel Mini PCI Type 3A 802.11b Wireless LAN Adapter model WM3A2100 for the purpose of the SAR evaluation. The evaluations performed on the Intel Mini PCI Type 3A 802.11b Wireless LAN Adapter model WM3A2100 while located inside the Dell PP10L laptop were to establish the conservative SAR value for both 1 and 10g averages while the Mini PCI card was transmitting at the maximum power level set below the amplifier saturation point.

The DUT (device under test) is the Dell PP10L laptop that uses the Intel Mini PCI Type 3A 802.11b Wireless LAN Adapter model WM3A2100.

Device Tested Laptop Configuration



Dell - PP10L

Device Tested Back Side



Dell-PP10L

Device Tested Front Side



Dell-PP10L

Device Tested Left Side



LCD Front Side

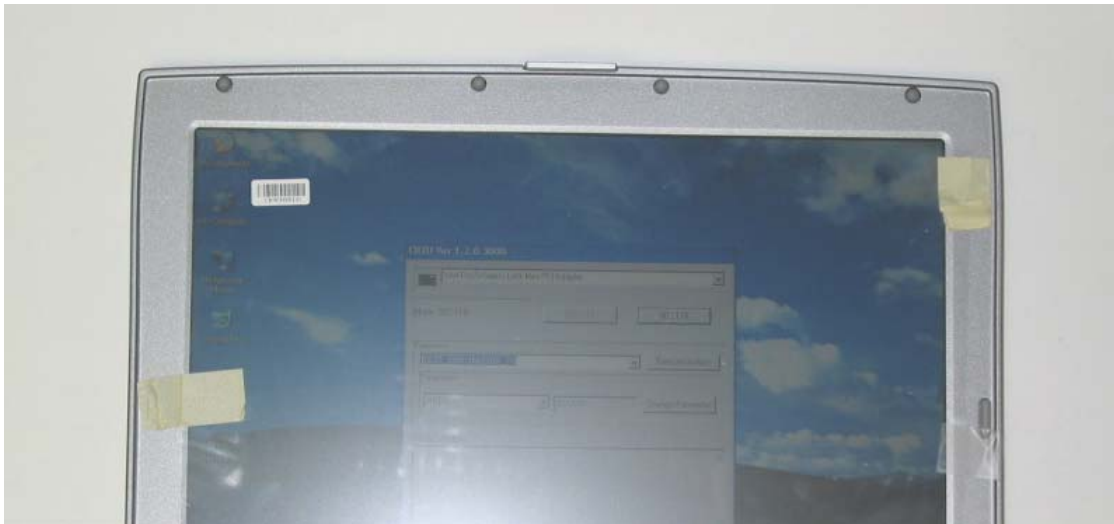

LCD Top Side



4. TEST EQUIPMENT

- APREL Triangular Dosimetric Probe Model E-010, s/n 163
- ALIDX-500 Dosimetric SAR Measurement System
- APREL flat Phantom F1, Part # P-V-G8 (overall shell thickness 2mm)
- APREL 2.45GHz Dipole
- APREL RF Amplifier
- Hewlett Packard Signal Generator Asset
- Rohde & Schwarz RF Power Meter
- Rohde & Schwarz Power Sensor
- Hewlett Packard Dual Directional Coupler

Table 2: Instrumentation

Instrument	Calibration Due	Asset Number/Serial Number
E-010 Probe	May 2004	163
ALIDX-500	March 2004	N/A
APREL Flat Phantom	N/A	APL-001
APREL UniPhantom	N/A	APL-085
APREL 2450MHz Dipole	CBT	N/A
APREL RF Amplifier	CBT	301467
HP-Signal Generator	September 2004	301468
R & S RF Power Meter	October 2003	100851
R & S RF Power Sensor	October 2003	301461
HP Directional Coupler	October 2003	100251

The APREL Laboratories Device Positioner HE-SET is made from a material which is resistant to solvents referenced in the applicable documents section for this report. In the areas where an antenna or main resonating structure could be located the support is provided with a low density material, similar to Styrofoam.



E-010 Isotropic E-Field Probe

The E-field probe used by APREL Laboratories, has been fully calibrated and assessed for isotropicity, and boundary effect. The probe utilizes a triangular sensor arrangement as detailed in the diagram below.

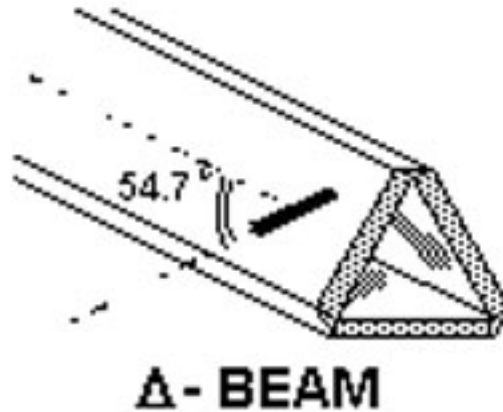

The SAR is assessed with the probe which moves at a default height of 5mm from the centre of the diode, which is mounted to the sensor, to the phantom surface (Z height). The diagram below shows how the centre of the sensor is defined with the location of the diode placed at the centre of the dipole. The 5mm default in the Z axis is the optimum height for assessing SAR where the boundary effect is at it least, with the probe located closest to the phantom surface (boundary).

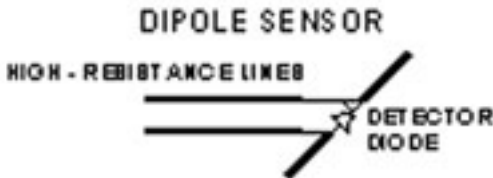

During the cube scan assessment, the probe is positioned in 5 x 8mm steps in both the X, and Y axis, and 7 x 5mm steps for the Z axis. The total size for the physical cube used during the averaging assessment is 32mm x 32mm x 35mm.

5.0 SET UP

5.1 ALIDX-500 Measurement System

The image below shows the laboratory along with the ALIDX-500 Measurement system.



The ALIDX-500 Dosimetric SAR Measurement System was developed jointly with APREL Laboratories and IDX Robotics for use within wireless development and the compliance environment. The system consists of a six axis articulated arm, and controller for precise probe positioning (0.05 mm repeatability). Custom software has been developed to enable communications between the robot controller software and the host operating system.

An amplifier is located on the articulated arm, which is isolated from the custom designed end effector and robot arm. The end effector provides the mechanical touch detection functionality and probe connection interface. The amplifier is functionally validated within the manufacturers site and calibrated at NCL Calibration Laboratories. A Data Acquisition Card (DAC) is used to collect the signal as detected by the isotropic e-field probe. The DAC manufacturer calibrates the DAC to NIST standards. A formal validation is executed using all mechanical and electronic components to prove conformity of the measurement platform as a whole.

The ALIDX-500 has been designed to measure devices within the compliance environment to meet all recognized standards. The system also conforms to standards, which are currently being developed by the scientific and manufacturing community.

The course scan resolution is defined by the operator and reflects the requirements of the standard to which the device is being tested. Precise measurements are made within the predefined course scan area and the values are logged.

The user predefines the sample rate for which the measurements are made so as to ensure that the full duty-cycle of a pulse modulation device is covered during the sample. The following algorithm is an example of the function used by the system for linearization of the output for the probe.

$$V_i = U_i + U_i^2 \cdot \frac{cf}{dcp_i}$$

The APREL E-Field probe is evaluated to establish the diode compression point.

A complex algorithm is then used to calculate the values within the measured points down to a resolution of 1mm. The data from this process is then used to provide the co-ordinates from which the cube scan is created for the determination of the 1 g and 10 g averages.

Cube scan averaging consists of a number of complex algorithms, which are used to calculate the one, and ten gram averages. The basis for the cube scan process is centered on the location where the maximum measured SAR value was found. When a secondary peak value is found which is within 60% of the initial peak value, the system will report this back to the operator who can then assess the need for further analysis of both the peak values prior to the one and ten-gram cube scan averaging process. The algorithm consists of 3D cubic Spline, and Lagrange extrapolation to the surface, which form the matrix for calculating the measurement output for the one and ten gram average values. The resolution for the physical scan integral is user defined with a final calculated resolution down to 1mm.

In-depth analysis for the differential of the physical scanning resolution for the cube scan analysis has been carried out, to identify the optimum setting for the probe positioning steps, and this has been determined at 8mm increments on the X, & Y planes. The reduction of the physical step increment increased the time taken for analysis but did not provide a better uncertainty or return on measured values.

Prior to the measurement process the operator can insert the parameters for which the physical measurements are made, defining the X, Y, and Z probe movement integrals. For the FCC compliance process both OET 65 “Supplement C” and the IEEE 1528 were used to define the measurement parameters used during the assessment of the device.

The final output from the system provides data for the area scan measurements, physical and splined (1mm resolution) cube scan with physical and calculated values (1mm resolution).

The overall uncertainty for the methodology and algorithms the ALIDX500 used during the SAR calculation was evaluated using the data from IEEE 1528 f3 algorithm:

$$f_3(x, y, z) = A \frac{a^2}{\frac{a^2}{4} + x'^2 + y'^2} \cdot \left(e^{-\frac{2z}{a}} + \frac{a^2}{2(a + 2z)^2} \right)$$

The probe used during the measurement process has been assessed to provide values for diode compression. These values are calculated during the probe calibration exercise and are used in the mathematical calculations for the assessment of SAR.



5.2 Validation

A full system validation was run prior to the SAR testing. The methodology used for the system validation was taken from IEEE 1528 section 7 (where applicable). Further details of the tissue used during the system validation are provided in section 6.3 Simulated Tissue. The results from the system validation are provided in Appendix C Validation Results.

The image below shows the setup used for the system validation.

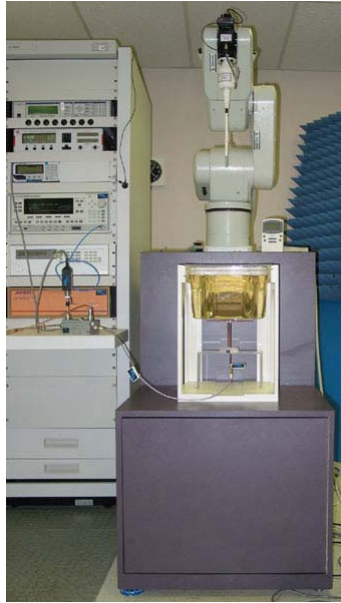

NOTE:

The full analysis of the Device as tested was completed within a 24hr period.

5.3 Body & Bystander Analysis

Measurements were made on the DUT while it was operating in the standard laptop configuration and while the LCD was closed. The device was assessed for both body and direct contact SAR at the low, mid and, high frequency channel settings. A full assessment was made for the device using the laptop configuration, with the top of the LCD, being assessed, along with the DUT being positioned vertically and assessments made on the left and right hand side.

The image below shows part of the setup used for body measurements.

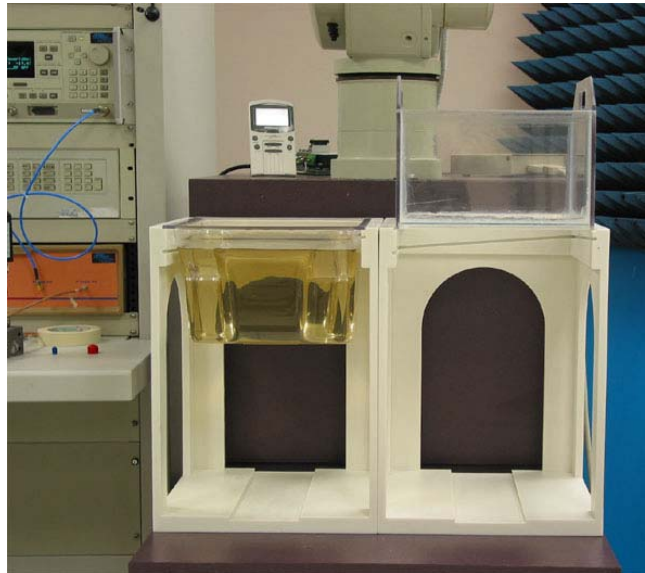

5.4 Simulated Tissue

The recipes used to make the simulated tissue were based on those as presented in OET Supplement C for body at 2450MHz and is provided below in table 3.

Table 3: Ingredients used for tissue

INGREDIENT	2450 MHz
DGBE	26.76 %
Water	73.2 %
Salt	0.04
Dielectric Constant	52.7
Conductivity (S/m)	1.95

The density used to determine SAR from the measurements was the recommended 1.0 kg/m³ found in Appendix C of “Supplement C OET Bulletin 65, Edition 01-01”.

Dielectric parameters of the simulated tissue material were determined using an Anritsu 37347A Vector Network Analyzer, and the APREL Dielectric Probe.

For the system validation the tissue was calibrated at 2450 MHz.

Table 4: Validation executed 9th September 03

BODY Tissue	APREL	Target Value	Δ (%)
Dielectric constant, ϵ_r	50.6	52.7	-4.0
Conductivity, σ [S/m]	2.01	1.95	+3.1

Tissue Conversion Factor,	5.6
Tissue Temperature (°C)	22.0
Ambient Temperature (°C)	23.5

Table 5: Tissue Calibration Instrumentation

Instrument	Calibration Due	Asset Number/Serial Number
Anritsu VNA	CBT	301382
APREL Dielectric Probe	CBT	-

5.5 Methodology

1. The test methodology utilized in the analysis of the Test Case Scenarios complies with the requirements of FCC 96-326 and ANSI/IEEE C95.3-1992.
2. The E-field is measured with a small isotropic probe (output voltage proportional to E^2).

$$SAR = \frac{\sigma |E|^2}{\rho}$$

3. The probe is moved precisely from one point to the next using the robot (10 mm increments for wide area scanning and 8 mm increments for zoom scanning in the X, Y directions) and (5.0 mm increments for the final depth profile measurement in the Z direction).
4. The probe travels in the homogeneous liquid simulating human tissue (body).

Section 5.4 contains information about the properties of the simulated tissue used for these measurements.

5. The liquid is contained in a manikin simulating a portion of the human body with an overall shell thickness of 2 mm.
6. The DUT is positioned with the surface under investigation against the phantom with no separation distance for an initial conservative analysis.
7. All tests were performed with the highest power available from the sample DUT under transmit conditions.

More detailed descriptions of the test method are given in Section 6 where appropriate.

6.0 TEST RESULTS

6.1 TRANSMITTER CHARACTERISTICS

The Intel Pro/Wireless 2100 WLAN Mini-PCI Type 3A Adapter was integrated by Intel. The Intel Pro/Wireless 2100 WLAN Mini-PCI Type 3A Adapter was then set to transmit, using the software, which was supplied by Intel, with a 100% duty cycle (modulated mode).

The Dell PP10L Laptop has been developed to operate with both the AC and, battery cell. The DUT was analyzed and conducted power measurements were made on the Tx output port for the Mini PCI card using both battery and AC supply. The power measurement exercise showed that **no measurable difference could be made** when comparing battery and AC power modes.

The DUT then had the conducted power measured before and after SAR scanning while transmitting using the AC supply. These power measurements were made to assess any measurable drift. Table six contains the results from this exercise.

Note

The power measurements taken were conducted and measured using a power meter, and broadband power sensor.

Table 6: Conducted power measurement before and after the scanning

Type of Exposure	Scan Type Equivalent	Power Readings (dBm)		ΔP_{TX} (dB)
		Before scanning	After scanning	
Direct Contact Exposure	Area	16.5	16.5	0
	Zoom	16.5	16.5	0
Body Exposure	Area	16.5	16.5	0
	Zoom	16.5	16.5	0



6.2 SAR MEASUREMENTS

- 1) RF exposure is expressed as Specific Absorption Rate (SAR). SAR is calculated from the E-field, measured in a grid of test points. SAR is expressed as RF power per kilogram of mass, averaged in 10 grams of tissue for the extremities and 1 gram of tissue elsewhere. The equation below is a representation of how SAR can theoretically equate.

$$SAR = \frac{d}{dt} \left(\frac{dW}{dm} \right) = \frac{d}{dt} \left(\frac{dW}{\rho dV} \right)$$

- 2) The DUT was put into test mode for the SAR measurements via test software supplied by the manufacturer running on the host platform. This control software set the DUT channel and operating TX mode/frequency.
- 3) Table 6, provides the details in tabular form of the full measurement analysis (Test Case Scenarios), which was performed on the DUT. Appendix A provides contour plots of the SAR measurements super imposed on the DUT.
- 4) Zoom scans were performed for the low, middle and high channels of the DUT. These scans were repeated for all the required positions of the DUT. The DUT was operating with maximum output power and a duty cycle of 100%. The DUT was placed up against the phantom during the test process. The phantom shell thickness is 2 mm overall.

6.3 DIRECT CONTACT SAR

All subsequent testing for the direct contact SAR was performed on three channels (low: 2412MHz, middle: 2437MHz, high: 2462MHz) at the normal laptop use position and with the LCD closed. The results are presented in table 7.

- 1) The device had an initial area scan executed to establish the location of the maximum peak SAR. A calculated resolution of 1 mm was used to determine the location for the peak SAR.
- 2) The device was then explored on a refined 32 mm grid (Cube, Zoom Scan) in three dimensions (X, Y & Z) measuring at 8 mm integrals X & Y and 5 mm integrals in the Z plane so as to create a physical measured point matrix. The system then runs a series of complex algorithms, which completes the matrix of calculated and measured values equivalent to a 1 mm resolution in the X, & Y planes.
- 3) The software runs a series of Lagrange functions to provide the data for the Z plane, which is inserted into the matrix.
- 4) To complete the calculated matrix (1 mm resolution) a fourth-order polynomial extrapolation is used to compute the surface values and the 1 and 10-gram averages are then calculated.
- 5) Where two (or more) peaks with similar values are measured the location of the peaks is recorded. A refined grid is then created to assess each peak location individually, and the maximum value from the assessment is used to record conservative SAR for this report.
- 6) The highest conservative SAR value averaged over 10 grams for the direct contact exposure analysis (**DUT Front Side**) was found to be 0.40 W/kg at the mid channel 2437MHz.

6.4 BODY EXPOSURE

All subsequent testing for body exposure SAR was performed on three channels (low: 2412MHz, middle: 2437MHz, high: 2462MHz) at the normal laptop use position and with the LCD closed.

- 1) The device had an initial area scan executed to establish the location of the maximum peak SAR. A calculated resolution of 1mm was used to determine the location for the peak SAR.
- 2) The device was then explored on a refined 32 mm grid (Cube, Fine Scan) in three dimensions (X, Y & Z) measuring at 8 mm integrals X & Y and 5 mm integrals in the Z plane so as to create a physical measured point matrix. The system then runs a series of complex algorithms, which completes the matrix of calculated and measured values equivalent to a 1 mm resolution in the X, & Y planes.
- 3) The software runs a series of Lagrange functions to provide the data for the Z plane, which is inserted into the matrix.
- 4) To complete the calculated matrix (1mm resolution) a fourth order polynomial is used to extrapolate the surface values and the 1 and 10-gram averages are then calculated.
- 5) Where two (or more) peaks with similar values are measured the location of the peaks is recorded. A refined grid is then created to assess each peak location individually, and the maximum value from the assessment is used to record conservative SAR for this report.
- 6) The highest conservative SAR value averaged over 1 gram for body exposure analysis (**DUT Front Side**) was found to be 0.99 W/kg at the mid channel 2437MHz.

Table 7:
Test results
1 g and 10 g SAR values for the Dell PP10L

SAR Type	Position Separation mm	Channel	Channel Number	Freq MHz	1g SAR W/kg	10g SAR W/kg
Direct	Laptop Mode LCD TOP LHS	Low	1	2412	-	0.21
Direct	Laptop Mode LCD TOP LHS	Mid	6	2437	-	0.24
Direct	Laptop Mode LCD TOP LHS	High	11	2462	-	0.23
Body	Laptop Mode LCD TOP LHS	Low	1	2412	0.45	-
Body	Laptop Mode LCD TOP LHS	Mid	6	2437	0.54	-
Body	Laptop Mode LCD TOP LHS	High	11	2462	0.51	-
Direct	Laptop Mode LCD TOP RHS	Mid	6	2437	-	0.03
Body	Laptop Mode LCD TOP RHS	Mid	6	2437	0.09	-
Direct	Laptop Mode LCD Front Side	Mid	6	2437	-	0.06
Body	Laptop Mode LCD Front Side	Mid	6	2437	0.14	-
Direct	DUT Left Side	Mid	6	2437	-	0.04
Body	DUT Left Side	Mid	6	2437	0.12	-
Direct	DUT Front Side	Mid	6	2437	-	0.40
Body	DUT Front Side	Mid	6	2437	0.99	-
Direct	DUT Back Side	Mid	6	2437	-	0.04
Body	DUT Back Side	Mid	6	2437	0.09	-

All Tests Executed 9th September 03



7. CONCLUSIONS

The maximum Specific Absorption Rate (SAR) averaged over 10 grams, was found to be **at the Front Side of DUT**, where the conservative SAR was measured on the **Mid channel 2437MHz at 0.40 W/kg** (direct contact SAR for the exposed extremities – hands, wrists, feet and ankles). The overall margin of uncertainty for this measurement is **±17.8%** (Appendix D).

SAR Limit Direct Contact	Conservative Measured SAR
4.0 W/kg 10 gram Average Maximum	0.40 W/kg 10 gram Average

The maximum Specific Absorption Rate (SAR) averaged over 1 gram, was found to be **at the Front Side of DUT**, where the conservative SAR was measured on the **Mid channel 2437MHz at 0.99 W/kg** (Body SAR). The overall margin of uncertainty for this measurement is **±18.0%** (Appendix D).

SAR Limit Body	Conservative Measured SAR
1.6 W/kg 1 gram Average Maximum	0.99 W/kg 1 gram Average

Considering the above, this unit as tested, and as it will be marketed and used, is found to be compliant with the FCC 96-326 requirements.



Tested by: Y. Chen
Y. Chen

Date: 9th September, 2003

