



# FCC RF Test Report

APPLICANT : Dell Inc.  
EQUIPMENT : Portable Computer  
BRAND NAME : DELL  
MODEL NAME : T14G  
FCC ID : E2K-T14G001  
STANDARD : FCC Part 15 Subpart C §15.247  
CLASSIFICATION : (DTS) Digital Transmission System

The product was received on Nov. 07, 2014 and testing was completed on Nov. 26, 2014. We, SPORTON INTERNATIONAL INC., would like to declare that the tested sample has been evaluated in accordance with the test procedures and has been in compliance with the applicable technical standards.

The test results in this report apply exclusively to the tested model / sample. Without written approval of SPORTON INTERNATIONAL INC., the test report shall not be reproduced except in full.

Reviewed by: Joseph Lin / Supervisor

Approved by: Jones Tsai / Manager



## SPORTON INTERNATIONAL INC.

No. 52, Hwa Ya 1<sup>st</sup> Rd., Hwa Ya Technology Park, Kwei-Shan Hsiang, Tao Yuan Hsien, Taiwan, R.O.C.

SPORTON INTERNATIONAL INC.

TEL : 886-3-327-3456

FAX : 886-3-328-4978

FCC ID : E2K-T14G001

Page Number : 1 of 49

Report Issued Date : Dec. 11, 2014

Report Version : Rev. 01

Report Template No.: BU5-FR15CBT4.0 Version 1.0



# TABLE OF CONTENTS

**REVISION HISTORY..... 3**

**SUMMARY OF TEST RESULT ..... 4**

**1 GENERAL DESCRIPTION..... 5**

    1.1 Applicant ..... 5

    1.2 Manufacturer..... 5

    1.3 Product Feature of Equipment Under Test..... 5

    1.4 Product Specification subjective to this standard ..... 5

    1.5 Modification of EUT ..... 6

    1.6 Testing Location ..... 6

    1.7 Applicable Standards..... 6

**2 TEST CONFIGURATION OF EQUIPMENT UNDER TEST..... 7**

    2.1 Descriptions of Test Mode ..... 7

    2.2 Test Mode..... 8

    2.3 Connection Diagram of Test System..... 9

    2.4 Support Unit used in test configuration and system ..... 10

    2.5 EUT Operation Test Setup ..... 10

    2.6 Measurement Results Explanation Example..... 10

**3 TEST RESULT ..... 11**

    3.1 6dB and 99% Bandwidth Measurement ..... 11

    3.2 Peak Output Power Measurement ..... 16

    3.3 Power Spectral Density Measurement ..... 18

    3.4 Conducted Band Edges and Spurious Emission Measurement ..... 24

    3.5 Radiated Band Edges and Spurious Emission Measurement ..... 33

    3.6 AC Conducted Emission Measurement..... 37

    3.7 Antenna Requirements ..... 47

**4 LIST OF MEASURING EQUIPMENT..... 48**

**5 UNCERTAINTY OF EVALUATION..... 49**

**APPENDIX A. TEST RESULT OF RADIATED TEST RESULTS**

**APPENDIX B. SETUP PHOTOGRAPHS**





### SUMMARY OF TEST RESULT

Report Section	FCC Rule	IC Rule	Description	Limit	Result	Remark
3.1	15.247(a)(2)	RSS-210 A8.2(a)	6dB Bandwidth	≥ 0.5MHz	Pass	-
3.1	-	RSS-Gen 4.6.1	99% Bandwidth	-	Pass	-
3.2	15.247(b)(1)	RSS-210 A8.1(b)	Peak Output Power	≤ 30dBm	Pass	-
3.3	15.247(e)	RSS-210 A8.2(b)	Power Spectral Density	≤ 8dBm/3kHz	Pass	-
3.4	15.247(d)	RSS-210 A8.5	Conducted Band Edges and Spurious Emission	≤ 20dBc	Pass	-
3.5	15.247(d)	RSS-210 A8.5	Radiated Band Edges and Spurious Emission	15.209(a) & 15.247(d)	Pass	Under limit 4.29 dB at 64.02 MHz
3.6	15.207	RSS-Gen 7.2.4	AC Conducted Emission	15.207(a)	Pass	Under limit 6.50 dB at 0.478 MHz
3.7	15.203 & 15.247(b)	RSS-210 A8.4	Antenna Requirement	N/A	Pass	-



# 1 General Description

## 1.1 Applicant

Dell Inc.  
One Dell Way Round Rock, TX 78682, USA

## 1.2 Manufacturer

Dell Inc.  
One Dell Way Round Rock, TX 78682, USA

## 1.3 Product Feature of Equipment Under Test

Product Feature	
Equipment	Portable Computer
Brand Name	DELL
Model Name	T14G
FCC ID	E2K-T14G001
EUT supports Radios application	WLAN 11b/g/n (HT20) WLAN 11a/n (HT20/HT40) Bluetooth v4.0 EDR/LE
HW Version	DVT1 Stage
SW Version	X12
EUT Stage	Production Unit

Remark: The above EUT's information was declared by manufacturer. Please refer to the specifications or user's manual for more detailed description.

## 1.4 Product Specification subjective to this standard

Product Specification subjective to this standard	
Tx/Rx Frequency Range	2402 MHz ~ 2480 MHz
Number of Channels	40
Carrier Frequency of Each Channel	40 Channel(37 hopping + 3 advertising channel)
Maximum Output Power to Antenna	6.71 dBm (0.0047 W)
99% Occupied Bandwidth	1.04MHz
Antenna Type	PIFA Antenna type with gain -0.61 dBi
Type of Modulation	Bluetooth LE : GFSK



### 1.5 Modification of EUT

No modifications are made to the EUT during all test items.

### 1.6 Testing Location

Sporton Lab is accredited to ISO 17025 by Taiwan Accreditation Foundation (TAF code : 1190) and the FCC designation No. TW1022 under the FCC 2.948(e) by Mutual Recognition Agreement (MRA) in FCC Test.

<b>Test Site</b>	SPORTON INTERNATIONAL INC.		
<b>Test Site Location</b>	No. 52, Hwa Ya 1 <sup>st</sup> Rd., Hwa Ya Technology Park, Kwei-Shan Hsiang, Tao Yuan Hsien, Taiwan, R.O.C. TEL: +886-3-327-3456 FAX: +886-3-328-4978		
<b>Test Site No.</b>	<b>Sporton Site No.</b>		
	TH02-HY	CO05-HY	03CH05-HY

### 1.7 Applicable Standards

According to the specifications of the manufacturer, the EUT must comply with the requirements of the following standards:

- FCC Part 15 Subpart C §15.247
- FCC KDB Publication No. 558074 D01 DTS Meas. Guidance v03r02
- ANSI C63.4-2003

**Remark:** All test items were verified and recorded according to the standards and without any deviation during the test.



## 2 Test Configuration of Equipment Under Test

### 2.1 Descriptions of Test Mode

The RF output power was recorded in the following table:

Channel	Frequency	Bluetooth 4.0 – LE RF Output Power	
		Data Rate / Modulation	
		GFSK	
		1Mbps	
Ch00	2402MHz	6.71	dBm
Ch19	2440MHz	5.56	dBm
Ch39	2480MHz	4.66	dBm

- a. The EUT has been associated with peripherals and configuration operated in a manner tended to maximize its emission characteristics in a typical application. Frequency range investigated: conduction (150 kHz to 30 MHz), radiation (9 kHz to the 10th harmonic of the highest fundamental frequency or to 40 GHz, whichever is lower). Pre-scanned tests, X, Y, Z in three orthogonal panels to determine the final configuration (Y plane as worst plane) from all possible combinations.
  
- b. AC power line Conducted Emission was tested under maximum output power.



## 2.2 Test Mode

The following summary table is showing all test modes to demonstrate in compliance with the standard.

Summary table of Test Cases	
Test Item	Data Rate / Modulation
	Bluetooth 4.0 – LE / GFSK
Conducted TCs	Mode 1: Bluetooth Tx CH00_2402 MHz_1Mbps Mode 2: Bluetooth Tx CH19_2440 MHz_1Mbps Mode 3: Bluetooth Tx CH39_2480 MHz_1Mbps
Radiated TCs	Mode 1: Bluetooth Tx CH00_2402 MHz_1Mbps Mode 2: Bluetooth Tx CH19_2440 MHz_1Mbps Mode 3: Bluetooth Tx CH39_2480 MHz_1Mbps
AC Conducted Emission	Mode 1: WLAN (2.4GHz) Link + Bluetooth Link + H Patten + Camera + MPEG4 + Earphone + Data Link with iPod + HDMI Cable + SD Card + Adapter



## 2.3 Connection Diagram of Test System

### <Bluetooth 4.0 – LE Tx Mode>

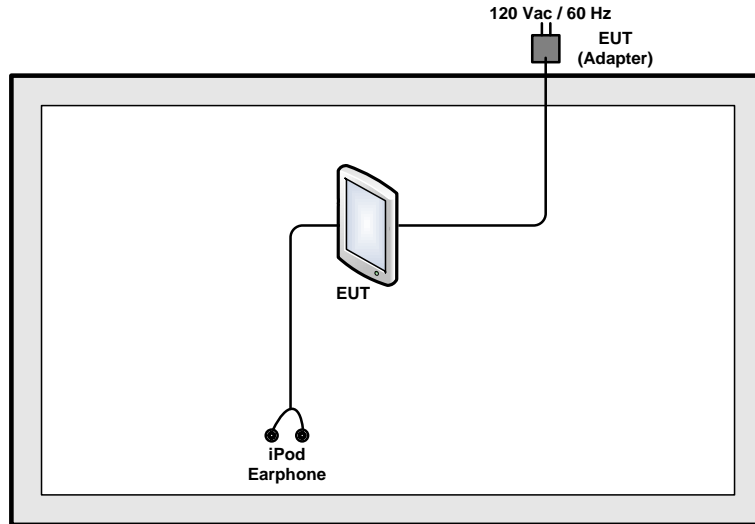

### <AC Conducted Emission Mode>

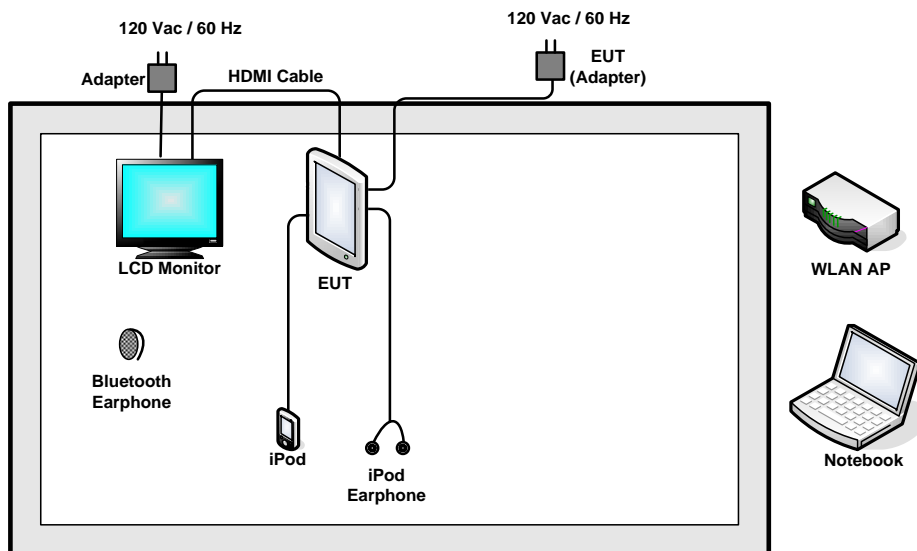



### 2.4 Support Unit used in test configuration and system

Item	Equipment	Trade Name	Model Name	FCC ID	Data Cable	Power Cord
1.	Bluetooth Earphone	Sony Ericsson	MW600	PY7DDA-2029	N/A	N/A
2.	WLAN AP	D-Link	DIR-865L	KA2IR865LA1	N/A	Unshielded, 1.8 m
3.	Notebook	DELL	Latitude E6320	FCC DoC/ Contains FCC ID: QDS-BRCM1054	N/A	AC I/P: Unshielded, 1.2 m DC O/P: Shielded, 1.8 m
4.	iPod	Apple	A1285	FCC DoC	Shielded, 1.0 m	N/A
5.	iPod Earphone	Apple	N/A	Verification	Unshielded, 1.0 m	N/A
6.	LCD Monitor	DELL	U2410	FCC DoC	Shielded, 1.6 m	Unshielded, 1.8 m
7.	SD Card	SanDisk	MicroSD HC	FCC DoC	N/A	N/A

### 2.5 EUT Operation Test Setup

For Bluetooth function, the RF utility, “cmd” was installed in EUT which was programmed in order to make the EUT get into the engineering modes to contact with Bluetooth base station for continuous transmitting and receiving signals.

### 2.6 Measurement Results Explanation Example

For all conducted test items:

The offset level is set in the spectrum analyzer to compensate the RF cable loss and attenuator factor between EUT conducted output port and spectrum analyzer. With the offset compensation, the spectrum analyzer reading level is exactly the EUT RF output level.

Example :

The spectrum analyzer offset is derived from RF cable loss and attenuator factor.

*Offset = RF cable loss + attenuator factor.*

Following shows an offset computation example with cable loss 4.2 dB and 10dB attenuator.

$$\begin{aligned}
\text{Offset(dB)} &= \text{RF cable loss(dB)} + \text{attenuator factor(dB)}. \\
&= 4.2 + 10 = 14.2 \text{ (dB)}
\end{aligned}$$

### 3 Test Result

#### 3.1 6dB and 99% Bandwidth Measurement

##### 3.1.1 Limit of 6dB and 99% Bandwidth

The minimum 6 dB bandwidth shall be at least 500 kHz.

##### 3.1.2 Measuring Instruments

The section 4.0 of List of Measuring Equipment of this test report is used for test.

##### 3.1.3 Test Procedures

1. The testing follows FCC KDB Publication No. 558074 D01 DTS Meas. Guidance v03r02.
2. The RF output of EUT was connected to the spectrum analyzer by RF cable and attenuator. The path loss was compensated to the results for each measurement.
3. Set to the maximum power setting and enable the EUT transmit continuously.
4. Make the measurement with the spectrum analyzer's resolution bandwidth (RBW) = 100 kHz. Set the Video bandwidth (VBW) = 300 kHz. In order to make an accurate measurement. The 6 dB bandwidth must be greater than 500 kHz.
5. For 99% Bandwidth Measurement, the spectrum analyzer's resolution bandwidth (RBW) is set 30kHz and set the Video bandwidth (VBW) = 100kHz.
6. Measure and record the results in the test report.

##### 3.1.4 Test Setup





### 3.1.5 Test Result of 6dB Bandwidth

Test Mode :	Bluetooth 4.0 - LE	Temperature :	22~25°C
Test Engineer :	Osolemio Chang	Relative Humidity :	51~55%

Channel	Frequency (MHz)	6dB Bandwidth (MHz)	6dB Bandwidth Min. Limit (MHz)	Pass/Fail
00	2402	0.71	0.5	Pass
19	2440	0.71	0.5	Pass
39	2480	0.70	0.5	Pass

6 dB Bandwidth Plot on Channel 00

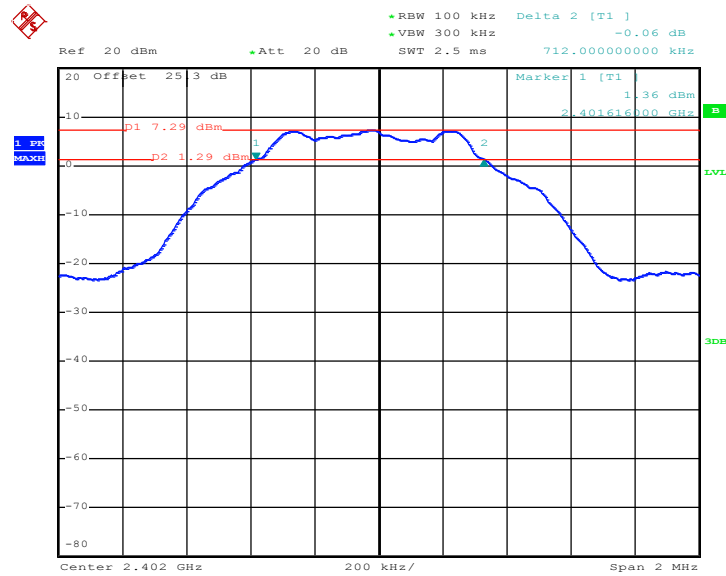

Date: 26.NOV.2014 14:42:32



6 dB Bandwidth Plot on Channel 19

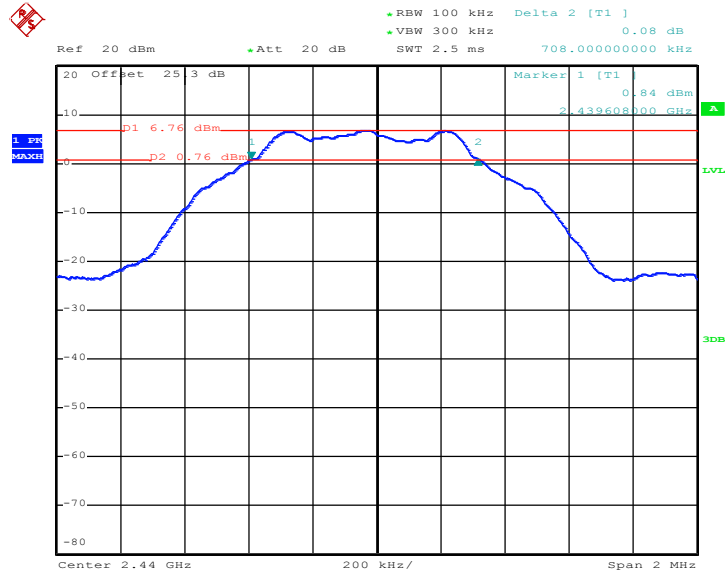

Date: 25.NOV.2014 20:19:57

6 dB Bandwidth Plot on Channel 39

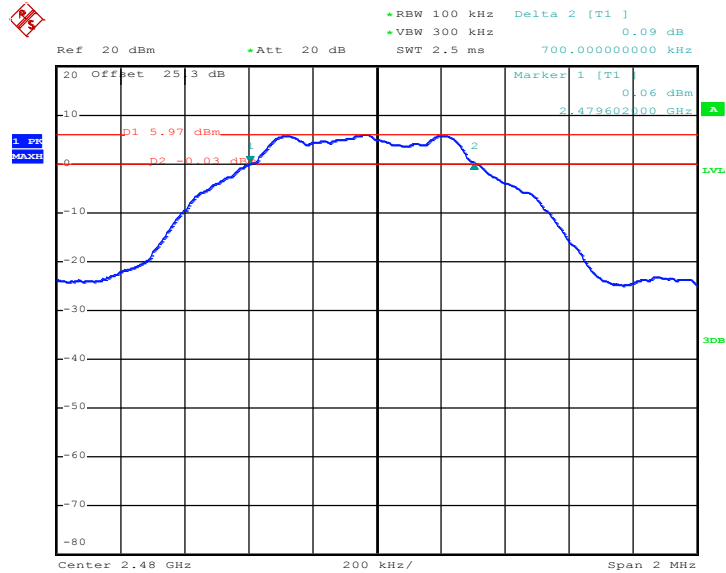

Date: 25.NOV.2014 20:25:18



3.1.6 Test Result of 99% Occupied Bandwidth

Test Mode :	Bluetooth 4.0 - LE	Temperature :	22~25°C
Test Engineer :	Osolemio Chang	Relative Humidity :	51~55%

Channel	Frequency (MHz)	99% Occupied Bandwidth (MHz)
00	2402	1.04
19	2440	1.04
39	2480	1.04

99% Bandwidth Plot on Channel 00

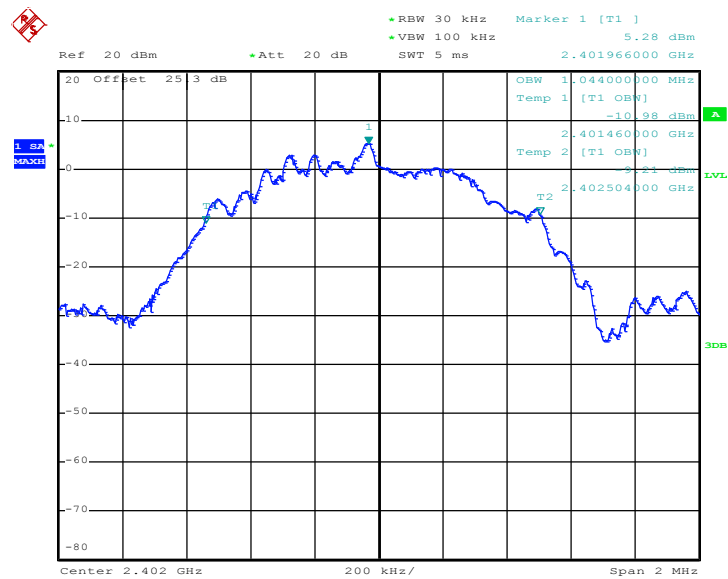

Date: 25.NOV.2014 20:17:12



99% Occupied Bandwidth Plot on Channel 19

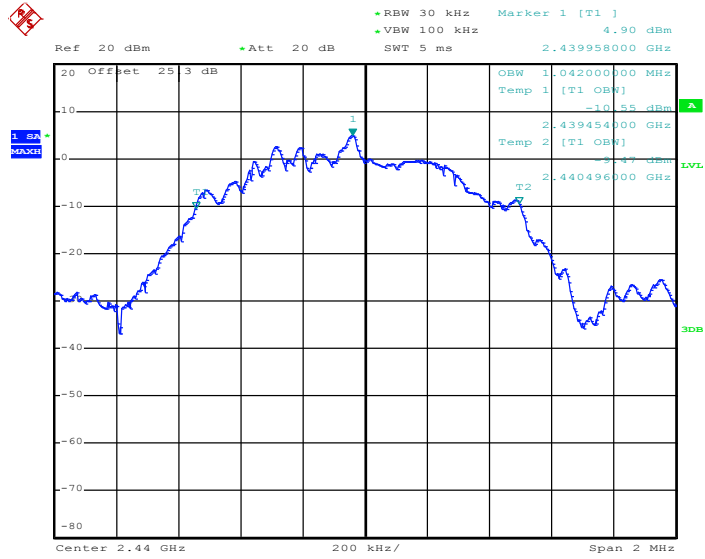

Date: 25.NOV.2014 20:22:43

99% Occupied Bandwidth Plot on Channel 39

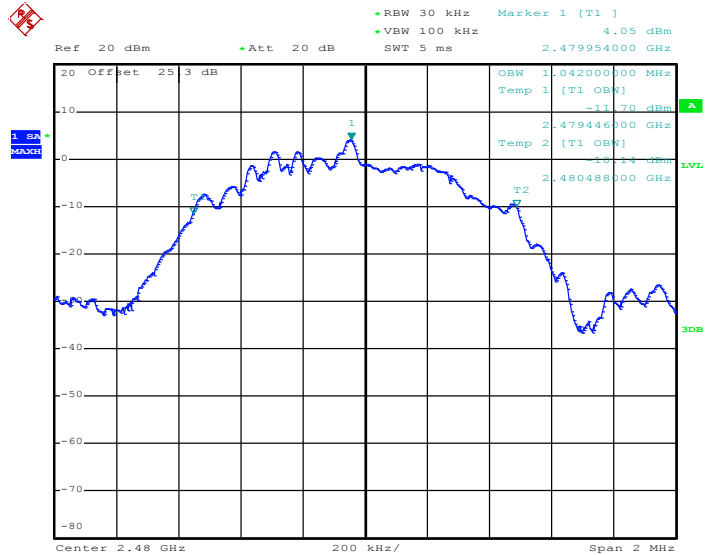

Date: 25.NOV.2014 20:27:36

Note: The occupied channel bandwidth is maintained within the band of operation for all of the modulations.

## 3.2 Peak Output Power Measurement

### 3.2.1 Limit of Peak Output Power

For systems using digital modulation in the 2400-2483.5MHz, the limit for peak output power is 30dBm. If transmitting antenna of directional gain greater than 6dBi is used, the peak output power from the intentional radiator shall be reduced below the above stated value by the amount in dB that the directional gain of the antenna exceeds 6 dBi. In case of point-to-point operation, the limit has to be reduced by 1dB for every 3dB that the directional gain of the antenna exceeds 6dBi.

### 3.2.2 Measuring Instruments

The section 4.0 of List of Measuring Equipment of this test report is used for test.

### 3.2.3 Test Procedures

1. The testing follows the Measurement Procedure of FCC KDB No. 558074 DTS D01 Meas. Guidance v03r02.
2. The RF output of EUT was connected to the power meter by RF cable and attenuator. The path loss was compensated to the results for each measurement.
3. Set to the maximum power setting and enable the EUT transmit continuously.
4. Measure the conducted output power and record the results in the test report.

### 3.2.4 Test Setup

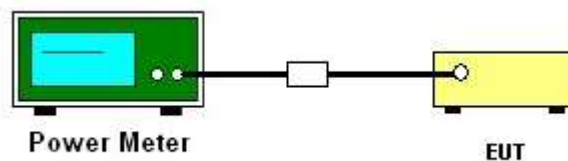





3.2.5 Test Result of Peak Output Power

Test Mode :	Bluetooth 4.0 - LE	Temperature :	22~25°C
Test Engineer :	Osolemio Chang	Relative Humidity :	51~55%

Channel	Frequency (MHz)	RF Power (dBm)		
		GFSK	Max. Limits (dBm)	Pass/Fail
		1 Mbps		
00	2402	6.71	30.00	Pass
19	2440	5.56	30.00	Pass
39	2480	4.66	30.00	Pass

### 3.3 Power Spectral Density Measurement

#### 3.3.1 Limit of Power Spectral Density

The peak power spectral density shall not be greater than 8dBm in any 3kHz band at any time interval of continuous transmission.

#### 3.3.2 Measuring Instruments

The section 4.0 of List of Measuring Equipment of this test report is used for test.

#### 3.3.3 Test Procedures

1. The testing follows Measurement Procedure 10.2 Method PKPSD of FCC KDB Publication No. 558074 D01 DTS Meas. Guidance v03r02
2. The RF output of EUT was connected to the spectrum analyzer by RF cable and attenuator. The path loss was compensated to the results for each measurement.
3. Set to the maximum power setting and enable the EUT transmit continuously.
4. Make the measurement with the spectrum analyzer's resolution bandwidth (RBW) = 3 kHz. Video bandwidth VBW = 10 kHz In order to make an accurate measurement, set the span to 1.5 times DTS Channel Bandwidth. (6dB BW)
5. Detector = peak, Sweep time = auto couple, Trace mode = max hold, Allow trace to fully stabilize. Use the peak marker function to determine the maximum power level.
6. Measure and record the results in the test report.
7. The Measured power density (dBm)/ 100kHz is a reference level and used as 20dBc down limit line for Conducted Band Edges and Conducted Spurious Emission.

#### 3.3.4 Test Setup

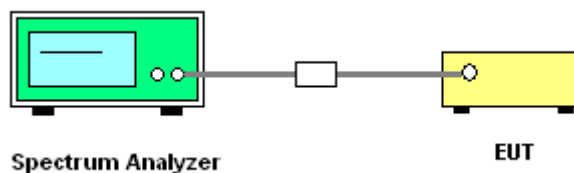



### 3.3.5 Test Result of Power Spectral Density

Test Mode :	Bluetooth 4.0 - LE	Temperature :	22~25°C
Test Engineer :	Osolemio Chang	Relative Humidity :	51~55%

Channel	Frequency (MHz)	Power Density		Max. Limits (dBm/3kHz)	Pass/Fail
		PSD/100kHz (dBm)	PSD/3kHz (dBm)		
00	2402	7.25	-6.35	8	Pass
19	2440	6.76	-6.84	8	Pass
39	2480	5.96	-7.71	8	Pass

**Note:**

1. Measured power density (dBm) has offset with cable loss.
2. The Measured power density (dBm)/ 100kHz is reference level and used as 20dBc down for Conducted Band Edges and Conducted Spurious Emission limit line.



### 3.3.6 Test Result of Power Spectral Density Plots (100kHz)

PSD 100kHz Plot on Channel 00

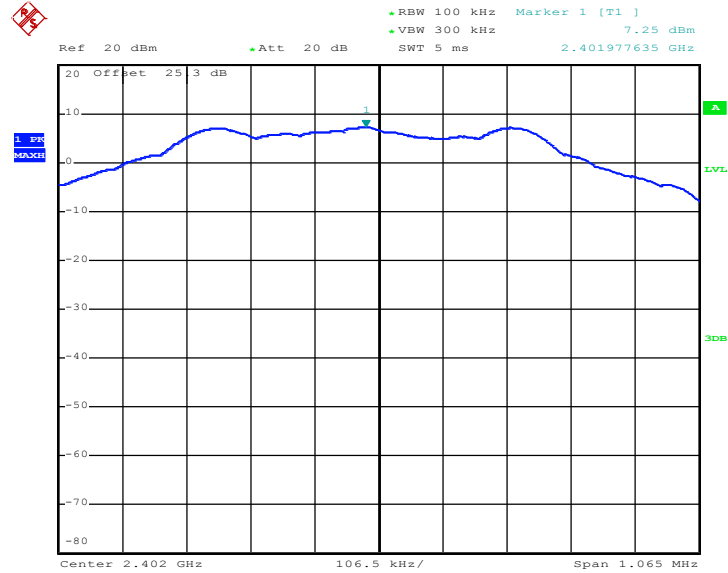

Date: 25.NOV.2014 20:15:12



PSD 100kHz Plot on Channel 19

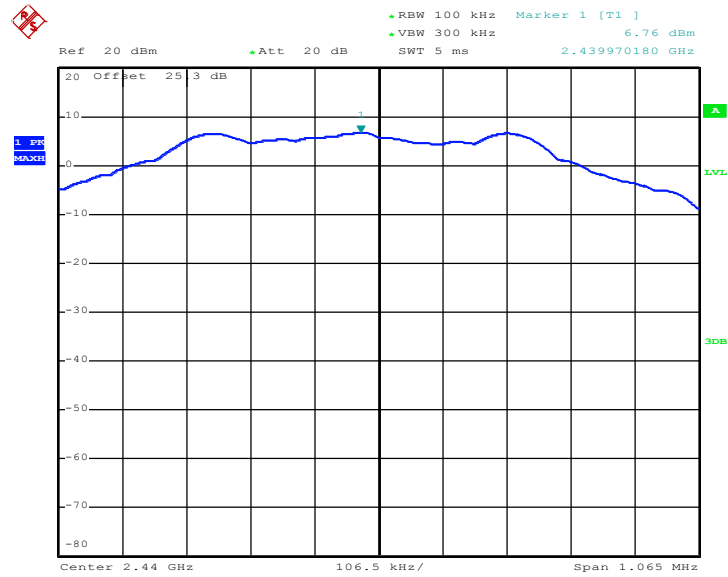

Date: 25.NOV.2014 20:20:58

PSD 100kHz Plot on Channel 39

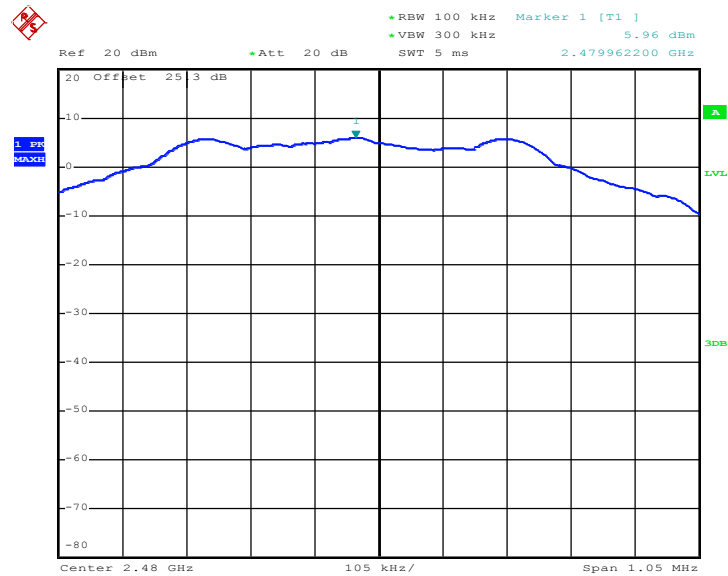

Date: 25.NOV.2014 20:26:15



### 3.3.7 Test Result of Power Spectral Density Plots (3kHz)

PSD 3kHz Plot on Channel 00

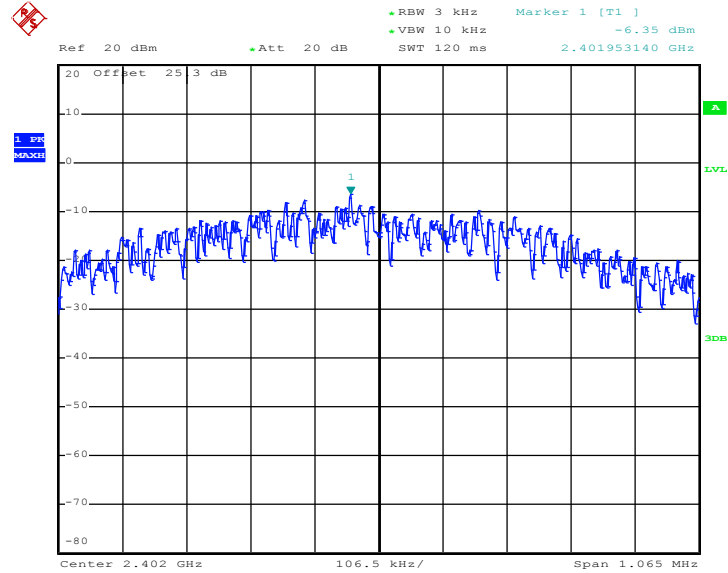

Date: 25.NOV.2014 20:14:42



PSD 3kHz Plot on Channel 19

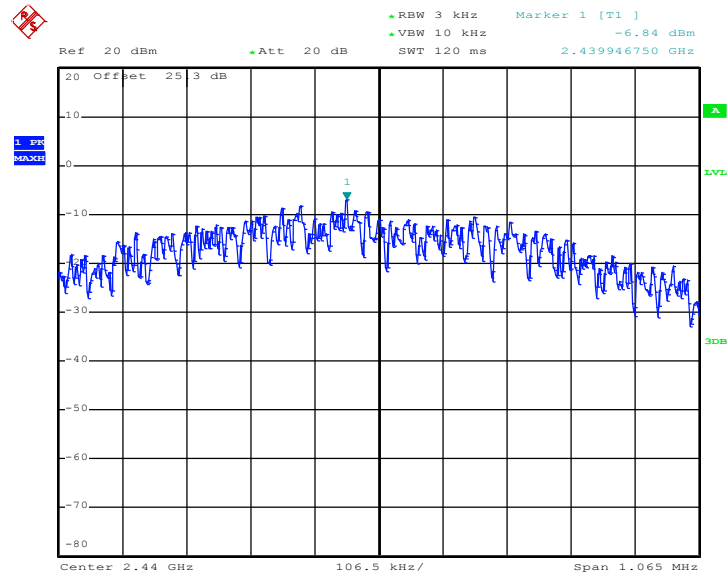

Date: 25.NOV.2014 20:20:23

PSD 3kHz Plot on Channel 39

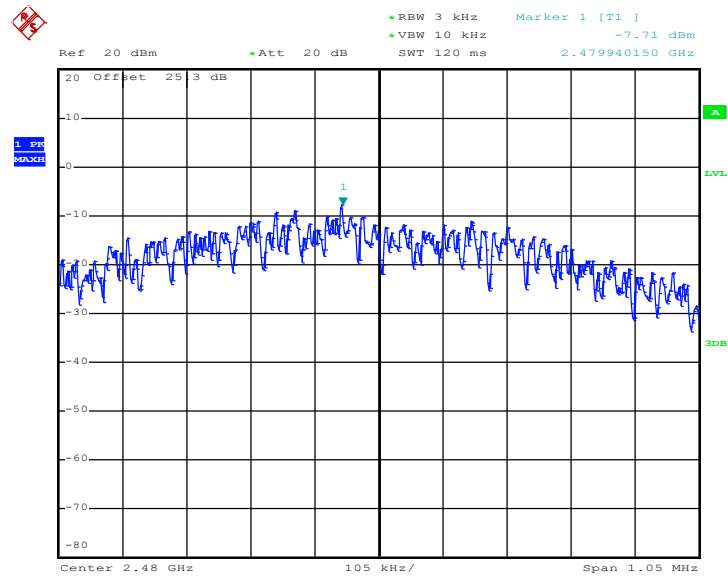

Date: 25.NOV.2014 20:25:52

## 3.4 Conducted Band Edges and Spurious Emission Measurement

### 3.4.1 Limit of Conducted Band Edges and Spurious Emission

All harmonics/spurious must be at least 20 dB down from the highest emission level within the authorized band.

### 3.4.2 Measuring Instruments

The section 4.0 of List of Measuring Equipment of this test report is used for test.

### 3.4.3 Test Procedure

1. The testing follows FCC KDB Publication No. 558074 D01 DTS Meas. Guidance v03r02.
2. The RF output of EUT was connected to the spectrum analyzer by RF cable and attenuator. The path loss was compensated to the results for each measurement.
3. Set to the maximum power setting and enable the EUT transmit continuously.
4. Set RBW = 100 kHz, VBW=300 kHz, Peak Detector. Unwanted Emissions measured in any 100 kHz bandwidth outside of the authorized frequency band shall be attenuated by at least 20 dB relative to the maximum in-band peak PSD level in 100 kHz when maximum peak conducted output power procedure is used. If the transmitter complies with the conducted power limits based on the use of RMS averaging over a time interval, the attenuation required under this paragraph shall be 30 dB instead of 20 dB per 15.247(d).
5. Measure and record the results in the test report.
6. The RF fundamental frequency should be excluded against the limit line in the operating frequency band.

### 3.4.4 Test Setup

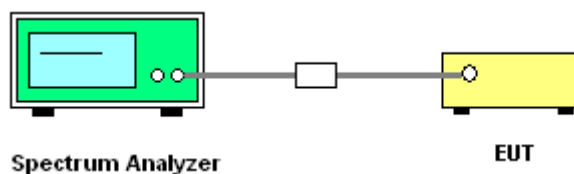





### 3.4.5 Test Result of Conducted Band Edges

Test Mode :	Bluetooth 4.0 - LE	Temperature :	22~25°C
Test Channel :	00 and 39	Relative Humidity :	51~55%
		Test Engineer :	Osolemio Chang

Low Band Edge Plot on Channel 00

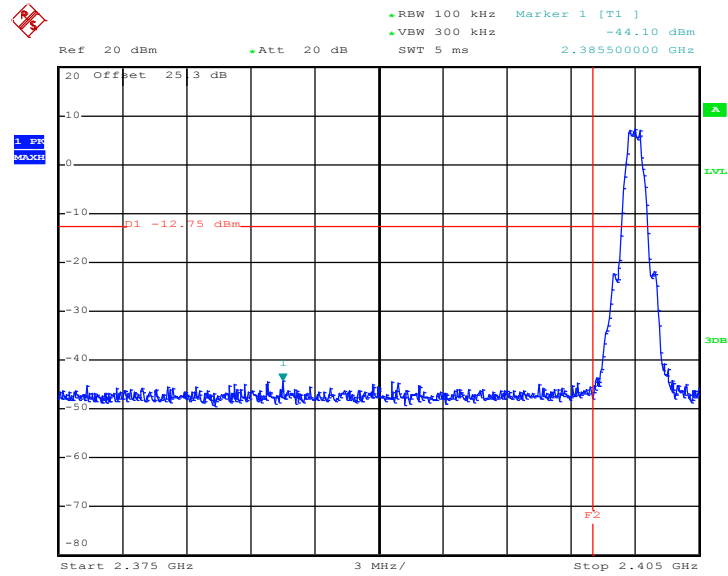

Date: 25.NOV.2014 20:15:32



High Band Edge Plot on Channel 39

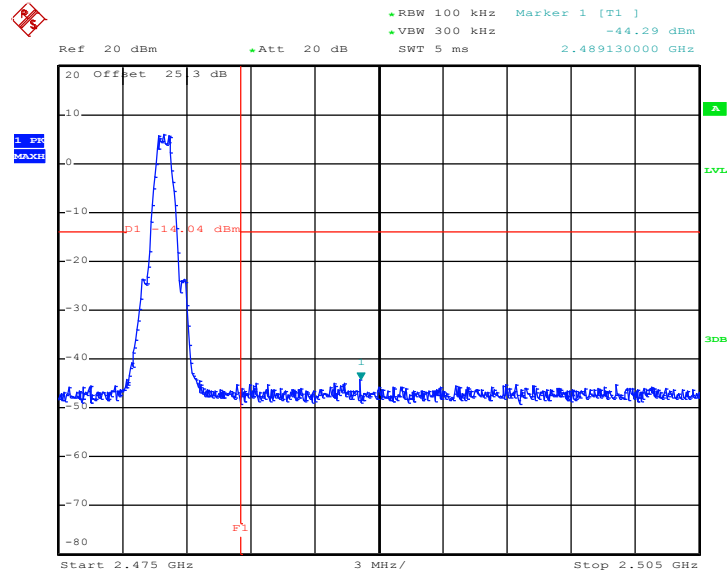

Date: 25.NOV.2014 20:26:33



### 3.4.6 Test Result of Conducted Spurious Emission

Test Mode :	Bluetooth 4.0 - LE	Temperature :	22~25°C
Test Channel :	00	Relative Humidity :	51~55%
		Test Engineer :	Osolemio Chang

Conducted Spurious Emission Plot on Bluetooth LE 1Mbps GFSK Channel 00

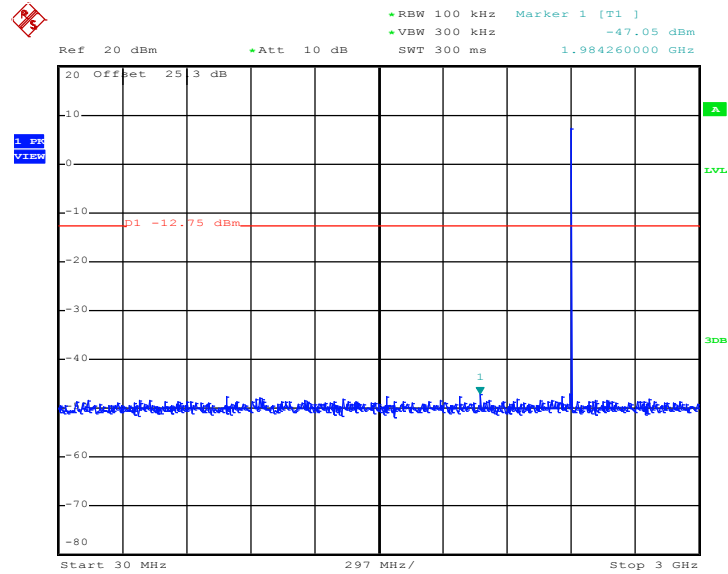

Date: 25.NOV.2014 20:16:11



### Conducted Spurious Emission Plot on Bluetooth LE 1Mbps GFSK Channel 00

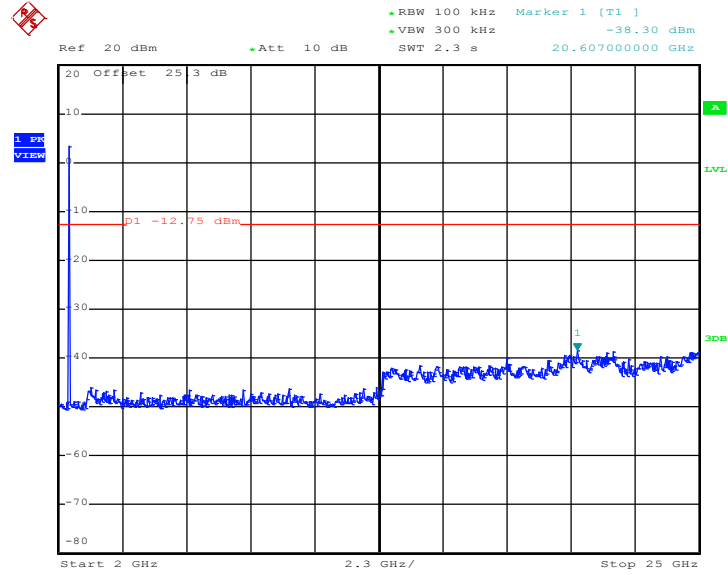

Date: 25.NOV.2014 20:16:29



Test Mode :	Bluetooth 4.0 - LE	Temperature :	22~25°C
Test Channel :	19	Relative Humidity :	51~55%
		Test Engineer :	Osolemio Chang

**Conducted Spurious Emission Plot on Bluetooth LE 1Mbps  
GFSK Channel 19**

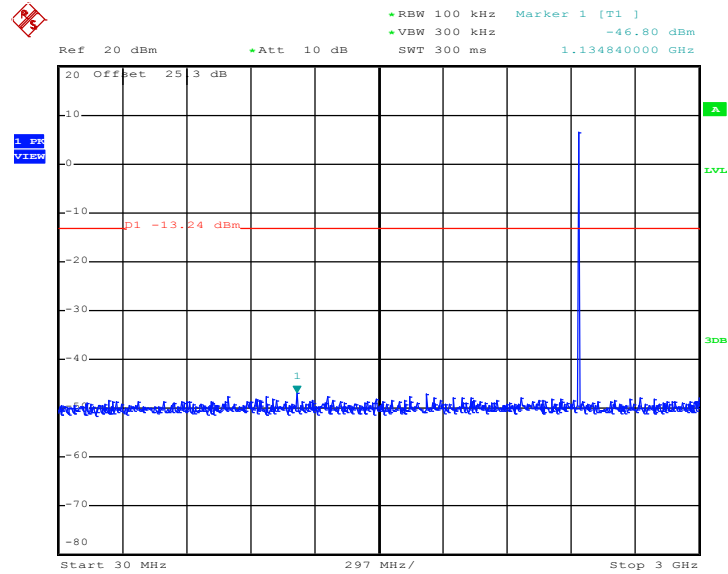

Date: 25.NOV.2014 20:21:25



### Conducted Spurious Emission Plot on Bluetooth LE 1Mbps GFSK Channel 19

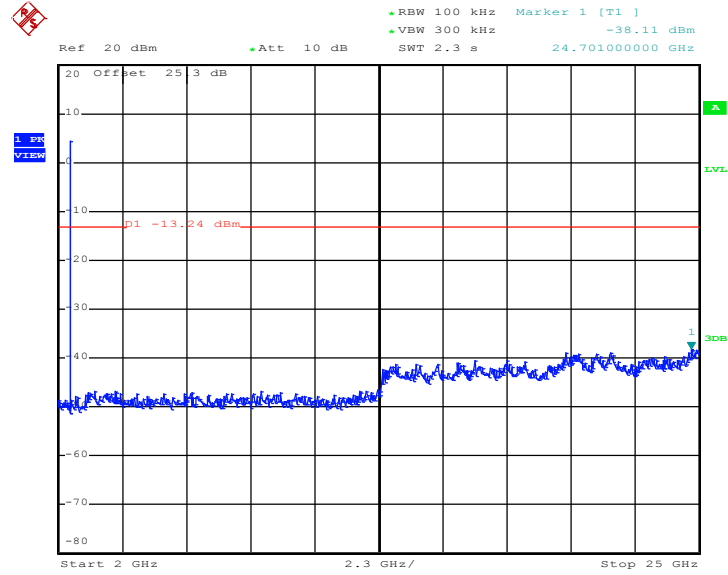

Date: 25.NOV.2014 20:21:43



Test Mode :	Bluetooth 4.0 - LE	Temperature :	22~25°C
Test Channel :	39	Relative Humidity :	51~55%
		Test Engineer :	Osolemio Chang

**Conducted Spurious Emission Plot on Bluetooth LE 1Mbps  
GFSK Channel 39**

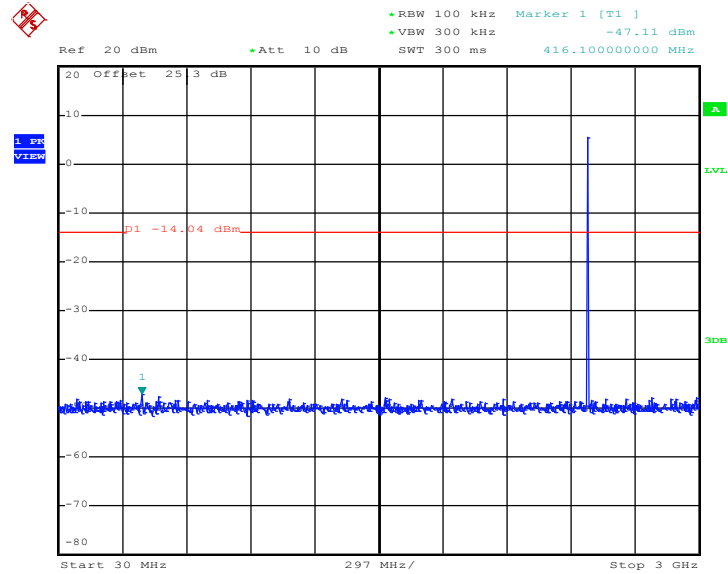

Date: 25.NOV.2014 20:26:59



### Conducted Spurious Emission Plot on Bluetooth LE 1Mbps GFSK Channel 39

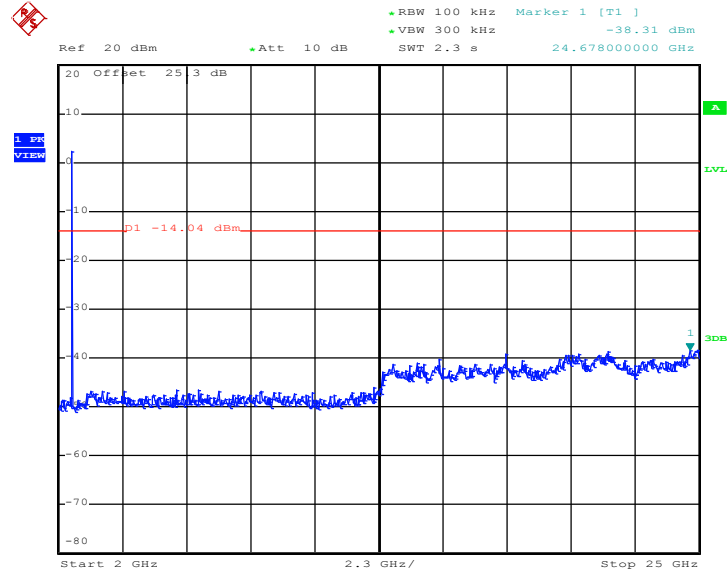

Date: 25.NOV.2014 20:27:17





### 3.5 Radiated Band Edges and Spurious Emission Measurement

#### 3.5.1 Limit of Radiated Band Edges and Spurious Emission

In any 100 kHz bandwidth outside the intentional radiator frequency band, all harmonics/spurious must be at least 20 dB below the highest emission level within the authorized band. If the output power of this device was measured by spectrum analyzer, the attenuation under this paragraph shall be 30 dB instead of 20 dB. In addition, radiated emissions which fall in the restricted bands must also comply with the FCC section 15.209 limits as below.

Frequency (MHz)	Field Strength (microvolts/meter)	Measurement Distance (meters)
0.009 – 0.490	2400/F(kHz)	300
0.490 – 1.705	24000/F(kHz)	30
1.705 – 30.0	30	30
30 – 88	100	3
88 – 216	150	3
216 - 960	200	3
Above 960	500	3

#### 3.5.2 Measuring Instruments

The section 4.0 of List of Measuring Equipment of this test report is used for test.



3.5.3 Test Procedures

1. The testing follows FCC KDB Publication No. 558074 D01 DTS Meas. Guidance v03r02.
2. The EUT was arranged to its worst case and then tune the antenna tower (from 1 m to 4 m) and turntable (from 0 degree to 360 degrees) to find the maximum reading. A pre-amp and a high pass filter are used for the test in order to get better signal level.
3. The EUT was placed on a turntable with 0.8 meter above ground.
4. The EUT was set 3 meters from the interference receiving antenna, which was mounted on the top of a variable height antenna tower.
5. Corrected Reading: Antenna Factor + Cable Loss + Read Level - Preamp Factor = Level
6. For measurement below 1GHz, If the emission level of the EUT measured by the peak detector is 3 dB lower than the applicable limit, the peak emission level will be reported. Otherwise, the emission measurement will be repeated using the quasi-peak detector and reported.
7. Use the following spectrum analyzer settings:
  - (1) Span shall wide enough to fully capture the emission being measured;
  - (2) Set RBW=100 kHz for  $f < 1$  GHz;  $VBW \geq RBW$ ; Sweep = auto; Detector function = peak; Trace = max hold;
  - (3) Set RBW = 1 MHz, VBW= 3MHz for  $f \geq 1$  GHz for peak measurement.

For average measurement:

  - $VBW = 10$  Hz, when duty cycle is no less than 98 percent.
  - $VBW \geq 1/T$ , when duty cycle is less than 98 percent where T is the minimum transmission duration over which the transmitter is on and is transmitting at its maximum power control level for the tested mode of operation.

Band	Duty Cycle(%)	T(μs)	1/T(kHz)	VBW Setting
Bluetooth 4.0 - LE	62.44	394	2.54	3kHz

### 3.5.4 Test Setup

For radiated emissions below 30MHz

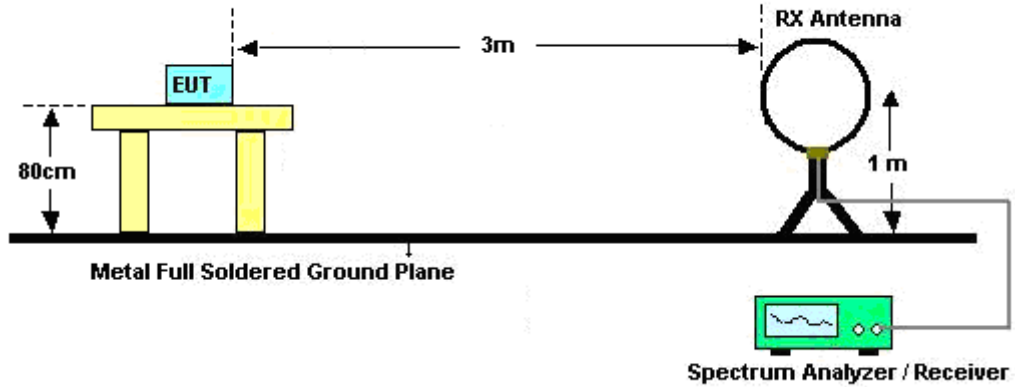

For radiated emissions from 30MHz to 1GHz

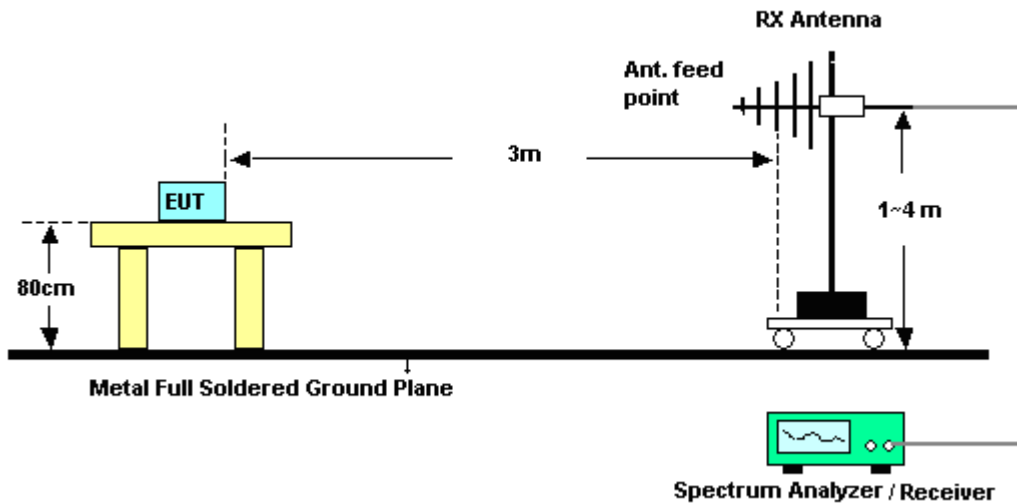

For radiated emissions above 1GHz

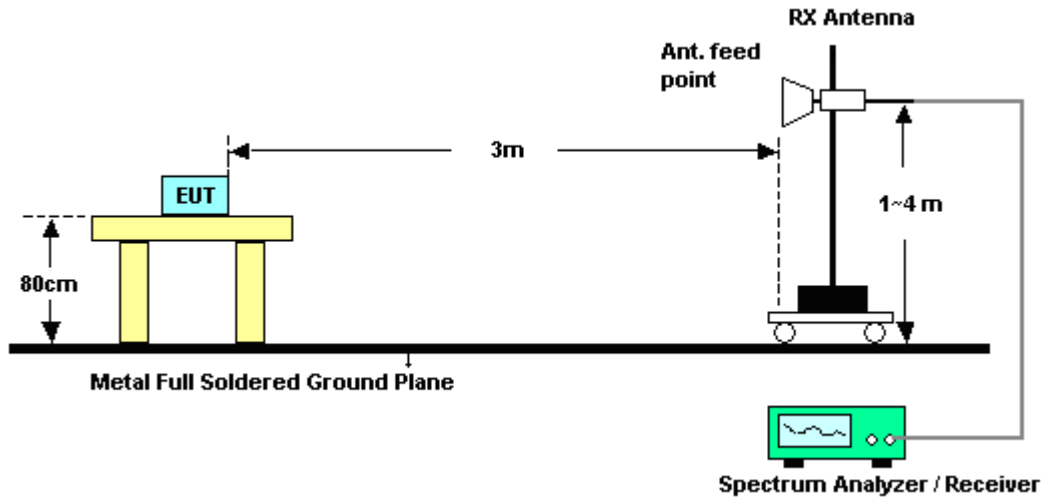

### 3.5.5 Test Results of Radiated Spurious Emissions (9 kHz ~ 30 MHz)

The low frequency, which started from 9 kHz to 30MHz, was pre-scanned and the result which was 20dB lower than the limit line per 15.31(o) was not reported.

### 3.5.6 Test Result

Please refer to appendix A as below.



### 3.6 AC Conducted Emission Measurement

#### 3.6.1 Limit of AC Conducted Emission

For equipment that is designed to be connected to the public utility (AC) power line, the radio frequency voltage that is conducted back onto the AC power line on any frequency or frequencies within the band 150 kHz to 30 MHz shall not exceed the limits in the following table.

Frequency of emission (MHz)	Conducted limit (dBµV)	
	Quasi-peak	Average
0.15-0.5	66 to 56*	56 to 46*
0.5-5	56	46
5-30	60	50

\*Decreases with the logarithm of the frequency.

#### 3.6.2 Measuring Instruments

The section 4.0 of List of Measuring Equipment of this test report is used for test.

#### 3.6.3 Test Procedures

1. The EUT was placed 0.4 meter from the conducting wall of the shielding room was kept at least 80 centimeters from any other grounded conducting surface.
2. Connect EUT to the power mains through a line impedance stabilization network (LISN).
3. All the support units are connecting to the other LISN.
4. The LISN provides 50 ohm coupling impedance for the measuring instrument.
5. The FCC states that a 50 ohm, 50 microhenry LISN should be used.
6. Both sides of AC line were checked for maximum conducted interference.
7. The frequency range from 150 kHz to 30 MHz was searched.
8. Set the test-receiver system to Peak Detect Function and specified bandwidth (IF Bandwidth = 9kHz) with Maximum Hold Mode. Then measurement is also conducted by Average Detector and Quasi-Peak Detector Function respectively.

### 3.6.4 Test Setup





3.6.5 Test Result of AC Conducted Emission

Test Mode :	Mode 1	Temperature :	21~23°C
Test Engineer :	Eric Jeng	Relative Humidity :	46~48%
Test Voltage :	120Vac / 60Hz	Phase :	Line
Function Type :	WLAN (2.4GHz) Link + Bluetooth Link + H Patten + Camera + MPEG4 + Earphone + Data Link with iPod + HDMI Cable + SD Card + Adapter		

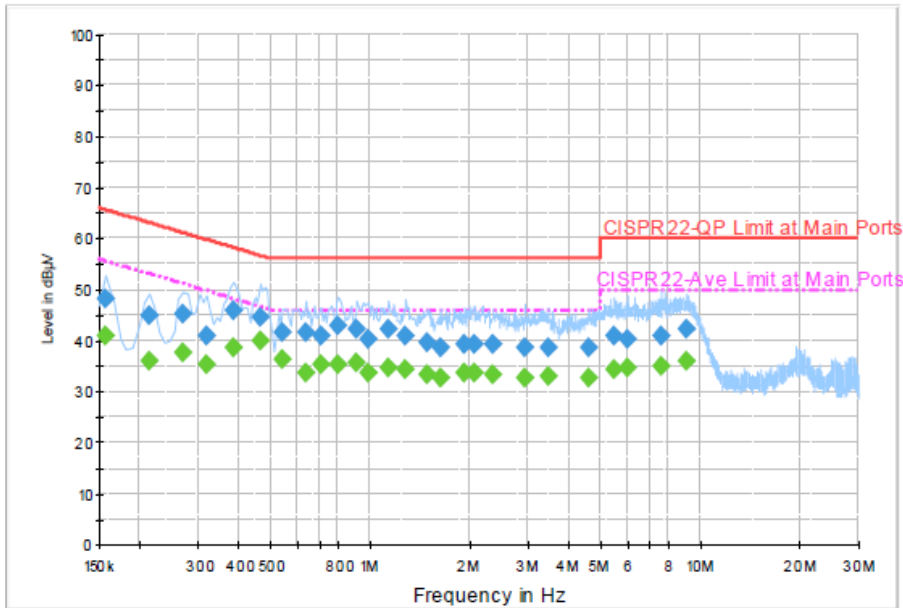

Final Result : Quasi-Peak

Frequency (MHz)	Quasi-Peak (dBµV)	Filter	Line	Corr. (dB)	Margin (dB)	Limit (dBµV)
0.158000	48.2	Off	L1	19.4	17.4	65.6
0.214000	44.9	Off	L1	19.4	18.1	63.0
0.270000	45.2	Off	L1	19.4	15.9	61.1
0.318000	40.9	Off	L1	19.4	18.9	59.8
0.382000	46.0	Off	L1	19.4	12.2	58.2
0.462000	44.5	Off	L1	19.4	12.2	56.7
0.542000	41.7	Off	L1	19.4	14.3	56.0
0.638000	41.6	Off	L1	19.5	14.4	56.0
0.710000	41.0	Off	L1	19.5	15.0	56.0
0.798000	42.8	Off	L1	19.5	13.2	56.0
0.910000	42.3	Off	L1	19.5	13.7	56.0
0.982000	40.3	Off	L1	19.5	15.7	56.0
1.126000	42.3	Off	L1	19.5	13.7	56.0
1.278000	40.8	Off	L1	19.5	15.2	56.0
1.486000	39.7	Off	L1	19.5	16.3	56.0



Test Mode :	Mode 1	Temperature :	21~23°C
Test Engineer :	Eric Jeng	Relative Humidity :	46~48%
Test Voltage :	120Vac / 60Hz	Phase :	Line
Function Type :	WLAN (2.4GHz) Link + Bluetooth Link + H Patten + Camera + MPEG4 + Earphone + Data Link with iPod + HDMI Cable + SD Card + Adapter		

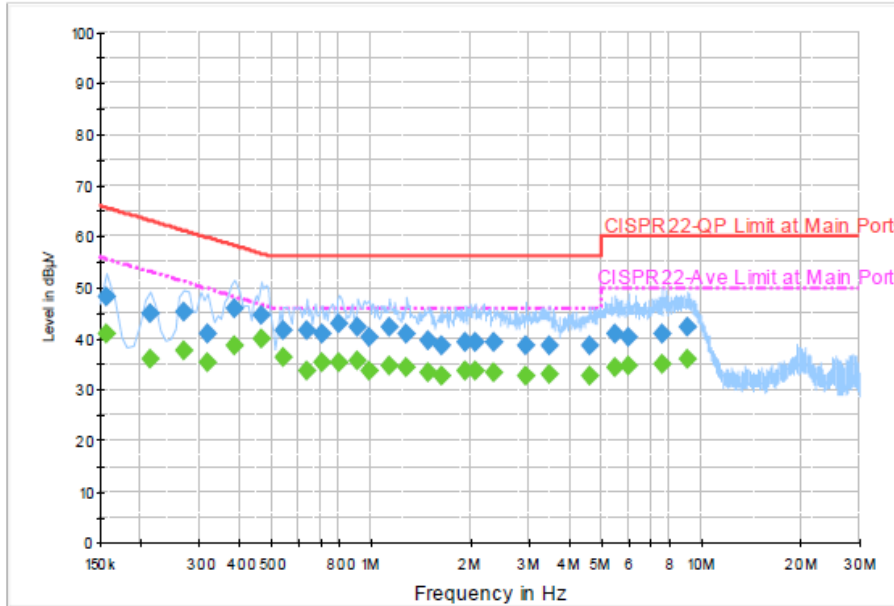

Final Result : Quasi-Peak

Frequency (MHz)	Quasi-Peak (dBµV)	Filter	Line	Corr. (dB)	Margin (dB)	Limit (dBµV)
1.622000	38.7	Off	L1	19.5	17.3	56.0
1.918000	39.2	Off	L1	19.5	16.8	56.0
2.070000	39.3	Off	L1	19.2	16.7	56.0
2.342000	39.1	Off	L1	19.4	16.9	56.0
2.926000	38.7	Off	L1	19.6	17.3	56.0
3.454000	38.8	Off	L1	19.6	17.2	56.0
4.558000	38.6	Off	L1	19.6	17.4	56.0
5.470000	40.8	Off	L1	19.6	19.2	60.0
5.974000	40.4	Off	L1	19.7	19.6	60.0
7.574000	40.8	Off	L1	19.6	19.2	60.0
9.054000	42.2	Off	L1	19.7	17.8	60.0





Test Mode :	Mode 1	Temperature :	21~23°C
Test Engineer :	Eric Jeng	Relative Humidity :	46~48%
Test Voltage :	120Vac / 60Hz	Phase :	Line
Function Type :	WLAN (2.4GHz) Link + Bluetooth Link + H Patten + Camera + MPEG4 + Earphone + Data Link with iPod + HDMI Cable + SD Card + Adapter		

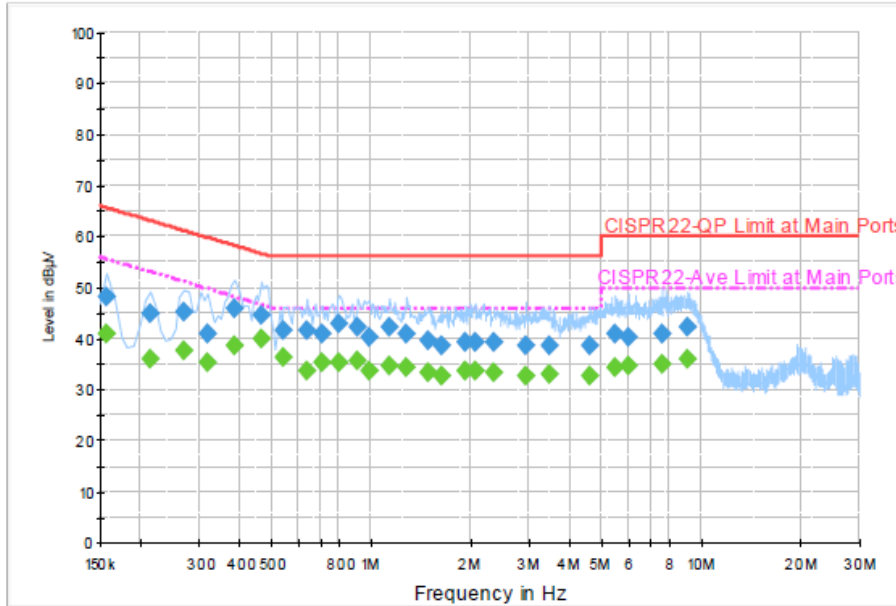

Final Result : Average

Frequency (MHz)	Average (dBµV)	Filter	Line	Corr. (dB)	Margin (dB)	Limit (dBµV)
0.158000	41.1	Off	L1	19.4	14.5	55.6
0.214000	35.9	Off	L1	19.4	17.1	53.0
0.270000	37.6	Off	L1	19.4	13.5	51.1
0.318000	35.5	Off	L1	19.4	14.3	49.8
0.382000	38.6	Off	L1	19.4	9.6	48.2
0.462000	39.8	Off	L1	19.4	6.9	46.7
0.542000	36.3	Off	L1	19.4	9.7	46.0
0.638000	33.6	Off	L1	19.5	12.4	46.0
0.710000	35.5	Off	L1	19.5	10.5	46.0
0.798000	35.3	Off	L1	19.5	10.7	46.0
0.910000	35.5	Off	L1	19.5	10.5	46.0
0.982000	33.7	Off	L1	19.5	12.3	46.0
1.126000	34.8	Off	L1	19.5	11.2	46.0
1.278000	34.3	Off	L1	19.5	11.7	46.0



Test Mode :	Mode 1	Temperature :	21~23°C
Test Engineer :	Eric Jeng	Relative Humidity :	46~48%
Test Voltage :	120Vac / 60Hz	Phase :	Line
Function Type :	WLAN (2.4GHz) Link + Bluetooth Link + H Patten + Camera + MPEG4 + Earphone + Data Link with iPod + HDMI Cable + SD Card + Adapter		

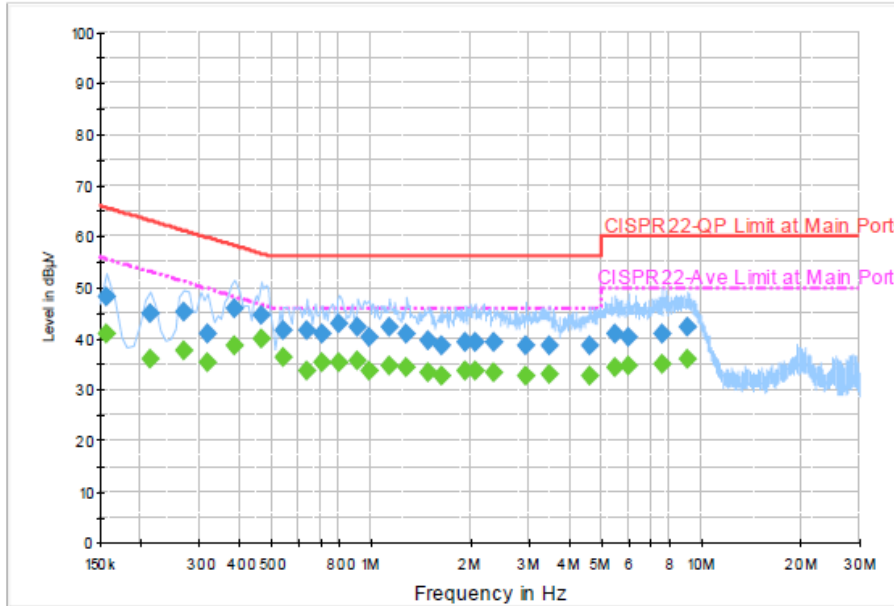

Final Result : Average

Frequency (MHz)	Average (dBµV)	Filter	Line	Corr. (dB)	Margin (dB)	Limit (dBµV)
1.486000	33.3	Off	L1	19.5	12.7	46.0
1.622000	32.8	Off	L1	19.5	13.2	46.0
1.918000	33.6	Off	L1	19.5	12.4	46.0
2.070000	33.6	Off	L1	19.2	12.4	46.0
2.342000	33.3	Off	L1	19.4	12.7	46.0
2.926000	32.6	Off	L1	19.6	13.4	46.0
3.454000	32.9	Off	L1	19.6	13.1	46.0
4.558000	32.6	Off	L1	19.6	13.4	46.0
5.470000	34.4	Off	L1	19.6	15.6	50.0
5.974000	34.5	Off	L1	19.7	15.5	50.0
7.574000	34.9	Off	L1	19.6	15.1	50.0
9.054000	36.0	Off	L1	19.7	14.0	50.0



Test Mode :	Mode 1	Temperature :	21~23°C
Test Engineer :	Eric Jeng	Relative Humidity :	46~48%
Test Voltage :	120Vac / 60Hz	Phase :	Neutral
Function Type :	WLAN (2.4GHz) Link + Bluetooth Link + H Patten + Camera + MPEG4 + Earphone + Data Link with iPod + HDMI Cable + SD Card + Adapter		

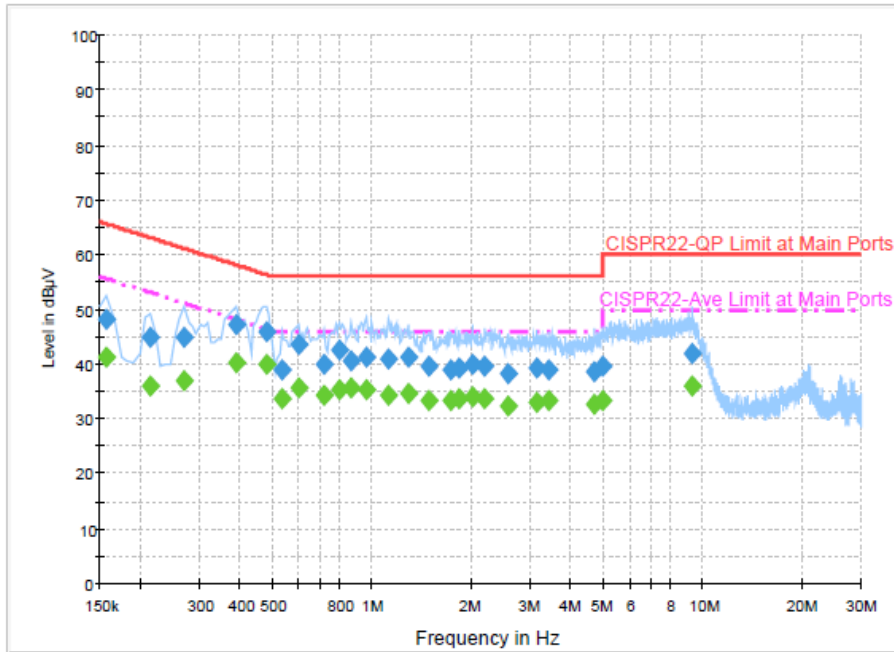

Final Result : Quasi-Peak

Frequency (MHz)	Quasi-Peak (dBµV)	Filter	Line	Corr. (dB)	Margin (dB)	Limit (dBµV)
0.158000	48.2	Off	N	19.4	17.4	65.6
0.214000	45.0	Off	N	19.4	18.0	63.0
0.270000	44.8	Off	N	19.4	16.3	61.1
0.390000	47.1	Off	N	19.4	11.0	58.1
0.478000	45.7	Off	N	19.5	10.7	56.4
0.534000	38.9	Off	N	19.4	17.1	56.0
0.598000	43.4	Off	N	19.5	12.6	56.0
0.718000	39.9	Off	N	19.5	16.1	56.0
0.798000	42.7	Off	N	19.5	13.3	56.0
0.862000	40.5	Off	N	19.5	15.5	56.0
0.958000	41.3	Off	N	19.5	14.7	56.0
1.118000	41.1	Off	N	19.5	14.9	56.0
1.286000	41.2	Off	N	19.5	14.8	56.0



Test Mode :	Mode 1	Temperature :	21~23°C
Test Engineer :	Eric Jeng	Relative Humidity :	46~48%
Test Voltage :	120Vac / 60Hz	Phase :	Neutral
Function Type :	WLAN (2.4GHz) Link + Bluetooth Link + H Patten + Camera + MPEG4 + Earphone + Data Link with iPod + HDMI Cable + SD Card + Adapter		

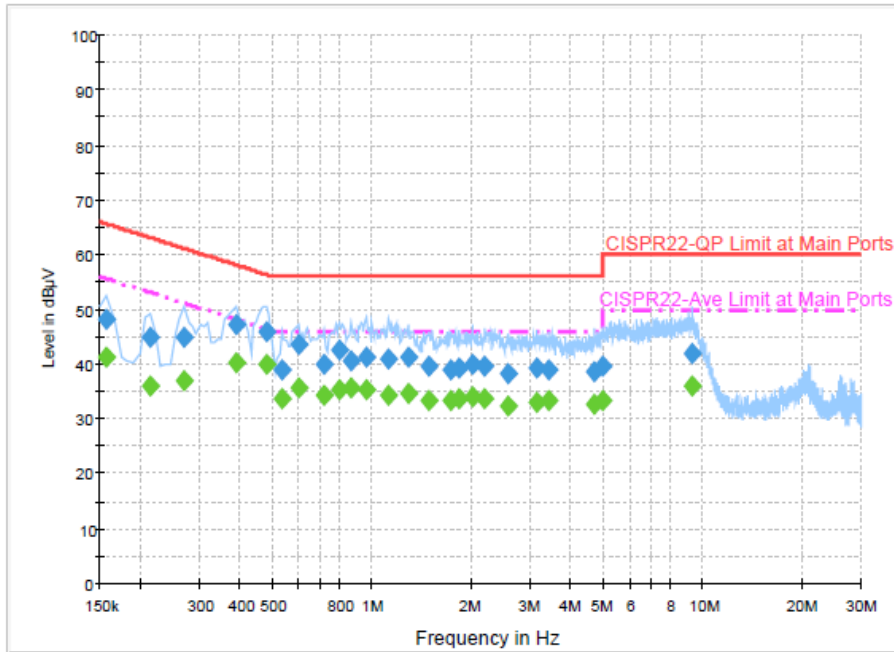

Final Result : Quasi-Peak

Frequency (MHz)	Quasi-Peak (dBµV)	Filter	Line	Corr. (dB)	Margin (dB)	Limit (dBµV)
1.486000	39.6	Off	N	19.5	16.4	56.0
1.718000	39.0	Off	N	19.5	17.0	56.0
1.822000	39.1	Off	N	19.6	16.9	56.0
2.014000	39.8	Off	N	19.5	16.2	56.0
2.190000	39.5	Off	N	19.3	16.5	56.0
2.590000	38.4	Off	N	19.5	17.6	56.0
3.142000	39.2	Off	N	19.6	16.8	56.0
3.406000	38.9	Off	N	19.6	17.1	56.0
4.694000	38.5	Off	N	19.6	17.5	56.0
4.958000	39.6	Off	N	19.7	16.4	56.0
9.270000	41.9	Off	N	19.7	18.1	60.0



Test Mode :	Mode 1	Temperature :	21~23°C
Test Engineer :	Eric Jeng	Relative Humidity :	46~48%
Test Voltage :	120Vac / 60Hz	Phase :	Neutral
Function Type :	WLAN (2.4GHz) Link + Bluetooth Link + H Patten + Camera + MPEG4 + Earphone + Data Link with iPod + HDMI Cable + SD Card + Adapter		

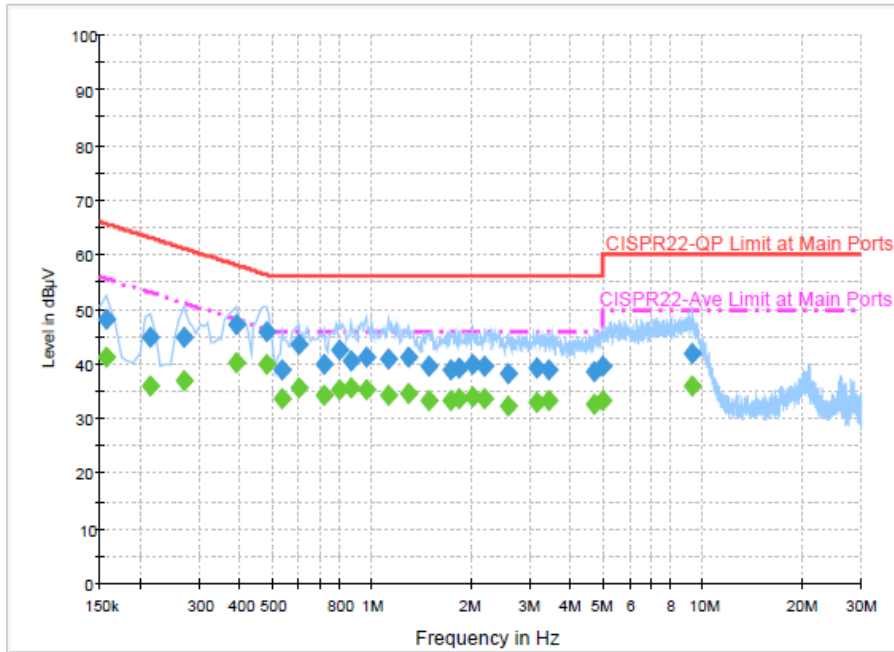

Final Result : Average

Frequency (MHz)	Average (dBµV)	Filter	Line	Corr. (dB)	Margin (dB)	Limit (dBµV)
0.158000	41.1	Off	N	19.4	14.5	55.6
0.214000	35.8	Off	N	19.4	17.2	53.0
0.270000	36.9	Off	N	19.4	14.2	51.1
0.390000	40.2	Off	N	19.4	7.9	48.1
0.478000	39.9	Off	N	19.5	6.5	46.4
0.534000	33.7	Off	N	19.4	12.3	46.0
0.598000	35.5	Off	N	19.5	10.5	46.0
0.718000	34.4	Off	N	19.5	11.6	46.0
0.798000	35.3	Off	N	19.5	10.7	46.0
0.862000	35.8	Off	N	19.5	10.2	46.0
0.958000	35.2	Off	N	19.5	10.8	46.0
1.118000	34.4	Off	N	19.5	11.6	46.0
1.286000	34.8	Off	N	19.5	11.2	46.0



Test Mode :	Mode 1	Temperature :	21~23°C
Test Engineer :	Eric Jeng	Relative Humidity :	46~48%
Test Voltage :	120Vac / 60Hz	Phase :	Neutral
Function Type :	WLAN (2.4GHz) Link + Bluetooth Link + H Patten + Camera + MPEG4 + Earphone + Data Link with iPod + HDMI Cable + SD Card + Adapter		

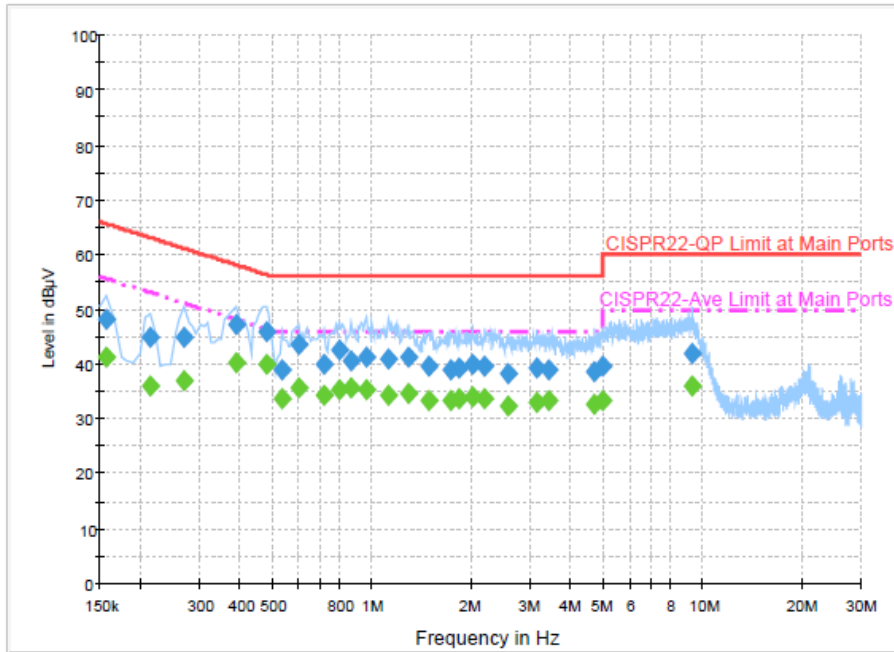

Final Result : Average

Frequency (MHz)	Average (dBµV)	Filter	Line	Corr. (dB)	Margin (dB)	Limit (dBµV)
1.486000	33.2	Off	N	19.5	12.8	46.0
1.718000	33.2	Off	N	19.5	12.8	46.0
1.822000	33.5	Off	N	19.6	12.5	46.0
2.014000	33.9	Off	N	19.5	12.1	46.0
2.190000	33.8	Off	N	19.3	12.2	46.0
2.590000	32.4	Off	N	19.5	13.6	46.0
3.142000	33.2	Off	N	19.6	12.8	46.0
3.406000	33.2	Off	N	19.6	12.8	46.0
4.694000	32.7	Off	N	19.6	13.3	46.0
4.958000	33.4	Off	N	19.7	12.6	46.0
9.270000	35.9	Off	N	19.7	14.1	50.0



## **3.7 Antenna Requirements**

### **3.7.1 Standard Applicable**

If directional gain of transmitting antennas is greater than 6dBi, the power shall be reduced by the same level in dB comparing to gain minus 6dBi. The use of a permanently attached antenna or of an antenna that uses a unique coupling to the intentional radiator shall be considered sufficient to comply with the FCC rule.

### **3.7.2 Antenna Anti-Replacement Construction**

An embedded-in antenna design is used.

### **3.7.3 Antenna Gain**

The antenna peak gain of EUT is less than 6 dBi. Therefore, it is not necessary to reduce maximum peak output power limit.



## 4 List of Measuring Equipment

Instrument	Manufacturer	Model No.	Serial No.	Characteristics	Calibration Date	Test Date	Due Date	Remark
Spectrum Analyzer	Rohde & Schwarz	FSP40	100055	9kHz~40GHz	Jun. 09, 2014	Oct. 29, 2014 ~ Nov. 26, 2014	Jun. 08, 2015	Conducted (TH02-HY)
Power Meter	Agilent	E4416A	GB41292344	300MHz~40GHz	Jan. 28, 2014	Oct. 29, 2014 ~ Nov. 26, 2014	Jan. 27, 2015	Conducted (TH02-HY)
Power Sensor	Agilent	E9327A	US40441548	300MHz~40GHz	Jan. 28, 2014	Oct. 29, 2014 ~ Nov. 26, 2014	Jan. 27, 2015	Conducted (TH02-HY)
Spectrum Analyzer	Rohde & Schwarz	FSP40	100055	9kHz~40GHz	Jun. 09, 2014	Nov. 18, 2014 ~ Nov. 19, 2014	Jun. 08, 2015	Radiation (03CH05-HY)
Bilog Antenna	Schaffner	CBL6111C	2725	30MHz~1GHz	Sep. 27, 2014	Nov. 18, 2014 ~ Nov. 19, 2014	Sep. 26, 2015	Radiation (03CH05-HY)
Double Ridged Guide Horn Antenna	SCHWARZBECK	BBHA 9120 D	9120D-1241	1GHz~18GHz	Apr. 16, 2014	Nov. 18, 2014 ~ Nov. 19, 2014	Apr. 15, 2015	Radiation (03CH05-HY)
SHF-EHF Horn Antenna	SCHWARZBECK	BBHA 9170	BBHA9170251	18GHz~40GHz	Oct. 02, 2014	Nov. 18, 2014 ~ Nov. 19, 2014	Oct. 01, 2015	Radiation (03CH05-HY)
Preamplifier	MITEQ	AMF-7D-0010 1800-30-10P	1590074	100kHz~18GHz	Jul. 07, 2014	Nov. 18, 2014 ~ Nov. 19, 2014	Jul. 06, 2015	Radiation (03CH05-HY)
Preamplifier	EMCI	EMC011830	980148	DC~18GHz	Jun. 23, 2014	Nov. 18, 2014 ~ Nov. 19, 2014	Jun. 22, 2015	Radiation (03CH05-HY)
Preamplifier	COM-POWER	PA-103	161075	9kHz~30MHz	Apr. 15, 2014	Nov. 18, 2014 ~ Nov. 19, 2014	Apr. 14, 2015	Radiation (03CH05-HY)
Preamplifier	Miteq	TTA0204	1872107	18GHz~40GHz	May 23, 2014	Nov. 18, 2014 ~ Nov. 19, 2014	May 22, 2015	Radiation (03CH05-HY)
Turn Table	HD	HD100	420/611	0 - 360 degree	N/A	Nov. 18, 2014 ~ Nov. 19, 2014	N/A	Radiation (03CH05-HY)
Antenna Mast	HD	HD100	240/666	1 m - 4 m	N/A	Nov. 18, 2014 ~ Nov. 19, 2014	N/A	Radiation (03CH05-HY)
Loop Antenna	TESEQ	HLA 6120	31244	9 kHz~30 MhZ	Dec. 02, 2012	Nov. 18, 2014 ~ Nov. 19, 2014	Dec. 01, 2014	Radiation (03CH05-HY)
EMI Test Receiver	Rohde & Schwarz	ESCS 30	100356	9kHz ~ 2.75GHz	Nov. 12, 2014	Nov. 13, 2014	Nov. 11, 2015	Conduction (CO05-HY)
LISN (for auxiliary equipment)	Rohde & Schwarz	ENV216	100081	9kHz ~ 30MHz	Dec. 12, 2013	Nov. 13, 2014	Dec. 11, 2014	Conduction (CO05-HY)
LISN	Rohde & Schwarz	ENV216	100080	9kHz ~ 30MHz	Dec. 04, 2013	Nov. 13, 2014	Dec. 03, 2014	Conduction (CO05-HY)
AC Power Source	ChainTek	APC-1000W	N/A	N/A	N/A	Nov. 13, 2014	N/A	Conduction (CO05-HY)





## 5 Uncertainty of Evaluation

### Uncertainty of Conducted Emission Measurement (150 kHz ~ 30 MHz)

Measuring Uncertainty for a Level of Confidence of 95% ( $U = 2Uc(y)$ )	2.26
---	------

### Uncertainty of Radiated Emission Measurement (30 MHz ~ 1000 MHz)

Measuring Uncertainty for a Level of Confidence of 95% ( $U = 2Uc(y)$ )	5.1
---	-----