

FCC Test Report

Report No.: RF191005C06

FCC ID: E2K-T03H004

Test Model: T03H

Series Model: T03H004 (refer to item 3.1 for more details)

Received Date: Oct. 05, 2019

Test Date: Oct. 16 ~ Oct. 25, 2019

Issued Date: Oct. 31, 2019

Applicant: Dell Inc.

Address: One Dell Way, Round Rock, Texas 78682, USA

Issued By: Bureau Veritas Consumer Products Services (H.K.) Ltd., Taoyuan Branch
Lin Kou Laboratories

Lab Address: No. 47-2, 14th Ling, Chia Pau Vil., Lin Kou Dist., New Taipei City, Taiwan

Test Location: No. 19, Hwa Ya 2nd Rd., Wen Hwa Vil., Kwei Shan Dist., Taoyuan City
33383, TAIWAN

**FCC Registration /
Designation Number:** 788550 / TW0003



This report is for your exclusive use. Any copying or replication of this report to or for any other person or entity, or use of our name or trademark, is permitted only with our prior written permission. This report sets forth our findings solely with respect to the test samples identified herein. The results set forth in this report are not indicative or representative of the quality or characteristics of the lot from which a test sample was taken or any similar or identical product unless specifically and expressly noted. Our report includes all of the tests requested by you and the results thereof based upon the information that you provided to us. You have 60 days from date of issuance of this report to notify us of any material error or omission caused by our negligence, provided, however, that such notice shall be in writing and shall specifically address the issue you wish to raise. A failure to raise such issue within the prescribed time shall constitute your unqualified acceptance of the completeness of this report, the tests conducted and the correctness of the report contents. Unless specifically mentioned, the uncertainty of measurement has been explicitly taken into account to declare the compliance or non-compliance to the specification. The report must not be used by the client to claim product certification, approval, or endorsement by TAF or any government agencies.

Table of Contents

Release Control Record	3
1 Certificate of Conformity	4
2 Summary of Test Results	5
2.1 Measurement Uncertainty.....	5
2.2 Modification Record.....	5
3 General Information	6
3.1 General Description of EUT.....	6
3.2 Description of Test Modes.....	8
3.2.1 Test Mode Applicability and Tested Channel Data.....	9
3.3 Description of Support Units.....	10
3.3.1 Configuration of System under Test.....	10
3.4 General Description of Applied Standards.....	10
4 Test Types and Results	11
4.1 Radiated Emission Measurement.....	11
4.1.1 Limits of Radiated Emission Measurement.....	11
4.1.2 Test Instruments.....	12
4.1.3 Test Procedures.....	13
4.1.4 Deviation from Test Standard.....	13
4.1.5 Test Set Up.....	14
4.1.6 EUT Operating Conditions.....	14
4.1.7 Test Results.....	15
4.2 Conducted Emission Measurement.....	47
4.2.1 Limits of Conducted Emission Measurement.....	47
4.2.2 Test Instruments.....	47
4.2.3 Test Procedures.....	48
4.2.4 Deviation from Test Standard.....	48
4.2.5 Test Setup.....	48
4.2.6 EUT Operating Conditions.....	48
4.2.7 Test Results.....	49
4.3 Frequency Stability.....	57
4.3.1 Limits of Frequency Stability Measurement.....	57
4.3.2 Test Setup.....	57
4.3.3 Test Instruments.....	57
4.3.4 Test Procedure.....	57
4.3.5 Deviation from Test Standard.....	58
4.3.6 EUT Operating Conditions.....	58
4.3.7 Test Result.....	58
4.4 20dB Bandwidth.....	59
4.4.1 Limits of 20dB Bandwidth Measurement.....	59
4.4.2 Test Setup.....	59
4.4.3 Test Instruments.....	59
4.4.4 Test Procedures.....	59
4.4.5 Deviation from Test Standard.....	59
4.4.6 EUT Operating Conditions.....	59
4.4.7 Test Results.....	60
5 Pictures of Test Arrangements	64
Appendix – Information of the Testing Laboratories	65

Release Control Record

Issue No.	Description	Date Issued
RF191005C06	Original release	Oct. 31, 2019

1 Certificate of Conformity

Product: Tablet PC

Brand: DELL

Test Model: T03H

Series Model: T03H004 (refer to item 3.1 for more details)

Sample Status: Engineering sample

Applicant: Dell Inc.

Test Date: Oct. 16 ~ Oct. 25, 2019

Standards: 47 CFR FCC Part 15, Subpart C (Section 15.225)
47 CFR FCC Part 15, Subpart C (Section 15.215)
ANSI C63.10:2013

The above equipment has been tested by **Bureau Veritas Consumer Products Services (H.K.) Ltd., Taoyuan Branch**, and found compliance with the requirement of the above standards. The test record, data evaluation & Equipment Under Test (EUT) configurations represented herein are true and accurate accounts of the measurements of the sample's RF characteristics under the conditions specified in this report.

Prepared by : Celine Chou , **Date:** Oct. 31, 2019
Celine Chou / Senior Specialist

Approved by : Bruce Chen , **Date:** Oct. 31, 2019
Bruce Chen / Senior Project Engineer

2 Summary of Test Results

47 CFR FCC Part 15, Subpart C (Section 15.225, 15.215)			
FCC Clause	Test Item	Result	Remarks
15.207	Conducted emission test	Pass	Meet the requirement of limit. Minimum passing margin is -3.15dB at 13.56200MHz
15.225 (a)	The field strength of any emissions within the band 13.553-13.567 MHz	Pass	Meet the requirement of limit. Minimum passing margin is -61.3dB at 13.56MHz.
15.225 (b)	The field strength of any emissions within the bands 13.410-13.553 MHz and 13.567-13.710 MHz	Pass	Meet the requirement of limit.
15.225 (c)	The field strength of any emissions within the bands 13.110-13.410 MHz and 13.710-14.010 MHz	Pass	Meet the requirement of limit.
15.225 (d)	The field strength of any emissions appearing outside of the 13.110-14.010 MHz band	Pass	Meet the requirement of limit. Minimum passing margin is -1.3dB at 298.32MHz.
15.225 (e)	The frequency tolerance	Pass	Meet the requirement of limit.
15.215 (c)	20dB Bandwidth	Pass	Meet the requirement of limit.

Note: Determining compliance based on the results of the compliance measurement, not taking into account measurement instrumentation uncertainty.

2.1 Measurement Uncertainty

Where relevant, the following measurement uncertainty levels have been estimated for tests performed on the EUT as specified in CISPR 16-4-2:

Measurement	Frequency	Expanded Uncertainty (k=2) (±)
Conducted Emissions at mains ports	150kHz ~ 30MHz	2.79 dB
Radiated Emissions up to 1 GHz	9kHz ~ 30MHz	3.04 dB
	30MHz ~ 200MHz	3.86 dB
	200MHz ~ 1000MHz	3.87 dB

2.2 Modification Record

There were no modifications required for compliance.

3 General Information

3.1 General Description of EUT

Product	Tablet PC
Brand	DELL
Test Model	T03H
Series Model	T03H004
Model Difference	For marketing purpose.
Sample Status	Engineering sample
Power Supply Rating	5Vdc / 9Vdc / 15Vdc / 19.5Vdc /20Vdc (adapter) 7.6Vdc (Battery)
Modulation Type	ASK
Operating Frequency	13.56MHz
Data Rate	Type A: 106kbit/s Type B: 106kbit/s Type F: 424kbit/s Type V: 848kbit/s
Field Strength	Type A: 62.6dBuV/m (3m) Type B: 62.7dBuV/m (3m) Type F: 62.6dBuV/m (3m) Type V: 62.6dBuV/m (3m)
Antenna Type	Loop Antenna
Antenna Connector	NA
Accessory Device	Adapter (optional), Battery
Cable Supplied	NA

Note:

1. The EUT consumes power from the following adapters (optional) and battery.

Adapter 1	
Brand	DELL
Model	LA90PM170
Input Power	100-240Vac, ~50-60Hz, 1.5A
Output Power	5V / 9V / 15V / 20V / 3A / 3A / 3A / 4.5A
Power cord	1.8m cable without core attached on adapter

Adapter 2	
Brand	DELL
Model	HA65NM170
Input Power	100-240Vac, ~50-60Hz, 1.7A
Output Power	5V / 9V / 15V / 20V / 3A / 3A / 3A /3.25A
Power cord	1.8m cable without core attached on adapter

Adapter 3	
Brand	DELL
Model	HA45NM170
Input Power	100-240Vac, ~50-60Hz, 1.3A
Output Power	5V / 9V / 15V / 20V / 3A / 3A / 3A / 2.25A
Power cord	1.8m cable without core attached on adapter

Adapter 4	
Brand	DELL
Model	LA45NM131
Input Power	100-240Vac, ~50/60Hz, 1.3A
Output Power	19.5V / 2.31A
Power cord	1.98m cable without core attached on adapter

Adapter 5	
Brand	DELL
Model	LA45NM171
Input Power	100-240Vac, ~50/60Hz, 1.3A
Output Power	5V/9V/15V/20V/3A/3A/3A/2.25A
Power cord	1.78m cable without core attached on adapter

Adapter 6	
Brand	DELL
Model	LA65NM170
Input Power	100-240Vac, ~50/60Hz, 1.7A
Output Power	5V/9V/15V/20V/3A/3A/3A/2.25A
Power cord	1.77m cable without core attached on adapter

Adapter 7	
Brand	DELL
Model	LA90PM111
Input Power	100-240Vac, ~50-60Hz, 1.5A
Output Power	19.5Vdc / 4.62A
Power cord	1.75m cable with 1 core attached on adapter

Adapter 8	
Brand	DELL
Model	DA90PM170
Input Power	100-240Vac, ~50-60Hz, 1.5A
Output Power	20V / 15V / 9V / 5V / 4.5A / 3 / 3 / 3A
Power cord	1.8m cable without core attached on adapter

Adapter 9	
Brand	DELL
Model	DA65NM170
Input Power	100-240Vac, ~50-60Hz, 1.7A
Output Power	20V / 15V / 9V / 5V / 3.25 / 3 / 3 / 3A
Power cord	1.8m cable without core attached on adapter

Adapter 10	
Brand	DELL
Model	DA45NM170
Input Power	100-240Vac, ~50-60Hz, 1.3A
Output Power	20V / 15V / 9V / 5V / 2.25 / 3 / 3 / 3A
Power cord	1.8m cable without core attached on adapter

Adapter 11	
Brand	DELL
Model	DA45NM131
Input Power	100-240Vac, ~50-60Hz, 1.3A
Output Power	19.5V / 2.31A
Power cord	2m cable without core attached on adapter

Adapter 12	
Brand	DELL
Model	LA45NM140
Input Power	100-240Vac, ~50-60Hz, 1.3A
Output Power	19.5V / 2.31A
Power cord	1.75m cable with one core attached on adapter

Adapter 13	
Brand	DELL
Model	HA45NM140
Input Power	100-240Vac, ~50-60Hz, 1.3A
Output Power	19.5V / 2.31A
Power cord	1.75m cable with one core attached on adapter

Battery	
Brand	(DELL) SIMPLO
Model	J7HTX
Power Rating	7.6Vdc, 34WH, 4342mAh

* After pre-test, adapter 1 was chosen for final test and presented in the test report.

3.2 Description of Test Modes

1 channel is provided to this EUT

Channel	Freq. (MHz)
1	13.56

3.2.1 Test Mode Applicability and Tested Channel Data

EUT Configure Mode	Applicable to				Description
	RE	PLC	FS	EB	
-	√	√	√	√	-

Where RE: Radiated Emission
 FS: Frequency Stability
 PLC: Power Line Conducted Emission
 EB: 20dB Bandwidth measurement

Note: The EUT had been pre-tested on the positioned of each 3 axis. The worst case was found when positioned on **Y-plane**.

Radiated Emission Test:

- Pre-Scan has been conducted to determine the worst-case mode from all possible combinations between available modulations, data rates and antenna ports (if EUT with antenna diversity architecture).
- Following channel(s) was (were) selected for the final test as listed below.

EUT Configure Mode	Available Channel	Tested Channel	Modulation Type	Data Rate
-	1	1	ASK	Type A: 106kbit/s
-	1	1	ASK	Type B: 106kbit/s
-	1	1	ASK	Type F: 424kbit/s
-	1	1	ASK	Type V: 848kbit/s

Power Line Conducted Emission Test:

- Pre-Scan has been conducted to determine the worst-case mode from all possible combinations between available modulations, data rates and antenna ports (if EUT with antenna diversity architecture).
- Following channel(s) was (were) selected for the final test as listed below.

EUT Configure Mode	Available Channel	Tested Channel	Modulation Type	Data Rate
-	1	1	ASK	Type A: 106kbit/s
-	1	1	ASK	Type B: 106kbit/s
-	1	1	ASK	Type F: 424kbit/s
-	1	1	ASK	Type V: 848kbit/s

Frequency Stability:

- Pre-Scan has been conducted to determine the worst-case mode from all possible combinations between available modulations, data rates and antenna ports (if EUT with antenna diversity architecture).
- Following channel(s) was (were) selected for the final test as listed below.

EUT Configure Mode	Available Channel	Tested Channel	Modulation Type	Data Rate
-	1	1	ASK	Type B: 106kbit/s

20dB Bandwidth:

- Pre-Scan has been conducted to determine the worst-case mode from all possible combinations between available modulations, data rates and antenna ports (if EUT with antenna diversity architecture).
- Following channel(s) was (were) selected for the final test as listed below.

EUT Configure Mode	Available Channel	Tested Channel	Modulation Type	Data Rate
-	1	1	ASK	Type A: 106kbit/s
-	1	1	ASK	Type B: 106kbit/s
-	1	1	ASK	Type F: 424kbit/s
-	1	1	ASK	Type V: 848kbit/s

Test Condition:

Applicable to	Environmental Conditions	Input Power	Tested by
RE	23 deg. C, 66% RH	120Vac, 60Hz	Titan Hsu
PLC	23 deg. C, 66% RH	120Vac, 60Hz	Titan Hsu
FS	23 deg. C, 66% RH	120Vac, 60Hz	Titan Hsu
BW	23 deg. C, 66% RH	120Vac, 60Hz	Titan Hsu

3.3 Description of Support Units

The EUT has been tested as an independent unit together with other necessary accessories or support units.

3.3.1 Configuration of System under Test

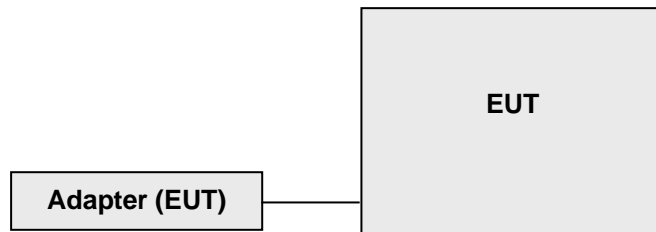

3.4 General Description of Applied Standards

The EUT is a RF Product. According to the specifications of the manufacturer, it must comply with the requirements of the following standards:

FCC Part 15, Subpart C (15.225)

FCC Part 15, Subpart C (15.215)

ANSI C63.10-2013

All test items have been performed and recorded as per the above standards.

4 Test Types and Results

4.1 Radiated Emission Measurement

4.1.1 Limits of Radiated Emission Measurement

The field strength of any emissions within the band 13.553-13.567 MHz shall not exceed 15,848 microvolts/meter at 30 meters.

Within the bands 13.410-13.553 MHz and 13.567-13.710 MHz, the field strength of any emissions shall not exceed 334 microvolts/meter at 30 meters.

Within the bands 13.110-13.410 MHz and 13.710-14.010 MHz the field strength of any emissions shall not exceed 106 microvolts/meter at 30 meters.

The field strength of any emissions appearing outside of the 13.110-14.010 MHz band shall not exceed the general radiated emission limits in § 15.209.

Frequencies (MHz)	Field Strength (microvolts/meter)	Measurement Distance (meters)
0.009 ~ 0.490	2400/F(kHz)	300
0.490 ~ 1.705	24000/F(kHz)	30
1.705 ~ 30.0	30	30
30 ~ 88	100	3
88 ~ 216	150	3
216 ~ 960	200	3
Above 960	500	3

Note:

1. The lower limit shall apply at the transition frequencies.
2. Emission level (dBuV/m) = 20 log Emission level (uV/m).
3. For frequencies above 1000MHz, the field strength limits are based on average detector, however, the peak field strength of any emission shall not exceed the maximum permitted average limits, specified above by more than 20dB under any condition of modulation.

4.1.2 Test Instruments

Description & Manufacturer	Model No.	Serial No.	Cal. Date	Cal. Due
Test Receiver ROHDE & SCHWARZ	ESIB7	100187	May 30, 2019	May 29, 2020
BILOG Antenna SCHWARZBECK	VULB9168	9168-171	Nov. 22, 2018	Nov. 21, 2019
HORN Antenna SCHWARZBECK	9120D	209	Nov. 25, 2018	Nov. 24, 2019
HORN Antenna SCHWARZBECK	BBHA 9170	BBHA9170241	Nov. 25, 2018	Nov. 24, 2019
Loop Antenna TESEQ	HLA 6121	45745	Jul. 01, 2019	Jun. 30, 2020
Preamplifier Agilent (Below 1GHz)	8447D	2944A10738	Aug. 20, 2019	Aug. 19, 2020
Preamplifier Agilent (Above 1GHz)	8449B	3008A02465	Mar. 27, 2019	Mar. 26, 2020
RF Coaxial Cable WOKEN With 5dB PAD	8D-FB	Cable-CH3-01	Aug. 20, 2019	Aug. 19, 2020
RF signal cable HUBER+SUHNER	SUCOFLEX 104	Cable-CH3-03 (223653/4)	Aug. 20, 2019	Aug. 19, 2020
RF signal cable HUBER+SUHNER& EMCI	SUCOFLEX 104&EMC104-SM-S M-8000	Cable-CH3-03 (309224+170907)	Aug. 20, 2019	Aug. 19, 2020
Software BV ADT	ADT_Radiated_ V7.6.15.9.5	NA	NA	NA
Antenna Tower inn-co GmbH	MA 4000	013303	NA	NA
Antenna Tower Controller BV ADT	AT100	AT93021702	NA	NA
Turn Table BV ADT	TT100	TT93021702	NA	NA
Turn Table Controller BV ADT	SC100	SC93021702	NA	NA
Boresight Antenna Fixture	FBA-01	FBA-SIP01	NA	NA

Note: 1. The calibration interval of the above test instruments is 12 months and the calibrations are traceable to NML/ROC and NIST/USA.
2. The test was performed in HwaYa Chamber 3.

4.1.3 Test Procedures

For Radiated emission below 30MHz

- a. The EUT was placed on the top of a rotating table 0.8 meters above the ground at a 3 meter chamber room. The table was rotated 360 degrees to determine the position of the highest radiation.
- b. The EUT was set 3 meters away from the interference-receiving antenna, which was mounted on the top of a variable-height antenna tower.
- c. Parallel, perpendicular, and ground-parallel orientations of the antenna are set to make the measurement.
- d. For each suspected emission, the EUT was arranged to its worst case and the rotatable table was turned from 0 degrees to 360 degrees to find the maximum reading.
- e. The test-receiver system was set to Quasi-Peak Detect Function and Specified Bandwidth with Maximum Hold Mode.

Note:

1. The resolution bandwidth and video bandwidth of test receiver/spectrum analyzer is 9kHz at frequency below 30MHz.
2. There is a comparison data of both open-field test site and semi-Anechoic chamber, and the result came out very similar.

For Radiated emission above 30MHz

- a. The EUT was placed on the top of a rotating table 0.8 meters (for 30MHz ~ 1GHz) / 1.5 meters (for above 1GHz) above the ground at 3 meter chamber room for test. The table was rotated 360 degrees to determine the position of the highest radiation.
- b. The EUT was set 3 meters away from the interference-receiving antenna, which was mounted on the top of a variable-height antenna tower.
- c. The height of antenna is varied from one meter to four meters above the ground to determine the maximum value of the field strength. Both horizontal and vertical polarizations of the antenna are set to make the measurement.
- d. For each suspected emission, the EUT was arranged to its worst case and then the antenna was tuned to heights from 1 meter to 4 meters and the rotatable table was turned from 0 degrees to 360 degrees to find the maximum reading.
- e. The test-receiver system was set to quasi-peak detect function and specified bandwidth with maximum hold mode when the test frequency is below 1 GHz.
- f. The test-receiver system was set to peak and average detect function and specified bandwidth with maximum hold mode when the test frequency is above 1 GHz. If the peak reading value also meets average limit, measurement with the average detector is unnecessary.

Note:

1. The resolution bandwidth and video bandwidth of test receiver/spectrum analyzer is 120kHz for Quasi-peak detection (QP) at frequency below 1GHz.
2. The resolution bandwidth of test receiver/spectrum analyzer is 1 MHz and the video bandwidth is 3 MHz for Peak detection (PK) at frequency above 1GHz.
3. The resolution bandwidth of test receiver/spectrum analyzer is 1MHz and the video bandwidth is $\geq 1/T$ (Duty cycle < 98%) or 10Hz (Duty cycle $\geq 98\%$) for Average detection (AV) at frequency above 1GHz.
4. All modes of operation were investigated and the worst-case emissions are reported.

4.1.4 Deviation from Test Standard

No deviation.

4.1.5 Test Set Up

For Radiated emission below 30MHz

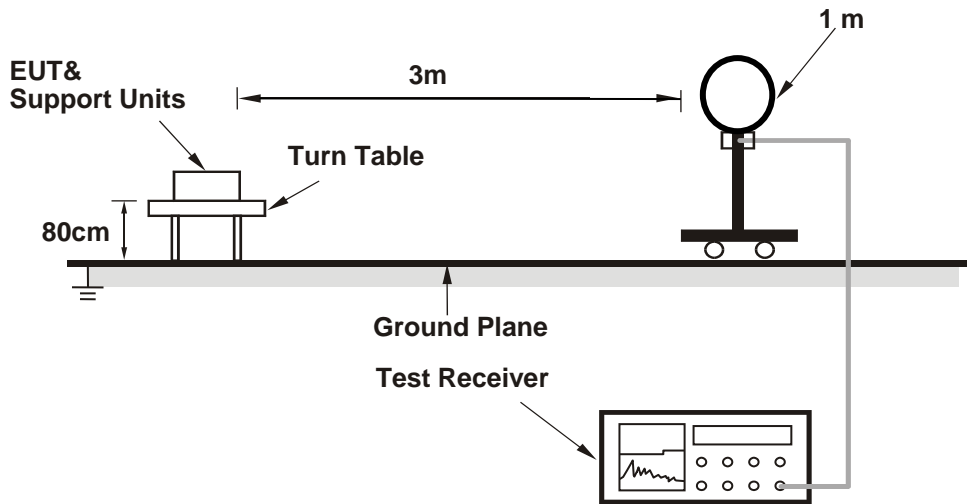

For Radiated emission 30MHz to 1GHz

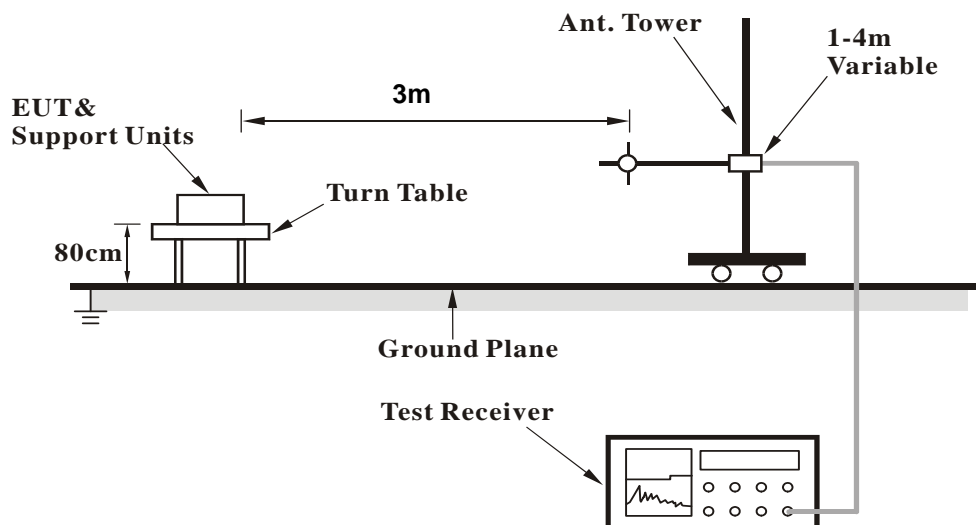

For the actual test configuration, please refer to the attached file (Test Setup Photo).

4.1.6 EUT Operating Conditions

- a. Set the EUT under transmission condition continuously at specific channel frequency.

4.1.7 Test Results

Type A

EUT Test Condition		Measurement Detail	
Channel	Channel 1	Frequency Range	13.553 ~ 13.567MHz
Input Power	120Vac, 60Hz	Detector Function	Quasi-Peak
Environmental Conditions	23 deg. C, 66% RH	Tested By	Titan Hsu

Antenna Polarity & Test Distance: Loop Antenna Parallel At 3m								
No.	Freq. (MHz)	Emission Level (dBuV/m)	Limit (dBuV/m)	Margin (dB)	Antenna Height (m)	Table Angle (Degree)	Raw Value (dBuV)	Correction Factor (dB/m)
1	*13.56	62.6 QP	124.0	-61.4	1.00 V	159	40.8	21.8

Remarks:

1. Emission Level(dBuV/m) = Raw Value(dBuV) + Correction Factor(dB/m)
2. Correction Factor(dB/m) = Antenna Factor(dB/m) + Cable Factor(dB) – Pre-Amplifier Factor(dB)
3. The other emission levels were very low against the limit.
4. Margin value = Emission Level – Limit value
5. “ * “ : Fundamental frequency
6. Above limits have been translated by the formula

The measured field strength was extrapolated to distance 30 meters, using the formula that the limit of field strength varies as the inverse distance square (40dB per decade of distance)

Example:

$$\begin{aligned}
 13.56\text{MHz} &= 15848\mu\text{V/m} && 30\text{m} \\
 &= 84\text{dBuV/m} && 30\text{m} \\
 &= 84+20\log(30/3)^2 && 3\text{m} \\
 &= 124\text{dBuV/m}
 \end{aligned}$$

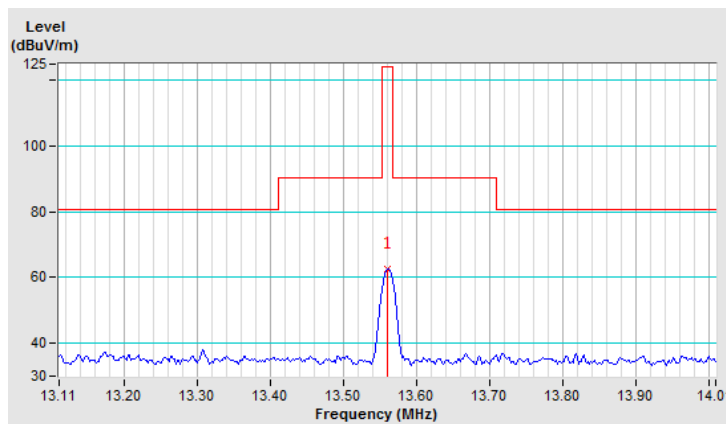

Antenna Polarity & Test Distance: Loop Antenna Parallel At 30m				
No.	Freq. (MHz)	Emission Level (dBuV/m)	Limit (dBuV/m)	Margin (dB)
1	*13.56	22.6 QP	84.0	-61.4

Remarks: Emission Level at 30m = Emission Level at 3m + 20log(3/30)²

EUT Test Condition		Measurement Detail	
Channel	Channel 1	Frequency Range	13.553 ~ 13.567MHz
Input Power	120Vac, 60Hz	Detector Function	Quasi-Peak
Environmental Conditions	23 deg. C, 66% RH	Tested By	Titan Hsu

Antenna Polarity & Test Distance: Loop Antenna Perpendicular At 3m								
No.	Freq. (MHz)	Emission Level (dBuV/m)	Limit (dBuV/m)	Margin (dB)	Antenna Height (m)	Table Angle (Degree)	Raw Value (dBuV)	Correction Factor (dB/m)
1	*13.56	59.8 QP	124.0	-64.2	1.00 V	86	38.0	21.8

Remarks:

1. Emission Level(dBuV/m) = Raw Value(dBuV) + Correction Factor(dB/m)
2. Correction Factor(dB/m) = Antenna Factor(dB/m) + Cable Factor(dB) – Pre-Amplifier Factor(dB)
3. The other emission levels were very low against the limit.
4. Margin value = Emission Level – Limit value
5. “ * ” : Fundamental frequency
6. Above limits have been translated by the formula

The measured field strength was extrapolated to distance 30 meters, using the formula that the limit of field strength varies as the inverse distance square (40dB per decade of distance)

Example:

$$\begin{aligned}
 13.56\text{MHz} &= 15848\mu\text{V/m} && 30\text{m} \\
 &= 84\text{dBuV/m} && 30\text{m} \\
 &= 84+20\log(30/3)^2 && 3\text{m} \\
 &= 124\text{dBuV/m}
 \end{aligned}$$

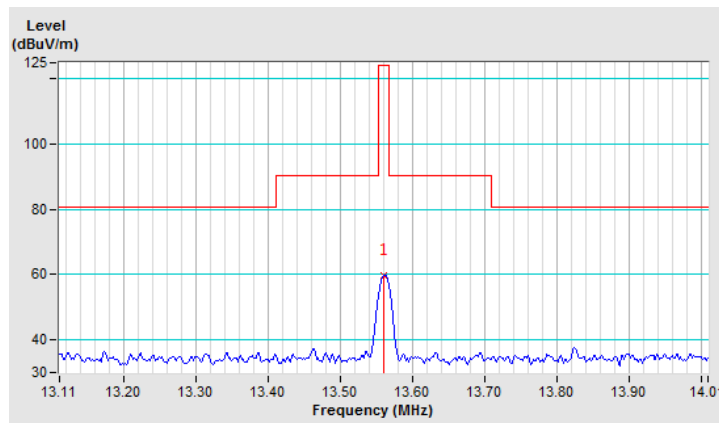

Antenna Polarity & Test Distance: Loop Antenna Perpendicular At 30m				
No.	Freq. (MHz)	Emission Level (dBuV/m)	Limit (dBuV/m)	Margin (dB)
1	*13.56	19.8 QP	84.0	-64.2

Remarks: Emission Level at 30m = Emission Level at 3m + 20log(3/30)²

EUT Test Condition		Measurement Detail	
Channel	Channel 1	Frequency Range	13.553 ~ 13.567MHz
Input Power	120Vac, 60Hz	Detector Function	Quasi-Peak
Environmental Conditions	23 deg. C, 66% RH	Tested By	Titan Hsu

Antenna Polarity & Test Distance: Loop Antenna Ground-Parallel At 3m								
No.	Freq. (MHz)	Emission Level (dBuV/m)	Limit (dBuV/m)	Margin (dB)	Antenna Height (m)	Table Angle (Degree)	Raw Value (dBuV)	Correction Factor (dB/m)
1	*13.56	54.6 QP	124.0	-69.4	1.00 V	5	32.8	21.8

Remarks:

1. Emission Level(dBuV/m) = Raw Value(dBuV) + Correction Factor(dB/m)
2. Correction Factor(dB/m) = Antenna Factor(dB/m) + Cable Factor(dB) – Pre-Amplifier Factor(dB)
3. The other emission levels were very low against the limit.
4. Margin value = Emission Level – Limit value
5. “ * ” : Fundamental frequency
6. Above limits have been translated by the formula

The measured field strength was extrapolated to distance 30 meters, using the formula that the limit of field strength varies as the inverse distance square (40dB per decade of distance)

Example:

$$\begin{aligned}
 13.56\text{MHz} &= 15848\mu\text{V/m} && 30\text{m} \\
 &= 84\text{dBuV/m} && 30\text{m} \\
 &= 84+20\log(30/3)^2 && 3\text{m} \\
 &= 124\text{dBuV/m}
 \end{aligned}$$

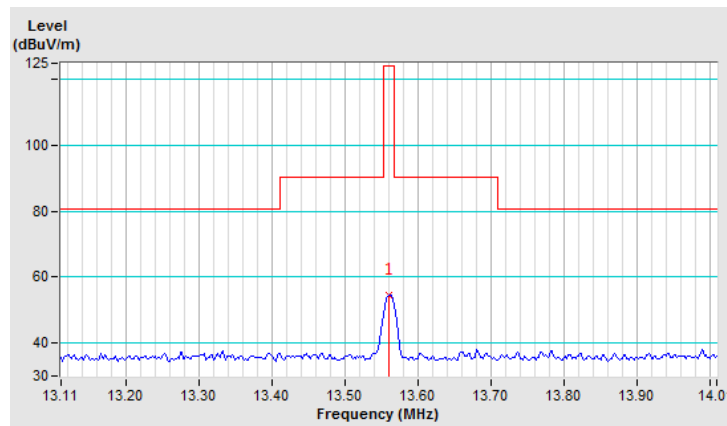

Antenna Polarity & Test Distance: Loop Antenna Ground-Parallel At 30m				
No.	Freq. (MHz)	Emission Level (dBuV/m)	Limit (dBuV/m)	Margin (dB)
1	*13.56	14.6 QP	84.0	-69.4

Remarks: Emission Level at 30m = Emission Level at 3m + 20log(3/30)²

EUT Test Condition		Measurement Detail	
Channel	Channel 1	Frequency Range	Below 30MHz
Input Power	120Vac, 60Hz	Detector Function	Quasi-Peak
Environmental Conditions	23 deg. C, 66% RH	Tested By	Titan Hsu

Antenna Polarity & Test Distance: Loop Antenna Parallel At 3m								
No.	Freq. (MHz)	Emission Level (dBuV/m)	Limit (dBuV/m)	Margin (dB)	Antenna Height (m)	Table Angle (Degree)	Raw Value (dBuV)	Correction Factor (dB/m)
1	2.29	37.5 QP	69.5	-32.0	1.00 V	137	17.6	19.9
2	5.71	35.2 QP	69.5	-34.3	1.00 V	137	14.9	20.3
3	10.51	38.4 QP	69.5	-31.1	1.00 V	105	16.7	21.7
4	15.78	39.2 QP	69.5	-30.3	1.00 V	3	17.3	21.9
5	19.20	44.2 QP	69.5	-25.3	1.00 V	11	22.1	22.1
6	22.32	41.1 QP	69.5	-28.4	1.00 V	11	19.0	22.1

Remarks:

1. Emission Level(dBuV/m) = Raw Value(dBuV) + Correction Factor(dB/m)
2. Correction Factor(dB/m) = Antenna Factor(dB/m) + Cable Factor(dB) – Pre-Amplifier Factor(dB)
3. The other emission levels were very low against the limit.
4. Margin value = Emission Level – Limit value

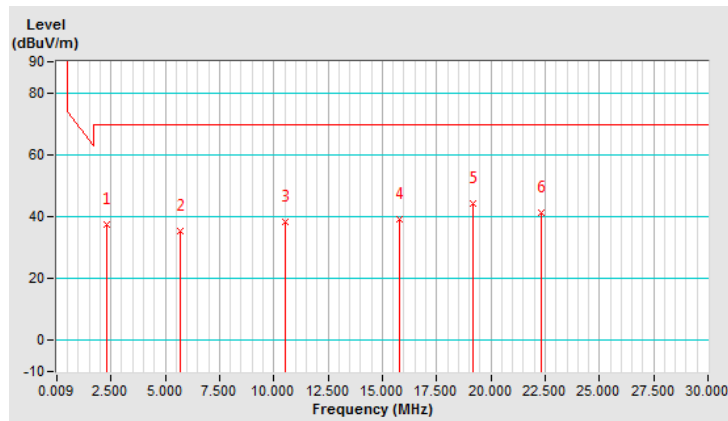

EUT Test Condition		Measurement Detail	
Channel	Channel 1	Frequency Range	Below 30MHz
Input Power	120Vac, 60Hz	Detector Function	Quasi-Peak
Environmental Conditions	23 deg. C, 66% RH	Tested By	Titan Hsu

Antenna Polarity & Test Distance: Loop Antenna Perpendicular At 3m								
No.	Freq. (MHz)	Emission Level (dBuV/m)	Limit (dBuV/m)	Margin (dB)	Antenna Height (m)	Table Angle (Degree)	Raw Value (dBuV)	Correction Factor (dB/m)
1	2.05	37.6 QP	69.5	-31.9	1.00 V	222	17.7	19.9
2	5.47	35.3 QP	69.5	-34.2	1.00 V	143	15.1	20.2
3	6.61	36.4 QP	69.5	-33.1	1.00 V	154	15.8	20.6
4	11.59	36.7 QP	69.5	-32.8	1.00 V	1	15.0	21.7
5	19.32	38.5 QP	69.5	-31.0	1.00 V	15	16.4	22.1
6	22.92	40.4 QP	69.5	-29.1	1.00 V	59	18.3	22.1

Remarks:

1. Emission Level(dBuV/m) = Raw Value(dBuV) + Correction Factor(dB/m)
2. Correction Factor(dB/m) = Antenna Factor(dB/m) + Cable Factor(dB) – Pre-Amplifier Factor(dB)
3. The other emission levels were very low against the limit.
4. Margin value = Emission Level – Limit value

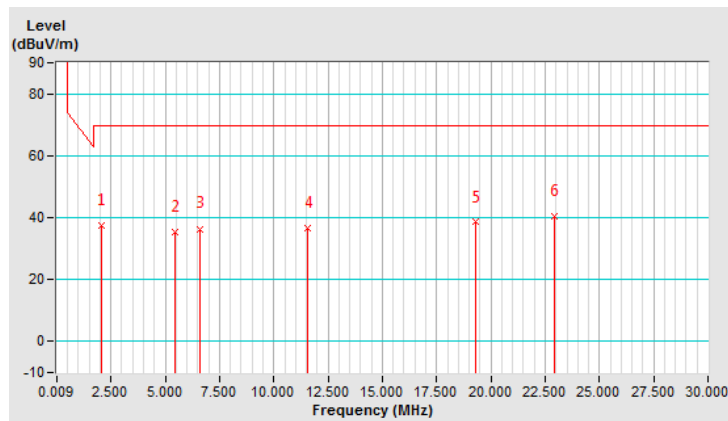

EUT Test Condition		Measurement Detail	
Channel	Channel 1	Frequency Range	Below 30MHz
Input Power	120Vac, 60Hz	Detector Function	Quasi-Peak
Environmental Conditions	23 deg. C, 66% RH	Tested By	Titan Hsu

Antenna Polarity & Test Distance: Loop Antenna Ground-Parallel At 3m								
No.	Freq. (MHz)	Emission Level (dBuV/m)	Limit (dBuV/m)	Margin (dB)	Antenna Height (m)	Table Angle (Degree)	Raw Value (dBuV)	Correction Factor (dB/m)
1	3.55	37.5 QP	69.5	-32.0	1.00 V	94	17.5	20.0
2	7.03	35.8 QP	69.5	-33.7	1.00 V	305	15.1	20.7
3	10.93	35.9 QP	69.5	-33.6	1.00 V	352	14.2	21.7
4	16.80	37.9 QP	69.5	-31.6	1.00 V	268	15.9	22.0
5	20.70	41.1 QP	69.5	-28.4	1.00 V	197	19.0	22.1
6	23.16	44.7 QP	69.5	-24.8	1.00 V	137	22.6	22.1

Remarks:

1. Emission Level(dBuV/m) = Raw Value(dBuV) + Correction Factor(dB/m)
2. Correction Factor(dB/m) = Antenna Factor(dB/m) + Cable Factor(dB) – Pre-Amplifier Factor(dB)
3. The other emission levels were very low against the limit.
4. Margin value = Emission Level – Limit value

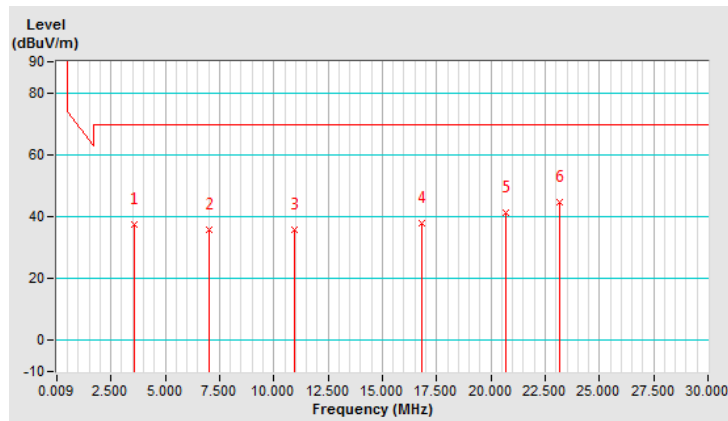

EUT Test Condition		Measurement Detail	
Channel	Channel 1	Frequency Range	Below 1000MHz
Input Power	120Vac, 60Hz	Detector Function	Quasi-Peak
Environmental Conditions	23 deg. C, 66% RH	Tested By	Titan Hsu

Antenna Polarity & Test Distance: Horizontal At 3m								
No.	Freq. (MHz)	Emission Level (dBuV/m)	Limit (dBuV/m)	Margin (dB)	Antenna Height (m)	Table Angle (Degree)	Raw Value (dBuV)	Correction Factor (dB/m)
1	70.77	27.8 QP	40.0	-12.2	2.01 H	31	39.0	-11.2
2	155.13	28.0 QP	43.5	-15.5	1.50 H	18	36.7	-8.7
3	243.70	39.4 QP	46.0	-6.6	1.01 H	14	48.8	-9.4
4	298.32	44.7 QP	46.0	-1.3	1.00 H	204	52.2	-7.5
5	325.25	37.8 QP	46.0	-8.2	1.01 H	221	44.5	-6.7
6	613.47	28.9 QP	46.0	-17.1	2.01 H	281	27.6	1.3

Remarks:

1. Emission Level(dBuV/m) = Raw Value(dBuV) + Correction Factor(dB/m)
2. Correction Factor(dB/m) = Antenna Factor(dB/m) + Cable Factor(dB) – Pre-Amplifier Factor(dB)
3. The other emission levels were very low against the limit.
4. Margin value = Emission Level – Limit value

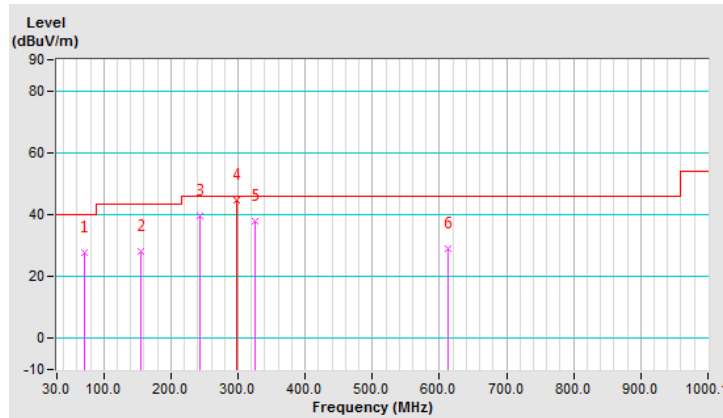

EUT Test Condition		Measurement Detail	
Channel	Channel 1	Frequency Range	Below 1000MHz
Input Power	120Vac, 60Hz	Detector Function	Quasi-Peak
Environmental Conditions	23 deg. C, 66% RH	Tested By	Titan Hsu

Antenna Polarity & Test Distance: Vertical At 3m								
No.	Freq. (MHz)	Emission Level (dBuV/m)	Limit (dBuV/m)	Margin (dB)	Antenna Height (m)	Table Angle (Degree)	Raw Value (dBuV)	Correction Factor (dB/m)
1	49.68	33.8 QP	40.0	-6.2	1.00 V	16	42.8	-9.0
2	104.51	28.2 QP	43.5	-15.3	1.00 V	50	40.6	-12.4
3	138.26	26.4 QP	43.5	-17.1	2.00 V	3	35.6	-9.2
4	298.53	38.7 QP	46.0	-7.3	2.00 V	137	46.2	-7.5
5	484.12	25.4 QP	46.0	-20.6	1.00 V	13	27.3	-1.9
6	666.89	29.5 QP	46.0	-16.5	1.00 V	353	27.9	1.6

Remarks:

1. Emission Level(dBuV/m) = Raw Value(dBuV) + Correction Factor(dB/m)
2. Correction Factor(dB/m) = Antenna Factor(dB/m) + Cable Factor(dB) – Pre-Amplifier Factor(dB)
3. The other emission levels were very low against the limit.
4. Margin value = Emission Level – Limit value

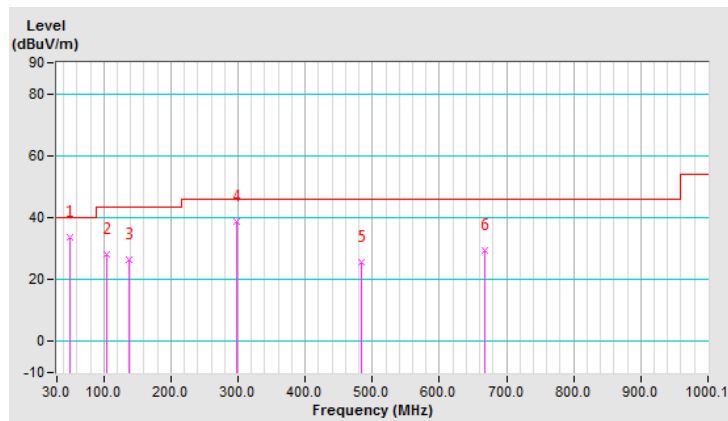

Type B

EUT Test Condition		Measurement Detail	
Channel	Channel 1	Frequency Range	13.553 ~ 13.567MHz
Input Power	120Vac, 60Hz	Detector Function	Quasi-Peak
Environmental Conditions	23 deg. C, 66% RH	Tested By	Titan Hsu

Antenna Polarity & Test Distance: Loop Antenna Parallel At 3m								
No.	Freq. (MHz)	Emission Level (dBuV/m)	Limit (dBuV/m)	Margin (dB)	Antenna Height (m)	Table Angle (Degree)	Raw Value (dBuV)	Correction Factor (dB/m)
1	*13.56	62.7 QP	124.0	-61.3	0.00 V	156	40.9	21.8

Remarks:

1. Emission Level(dBuV/m) = Raw Value(dBuV) + Correction Factor(dB/m)
2. Correction Factor(dB/m) = Antenna Factor(dB/m) + Cable Factor(dB) – Pre-Amplifier Factor(dB)
3. The other emission levels were very low against the limit.
4. Margin value = Emission Level – Limit value
5. “ * ” : Fundamental frequency
6. Above limits have been translated by the formula

The measured field strength was extrapolated to distance 30 meters, using the formula that the limit of field strength varies as the inverse distance square (40dB per decade of distance)

Example:

$$\begin{aligned}
 13.56\text{MHz} &= 15848\mu\text{V/m} && 30\text{m} \\
 &= 84\text{dBuV/m} && 30\text{m} \\
 &= 84+20\log(30/3)^2 && 3\text{m} \\
 &= 124\text{dBuV/m}
 \end{aligned}$$

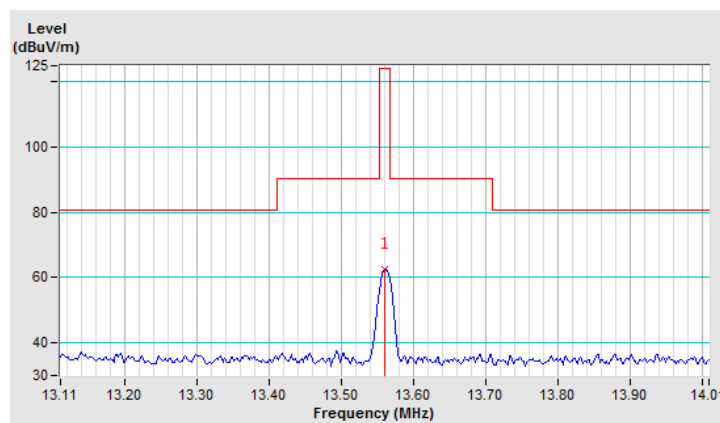

Antenna Polarity & Test Distance: Loop Antenna Parallel At 30m				
No.	Freq. (MHz)	Emission Level (dBuV/m)	Limit (dBuV/m)	Margin (dB)
1	*13.56	22.7 QP	84.0	-61.3

Remarks: Emission Level at 30m = Emission Level at 3m + 20log(3/30)²

EUT Test Condition		Measurement Detail	
Channel	Channel 1	Frequency Range	13.553 ~ 13.567MHz
Input Power	120Vac, 60Hz	Detector Function	Quasi-Peak
Environmental Conditions	23 deg. C, 66% RH	Tested By	Titan Hsu

Antenna Polarity & Test Distance: Loop Antenna Perpendicular At 3m								
No.	Freq. (MHz)	Emission Level (dBuV/m)	Limit (dBuV/m)	Margin (dB)	Antenna Height (m)	Table Angle (Degree)	Raw Value (dBuV)	Correction Factor (dB/m)
1	*13.56	60.1 QP	124.0	-63.9	1.00 V	90	38.3	21.8

Remarks:

1. Emission Level(dBuV/m) = Raw Value(dBuV) + Correction Factor(dB/m)
2. Correction Factor(dB/m) = Antenna Factor(dB/m) + Cable Factor(dB) – Pre-Amplifier Factor(dB)
3. The other emission levels were very low against the limit.
4. Margin value = Emission Level – Limit value
5. “ * ” : Fundamental frequency
6. Above limits have been translated by the formula

The measured field strength was extrapolated to distance 30 meters, using the formula that the limit of field strength varies as the inverse distance square (40dB per decade of distance)

Example:

$$\begin{aligned}
 13.56\text{MHz} &= 15848\mu\text{V/m} && 30\text{m} \\
 &= 84\text{dBuV/m} && 30\text{m} \\
 &= 84+20\log(30/3)^2 && 3\text{m} \\
 &= 124\text{dBuV/m}
 \end{aligned}$$

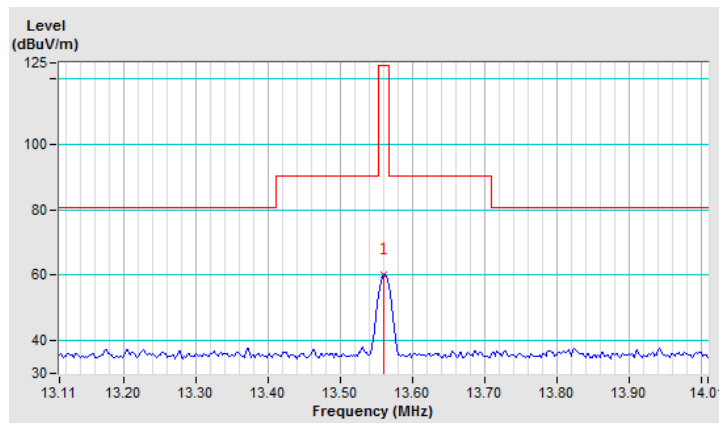

Antenna Polarity & Test Distance: Loop Antenna Perpendicular At 30m				
No.	Freq. (MHz)	Emission Level (dBuV/m)	Limit (dBuV/m)	Margin (dB)
1	*13.56	20.1 QP	84.0	-63.9

Remarks: Emission Level at 30m = Emission Level at 3m + 20log(3/30)²

EUT Test Condition		Measurement Detail	
Channel	Channel 1	Frequency Range	13.553 ~ 13.567MHz
Input Power	120Vac, 60Hz	Detector Function	Quasi-Peak
Environmental Conditions	23 deg. C, 66% RH	Tested By	Titan Hsu

Antenna Polarity & Test Distance: Loop Antenna Ground-Parallel At 3m								
No.	Freq. (MHz)	Emission Level (dBuV/m)	Limit (dBuV/m)	Margin (dB)	Antenna Height (m)	Table Angle (Degree)	Raw Value (dBuV)	Correction Factor (dB/m)
1	*13.56	54.9 QP	124.0	-69.1	1.00 V	17	33.1	21.8

Remarks:

1. Emission Level(dBuV/m) = Raw Value(dBuV) + Correction Factor(dB/m)
2. Correction Factor(dB/m) = Antenna Factor(dB/m) + Cable Factor(dB) – Pre-Amplifier Factor(dB)
3. The other emission levels were very low against the limit.
4. Margin value = Emission Level – Limit value
5. “ * ” : Fundamental frequency
6. Above limits have been translated by the formula

The measured field strength was extrapolated to distance 30 meters, using the formula that the limit of field strength varies as the inverse distance square (40dB per decade of distance)

Example:

$$\begin{aligned}
 13.56\text{MHz} &= 15848\mu\text{V/m} && 30\text{m} \\
 &= 84\text{dBuV/m} && 30\text{m} \\
 &= 84+20\log(30/3)^2 && 3\text{m} \\
 &= 124\text{dBuV/m}
 \end{aligned}$$

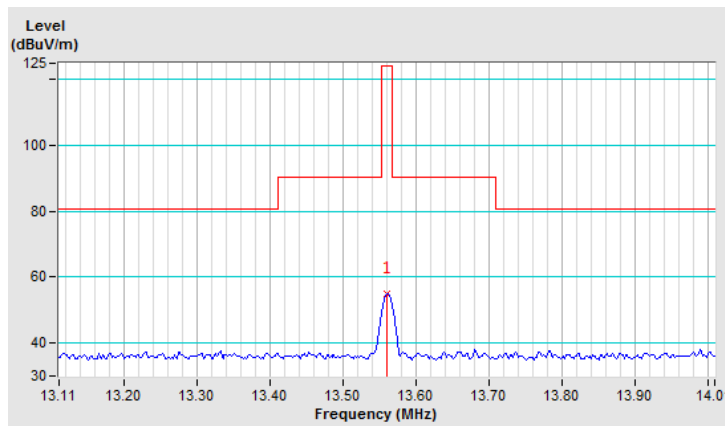

Antenna Polarity & Test Distance: Loop Antenna Ground-Parallel At 30m				
No.	Freq. (MHz)	Emission Level (dBuV/m)	Limit (dBuV/m)	Margin (dB)
1	*13.56	14.9 QP	84.0	-69.1

Remarks: Emission Level at 30m = Emission Level at 3m + 20log(3/30)²

EUT Test Condition		Measurement Detail	
Channel	Channel 1	Frequency Range	Below 30MHz
Input Power	120Vac, 60Hz	Detector Function	Quasi-Peak
Environmental Conditions	23 deg. C, 66% RH	Tested By	Titan Hsu

Antenna Polarity & Test Distance: Loop Antenna Parallel At 3m								
No.	Freq. (MHz)	Emission Level (dBuV/m)	Limit (dBuV/m)	Margin (dB)	Antenna Height (m)	Table Angle (Degree)	Raw Value (dBuV)	Correction Factor (dB/m)
1	3.55	40.7 QP	69.5	-28.8	1.00 V	159	20.7	20.0
2	10.51	39.7 QP	69.5	-29.8	1.00 V	341	18.0	21.7
3	15.78	39.6 QP	69.5	-29.9	1.00 V	212	17.7	21.9
4	17.34	40.9 QP	69.5	-28.6	1.00 V	128	18.9	22.0
5	19.98	47.0 QP	69.5	-22.5	1.00 V	128	24.9	22.1
6	24.00	43.8 QP	69.5	-25.7	1.00 V	128	21.7	22.1

Remarks:

1. Emission Level(dBuV/m) = Raw Value(dBuV) + Correction Factor(dB/m)
2. Correction Factor(dB/m) = Antenna Factor(dB/m) + Cable Factor(dB) – Pre-Amplifier Factor(dB)
3. The other emission levels were very low against the limit.
4. Margin value = Emission Level – Limit value

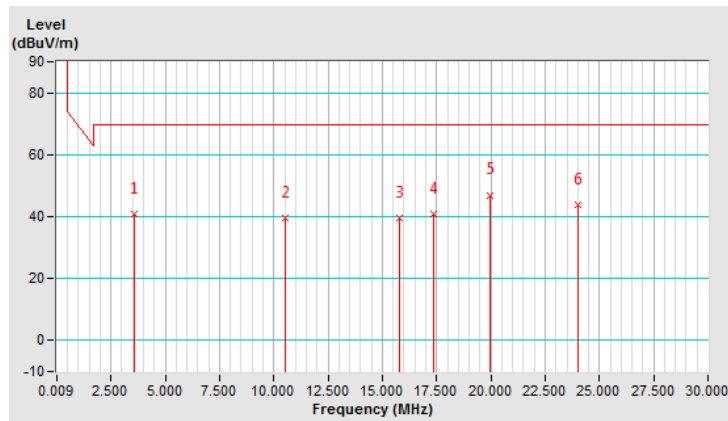

EUT Test Condition		Measurement Detail	
Channel	Channel 1	Frequency Range	Below 30MHz
Input Power	120Vac, 60Hz	Detector Function	Quasi-Peak
Environmental Conditions	23 deg. C, 66% RH	Tested By	Titan Hsu

Antenna Polarity & Test Distance: Loop Antenna Perpendicular At 3m								
No.	Freq. (MHz)	Emission Level (dBuV/m)	Limit (dBuV/m)	Margin (dB)	Antenna Height (m)	Table Angle (Degree)	Raw Value (dBuV)	Correction Factor (dB/m)
1	2.53	37.3 QP	69.5	-32.2	1.00 V	100	17.4	19.9
2	5.59	35.3 QP	69.5	-34.2	1.00 V	353	15.0	20.3
3	8.35	35.0 QP	69.5	-34.5	1.00 V	23	13.9	21.1
4	12.25	35.9 QP	69.5	-33.6	1.00 V	313	14.1	21.8
5	16.14	37.3 QP	69.5	-32.2	1.00 V	94	15.4	21.9
6	18.48	38.1 QP	69.5	-31.4	1.00 V	325	16.1	22.0

Remarks:

1. Emission Level(dBuV/m) = Raw Value(dBuV) + Correction Factor(dB/m)
2. Correction Factor(dB/m) = Antenna Factor(dB/m) + Cable Factor(dB) – Pre-Amplifier Factor(dB)
3. The other emission levels were very low against the limit.
4. Margin value = Emission Level – Limit value

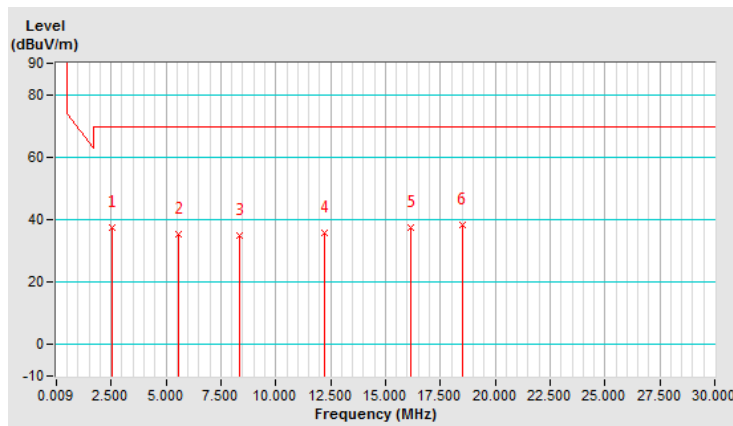

EUT Test Condition		Measurement Detail	
Channel	Channel 1	Frequency Range	Below 30MHz
Input Power	120Vac, 60Hz	Detector Function	Quasi-Peak
Environmental Conditions	23 deg. C, 66% RH	Tested By	Titan Hsu

Antenna Polarity & Test Distance: Loop Antenna Ground-Parallel At 3m								
No.	Freq. (MHz)	Emission Level (dBuV/m)	Limit (dBuV/m)	Margin (dB)	Antenna Height (m)	Table Angle (Degree)	Raw Value (dBuV)	Correction Factor (dB/m)
1	1.93	40.2 QP	69.5	-29.3	1.00 V	132	20.3	19.9
2	10.51	38.5 QP	69.5	-31.0	1.00 V	90	16.8	21.7
3	16.86	40.0 QP	69.5	-29.5	1.00 V	50	18.0	22.0
4	19.80	41.0 QP	69.5	-28.5	1.00 V	65	18.9	22.1
5	23.10	46.1 QP	69.5	-23.4	1.00 V	351	24.0	22.1
6	27.00	36.0 QP	69.5	-33.5	1.00 V	47	13.8	22.2

Remarks:

1. Emission Level(dBuV/m) = Raw Value(dBuV) + Correction Factor(dB/m)
2. Correction Factor(dB/m) = Antenna Factor(dB/m) + Cable Factor(dB) – Pre-Amplifier Factor(dB)
3. The other emission levels were very low against the limit.
4. Margin value = Emission Level – Limit value

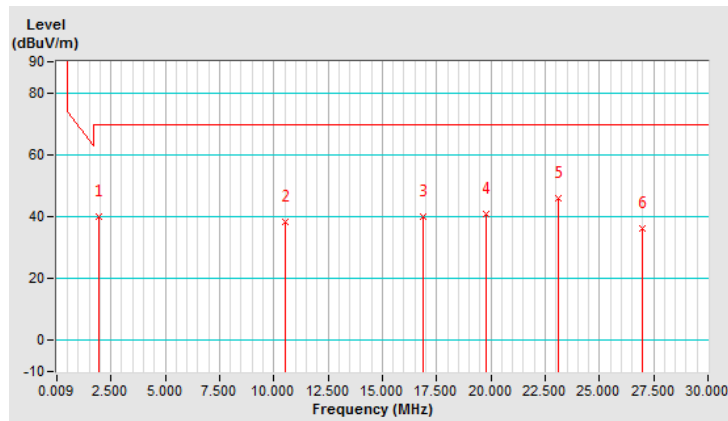

EUT Test Condition		Measurement Detail	
Channel	Channel 1	Frequency Range	Below 1000MHz
Input Power	120Vac, 60Hz	Detector Function	Quasi-Peak
Environmental Conditions	23 deg. C, 66% RH	Tested By	Titan Hsu

Antenna Polarity & Test Distance: Horizontal At 3m								
No.	Freq. (MHz)	Emission Level (dBuV/m)	Limit (dBuV/m)	Margin (dB)	Antenna Height (m)	Table Angle (Degree)	Raw Value (dBuV)	Correction Factor (dB/m)
1	34.22	31.3 QP	40.0	-8.7	1.00 H	299	41.7	-10.4
2	48.28	30.7 QP	40.0	-9.3	1.49 H	14	39.6	-8.9
3	105.92	33.3 QP	43.5	-10.2	1.99 H	15	45.6	-12.3
4	173.41	35.9 QP	43.5	-7.6	1.49 H	15	45.1	-9.2
5	298.53	37.1 QP	46.0	-8.9	1.00 H	178	44.6	-7.5
6	385.70	34.0 QP	46.0	-12.0	1.00 H	329	39.0	-5.0

Remarks:

1. Emission Level(dBuV/m) = Raw Value(dBuV) + Correction Factor(dB/m)
2. Correction Factor(dB/m) = Antenna Factor(dB/m) + Cable Factor(dB) – Pre-Amplifier Factor(dB)
3. The other emission levels were very low against the limit.
4. Margin value = Emission Level – Limit value

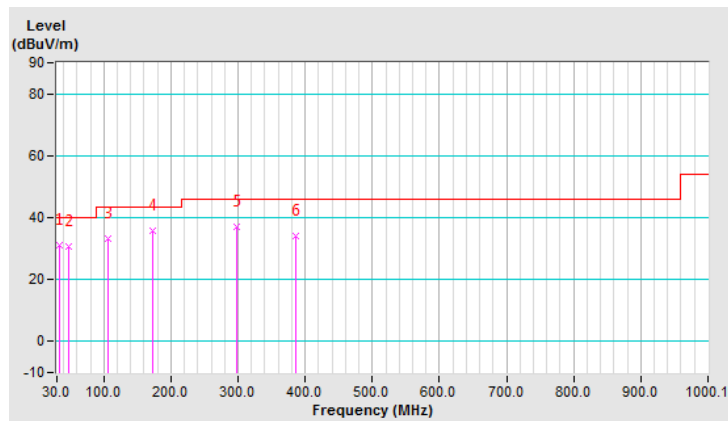

EUT Test Condition		Measurement Detail	
Channel	Channel 1	Frequency Range	Below 1000MHz
Input Power	120Vac, 60Hz	Detector Function	Quasi-Peak
Environmental Conditions	23 deg. C, 66% RH	Tested By	Titan Hsu

Antenna Polarity & Test Distance: Vertical At 3m								
No.	Freq. (MHz)	Emission Level (dBuV/m)	Limit (dBuV/m)	Margin (dB)	Antenna Height (m)	Table Angle (Degree)	Raw Value (dBuV)	Correction Factor (dB/m)
1	49.68	32.9 QP	40.0	-7.1	1.01 V	19	41.9	-9.0
2	104.51	27.2 QP	43.5	-16.3	1.01 V	15	39.6	-12.4
3	174.81	27.4 QP	43.5	-16.1	1.98 V	44	36.6	-9.2
4	270.42	27.2 QP	46.0	-18.8	1.01 V	334	35.6	-8.4
5	385.70	25.0 QP	46.0	-21.0	1.51 V	178	30.0	-5.0
6	467.25	26.5 QP	46.0	-19.5	1.51 V	261	28.8	-2.3

Remarks:

1. Emission Level(dBuV/m) = Raw Value(dBuV) + Correction Factor(dB/m)
2. Correction Factor(dB/m) = Antenna Factor(dB/m) + Cable Factor(dB) – Pre-Amplifier Factor(dB)
3. The other emission levels were very low against the limit.
4. Margin value = Emission Level – Limit value

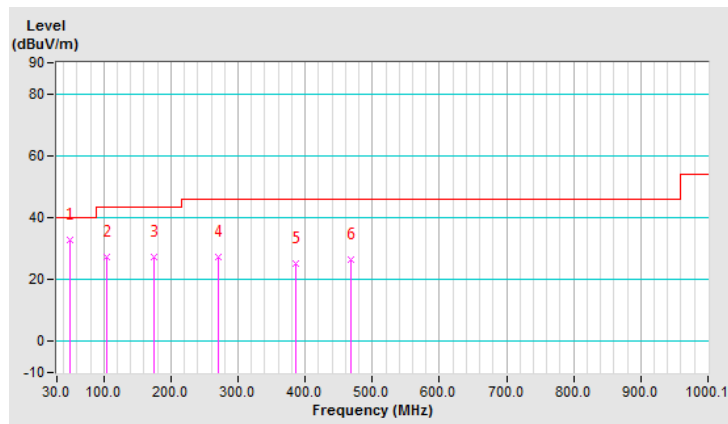

Type F

EUT Test Condition		Measurement Detail	
Channel	Channel 1	Frequency Range	13.553 ~ 13.567MHz
Input Power	120Vac, 60Hz	Detector Function	Quasi-Peak
Environmental Conditions	23 deg. C, 66% RH	Tested By	Titan Hsu

Antenna Polarity & Test Distance: Loop Antenna Parallel At 3m								
No.	Freq. (MHz)	Emission Level (dBuV/m)	Limit (dBuV/m)	Margin (dB)	Antenna Height (m)	Table Angle (Degree)	Raw Value (dBuV)	Correction Factor (dB/m)
1	*13.56	62.6 QP	124.0	-61.4	1.00 V	152	40.8	21.8

Remarks:

1. Emission Level(dBuV/m) = Raw Value(dBuV) + Correction Factor(dB/m)
2. Correction Factor(dB/m) = Antenna Factor(dB/m) + Cable Factor(dB) – Pre-Amplifier Factor(dB)
3. The other emission levels were very low against the limit.
4. Margin value = Emission Level – Limit value
5. “ * “ : Fundamental frequency
6. Above limits have been translated by the formula

The measured field strength was extrapolated to distance 30 meters, using the formula that the limit of field strength varies as the inverse distance square (40dB per decade of distance)

Example:

$$\begin{aligned}
 13.56\text{MHz} &= 15848\text{uV/m} && 30\text{m} \\
 &= 84\text{dBuV/m} && 30\text{m} \\
 &= 84+20\log(30/3)^2 && 3\text{m} \\
 &= 124\text{dBuV/m}
 \end{aligned}$$

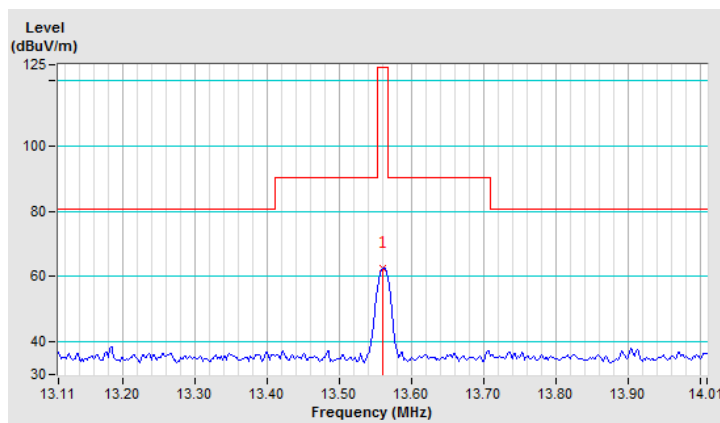

Antenna Polarity & Test Distance: Loop Antenna Parallel At 30m				
No.	Freq. (MHz)	Emission Level (dBuV/m)	Limit (dBuV/m)	Margin (dB)
1	*13.56	22.6 QP	84.0	-61.4

Remarks: Emission Level at 30m = Emission Level at 3m + 20log(3/30)²

EUT Test Condition		Measurement Detail	
Channel	Channel 1	Frequency Range	13.553 ~ 13.567MHz
Input Power	120Vac, 60Hz	Detector Function	Quasi-Peak
Environmental Conditions	23 deg. C, 66% RH	Tested By	Titan Hsu

Antenna Polarity & Test Distance: Loop Antenna Perpendicular At 3m								
No.	Freq. (MHz)	Emission Level (dBuV/m)	Limit (dBuV/m)	Margin (dB)	Antenna Height (m)	Table Angle (Degree)	Raw Value (dBuV)	Correction Factor (dB/m)
1	*13.56	59.9 QP	124.0	-64.1	1.00 V	77	38.1	21.8

Remarks:

1. Emission Level(dBuV/m) = Raw Value(dBuV) + Correction Factor(dB/m)
2. Correction Factor(dB/m) = Antenna Factor(dB/m) + Cable Factor(dB) – Pre-Amplifier Factor(dB)
3. The other emission levels were very low against the limit.
4. Margin value = Emission Level – Limit value
5. “ * ” : Fundamental frequency
6. Above limits have been translated by the formula

The measured field strength was extrapolated to distance 30 meters, using the formula that the limit of field strength varies as the inverse distance square (40dB per decade of distance)

Example:

$$\begin{aligned}
 13.56\text{MHz} &= 15848\mu\text{V/m} && 30\text{m} \\
 &= 84\text{dBuV/m} && 30\text{m} \\
 &= 84+20\log(30/3)^2 && 3\text{m} \\
 &= 124\text{dBuV/m}
 \end{aligned}$$

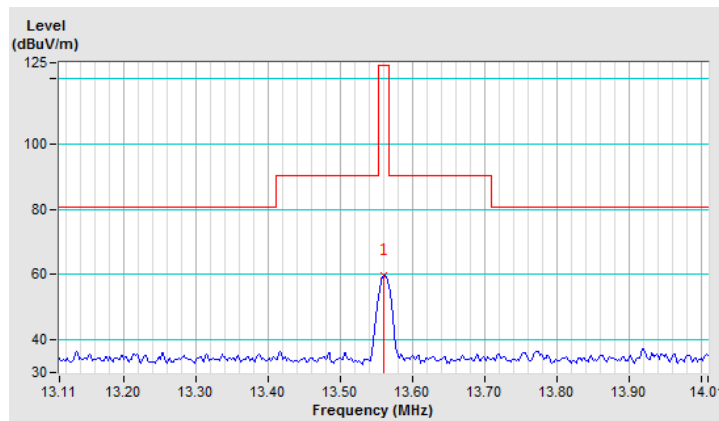

Antenna Polarity & Test Distance: Loop Antenna Perpendicular At 30m				
No.	Freq. (MHz)	Emission Level (dBuV/m)	Limit (dBuV/m)	Margin (dB)
1	*13.56	19.9 QP	84.0	-64.1

Remarks: Emission Level at 30m = Emission Level at 3m + 20log(3/30)²

EUT Test Condition		Measurement Detail	
Channel	Channel 1	Frequency Range	13.553 ~ 13.567MHz
Input Power	120Vac, 60Hz	Detector Function	Quasi-Peak
Environmental Conditions	23 deg. C, 66% RH	Tested By	Titan Hsu

Antenna Polarity & Test Distance: Loop Antenna Ground-Parallel At 3m								
No.	Freq. (MHz)	Emission Level (dBuV/m)	Limit (dBuV/m)	Margin (dB)	Antenna Height (m)	Table Angle (Degree)	Raw Value (dBuV)	Correction Factor (dB/m)
1	*13.56	54.6 QP	124.0	-69.4	1.00 V	13	32.8	21.8

Remarks:

1. Emission Level(dBuV/m) = Raw Value(dBuV) + Correction Factor(dB/m)
2. Correction Factor(dB/m) = Antenna Factor(dB/m) + Cable Factor(dB) – Pre-Amplifier Factor(dB)
3. The other emission levels were very low against the limit.
4. Margin value = Emission Level – Limit value
5. “ * ” : Fundamental frequency
6. Above limits have been translated by the formula

The measured field strength was extrapolated to distance 30 meters, using the formula that the limit of field strength varies as the inverse distance square (40dB per decade of distance)

Example:

$$\begin{aligned}
 13.56\text{MHz} &= 15848\mu\text{V/m} && 30\text{m} \\
 &= 84\text{dBuV/m} && 30\text{m} \\
 &= 84+20\log(30/3)^2 && 3\text{m} \\
 &= 124\text{dBuV/m}
 \end{aligned}$$

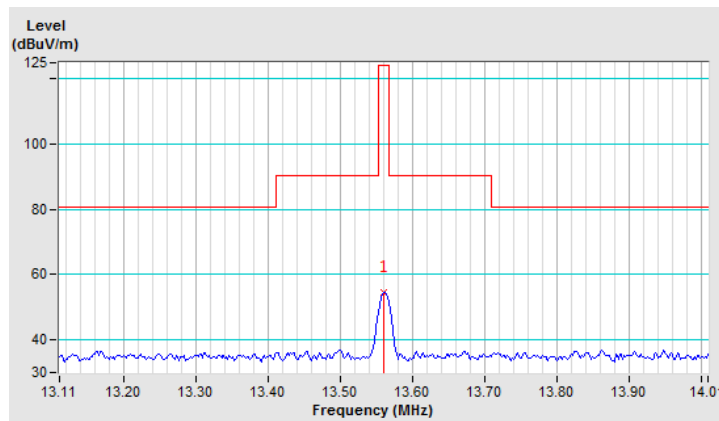

Antenna Polarity & Test Distance: Loop Antenna Ground-Parallel At 30m				
No.	Freq. (MHz)	Emission Level (dBuV/m)	Limit (dBuV/m)	Margin (dB)
1	*13.56	14.6 QP	84.0	-69.4

Remarks: Emission Level at 30m = Emission Level at 3m + 20log(3/30)²

EUT Test Condition		Measurement Detail	
Channel	Channel 1	Frequency Range	Below 30MHz
Input Power	120Vac, 60Hz	Detector Function	Quasi-Peak
Environmental Conditions	23 deg. C, 66% RH	Tested By	Titan Hsu

Antenna Polarity & Test Distance: Loop Antenna Parallel At 3m								
No.	Freq. (MHz)	Emission Level (dBuV/m)	Limit (dBuV/m)	Margin (dB)	Antenna Height (m)	Table Angle (Degree)	Raw Value (dBuV)	Correction Factor (dB/m)
1	3.55	38.9 QP	69.5	-30.6	1.00 V	188	18.9	20.0
2	6.55	35.0 QP	69.5	-34.5	1.00 V	334	14.4	20.6
3	10.51	40.3 QP	69.5	-29.2	1.00 V	323	18.6	21.7
4	15.78	40.2 QP	69.5	-29.3	1.00 V	82	18.3	21.9
5	20.04	44.0 QP	69.5	-25.5	1.00 V	233	21.9	22.1
6	25.68	37.5 QP	69.5	-32.0	1.00 V	123	15.4	22.1

Remarks:

1. Emission Level(dBuV/m) = Raw Value(dBuV) + Correction Factor(dB/m)
2. Correction Factor(dB/m) = Antenna Factor(dB/m) + Cable Factor(dB) – Pre-Amplifier Factor(dB)
3. The other emission levels were very low against the limit.
4. Margin value = Emission Level – Limit value

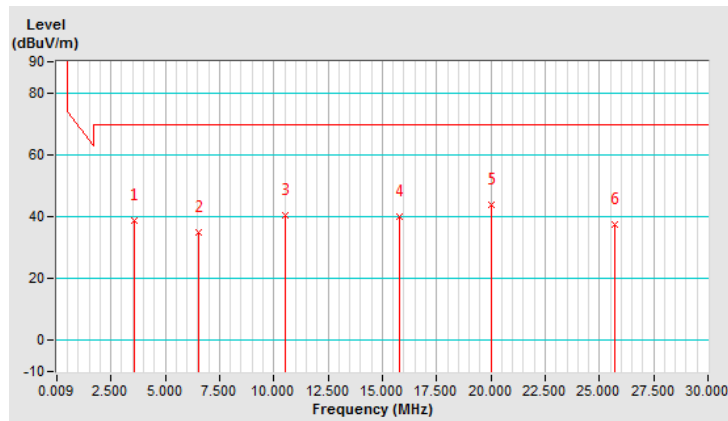

EUT Test Condition		Measurement Detail	
Channel	Channel 1	Frequency Range	Below 30MHz
Input Power	120Vac, 60Hz	Detector Function	Quasi-Peak
Environmental Conditions	23 deg. C, 66% RH	Tested By	Titan Hsu

Antenna Polarity & Test Distance: Loop Antenna Perpendicular At 3m								
No.	Freq. (MHz)	Emission Level (dBuV/m)	Limit (dBuV/m)	Margin (dB)	Antenna Height (m)	Table Angle (Degree)	Raw Value (dBuV)	Correction Factor (dB/m)
1	3.55	37.6 QP	69.5	-31.9	1.00 V	350	17.6	20.0
2	5.47	36.1 QP	69.5	-33.4	1.00 V	5	15.9	20.2
3	7.87	36.1 QP	69.5	-33.4	1.00 V	120	15.1	21.0
4	10.81	35.0 QP	69.5	-34.5	1.00 V	301	13.3	21.7
5	18.96	39.5 QP	69.5	-30.0	1.00 V	328	17.5	22.0
6	22.92	39.0 QP	69.5	-30.5	1.00 V	295	16.9	22.1

Remarks:

1. Emission Level(dBuV/m) = Raw Value(dBuV) + Correction Factor(dB/m)
2. Correction Factor(dB/m) = Antenna Factor(dB/m) + Cable Factor(dB) – Pre-Amplifier Factor(dB)
3. The other emission levels were very low against the limit.
4. Margin value = Emission Level – Limit value

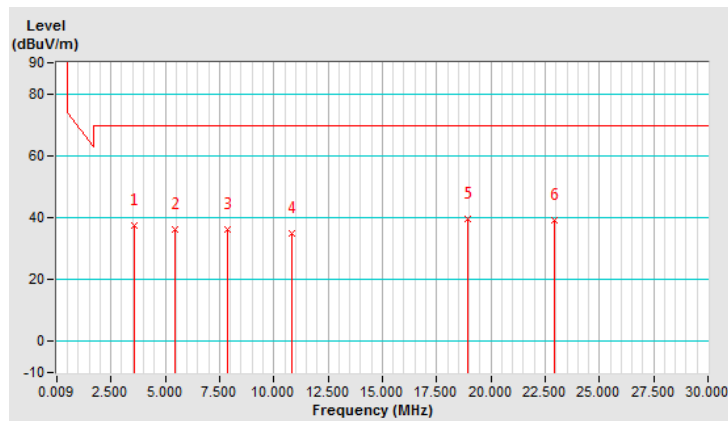

EUT Test Condition		Measurement Detail	
Channel	Channel 1	Frequency Range	Below 30MHz
Input Power	120Vac, 60Hz	Detector Function	Quasi-Peak
Environmental Conditions	23 deg. C, 66% RH	Tested By	Titan Hsu

Antenna Polarity & Test Distance: Loop Antenna Ground-Parallel At 3m								
No.	Freq. (MHz)	Emission Level (dBuV/m)	Limit (dBuV/m)	Margin (dB)	Antenna Height (m)	Table Angle (Degree)	Raw Value (dBuV)	Correction Factor (dB/m)
1	3.49	36.6 QP	69.5	-32.9	1.00 V	191	16.6	20.0
2	8.83	36.0 QP	69.5	-33.5	1.00 V	94	14.7	21.3
3	16.86	40.1 QP	69.5	-29.4	1.00 V	126	18.1	22.0
4	18.96	39.5 QP	69.5	-30.0	1.00 V	244	17.5	22.0
5	20.76	41.5 QP	69.5	-28.0	1.00 V	355	19.4	22.1
6	25.62	36.0 QP	69.5	-33.5	1.00 V	200	13.9	22.1

Remarks:

1. Emission Level(dBuV/m) = Raw Value(dBuV) + Correction Factor(dB/m)
2. Correction Factor(dB/m) = Antenna Factor(dB/m) + Cable Factor(dB) – Pre-Amplifier Factor(dB)
3. The other emission levels were very low against the limit.
4. Margin value = Emission Level – Limit value

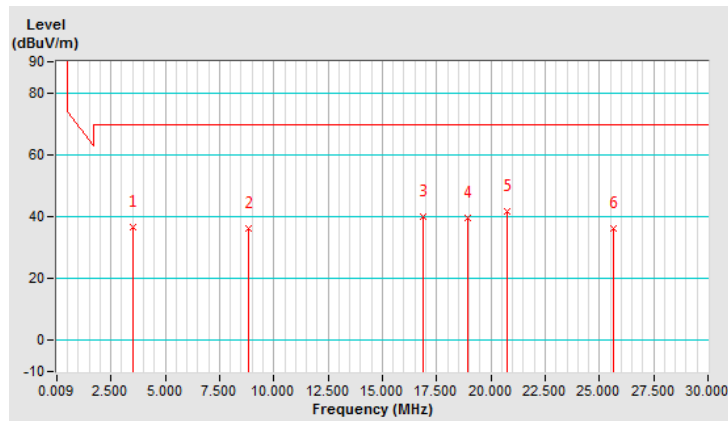

EUT Test Condition		Measurement Detail	
Channel	Channel 1	Frequency Range	Below 1000MHz
Input Power	120Vac, 60Hz	Detector Function	Quasi-Peak
Environmental Conditions	23 deg. C, 66% RH	Tested By	Titan Hsu

Antenna Polarity & Test Distance: Horizontal At 3m								
No.	Freq. (MHz)	Emission Level (dBuV/m)	Limit (dBuV/m)	Margin (dB)	Antenna Height (m)	Table Angle (Degree)	Raw Value (dBuV)	Correction Factor (dB/m)
1	104.51	32.4 QP	43.5	-11.1	2.00 H	329	44.8	-12.4
2	174.81	36.5 QP	43.5	-7.0	1.51 H	327	45.7	-9.2
3	243.70	33.4 QP	46.0	-12.6	1.01 H	17	42.8	-9.4
4	270.42	34.8 QP	46.0	-11.2	1.01 H	178	43.2	-8.4
5	385.70	34.2 QP	46.0	-11.8	1.01 H	312	39.2	-5.0
6	448.97	32.1 QP	46.0	-13.9	1.01 H	154	34.7	-2.6

Remarks:

1. Emission Level(dBuV/m) = Raw Value(dBuV) + Correction Factor(dB/m)
2. Correction Factor(dB/m) = Antenna Factor(dB/m) + Cable Factor(dB) – Pre-Amplifier Factor(dB)
3. The other emission levels were very low against the limit.
4. Margin value = Emission Level – Limit value

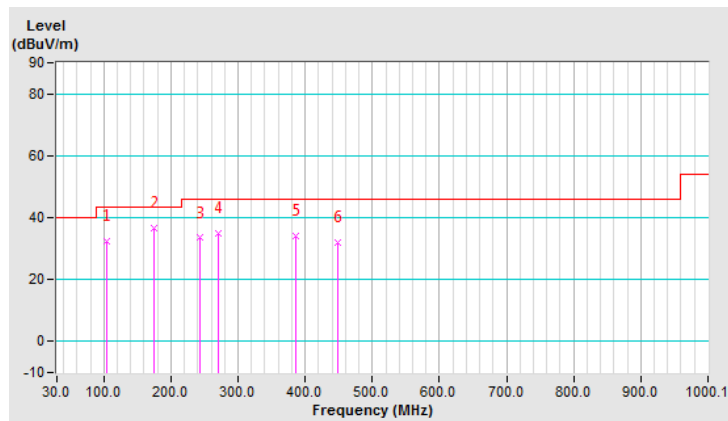

EUT Test Condition		Measurement Detail	
Channel	Channel 1	Frequency Range	Below 1000MHz
Input Power	120Vac, 60Hz	Detector Function	Quasi-Peak
Environmental Conditions	23 deg. C, 66% RH	Tested By	Titan Hsu

Antenna Polarity & Test Distance: Vertical At 3m								
No.	Freq. (MHz)	Emission Level (dBuV/m)	Limit (dBuV/m)	Margin (dB)	Antenna Height (m)	Table Angle (Degree)	Raw Value (dBuV)	Correction Factor (dB/m)
1	49.68	32.8 QP	40.0	-7.2	1.49 V	6	41.8	-9.0
2	104.51	27.3 QP	43.5	-16.2	1.00 V	44	39.7	-12.4
3	173.41	27.6 QP	43.5	-15.9	1.49 V	73	36.8	-9.2
4	270.42	29.3 QP	46.0	-16.7	1.00 V	333	37.7	-8.4
5	384.30	27.0 QP	46.0	-19.0	1.40 V	112	32.0	-5.0
6	513.64	27.9 QP	46.0	-18.1	1.49 V	98	29.0	-1.1

Remarks:

1. Emission Level(dBuV/m) = Raw Value(dBuV) + Correction Factor(dB/m)
2. Correction Factor(dB/m) = Antenna Factor(dB/m) + Cable Factor(dB) – Pre-Amplifier Factor(dB)
3. The other emission levels were very low against the limit.
4. Margin value = Emission Level – Limit value

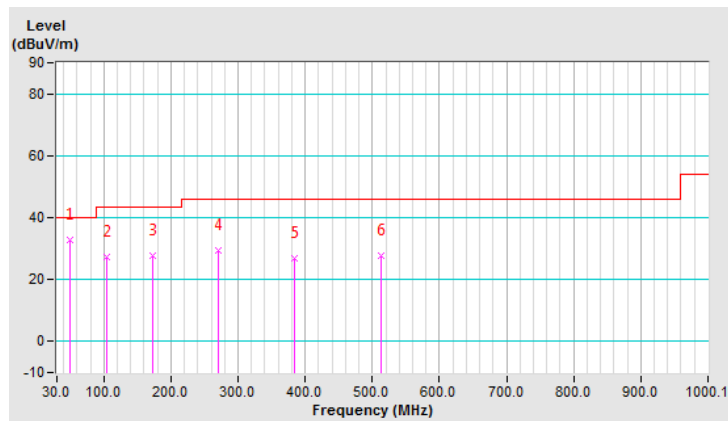

Type V

EUT Test Condition		Measurement Detail	
Channel	Channel 1	Frequency Range	13.553 ~ 13.567MHz
Input Power	120Vac, 60Hz	Detector Function	Quasi-Peak
Environmental Conditions	23 deg. C, 66% RH	Tested By	Titan Hsu

Antenna Polarity & Test Distance: Loop Antenna Parallel At 3m								
No.	Freq. (MHz)	Emission Level (dBuV/m)	Limit (dBuV/m)	Margin (dB)	Antenna Height (m)	Table Angle (Degree)	Raw Value (dBuV)	Correction Factor (dB/m)
1	*13.56	62.6 QP	124.0	-61.4	1.00 V	169	40.8	21.8

Remarks:

1. Emission Level(dBuV/m) = Raw Value(dBuV) + Correction Factor(dB/m)
2. Correction Factor(dB/m) = Antenna Factor(dB/m) + Cable Factor(dB) – Pre-Amplifier Factor(dB)
3. The other emission levels were very low against the limit.
4. Margin value = Emission Level – Limit value
5. “ * ” : Fundamental frequency
6. Above limits have been translated by the formula

The measured field strength was extrapolated to distance 30 meters, using the formula that the limit of field strength varies as the inverse distance square (40dB per decade of distance)

Example:

$$\begin{aligned}
 13.56\text{MHz} &= 15848\text{uV/m} && 30\text{m} \\
 &= 84\text{dBuV/m} && 30\text{m} \\
 &= 84+20\log(30/3)^2 && 3\text{m} \\
 &= 124\text{dBuV/m}
 \end{aligned}$$

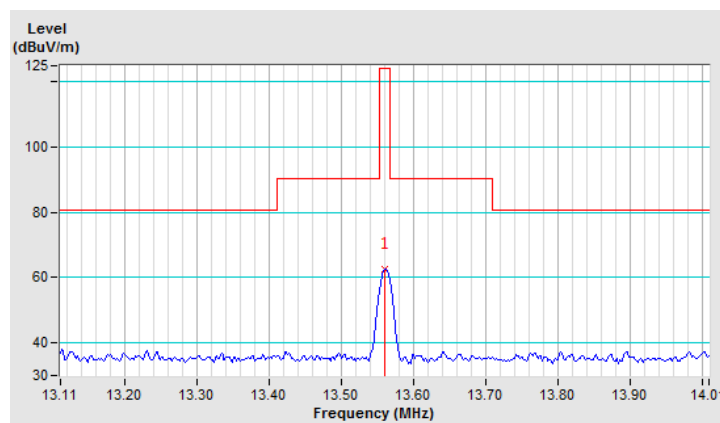

Antenna Polarity & Test Distance: Loop Antenna Parallel At 30m				
No.	Freq. (MHz)	Emission Level (dBuV/m)	Limit (dBuV/m)	Margin (dB)
1	*13.56	22.6 QP	84.0	-61.4

Remarks: Emission Level at 30m = Emission Level at 3m + 20log(3/30)²

EUT Test Condition		Measurement Detail	
Channel	Channel 1	Frequency Range	13.553 ~ 13.567MHz
Input Power	120Vac, 60Hz	Detector Function	Quasi-Peak
Environmental Conditions	23 deg. C, 66% RH	Tested By	Titan Hsu

Antenna Polarity & Test Distance: Loop Antenna Perpendicular At 3m								
No.	Freq. (MHz)	Emission Level (dBuV/m)	Limit (dBuV/m)	Margin (dB)	Antenna Height (m)	Table Angle (Degree)	Raw Value (dBuV)	Correction Factor (dB/m)
1	*13.56	59.8 QP	124.0	-64.2	1.00 V	76	38.0	21.8

Remarks:

1. Emission Level(dBuV/m) = Raw Value(dBuV) + Correction Factor(dB/m)
2. Correction Factor(dB/m) = Antenna Factor(dB/m) + Cable Factor(dB) – Pre-Amplifier Factor(dB)
3. The other emission levels were very low against the limit.
4. Margin value = Emission Level – Limit value
5. “ * ” : Fundamental frequency
6. Above limits have been translated by the formula

The measured field strength was extrapolated to distance 30 meters, using the formula that the limit of field strength varies as the inverse distance square (40dB per decade of distance)

Example:

$$\begin{aligned}
 13.56\text{MHz} &= 15848\mu\text{V/m} && 30\text{m} \\
 &= 84\text{dBuV/m} && 30\text{m} \\
 &= 84+20\log(30/3)^2 && 3\text{m} \\
 &= 124\text{dBuV/m}
 \end{aligned}$$

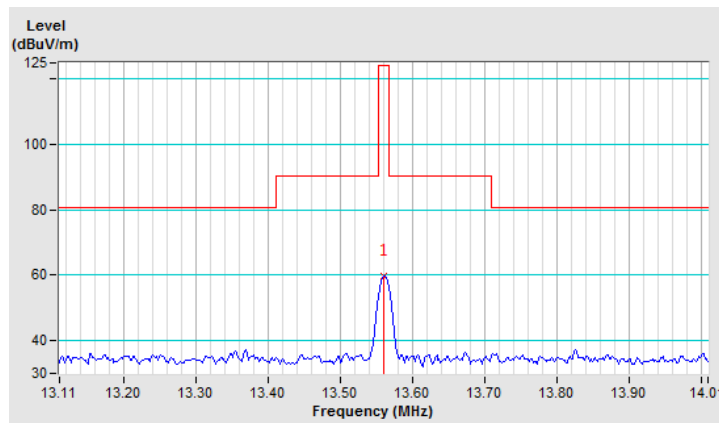

Antenna Polarity & Test Distance: Loop Antenna Perpendicular At 30m				
No.	Freq. (MHz)	Emission Level (dBuV/m)	Limit (dBuV/m)	Margin (dB)
1	*13.56	19.8 QP	84.0	-64.2

Remarks: Emission Level at 30m = Emission Level at 3m + 20log(3/30)²

EUT Test Condition		Measurement Detail	
Channel	Channel 1	Frequency Range	13.553 ~ 13.567MHz
Input Power	120Vac, 60Hz	Detector Function	Quasi-Peak
Environmental Conditions	23 deg. C, 66% RH	Tested By	Titan Hsu

Antenna Polarity & Test Distance: Loop Antenna Ground-Parallel At 3m								
No.	Freq. (MHz)	Emission Level (dBuV/m)	Limit (dBuV/m)	Margin (dB)	Antenna Height (m)	Table Angle (Degree)	Raw Value (dBuV)	Correction Factor (dB/m)
1	*13.56	54.6 QP	124.0	-69.4	1.00 V	7	32.8	21.8

Remarks:

1. Emission Level(dBuV/m) = Raw Value(dBuV) + Correction Factor(dB/m)
2. Correction Factor(dB/m) = Antenna Factor(dB/m) + Cable Factor(dB) – Pre-Amplifier Factor(dB)
3. The other emission levels were very low against the limit.
4. Margin value = Emission Level – Limit value
5. “ * ” : Fundamental frequency
6. Above limits have been translated by the formula

The measured field strength was extrapolated to distance 30 meters, using the formula that the limit of field strength varies as the inverse distance square (40dB per decade of distance)

Example:

$$\begin{aligned}
 13.56\text{MHz} &= 15848\mu\text{V/m} && 30\text{m} \\
 &= 84\text{dBuV/m} && 30\text{m} \\
 &= 84+20\log(30/3)^2 && 3\text{m} \\
 &= 124\text{dBuV/m}
 \end{aligned}$$

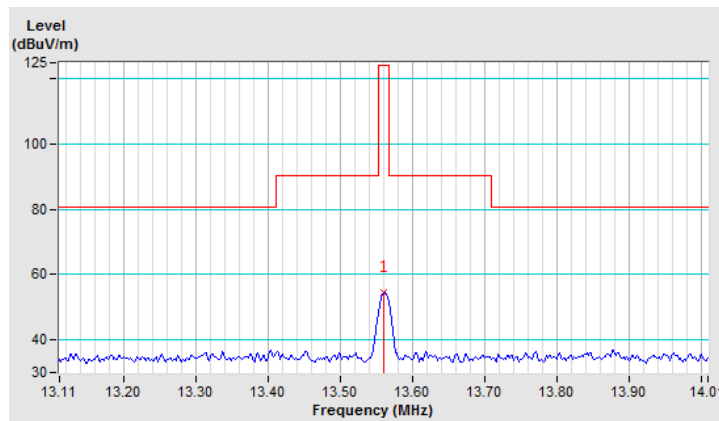

Antenna Polarity & Test Distance: Loop Antenna Ground-Parallel At 30m				
No.	Freq. (MHz)	Emission Level (dBuV/m)	Limit (dBuV/m)	Margin (dB)
1	*13.56	14.6 QP	84.0	-69.4

Remarks: Emission Level at 30m = Emission Level at 3m + 20log(3/30)²

EUT Test Condition		Measurement Detail	
Channel	Channel 1	Frequency Range	Below 30MHz
Input Power	120Vac, 60Hz	Detector Function	Quasi-Peak
Environmental Conditions	23 deg. C, 66% RH	Tested By	Titan Hsu

Antenna Polarity & Test Distance: Loop Antenna Parallel At 3m								
No.	Freq. (MHz)	Emission Level (dBuV/m)	Limit (dBuV/m)	Margin (dB)	Antenna Height (m)	Table Angle (Degree)	Raw Value (dBuV)	Correction Factor (dB/m)
1	3.55	41.3 QP	69.5	-28.2	1.00 V	267	21.3	20.0
2	10.51	41.6 QP	69.5	-27.9	1.00 V	256	19.9	21.7
3	15.78	40.1 QP	69.5	-29.4	1.00 V	36	18.2	21.9
4	19.38	44.0 QP	69.5	-25.5	1.00 V	204	21.9	22.1
5	21.96	41.8 QP	69.5	-27.7	1.00 V	298	19.7	22.1
6	23.64	39.6 QP	69.5	-29.9	1.00 V	10	17.5	22.1

Remarks:

1. Emission Level(dBuV/m) = Raw Value(dBuV) + Correction Factor(dB/m)
2. Correction Factor(dB/m) = Antenna Factor(dB/m) + Cable Factor(dB) – Pre-Amplifier Factor(dB)
3. The other emission levels were very low against the limit.
4. Margin value = Emission Level – Limit value

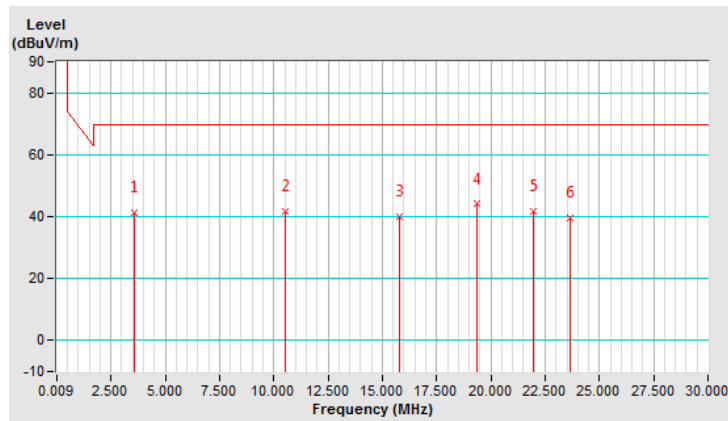

EUT Test Condition		Measurement Detail	
Channel	Channel 1	Frequency Range	Below 30MHz
Input Power	120Vac, 60Hz	Detector Function	Quasi-Peak
Environmental Conditions	23 deg. C, 66% RH	Tested By	Titan Hsu

Antenna Polarity & Test Distance: Loop Antenna Perpendicular At 3m								
No.	Freq. (MHz)	Emission Level (dBuV/m)	Limit (dBuV/m)	Margin (dB)	Antenna Height (m)	Table Angle (Degree)	Raw Value (dBuV)	Correction Factor (dB/m)
1	3.01	38.4 QP	69.5	-31.1	1.00 V	355	18.5	19.9
2	8.41	36.2 QP	69.5	-33.3	1.00 V	227	15.0	21.2
3	11.77	36.1 QP	69.5	-33.4	1.00 V	246	14.4	21.7
4	16.56	37.4 QP	69.5	-32.1	1.00 V	124	15.5	21.9
5	22.92	39.0 QP	69.5	-30.5	1.00 V	13	16.9	22.1
6	27.18	36.1 QP	69.5	-33.4	1.00 V	195	13.9	22.2

Remarks:

1. Emission Level(dBuV/m) = Raw Value(dBuV) + Correction Factor(dB/m)
2. Correction Factor(dB/m) = Antenna Factor(dB/m) + Cable Factor(dB) – Pre-Amplifier Factor(dB)
3. The other emission levels were very low against the limit.
4. Margin value = Emission Level – Limit value

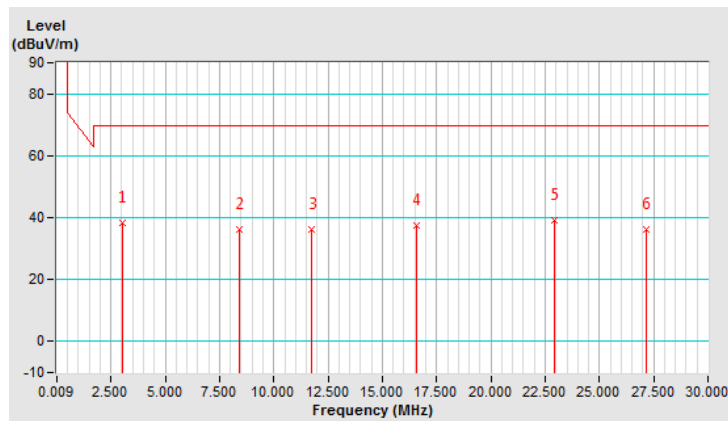

EUT Test Condition		Measurement Detail	
Channel	Channel 1	Frequency Range	Below 30MHz
Input Power	120Vac, 60Hz	Detector Function	Quasi-Peak
Environmental Conditions	23 deg. C, 66% RH	Tested By	Titan Hsu

Antenna Polarity & Test Distance: Loop Antenna Ground-Parallel At 3m								
No.	Freq. (MHz)	Emission Level (dBuV/m)	Limit (dBuV/m)	Margin (dB)	Antenna Height (m)	Table Angle (Degree)	Raw Value (dBuV)	Correction Factor (dB/m)
1	3.55	37.3 QP	69.5	-32.2	1.00 V	10	17.3	20.0
2	7.09	35.0 QP	69.5	-34.5	1.00 V	107	14.3	20.7
3	9.19	35.5 QP	69.5	-34.0	1.00 V	174	14.1	21.4
4	16.86	42.5 QP	69.5	-27.0	1.00 V	18	20.5	22.0
5	20.52	40.5 QP	69.5	-29.0	1.00 V	178	18.4	22.1
6	22.98	46.6 QP	69.5	-22.9	1.00 V	302	24.5	22.1

Remarks:

1. Emission Level(dBuV/m) = Raw Value(dBuV) + Correction Factor(dB/m)
2. Correction Factor(dB/m) = Antenna Factor(dB/m) + Cable Factor(dB) – Pre-Amplifier Factor(dB)
3. The other emission levels were very low against the limit.
4. Margin value = Emission Level – Limit value

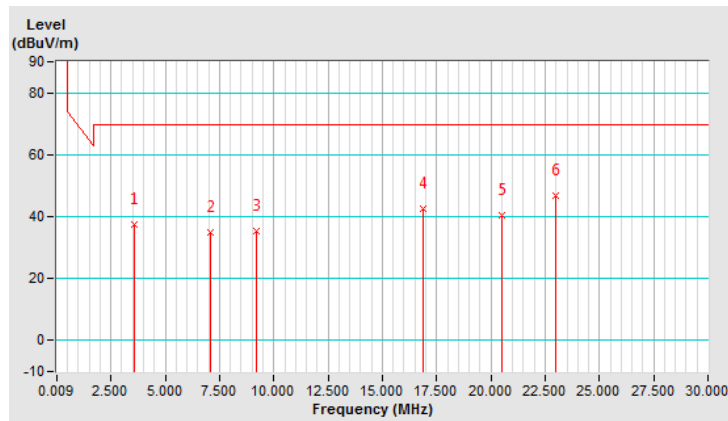

EUT Test Condition		Measurement Detail	
Channel	Channel 1	Frequency Range	Below 1000MHz
Input Power	120Vac, 60Hz	Detector Function	Quasi-Peak
Environmental Conditions	23 deg. C, 66% RH	Tested By	Titan Hsu

Antenna Polarity & Test Distance: Horizontal At 3m								
No.	Freq. (MHz)	Emission Level (dBuV/m)	Limit (dBuV/m)	Margin (dB)	Antenna Height (m)	Table Angle (Degree)	Raw Value (dBuV)	Correction Factor (dB/m)
1	34.22	29.4 QP	40.0	-10.6	2.01 H	12	39.8	-10.4
2	105.92	33.3 QP	43.5	-10.2	1.51 H	4	45.6	-12.3
3	125.60	33.4 QP	43.5	-10.1	2.01 H	81	43.9	-10.5
4	173.41	35.1 QP	43.5	-8.4	2.01 H	344	44.3	-9.2
5	242.30	34.5 QP	46.0	-11.5	1.01 H	8	43.9	-9.4
6	384.30	30.1 QP	46.0	-15.9	1.01 H	298	35.1	-5.0

Remarks:

1. Emission Level(dBuV/m) = Raw Value(dBuV) + Correction Factor(dB/m)
2. Correction Factor(dB/m) = Antenna Factor(dB/m) + Cable Factor(dB) – Pre-Amplifier Factor(dB)
3. The other emission levels were very low against the limit.
4. Margin value = Emission Level – Limit value

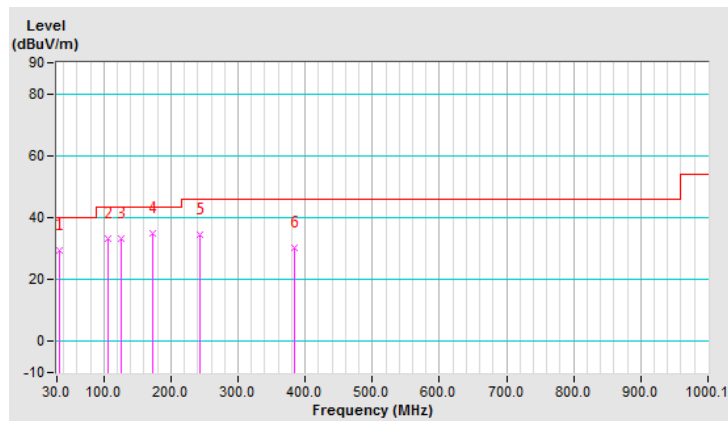

EUT Test Condition		Measurement Detail	
Channel	Channel 1	Frequency Range	Below 1000MHz
Input Power	120Vac, 60Hz	Detector Function	Quasi-Peak
Environmental Conditions	23 deg. C, 66% RH	Tested By	Titan Hsu

Antenna Polarity & Test Distance: Vertical At 3m								
No.	Freq. (MHz)	Emission Level (dBuV/m)	Limit (dBuV/m)	Margin (dB)	Antenna Height (m)	Table Angle (Degree)	Raw Value (dBuV)	Correction Factor (dB/m)
1	49.68	33.1 QP	40.0	-6.9	1.50 V	103	42.1	-9.0
2	104.51	27.6 QP	43.5	-15.9	1.00 V	54	40.0	-12.4
3	173.41	27.2 QP	43.5	-16.3	1.00 V	95	36.4	-9.2
4	270.42	27.8 QP	46.0	-18.2	2.00 V	337	36.2	-8.4
5	391.33	25.6 QP	46.0	-20.4	1.49 V	128	30.4	-4.8
6	432.10	28.9 QP	46.0	-17.1	1.00 V	332	32.0	-3.1

Remarks:

1. Emission Level(dBuV/m) = Raw Value(dBuV) + Correction Factor(dB/m)
2. Correction Factor(dB/m) = Antenna Factor(dB/m) + Cable Factor(dB) – Pre-Amplifier Factor(dB)
3. The other emission levels were very low against the limit.
4. Margin value = Emission Level – Limit value

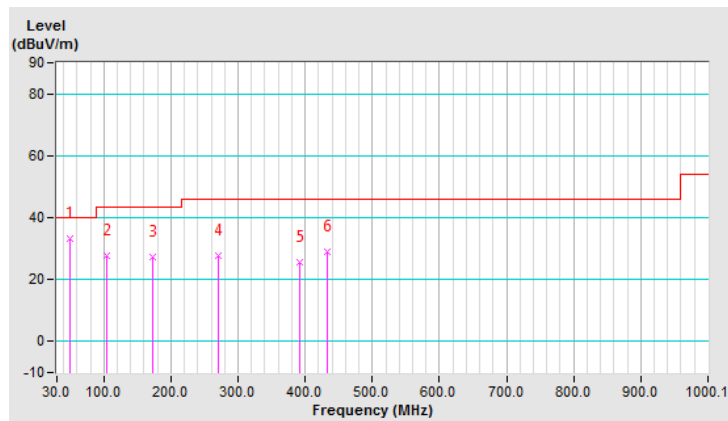

4.2 Conducted Emission Measurement

4.2.1 Limits of Conducted Emission Measurement

Frequency (MHz)	Conducted Limit (dBuV)	
	Quasi-peak	Average
0.15 - 0.5	66 - 56	56 - 46
0.50 - 5.0	56	46
5.0 - 30.0	60	50

Note: 1. The lower limit shall apply at the transition frequencies.

2. The limit decreases in line with the logarithm of the frequency in the range of 0.15 to 0.50MHz.

4.2.2 Test Instruments

Description & Manufacturer	Model No.	Serial No.	Cal. Date	Cal. Due
Test Receiver ROHDE & SCHWARZ	ESCI	100613	Dec. 10, 2018	Dec. 09, 2019
RF signal cable Woken	5D-FB	Cable-cond1-01	Sep. 05, 2019	Sep. 04, 2020
LISN ROHDE & SCHWARZ (EUT)	ENV216	101826	Feb. 21, 2019	Feb. 20, 2020
LISN ROHDE & SCHWARZ (Peripheral)	ESH3-Z5	100311	Aug. 22, 2019	Aug. 21, 2020
Software ADT	BV ADT_Cond_ V7.3.7.4	NA	NA	NA

Note: 1. The calibration interval of the above test instruments is 12 months and the calibrations are traceable to NML/ROC and NIST/USA.

2. The test was performed in HwaYa Shielded Room 1.

3. The VCCI Site Registration No. is C-12040.

4.2.3 Test Procedures

- The EUT was placed 0.4 meters from the conducting wall of the shielded room with EUT being connected to the power mains through a line impedance stabilization network (LISN). Other support units were connected to the power mains through another LISN. The two LISNs provide 50 ohm/ 50uH of coupling impedance for the measuring instrument.
- Both lines of the power mains connected to the EUT were checked for maximum conducted interference.
- The frequency range from 150kHz to 30MHz was searched. Emission levels under (Limit - 20dB) was not recorded.

Note: The resolution bandwidth and video bandwidth of test receiver is 9kHz for quasi-peak detection (QP) and average detection (AV) at frequency 0.15MHz-30MHz.

4.2.4 Deviation from Test Standard

No deviation.

4.2.5 Test Setup

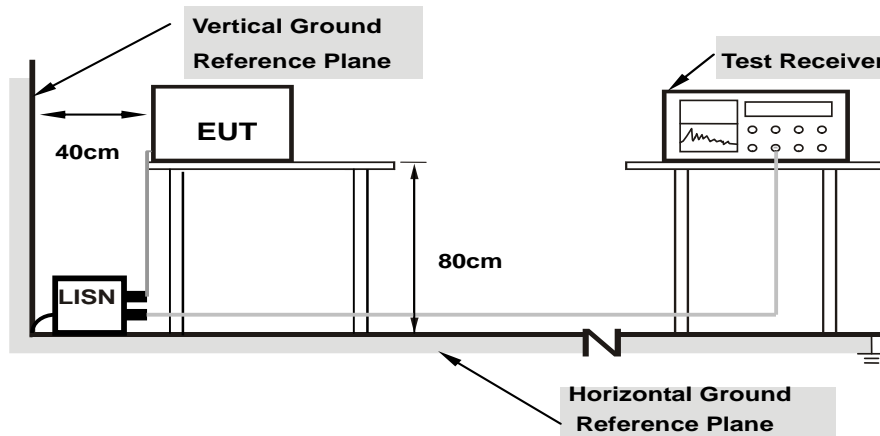

Note: 1.Support units were connected to second LISN.

For the actual test configuration, please refer to the attached file (Test Setup Photo).

4.2.6 EUT Operating Conditions

Same as 4.1.6.

4.2.7 Test Results

Type A

Phase	Line (L)	Detector Function	Quasi-Peak (QP) / Average (AV)
-------	----------	-------------------	--------------------------------

No	Freq. [MHz]	Corr. Factor (dB)	Reading Value [dB (uV)]		Emission Level [dB (uV)]		Limit [dB (uV)]		Margin (dB)	
			Q.P.	AV.	Q.P.	AV.	Q.P.	AV.	Q.P.	AV.
			1	0.15000	9.67	24.53	5.61	34.20	15.28	66.00
2	0.18228	9.66	15.99	10.56	25.65	20.22	64.38	54.38	-38.73	-34.16
3	0.41799	9.69	21.53	18.63	31.22	28.32	57.49	47.49	-26.27	-19.17
4	1.43400	9.75	10.80	0.63	20.55	10.38	56.00	46.00	-35.45	-35.62
5	3.94600	9.84	11.63	3.91	21.47	13.75	56.00	46.00	-34.53	-32.25
6	13.56200	9.95	28.72	25.63	38.67	35.58	60.00	50.00	-21.33	-14.42

Remarks:

1. Q.P. and AV. are abbreviations of quasi-peak and average individually.
2. The emission levels of other frequencies were very low against the limit.
3. Margin value = Emission level - Limit value
4. Correction factor = Insertion loss + Cable loss
5. Emission Level = Correction Factor + Reading Value.

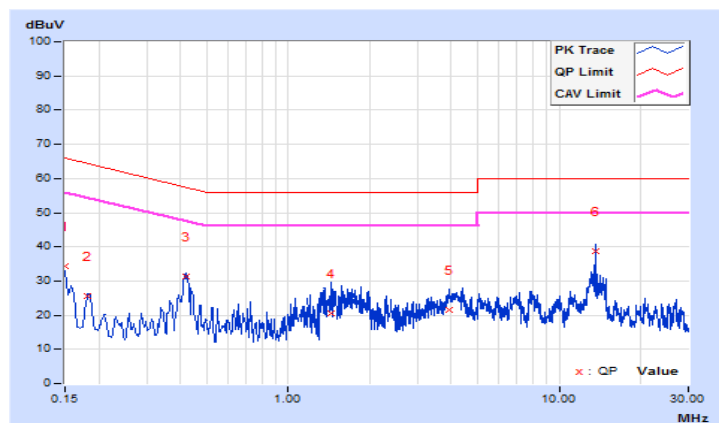

Phase	Neutral (N)	Detector Function	Quasi-Peak (QP) / Average (AV)
-------	-------------	-------------------	--------------------------------

No	Freq. [MHz]	Corr. Factor (dB)	Reading Value [dB (uV)]		Emission Level [dB (uV)]		Limit [dB (uV)]		Margin (dB)	
			Q.P.	AV.	Q.P.	AV.	Q.P.	AV.	Q.P.	AV.
			1	0.17000	9.64	20.30	2.34	29.94	11.98	64.96
2	0.24600	9.64	12.26	3.42	21.90	13.06	61.89	51.89	-39.99	-38.83
3	0.37028	9.66	16.45	8.65	26.11	18.31	58.49	48.49	-32.38	-30.18
4	0.41799	9.66	22.52	19.90	32.18	29.56	57.49	47.49	-25.31	-17.93
5	2.61000	9.77	12.42	4.49	22.19	14.26	56.00	46.00	-33.81	-31.74
6	13.56200	9.97	38.22	36.60	48.19	46.57	60.00	50.00	-11.81	-3.43

Remarks:

1. Q.P. and AV. are abbreviations of quasi-peak and average individually.
2. The emission levels of other frequencies were very low against the limit.
3. Margin value = Emission level - Limit value
4. Correction factor = Insertion loss + Cable loss
5. Emission Level = Correction Factor + Reading Value.

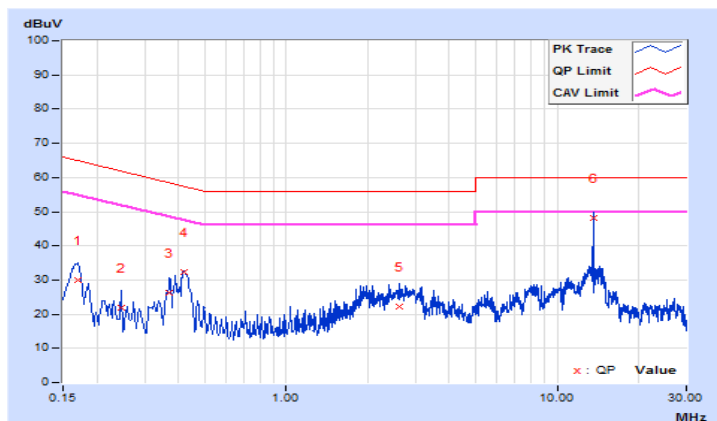

Type B

Phase	Line (L)	Detector Function	Quasi-Peak (QP) / Average (AV)
-------	----------	-------------------	--------------------------------

No	Freq. [MHz]	Corr. Factor (dB)	Reading Value [dB (uV)]		Emission Level [dB (uV)]		Limit [dB (uV)]		Margin (dB)	
			Q.P.	AV.	Q.P.	AV.	Q.P.	AV.	Q.P.	AV.
			1	0.16190	9.67	21.73	8.99	31.40	18.66	65.37
2	0.21400	9.66	14.87	1.41	24.53	11.07	63.05	53.05	-38.52	-41.98
3	0.26221	9.67	14.26	3.58	23.93	13.25	61.36	51.36	-37.43	-38.11
4	2.16600	9.78	9.89	2.37	19.67	12.15	56.00	46.00	-36.33	-33.85
5	4.77000	9.85	11.26	4.29	21.11	14.14	56.00	46.00	-34.89	-31.86
6	13.56200	9.95	28.76	25.66	38.71	35.61	60.00	50.00	-21.29	-14.39

Remarks:

1. Q.P. and AV. are abbreviations of quasi-peak and average individually.
2. The emission levels of other frequencies were very low against the limit.
3. Margin value = Emission level - Limit value
4. Correction factor = Insertion loss + Cable loss
5. Emission Level = Correction Factor + Reading Value.

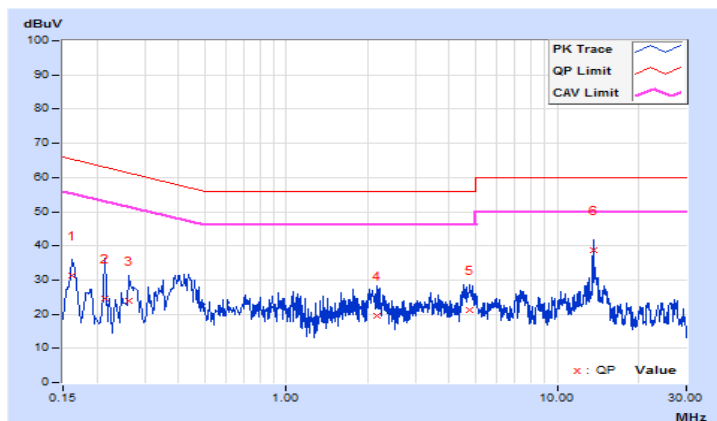

Phase	Neutral (N)	Detector Function	Quasi-Peak (QP) / Average (AV)
-------	-------------	-------------------	--------------------------------

No	Freq. [MHz]	Corr. Factor (dB)	Reading Value [dB (uV)]		Emission Level [dB (uV)]		Limit [dB (uV)]		Margin (dB)	
			Q.P.	AV.	Q.P.	AV.	Q.P.	AV.	Q.P.	AV.
			1	0.15800	9.64	23.05	15.68	32.69	25.32	65.57
2	0.20600	9.64	12.82	3.55	22.46	13.19	63.37	53.37	-40.91	-40.18
3	0.42200	9.66	21.95	18.59	31.61	28.25	57.41	47.41	-25.80	-19.16
4	1.16600	9.71	2.88	1.83	12.59	11.54	56.00	46.00	-43.41	-34.46
5	2.71800	9.77	12.95	6.15	22.72	15.92	56.00	46.00	-33.28	-30.08
6	13.55800	9.97	38.58	36.81	48.55	46.78	60.00	50.00	-11.45	-3.22

Remarks:

1. Q.P. and AV. are abbreviations of quasi-peak and average individually.
2. The emission levels of other frequencies were very low against the limit.
3. Margin value = Emission level - Limit value
4. Correction factor = Insertion loss + Cable loss
5. Emission Level = Correction Factor + Reading Value.

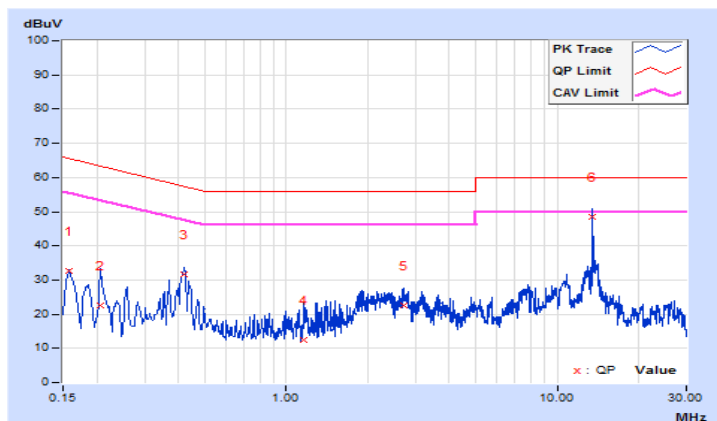

Type F

Phase	Line (L)	Detector Function	Quasi-Peak (QP) / Average (AV)
-------	----------	-------------------	--------------------------------

No	Freq. [MHz]	Corr. Factor (dB)	Reading Value [dB (uV)]		Emission Level [dB (uV)]		Limit [dB (uV)]		Margin (dB)	
			Q.P.	AV.	Q.P.	AV.	Q.P.	AV.	Q.P.	AV.
			1	0.15728	9.67	17.66	14.76	27.33	24.43	65.61
2	0.21000	9.66	13.91	6.80	23.57	16.46	63.21	53.21	-39.64	-36.75
3	0.27800	9.67	12.78	0.76	22.45	10.43	60.88	50.88	-38.43	-40.45
4	0.41799	9.69	21.44	19.01	31.13	28.70	57.49	47.49	-26.36	-18.79
5	1.40600	9.75	11.81	0.12	21.56	9.87	56.00	46.00	-34.44	-36.13
6	13.55800	9.95	28.62	25.43	38.57	35.38	60.00	50.00	-21.43	-14.62

Remarks:

1. Q.P. and AV. are abbreviations of quasi-peak and average individually.
2. The emission levels of other frequencies were very low against the limit.
3. Margin value = Emission level - Limit value
4. Correction factor = Insertion loss + Cable loss
5. Emission Level = Correction Factor + Reading Value.

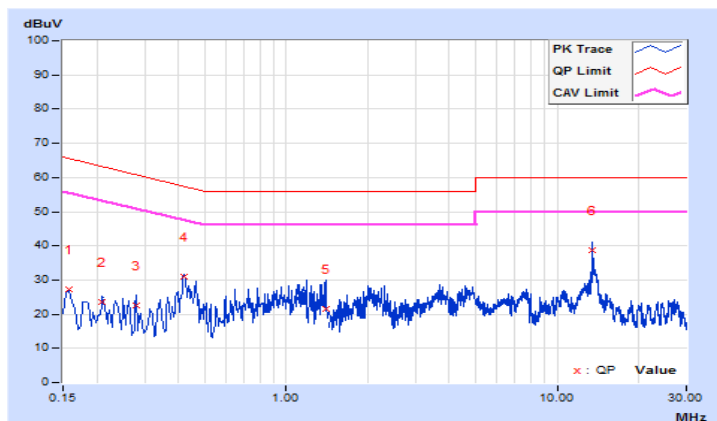

Phase	Neutral (N)	Detector Function	Quasi-Peak (QP) / Average (AV)
-------	-------------	-------------------	--------------------------------

No	Freq. [MHz]	Corr. Factor (dB)	Reading Value [dB (uV)]		Emission Level [dB (uV)]		Limit [dB (uV)]		Margin (dB)	
			Q.P.	AV.	Q.P.	AV.	Q.P.	AV.	Q.P.	AV.
			1	0.15800	9.64	20.12	15.08	29.76	24.72	65.57
2	0.18228	9.64	17.07	10.25	26.71	19.89	64.38	54.38	-37.67	-34.49
3	0.41909	9.66	23.05	21.14	32.71	30.80	57.47	47.47	-24.76	-16.67
4	3.37400	9.79	11.28	5.49	21.07	15.28	56.00	46.00	-34.93	-30.72
5	8.17400	9.88	11.71	5.20	21.59	15.08	60.00	50.00	-38.41	-34.92
6	13.56200	9.97	37.92	36.88	47.89	46.85	60.00	50.00	-12.11	-3.15

Remarks:

1. Q.P. and AV. are abbreviations of quasi-peak and average individually.
2. The emission levels of other frequencies were very low against the limit.
3. Margin value = Emission level - Limit value
4. Correction factor = Insertion loss + Cable loss
5. Emission Level = Correction Factor + Reading Value.

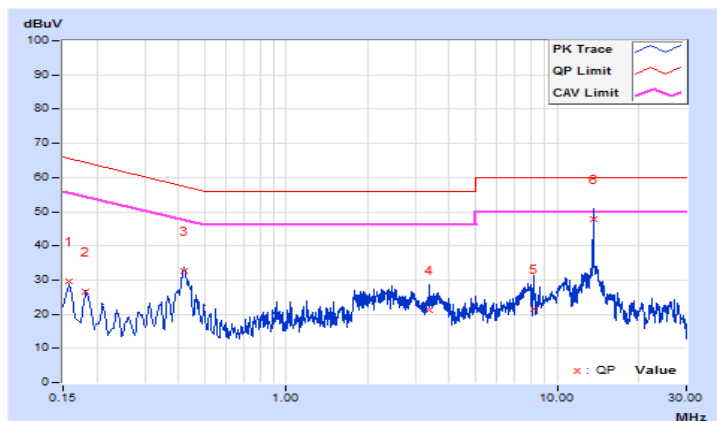

Type V

Phase	Line (L)	Detector Function	Quasi-Peak (QP) / Average (AV)
-------	----------	-------------------	--------------------------------

No	Freq. [MHz]	Corr. Factor (dB)	Reading Value [dB (uV)]		Emission Level [dB (uV)]		Limit [dB (uV)]		Margin (dB)	
			Q.P.	AV.	Q.P.	AV.	Q.P.	AV.	Q.P.	AV.
			1	0.15811	9.67	17.55	14.22	27.22	23.89	65.56
2	0.18519	9.66	14.88	8.96	24.54	18.62	64.25	54.25	-39.71	-35.63
3	0.41799	9.69	21.42	18.97	31.11	28.66	57.49	47.49	-26.38	-18.83
4	1.34600	9.75	11.37	3.55	21.12	13.30	56.00	46.00	-34.88	-32.70
5	3.64600	9.83	11.39	4.50	21.22	14.33	56.00	46.00	-34.78	-31.67
6	13.56200	9.95	28.79	25.71	38.74	35.66	60.00	50.00	-21.26	-14.34

Remarks:

1. Q.P. and AV. are abbreviations of quasi-peak and average individually.
2. The emission levels of other frequencies were very low against the limit.
3. Margin value = Emission level - Limit value
4. Correction factor = Insertion loss + Cable loss
5. Emission Level = Correction Factor + Reading Value.

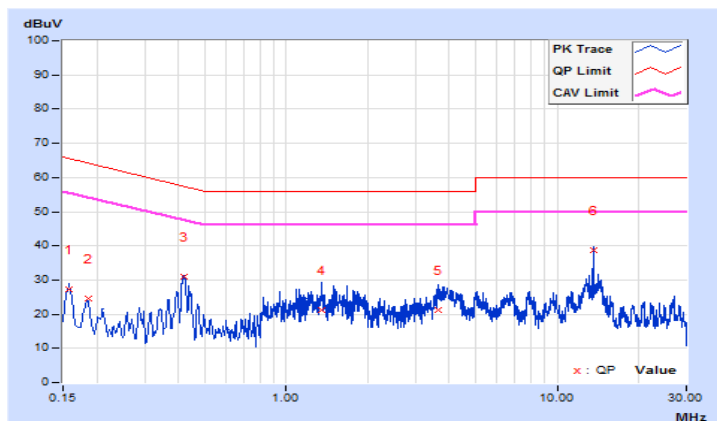

Phase	Neutral (N)	Detector Function	Quasi-Peak (QP) / Average (AV)
-------	-------------	-------------------	--------------------------------

No	Freq. [MHz]	Corr. Factor (dB)	Reading Value [dB (uV)]		Emission Level [dB (uV)]		Limit [dB (uV)]		Margin (dB)	
			Q.P.	AV.	Q.P.	AV.	Q.P.	AV.	Q.P.	AV.
			1	0.15400	9.64	22.36	12.68	32.00	22.32	65.78
2	0.23000	9.64	11.94	3.22	21.58	12.86	62.45	52.45	-40.87	-39.59
3	0.27786	9.65	11.43	0.21	21.08	9.86	60.88	50.88	-39.80	-41.02
4	0.41799	9.66	22.74	20.67	32.40	30.33	57.49	47.49	-25.09	-17.16
5	8.02600	9.88	12.08	5.29	21.96	15.17	60.00	50.00	-38.04	-34.83
6	13.56200	9.97	37.55	36.22	47.52	46.19	60.00	50.00	-12.48	-3.81

Remarks:

1. Q.P. and AV. are abbreviations of quasi-peak and average individually.
2. The emission levels of other frequencies were very low against the limit.
3. Margin value = Emission level - Limit value
4. Correction factor = Insertion loss + Cable loss
5. Emission Level = Correction Factor + Reading Value.

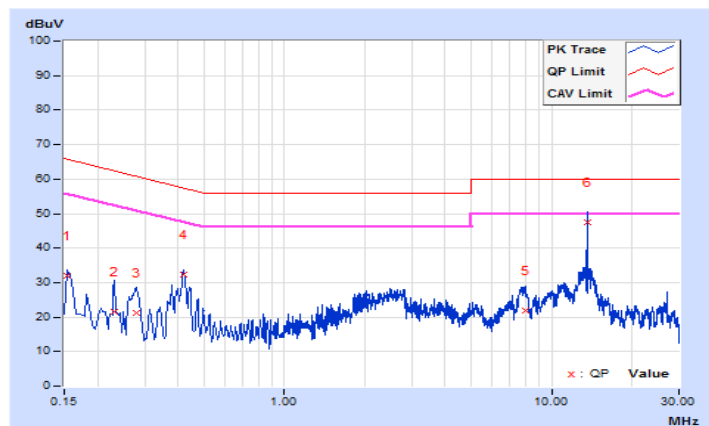

4.3 Frequency Stability

4.3.1 Limits of Frequency Stability Measurement

The frequency tolerance of the carrier signal shall be maintained within +/- 0.01% of the operating frequency over a temperature variation of -20 degrees to 50 degrees C at normal supply voltage, and for a variation in the primary supply voltage from 85% to 115% of the rated supply voltage at a temperature of 20 degrees C.

4.3.2 Test Setup

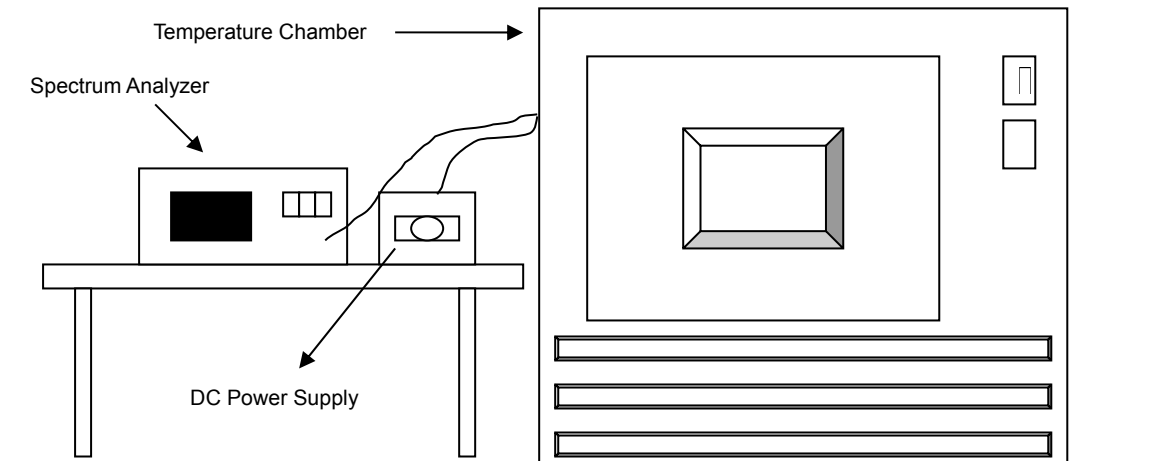

4.3.3 Test Instruments

Description & Manufacturer	Model No.	Serial No.	Cal. Date	Cal. Due
Spectrum Analyzer ROHDE & SCHWARZ	FSP40	100040	Sep. 23, 2019	Sep. 22, 2020
WIT Standard Temperature And Humidity Chamber	TH-4S-C	W981030	Jun. 03, 2019	Jun. 02, 2020
Digital Multimeter Fluke	87-III	70360742	Jun. 28, 2019	Jun. 27, 2020
DC Power Supply Topward	6306A	727263	NA	NA

Note: 1. The calibration interval of the above test instruments is 12 months and the calibrations are traceable to NML/ROC and NIST/USA.

4.3.4 Test Procedure

- The EUT was placed inside the environmental test chamber and powered by nominal DC voltage.
- Turned the EUT on and coupled its output to a spectrum analyzer.
- Turned the EUT off and set the chamber to the highest temperature specified.
- Allowed sufficient time (approximately 30 min) for the temperature of the chamber to stabilize then turned the EUT on and measured the operating frequency after 2, 5, and 10 minutes.
- Repeat step c and d with every 10 degrees reduction until the lowest temperature achieved.
- The test chamber was allowed to stabilize at +20 degree C for a minimum of 30 minutes. The supply voltage was then adjusted on the EUT from 85% to 115% and the frequency record.

4.3.5 Deviation from Test Standard

No deviation.

4.3.6 EUT Operating Conditions

Same as Item 4.1.6.

4.3.7 Test Result

Type B

Frequency Stability Versus Temp.									
TEMP. (°C)	Power Supply (Vdc)	0 Minute		2 Minute		5 Minute		10 Minute	
		Measured Frequency	Frequency Drift	Measured Frequency	Frequency Drift	Measured Frequency	Frequency Drift	Measured Frequency	Frequency Drift
		(MHz)	%	(MHz)	%	(MHz)	%	(MHz)	%
50	20	13.56001	0.00007	13.56001	0.00007	13.56001	0.00007	13.56002	0.00015
40	20	13.55993	-0.00052	13.55994	-0.00044	13.55995	-0.00037	13.55994	-0.00044
30	20	13.55994	-0.00044	13.55994	-0.00044	13.55994	-0.00044	13.55994	-0.00044
20	20	13.56004	0.00029	13.56004	0.00029	13.56004	0.00029	13.56005	0.00037
10	20	13.56004	0.00029	13.56005	0.00037	13.56005	0.00037	13.56005	0.00037
0	20	13.56004	0.00029	13.56003	0.00022	13.56003	0.00022	13.56004	0.00029
-10	20	13.56003	0.00022	13.56002	0.00015	13.56003	0.00022	13.56003	0.00022
-20	20	13.56002	0.00015	13.56002	0.00015	13.56002	0.00015	13.56002	0.00015

Frequency Stability Versus Voltage									
TEMP. (°C)	Power Supply (Vdc)	0 Minute		2 Minute		5 Minute		10 Minute	
		Measured Frequency	Frequency Drift	Measured Frequency	Frequency Drift	Measured Frequency	Frequency Drift	Measured Frequency	Frequency Drift
		(MHz)	%	(MHz)	%	(MHz)	%	(MHz)	%
20	23	13.56004	0.00029	13.56004	0.00029	13.56004	0.00029	13.56005	0.00037
	20	13.56004	0.00029	13.56004	0.00029	13.56004	0.00029	13.56005	0.00037
	17	13.56004	0.00029	13.56004	0.00029	13.56004	0.00029	13.56005	0.00037

4.4 20dB Bandwidth

4.4.1 Limits of 20dB Bandwidth Measurement

The 20dB bandwidth shall be specified in operating frequency band.

4.4.2 Test Setup

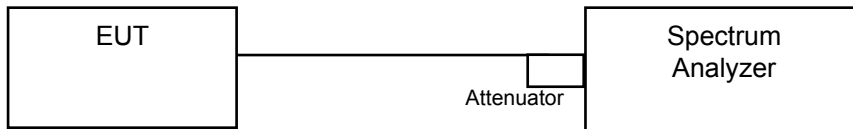

4.4.3 Test Instruments

Refer to section 4.1.2 to get information of above instrument.

4.4.4 Test Procedures

The bandwidth of the fundamental frequency was measured by spectrum analyzer with 1kHz RBW and 3kHz VBW. The 20dB bandwidth is defined as the total spectrum the power of which is higher than peak power minus 20dB.

4.4.5 Deviation from Test Standard

No deviation.

4.4.6 EUT Operating Conditions

Same as Item 4.1.6.

4.4.7 Test Results

Type A

20dBc point (Low)	20dBc point (High)	Operating frequency band (MHz)	Pass / Fail
13.5588	13.56144	13.553~13.567	Pass

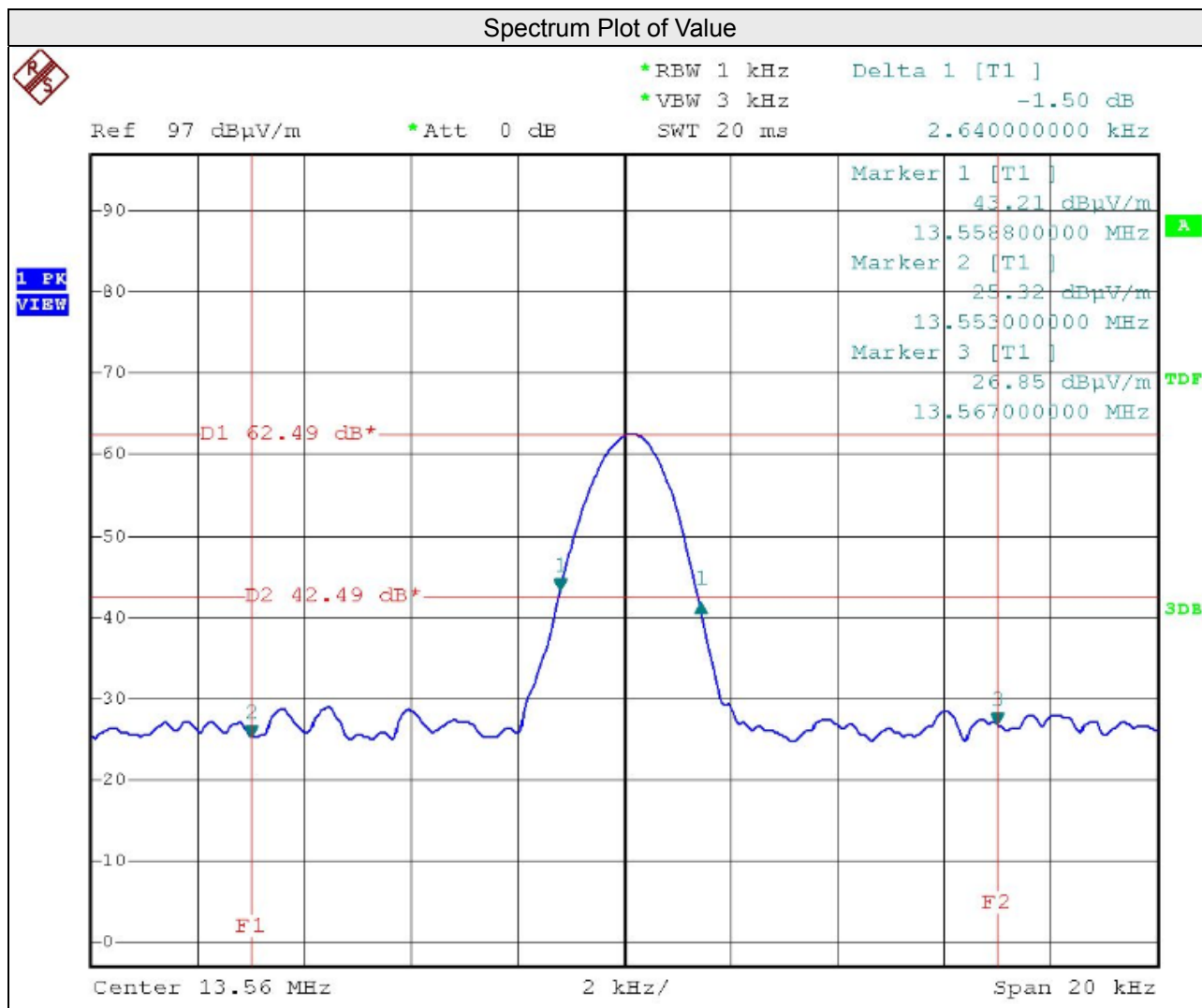

Note: The signal look like CW signal, so RBW can't be match 1~5 % OBW.

Type B

20dBc point (Low)	20dBc point (High)	Operating frequency band (MHz)	Pass / Fail
13.5588	13.56144	13.553~13.567	Pass

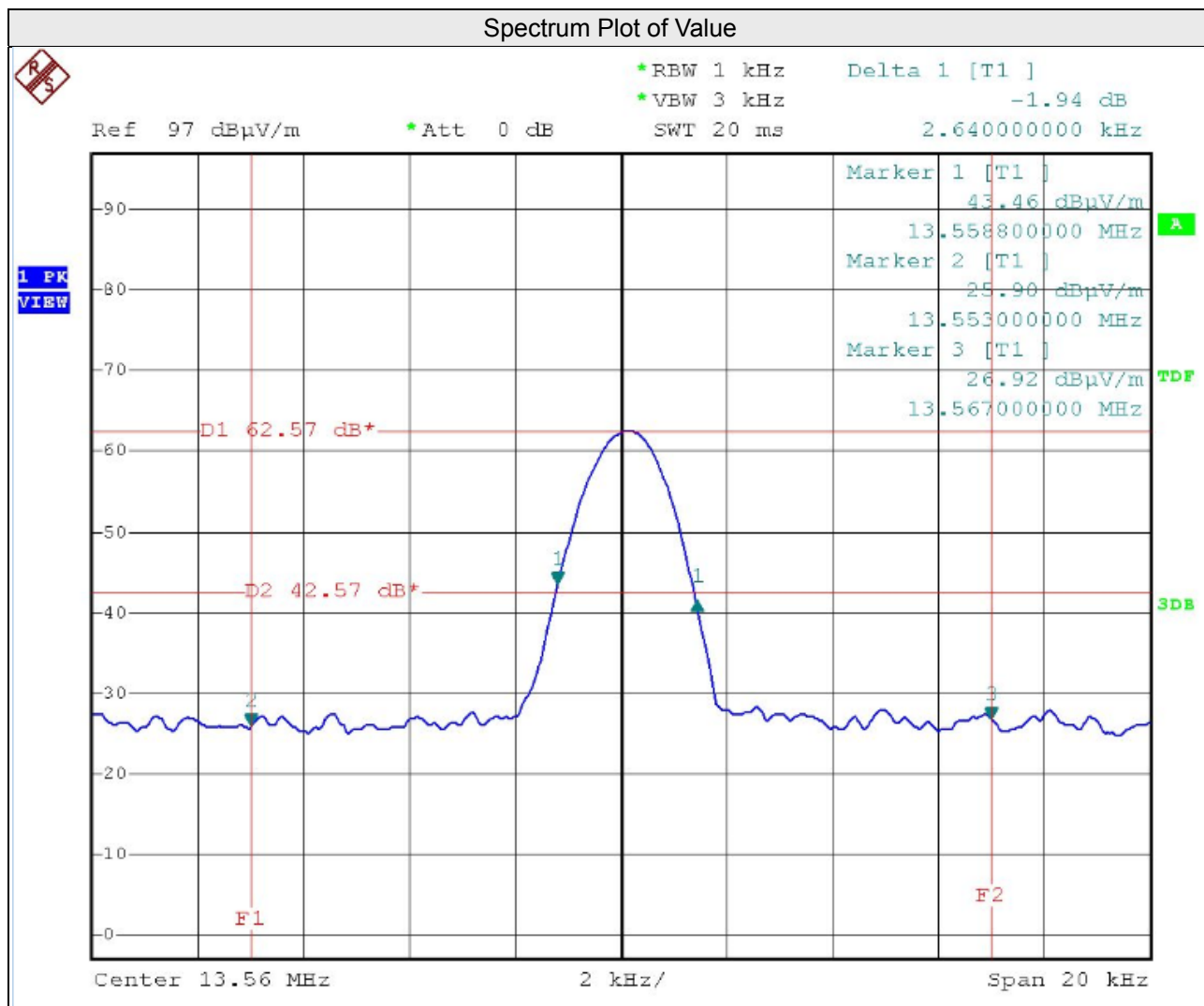

Note: The signal look like CW signal, so RBW can't be match 1~5 % OBW.

Type F

20dBc point (Low)	20dBc point (High)	Operating frequency band (MHz)	Pass / Fail
13.55876	13.56144	13.553~13.567	Pass

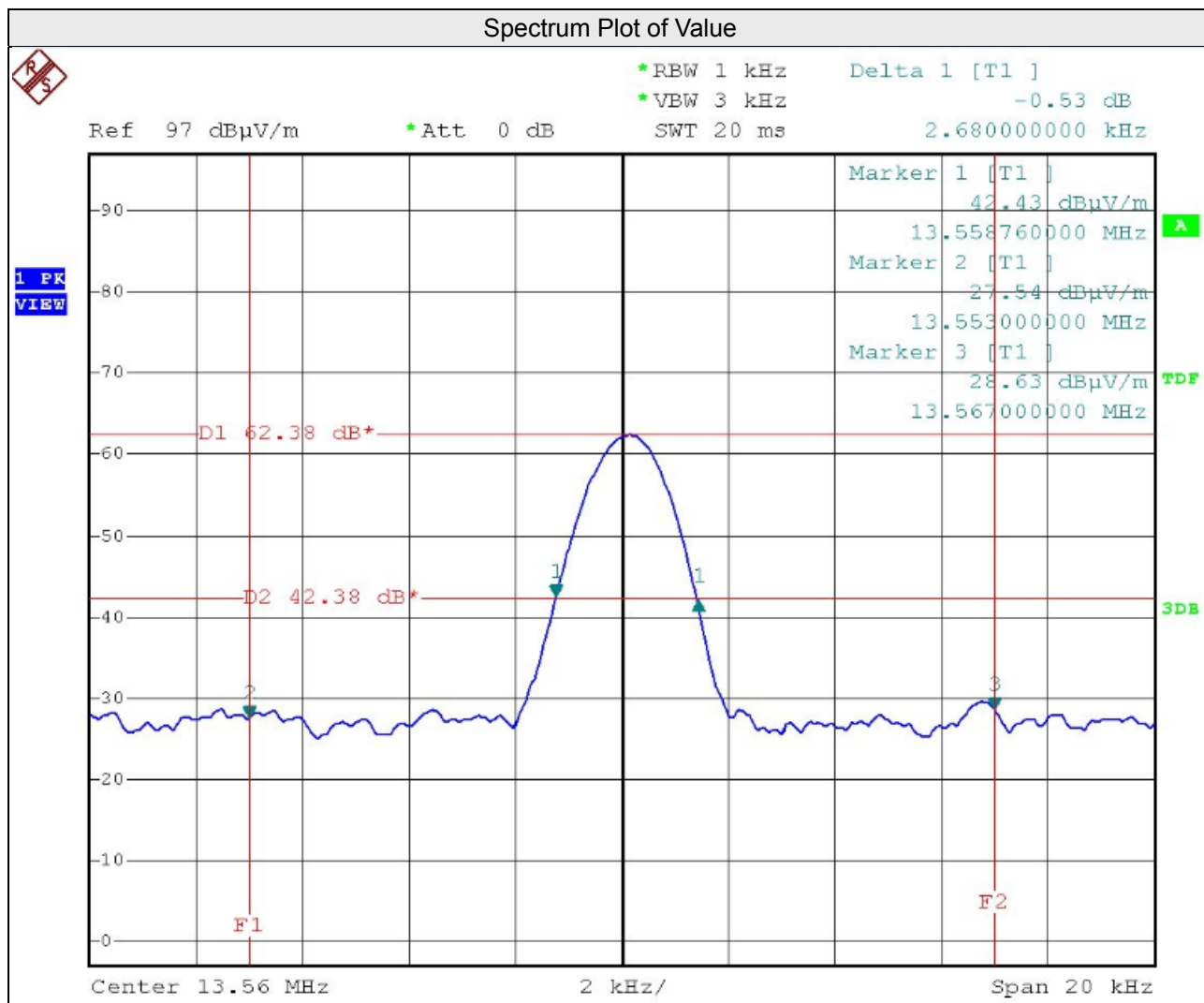

Note: The signal look like CW signal, so RBW can't be match 1~5 % OBW.

Type V

20dBc point (Low)	20dBc point (High)	Operating frequency band (MHz)	Pass / Fail
13.55876	13.56144	13.553~13.567	Pass

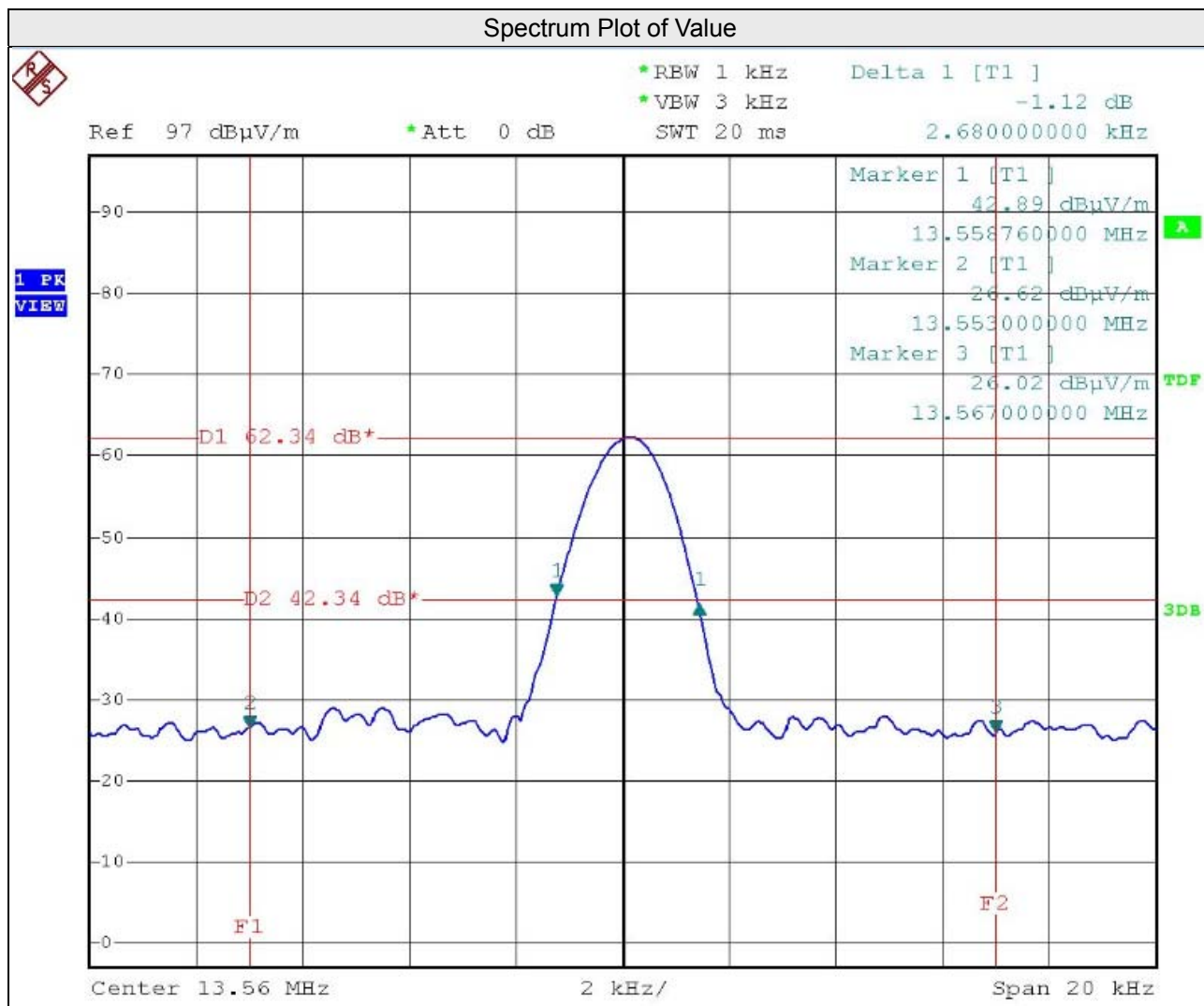

Note: The signal look like CW signal, so RBW can't be match 1~5 % OBW.

5 Pictures of Test Arrangements

Please refer to the attached file (Test Setup Photo).

Appendix – Information of the Testing Laboratories

We, Bureau Veritas Consumer Products Services (H.K.) Ltd., Taoyuan Branch, were founded in 1988 to provide our best service in EMC, Radio, Telecom and Safety consultation. Our laboratories are FCC recognized accredited test firms and accredited and approved according to ISO/IEC 17025.

If you have any comments, please feel free to contact us at the following:

Lin Kou EMC/RF Lab

Tel: 886-2-26052180

Fax: 886-2-26051924

Hsin Chu EMC/RF/Telecom Lab

Tel: 886-3-6668565

Fax: 886-3-6668323

Hwa Ya EMC/RF/Safety Lab

Tel: 886-3-3183232

Fax: 886-3-3270892

Email: service.adt@tw.bureauveritas.com

Web Site: www.bureauveritas-adt.com

The address and road map of all our labs can be found in our web site also.

--- END ---