



FCC RF Test Report

APPLICANT : DELL Inc.
EQUIPMENT : Tablet PC
BRAND NAME : Dell
MODEL NAME : T02D; T02D004
TYPE NAME : T02D004
FCC ID : E2K-T02D004
STANDARD : FCC 47 CFR Part 2, 22(H), 24(E), 27(L)
CLASSIFICATION : PCS Licensed Transmitter (PCB)

The product was received on Mar. 18, 2014 and testing was completed on Aug. 22, 2014. We, SPORTON INTERNATIONAL (KUNSHAN) INC., would like to declare that the tested sample has been evaluated in accordance with the test procedures given in ANSI / TIA / EIA-603-C-2004 and has been in compliance with the applicable technical standards.

The test results in this report apply exclusively to the tested model / sample. Without written approval of SPORTON INTERNATIONAL (KUNSHAN) INC., the test report shall not be reproduced except in full.

Reviewed by: Joseph Lin / Supervisor

Approved by: Jones Tsai / Manager



SPORTON INTERNATIONAL (KUNSHAN) INC.
No. 3-2, PingXiang Road, Kunshan, Jiangsu Province, P.R.C.



TABLE OF CONTENTS

REVISION HISTORY.....	3
SUMMARY OF TEST RESULT	4
1 GENERAL DESCRIPTION	5
1.1 Applicant.....	5
1.2 Manufacturer	5
1.3 Product Feature of Equipment Under Test	5
1.4 Product Specification subjective to this standard.....	6
1.5 Modification of EUT	6
1.6 Maximum ERP/EIRP Power, Frequency Tolerance, and Emission Designator	7
1.7 Testing Location	7
1.8 Applicable Standards	8
2 TEST CONFIGURATION OF EQUIPMENT UNDER TEST.....	9
2.1 Test Mode.....	9
2.2 Connection Diagram of Test System	11
2.3 Support Unit used in test configuration	11
2.4 Measurement Results Explanation Example	11
3 TEST RESULT.....	12
3.1 Conducted Output Power Measurement.....	12
3.2 Peak-to-Average Ratio	15
3.3 Effective Radiated Power and Effective Isotropic Radiated Power Measurement	31
3.4 99% Occupied Bandwidth and 26dB Bandwidth Measurement.....	37
3.5 Band Edge Measurement.....	61
3.6 Conducted Spurious Emission Measurement.....	76
3.7 Field Strength of Spurious Radiation Measurement	131
3.8 Frequency Stability Measurement.....	154
4 LIST OF MEASURING EQUIPMENT.....	160
5 UNCERTAINTY OF EVALUATION.....	161
APPENDIX A. SETUP PHOTOGRAPHS	



REVISION HISTORY

REPORT NO.	VERSION	DESCRIPTION	ISSUED DATE
FG431806-01A	Rev. 01	Initial issue of report	Aug. 29, 2014



SUMMARY OF TEST RESULT

Report Section	FCC Rule	IC Rule	Description	Limit	Result	Remark
3.1	§2.1046	RSS-132 (5.4) RSS-133 (6.4) RSS-139 (6.4)	Conducted Output Power	Reporting Only	PASS	-
3.2	§24.232(d)	RSS-132 (5.4) RSS-133 (6.4) RSS-139 (6.4)	Peak-to-Average Ratio	< 13 dB	PASS	-
3.3	§22.913(a)(2)	RSS-132(5.4) SRSP-503(5.1.3)	Effective Radiated Power	< 7 Watts	PASS	-
	§24.232(c)	RSS-133 (6.4) SRSP-510(5.1.2)	Equivalent Isotropic Radiated Power	< 2 Watts	PASS	-
	§27.50(d)(4)	RSS-139 (6.4) SRSP-513(5.1.2)	Equivalent Isotropic Radiated Power	< 1 Watts	PASS	-
3.4	§2.1049 §22.917(b) §24.238(b) §27.53(g)	RSS-GEN(4.6.1) RSS-133(6.5) RSS-139 (6.5)	Occupied Bandwidth	Reporting Only	PASS	-
3.5	§2.1051 §22.917(a) §24.238(a) §27.53(h)	RSS-GEN(4.9) RSS-132 (5.5) RSS-133 (6.5) RSS-139 (6.5)	Band Edge Measurement	< 43+10log10(P[Watts])	PASS	-
3.6	§2.1051 §22.917(a) §24.238(a) §27.53(h)	RSS-GEN(4.9) RSS-132 (5.5) RSS-133 (6.5) RSS-139 (6.5)	Conducted Spurious Emission	< 43+10log10(P[Watts])	PASS	-
3.7	§2.1053 §22.917(a) §24.238(a) §27.53(h)	RSS-GEN(4.9) RSS-132 (5.5) RSS-133 (6.5) RSS-139 (6.5)	Field Strength of Spurious Radiation	< 43+10log10(P[Watts])	PASS	Under limit 31.86 dB at 2510.000 MHz
3.8	§2.1055 §22.355 §24.235 §27.54	RSS-GEN(4.7) RSS-132 (5.3) RSS-133 (6.3) RSS-139 (6.3)	Frequency Stability for Temperature & Voltage	< 2.5 ppm	PASS	-



1 General Description

1.1 Applicant

DELL Inc.
One Dell Way, Round Rock, Texas 78682, United States

1.2 Manufacturer

DELL Inc.
One Dell Way, Round Rock, Texas 78682, United States

1.3 Product Feature of Equipment Under Test

Product Feature	
Equipment	Tablet PC
Brand Name	Dell
Model Name	T02D; T02D004
Type Name	T02D004
FCC ID	E2K-T02D004
EUT supports Radios application	GSM/GPRS/EGPRS/WCDMA/HSPA/ HSPA+(Downlink Only)/DC-HSDPA/LTE/ 802.11a/b/g/n (HT20 / HT40)/ 802.11ac (VHT20/VHT40/VHT80)/ Bluetooth v3.0 + EDR / Bluetooth v4.0 LE
HW Version	DVT-B-V0.40
SW Version	YTP802A410830
EUT Stage	Identical Prototype

Remark: The above EUT's information was declared by manufacturer. Please refer to the specifications or user's manual for more detailed description.

1.4 Product Specification subjective to this standard

Product Specification subjective to this standard	
Tx Frequency	GSM850: 824.2 MHz ~ 848.8 MHz GSM1900: 1850.2 MHz ~ 1909.8MHz WCDMA Band V: 826.4 MHz ~ 846.6 MHz WCDMA Band IV : 1712.4 MHz ~ 1752.6 MHz WCDMA Band II: 1852.4 MHz ~ 1907.6 MHz
Rx Frequency	GSM850: 869.2 MHz ~ 893.8 MHz GSM1900: 1930.2 MHz ~ 1989.8 MHz WCDMA Band V: 871.4 MHz ~ 891.6 MHz WCDMA Band IV : 2112.4 MHz ~ 2152.6 MHz WCDMA Band II: 1932.4 MHz ~ 1987.6 MHz
Maximum Output Power to Antenna	GSM850 : 32.10 dBm GSM1900 : 30.11 dBm WCDMA Band V : 23.22 dBm WCDMA Band IV : 23.22 dBm WCDMA Band II : 22.43 dBm
99% Occupied Bandwidth	GSM850: 0.248MHz GSM1900: 0.250MHz WCDMA Band V: 4.08MHz WCDMA Band IV: 4.08MHz WCDMA Band II: 4.10MHz
Antenna Type	Chip Antenna
Type of Modulation	GSM: GMSK GPRS: GMSK EDGE: GMSK / 8PSK WCDMA : QPSK (Uplink) HSDPA/DC-HSDPA : QPSK (Uplink) HSUPA : QPSK (Uplink) HSPA+ : 16QAM (Downlink Only) DC-HSDPA : 64QAM

1.5 Modification of EUT

No modifications are made to the EUT during all test items.



1.6 Maximum ERP/EIRP Power, Frequency Tolerance, and Emission Designator

FCC Rule	System	Type of Modulation	Maximum ERP/EIRP (W)	Frequency Tolerance (ppm)	Emission Designator
Part 22	GSM850 GPRS class 8	GMSK	0.86	0.05 ppm	248KGXW
Part 22	GSM850 EDGE class 8	8PSK	0.21	0.04 ppm	247KG7W
Part 22	WCDMA Band V RMC 12.2Kbps	QPSK	0.11	0.04 ppm	4M08F9W
Part 24	GSM1900 GPRS class 8	GMSK	1.40	0.03 ppm	246KGXW
Part 24	GSM1900 EDGE class 8	8PSK	0.62	0.02 ppm	250KG7W
Part 24	WCDMA Band II RMC 12.2Kbps	QPSK	0.27	0.01 ppm	4M10F9W
Part 27	WCDMA Band IV RMC 12.2Kbps	QPSK	0.39	0.01 ppm	4M08F9W

1.7 Testing Location

Test Site	SPORTON INTERNATIONAL (SHENZHEN) INC.	
Test Site Location	No. 3 Building, the third floor of south, Shahe River west, Fengzeyuan warehouse, Nanshan District, Shenzhen, Guangdong, P.R.C. TEL: +86-755-3320-2398	
Test Site No.	Sporton Site No.	FCC/IC Registration No.
	TH01-SZ	831040/4086F-1

Test Site	SPORTON INTERNATIONAL (KUNSHAN) INC.	
Test Site Location	No. 3-2, PingXiang Road, Kunshan, Jiangsu Province, P.R.C. TEL: +86-0512-5790-0158 FAX: +86-0512-5790-0958	
Test Site No.	Sporton Site No.	FCC/IC Registration No.
	03CH01-KS	149928/4086E-1



1.8 Applicable Standards

According to the specifications of the manufacturer, the EUT must comply with the requirements of the following standards:

- ♦ 47 CFR Part 2, 22(H), 24(E), 27(L)
- ♦ ANSI / TIA / EIA-603-C-2004
- ♦ FCC KDB 971168 D01 Power Meas. License Digital Systems v02r01
- ♦ IC RSS-132 Issue 3
- ♦ IC RSS-133 Issue 6
- ♦ IC RSS-139 Issue 2
- ♦ IC RSS-Gen Issue 3
- ♦ NOTICE 2012-DRS0126

Remark:

1. All test items were verified and recorded according to the standards and without any deviation during the test.
2. This EUT has also been tested and complied with the requirements of FCC Part 15, Subpart B, recorded in a separate test report.
3. Per the section 2.2.3 of Notice of 2012-DRS0126, " Receivers Excluded from Industry Canada Requirements", only radiocommunication receivers operating in stand-alone mode within the band 30-960 MHz and scanner receivers are subject to Industry Canada requirements.

2 Test Configuration of Equipment Under Test

2.1 Test Mode

Antenna port conducted and radiated test items were performed according to KDB 971168 D01 Power Meas. License Digital Systems v02r01 with maximum output power.

Radiated measurements were performed with rotating EUT in different three orthogonal test planes to find the maximum emission.

Radiated emissions were investigated as following frequency range:

1. 30 MHz to 9000 MHz for GSM850 and WCDMA Band V.
2. 30 MHz to 19000 MHz for GSM1900 and WCDMA Band II.
3. 30 MHz to 18000 MHz for WCDMA Band IV.

Test Modes		
Band	Radiated TCs	Conducted TCs
GSM 850	<ul style="list-style-type: none"> ■ GPRS class 8 Link ■ EDGE class 8 Link 	<ul style="list-style-type: none"> ■ GPRS class 8 Link ■ EDGE class 8 Link
GSM 1900	<ul style="list-style-type: none"> ■ GPRS class 8 Link ■ EDGE class 8 Link 	<ul style="list-style-type: none"> ■ GPRS class 8 Link ■ EDGE class 8 Link
WCDMA Band V	<ul style="list-style-type: none"> ■ RMC 12.2Kbps Link 	<ul style="list-style-type: none"> ■ RMC 12.2Kbps Link
WCDMA Band II	<ul style="list-style-type: none"> ■ RMC 12.2Kbps Link 	<ul style="list-style-type: none"> ■ RMC 12.2Kbps Link
WCDMA Band IV	<ul style="list-style-type: none"> ■ RMC 12.2Kbps Link 	<ul style="list-style-type: none"> ■ RMC 12.2Kbps Link

Note: The maximum power levels are chosen to test as the worst case configuration as follows:

GPRS multi-slot class 8 mode for GMSK modulation,

EDGE multi-slot class 8 mode for 8PSK modulation,

RMC 12.2Kbps mode for WCDMA band V,

RMC 12.2Kbps mode for WCDMA band II,

RMC 12.2Kbps mode for WCDMA band IV, only these modes were used for all tests.



Conducted Power Measurement Results:

Conducted Power (*Unit: dBm)						
Band	GSM850			GSM1900		
Channel	128	189	251	512	661	810
Frequency	824.2	836.4	848.8	1850.2	1880.0	1909.8
GSM	31.96	32.09	32.04	30.00	30.09	30.09
GPRS class 8	31.97	32.10	32.06	30.01	30.09	30.11
GPRS class 10	29.36	29.41	29.40	27.74	27.87	27.93
GPRS class 11	27.62	27.65	27.63	25.73	25.82	25.92
GPRS class 12	26.45	26.47	26.46	25.70	25.81	25.90
EGPRS class 8	26.72	26.73	26.67	26.13	26.25	26.45
EGPRS class 10	26.71	26.72	26.66	24.05	24.17	24.33
EGPRS class 11	25.93	25.92	25.88	22.09	22.23	22.40
EGPRS class 12	24.82	24.77	24.75	22.08	22.22	22.39

Conducted Power (*Unit: dBm)									
Band	WCDMA Band V			WCDMA Band II			WCDMA Band IV		
Channel	4132	4182	4233	9262	9400	9538	1312	1413	1513
Frequency	826.4	836.4	846.6	1852.4	1880	1907.6	1712.4	1732.6	1752.6
AMR 12.2K	23.08	23.21	23.20	22.35	22.42	22.38	23.00	23.10	23.21
RMC 12.2K	23.09	23.22	23.21	22.38	22.43	22.40	23.01	23.13	23.22
HSDPA Subtest-1	23.03	23.11	23.16	22.25	22.35	22.35	23.07	23.09	23.18
HSDPA Subtest-2	22.74	22.85	22.9	22.21	22.37	22.32	23.01	23.04	23.13
HSDPA Subtest-3	22.24	22.36	22.4	22.21	22.35	22.35	22.64	22.74	22.85
HSDPA Subtest-4	21.98	22.11	22.14	22.26	22.35	22.36	22.34	22.5	22.6
DC-HSDPA Subtest-1	22.94	23.10	23.07	22.17	22.24	22.12	23.20	23.15	23.18
DC-HSDPA Subtest-2	22.93	23.08	22.53	22.16	22.31	21.68	23.19	23.14	22.70
DC-HSDPA Subtest-3	22.41	22.58	22.03	21.68	21.68	21.19	22.62	22.65	22.20
DC-HSDPA Subtest-4	22.40	22.56	21.79	21.56	21.64	20.93	22.61	22.64	21.98
HSUPA Subtest-1	22.15	21.85	21.95	21.91	22.07	21.97	22.53	22.79	22.85
HSUPA Subtest-2	20.41	20.59	20.6	21.22	21.27	21.17	20.77	20.85	20.99
HSUPA Subtest-3	21.45	21.62	21.62	21.83	22.11	22.03	21.76	21.91	22.04
HSUPA Subtest-4	20.7	20.87	20.89	21.53	21.55	21.42	21.01	21.16	21.21
HSUPA Subtest-5	22.6	22.8	22.9	22.25	22.25	22.24	23.01	23	23.03

2.2 Connection Diagram of Test System

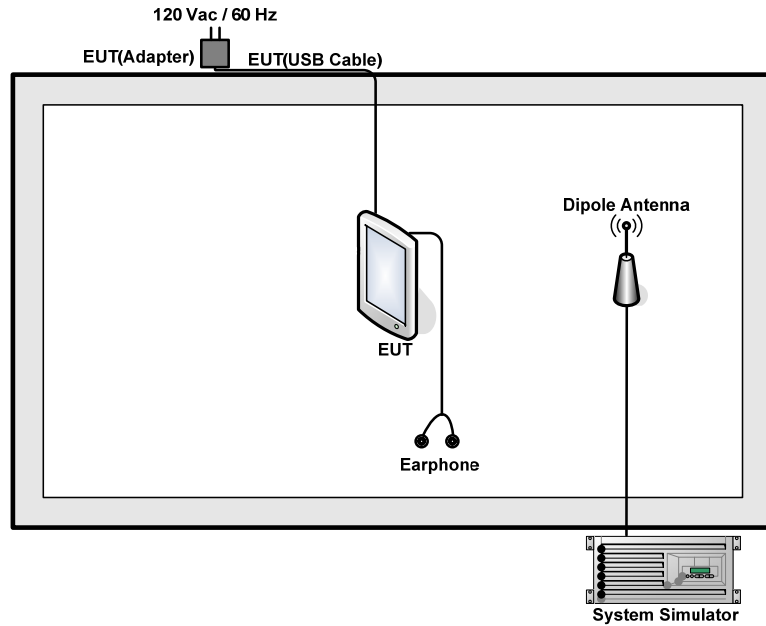

2.3 Support Unit used in test configuration

Item	Equipment	Trade Name	Model No.	FCC ID	Data Cable	Power Cord
1.	System Simulator	R&S	CMU 200	N/A	N/A	Unshielded, 1.8 m
2.	DC Power Supply	TOPWORD	3303DR	N/A	N/A	Unshielded, 1.8 m
3.	Earphone	Lenovo	SH100	FCC DoC	Unshielded, 1.2 m	N/A

2.4 Measurement Results Explanation Example

For all conducted test items:

The offset level is set in the spectrum analyzer to compensate the RF cable loss and attenuator factor between RF conducted output port and spectrum analyzer. With the offset compensation, the spectrum analyzer reading level will be exactly the RF output level.

The spectrum analyzer offset is derived from RF cable loss and attenuator factor.

Offset = RF cable loss + attenuator factor.

The following shows an offset computation example with RF cable loss 7 dB and a 10dB attenuator.

Example :

$$\begin{aligned} \text{Offset(dB)} &= \text{RF cable loss(dB)} + \text{attenuator factor(dB)} \\ &= 7 + 10 = 17 \text{ (dB)} \end{aligned}$$

3 Test Result

3.1 Conducted Output Power Measurement

3.1.1 Description of the Conducted Output Power Measurement

A system simulator was used to establish communication with the EUT. Its parameters were set to enforce EUT transmitting at the maximum power. The measured power in the radio frequency on the transmitter output terminals shall be reported.

3.1.2 Measuring Instruments

The measuring equipment is listed in the section 4 of this test report.

3.1.3 Test Procedures

1. The transmitter output port was connected to the system simulator.
2. Set EUT at maximum power through system simulator.
3. Select lowest, middle, and highest channels for each band and different modulation.
4. Measure the maximum burst average power for GSM and maximum average power for other modulation signal.

3.1.4 Test Setup

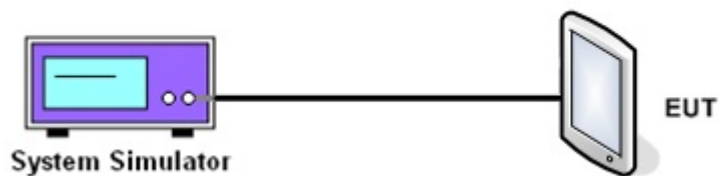



3.1.5 Test Result of Conducted Output Power

Cellular Band									
Modes	GSM850 (GPRS class 8)			GSM850 (EDGE class 8)			WCDMA Band V (RMC 12.2Kbps)		
Channel	128 (Low)	189 (Mid)	251 (High)	128 (Low)	189 (Mid)	251 (High)	4132 (Low)	4182 (Mid)	4233 (High)
Frequency (MHz)	824.2	836.4	848.8	824.2	836.4	848.8	826.4	836.4	846.6
Conducted Power (dBm)	31.97	32.10	32.06	26.72	26.73	26.67	23.09	23.22	23.21
Conducted Power (Watts)	1.57	1.62	1.61	0.47	0.47	0.46	0.20	0.21	0.21

PCS Band									
Modes	GSM1900 (GPRS class 8)			GSM1900 (EDGE class 8)			WCDMA Band II (RMC 12.2Kbps)		
Channel	512 (Low)	661 (Mid)	810 (High)	512 (Low)	661 (Mid)	810 (High)	9262 (Low)	9400 (Mid)	9538 (High)
Frequency (MHz)	1850.2	1880	1909.8	1850.2	1880	1909.8	1852.4	1880	1907.6
Conducted Power (dBm)	30.01	30.09	30.11	26.13	26.25	26.45	22.38	22.43	22.40
Conducted Power (Watts)	1.00	1.02	1.03	0.41	0.42	0.44	0.17	0.17	0.17



AWS Band			
Modes	WCDMA Band IV (RMC 12.2Kbps)		
Channel	1312(Low)	1413 (Mid)	1513 (High)
Frequency (MHz)	1712.4	1732.6	1752.6
Conducted Power (dBm)	23.01	23.13	23.22
Conducted Power (Watts)	0.20	0.21	0.21

Note: maximum burst average power for GSM, and maximum average power for WCDMA.

3.2 Peak-to-Average Ratio

3.2.1 Description of the PAR Measurement

The peak-to-average ratio (PAR) of the transmission may not exceed 13 dB.

3.2.2 Measuring Instruments

The measuring equipment is listed in the section 4 of this test report.

3.2.3 Test Procedures

1. The testing follows FCC KDB 971168 v02r01 Section 5.7.1.
2. The EUT was connected to the spectrum analyzer and system simulator via a power divider.
3. For GSM/EGPRS operating modes:
 - a. Set EUT in maximum power output.
 - b. Set the RBW = 1MHz, VBW = 3MHz, Peak detector on spectrum analyzer for first trace.
 - c. Set the RBW = 1MHz, VBW = 3MHz, RMS detector on spectrum analyzer for second trace.
 - d. The wanted burst signal is triggered by spectrum analyzer, and measured respectively the peak level and Mean level without burst-off time, after system simulator has synchronized with the spectrum analyzer.
4. For UMTS operating modes:
 - a. Set the CCDF (Complementary Cumulative Distribution Function) option on the spectrum analyzer.
 - b. The highest RF powers were measured and recorded the maximum PAPR level associated with a probability of 0.1 %.
5. Record the deviation as Peak to Average Ratio.

3.2.4 Test Setup

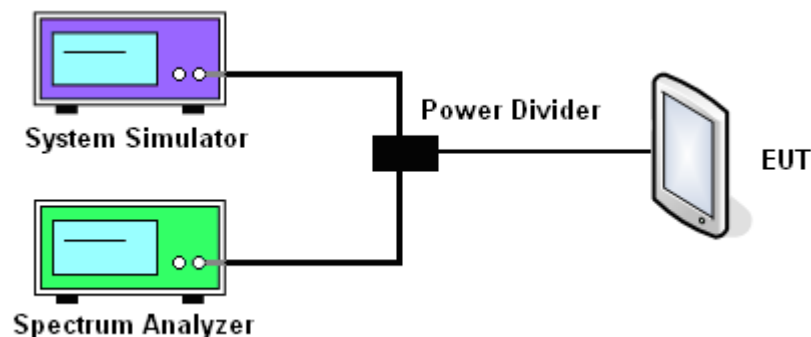

3.2.5 Test Result of Peak-to-Average Ratio

Cellular Band									
Modes	GSM850 (GPRS class 8)			GSM850 (EDGE class 8)			WCDMA Band V (RMC 12.2Kbps)		
Channel	128 (Low)	189 (Mid)	251 (High)	128 (Low)	189 (Mid)	251 (High)	4132 (Low)	4182 (Mid)	4233 (High)
Frequency (MHz)	824.2	836.4	848.8	824.2	836.4	848.8	826.4	836.4	846.6
Peak-to-Average Ratio (dB)	0.49	0.47	0.45	2.63	2.70	2.67	3.10	3.36	3.16

PCS Band									
Modes	GSM1900 (GPRS class 8)			GSM1900 (EDGE class 8)			WCDMA Band II (RMC 12.2Kbps)		
Channel	512 (Low)	661 (Mid)	810 (High)	512 (Low)	661 (Mid)	810 (High)	9262 (Low)	9400 (Mid)	9538 (High)
Frequency (MHz)	1850.2	1880	1909.8	1850.2	1880	1909.8	1852.4	1880	1907.6
Peak-to-Average Ratio (dB)	0.34	0.32	0.33	2.44	2.30	2.48	3.10	2.72	2.55

AWS Band			
Modes	WCDMA Band IV (RMC 12.2Kbps)		
Channel	1312(Low)	1413 (Mid)	1513 (High)
Frequency (MHz)	1712.4	1732.6	1752.6
Peak-to-Average Ratio (dB)	2.49	3.04	2.61



3.2.6 Test Result (Plots) of Peak-to-Average Ratio

Band :	GSM 850	Test Mode :	GPRS class 8 Link (GMSK)
--------	---------	-------------	--------------------------

Peak-to-Average Ratio on Channel 128 (824.2 MHz)

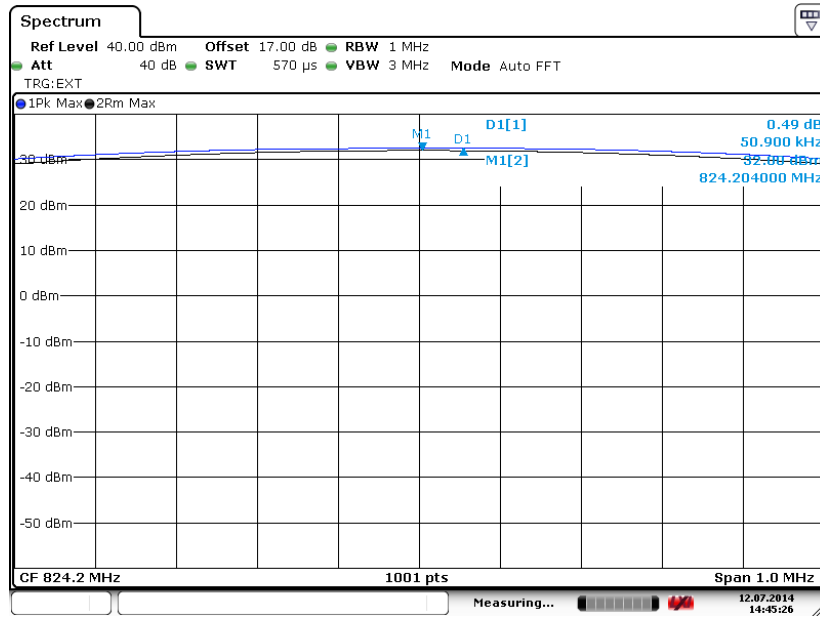

Date: 12.JUL.2014 14:45:27

Peak-to-Average Ratio on Channel 189 (836.4 MHz)

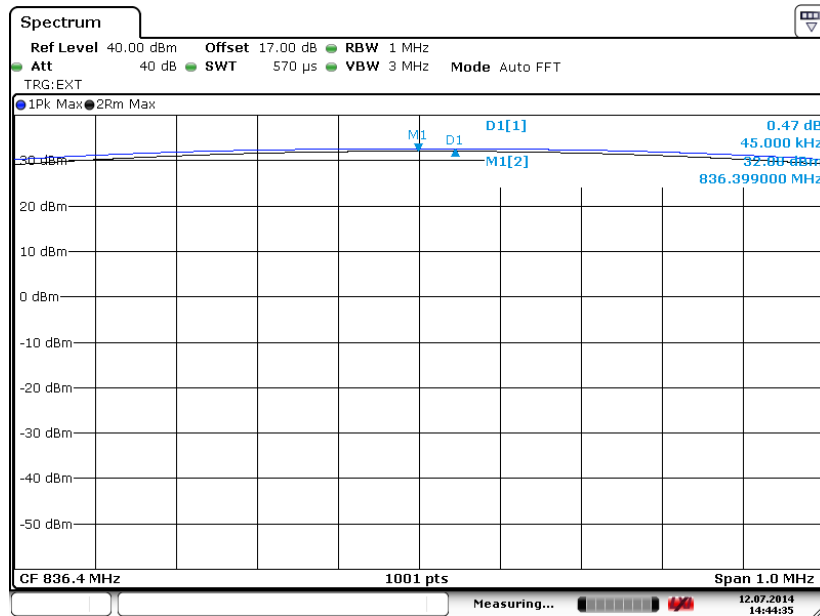

Date: 12.JUL.2014 14:44:35



Peak-to-Average Ratio on Channel 251 (848.8 MHz)

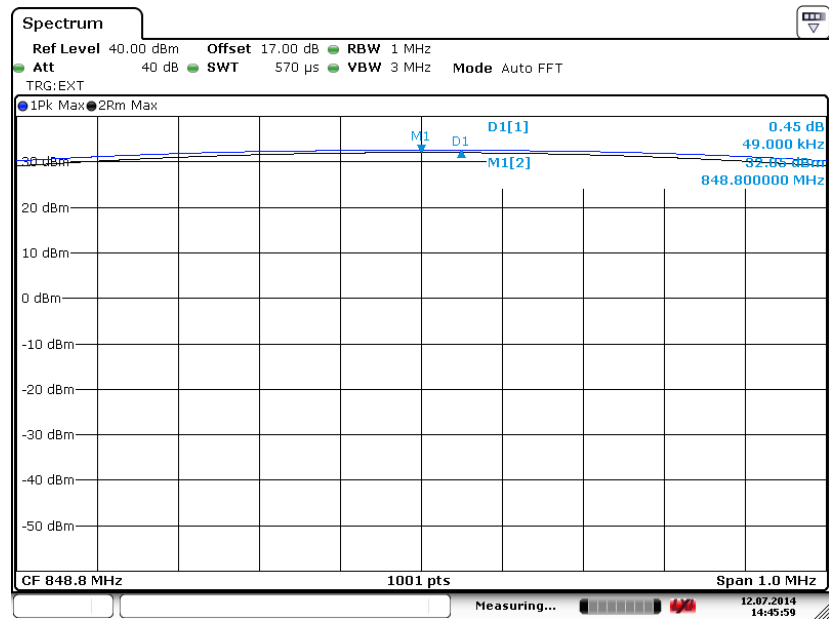

Date: 12.JUL.2014 14:45:59



Band :	GSM 850	Test Mode :	EDGE class 8 Link (8PSK)
---------------	---------	--------------------	--------------------------

Peak-to-Average Ratio on Channel 128 (824.2 MHz)

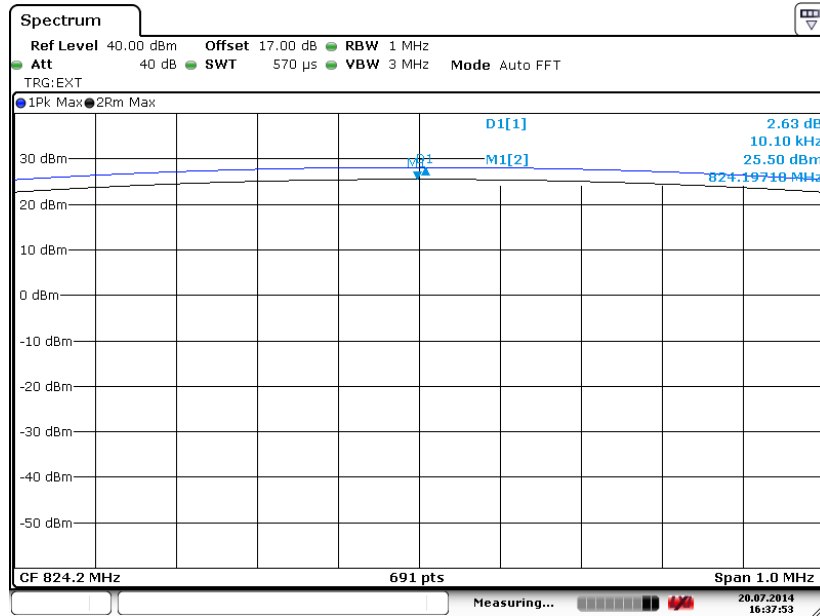

Date: 20.JUL.2014 16:37:53

Peak-to-Average Ratio on Channel 189 (836.4 MHz)

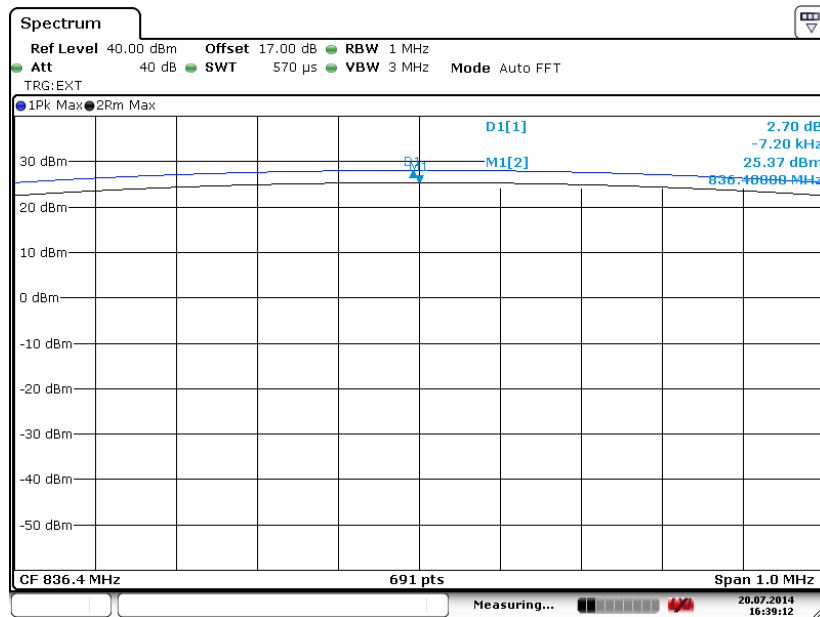

Date: 20.JUL.2014 16:39:12



Peak-to-Average Ratio on Channel 251 (848.8 MHz)

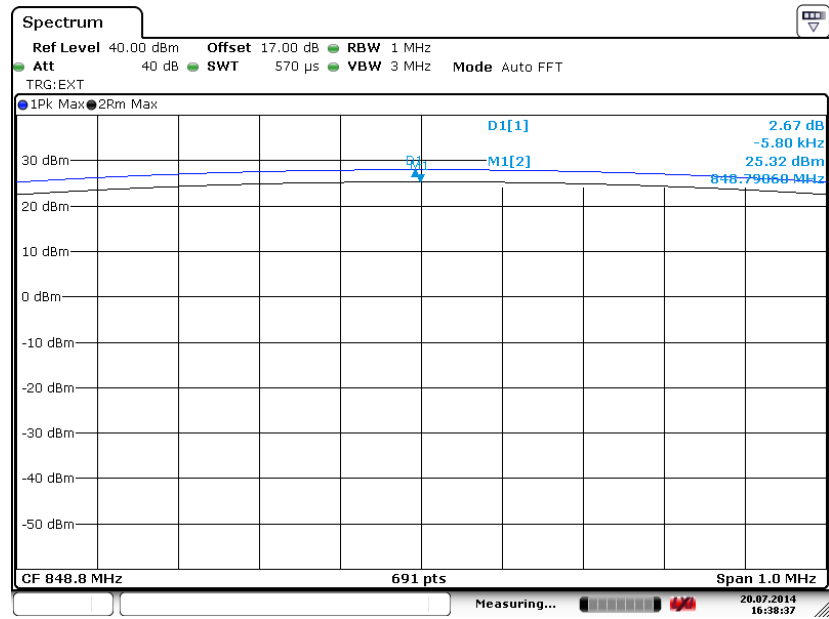

Date: 20.JUL.2014 16:38:37



Band :	GSM 1900	Test Mode :	GPRS class 8 Link (GMSK)
---------------	----------	--------------------	--------------------------

Peak-to-Average Ratio on Channel 512 (1850.2 MHz)

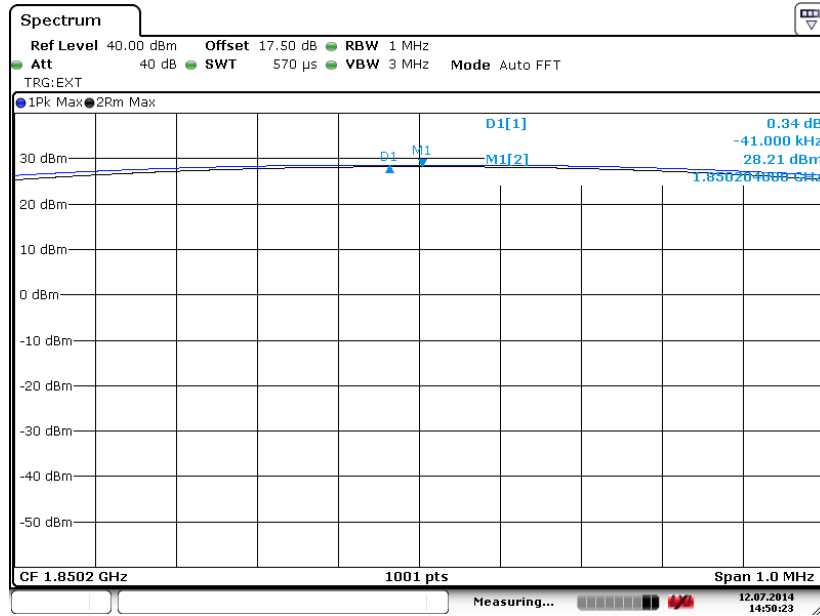

Date: 12.JUL.2014 14:50:23

Peak-to-Average Ratio on Channel 661 (1880.0 MHz)

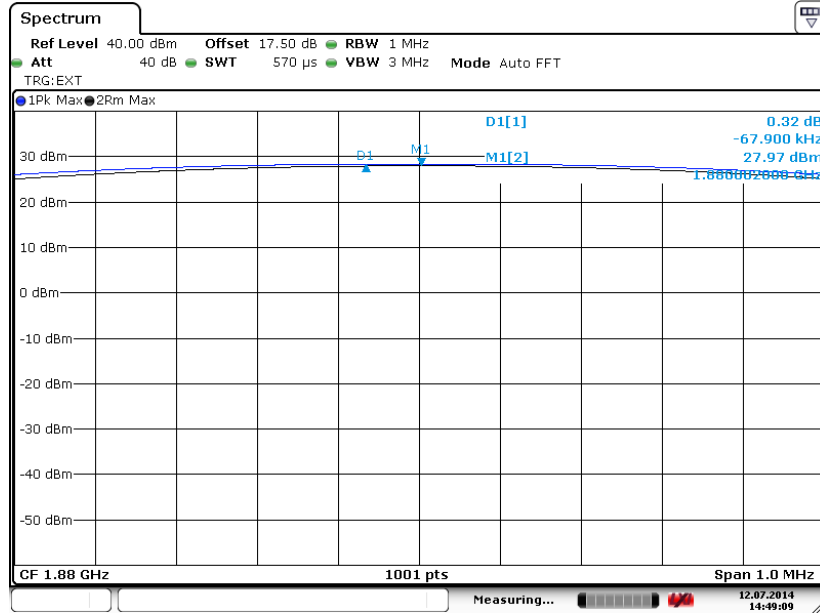

Date: 12.JUL.2014 14:49:09



Peak-to-Average Ratio on Channel 810 (1909.8 MHz)

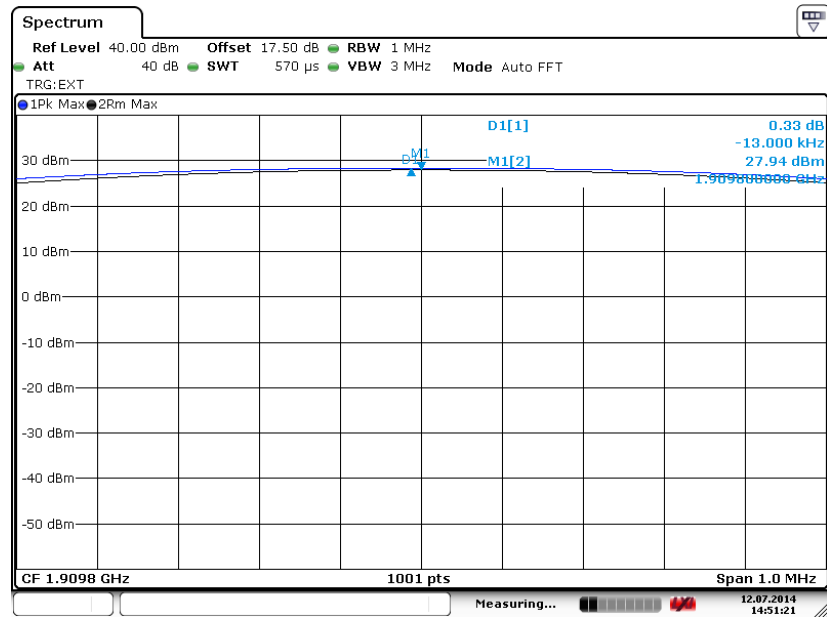

Date: 12.JUL.2014 14:51:21



Band :	GSM 1900	Test Mode :	EDGE class 8 Link (8PSK)
---------------	----------	--------------------	--------------------------

Peak-to-Average Ratio on Channel 512 (1850.2 MHz)

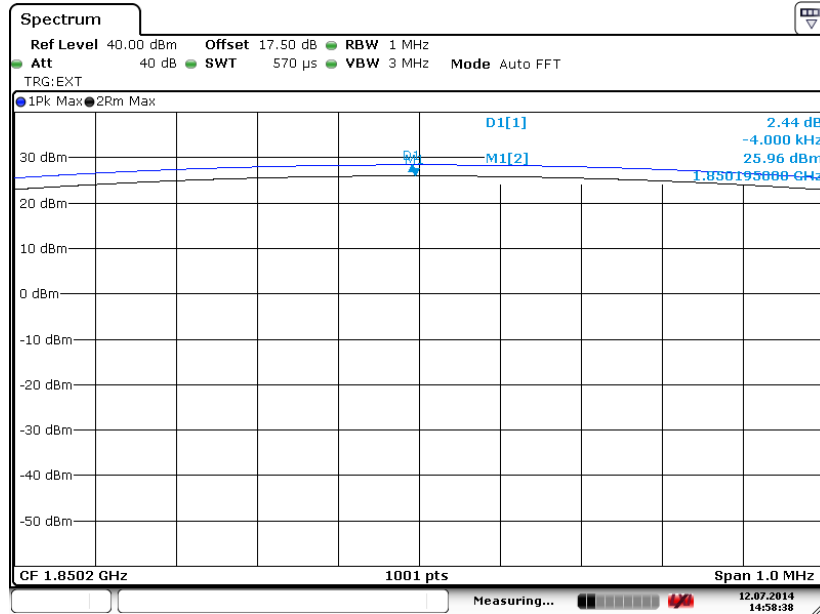

Date: 12.JUL.2014 14:58:38

Peak-to-Average Ratio on Channel 661 (1880.0 MHz)

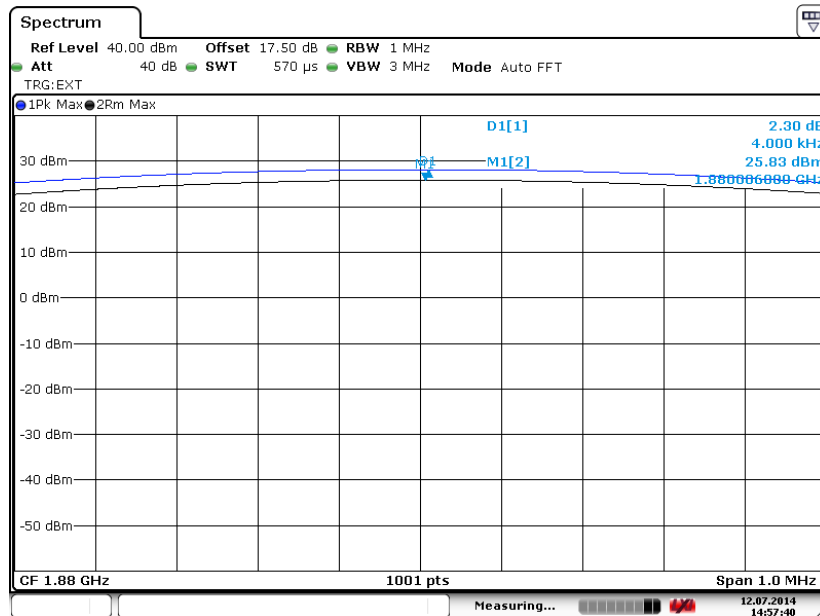

Date: 12.JUL.2014 14:57:40



Peak-to-Average Ratio on Channel 810 (1909.8 MHz)

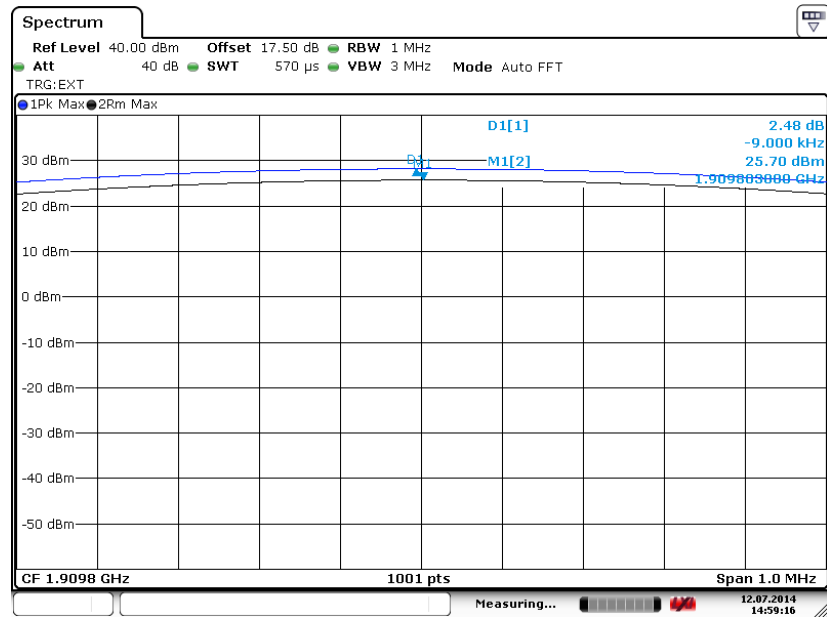

Date: 12.JUL.2014 14:59:16



Band :	WCDMA Band V	Test Mode :	RMC 12.2Kbps Link (QPSK)
---------------	--------------	--------------------	--------------------------

Peak-to-Average Ratio on Channel 4132 (826.4 MHz)

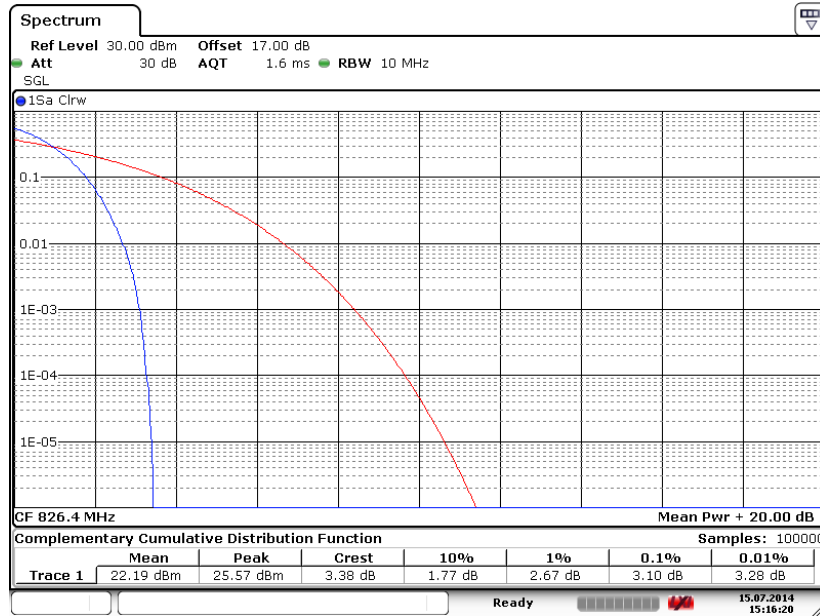

Date: 15.JUL.2014 15:16:20

Peak-to-Average Ratio on Channel 4182 (836.4 MHz)

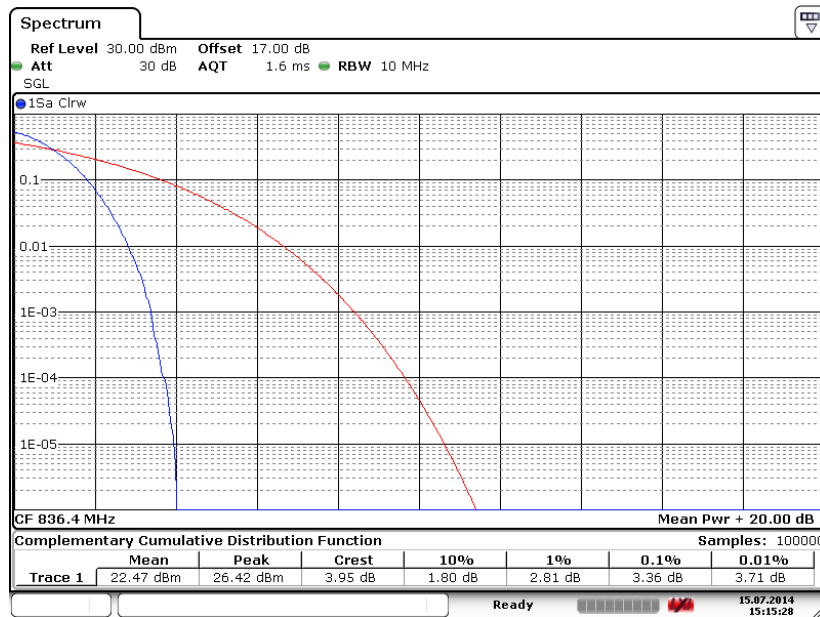

Date: 15.JUL.2014 15:15:28



Peak-to-Average Ratio on Channel 4233 (846.6 MHz)

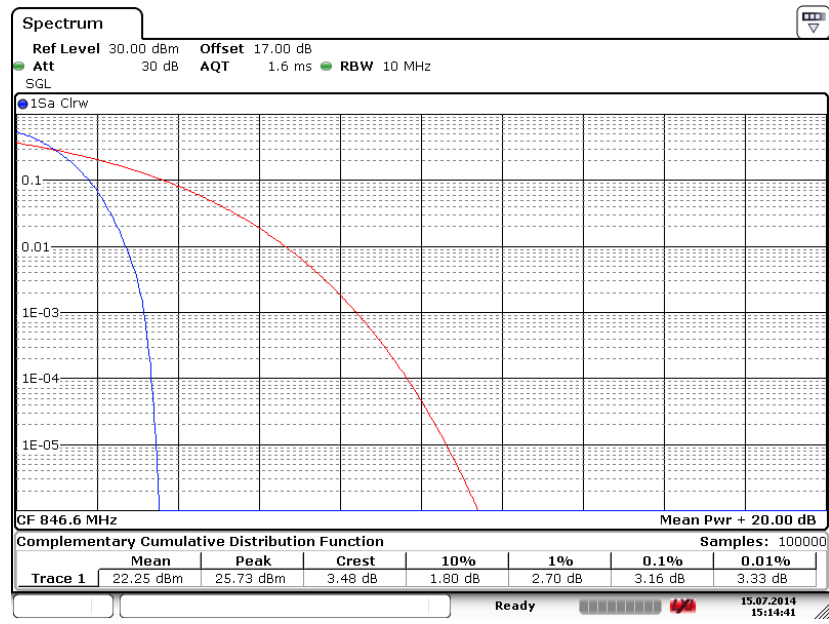

Date: 15.JUL.2014 15:14:41



Band :	WCDMA Band IV	Test Mode :	RMC 12.2Kbps Link (QPSK)
---------------	---------------	--------------------	--------------------------

Peak-to-Average Ratio on Channel 1312 (1712.4 MHz)

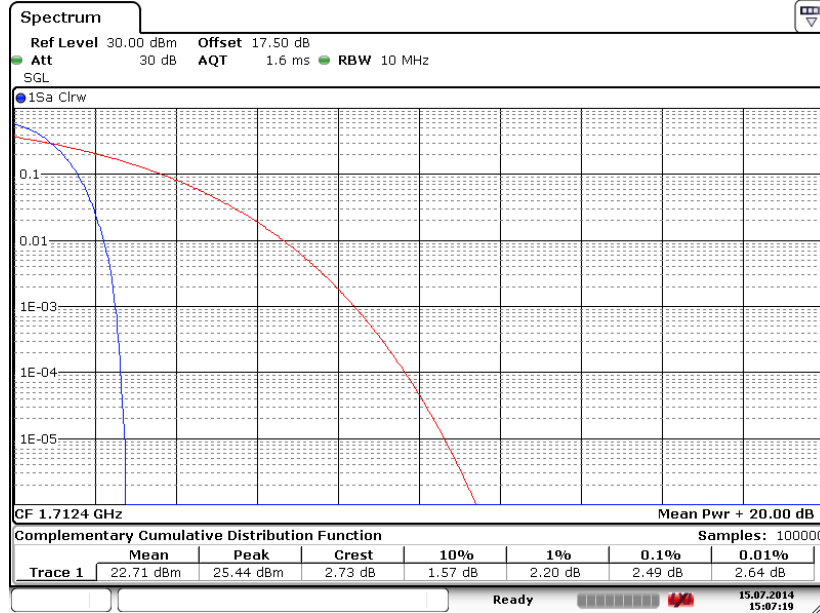

Date: 15.JUL.2014 15:07:20

Peak-to-Average Ratio on Channel 1413 (1732.6 MHz)

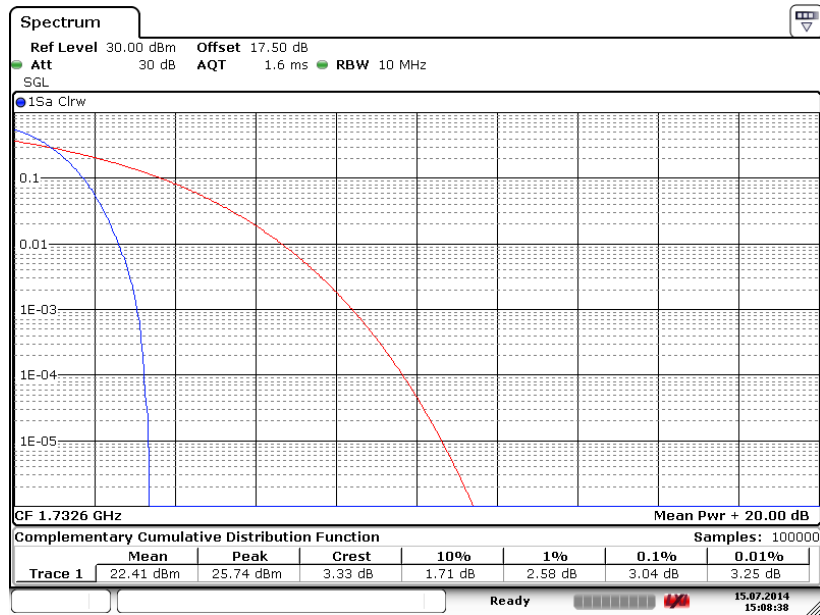

Date: 15.JUL.2014 15:08:38



Peak-to-Average Ratio on Channel 1513 (1752.6 MHz)

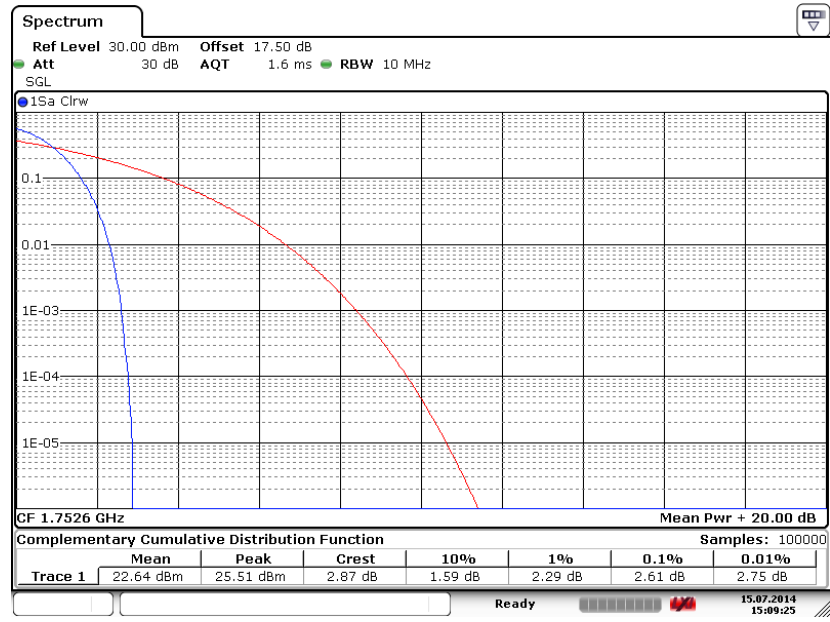

Date: 15.JUL.2014 15:09:26



Band :	WCDMA Band II	Test Mode :	RMC 12.2Kbps Link (QPSK)
---------------	---------------	--------------------	--------------------------

Peak-to-Average Ratio on Channel 9262 (1852.4 MHz)

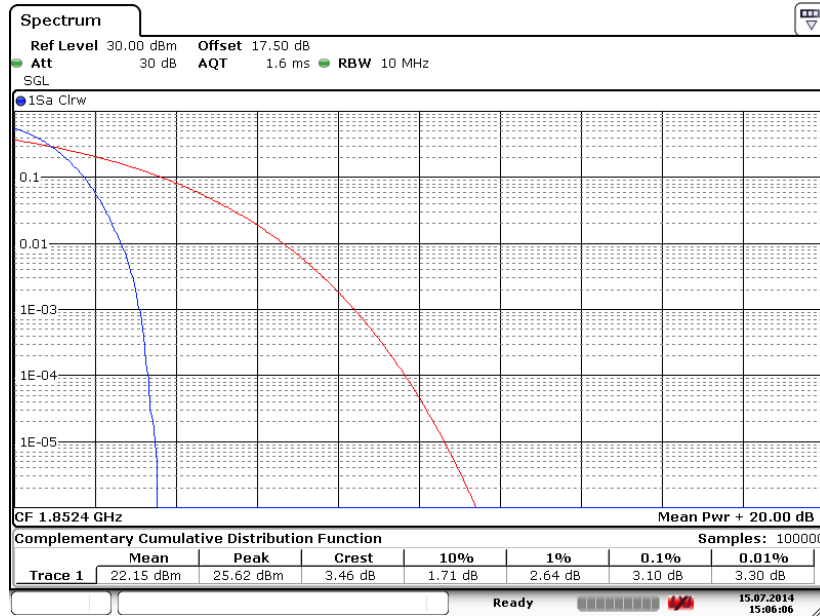

Date: 15.JUL.2014 15:06:06

Peak-to-Average Ratio on Channel 9400 (1880.0 MHz)

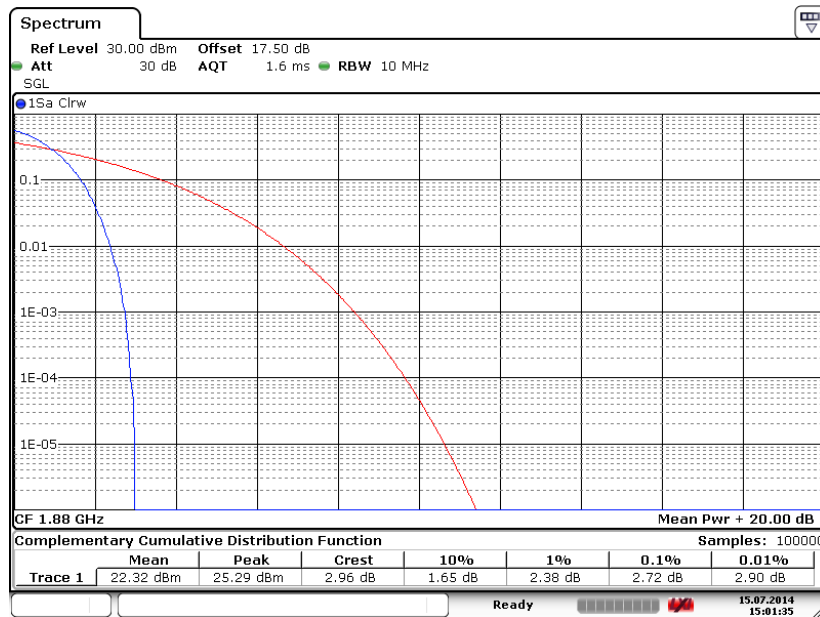

Date: 15.JUL.2014 15:01:35



Peak-to-Average Ratio on Channel 9538 (1907.6 MHz)

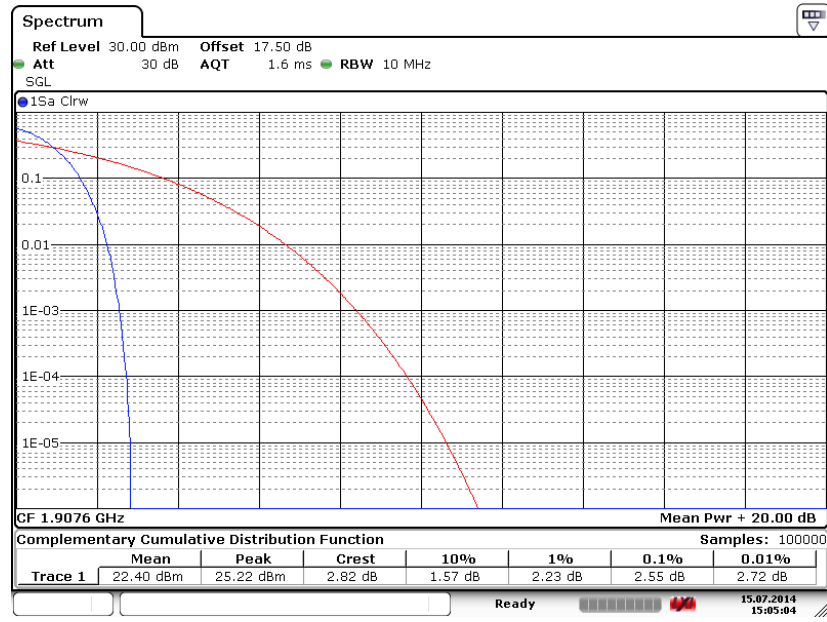

Date: 15.JUL.2014 15:05:04



3.3 Effective Radiated Power and Effective Isotropic Radiated Power Measurement

3.3.1 Description of the ERP/EIRP Measurement

The substitution method, in ANSI / TIA / EIA-603-C-2004, was used for ERP/EIRP measurement, and the spectrum analyzer configuration follows KDB 971168 D01 Power Meas. License Digital Systems v02r01. The ERP of mobile transmitters must not exceed 7 Watts (Cellular Band) and the EIRP of mobile transmitters are limited to 2 Watts (PCS Band) and 1 Watts (AWS Band).

3.3.2 Measuring Instruments

The measuring equipment is listed in the section 4 of this test report.

3.3.3 Test Procedures

1. The EUT was placed on a non-conductive rotating platform 0.8 meters high in a semi-anechoic chamber. The radiated emission at the fundamental frequency was measured at 3 m with a test antenna and a spectrum analyzer with RMS detector per section 5. of KDB 971168 D01.
2. During the measurement, the system simulator parameters were set to force the EUT transmitting at maximum output power. The maximum emission was recorded from analyzer power level (LVL) from the 360 degrees rotation of the turntable and the test antenna raised and lowered over a range from 1 to 4 meters in both horizontally and vertically polarized orientations.
3. Effective Isotropic Radiated Power (EIRP) was measured by substitution method according to TIA/EIA-603-C. The EUT was replaced by dipole antenna (substitution antenna) at the same location, and then a known power from S.G. was applied into the dipole antenna through a Tx cable, and then recorded the maximum Analyzer reading through raised and lowered the test antenna. The correction factor (in dB) = S.G. - Tx Cable loss + Substitution antenna gain - Analyzer reading. Then the EUT's EIRP was calculated with the correction factor, $EIRP = LVL + \text{Correction factor}$ and $ERP = EIRP - 2.15$.

3.3.4 Test Setup

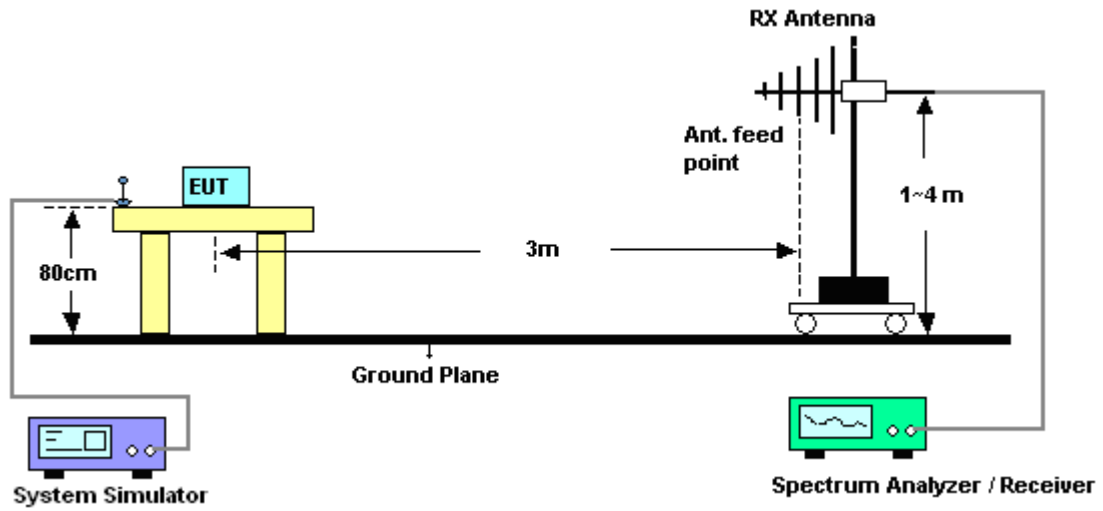

3.3.5 Test Result of ERP

GSM850 (GPRS class 8) Radiated Power ERP				
Horizontal Polarization				
Frequency (MHz)	LVL (dBm)	Correction Factor (dB)	ERP (dBm)	ERP (W)
824.2	1.18	29.11	28.14	0.65
836.4	1.06	29.2	28.11	0.65
848.8	0.54	29.4	27.79	0.60
Vertical Polarization				
Frequency (MHz)	LVL (dBm)	Correction Factor (dB)	ERP (dBm)	ERP (W)
824.2	-2.18	33.23	28.90	0.78
836.4	-1.52	33.00	29.33	0.86
848.8	-1.56	32.95	29.24	0.84

* ERP = LVL (dBm) + Correction Factor (dB) – 2.15

GSM850 (EDGE class 8) Radiated Power ERP				
Horizontal Polarization				
Frequency (MHz)	LVL (dBm)	Correction Factor (dB)	ERP (dBm)	ERP (W)
824.2	-5.35	29.11	21.61	0.14
836.4	-4.98	29.2	22.07	0.16
848.8	-4.79	29.4	22.46	0.18
Vertical Polarization				
Frequency (MHz)	LVL (dBm)	Correction Factor (dB)	ERP (dBm)	ERP (W)
824.2	-8.33	33.23	22.75	0.19
836.4	-7.95	33	22.90	0.20
848.8	-7.49	32.95	23.31	0.21

* ERP = LVL (dBm) + Correction Factor (dB) – 2.15



WCDMA Band V (RMC 12.2Kbps) Radiated Power ERP				
Horizontal Polarization				
Frequency (MHz)	LVL (dBm)	Correction Factor (dB)	ERP (dBm)	ERP (W)
826.4	-7.51	29.11	19.45	0.09
836.4	-7.48	29.2	19.57	0.09
846.6	-7.64	29.4	19.61	0.09
Vertical Polarization				
Frequency (MHz)	LVL (dBm)	Correction Factor (dB)	ERP (dBm)	ERP (W)
826.4	-10.83	33.23	20.25	0.11
836.4	-10.49	33	20.36	0.11
846.6	-10.23	32.95	20.57	0.11

* ERP = LVL (dBm) + Correction Factor (dB) – 2.15



3.3.6 Test Result of EIRP

GSM1900 (GPRS class 8) Radiated Power EIRP				
Horizontal Polarization				
Frequency (MHz)	LVL (dBm)	Correction Factor (dB)	EIRP (dBm)	EIRP (W)
1850.2	-15.47	42.76	27.29	0.54
1880.0	-15.36	42.32	26.96	0.50
1909.8	-14.73	41.95	27.22	0.53
Vertical Polarization				
Frequency (MHz)	LVL (dBm)	Correction Factor (dB)	EIRP (dBm)	EIRP (W)
1850.2	-10.68	42.13	31.45	1.40
1880.0	-11.83	42.79	30.96	1.25
1909.8	-12.38	42.83	30.45	1.11

* EIRP = LVL (dBm) + Correction Factor (dB)

GSM1900 (EDGE class 8) Radiated Power EIRP				
Horizontal Polarization				
Frequency (MHz)	LVL (dBm)	Correction Factor (dB)	EIRP (dBm)	EIRP (W)
1850.2	-18.54	42.76	24.22	0.26
1880.0	-17.93	42.32	24.39	0.28
1909.8	-17.17	41.95	24.78	0.30
Vertical Polarization				
Frequency (MHz)	LVL (dBm)	Correction Factor (dB)	EIRP (dBm)	EIRP (W)
1850.2	-14.24	42.13	27.89	0.62
1880.0	-15.25	42.79	27.55	0.57
1909.8	-16.08	42.83	26.75	0.47

* EIRP = LVL (dBm) + Correction Factor (dB)



WCDMA Band IV (RMC 12.2Kbps) Radiated Power EIRP				
Horizontal Polarization				
Frequency (MHz)	LVL (dBm)	Correction Factor (dB)	EIRP (dBm)	EIRP (W)
1712.40	-16.75	39.98	23.23	0.21
1732.60	-17.09	40.73	23.64	0.23
1752.60	-17.25	40.83	23.58	0.23
Vertical Polarization				
Frequency (MHz)	LVL (dBm)	Correction Factor (dB)	EIRP (dBm)	EIRP (W)
1712.40	-15.58	41.22	25.64	0.37
1732.60	-15.53	41.41	25.88	0.39
1752.60	-15.90	41.68	25.78	0.38

* EIRP = LVL (dBm) + Correction Factor (dB)

WCDMA Band II (RMC 12.2Kbps) Radiated Power EIRP				
Horizontal Polarization				
Frequency (MHz)	LVL (dBm)	Correction Factor (dB)	EIRP (dBm)	EIRP (W)
1852.4	-22.29	42.76	20.47	0.11
1880.0	-22.43	42.32	19.89	0.10
1907.6	-21.82	41.95	20.13	0.10
Vertical Polarization				
Frequency (MHz)	LVL (dBm)	Correction Factor (dB)	EIRP (dBm)	EIRP (W)
1852.4	-17.76	42.13	24.37	0.27
1880.0	-18.75	42.79	24.04	0.25
1907.6	-19.46	42.83	23.37	0.22

* EIRP = LVL (dBm) + Correction Factor (dB)

3.4 99% Occupied Bandwidth and 26dB Bandwidth Measurement

3.4.1 Description of 99% Occupied Bandwidth and 26dB Bandwidth Measurement

The 99% occupied bandwidth is the width of a frequency band such that, below the lower and above the upper frequency limits, the mean powers emitted are each equal to a specified percentage 0.5% of the total mean transmitted power.

The emission bandwidth is defined as the width of the signal between two points, located at the 2 sides of the carrier frequency, outside of which all emissions are attenuated at least 26 dB below the transmitter power.

3.4.2 Measuring Instruments

The measuring equipment is listed in the section 4 of this test report.

3.4.3 Test Procedures

1. The testing follows FCC KDB 971168 v02r01 Section 4.2.
2. The EUT was connected to the spectrum analyzer and system simulator via a power divider.
3. The RF output of the EUT was connected to the spectrum analyzer by RF cable and attenuator. The path loss was compensated to the results for each measurement.
4. The 99% occupied bandwidth were measured, set RBW= 1% of span, VBW= 3*RBW, sample detector, trace maximum hold.
5. The 26dB bandwidth were measured, set RBW= 1% of EBW, VBW= 3*RBW, peak detector, trace maximum hold.

3.4.4 Test Setup

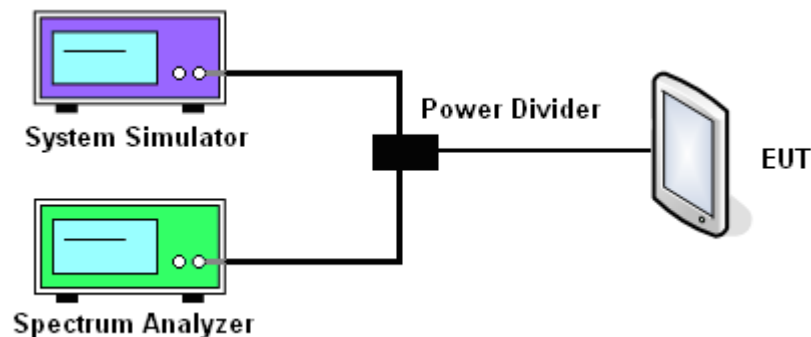



3.4.5 Test Result of Occupied Bandwidth and 26dB Bandwidth

Cellular Band						
Modes	GSM850 (GPRS class 8)			GSM850 (EDGE class 8)		
Channel	128 (Low)	189 (Mid)	251 (High)	128 (Low)	189 (Mid)	251 (High)
Frequency (MHz)	824.2	836.4	848.8	824.2	836.4	848.8
99% OBW (kHz)	247.75	244.76	246.75	244.57	247.47	244.57
26dB BW (kHz)	307.70	306.70	303.70	302.50	301.00	299.60

PCS Band						
Modes	GSM1900 (GPRS class 8)			GSM1900 (EDGE class 8)		
Channel	512 (Low)	661 (Mid)	810 (High)	512 (Low)	661 (Mid)	810 (High)
Frequency (MHz)	1850.2	1880	1909.8	1850.2	1880	1909.8
99% OBW (kHz)	246.02	246.02	246.02	248.91	250.36	247.47
26dB BW (kHz)	309.70	305.40	305.40	314.00	314.00	316.90

Cellular Band			
Modes	WCDMA Band V (RMC 12.2Kbps)		
Channel	4132 (Low)	4182 (Mid)	4233 (High)
Frequency (MHz)	826.4	836.4	846.6
99% OBW (MHz)	4.08	4.07	4.07
26dB BW (MHz)	4.63	4.63	4.63

AWS Band			
Modes	WCDMA Band IV (RMC 12.2Kbps)		
Channel	1312(Low)	1413 (Mid)	1513 (High)
Frequency (MHz)	1712.4	1732.6	1752.6
99% OBW (MHz)	4.08	4.07	4.08
26dB BW (MHz)	4.66	4.65	4.65



PCS Band			
Modes	WCDMA Band II (RMC 12.2Kbps)		
Channel	9262 (Low)	9400 (Mid)	9538 (High)
Frequency (MHz)	1852.4	1880	1907.6
99% OBW (MHz)	4.08	4.07	4.10
26dB BW (MHz)	4.65	4.65	4.69



3.4.6 Test Result (Plots) of Occupied Bandwidth and 26dB Bandwidth

Band :	GSM 850	Test Mode :	GPRS class 8 Link (GMSK)
--------	---------	-------------	--------------------------

99% Occupied Bandwidth Plot on Channel 128 (824.2 MHz)

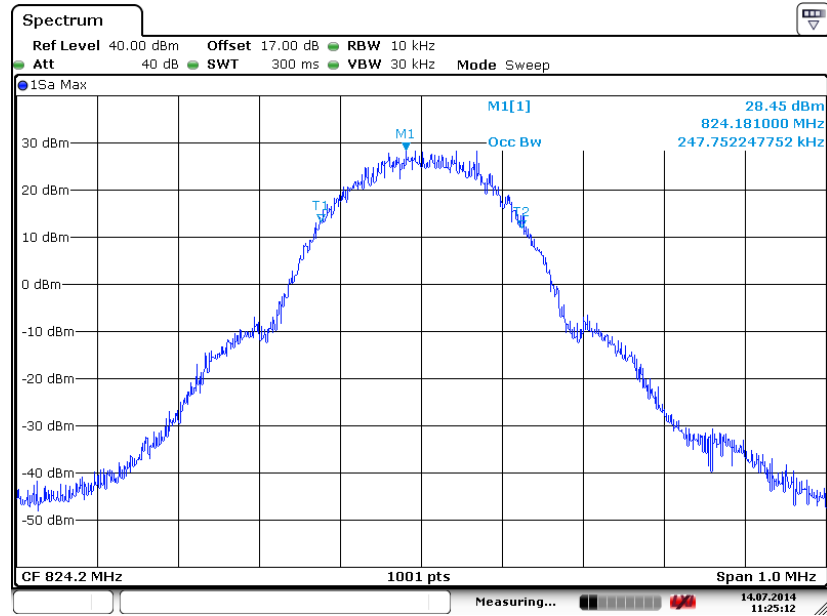

Date: 14.JUL.2014 11:25:13

26dB Bandwidth Plot on Channel 128 (824.2 MHz)

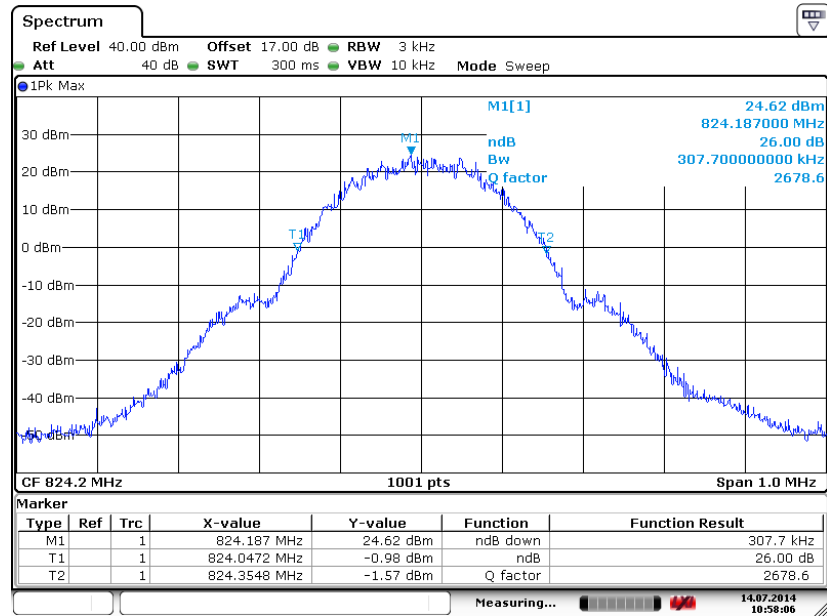

Date: 14.JUL.2014 10:58:06



99% Occupied Bandwidth Plot on Channel 189 (836.4 MHz)

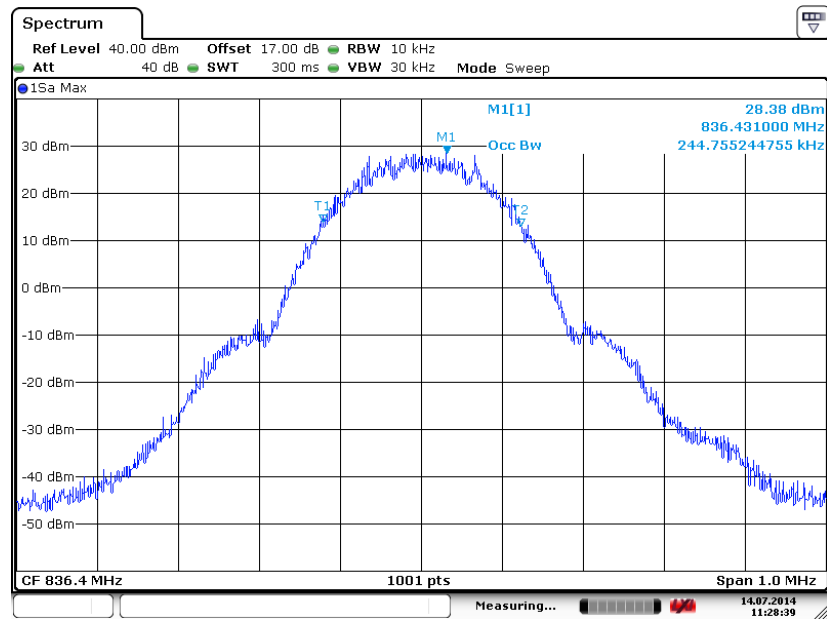

Date: 14.JUL.2014 11:28:40

26dB Bandwidth Plot on Channel 189 (836.4 MHz)

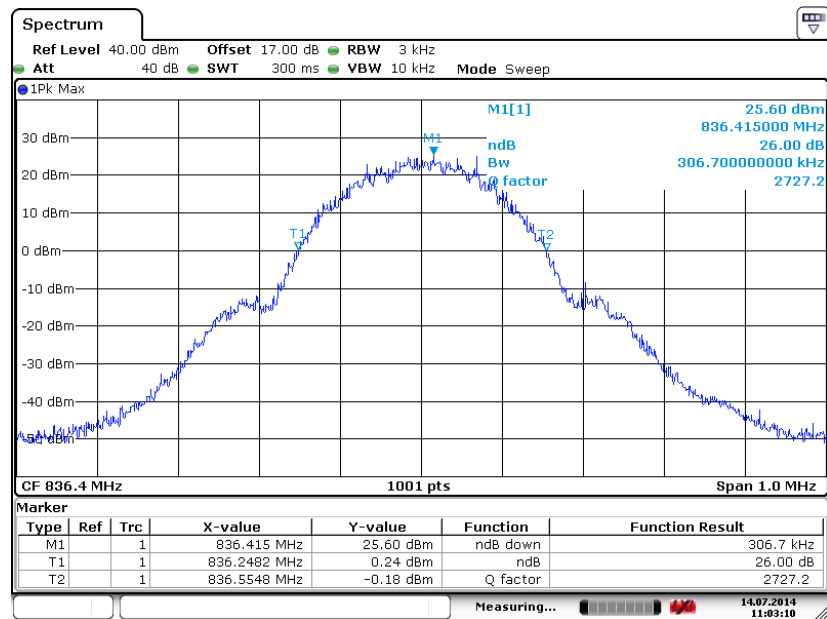

Date: 14.JUL.2014 11:03:10



99% Occupied Bandwidth Plot on Channel 251 (848.8 MHz)

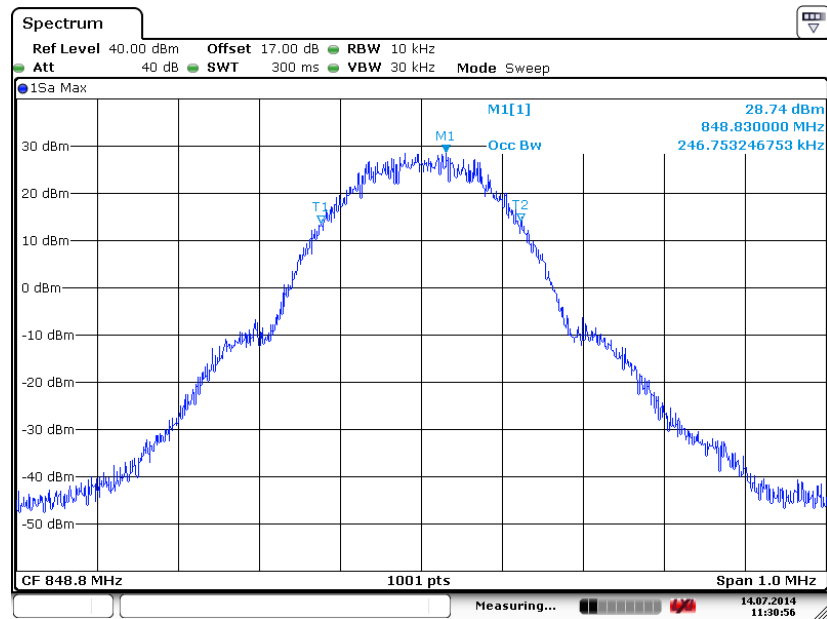

Date: 14.JUL.2014 11:30:56

26dB Bandwidth Plot on Channel 251 (848.8 MHz)

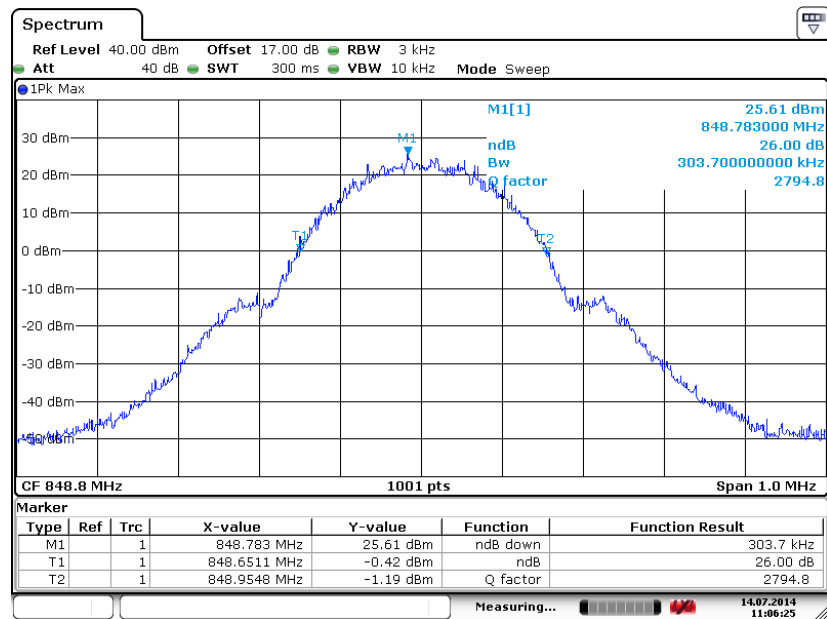

Date: 14.JUL.2014 11:06:25



Band :	GSM 850	Test Mode :	EDGE class 8 Link (8PSK)
---------------	---------	--------------------	--------------------------

99% Occupied Bandwidth Plot on Channel 128 (824.2 MHz)

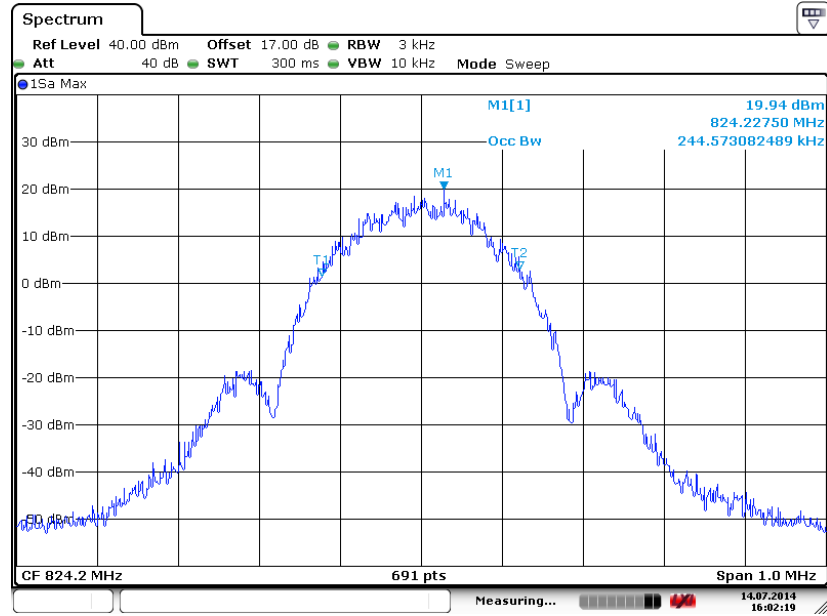

Date: 14.JUL.2014 16:02:19

26dB Bandwidth Plot on Channel 128 (824.2 MHz)

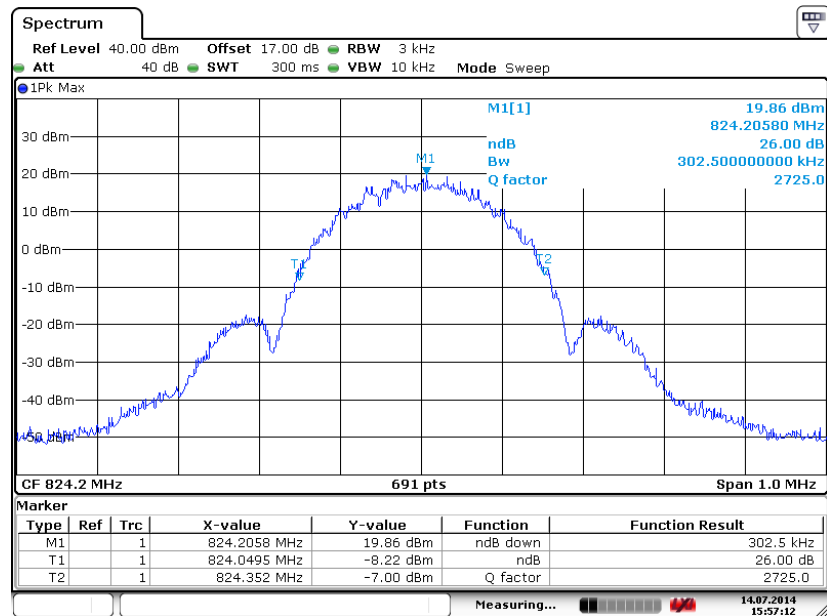

Date: 14.JUL.2014 15:57:12



99% Occupied Bandwidth Plot on Channel 189 (836.4 MHz)

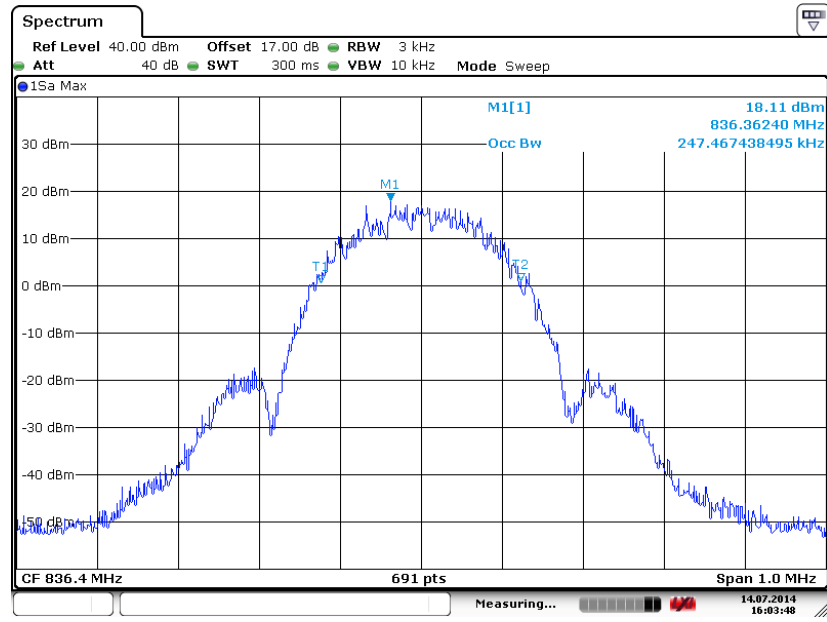

Date: 14.JUL.2014 16:03:48

26dB Bandwidth Plot on Channel 189 (836.4 MHz)

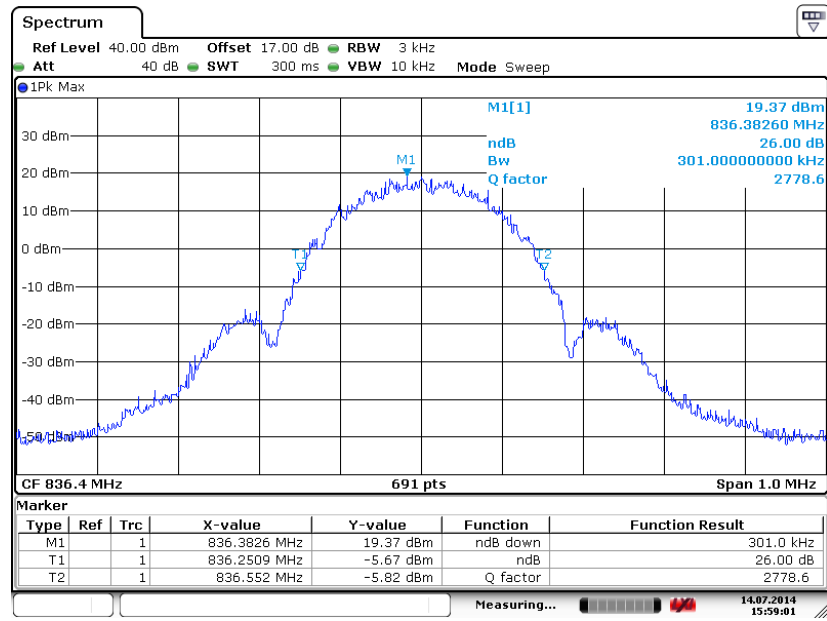

Date: 14.JUL.2014 15:59:02



99% Occupied Bandwidth Plot on Channel 251 (848.8 MHz)

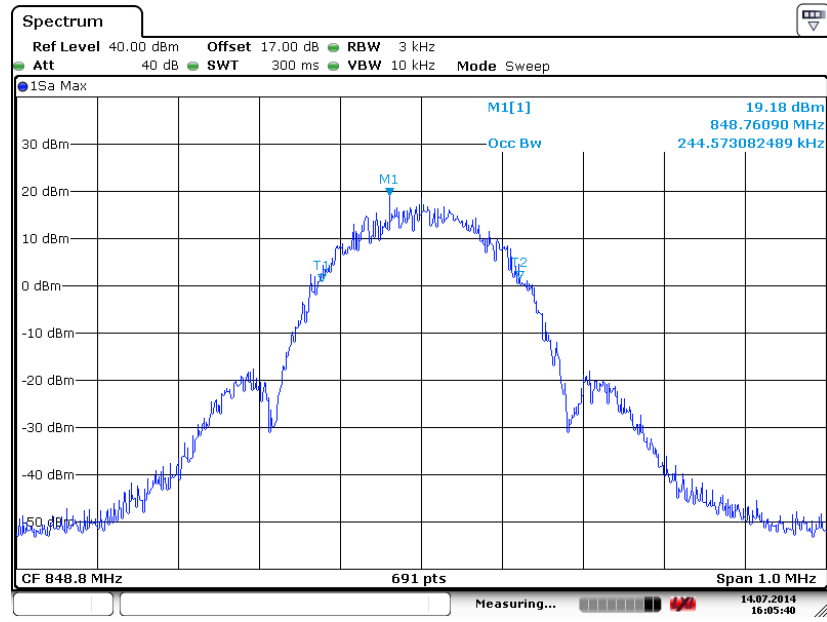

Date: 14.JUL.2014 16:05:40

26dB Bandwidth Plot on Channel 251 (848.8 MHz)

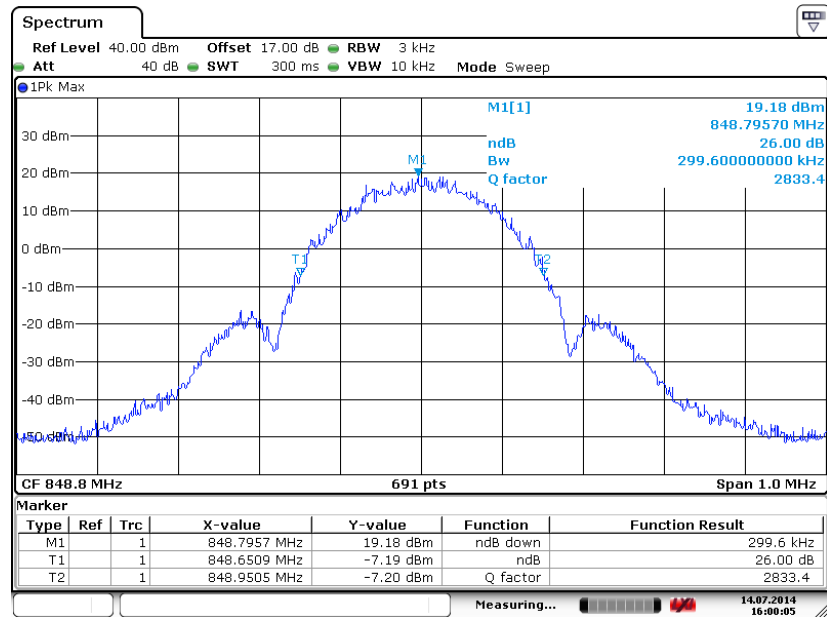

Date: 14.JUL.2014 16:00:05



Band :	GSM 1900	Test Mode :	GPRS class 8 Link (GMSK)
---------------	----------	--------------------	--------------------------

99% Occupied Bandwidth Plot on Channel 512 (1850.2 MHz)

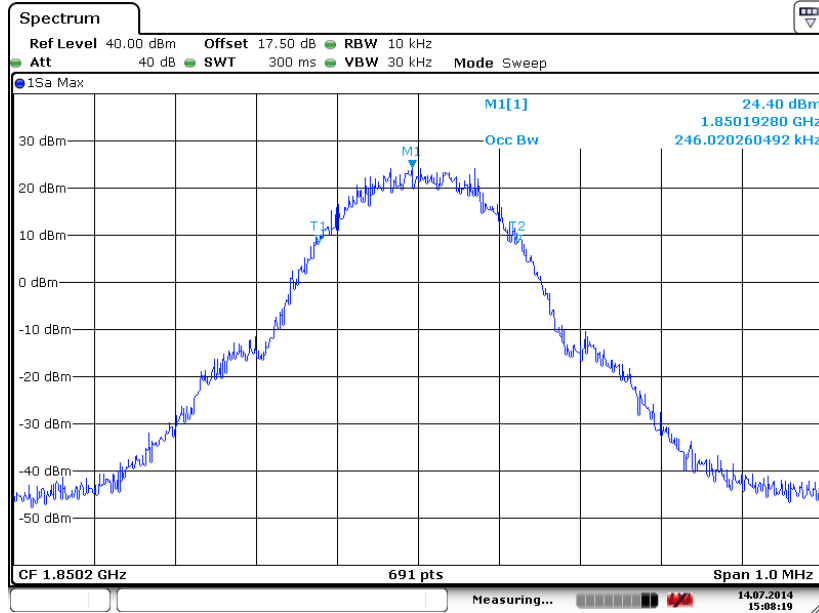

Date: 14.JUL.2014 15:08:19

26dB Bandwidth Plot on Channel 512 (1850.2 MHz)

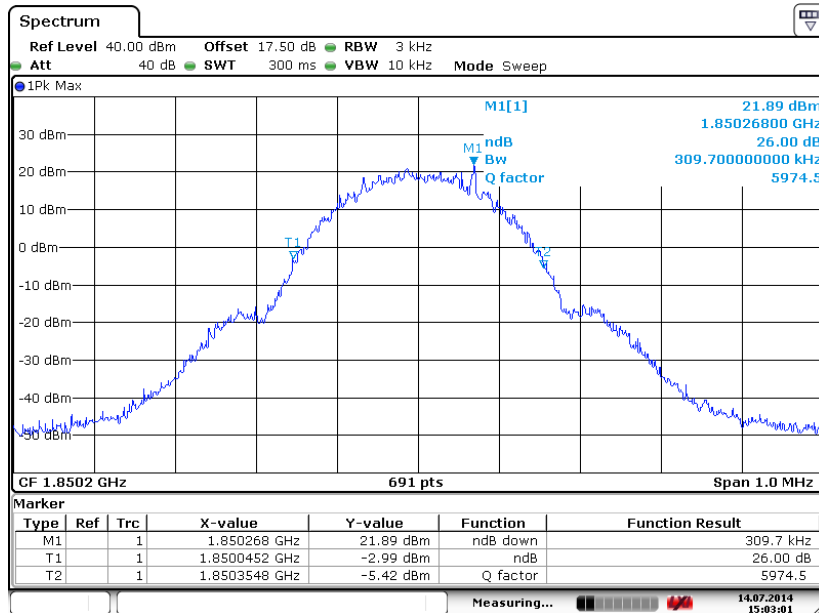

Date: 14.JUL.2014 15:03:01



99% Occupied Bandwidth Plot on Channel 661 (1880.0 MHz)

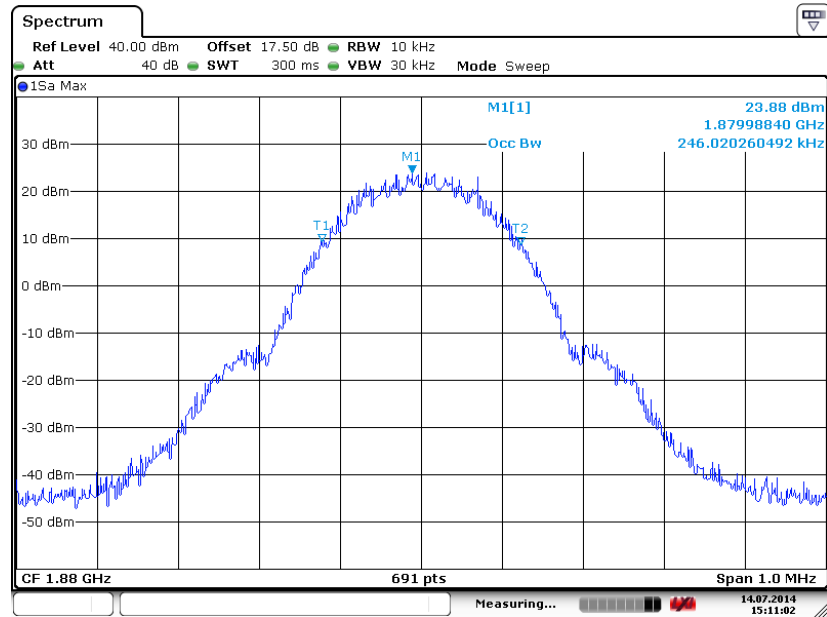

Date: 14.JUL.2014 15:11:03

26dB Bandwidth Plot on Channel 661 (1880.0 MHz)

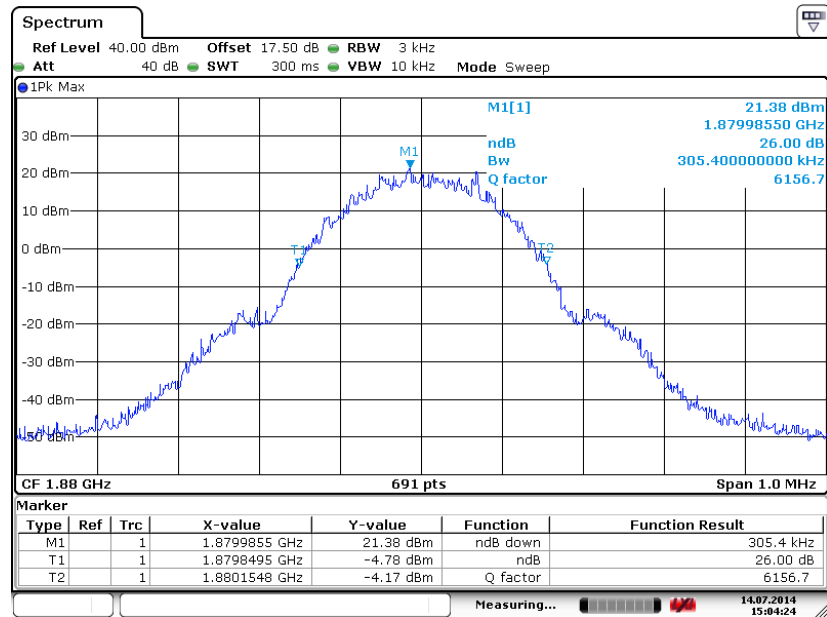

Date: 14.JUL.2014 15:04:24



99% Occupied Bandwidth Plot on Channel 810 (1909.8 MHz)

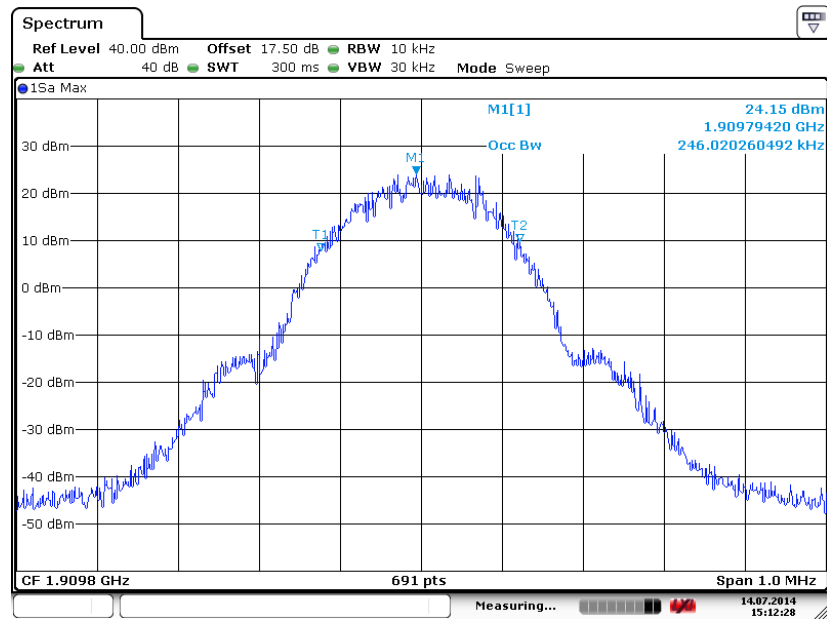

Date: 14.JUL.2014 15:12:28

26dB Bandwidth Plot on Channel 810 (1909.8 MHz)

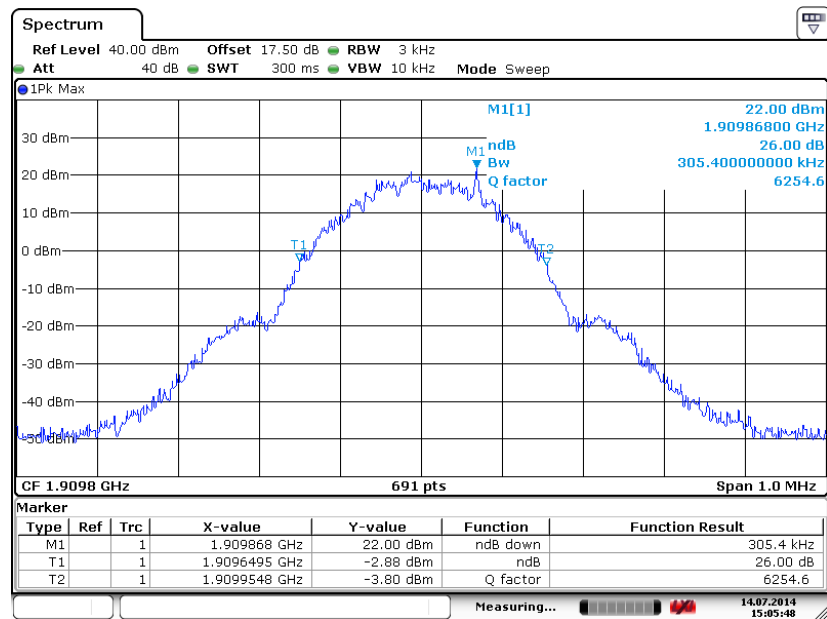

Date: 14.JUL.2014 15:05:48



Band :	GSM 1900	Test Mode :	EDGE class 8 Link (8PSK)
--------	----------	-------------	--------------------------

99% Occupied Bandwidth Plot on Channel 512 (1850.2 MHz)

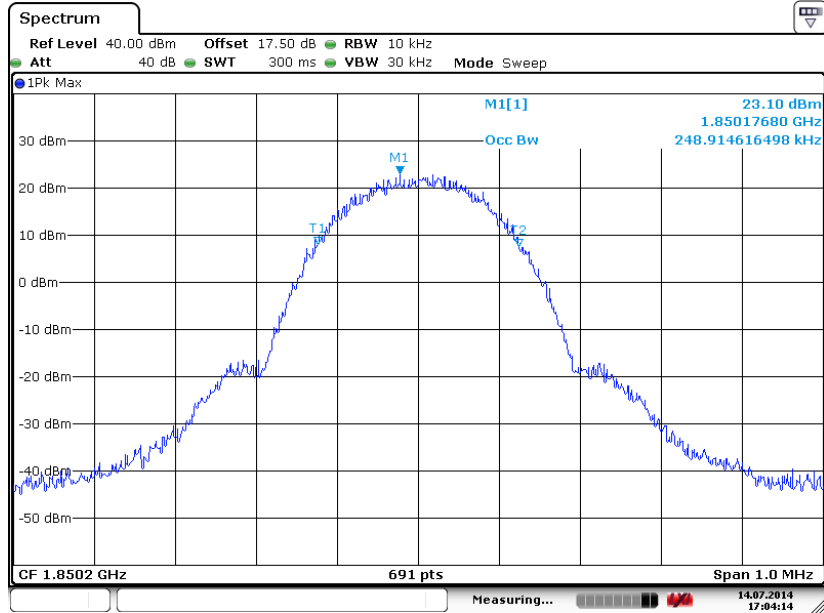

Date: 14.JUL.2014 17:04:14

26dB Bandwidth Plot on Channel 512 (1850.2 MHz)

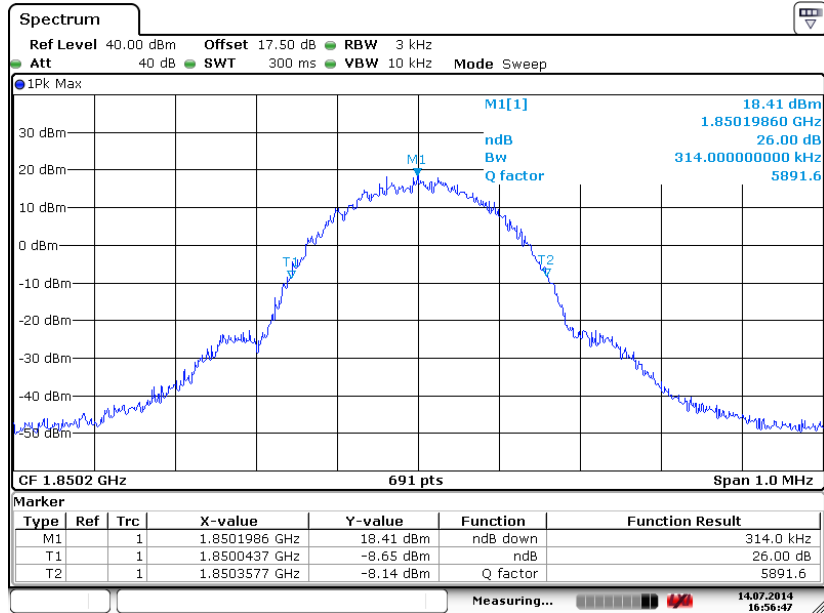

Date: 14.JUL.2014 16:56:47



99% Occupied Bandwidth Plot on Channel 661 (1880.0 MHz)

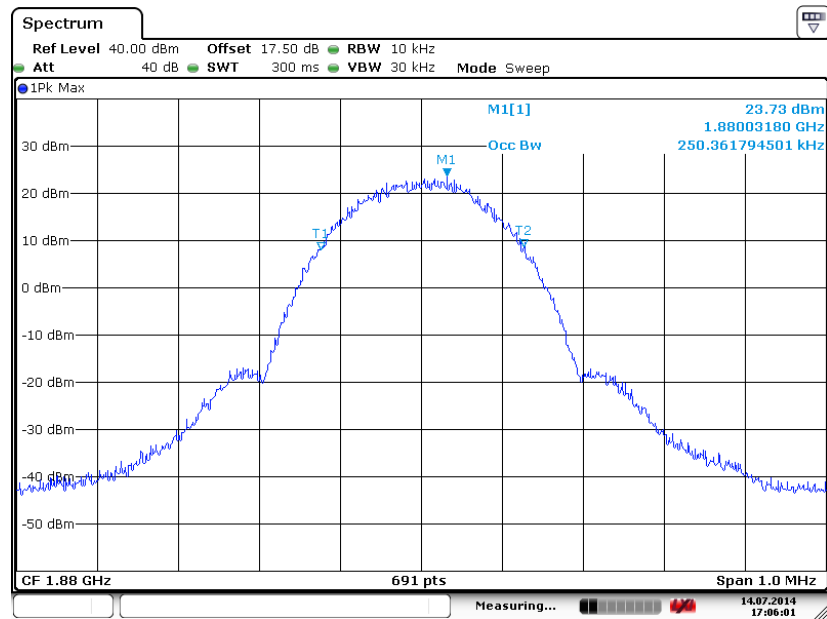

Date: 14.JUL.2014 17:06:01

26dB Bandwidth Plot on Channel 661 (1880.0 MHz)

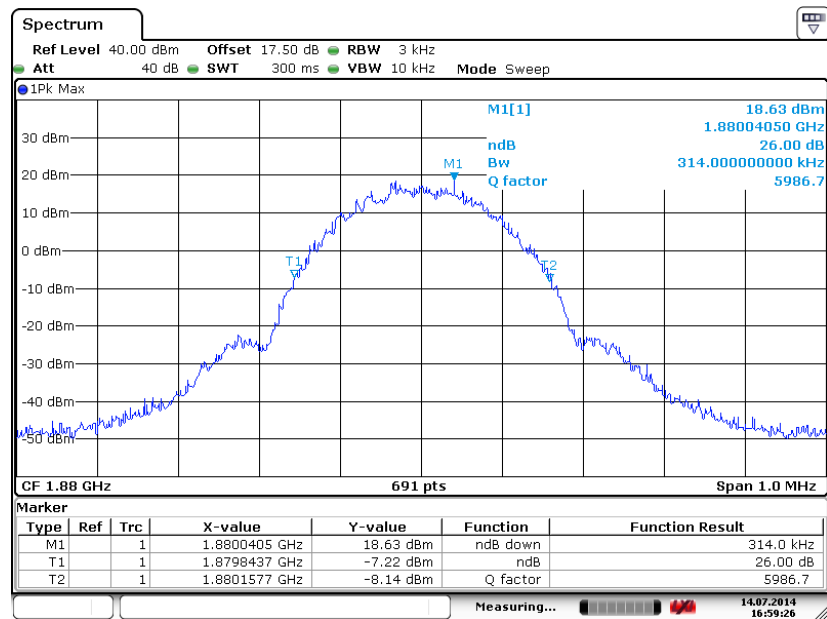

Date: 14.JUL.2014 16:59:26



99% Occupied Bandwidth Plot on Channel 810 (1909.8 MHz)

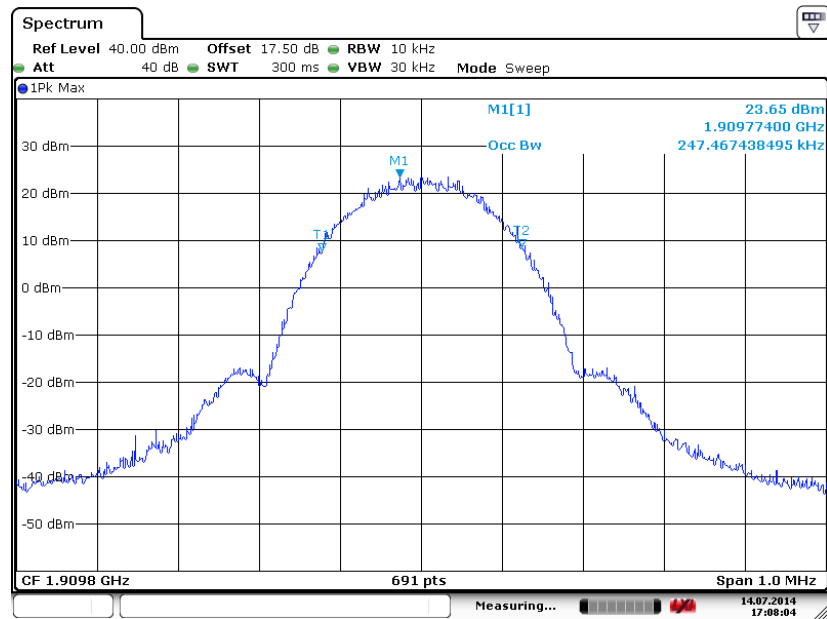

Date: 14.JUL.2014 17:08:04

26dB Bandwidth Plot on Channel 810 (1909.8 MHz)

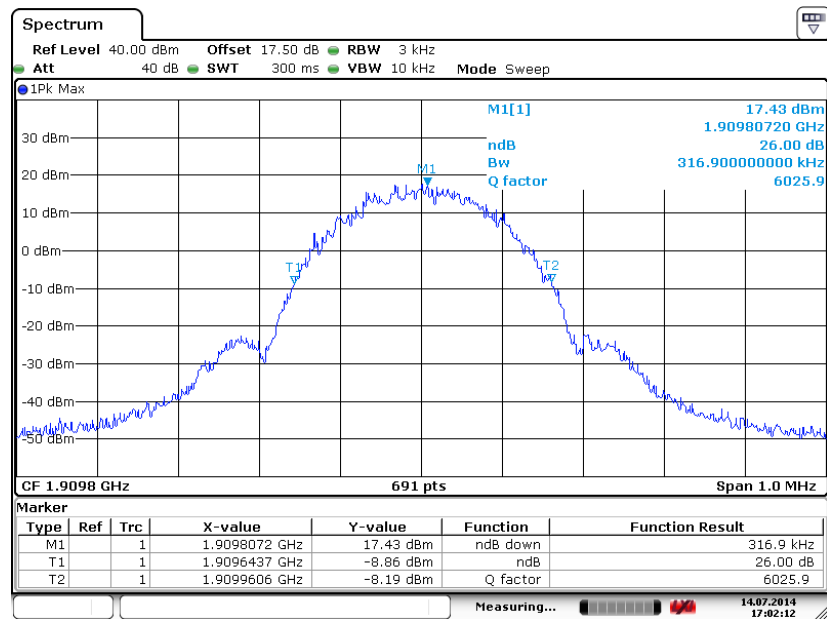

Date: 14.JUL.2014 17:02:12



Band :	WCDMA Band V	Test Mode :	RMC 12.2Kbps Link (QPSK)
--------	--------------	-------------	--------------------------

99% Occupied Bandwidth Plot on Channel 4132 (826.4 MHz)

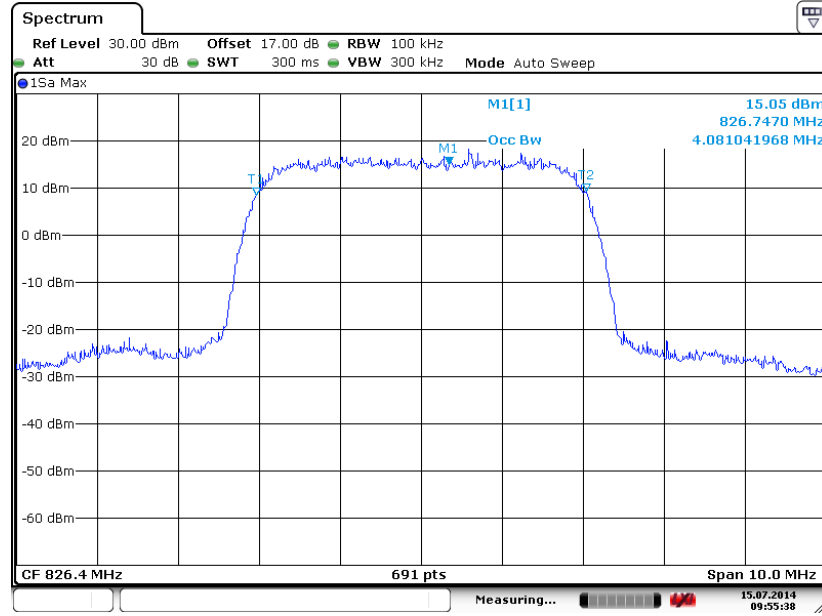

Date: 15.JUL.2014 09:55:38

26dB Bandwidth Plot on Channel 4132 (826.4 MHz)

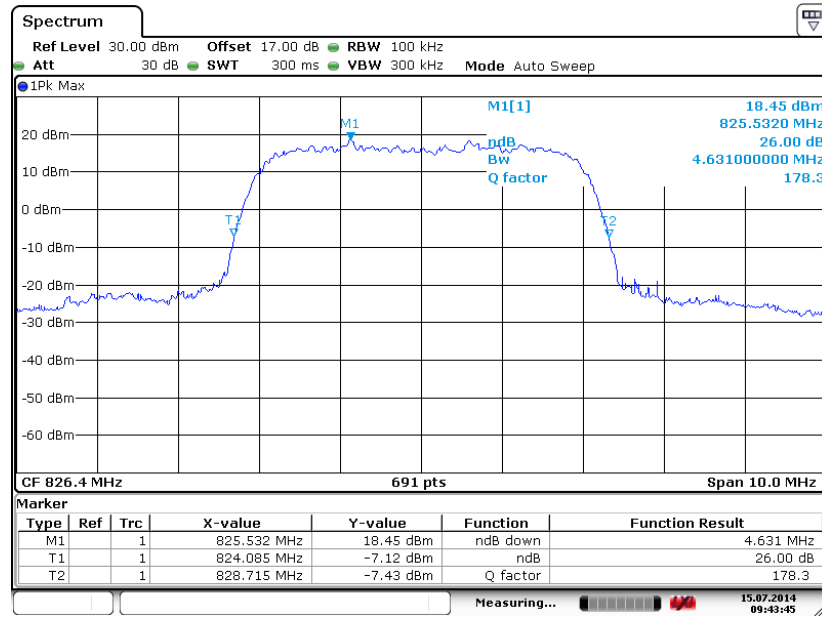

Date: 15.JUL.2014 09:43:45



99% Occupied Bandwidth Plot on Channel 4182 (836.4 MHz)

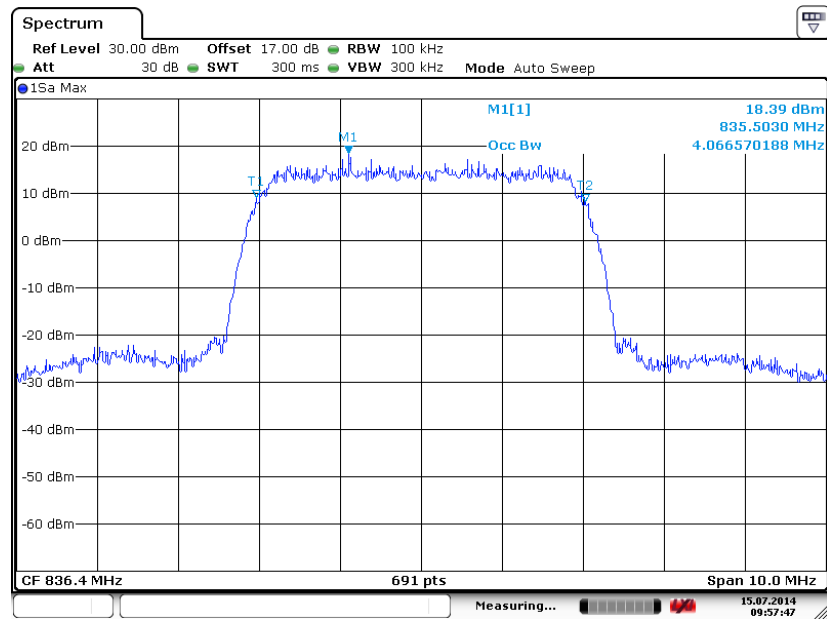

Date: 15.JUL.2014 09:57:47

26dB Bandwidth Plot on Channel 4182 (836.4 MHz)

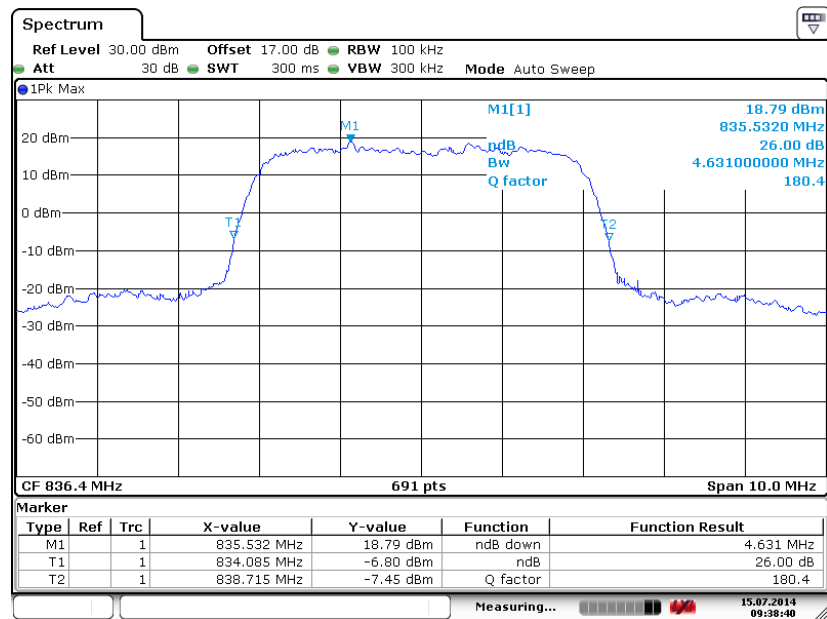

Date: 15.JUL.2014 09:38:40



99% Occupied Bandwidth Plot on Channel 4233 (846.6 MHz)

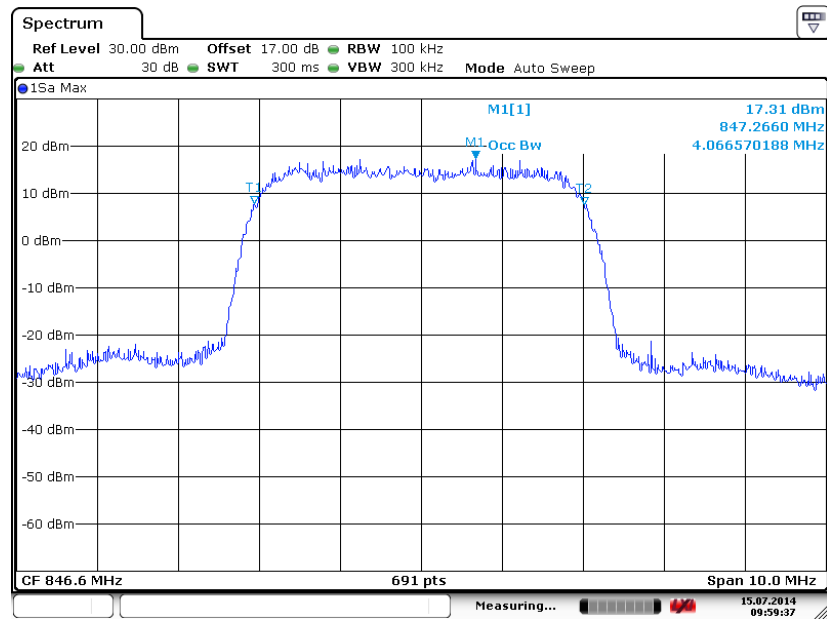

Date: 15.JUL.2014 09:59:37

26dB Bandwidth Plot on Channel 4233 (846.6 MHz)

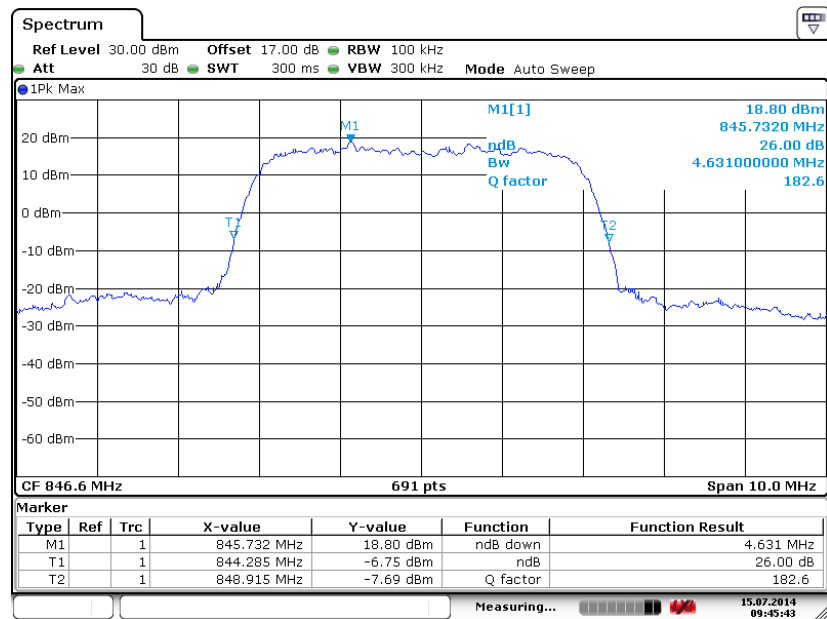

Date: 15.JUL.2014 09:45:43



Band :	WCDMA Band IV	Test Mode :	RMC 12.2Kbps Link (QPSK)
---------------	---------------	--------------------	--------------------------

99% Occupied Bandwidth Plot on Channel 1312 (1712.4 MHz)

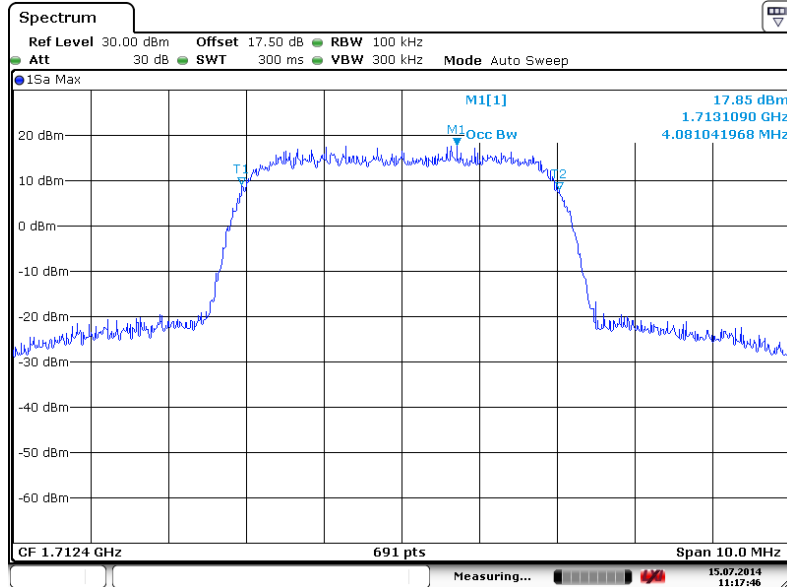

Date: 15.JUL.2014 11:17:46

26dB Bandwidth Plot on Channel 1312 (1712.4 MHz)

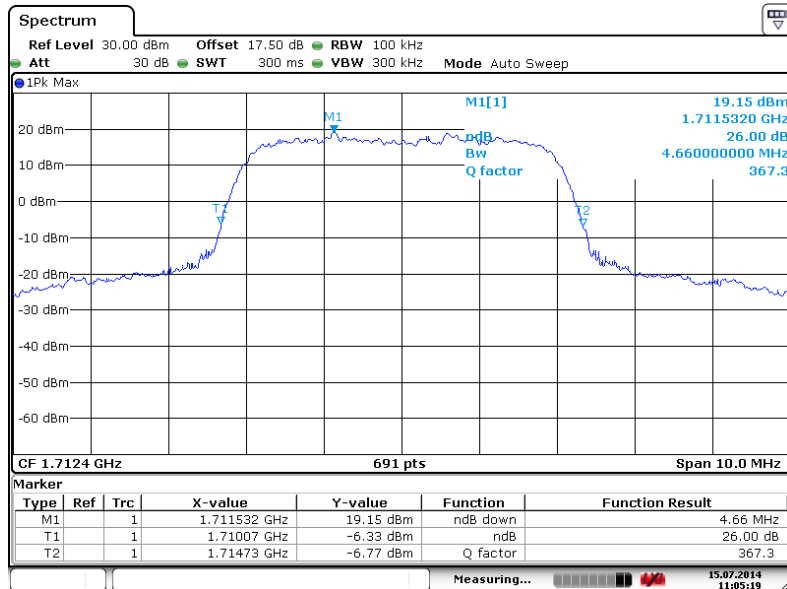

Date: 15.JUL.2014 11:05:19



99% Occupied Bandwidth Plot on Channel 1413 (1732.6 MHz)

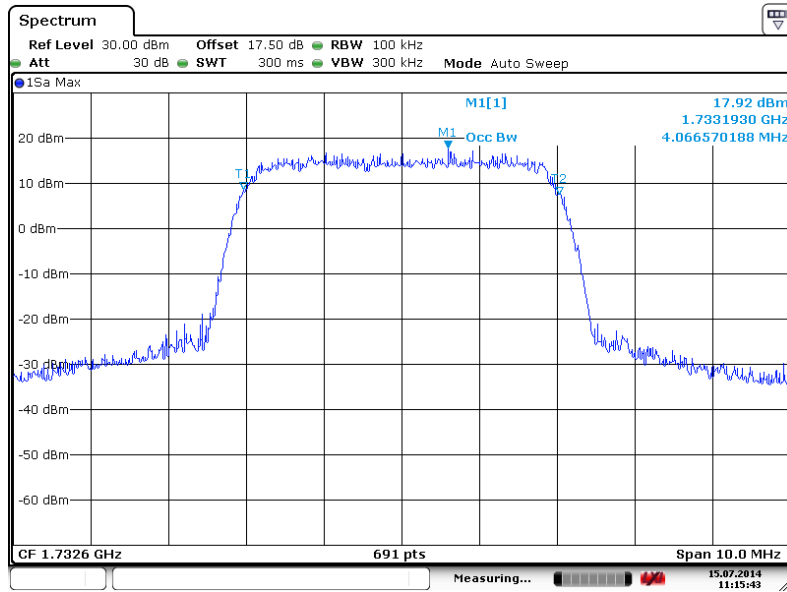

Date: 15.JUL.2014 11:15:43

26dB Bandwidth Plot on Channel 1413 (1732.6 MHz)

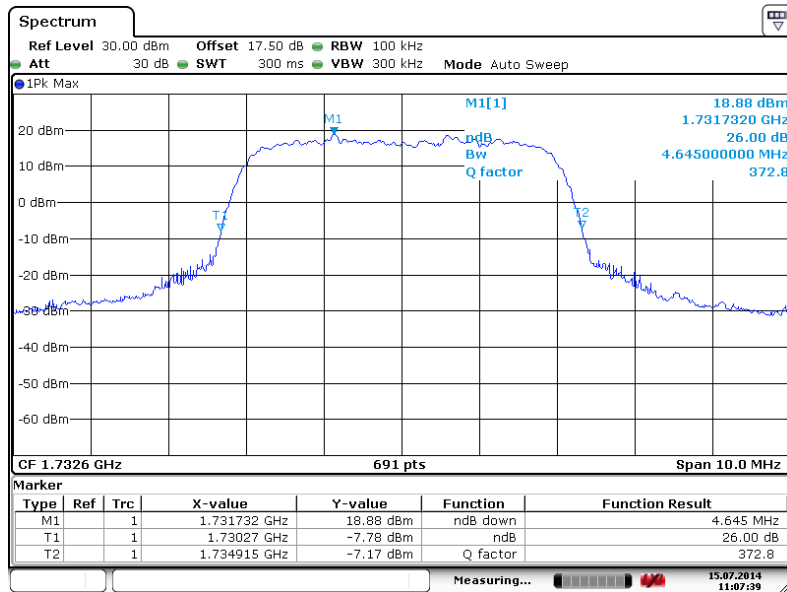

Date: 15.JUL.2014 11:07:39



99% Occupied Bandwidth Plot on Channel 1513 (1752.6 MHz)

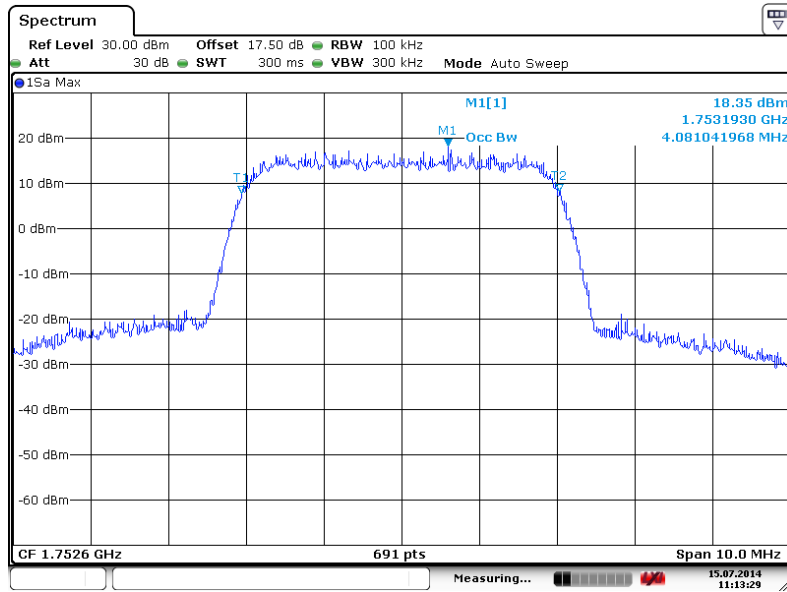

Date: 15.JUL.2014 11:13:29

26dB Bandwidth Plot on Channel 1513 (1752.6 MHz)

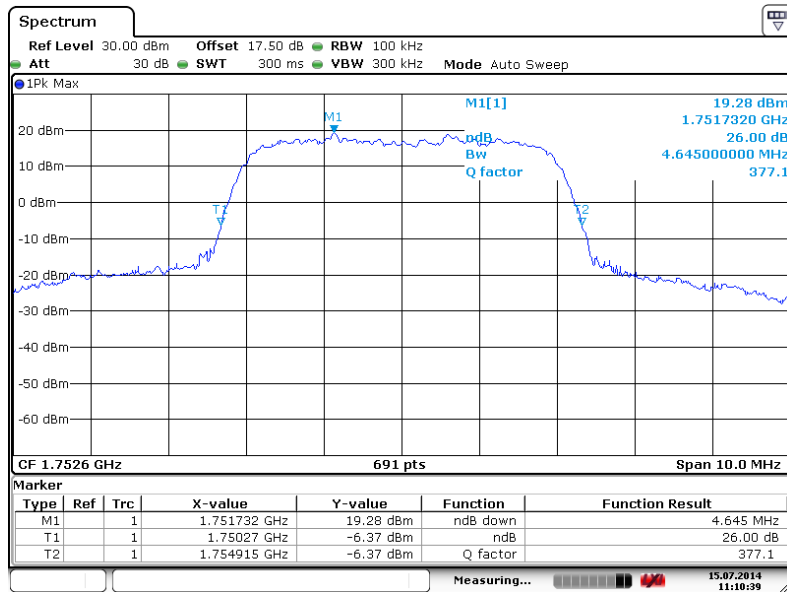

Date: 15.JUL.2014 11:10:40



Band :	WCDMA Band II	Test Mode :	RMC 12.2Kbps Link (QPSK)
--------	---------------	-------------	--------------------------

99% Occupied Bandwidth Plot on Channel 9262 (1852.4 MHz)

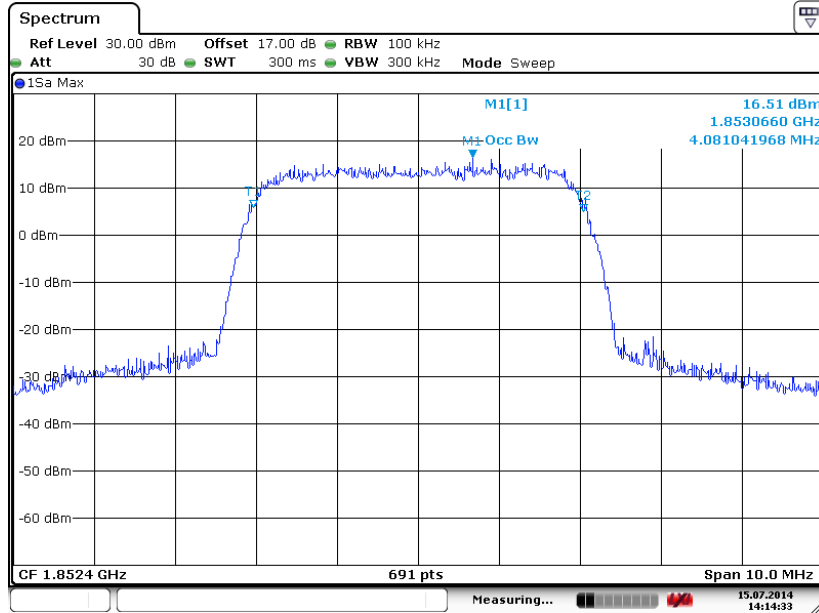

Date: 15.JUL.2014 14:14:34

26dB Bandwidth Plot on Channel 9262 (1852.4 MHz)

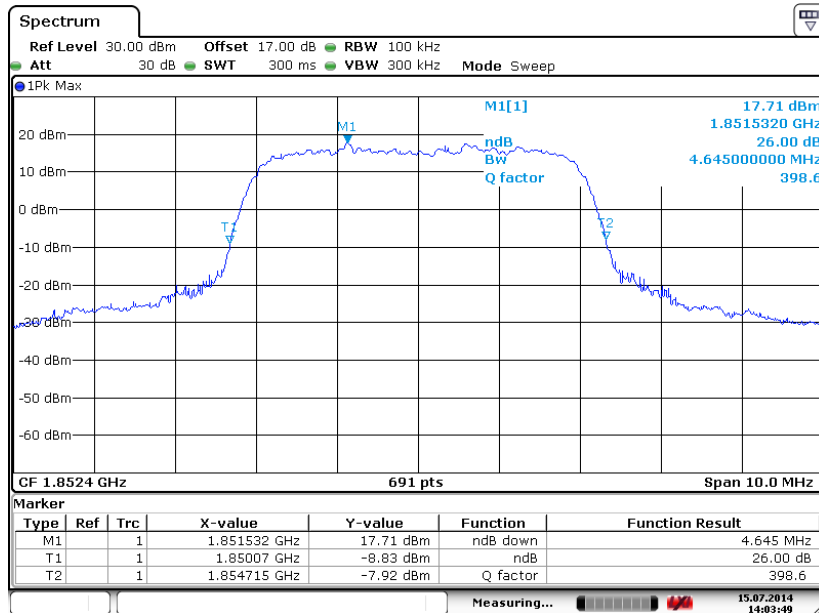

Date: 15.JUL.2014 14:03:49



99% Occupied Bandwidth Plot on Channel 9400 (1880.0 MHz)

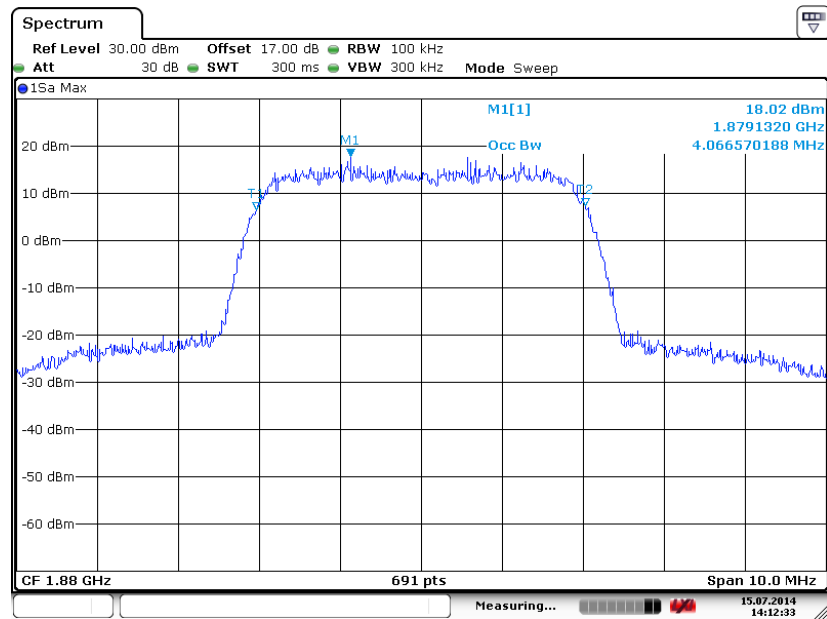

Date: 15.JUL.2014 14:12:34

26dB Bandwidth Plot on Channel 9400 (1880.0 MHz)

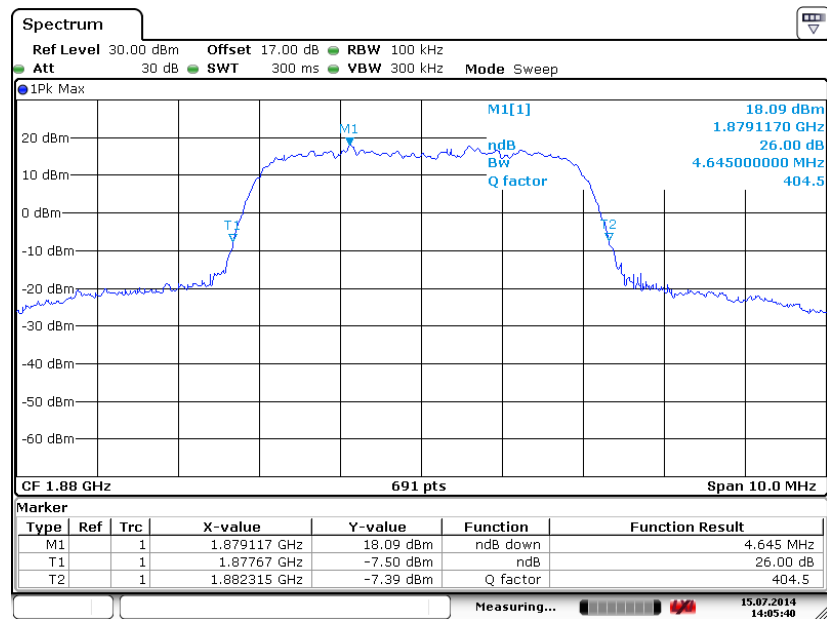

Date: 15.JUL.2014 14:05:40



99% Occupied Bandwidth Plot on Channel 9538 (1907.6 MHz)

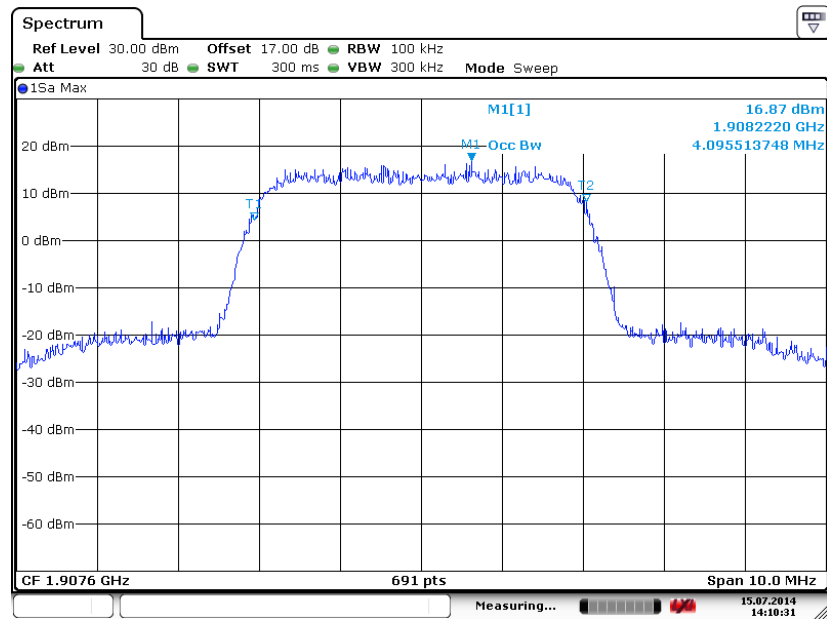

Date: 15.JUL.2014 14:10:31

26dB Bandwidth Plot on Channel 9538 (1907.6 MHz)

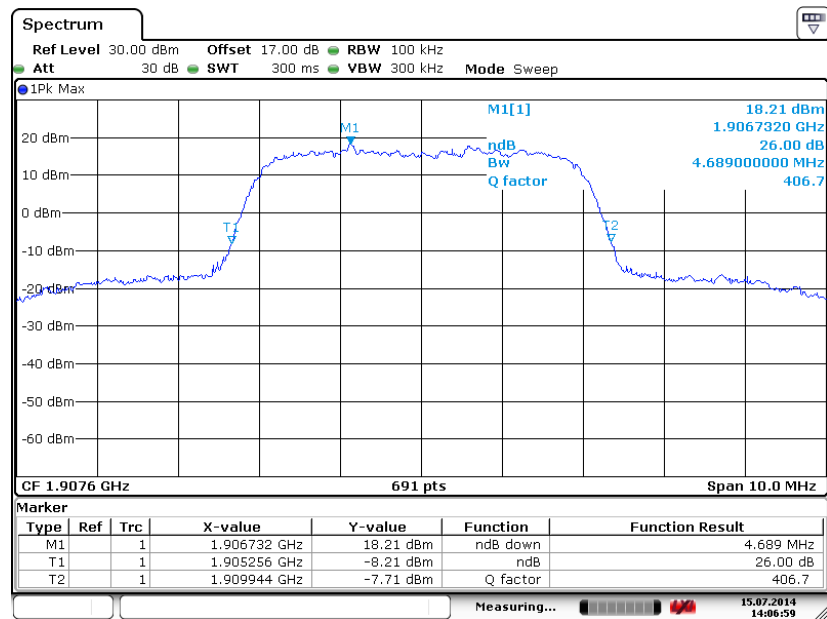

Date: 15.JUL.2014 14:06:59

3.5 Band Edge Measurement

3.5.1 Description of Band Edge Measurement

The power of any emission outside of the authorized operating frequency ranges must be lower than the transmitter power (P) by a factor of at least $43 + 10 \log (P)$ dB.

3.5.2 Measuring Instruments

The measuring equipment is listed in the section 4 of this test report.

3.5.3 Test Procedures

1. The testing follows FCC KDB 971168 v02r01 Section 6.0.
2. The EUT was connected to the spectrum analyzer and system simulator via a power divider.
3. The RF output of EUT was connected to the spectrum analyzer by an RF cable and attenuator. The path loss was compensated to the results for each measurement.
4. The band edges of low and high channels for the highest RF powers were measured.
5. The RF fundamental frequency should be excluded against the limit line in the operating frequency band.
6. The limit line is derived from $43 + 10\log(P)$ dB below the transmitter power P(Watts)
 $= P(W) - [43 + 10\log(P)] \text{ (dB)}$
 $= [30 + 10\log(P)] \text{ (dBm)} - [43 + 10\log(P)] \text{ (dB)}$
 $= -13\text{dBm}.$

3.5.4 Test Setup

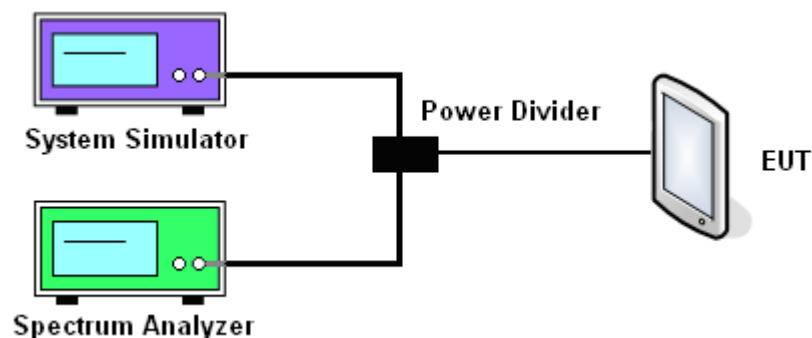

3.5.5 Test Result (Plots) of Conducted Band Edge

Band :	GSM850	Test Mode :	GPRS class 8 Link (GMSK)
Correction Factor :	0.11dB	Maximum 26dB Bandwidth :	0.308MHz
Band Edge :	-15.43dBm	Measurement Value :	-15.54dBm

Lower Band Edge Plot on Channel 128 (824.2 MHz)

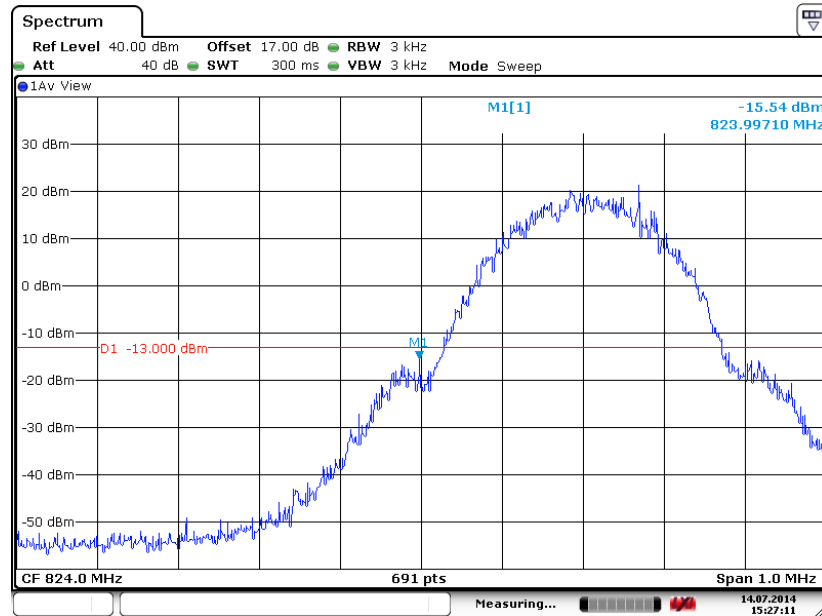

Date: 14.JUL.2014 15:27:12

1. Correction Factor(dB)= $10\log(1\% \text{ Emission BW/RBW})$
2. Band Edge= Measurement Value + Correction Factor(dB)



Band :	GSM850	Test Mode :	GPRS class 8 Link (GMSK)
Correction Factor :	0.11dB	Maximum 26dB Bandwidth :	0.308MHz
Band Edge :	-14.61dBm	Measurement Value :	-14.72dBm

Higher Band Edge Plot on Channel 251 (848.8 MHz)

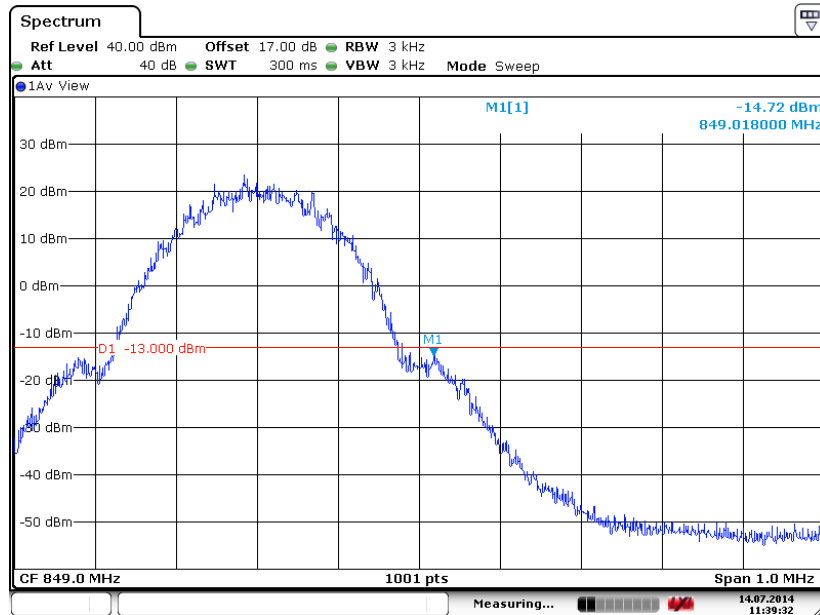

Date: 14.JUL.2014 11:39:32

1. Correction Factor(dB)= 10log(1% Emission BW/RBW)
2. Band Edge= Measurement Value + Correction Factor(dB)



Band :	GSM850	Test Mode :	EDGE class 8 Link (8PSK)
Correction Factor :	0.04dB	Maximum 26dB Bandwidth :	0.303MHz
Band Edge :	-21.04dBm	Measurement Value :	-21.08dBm

Lower Band Edge Plot on Channel 128 (824.2 MHz)

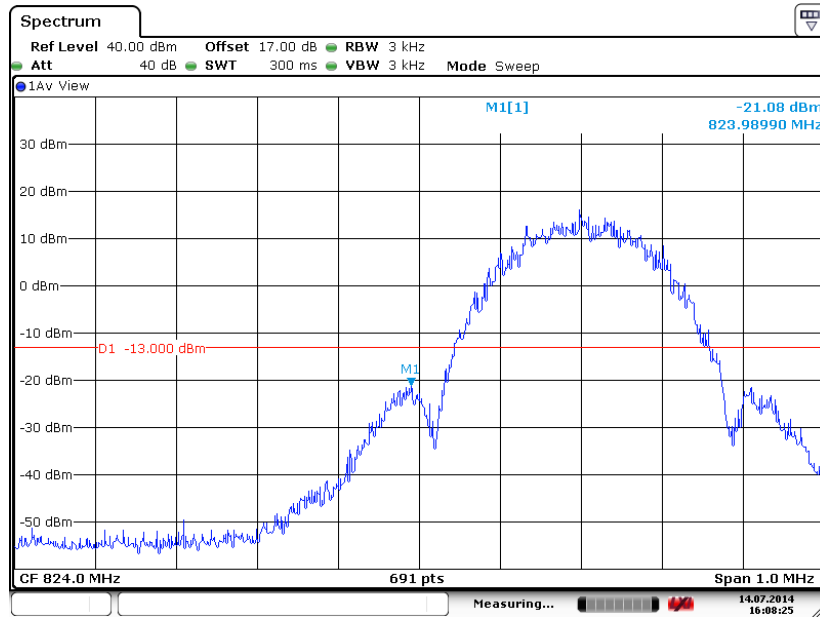

Date: 14.JUL.2014 16:08:25

1. Correction Factor(dB)= $10\log(1\% \text{ Emission BW/RBW})$
2. Band Edge= Measurement Value + Correction Factor(dB)



Band :	GSM850	Test Mode :	EDGE class 8 Link (8PSK)
Correction Factor :	0.04dB	Maximum 26dB Bandwidth :	0.303MHz
Band Edge :	-21.28dBm	Measurement Value :	-21.32dBm

Higher Band Edge Plot on Channel 251 (848.8 MHz)

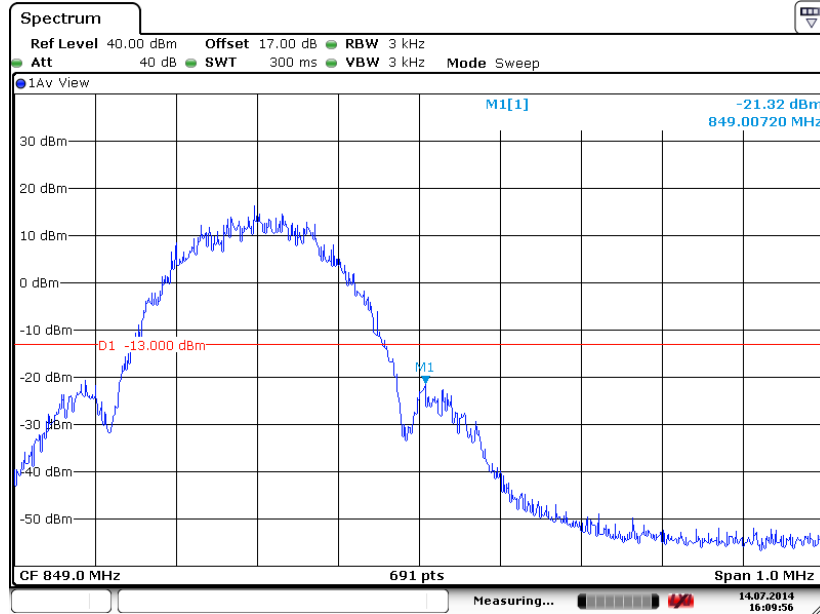

Date: 14.JUL.2014 16:09:57

1. Correction Factor(dB)= $10\log(1\% \text{ Emission BW/RBW})$
2. Band Edge= Measurement Value + Correction Factor(dB)



Band :	GSM1900	Test Mode :	GPRS class 8 Link (GMSK)
Correction Factor :	0.14dB	Maximum 26dB Bandwidth :	0.310MHz
Band Edge :	-18.48dBm	Measurement Value :	-18.62dBm

Lower Band Edge Plot on Channel 512 (1850.2 MHz)

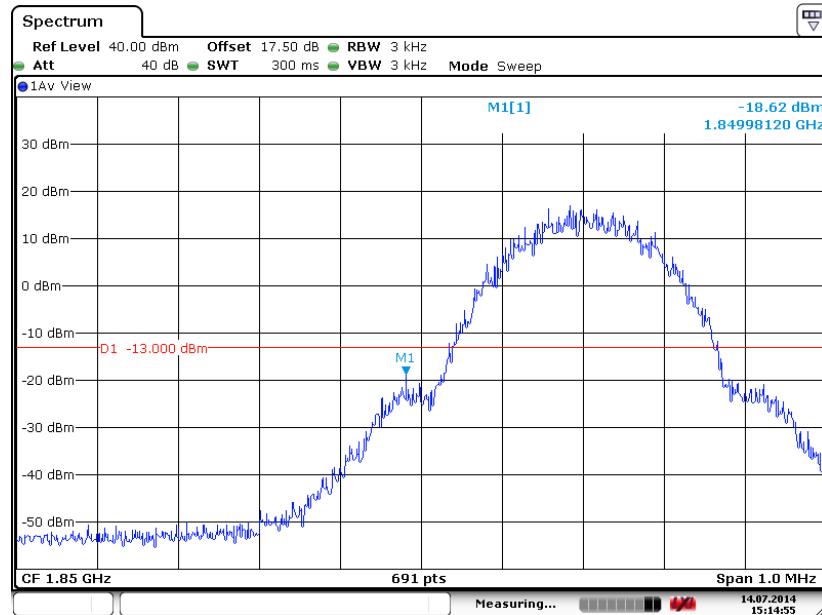

Date: 14.JUL.2014 15:14:56

1. Correction Factor(dB)= 10log(1% Emission BW/RBW)
2. Band Edge= Measurement Value + Correction Factor(dB)



Band :	GSM1900	Test Mode :	GPRS class 8 Link (GMSK)
Correction Factor :	0.14dB	Maximum 26dB Bandwidth :	0.310MHz
Band Edge :	-19.93dBm	Measurement Value :	-20.07dBm

Higher Band Edge Plot on Channel 810 (1909.8 MHz)

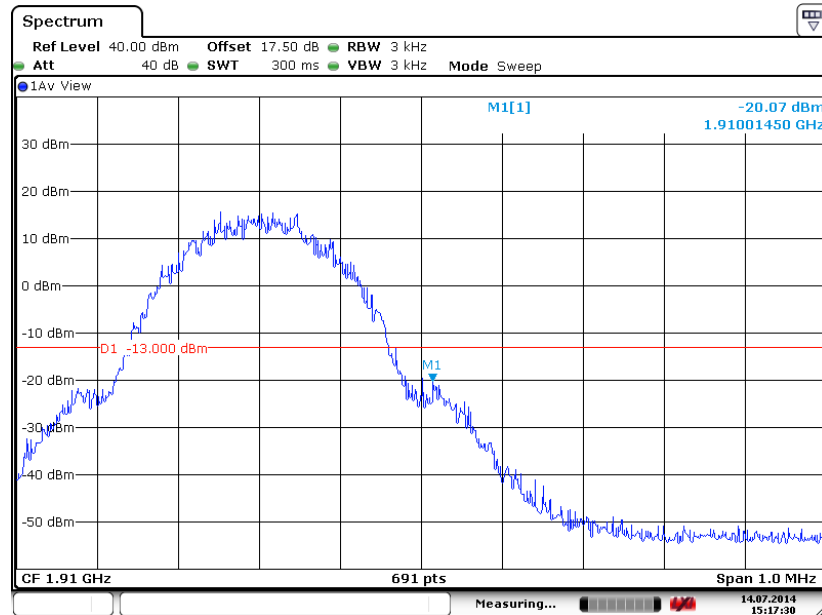

Date: 14.JUL.2014 15:17:30

1. Correction Factor(dB)= $10\log(1\% \text{ Emission BW/RBW})$
2. Band Edge= Measurement Value + Correction Factor(dB)



Band :	GSM1900	Test Mode :	EDGE class 8 Link (8PSK)
Correction Factor :	0.24dB	Maximum 26dB Bandwidth :	0.317MHz
Band Edge :	-26.12dBm	Measurement Value :	-26.36dBm

Lower Band Edge Plot on Channel 512 (1850.2 MHz)

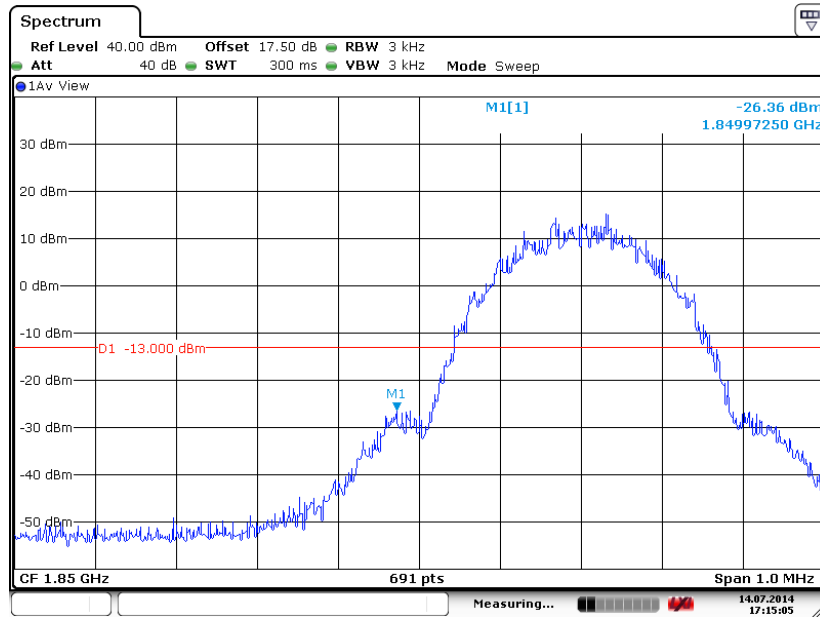

Date: 14.JUL.2014 17:15:06

1. Correction Factor(dB)= 10log(1% Emission BW/RBW)
2. Band Edge= Measurement Value + Correction Factor(dB)



Band :	GSM1900	Test Mode :	EDGE class 8 Link (8PSK)
Correction Factor :	0.24dB	Maximum 26dB Bandwidth :	0.317MHz
Band Edge :	-26.78dBm	Measurement Value :	-27.02dBm

Higher Band Edge Plot on Channel 810 (1909.8 MHz)



Date: 14.JUL.2014 17:13:18

1. Correction Factor(dB)= 10log(1% Emission BW/RBW)
2. Band Edge= Measurement Value + Correction Factor(dB)



Band :	WCDMA Band V	Test Mode :	RMC 12.2Kbps Link (QPSK)
Correction Factor :	-3.34dB	Maximum 26dB Bandwidth :	4.631MHz
Band Edge :	-30.46dBm	Measurement Value :	-27.12dBm

Lower Band Edge Plot on Channel 4132 (826.4 MHz)

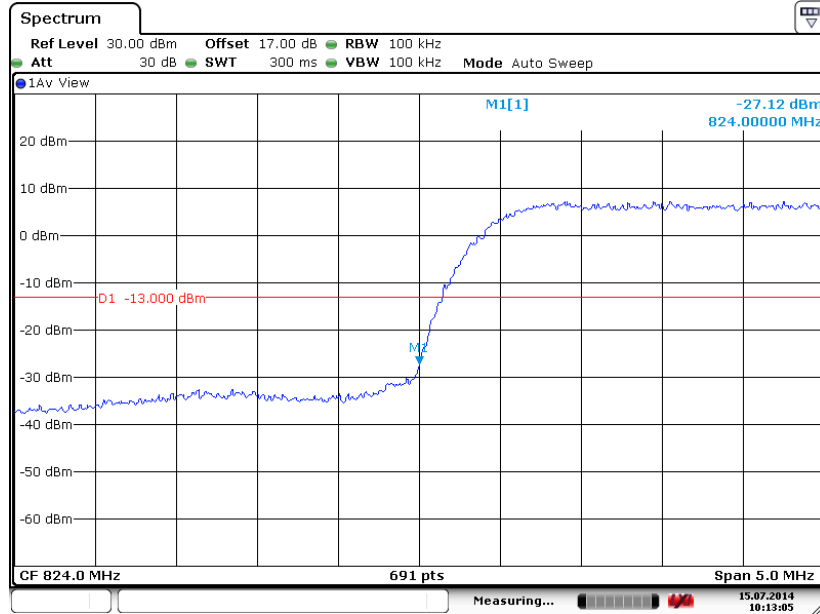

Date: 15.JUL.2014 10:13:06

1. Correction Factor(dB)= 10log(1% Emission BW/RBW)
2. Band Edge= Measurement Value + Correction Factor(dB)



Band :	WCDMA Band V	Test Mode :	RMC 12.2Kbps Link (QPSK)
Correction Factor :	-3.34dB	Maximum 26dB Bandwidth :	4.631MHz
Band Edge :	-30.09dBm	Measurement Value :	-26.75dBm

Higher Band Edge Plot on Channel 4233 (846.6 MHz)

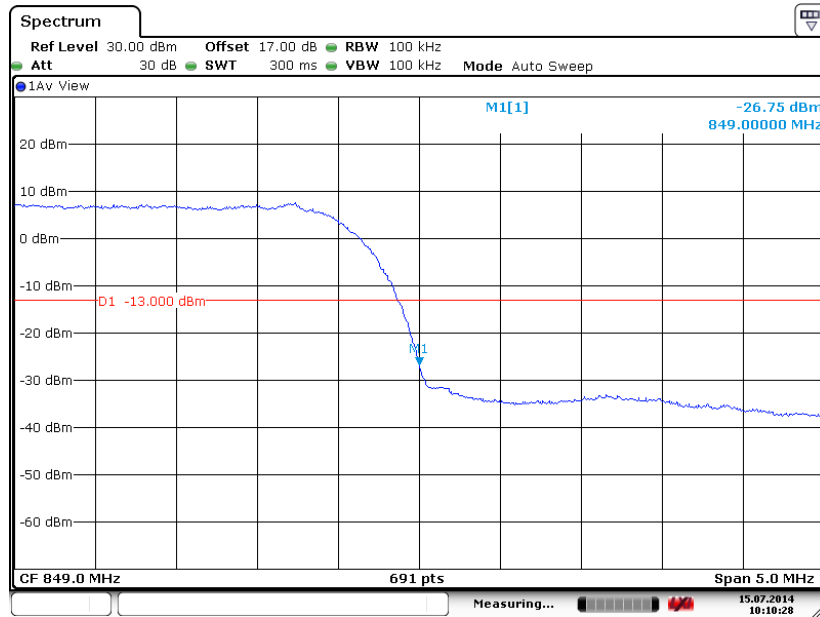

Date: 15.JUL.2014 10:10:28

1. Correction Factor(dB)= 10log(1% Emission BW/RBW)
2. Band Edge= Measurement Value + Correction Factor(dB)



Band :	WCDMA Band IV	Test Mode :	RMC 12.2Kbps Link (QPSK)
Correction Factor :	-3.32dB	Maximum 26dB Bandwidth :	4.660MHz
Band Edge :	-24.75dBm	Measurement Value :	-21.43dBm

Lower Band Edge Plot on Channel 1312 (1712.4 MHz)

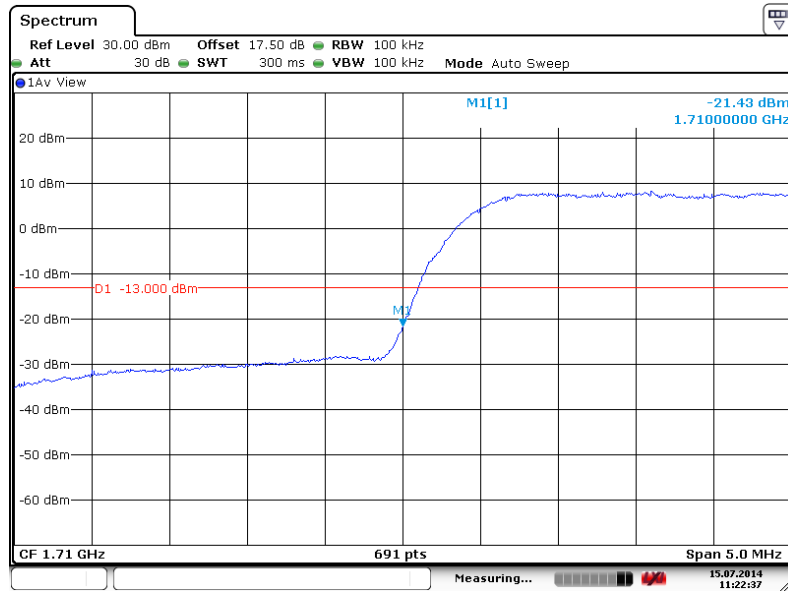

Date: 15.JUL.2014 11:22:38

1. Correction Factor(dB)= $10\log(1\% \text{ Emission BW/RBW})$
2. Band Edge= Measurement Value + Correction Factor(dB)



Band :	WCDMA Band IV	Test Mode :	RMC 12.2Kbps Link (QPSK)
Correction Factor :	-3.32dB	Maximum 26dB Bandwidth :	4.660MHz
Band Edge :	-25.72dBm	Measurement Value :	-22.40dBm

Higher Band Edge Plot on Channel 1513 (1752.6 MHz)

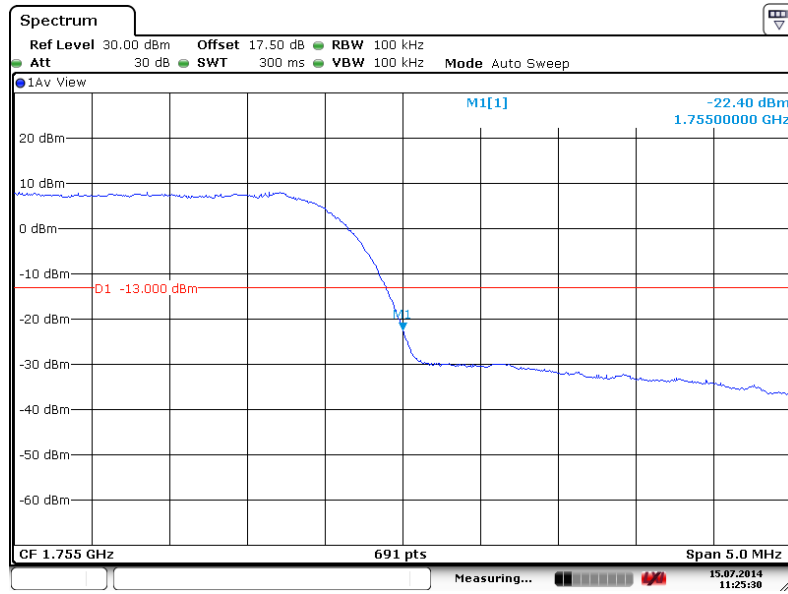

Date: 15.JUL.2014 11:25:30

1. Correction Factor(dB)= $10\log(1\% \text{ Emission BW/RBW})$
2. Band Edge= Measurement Value + Correction Factor(dB)



Band :	WCDMA Band II	Test Mode :	RMC 12.2Kbps Link (QPSK)
Correction Factor :	-3.29dB	Maximum 26dB Bandwidth :	4.689MHz
Band Edge :	-28.86dBm	Measurement Value :	-25.57dBm

Lower Band Edge Plot on Channel 9262 (1852.4 MHz)

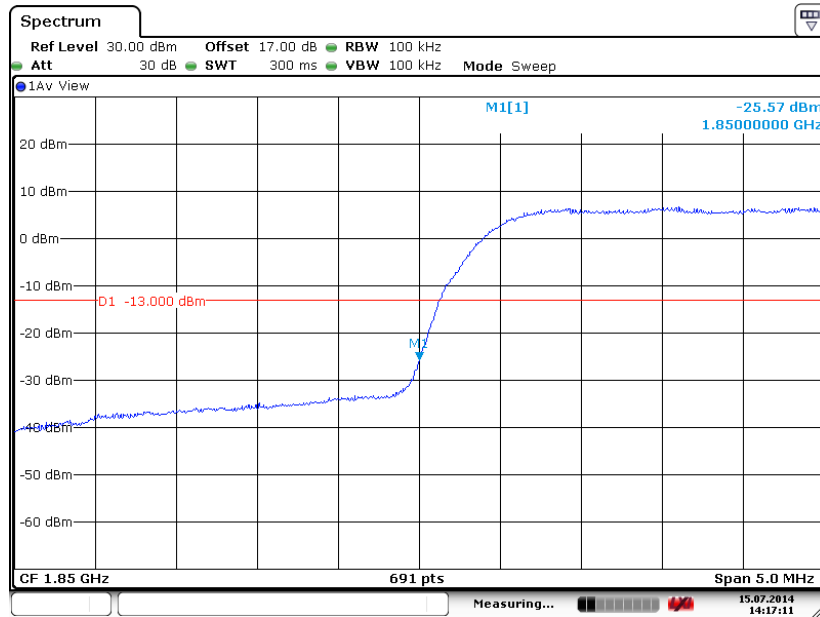

1. Correction Factor(dB)= $10\log(1\% \text{ Emission BW/RBW})$
2. Band Edge= Measurement Value + Correction Factor(dB)



Band :	WCDMA Band II	Test Mode :	RMC 12.2Kbps Link (QPSK)
Correction Factor :	-3.29dB	Maximum 26dB Bandwidth :	4.689MHz
Band Edge :	-24.24dBm	Measurement Value :	-20.95dBm

Higher Band Edge Plot on Channel 9538 (1907.6 MHz)

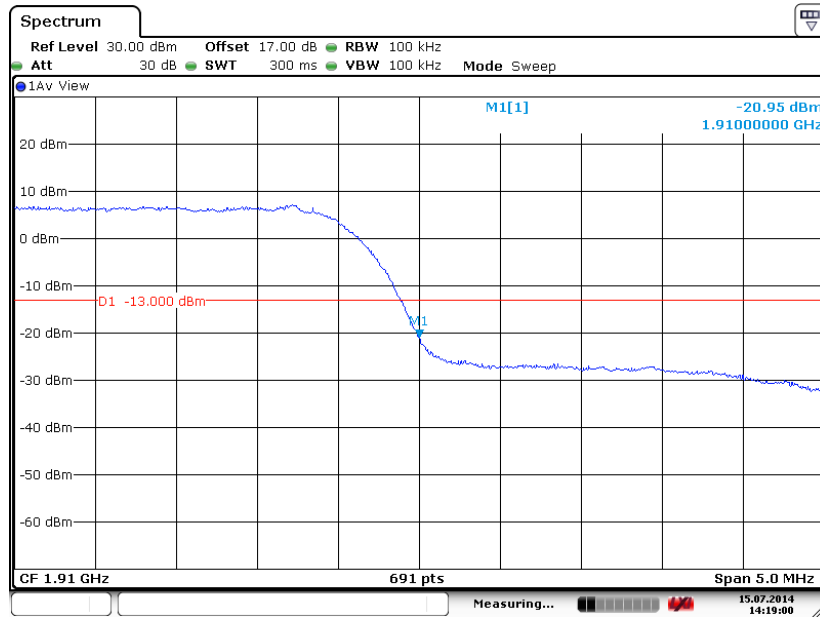

Date: 15.JUL.2014 14:19:00

1. Correction Factor(dB)= 10log(1% Emission BW/RBW)
2. Band Edge= Measurement Value + Correction Factor(dB)

3.6 Conducted Spurious Emission Measurement

3.6.1 Description of Conducted Spurious Emission Measurement

The power of any emission outside of the authorized operating frequency ranges must be lower than the transmitter power (P) by a factor of at least $43 + 10 \log (P)$ dB.

It is measured by means of a calibrated spectrum analyzer and scanned from 30 MHz up to a frequency including its 10th harmonic.

3.6.2 Measuring Instruments

The measuring equipment is listed in the section 4 of this test report.

3.6.3 Test Procedures

1. The testing follows FCC KDB 971168 v02r01 Section 6.0.
2. The EUT was connected to the spectrum analyzer and system simulator via a power divider.
3. The RF output of EUT was connected to the spectrum analyzer by an RF cable and attenuator. The path loss was compensated to the results for each measurement.
4. The middle channel for the highest RF power within the transmitting frequency was measured.
5. The conducted spurious emission for the whole frequency range was taken.
6. The RF fundamental frequency should be excluded against the limit line in the operating frequency band.
7. The limit line is derived from $43 + 10\log(P)$ dB below the transmitter power P(Watts)
 - = $P(W) - [43 + 10\log(P)]$ (dB)
 - = $[30 + 10\log(P)]$ (dBm) - $[43 + 10\log(P)]$ (dB)
 - = -13dBm.

3.6.4 Test Setup

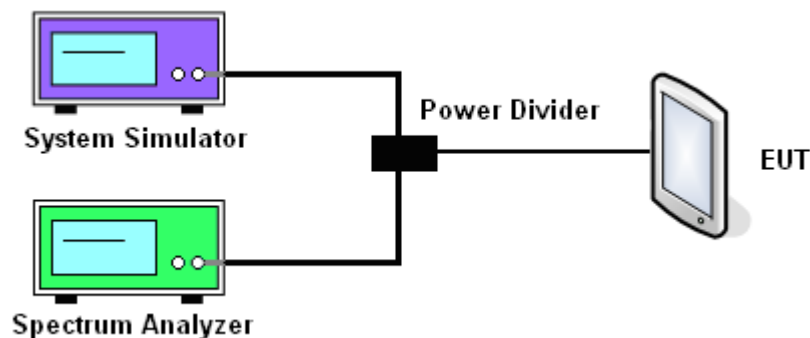



3.6.5 Test Result (Plots) of Conducted Spurious Emission

Band :	GSM850	Channel :	CH128
Test Mode :	GPRS class 8 Link (GMSK)	Frequency :	824.2 MHz

Conducted Spurious Emission Plot between 30MHz ~ 1GHz

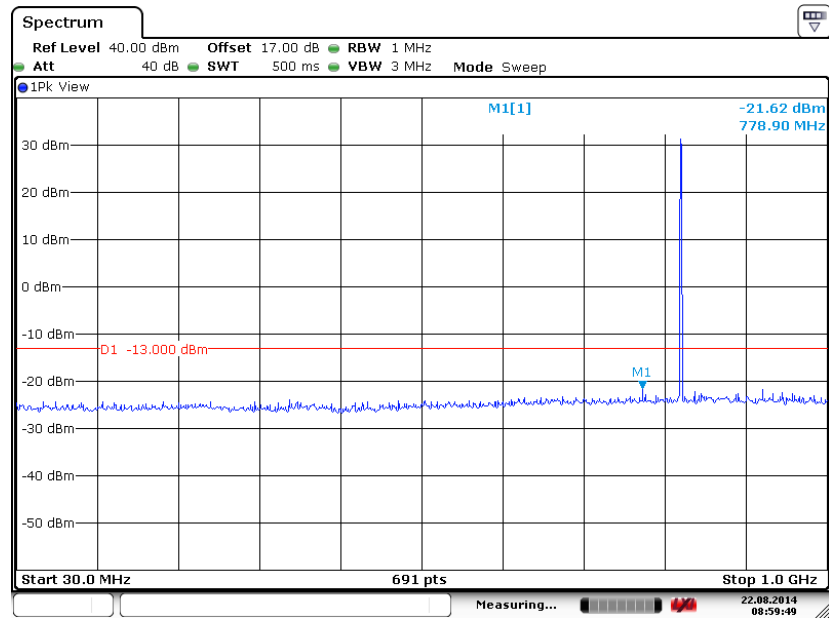

Date: 22.AUG.2014 08:59:49

Conducted Spurious Emission Plot between 1GHz ~ 3GHz

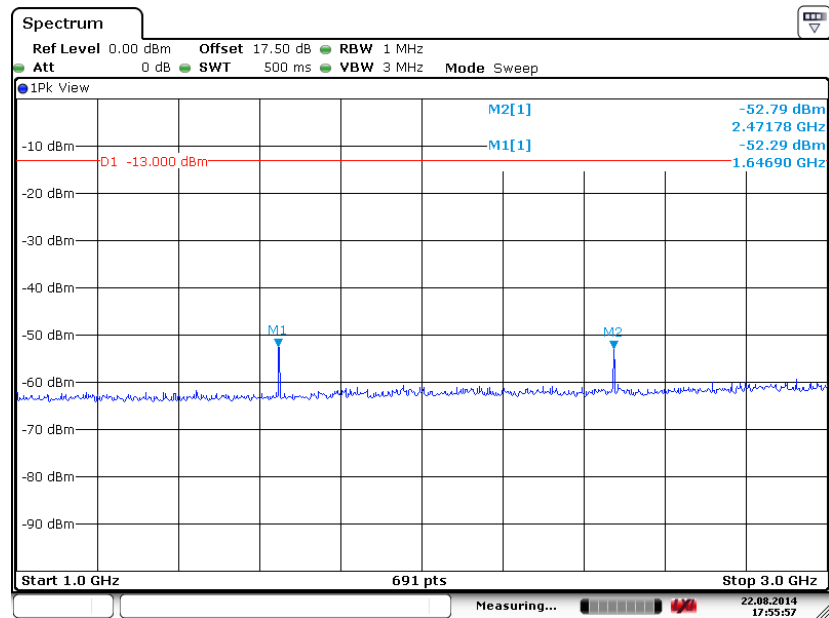

Date: 22.AUG.2014 17:55:57



Conducted Spurious Emission Plot between 3GHz ~ 7GHz

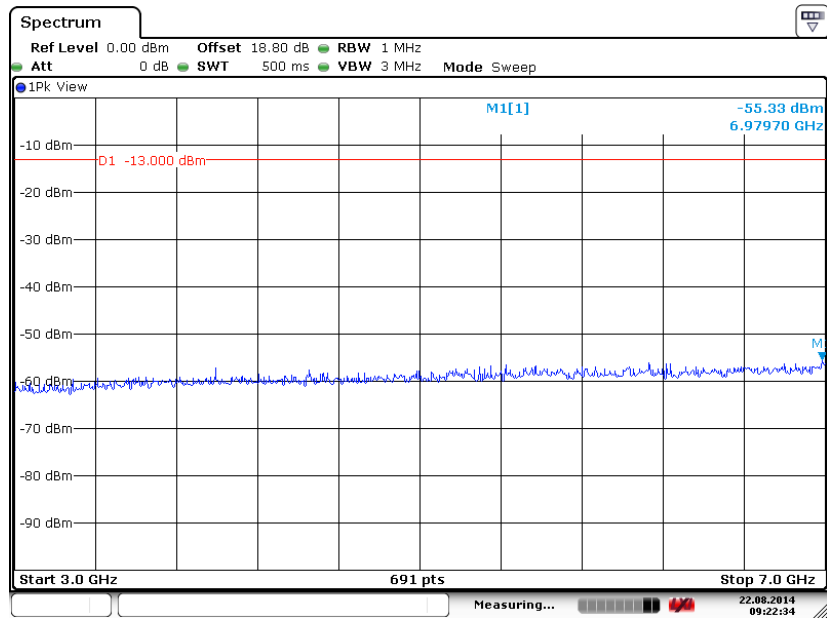

Date: 22.AUG.2014 09:22:34

Conducted Spurious Emission Plot between 7GHz ~ 9GHz

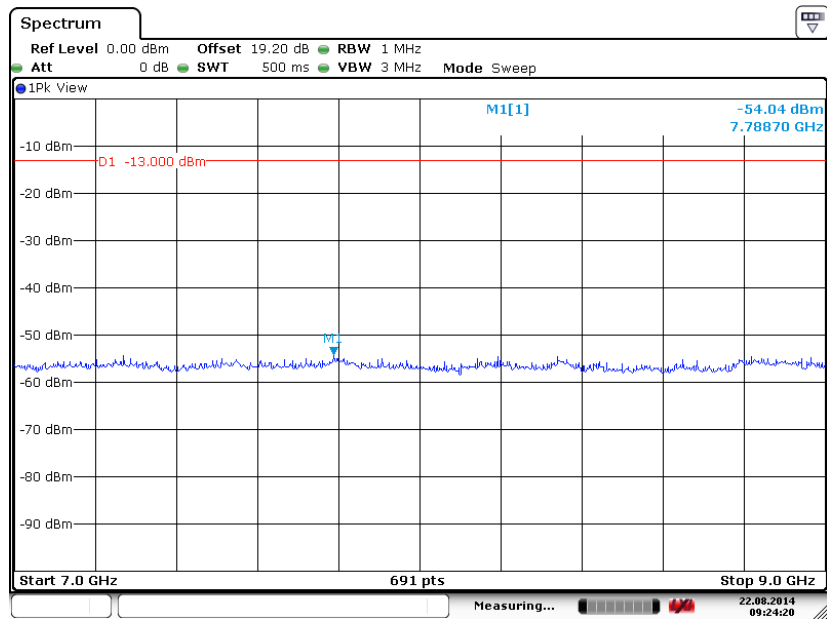

Date: 22.AUG.2014 09:24:20



Band :	GSM850	Channel :	CH189
Test Mode :	GPRS class 8 Link (GMSK)	Frequency :	836.4 MHz

Conducted Spurious Emission Plot between 30MHz ~ 1GHz

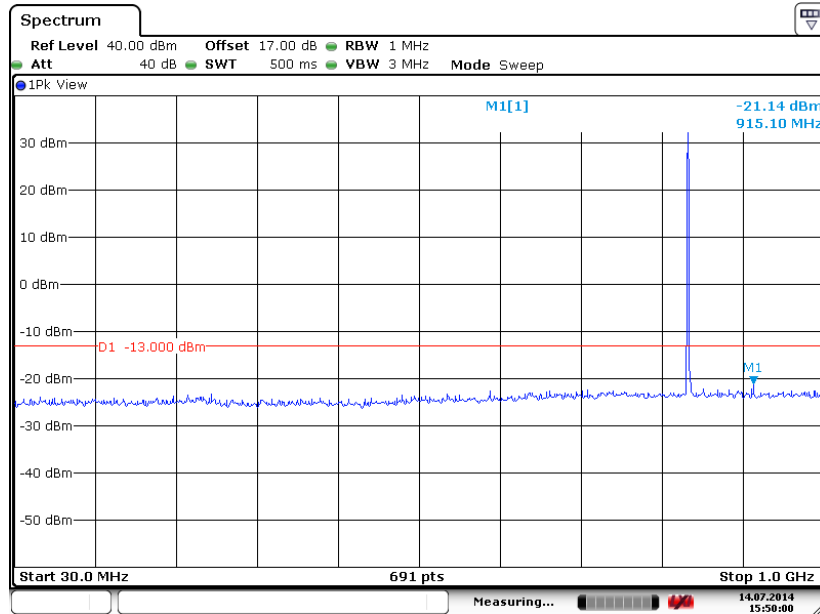

Date: 14.JUL.2014 15:50:01

Conducted Spurious Emission Plot between 1GHz ~ 3GHz

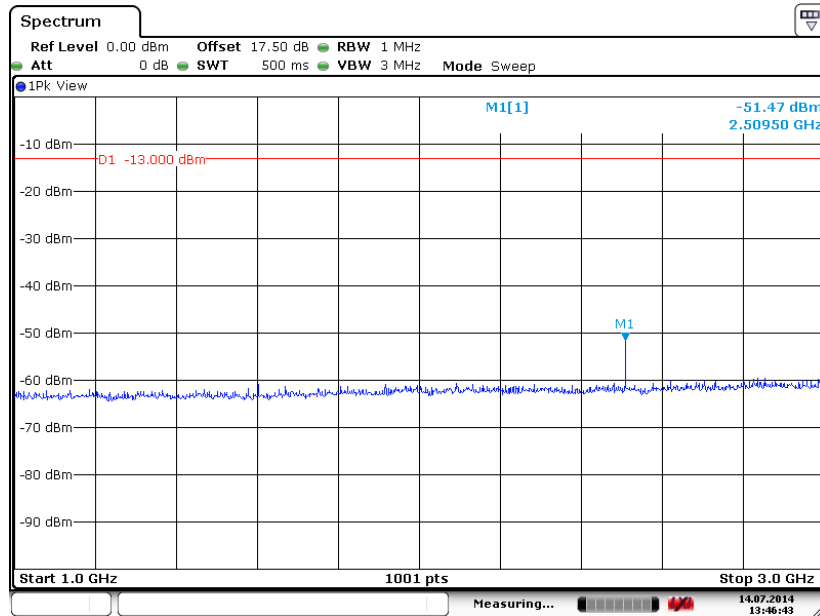

Date: 14.JUL.2014 13:46:43



Conducted Spurious Emission Plot between 3GHz ~ 7GHz

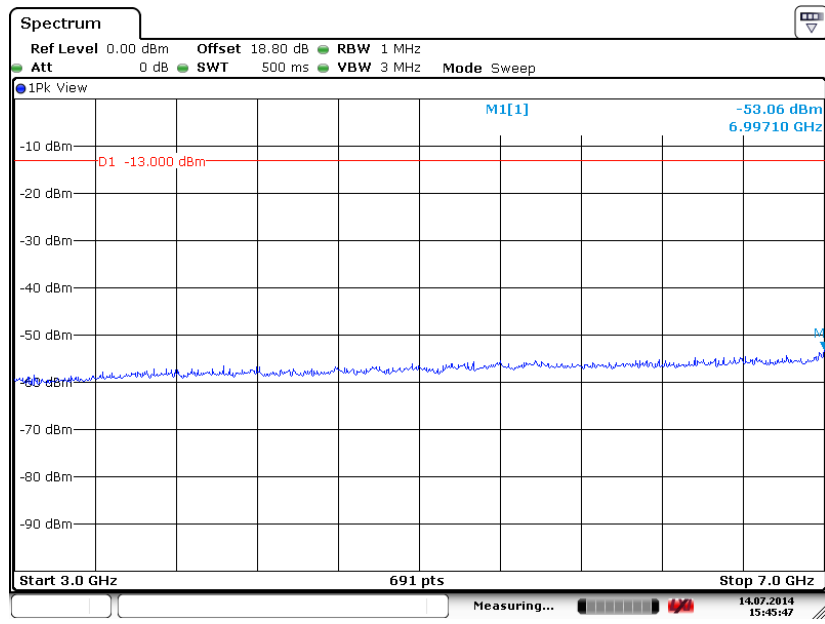

Date: 14.JUL.2014 15:45:47

Conducted Spurious Emission Plot between 7GHz ~ 9GHz

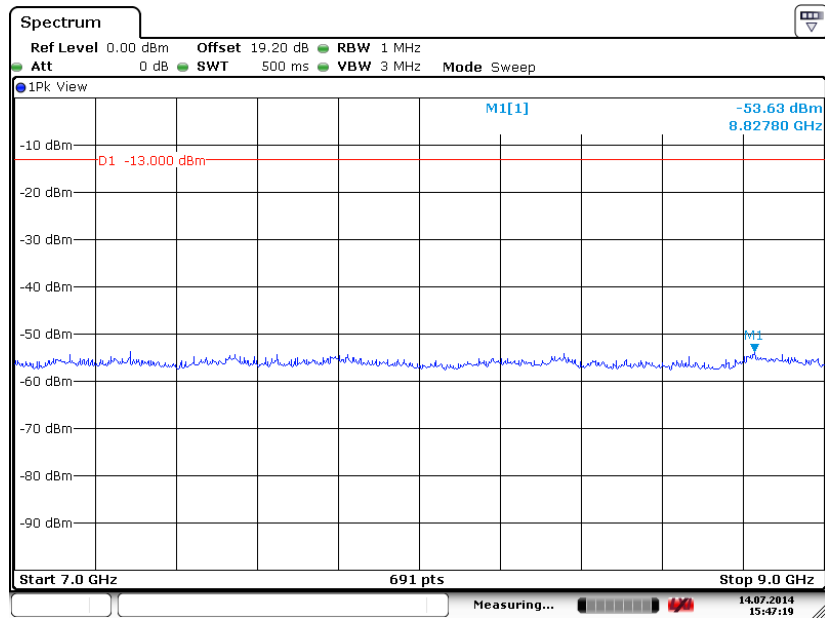

Date: 14.JUL.2014 15:47:19



Band :	GSM850	Channel :	CH251
Test Mode :	GPRS class 8 Link (GMSK)	Frequency :	848.8 MHz

Conducted Spurious Emission Plot between 30MHz ~ 1GHz

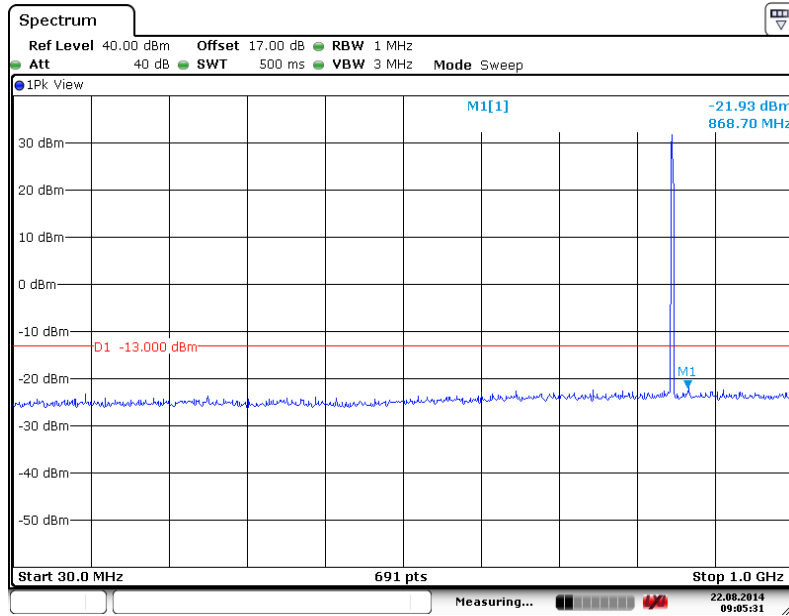

Date: 22.AUG.2014 09:05:31

Conducted Spurious Emission Plot between 1GHz ~ 3GHz

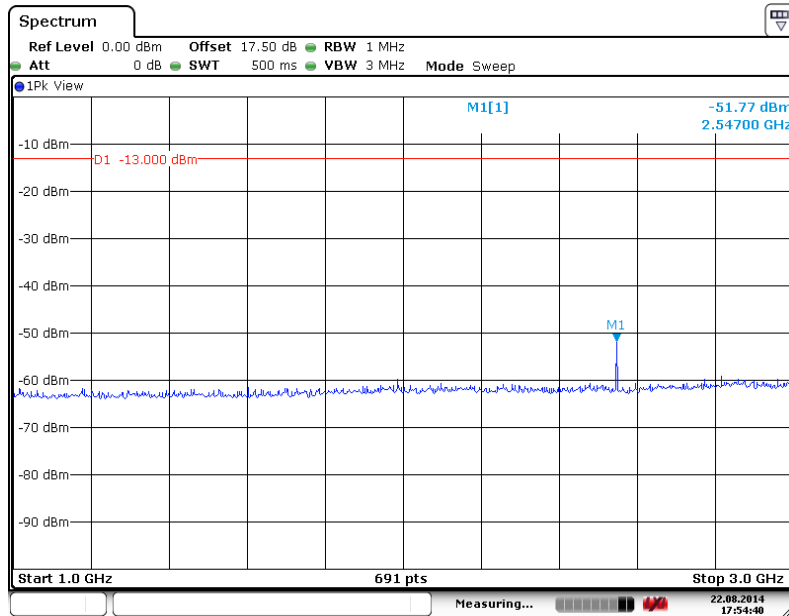

Date: 22.AUG.2014 17:54:39



Conducted Spurious Emission Plot between 3GHz ~ 7GHz

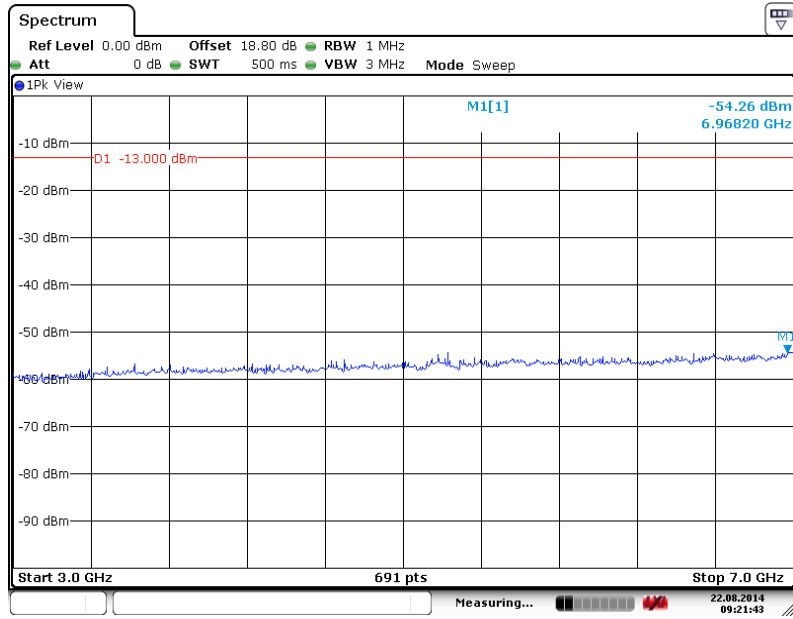

Date: 22.AUG.2014 09:21:43

Conducted Spurious Emission Plot between 7GHz ~ 9GHz

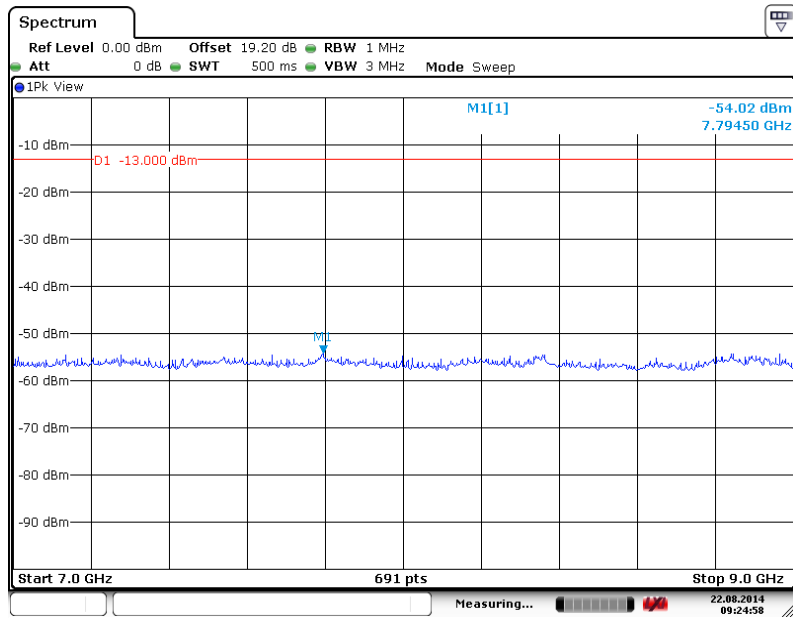

Date: 22.AUG.2014 09:24:58



Band :	GSM850	Channel :	CH128
Test Mode :	EDGE class 8 Link (8PSK)	Frequency :	824.2 MHz

Conducted Spurious Emission Plot between 30MHz ~ 1GHz

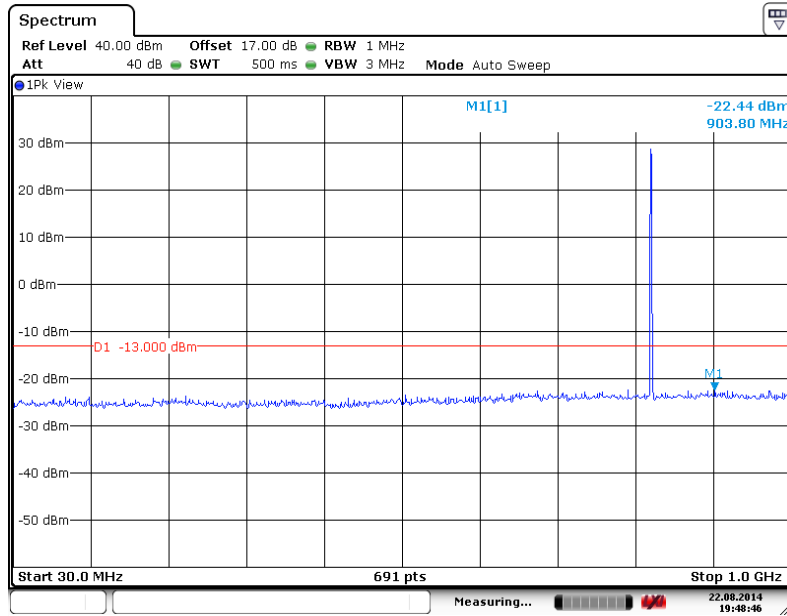

Date: 22.AUG.2014 19:48:46

Conducted Spurious Emission Plot between 1GHz ~ 3GHz

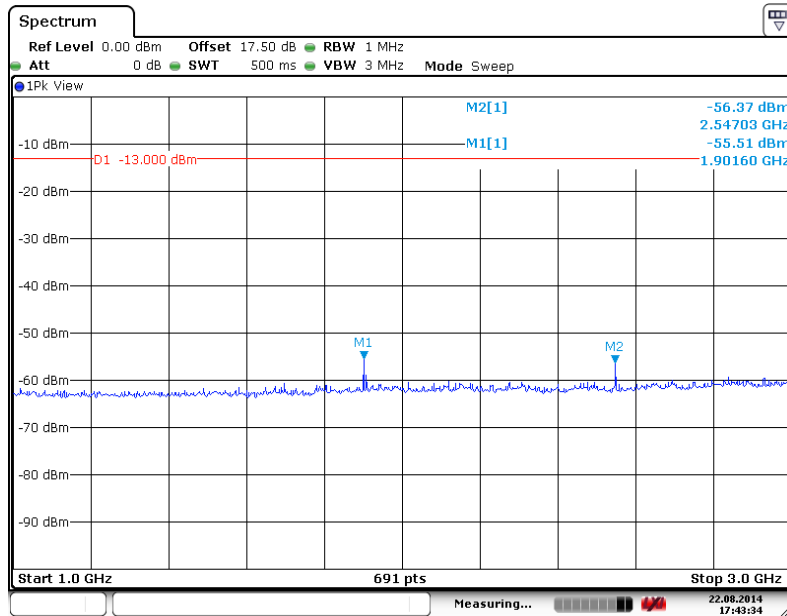

Date: 22.AUG.2014 17:43:34



Conducted Spurious Emission Plot between 3GHz ~ 7GHz

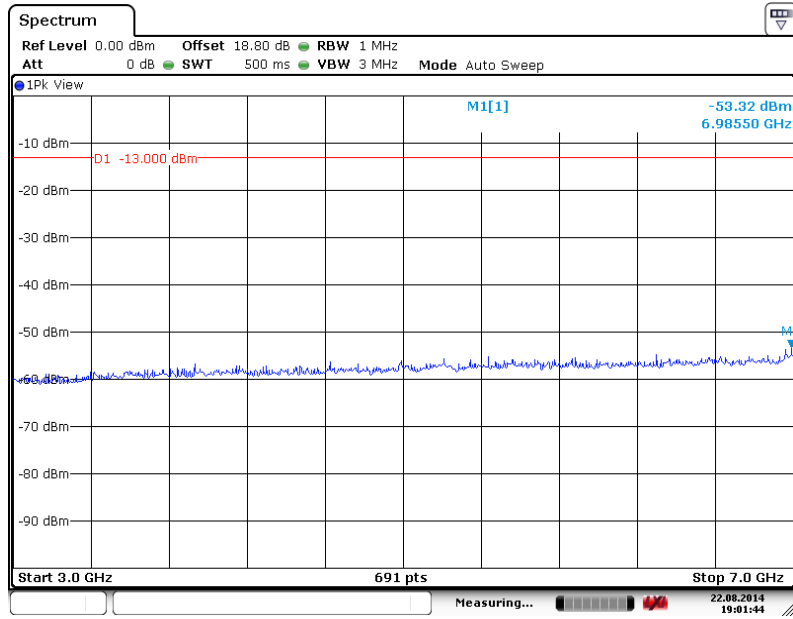

Date: 22.AUG.2014 19:01:44

Conducted Spurious Emission Plot between 7GHz ~ 9GHz

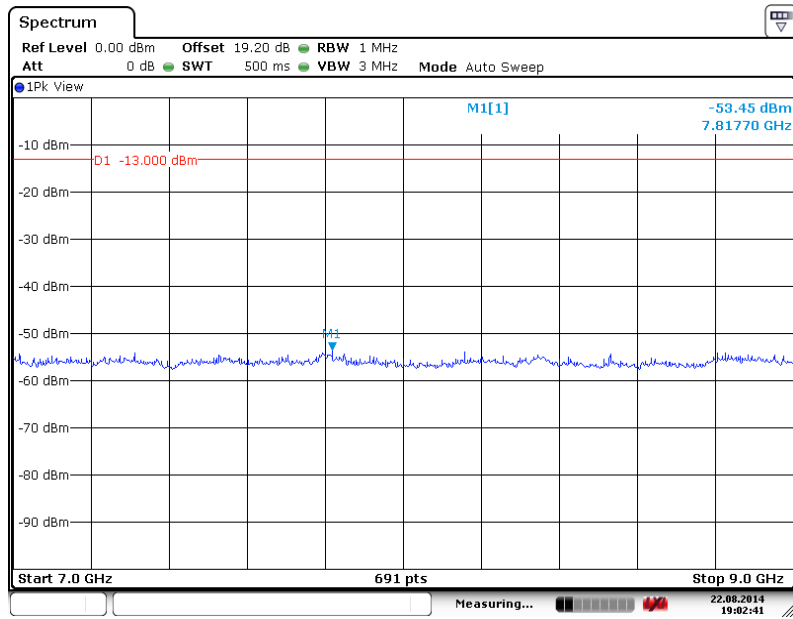

Date: 22.AUG.2014 19:02:41



Band :	GSM850	Channel :	CH189
Test Mode :	EDGE class 8 Link (8PSK)	Frequency :	836.4 MHz

Conducted Spurious Emission Plot between 30MHz ~ 1GHz

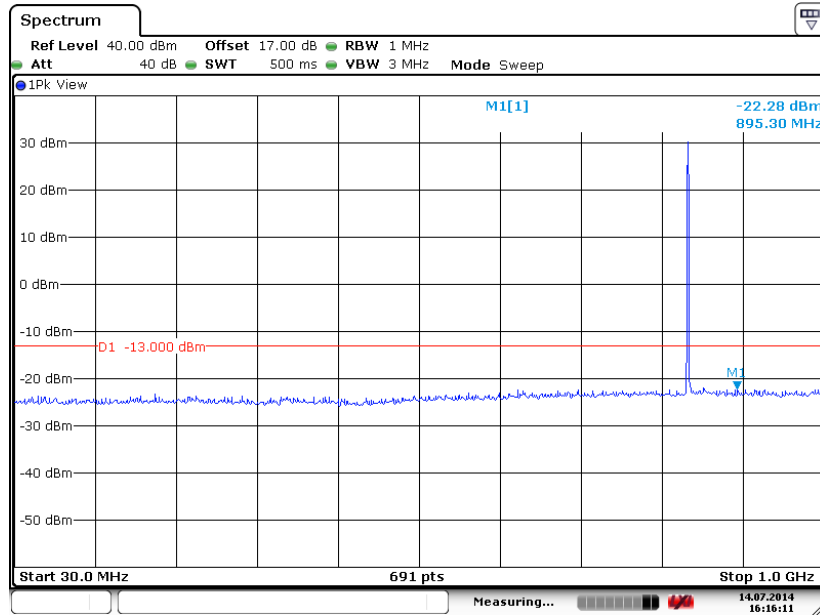

Date: 14.JUL.2014 16:16:12

Conducted Spurious Emission Plot between 1GHz ~ 3GHz

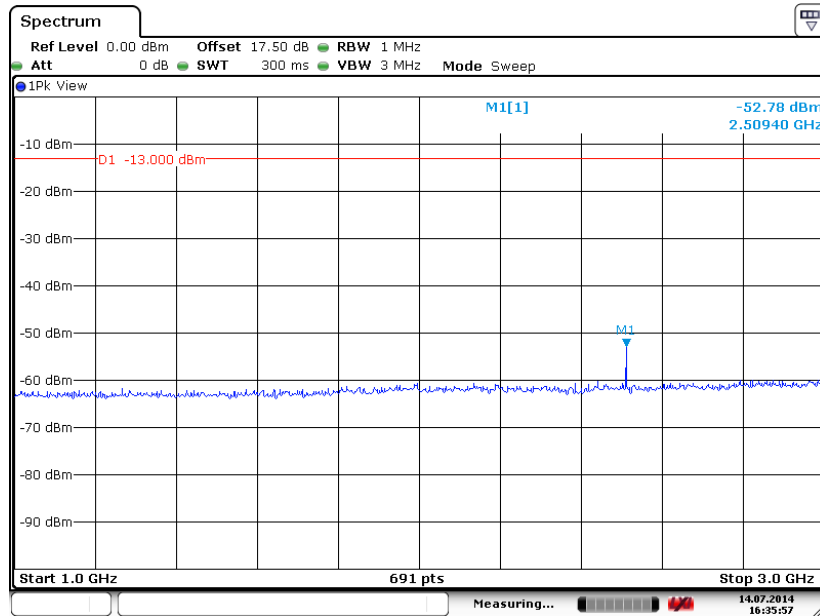

Date: 14.JUL.2014 16:35:57



Conducted Spurious Emission Plot between 3GHz ~ 7GHz

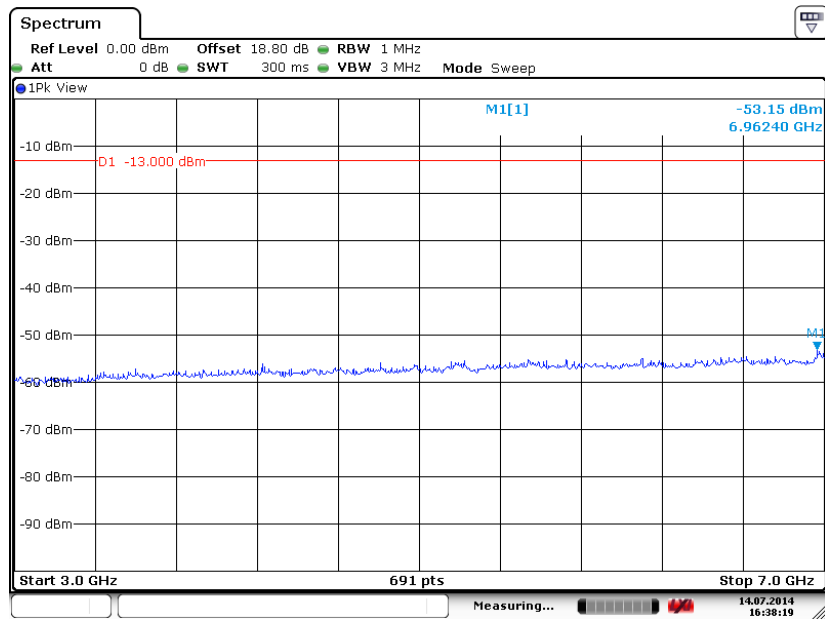

Date: 14.JUL.2014 16:38:19

Conducted Spurious Emission Plot between 7GHz ~ 9GHz

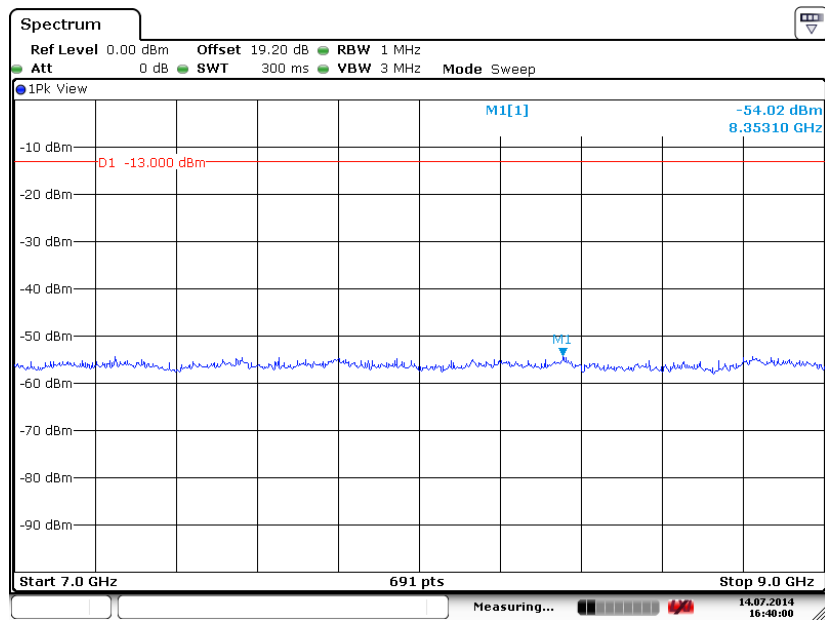

Date: 14.JUL.2014 16:40:00



Band :	GSM850	Channel :	CH251
Test Mode :	EDGE class 8 Link (8PSK)	Frequency :	848.8 MHz

Conducted Spurious Emission Plot between 30MHz ~ 1GHz

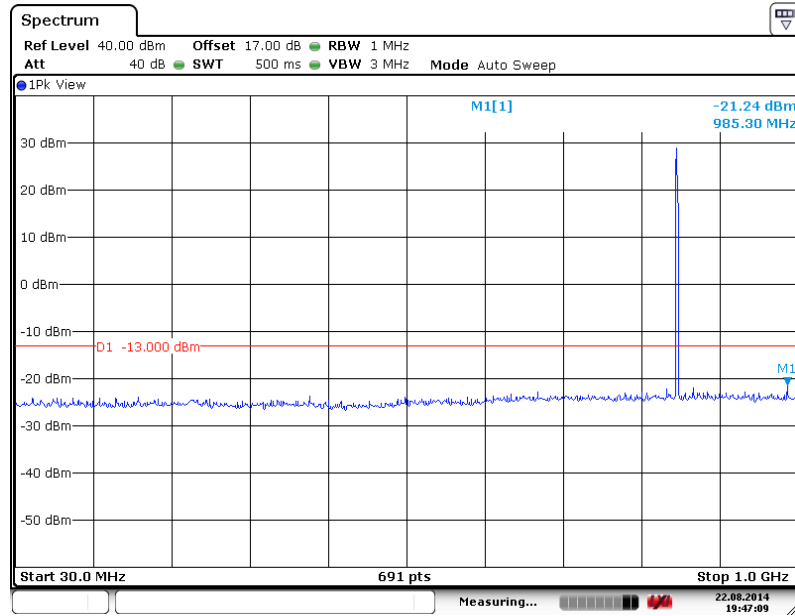

Date: 22.AUG.2014 19:47:09

Conducted Spurious Emission Plot between 1GHz ~ 3GHz

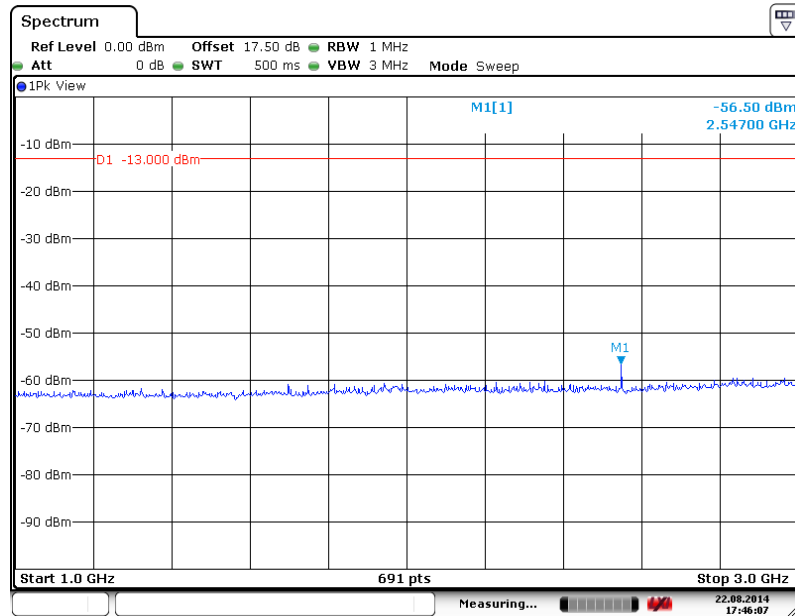

Date: 22.AUG.2014 17:46:07



Conducted Spurious Emission Plot between 3GHz ~ 7GHz

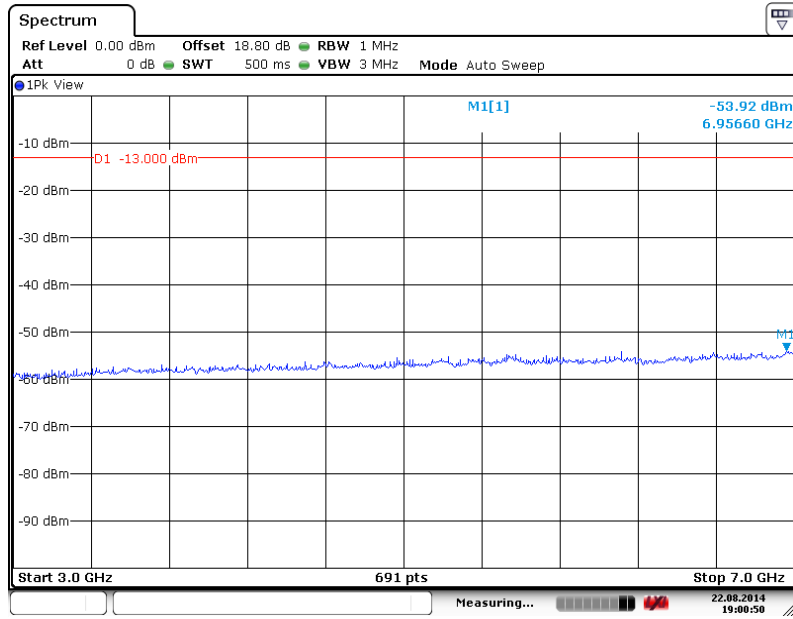

Date: 22.AUG.2014 19:00:50

Conducted Spurious Emission Plot between 7GHz ~ 9GHz

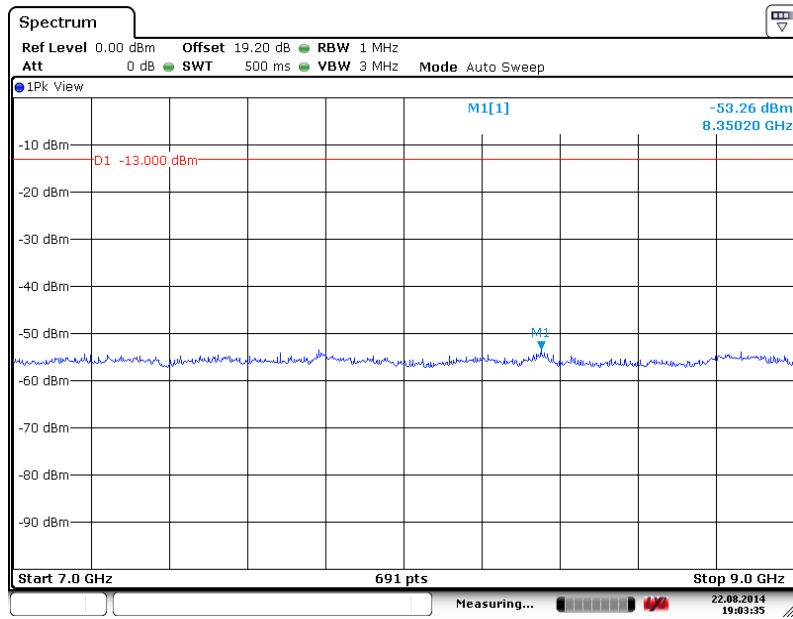

Date: 22.AUG.2014 19:03:35



Band :	GSM1900	Channel :	CH512
Test Mode :	GPRS class 8 Link (GMSK)	Frequency :	1850.2 MHz

Conducted Spurious Emission Plot between 30MHz ~ 1GHz

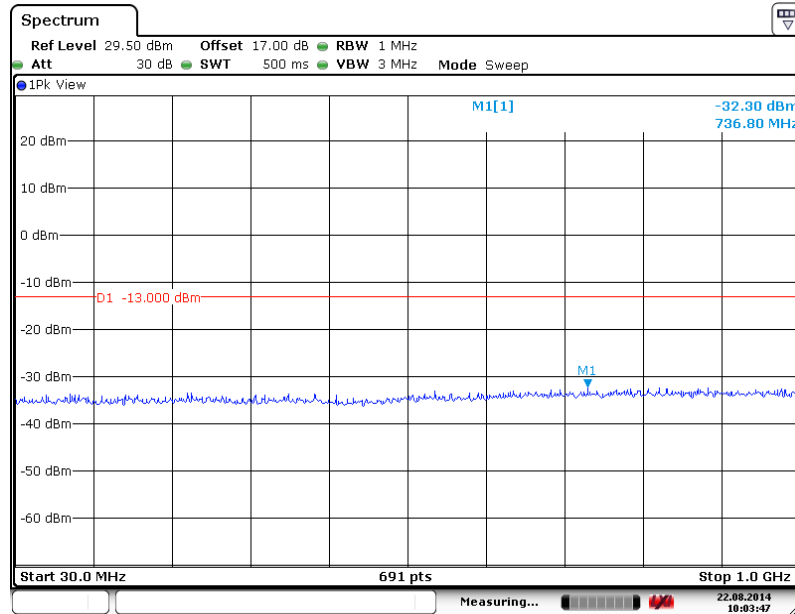

Date: 22.AUG.2014 10:03:47

Conducted Spurious Emission Plot between 1GHz ~ 3GHz

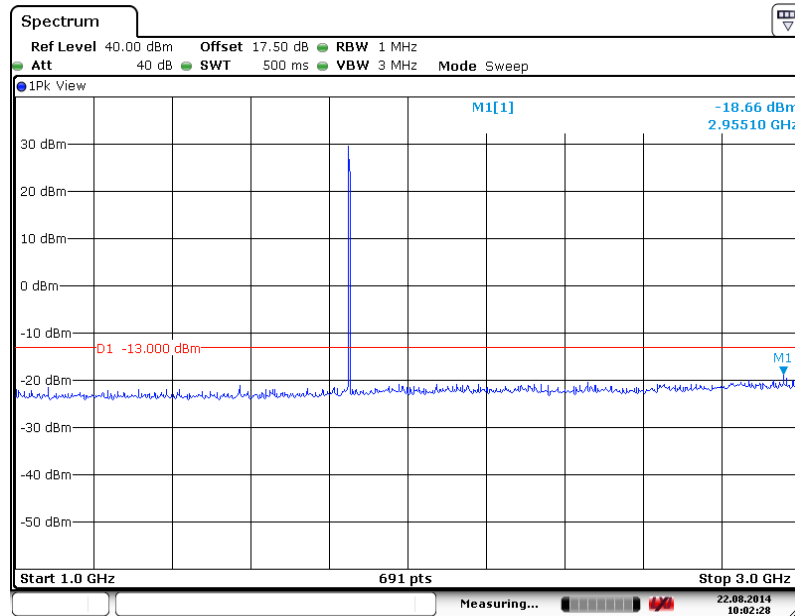

Date: 22.AUG.2014 10:02:28



Conducted Spurious Emission Plot between 3GHz ~ 7GHz

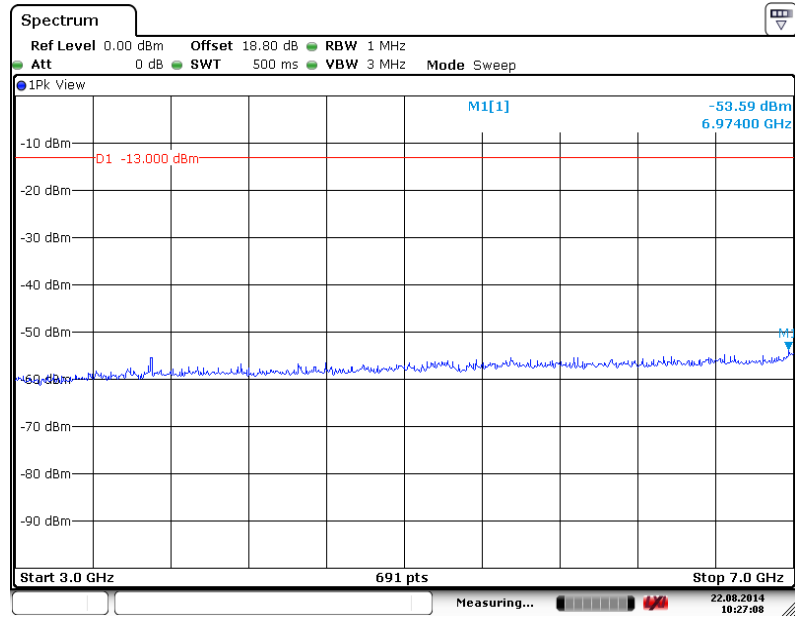

Date: 22.AUG.2014 10:27:08

Conducted Spurious Emission Plot between 7GHz ~ 13.6GHz

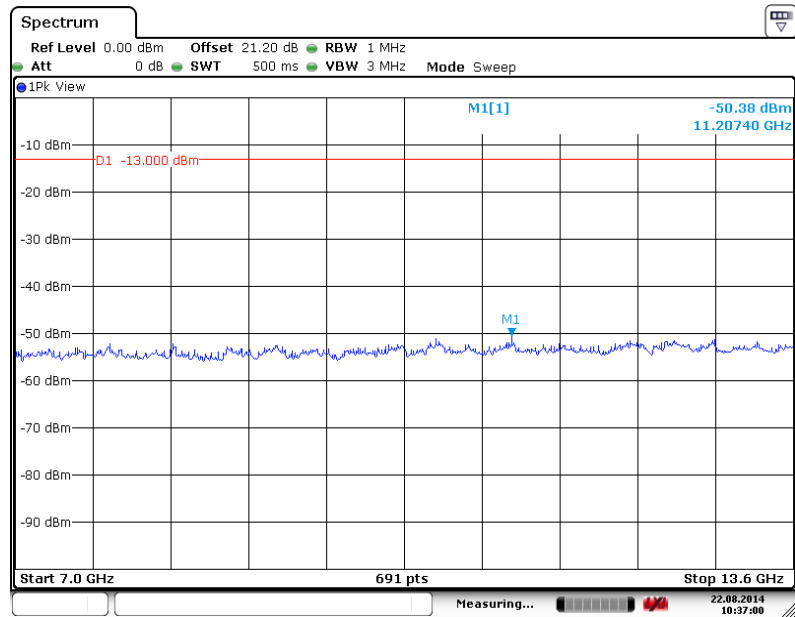

Date: 22.AUG.2014 10:37:00



Conducted Spurious Emission Plot between 13.6GHz ~ 19.1GHz

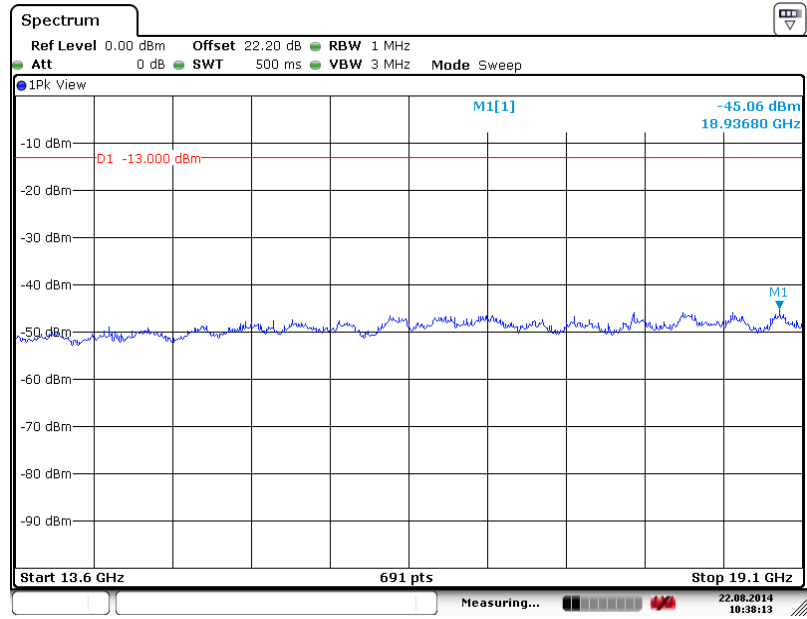

Date: 22.AUG.2014 10:38:13



Band :	GSM1900	Channel :	CH661
Test Mode :	GPRS class 8 Link (GMSK)	Frequency :	1880.0 MHz

Conducted Spurious Emission Plot between 30MHz ~ 1GHz

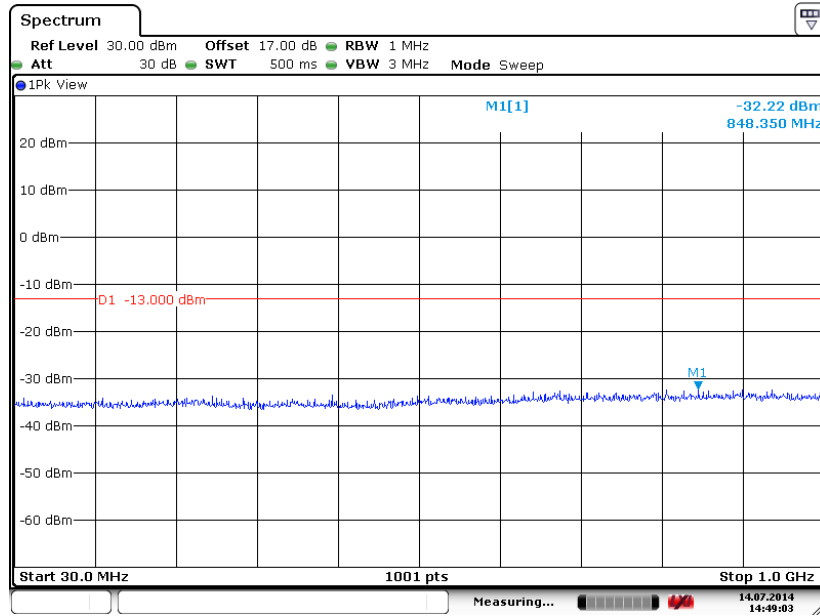

Date: 14.JUL.2014 14:49:03

Conducted Spurious Emission Plot between 1GHz ~ 3GHz

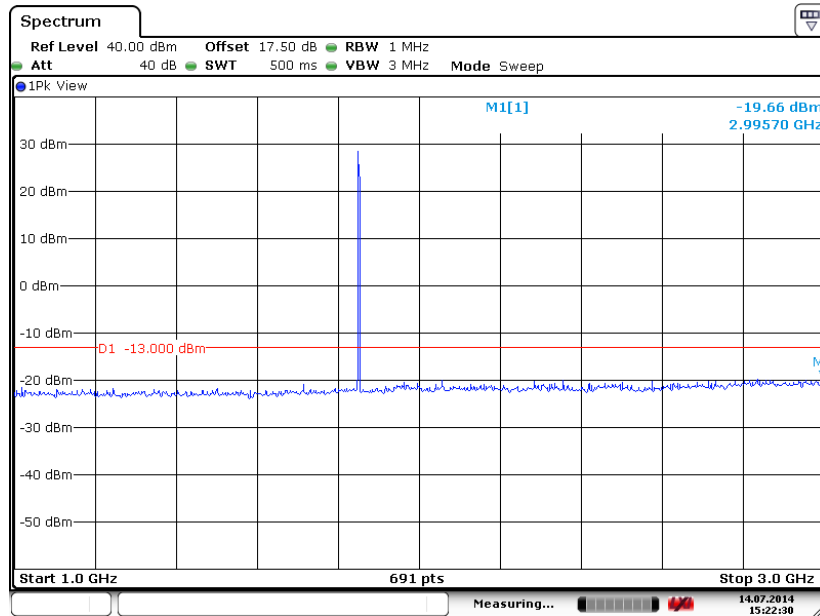

Date: 14.JUL.2014 15:22:30



Conducted Spurious Emission Plot between 3GHz ~ 7GHz

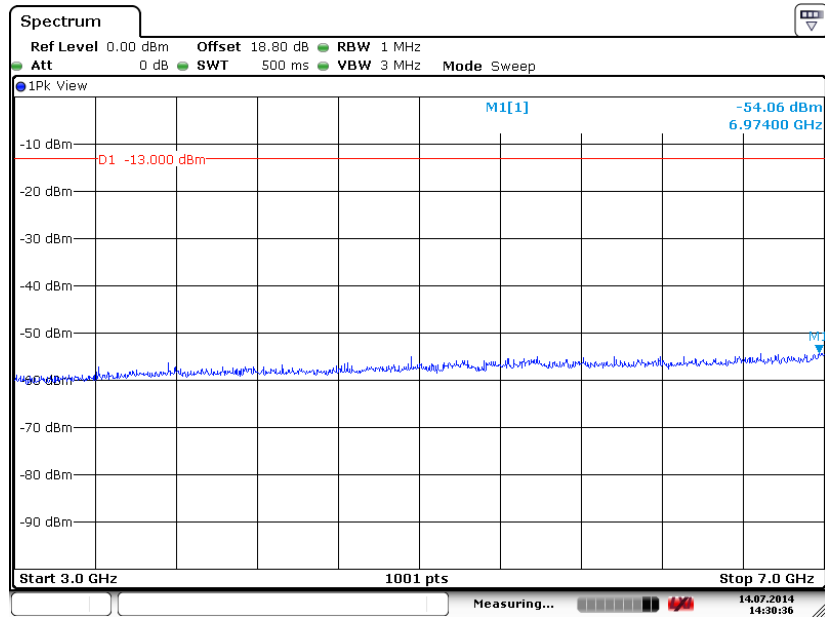

Date: 14.JUL.2014 14:30:36

Conducted Spurious Emission Plot between 7GHz ~ 13.6GHz

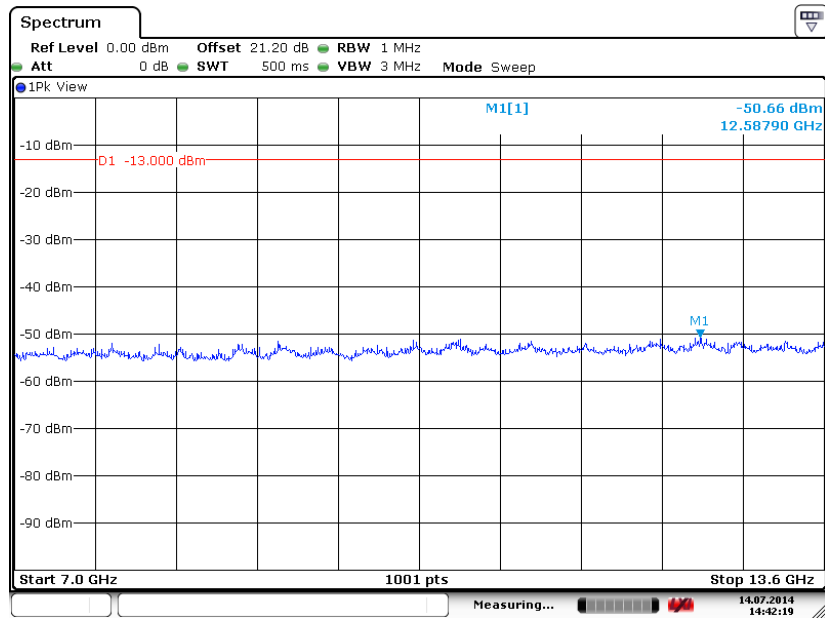

Date: 14.JUL.2014 14:42:19



Conducted Spurious Emission Plot between 13.6GHz ~ 19.1GHz

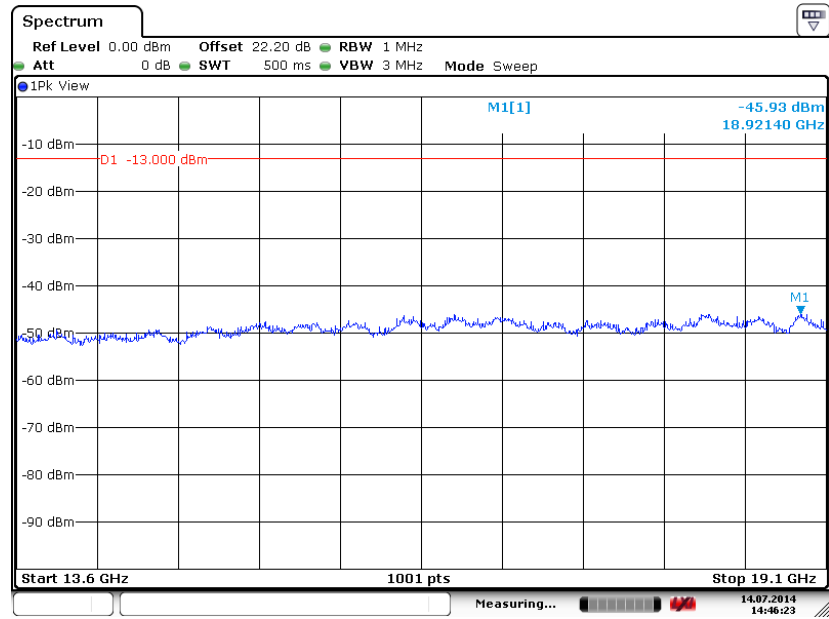

Date: 14.JUL.2014 14:46:23



Band :	GSM1900	Channel :	CH810
Test Mode :	GPRS class 8 Link (GMSK)	Frequency :	1909.8 MHz

Conducted Spurious Emission Plot between 30MHz ~ 1GHz

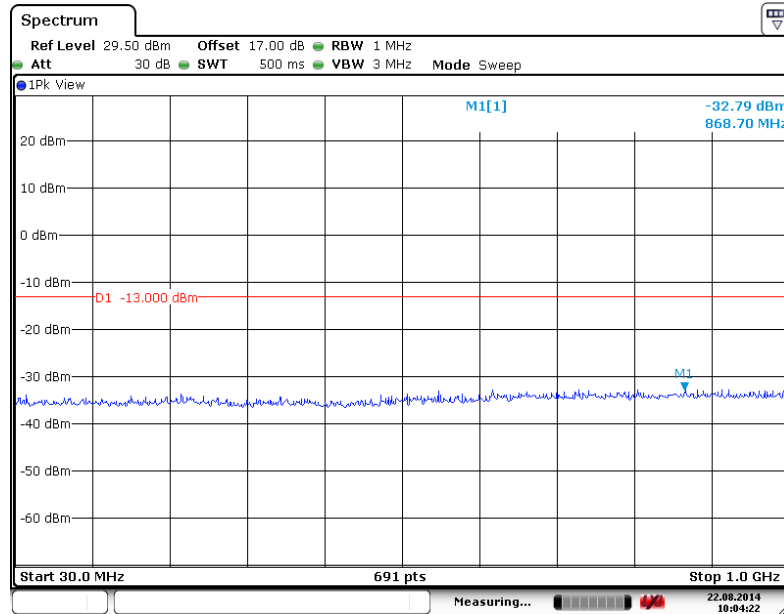

Date: 22.AUG.2014 10:04:22

Conducted Spurious Emission Plot between 1GHz ~ 3GHz

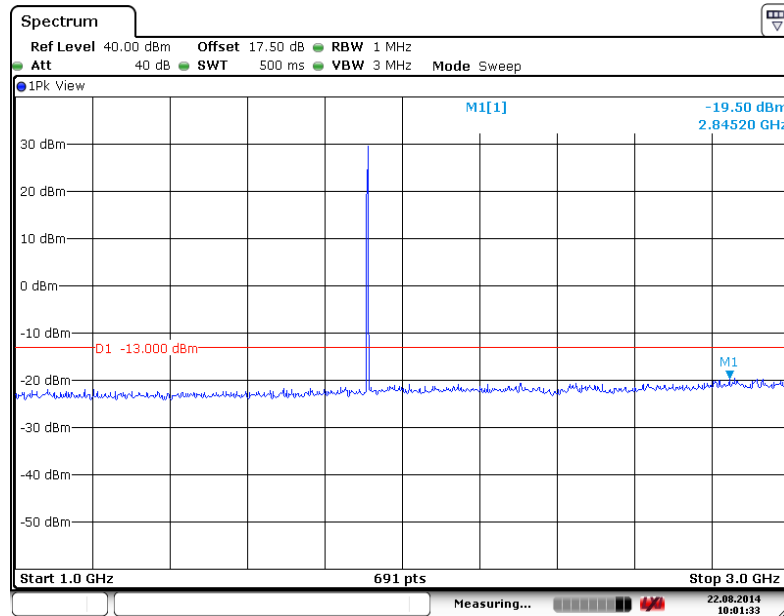

Date: 22.AUG.2014 10:01:33



Conducted Spurious Emission Plot between 3GHz ~ 7GHz

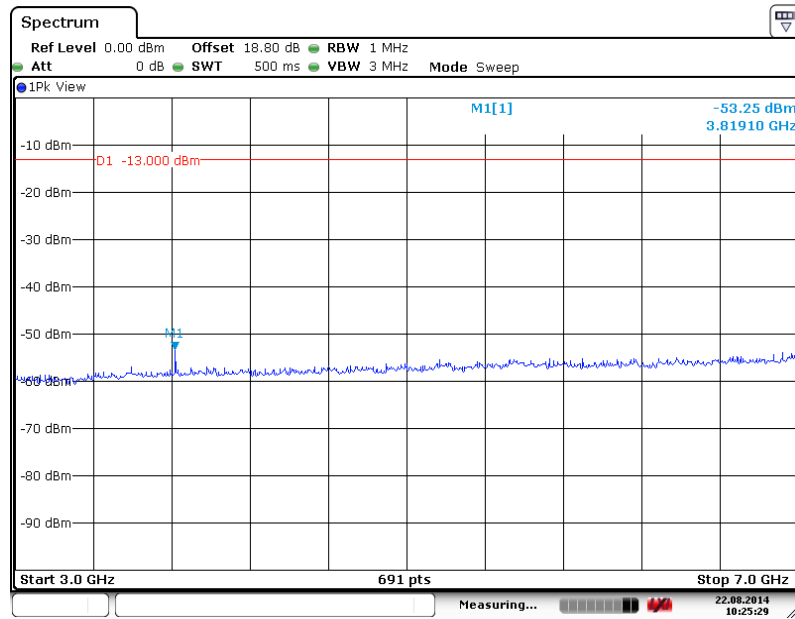

Date: 22.AUG.2014 10:25:29

Conducted Spurious Emission Plot between 7GHz ~ 13.6GHz

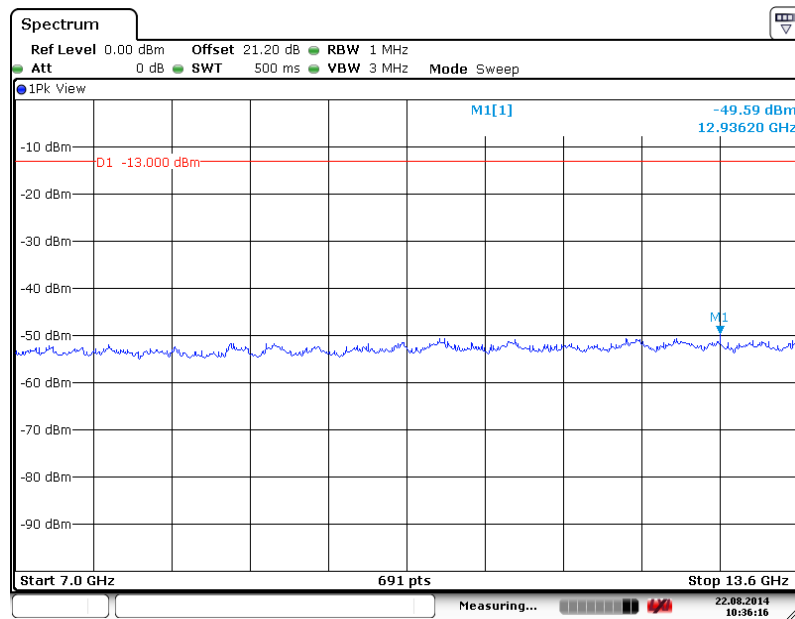

Date: 22.AUG.2014 10:36:16



Conducted Spurious Emission Plot between 13.6GHz ~ 19.1GHz

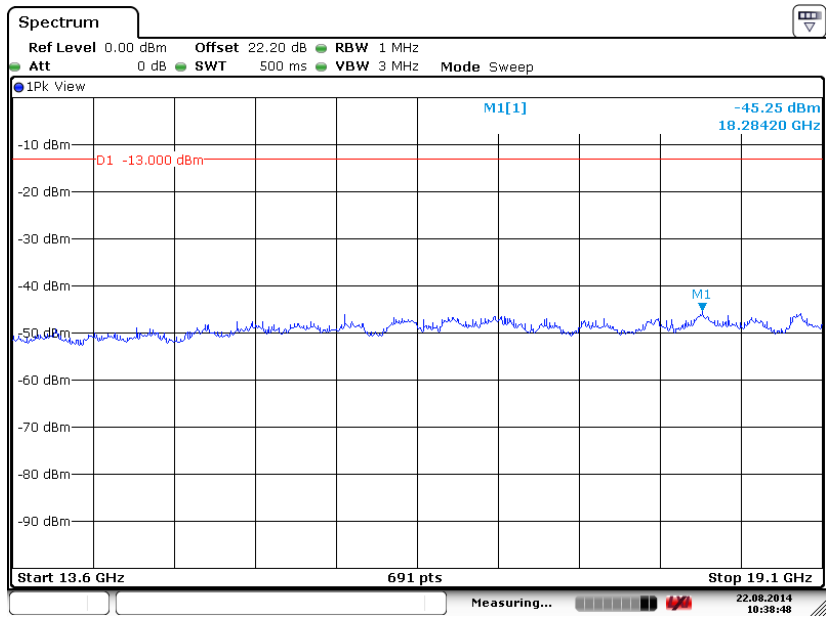

Date: 22.AUG.2014 10:38:48



Band :	GSM1900	Channel :	CH512
Test Mode :	EDGE class 8 Link (8PSK)	Frequency :	1850.2 MHz

Conducted Spurious Emission Plot between 30MHz ~ 1GHz

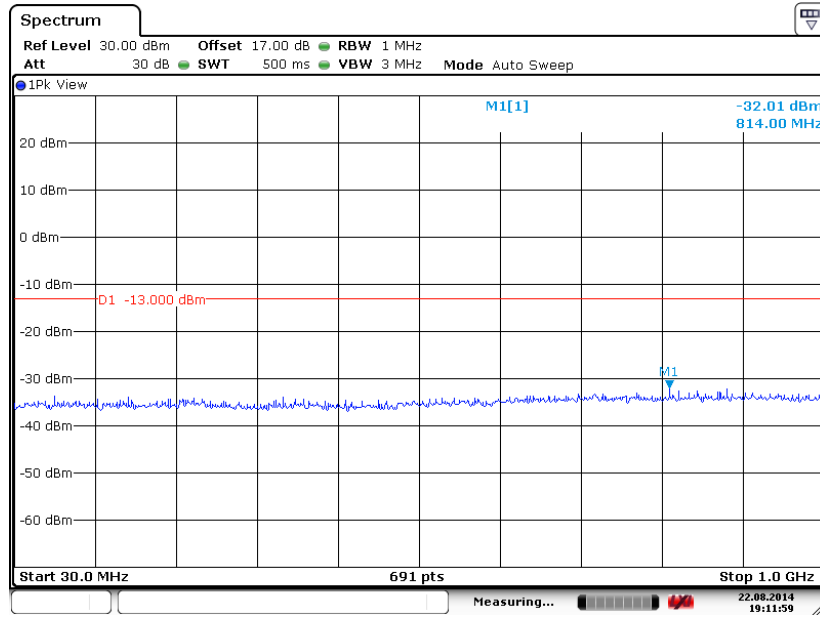

Date: 22.AUG.2014 19:11:59

Conducted Spurious Emission Plot between 1GHz ~ 3GHz

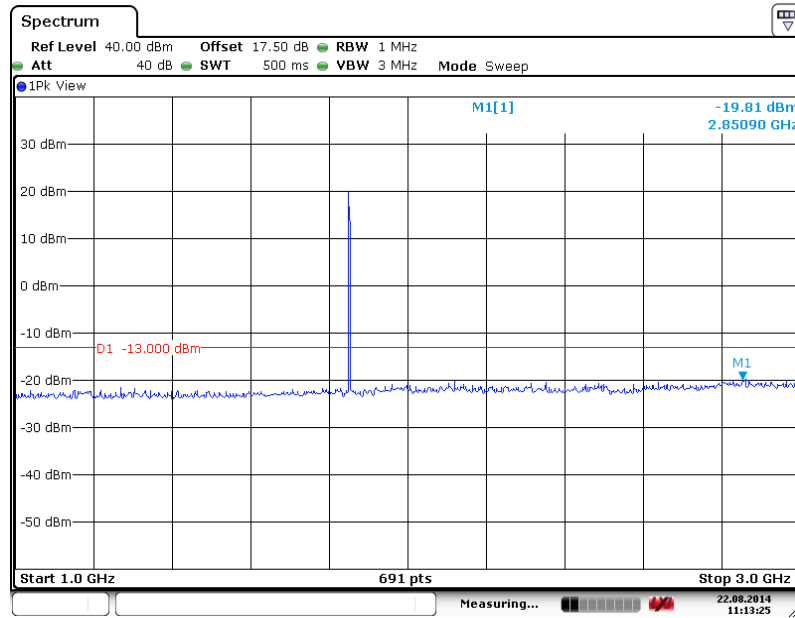

Date: 22.AUG.2014 11:13:25



Conducted Spurious Emission Plot between 3GHz ~ 7GHz

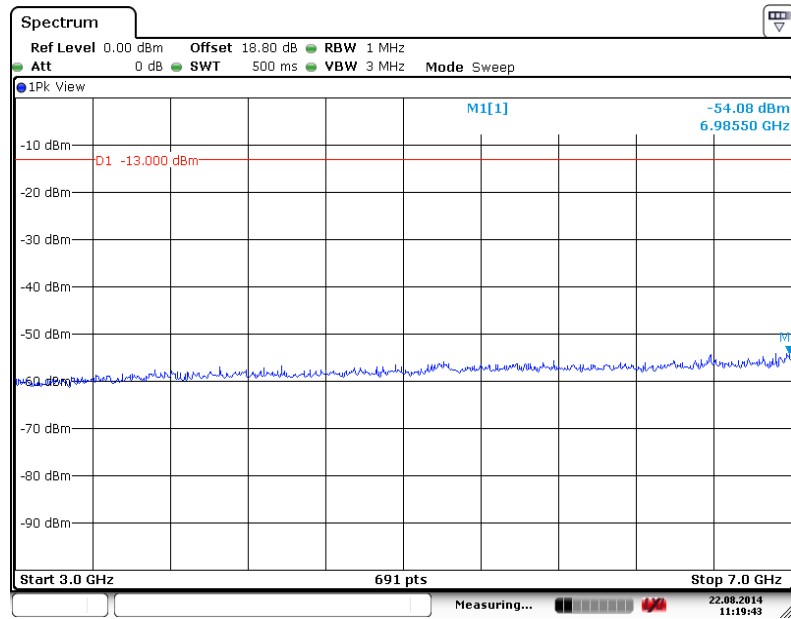

Date: 22.AUG.2014 11:19:43

Conducted Spurious Emission Plot between 7GHz ~ 13.6GHz

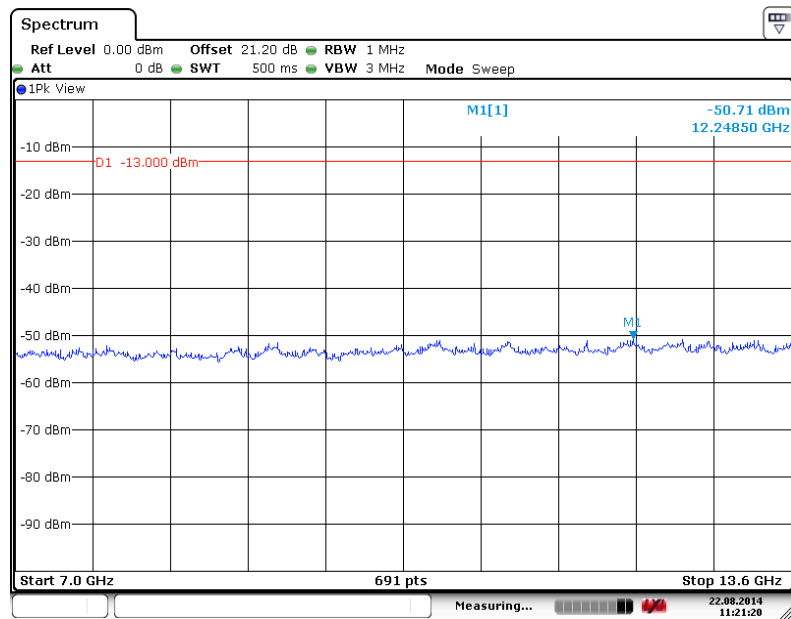

Date: 22.AUG.2014 11:21:20



Conducted Spurious Emission Plot between 13.6GHz ~ 19.1GHz

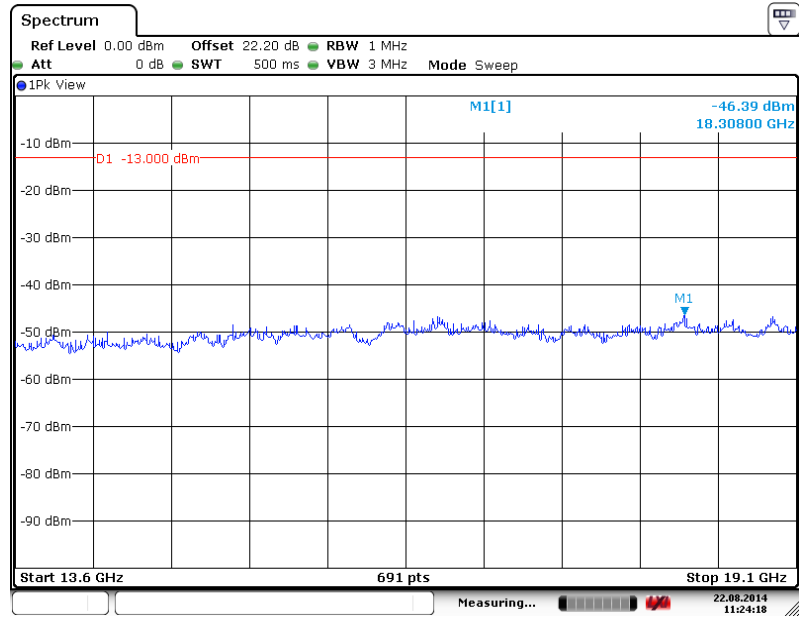

Date: 22.AUG.2014 11:24:17



Band :	GSM1900	Channel :	CH661
Test Mode :	EDGE class 8 Link (8PSK)	Frequency :	1880.0 MHz

Conducted Spurious Emission Plot between 30MHz ~ 1GHz

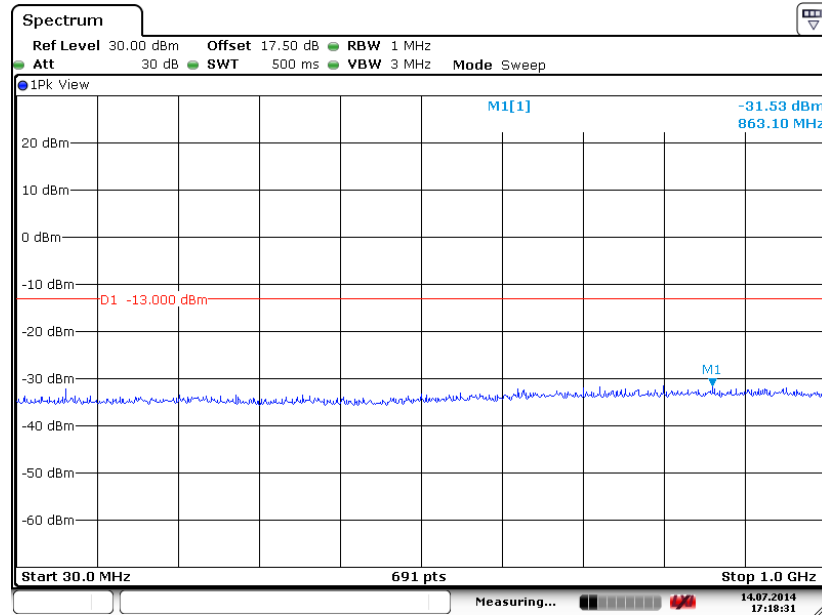

Date: 14.JUL.2014 17:18:32

Conducted Spurious Emission Plot between 1GHz ~ 3GHz

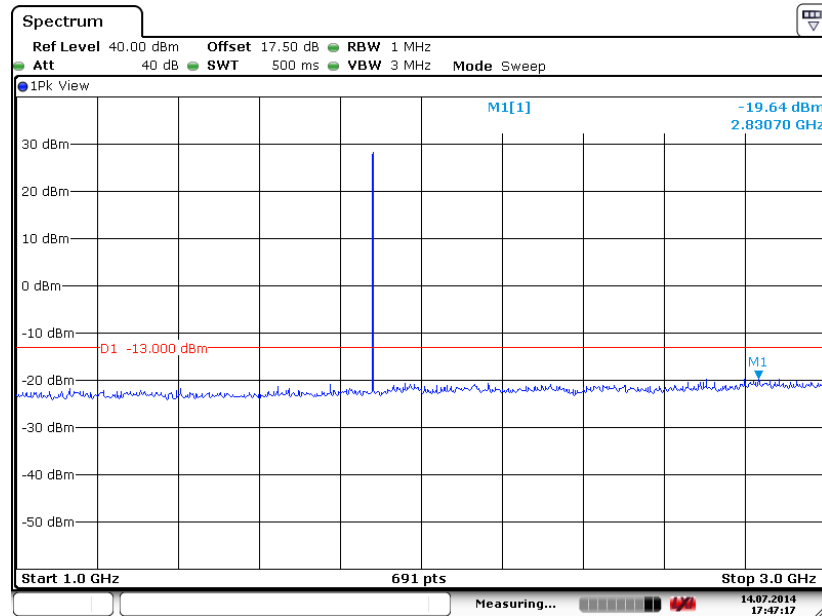

Date: 14.JUL.2014 17:47:17



Conducted Spurious Emission Plot between 3GHz ~ 7GHz

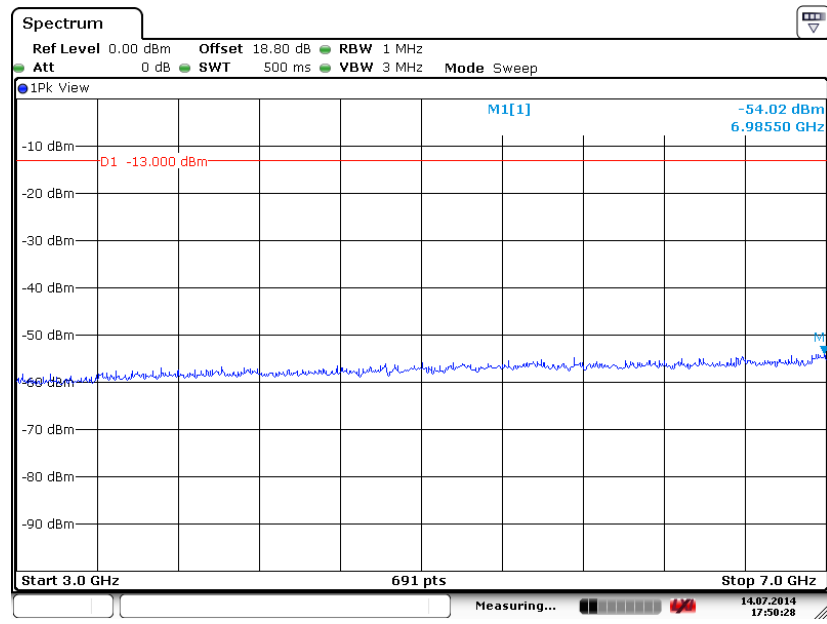

Date: 14.JUL.2014 17:50:29

Conducted Spurious Emission Plot between 7GHz ~ 13.6GHz

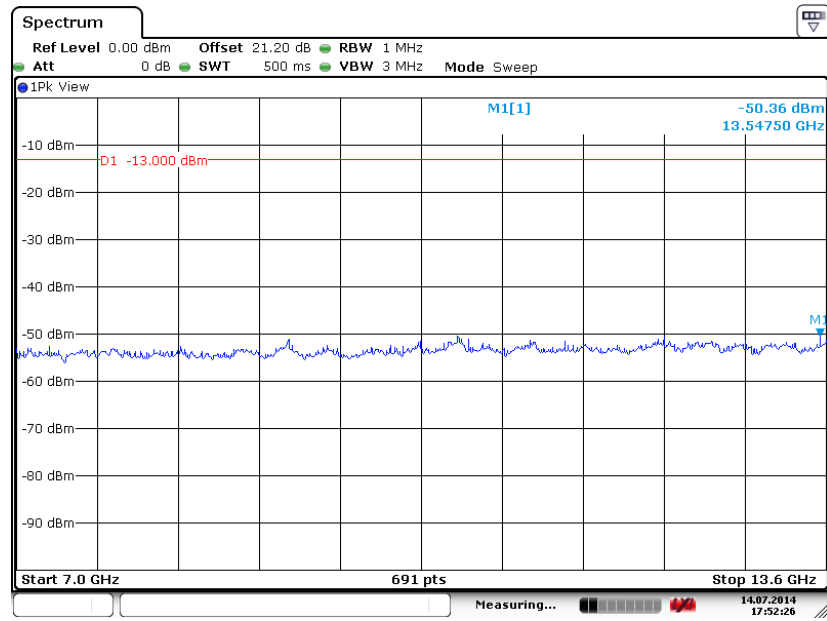

Date: 14.JUL.2014 17:52:27



Conducted Spurious Emission Plot between 13.6GHz ~ 19.1GHz

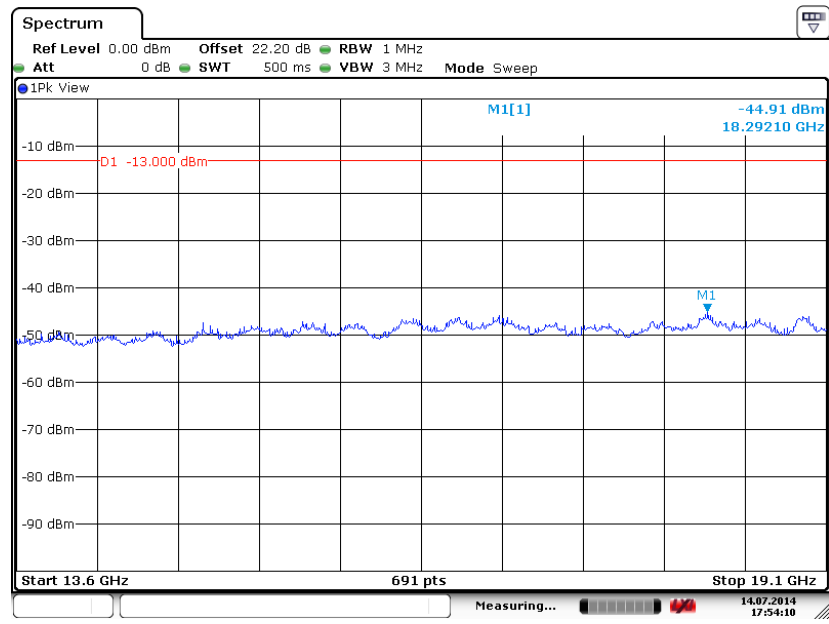

Date: 14.JUL.2014 17:54:11



Band :	GSM1900	Channel :	CH810
Test Mode :	EDGE class 8 Link (8PSK)	Frequency :	1909.8 MHz

Conducted Spurious Emission Plot between 30MHz ~ 1GHz

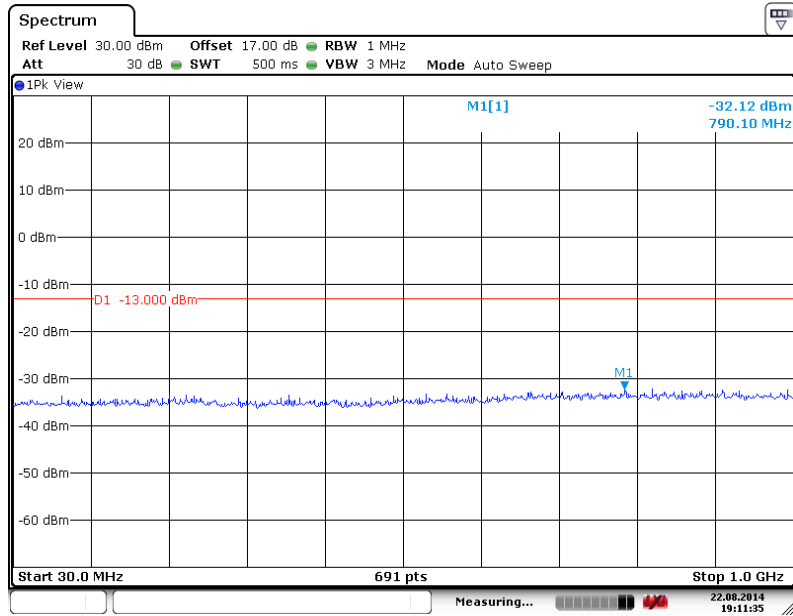

Date: 22.AUG.2014 19:11:35

Conducted Spurious Emission Plot between 1GHz ~ 3GHz

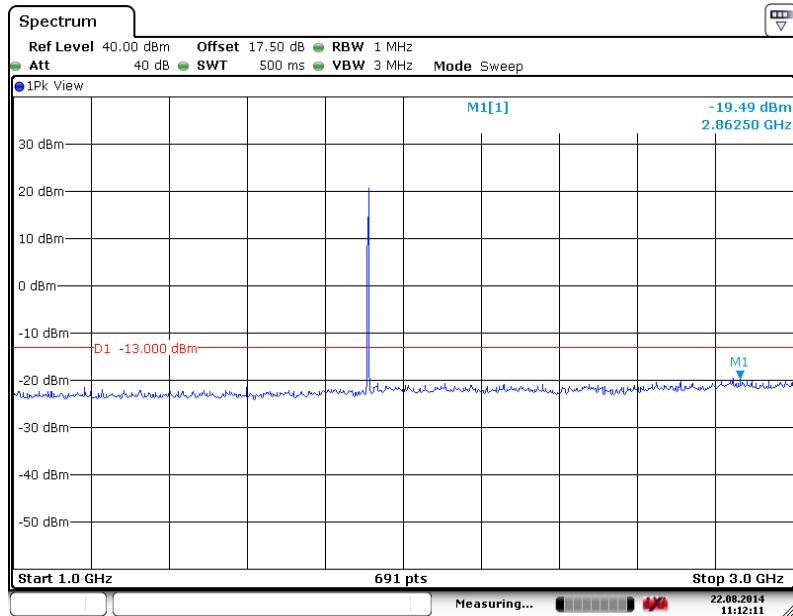

Date: 22.AUG.2014 11:12:11



Conducted Spurious Emission Plot between 3GHz ~ 7GHz

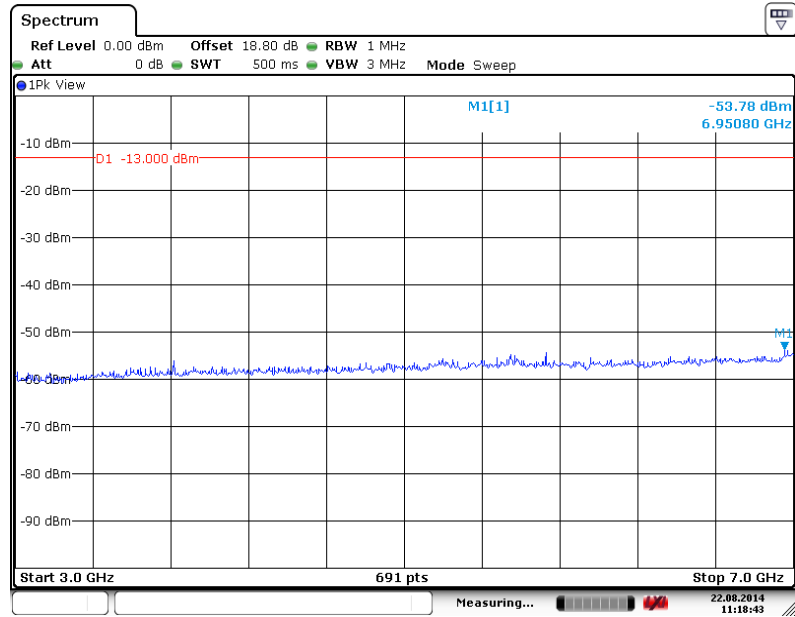

Date: 22.AUG.2014 11:18:43

Conducted Spurious Emission Plot between 7GHz ~ 13.6GHz

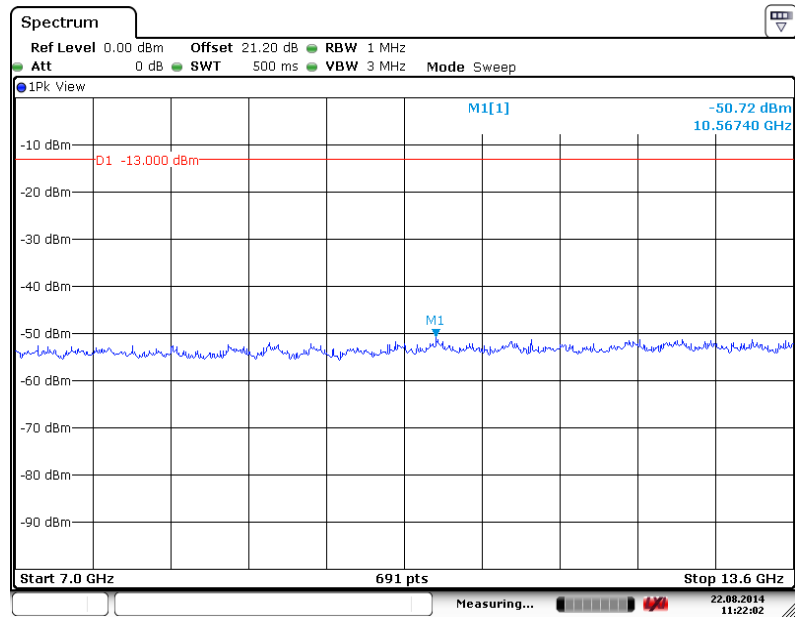

Date: 22.AUG.2014 11:22:02



Conducted Spurious Emission Plot between 13.6GHz ~ 19.1GHz

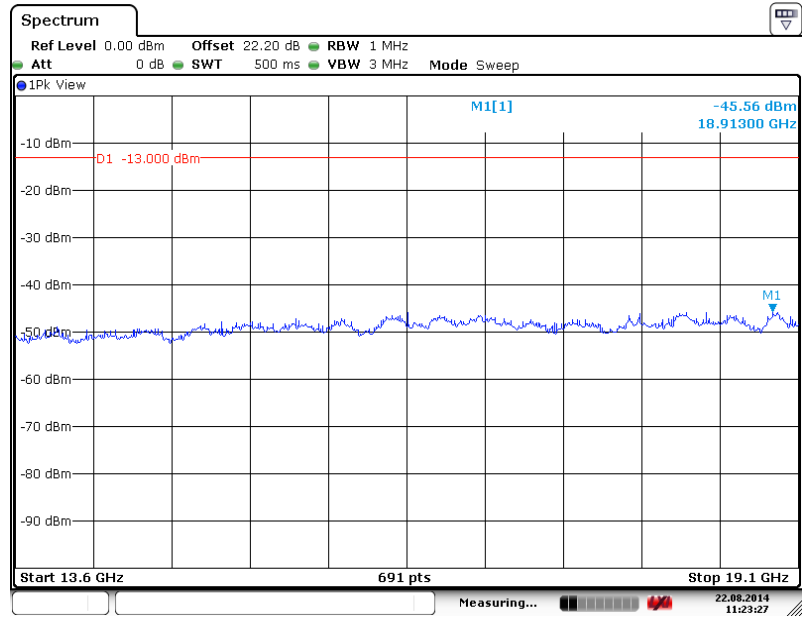

Date: 22.AUG.2014 11:23:27



Band :	WCDMA Band V	Channel :	CH4132
Test Mode :	RMC 12.2Kbps Link (QPSK)	Frequency :	826.4 MHz

Conducted Spurious Emission Plot between 30MHz ~ 1GHz

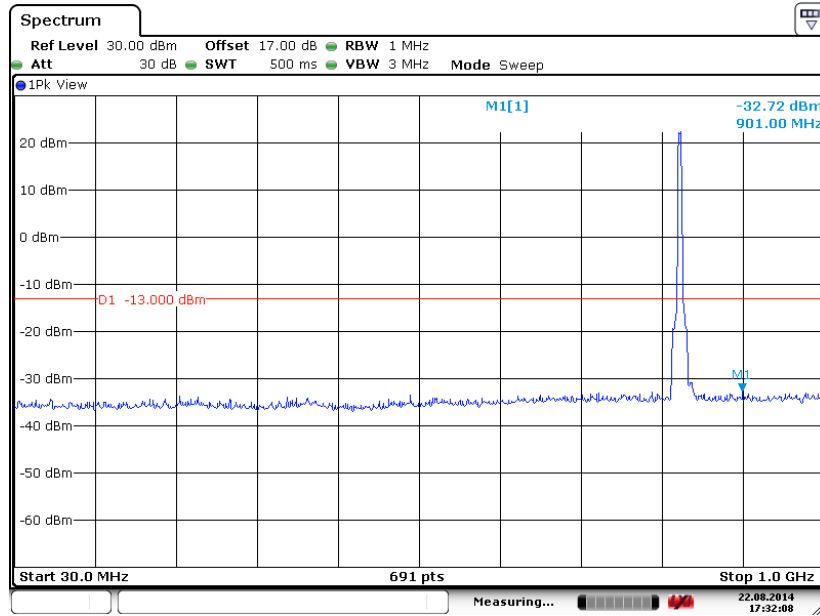

Date: 22.AUG.2014 17:32:07

Conducted Spurious Emission Plot between 1GHz ~ 3GHz

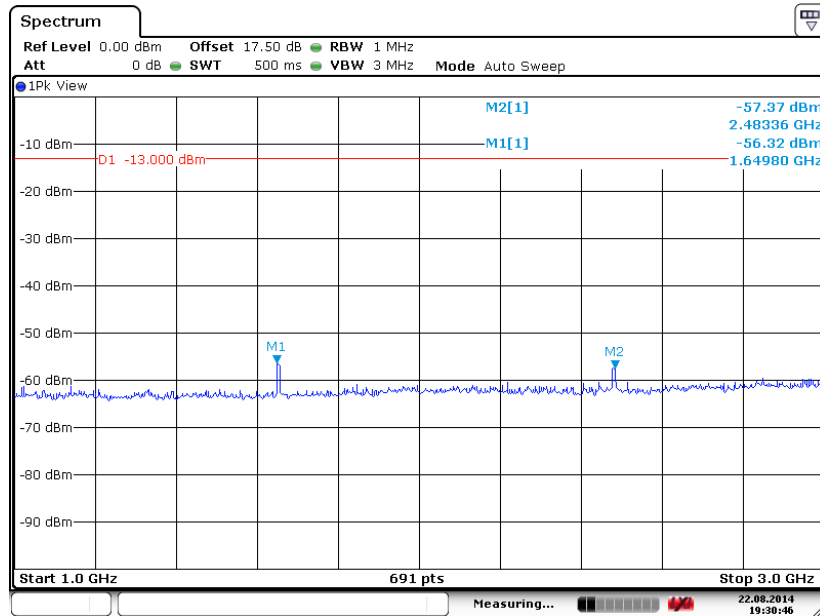

Date: 22.AUG.2014 19:30:46



Conducted Spurious Emission Plot between 3GHz ~ 7GHz

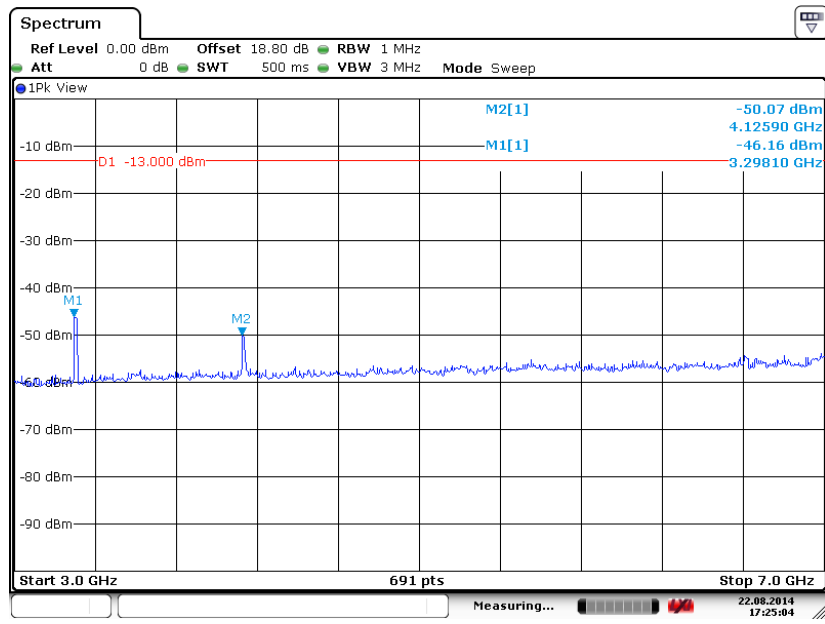

Conducted Spurious Emission Plot between 7GHz ~ 9GHz

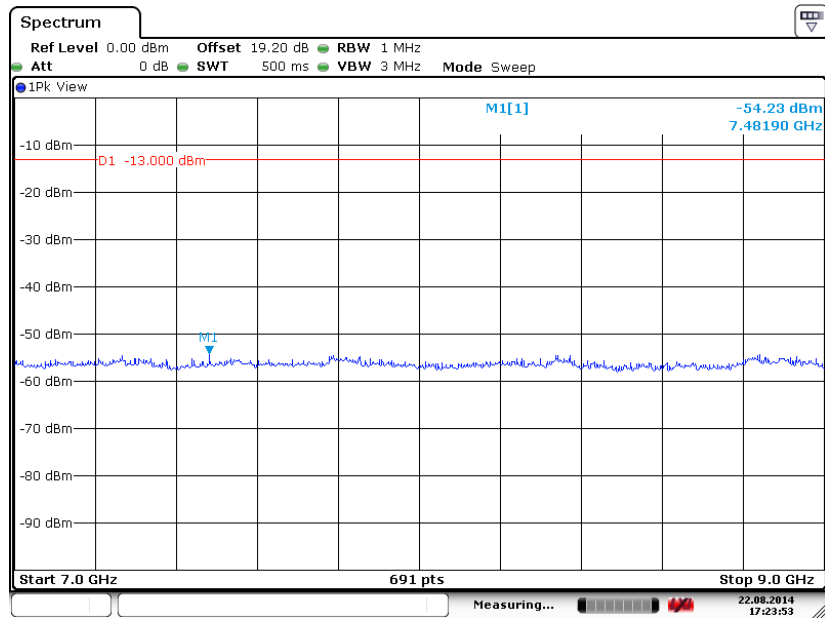



Band :	WCDMA Band V	Channel :	CH4182
Test Mode :	RMC 12.2Kbps Link (QPSK)	Frequency :	836.4 MHz

Conducted Spurious Emission Plot between 30MHz ~ 1GHz

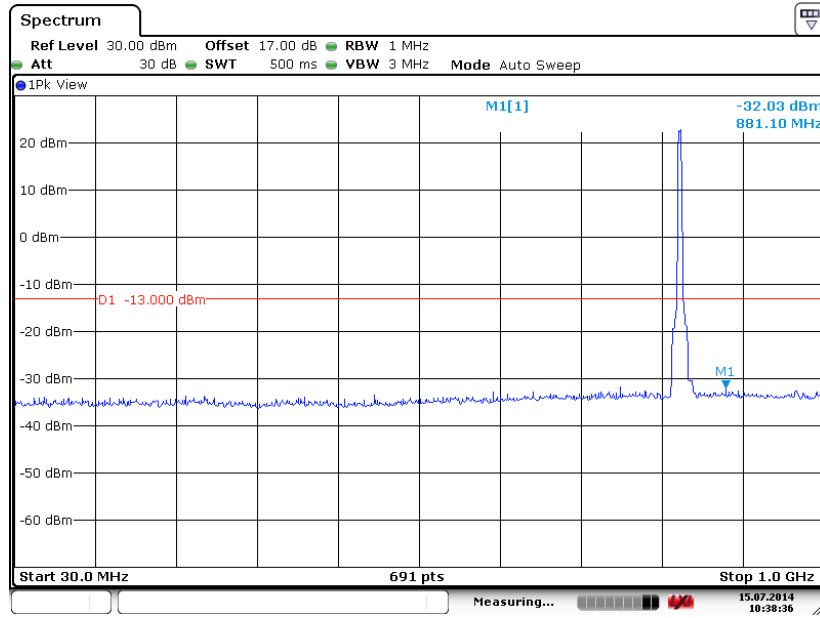

Date: 15.JUL.2014 10:38:36

Conducted Spurious Emission Plot between 1GHz ~ 3GHz

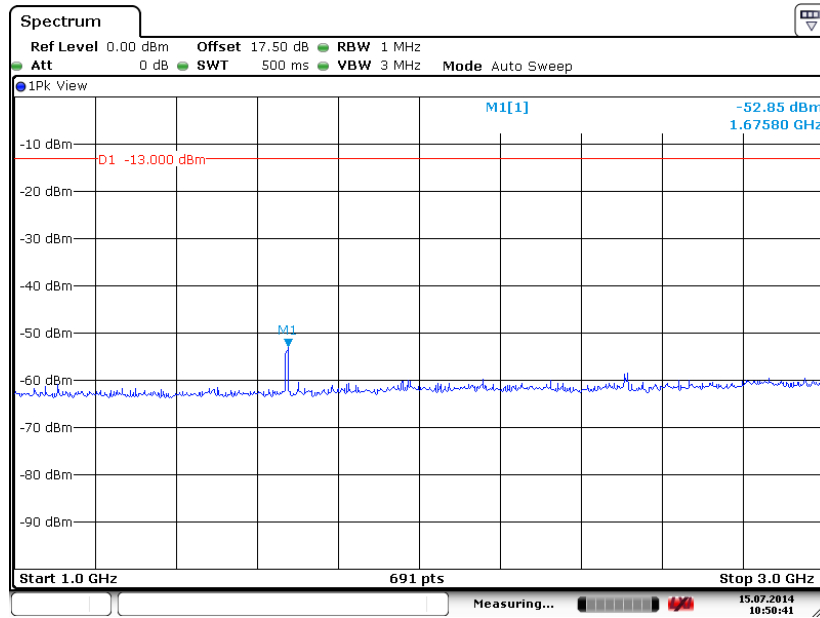

Date: 15.JUL.2014 10:50:41



Conducted Spurious Emission Plot between 3GHz ~ 7GHz

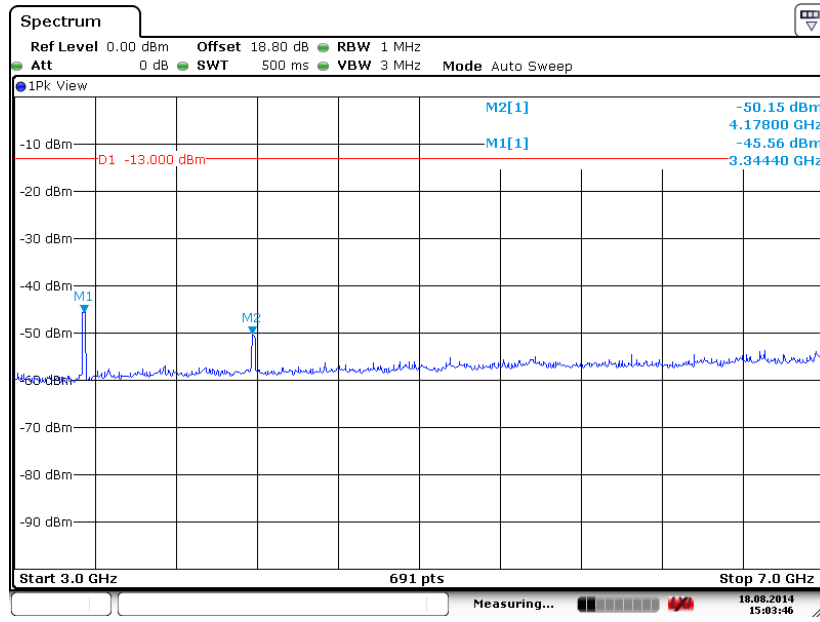

Date: 18.AUG.2014 15:03:46

Conducted Spurious Emission Plot between 7GHz ~ 9GHz

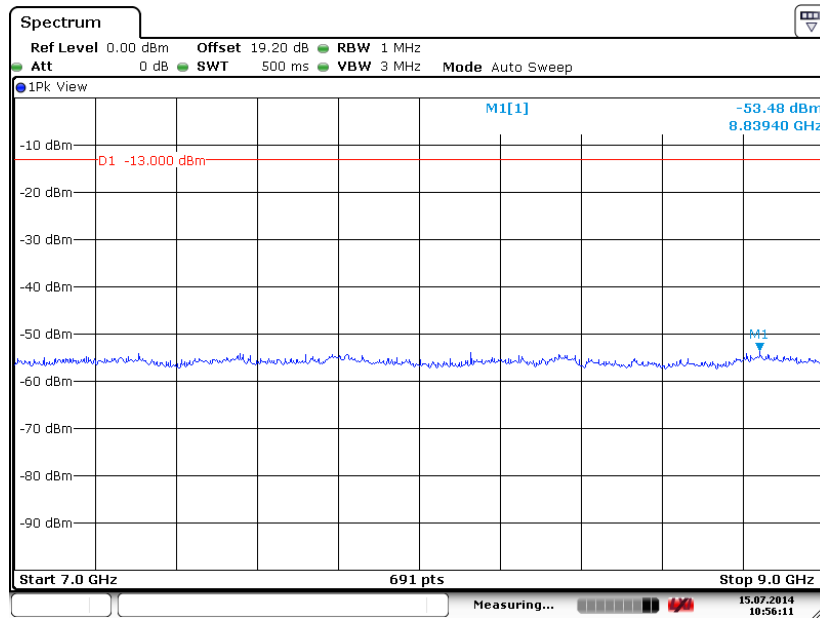

Date: 15.JUL.2014 10:56:11



Band :	WCDMA Band V	Channel :	CH4233
Test Mode :	RMC 12.2Kbps Link (QPSK)	Frequency :	846.6 MHz

Conducted Spurious Emission Plot between 30MHz ~ 1GHz

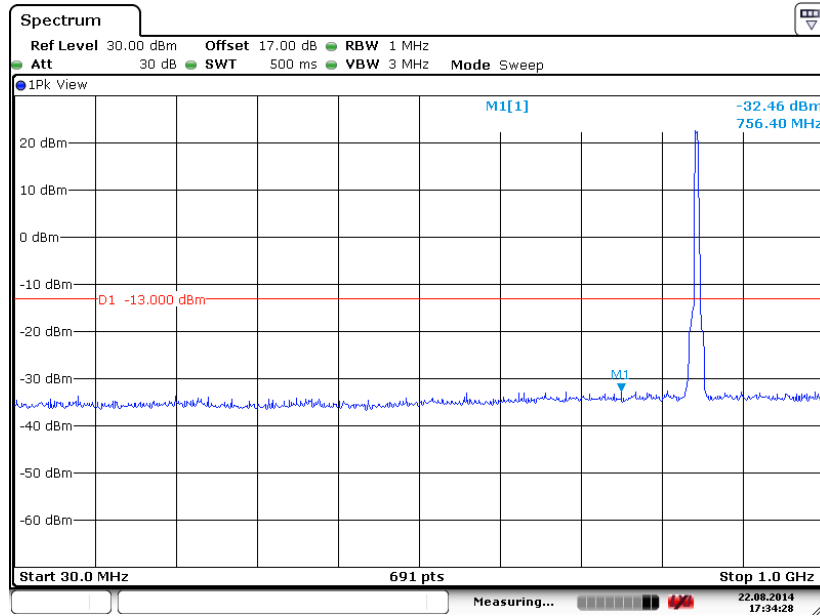

Date: 22.AUG.2014 17:34:27

Conducted Spurious Emission Plot between 1GHz ~ 3GHz

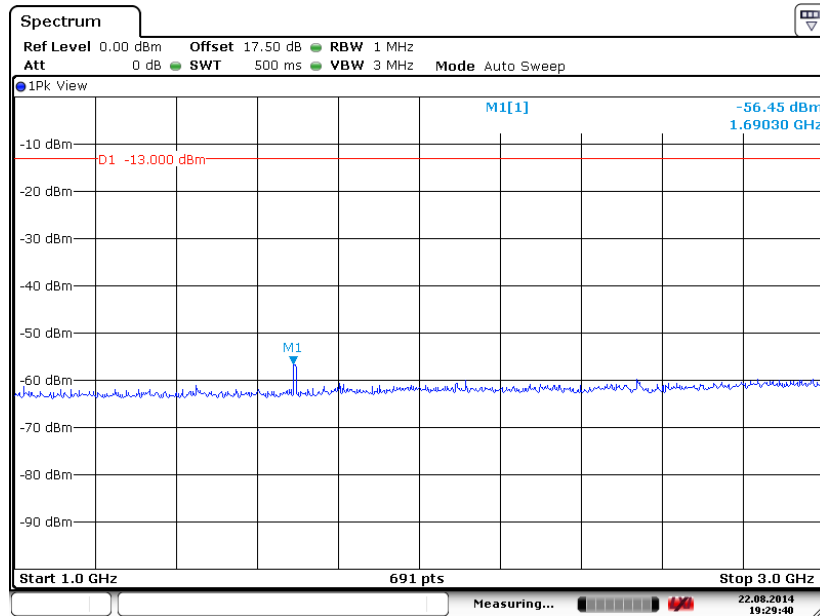

Date: 22.AUG.2014 19:29:39



Conducted Spurious Emission Plot between 3GHz ~ 7GHz

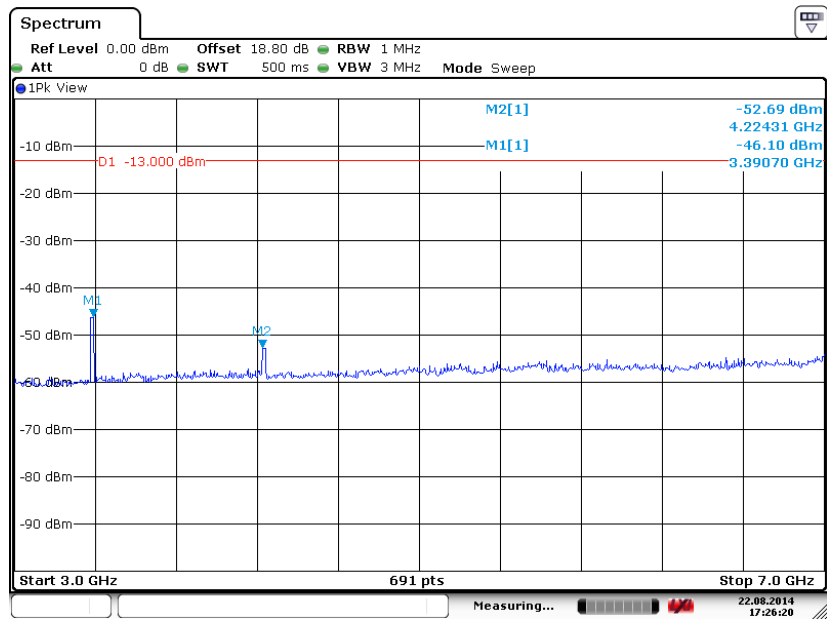

Conducted Spurious Emission Plot between 7GHz ~ 9GHz

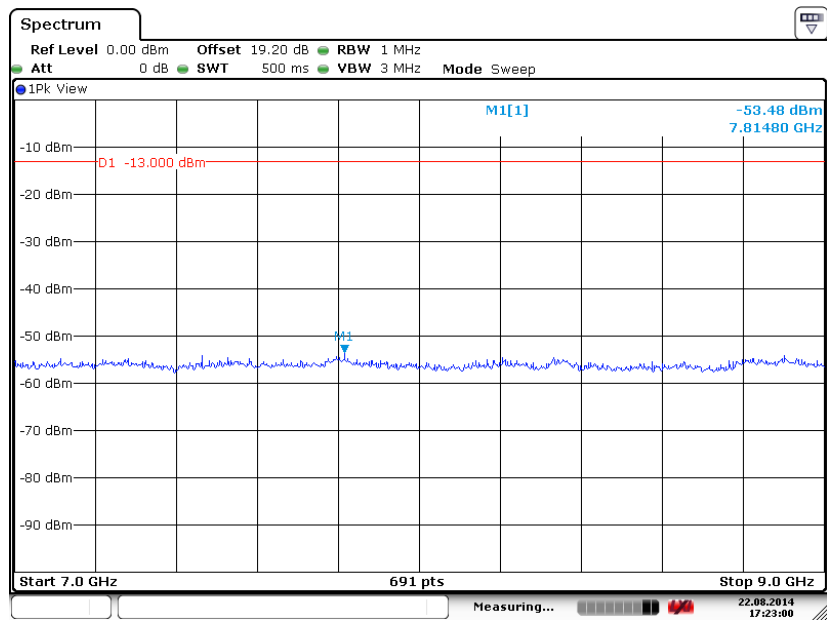



Band :	WCDMA Band IV	Channel :	CH1312
Test Mode :	RMC 12.2Kbps Link (QPSK)	Frequency :	1712.4 MHz

Conducted Spurious Emission Plot between 30MHz ~ 1GHz

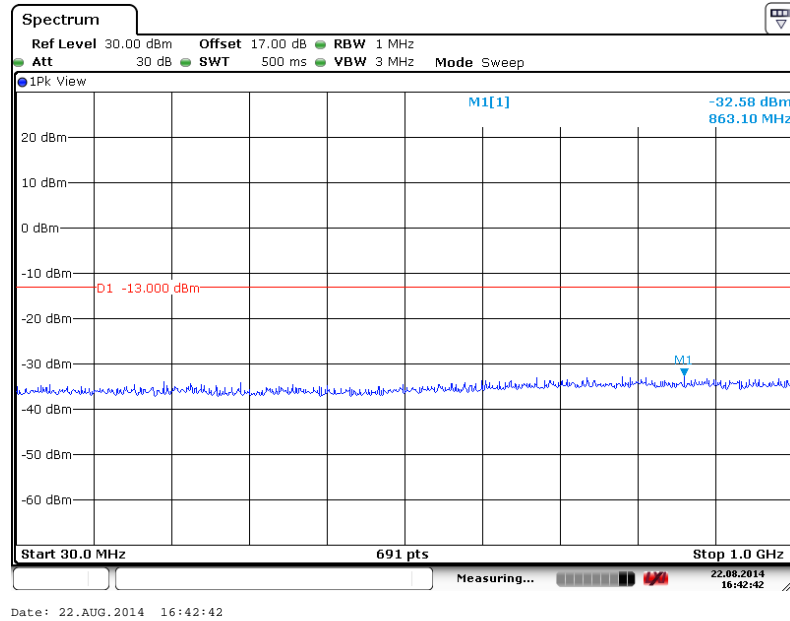

Conducted Spurious Emission Plot between 1GHz ~ 3GHz

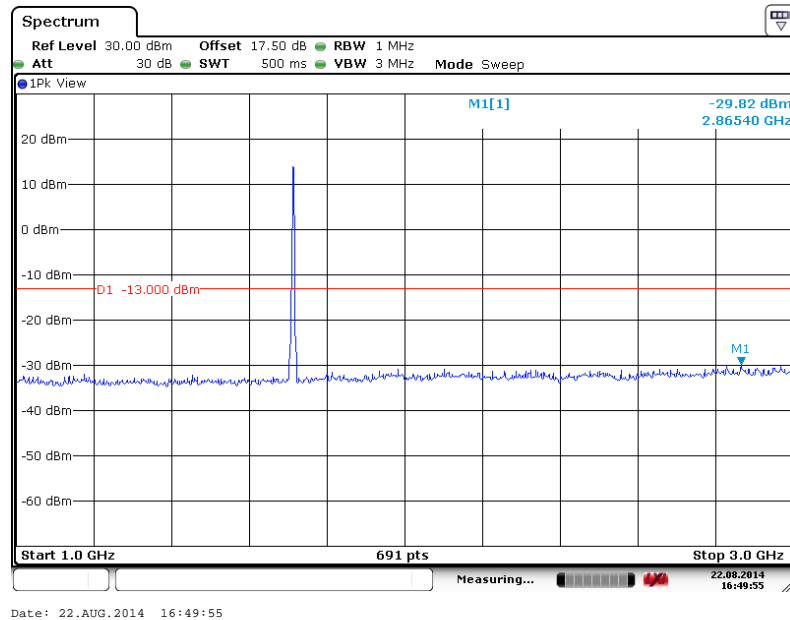



Conducted Spurious Emission Plot between 3GHz ~ 7GHz

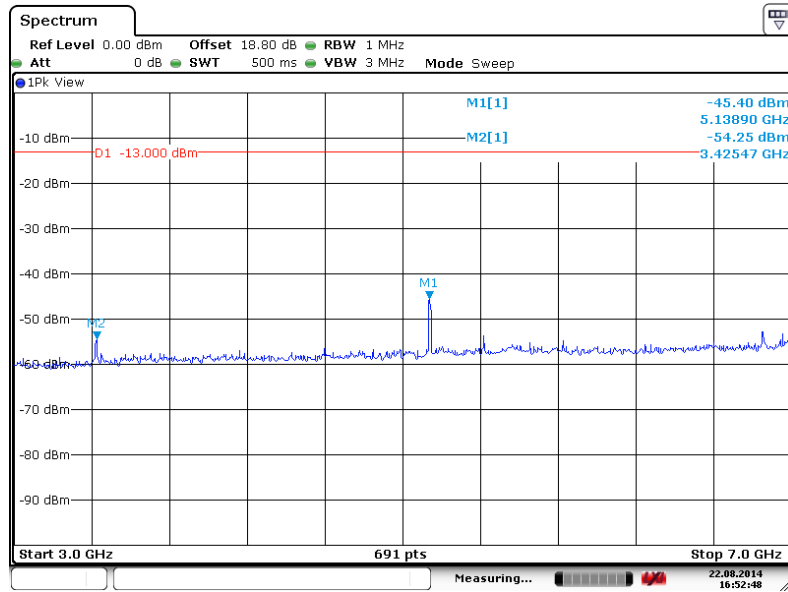

Conducted Spurious Emission Plot between 7GHz ~ 13.6GHz

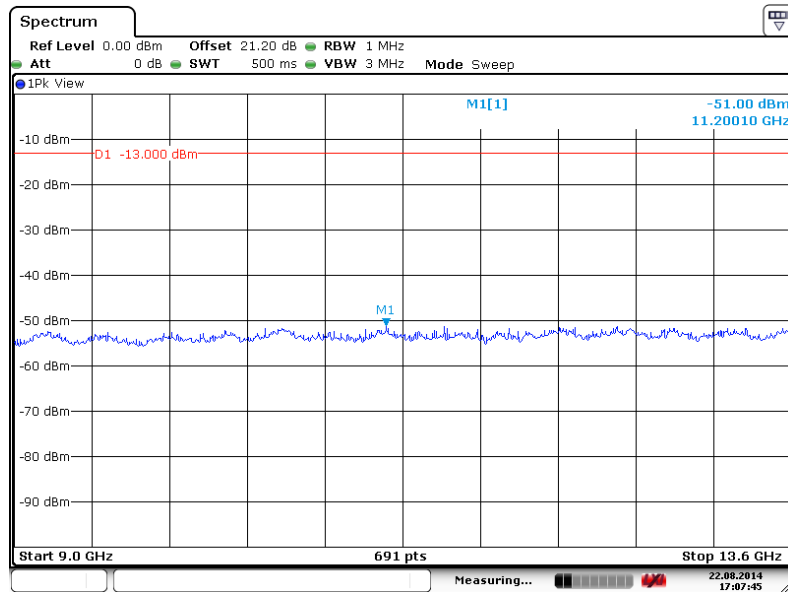



Conducted Spurious Emission Plot between 13.6GHz ~ 18GHz

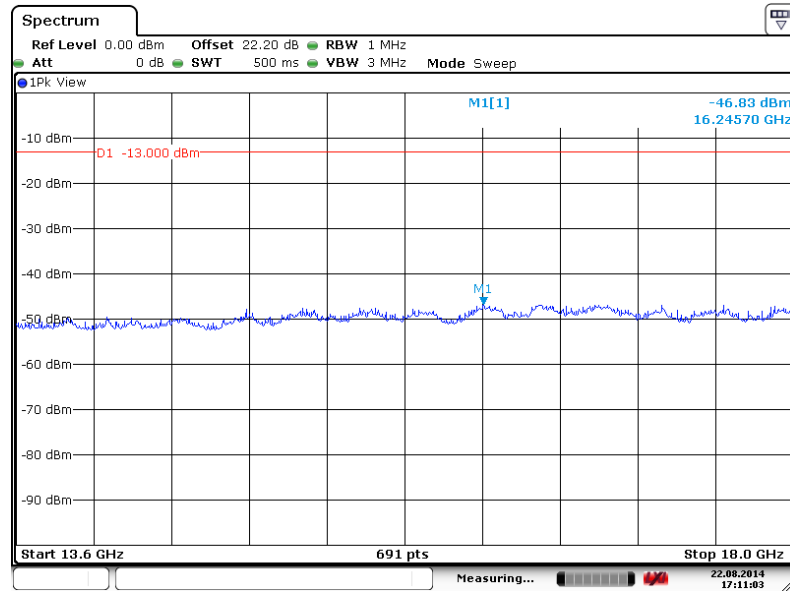

Date: 22.AUG.2014 17:11:03



Band :	WCDMA Band IV	Channel :	CH1413
Test Mode :	RMC 12.2Kbps Link (QPSK)	Frequency :	1732.6 MHz

Conducted Spurious Emission Plot between 30MHz ~ 1GHz

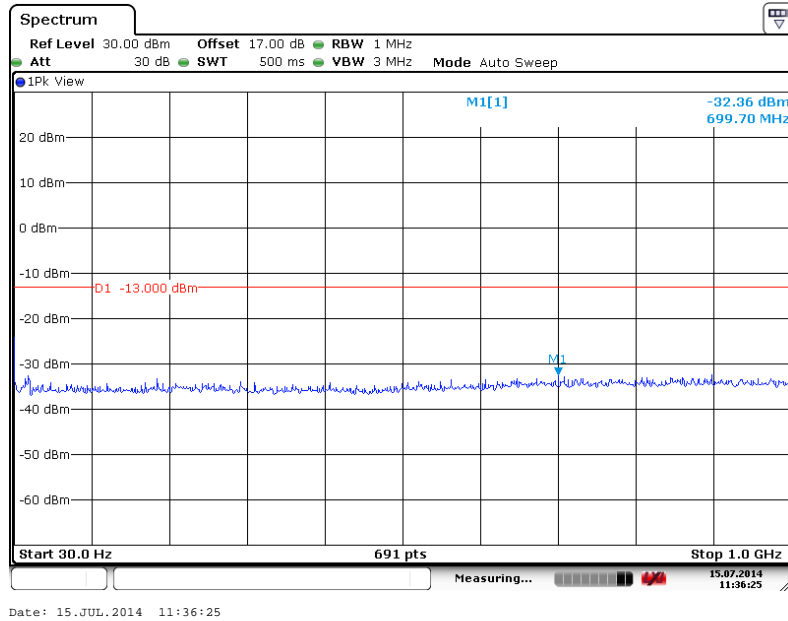

Conducted Spurious Emission Plot between 1GHz ~ 3GHz

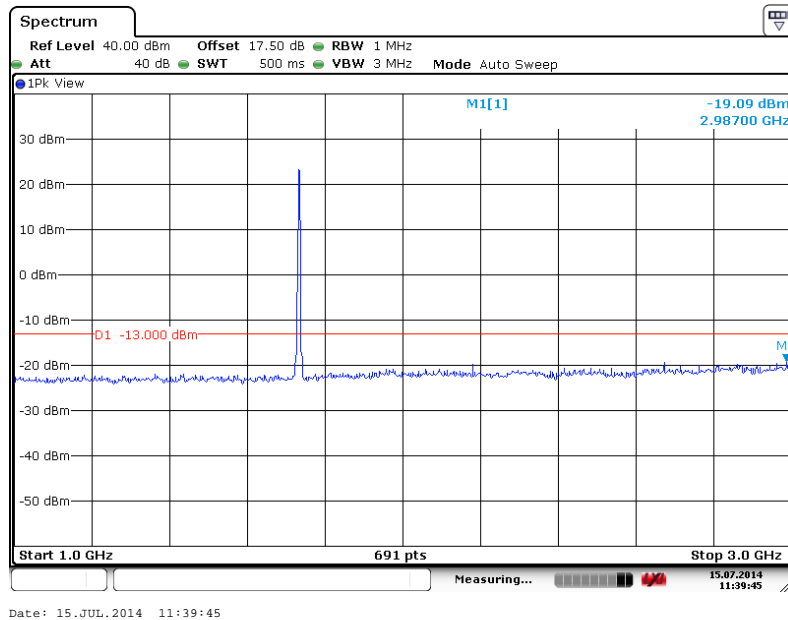



Conducted Spurious Emission Plot between 3GHz ~ 7GHz

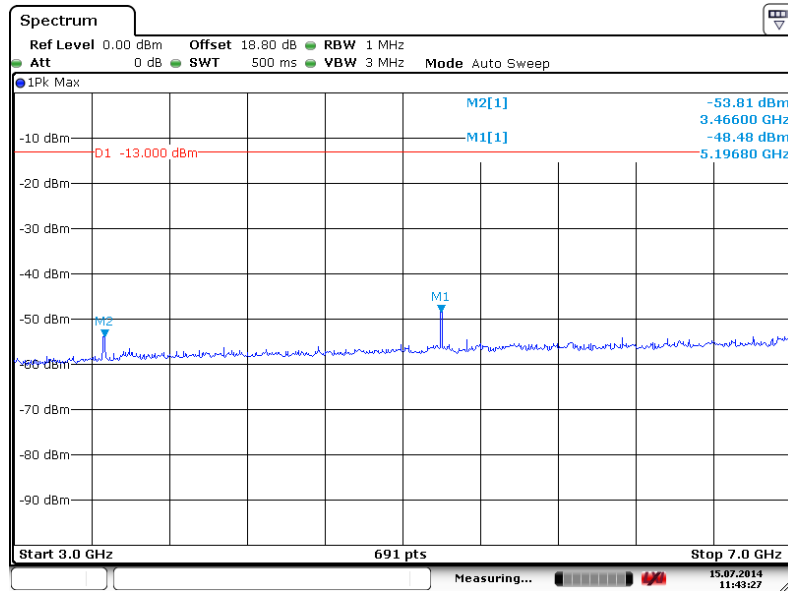

Conducted Spurious Emission Plot between 7GHz ~ 13.6GHz

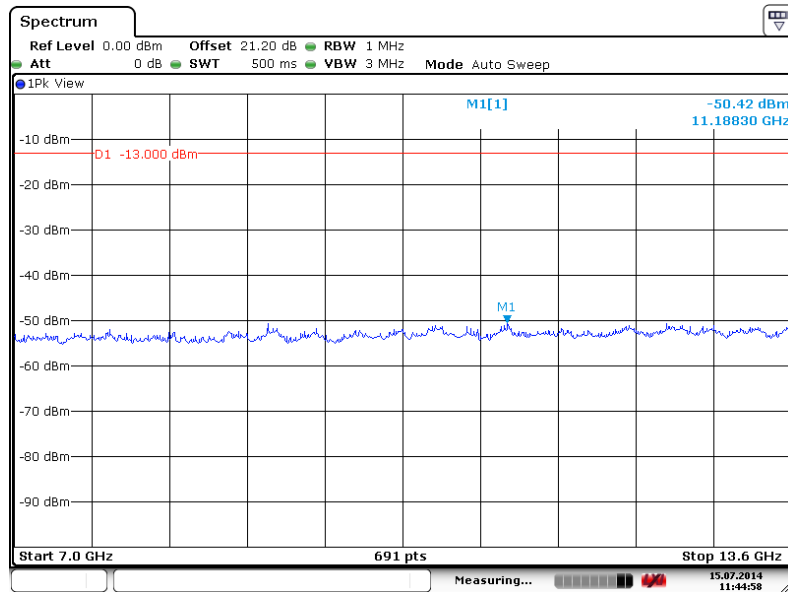



Conducted Spurious Emission Plot between 13.6GHz ~ 18GHz

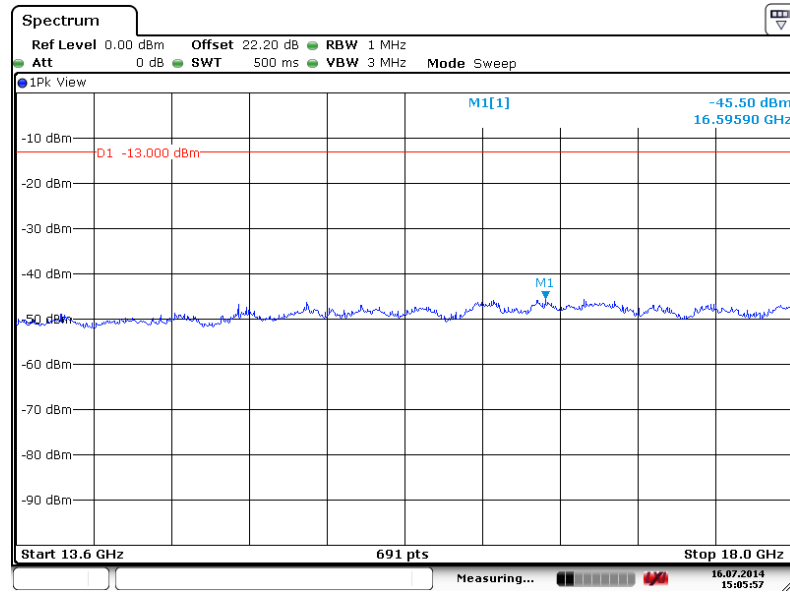

Date: 16.JUL.2014 15:05:58



Band :	WCDMA Band IV	Channel :	CH1513
Test Mode :	RMC 12.2Kbps Link (QPSK)	Frequency :	1752.6 MHz

Conducted Spurious Emission Plot between 30MHz ~ 1GHz

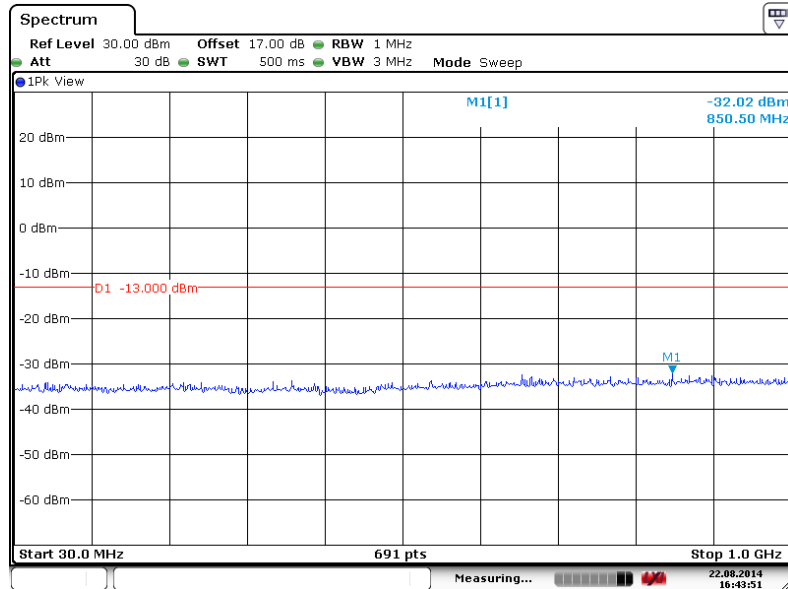

Date: 22.AUG.2014 16:43:51

Conducted Spurious Emission Plot between 1GHz ~ 3GHz

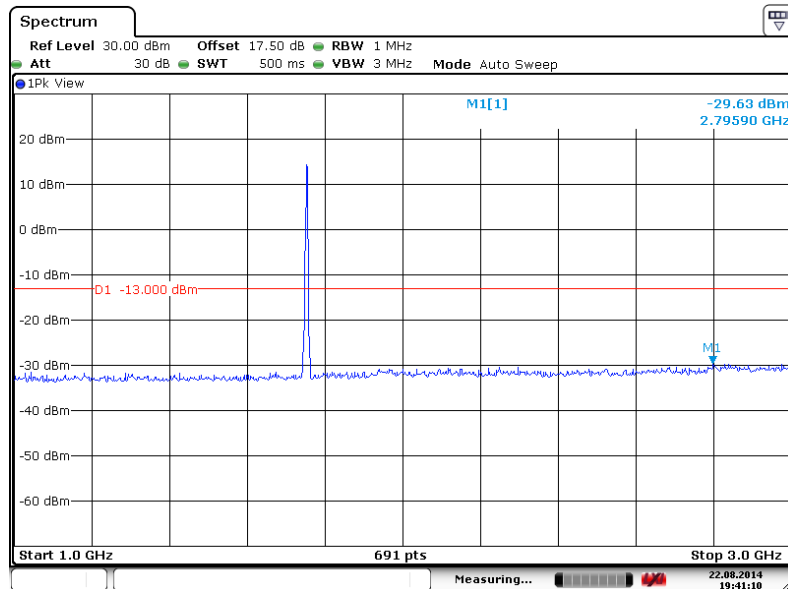

Date: 22.AUG.2014 19:41:10



Conducted Spurious Emission Plot between 3GHz ~ 7GHz

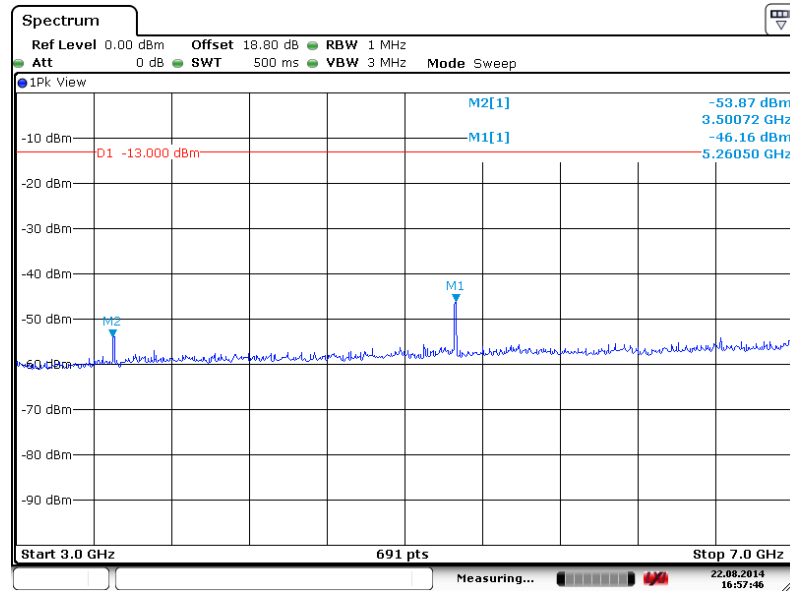

Conducted Spurious Emission Plot between 7GHz ~ 13.6GHz

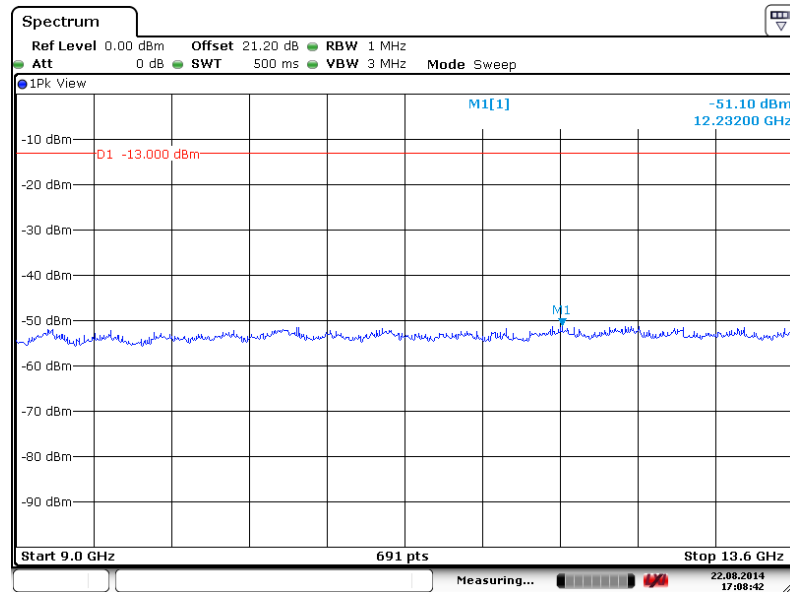



Conducted Spurious Emission Plot between 13.6GHz ~ 18GHz

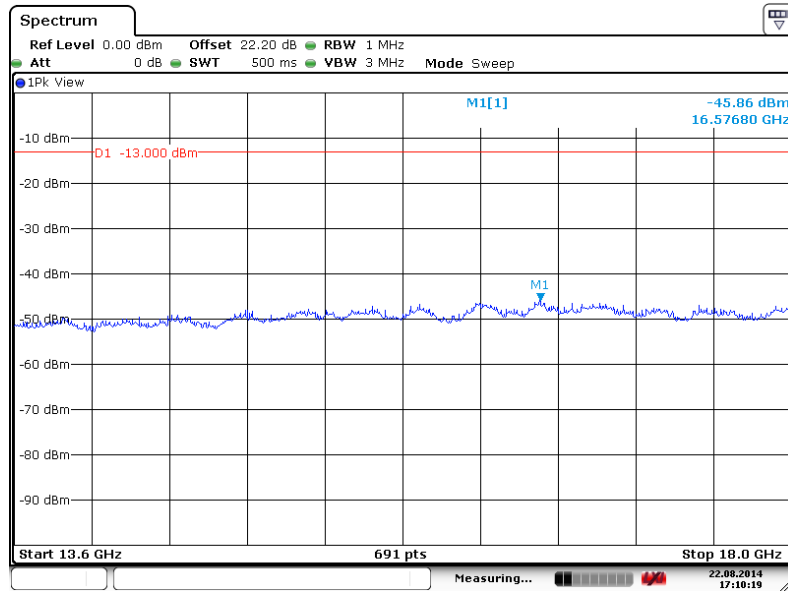

Date: 22.AUG.2014 17:10:19



Band :	WCDMA Band II	Channel :	CH9262
Test Mode :	RMC 12.2Kbps Link (QPSK)	Frequency :	1852.4 MHz

Conducted Spurious Emission Plot between 30MHz ~ 1GHz

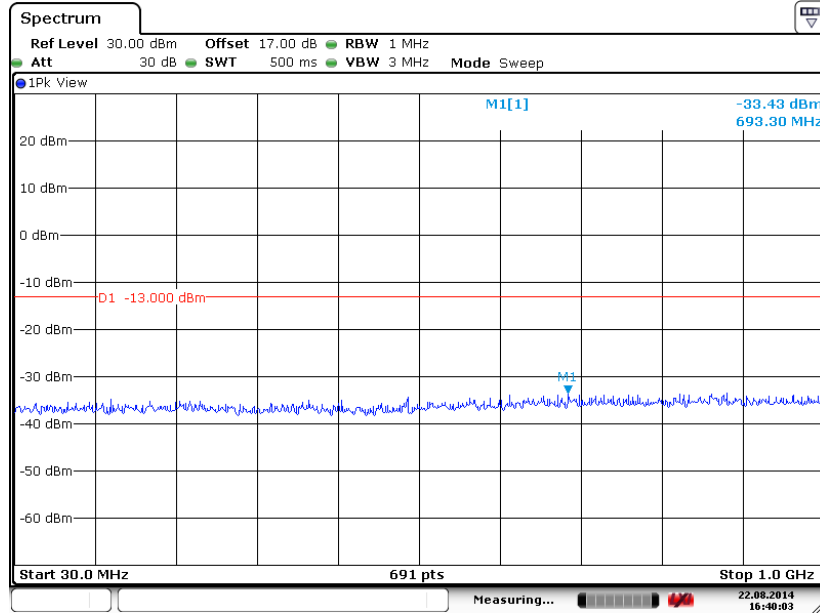

Conducted Spurious Emission Plot between 1GHz ~ 3GHz

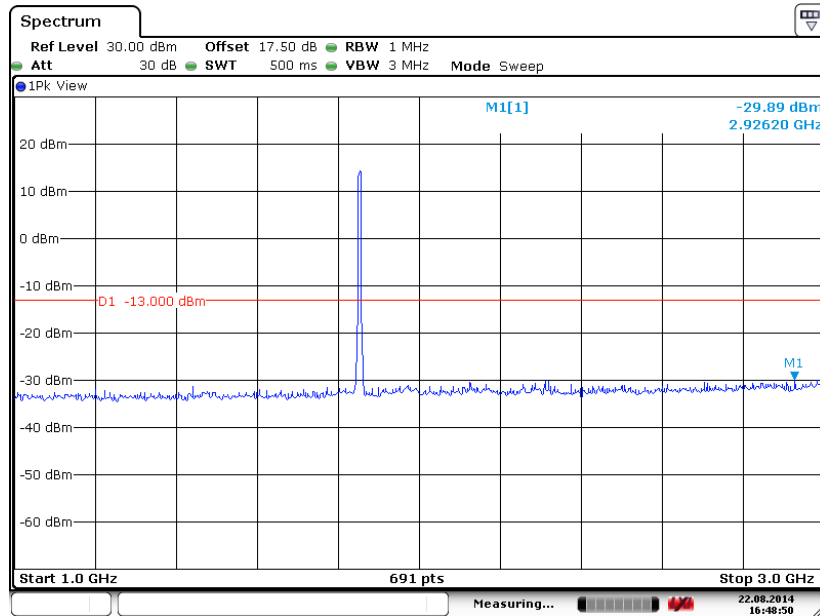



Conducted Spurious Emission Plot between 3GHz ~ 7GHz

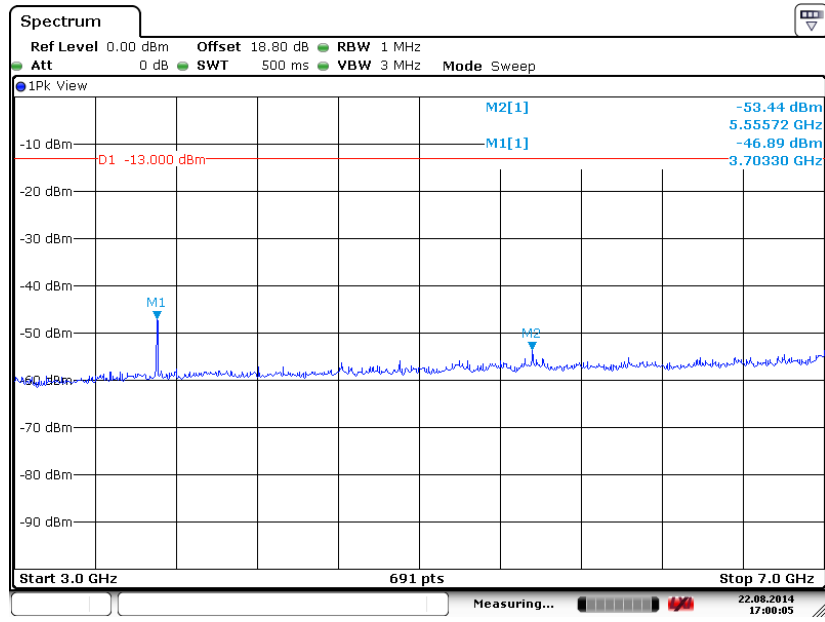

Conducted Spurious Emission Plot between 7GHz ~ 13.6GHz

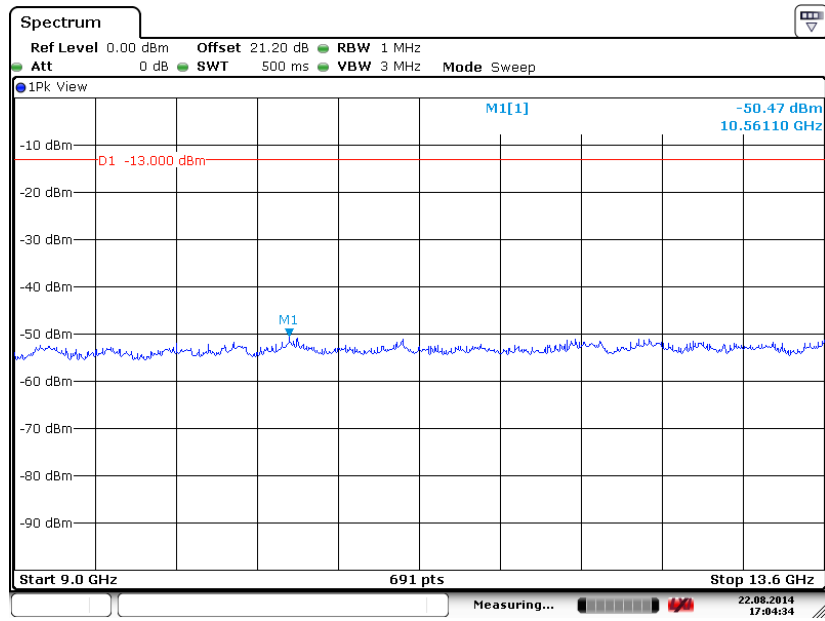



Conducted Spurious Emission Plot between 13.6GHz ~ 19.1GHz

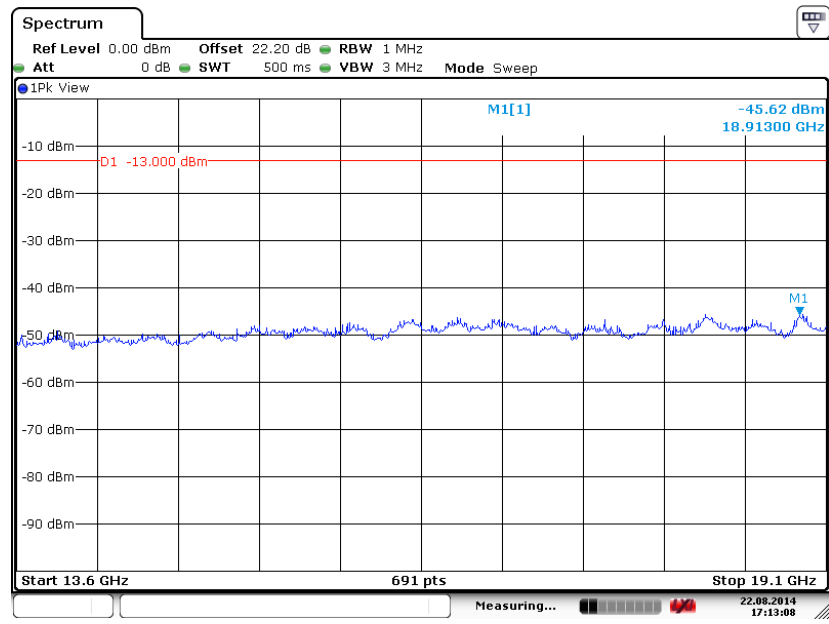

Date: 22.AUG.2014 17:13:08



Band :	WCDMA Band II	Channel :	CH9400
Test Mode :	RMC 12.2Kbps Link (QPSK)	Frequency :	1880.0 MHz

Conducted Spurious Emission Plot between 30MHz ~ 1GHz

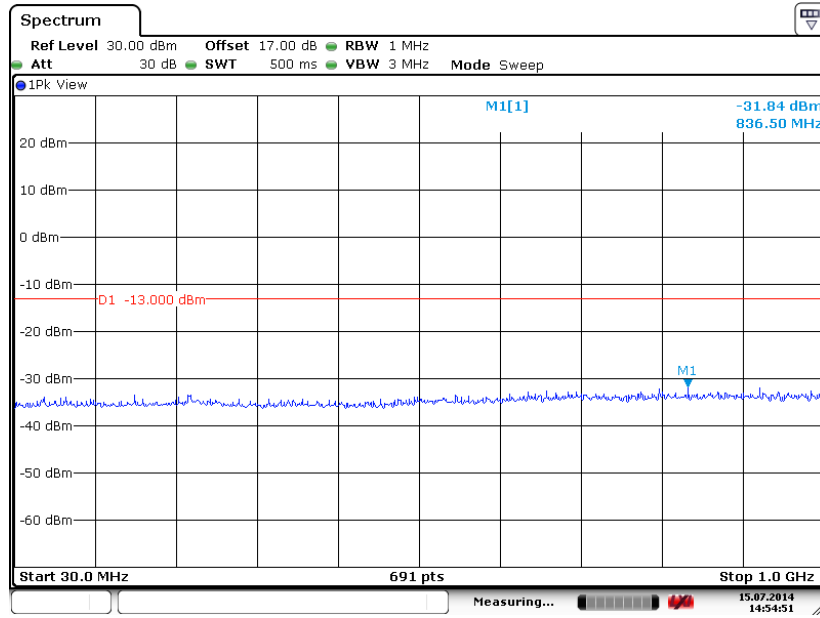

Date: 15.JUL.2014 14:54:52

Conducted Spurious Emission Plot between 1GHz ~ 3GHz

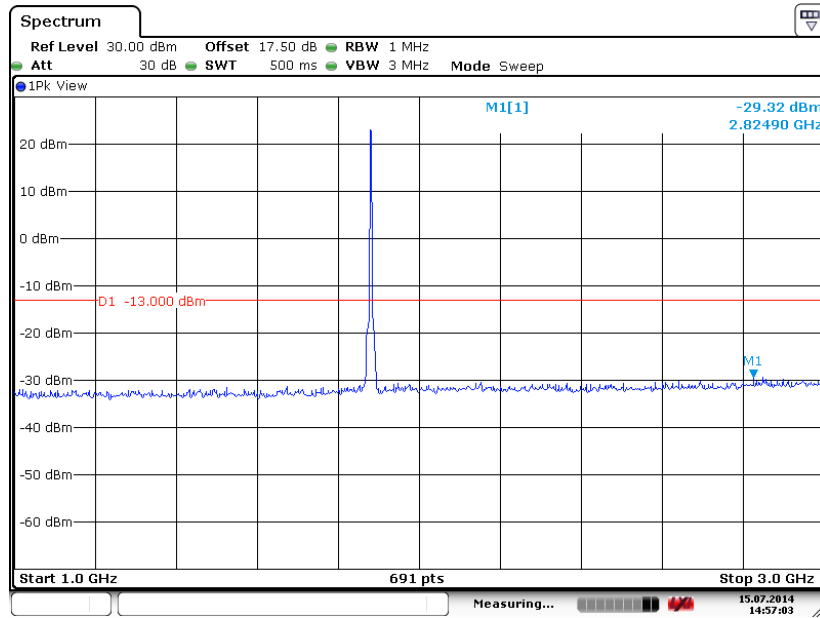

Date: 15.JUL.2014 14:57:03



Conducted Spurious Emission Plot between 3GHz ~ 7GHz

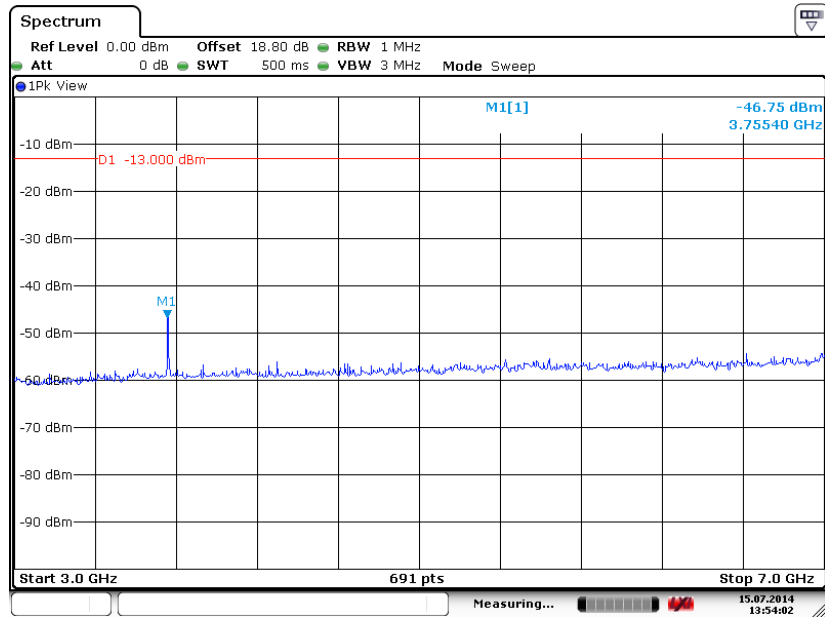

Date: 15.JUL.2014 13:54:02

Conducted Spurious Emission Plot between 7GHz ~ 13.6GHz

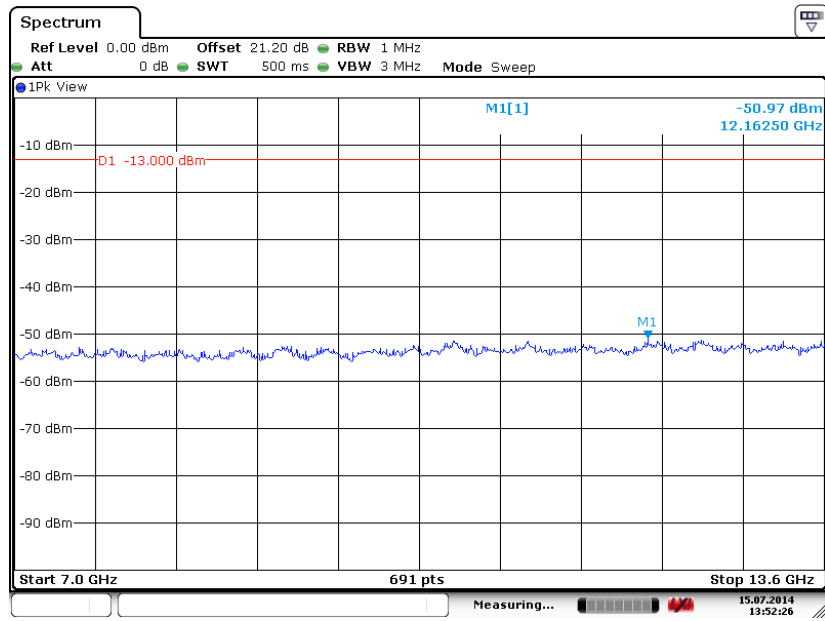

Date: 15.JUL.2014 13:52:26



Conducted Spurious Emission Plot between 13.6GHz ~ 19.1GHz

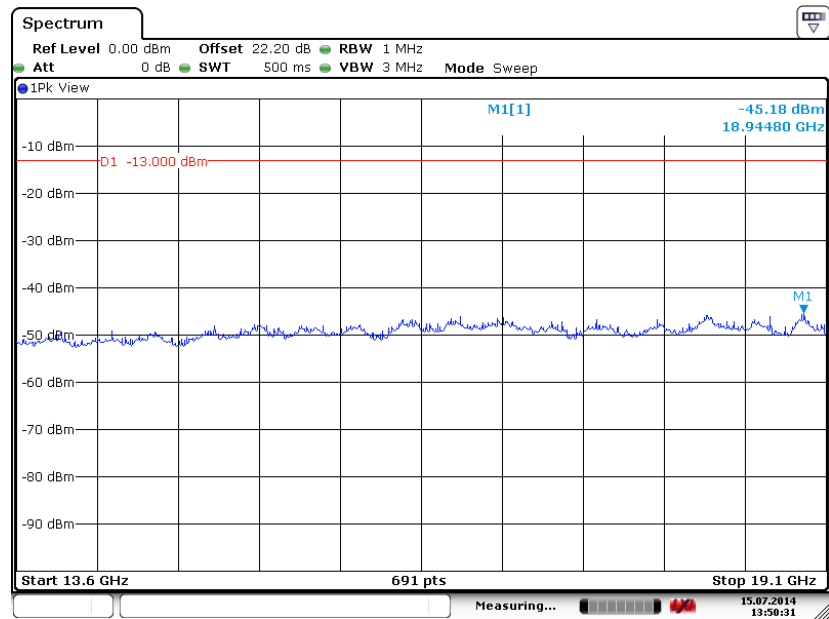

Date: 15.JUL.2014 13:50:31



Band :	WCDMA Band II	Channel :	CH9538
Test Mode :	RMC 12.2Kbps Link (QPSK)	Frequency :	1907.6 MHz

Conducted Spurious Emission Plot between 30MHz ~ 1GHz

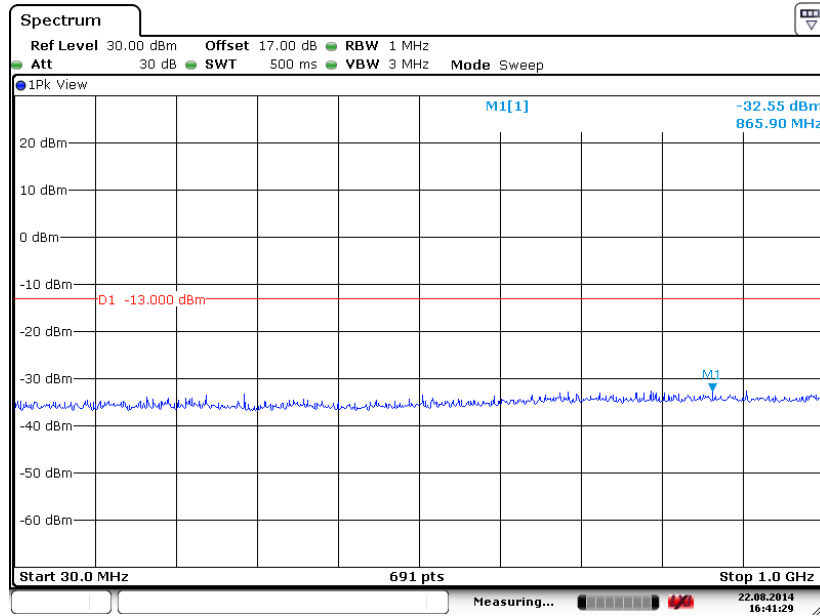

Date: 22.AUG.2014 16:41:29

Conducted Spurious Emission Plot between 1GHz ~ 3GHz

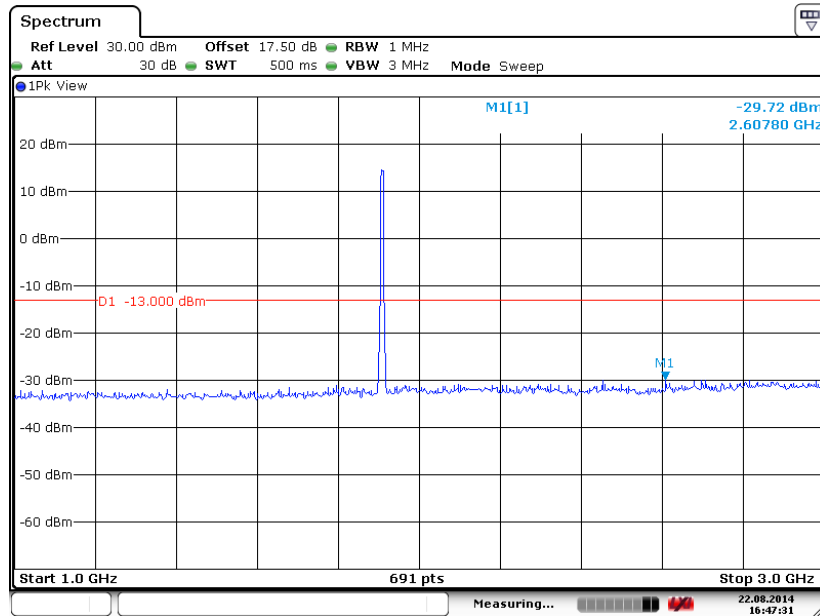

Date: 22.AUG.2014 16:47:31



Conducted Spurious Emission Plot between 3GHz ~ 7GHz

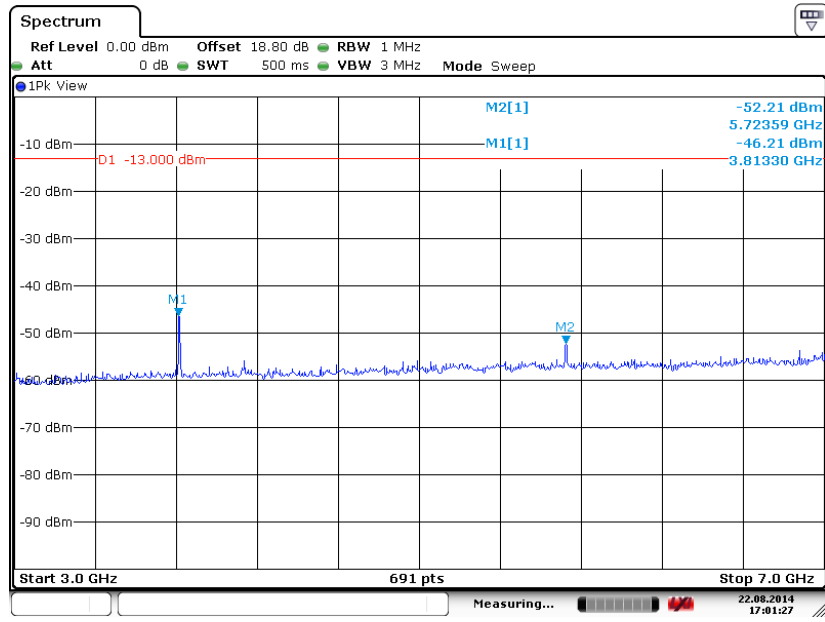

Conducted Spurious Emission Plot between 7GHz ~ 13.6GHz

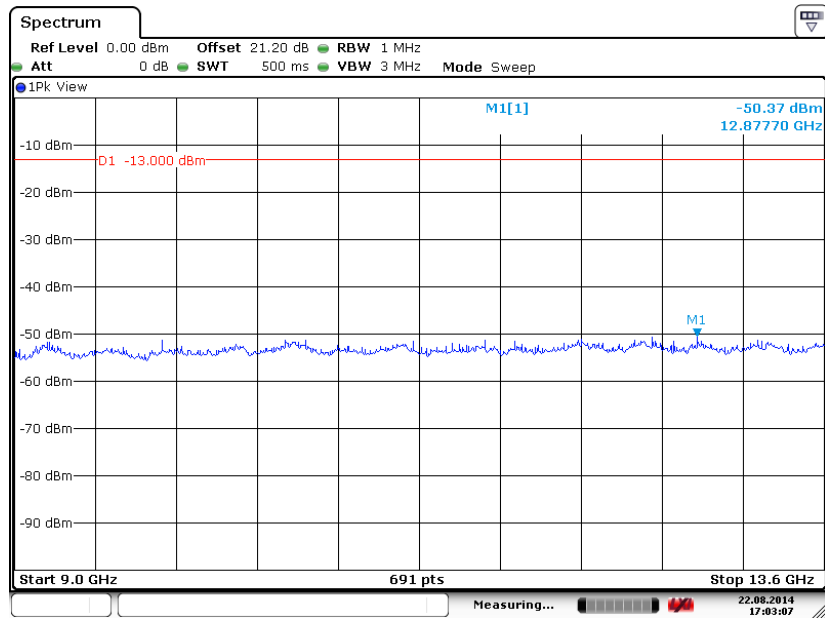



Conducted Spurious Emission Plot between 13.6GHz ~ 19.1GHz

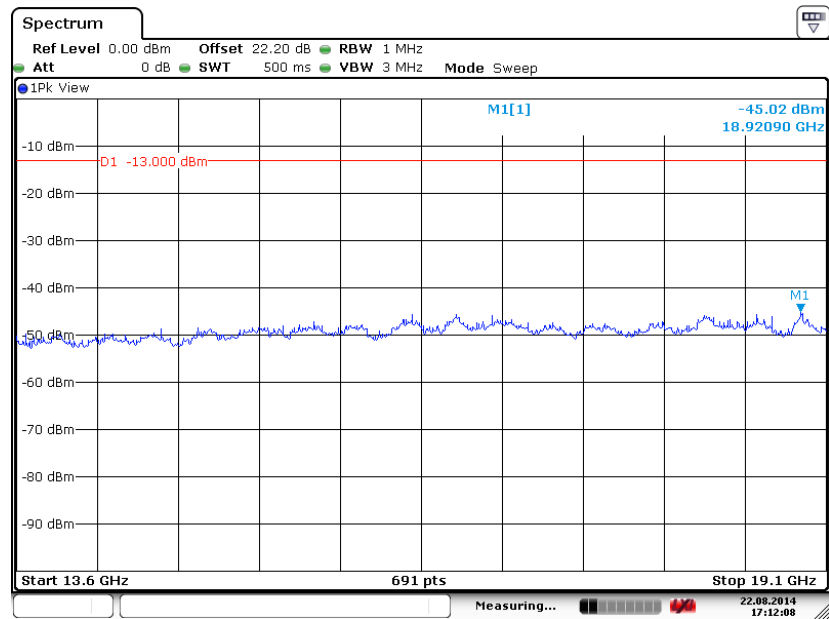

Date: 22.AUG.2014 17:12:08

3.7 Field Strength of Spurious Radiation Measurement

3.7.1 Description of Field Strength of Spurious Radiated Measurement

The power of any emission outside of the authorized operating frequency ranges must be attenuated below the transmitter power (P) by a factor of at least $43 + 10 \log (P)$ dB. The spectrum is scanned from 30 MHz up to a frequency including its 10th harmonic.

3.7.2 Measuring Instruments

The measuring equipment is listed in the section 4 of this test report.

3.7.3 Test Procedures

1. The testing follows FCC KDB 971168 v02r01 Section 5.8 and ANSI / TIA-603-C-2004 Section 2.2.12.
2. The EUT was placed on a rotatable wooden table 0.8 meters above the ground.
3. The EUT was set 3 meters from the receiving antenna, which was mounted on the antenna tower.
4. The table was rotated 360 degrees to determine the position of the highest spurious emission.
5. The height of the receiving antenna is varied between one meter and four meters to search for the maximum spurious emission for both horizontal and vertical polarizations.
6. Make the measurement with the spectrum analyzer's RBW = 1MHz, VBW = 3MHz, taking record of maximum spurious emission.
7. A horn antenna was substituted in place of the EUT and was driven by a signal generator.
8. Tune the output power of signal generator to the same emission level with EUT maximum spurious emission.
9. Taking the record of output power at antenna port.
10. Repeat step 7 to step 8 for another polarization.
11. $EIRP \text{ (dBm)} = S.G. \text{ Power} - Tx \text{ Cable Loss} + Tx \text{ Antenna Gain}$
12. $ERP \text{ (dBm)} = EIRP - 2.15$
13. The RF fundamental frequency should be excluded against the limit line in the operating frequency band.
14. The limit line is derived from $43 + 10\log(P)$ dB below the transmitter power P(Watts)
 $= P(W) - [43 + 10\log(P)] \text{ (dB)}$
 $= [30 + 10\log(P)] \text{ (dBm)} - [43 + 10\log(P)] \text{ (dB)}$
 $= -13\text{dBm}.$

3.7.4 Test Setup

For radiated emissions from 30MHz to 1GHz

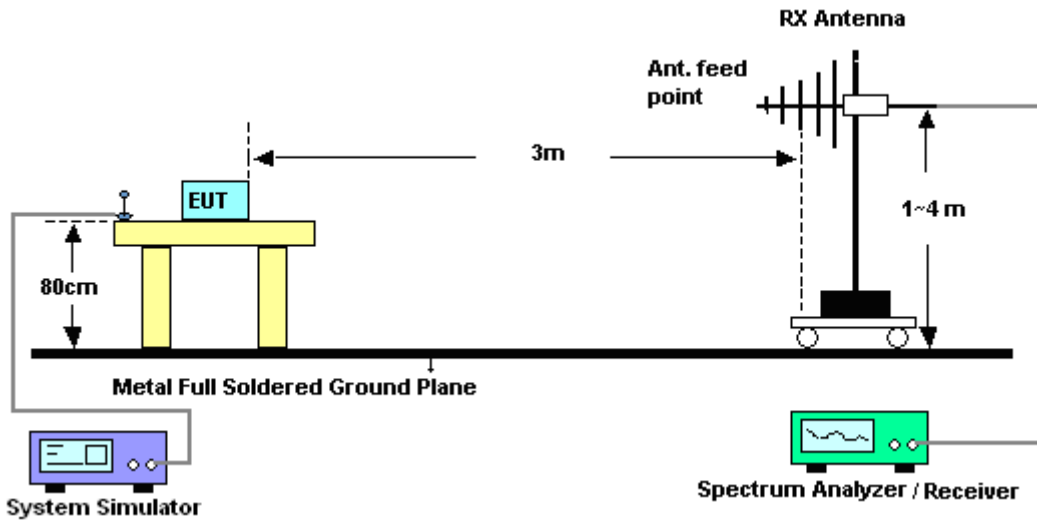

For radiated emissions above 1GHz

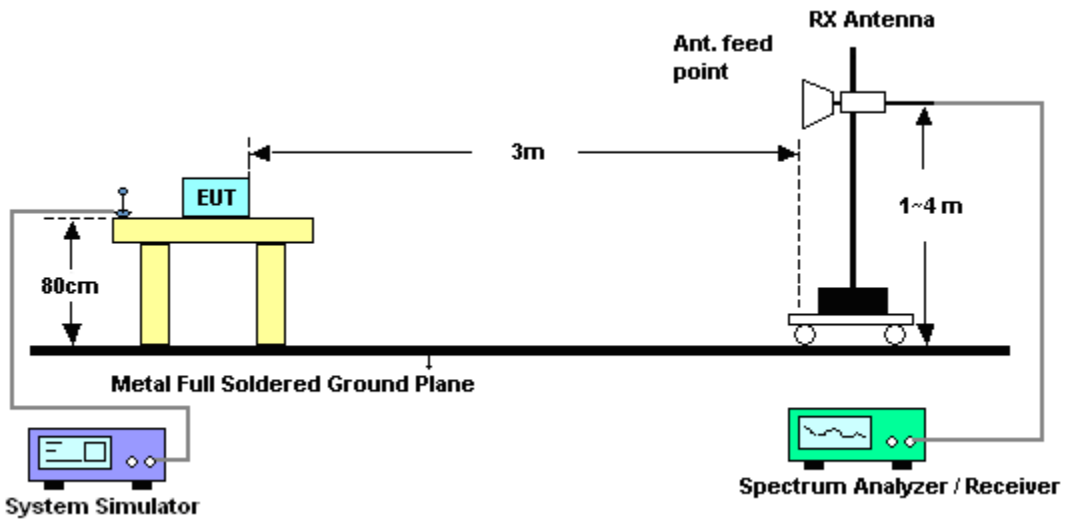



3.7.5 Test Result of Field Strength of Spurious Radiated

Band :	GSM850 for CH128		Temperature :	22~23°C					
Test Mode :	GPRS class 8 Link (GMSK)		Relative Humidity :	42~43%					
Test Engineer :	Star Wei		Polarization :	Horizontal					
Remark :	Spurious emissions within 30-1000MHz were found more than 20dB below limit line.								
Frequency (MHz)	ERP (dBm)	Limit (dBm)	Over Limit (dB)	SPA Reading (dBm)	S.G. Power (dBm)	TX Cable loss (dB)	TX Antenna Gain (dBi)	Polarization (H/V)	Result
1648	-68.48	-13	-55.48	-59.86	-69.13	0.57	3.37	H	Pass
2474	-62.84	-13	-49.84	-61.51	-65.07	0.78	5.16	H	Pass
3296	-67.10	-13	-54.10	-66.73	-70.74	0.87	6.66	H	Pass

Band :	GSM850 for CH128		Temperature :	22~23°C					
Test Mode :	GPRS class 8 Link (GMSK)		Relative Humidity :	42~43%					
Test Engineer :	Star Wei		Polarization :	Vertical					
Remark :	Spurious emissions within 30-1000MHz were found more than 20dB below limit line.								
Frequency (MHz)	ERP (dBm)	Limit (dBm)	Over Limit (dB)	SPA Reading (dBm)	S.G. Power (dBm)	TX Cable loss (dB)	TX Antenna Gain (dBi)	Polarization (H/V)	Result
1648	-57.12	-13	-44.12	-57.73	-57.77	0.57	3.37	V	Pass
2474	-47.19	-13	-34.19	-54.92	-49.42	0.78	5.16	V	Pass
3296	-64.25	-13	-51.25	-65.31	-67.89	0.87	6.66	V	Pass



Band :	GSM850 for CH189		Temperature :	22~23°C					
Test Mode :	GPRS class 8 Link (GMSK)		Relative Humidity :	42~43%					
Test Engineer :	Star Wei		Polarization :	Horizontal					
Remark :	Spurious emissions within 30-1000MHz were found more than 20dB below limit line.								
Frequency (MHz)	ERP (dBm)	Limit (dBm)	Over Limit (dB)	SPA Reading (dBm)	S.G. Power (dBm)	TX Cable loss (dB)	TX Antenna Gain (dBi)	Polarization (H/V)	Result
1674	-68.18	-13	-55.18	-59.71	-68.83	0.57	3.37	H	Pass
2510	-57.44	-13	-44.44	-57.76	-59.67	0.78	5.16	H	Pass
3344	-65.55	-13	-52.55	-65.18	-69.19	0.87	6.66	H	Pass

Band :	GSM850 for CH189		Temperature :	22~23°C					
Test Mode :	GPRS class 8 Link (GMSK)		Relative Humidity :	42~43%					
Test Engineer :	Star Wei		Polarization :	Vertical					
Remark :	Spurious emissions within 30-1000MHz were found more than 20dB below limit line.								
Frequency (MHz)	ERP (dBm)	Limit (dBm)	Over Limit (dB)	SPA Reading (dBm)	S.G. Power (dBm)	TX Cable loss (dB)	TX Antenna Gain (dBi)	Polarization (H/V)	Result
1674	-52.46	-13	-39.46	-54.67	-53.11	0.57	3.37	V	Pass
2510	-44.86	-13	-31.86	-53.23	-47.09	0.78	5.16	V	Pass
3344	-64.23	-13	-51.23	-65.29	-67.87	0.87	6.66	V	Pass



Band :	GSM850 for CH251					Temperature :	22~23°C		
Test Mode :	GPRS class 8 Link (GMSK)					Relative Humidity :	42~43%		
Test Engineer :	Star Wei					Polarization :	Horizontal		
Remark :	Spurious emissions within 30-1000MHz were found more than 20dB below limit line.								
Frequency (MHz)	ERP (dBm)	Limit (dBm)	Over Limit (dB)	SPA Reading (dBm)	S.G. Power (dBm)	TX Cable loss (dB)	TX Antenna Gain (dBi)	Polarization (H/V)	Result
1698	-62.28	-13	-49.28	-56.45	-62.93	0.57	3.37	H	Pass
2548	-55.09	-13	-42.09	-56.23	-57.32	0.78	5.16	H	Pass
3396	-66.53	-13	-53.53	-66.16	-70.17	0.87	6.66	H	Pass

Band :	GSM850 for CH251					Temperature :	22~23°C		
Test Mode :	GPRS class 8 Link (GMSK)					Relative Humidity :	42~43%		
Test Engineer :	Star Wei					Polarization :	Vertical		
Remark :	Spurious emissions within 30-1000MHz were found more than 20dB below limit line.								
Frequency (MHz)	ERP (dBm)	Limit (dBm)	Over Limit (dB)	SPA Reading (dBm)	S.G. Power (dBm)	TX Cable loss (dB)	TX Antenna Gain (dBi)	Polarization (H/V)	Result
1698	-52.03	-13	-39.03	-54.28	-52.68	0.57	3.37	V	Pass
2548	-49.17	-13	-36.17	-56.17	-51.40	0.78	5.16	V	Pass
3396	-65.11	-13	-52.11	-66.17	-68.75	0.87	6.66	V	Pass



Band :	GSM850 for CH128		Temperature :	22~23°C					
Test Mode :	EDGE class 8 Link (8PSK)		Relative Humidity :	42~43%					
Test Engineer :	Star Wei		Polarization :	Horizontal					
Remark :	Spurious emissions within 30-1000MHz were found more than 20dB below limit line.								
Frequency (MHz)	ERP (dBm)	Limit (dBm)	Over Limit (dB)	SPA Reading (dBm)	S.G. Power (dBm)	TX Cable loss (dB)	TX Antenna Gain (dBi)	Polarization (H/V)	Result
1648	-69.76	-13	-56.76	-60.88	-70.41	0.57	3.37	H	Pass
2474	-56.41	-13	-43.41	-57.08	-58.64	0.78	5.16	H	Pass
3296	-66.13	-13	-53.13	-65.76	-69.77	0.87	6.66	H	Pass

Band :	GSM850 for CH128		Temperature :	22~23°C					
Test Mode :	EDGE class 8 Link (8PSK)		Relative Humidity :	42~43%					
Test Engineer :	Star Wei		Polarization :	Vertical					
Remark :	Spurious emissions within 30-1000MHz were found more than 20dB below limit line.								
Frequency (MHz)	ERP (dBm)	Limit (dBm)	Over Limit (dB)	SPA Reading (dBm)	S.G. Power (dBm)	TX Cable loss (dB)	TX Antenna Gain (dBi)	Polarization (H/V)	Result
1648	-59.15	-13	-46.15	-58.79	-59.80	0.57	3.37	V	Pass
2474	-49.00	-13	-36.00	-55.97	-51.23	0.78	5.16	V	Pass
3296	-65.06	-13	-52.06	-66.12	-68.70	0.87	6.66	V	Pass



Band :	GSM850 for CH189				Temperature :	22~23°C			
Test Mode :	EDGE class 8 Link (8PSK)				Relative Humidity :	42~43%			
Test Engineer :	Star Wei				Polarization :	Horizontal			
Remark :	Spurious emissions within 30-1000MHz were found more than 20dB below limit line.								
Frequency (MHz)	ERP (dBm)	Limit (dBm)	Over Limit (dB)	SPA Reading (dBm)	S.G. Power (dBm)	TX Cable loss (dB)	TX Antenna Gain (dBi)	Polarization (H/V)	Result
1674	-68.86	-13	-55.86	-60.05	-69.51	0.57	3.37	H	Pass
2510	-58.65	-13	-45.65	-58.49	-60.88	0.78	5.16	H	Pass
3344	-65.81	-13	-52.81	-65.44	-69.45	0.87	6.66	H	Pass

Band :	GSM850 for CH189				Temperature :	22~23°C			
Test Mode :	EDGE class 8 Link (8PSK)				Relative Humidity :	42~43%			
Test Engineer :	Star Wei				Polarization :	Vertical			
Remark :	Spurious emissions within 30-1000MHz were found more than 20dB below limit line.								
Frequency (MHz)	ERP (dBm)	Limit (dBm)	Over Limit (dB)	SPA Reading (dBm)	S.G. Power (dBm)	TX Cable loss (dB)	TX Antenna Gain (dBi)	Polarization (H/V)	Result
1672	-55.64	-13	-42.64	-56.89	-56.29	0.57	3.37	V	Pass
2510	-50.50	-13	-37.50	-57.22	-52.73	0.78	5.16	V	Pass
3344	-64.84	-13	-51.84	-65.90	-68.48	0.87	6.66	V	Pass



Band :	GSM850 for CH251					Temperature :	22~23°C		
Test Mode :	EDGE class 8 Link (8PSK)					Relative Humidity :	42~43%		
Test Engineer :	Star Wei					Polarization :	Horizontal		
Remark :	Spurious emissions within 30-1000MHz were found more than 20dB below limit line.								
Frequency (MHz)	ERP (dBm)	Limit (dBm)	Over Limit (dB)	SPA Reading (dBm)	S.G. Power (dBm)	TX Cable loss (dB)	TX Antenna Gain (dBi)	Polarization (H/V)	Result
1688	-68.26	-13	-55.26	-59.75	-68.91	0.57	3.37	H	Pass
2538	-60.11	-13	-47.11	-58.93	-62.34	0.78	5.16	H	Pass
3396	-67.25	-13	-54.25	-66.88	-70.89	0.87	6.66	H	Pass

Band :	GSM850 for CH251					Temperature :	22~23°C		
Test Mode :	EDGE class 8 Link (8PSK)					Relative Humidity :	42~43%		
Test Engineer :	Star Wei					Polarization :	Vertical		
Remark :	Spurious emissions within 30-1000MHz were found more than 20dB below limit line.								
Frequency (MHz)	ERP (dBm)	Limit (dBm)	Over Limit (dB)	SPA Reading (dBm)	S.G. Power (dBm)	TX Cable loss (dB)	TX Antenna Gain (dBi)	Polarization (H/V)	Result
1696	-58.81	-13	-45.81	-58.63	-59.46	0.57	3.37	V	Pass
2546	-50.12	-13	-37.12	-56.93	-52.35	0.78	5.16	V	Pass
3396	-65.78	-13	-52.78	-66.84	-69.42	0.87	6.66	V	Pass



Band :	GSM1900 for CH512				Temperature :	22~23°C			
Test Mode :	GPRS class 8 Link (GMSK)				Relative Humidity :	42~43%			
Test Engineer :	Star Wei				Polarization :	Horizontal			
Remark :	Spurious emissions within 30-1000MHz were found more than 20dB below limit line.								
Frequency (MHz)	EIRP (dBm)	Limit (dBm)	Over Limit (dB)	SPA Reading (dBm)	S.G. Power (dBm)	TX Cable loss (dB)	TX Antenna Gain (dBi)	Polarization (H/V)	Result
3699	-62.09	-13	-49.09	-65.44	-68.47	0.78	7.16	H	Pass
5551	-56.67	-13	-43.67	-66.73	-65.21	1.04	9.58	H	Pass
7401	-54.57	-13	-41.57	-66.11	-64.68	1.35	11.46	H	Pass

Band :	GSM1900 for CH512				Temperature :	22~23°C			
Test Mode :	GPRS class 8 Link (GMSK)				Relative Humidity :	42~43%			
Test Engineer :	Star Wei				Polarization :	Vertical			
Remark :	Spurious emissions within 30-1000MHz were found more than 20dB below limit line.								
Frequency (MHz)	EIRP (dBm)	Limit (dBm)	Over Limit (dB)	SPA Reading (dBm)	S.G. Power (dBm)	TX Cable loss (dB)	TX Antenna Gain (dBi)	Polarization (H/V)	Result
3700	-58.18	-13	-45.18	-66.58	-64.56	0.78	7.16	V	Pass
5550	-55.09	-13	-42.09	-67.74	-63.63	1.04	9.58	V	Pass
7401	-52.05	-13	-39.05	-66.14	-62.16	1.35	11.46	V	Pass



Band :	GSM1900 for CH661					Temperature :	22~23°C		
Test Mode :	GPRS class 8 Link (GMSK)					Relative Humidity :	42~43%		
Test Engineer :	Star Wei					Polarization :	Horizontal		
Remark :	Spurious emissions within 30-1000MHz were found more than 20dB below limit line.								
Frequency (MHz)	EIRP (dBm)	Limit (dBm)	Over Limit (dB)	SPA Reading (dBm)	S.G. Power (dBm)	TX Cable loss (dB)	TX Antenna Gain (dBi)	Polarization (H/V)	Result
3759	-62.49	-13	-49.49	-65.84	-68.87	0.78	7.16	H	Pass
5640	-56.82	-13	-43.82	-66.88	-65.36	1.04	9.58	H	Pass
7521	-54.37	-13	-41.37	-65.91	-64.48	1.35	11.46	H	Pass

Band :	GSM1900 for CH661					Temperature :	22~23°C		
Test Mode :	GPRS class 8 Link (GMSK)					Relative Humidity :	42~43%		
Test Engineer :	Star Wei					Polarization :	Vertical		
Remark :	Spurious emissions within 30-1000MHz were found more than 20dB below limit line.								
Frequency (MHz)	EIRP (dBm)	Limit (dBm)	Over Limit (dB)	SPA Reading (dBm)	S.G. Power (dBm)	TX Cable loss (dB)	TX Antenna Gain (dBi)	Polarization (H/V)	Result
3759	-57.15	-13	-44.15	-65.55	-63.53	0.78	7.16	V	Pass
5640	-54.09	-13	-41.09	-66.74	-62.63	1.04	9.58	V	Pass
7521	-53.12	-13	-40.12	-67.21	-63.23	1.35	11.46	V	Pass



Band :	GSM1900 for CH810					Temperature :	22~23°C		
Test Mode :	GPRS class 8 Link (GMSK)					Relative Humidity :	42~43%		
Test Engineer :	Star Wei					Polarization :	Horizontal		
Remark :	Spurious emissions within 30-1000MHz were found more than 20dB below limit line.								
Frequency (MHz)	EIRP (dBm)	Limit (dBm)	Over Limit (dB)	SPA Reading (dBm)	S.G. Power (dBm)	TX Cable loss (dB)	TX Antenna Gain (dBi)	Polarization (H/V)	Result
3819	-63.63	-13	-50.63	-66.98	-70.01	0.78	7.16	H	Pass
5729	-57.39	-13	-44.39	-67.45	-65.93	1.04	9.58	H	Pass
7638	-55.65	-13	-42.65	-67.19	-65.76	1.35	11.46	H	Pass

Band :	GSM1900 for CH810					Temperature :	22~23°C		
Test Mode :	GPRS class 8 Link (GMSK)					Relative Humidity :	42~43%		
Test Engineer :	Star Wei					Polarization :	Vertical		
Remark :	Spurious emissions within 30-1000MHz were found more than 20dB below limit line.								
Frequency (MHz)	EIRP (dBm)	Limit (dBm)	Over Limit (dB)	SPA Reading (dBm)	S.G. Power (dBm)	TX Cable loss (dB)	TX Antenna Gain (dBi)	Polarization (H/V)	Result
3819	-57.67	-13	-44.67	-66.07	-64.05	0.78	7.16	V	Pass
5729	-55.17	-13	-42.17	-67.82	-63.71	1.04	9.58	V	Pass
7638	-52.58	-13	-39.58	-66.67	-62.69	1.35	11.46	V	Pass



Band :	GSM1900 for CH512					Temperature :	22~23°C		
Test Mode :	EDGE class 8 Link (8PSK)					Relative Humidity :	42~43%		
Test Engineer :	Star Wei					Polarization :	Horizontal		
Remark :	Spurious emissions within 30-1000MHz were found more than 20dB below limit line.								
Frequency (MHz)	EIRP (dBm)	Limit (dBm)	Over Limit (dB)	SPA Reading (dBm)	S.G. Power (dBm)	TX Cable loss (dB)	TX Antenna Gain (dBi)	Polarization (H/V)	Result
3699	-63.42	-13	-50.42	-66.77	-69.80	0.78	7.16	H	Pass
5551	-56.85	-13	-43.85	-66.91	-65.39	1.04	9.58	H	Pass
7401	-54.82	-13	-41.82	-66.36	-64.93	1.35	11.46	H	Pass

Band :	GSM1900 for CH512					Temperature :	22~23°C		
Test Mode :	EDGE class 8 Link (8PSK)					Relative Humidity :	42~43%		
Test Engineer :	Star Wei					Polarization :	Vertical		
Remark :	Spurious emissions within 30-1000MHz were found more than 20dB below limit line.								
Frequency (MHz)	EIRP (dBm)	Limit (dBm)	Over Limit (dB)	SPA Reading (dBm)	S.G. Power (dBm)	TX Cable loss (dB)	TX Antenna Gain (dBi)	Polarization (H/V)	Result
3699	-58.24	-13	-45.24	-66.64	-64.62	0.78	7.16	V	Pass
5551	-53.71	-13	-40.71	-66.36	-62.25	1.04	9.58	V	Pass
7401	-51.93	-13	-38.93	-66.02	-62.04	1.35	11.46	V	Pass



Band :	GSM1900 for CH661					Temperature :	22~23°C		
Test Mode :	EDGE class 8 Link (8PSK)					Relative Humidity :	42~43%		
Test Engineer :	Star Wei					Polarization :	Horizontal		
Remark :	Spurious emissions within 30-1000MHz were found more than 20dB below limit line.								
Frequency (MHz)	EIRP (dBm)	Limit (dBm)	Over Limit (dB)	SPA Reading (dBm)	S.G. Power (dBm)	TX Cable loss (dB)	TX Antenna Gain (dBi)	Polarization (H/V)	Result
3759	-62.06	-13	-49.06	-65.41	-68.44	0.78	7.16	H	Pass
5640	-58.04	-13	-45.04	-68.10	-66.58	1.04	9.58	H	Pass
7521	-55.39	-13	-42.39	-66.93	-65.50	1.35	11.46	H	Pass

Band :	GSM1900 for CH661					Temperature :	22~23°C		
Test Mode :	EDGE class 8 Link (8PSK)					Relative Humidity :	42~43%		
Test Engineer :	Star Wei					Polarization :	Vertical		
Remark :	Spurious emissions within 30-1000MHz were found more than 20dB below limit line.								
Frequency (MHz)	EIRP (dBm)	Limit (dBm)	Over Limit (dB)	SPA Reading (dBm)	S.G. Power (dBm)	TX Cable loss (dB)	TX Antenna Gain (dBi)	Polarization (H/V)	Result
3759	-57.75	-13	-44.75	-66.15	-64.13	0.78	7.16	V	Pass
5640	-54.42	-13	-41.42	-67.07	-62.96	1.04	9.58	V	Pass
7521	-53.06	-13	-40.06	-67.15	-63.17	1.35	11.46	V	Pass



Band :	GSM1900 for CH810	Temperature :	22~23°C						
Test Mode :	EDGE class 8 Link (8PSK)	Relative Humidity :	42~43%						
Test Engineer :	Star Wei	Polarization :	Horizontal						
Remark :	Spurious emissions within 30-1000MHz were found more than 20dB below limit line.								
Frequency (MHz)	EIRP (dBm)	Limit (dBm)	Over Limit (dB)	SPA Reading (dBm)	S.G. Power (dBm)	TX Cable loss (dB)	TX Antenna Gain (dBi)	Polarization (H/V)	Result
3819	-63.19	-13	-50.19	-66.54	-69.57	0.78	7.16	H	Pass
5729	-57.52	-13	-44.52	-67.58	-66.06	1.04	9.58	H	Pass
7638	-54.41	-13	-41.41	-65.95	-64.52	1.35	11.46	H	Pass

Band :	GSM1900 for CH810	Temperature :	22~23°C						
Test Mode :	EDGE class 8 Link (8PSK)	Relative Humidity :	42~43%						
Test Engineer :	Star Wei	Polarization :	Vertical						
Remark :	Spurious emissions within 30-1000MHz were found more than 20dB below limit line.								
Frequency (MHz)	EIRP (dBm)	Limit (dBm)	Over Limit (dB)	SPA Reading (dBm)	S.G. Power (dBm)	TX Cable loss (dB)	TX Antenna Gain (dBi)	Polarization (H/V)	Result
3819	-58.25	-13	-45.25	-66.65	-64.63	0.78	7.16	V	Pass
5729	-53.45	-13	-40.45	-66.1	-61.99	1.04	9.58	V	Pass
7638	-52.22	-13	-39.22	-66.31	-62.33	1.35	11.46	V	Pass



Band :	WCDMA Band V for CH4132	Temperature :	22~23°C						
Test Mode :	RMC 12.2Kbps Link (QPSK)	Relative Humidity :	42~43%						
Test Engineer :	Star Wei	Polarization :	Horizontal						
Remark :	Spurious emissions within 30-1000MHz were found more than 20dB below limit line.								
Frequency (MHz)	ERP (dBm)	Limit (dBm)	Over Limit (dB)	SPA Reading (dBm)	S.G. Power (dBm)	TX Cable loss (dB)	TX Antenna Gain (dBi)	Polarization (H/V)	Result
1652	-69.85	-13	-56.85	-60.97	-70.50	0.57	3.37	H	Pass
2479	-67.77	-13	-54.77	-66.44	-70.00	0.78	5.16	H	Pass
3304	-65.98	-13	-52.98	-65.61	-69.62	0.87	6.66	H	Pass

Band :	WCDMA Band V for CH4132	Temperature :	22~23°C						
Test Mode :	RMC 12.2Kbps Link (QPSK)	Relative Humidity :	42~43%						
Test Engineer :	Star Wei	Polarization :	Vertical						
Remark :	Spurious emissions within 30-1000MHz were found more than 20dB below limit line.								
Frequency (MHz)	ERP (dBm)	Limit (dBm)	Over Limit (dB)	SPA Reading (dBm)	S.G. Power (dBm)	TX Cable loss (dB)	TX Antenna Gain (dBi)	Polarization (H/V)	Result
1652	-66.20	-13	-53.20	-62.40	-66.85	0.57	3.37	V	Pass
2479	-63.28	-13	-50.28	-65.71	-65.51	0.78	5.16	V	Pass
3304	-64.88	-13	-51.88	-65.94	-68.52	0.87	6.66	V	Pass



Band :	WCDMA Band V for CH4182	Temperature :	22~23°C						
Test Mode :	RMC 12.2Kbps Link (QPSK)	Relative Humidity :	42~43%						
Test Engineer :	Star Wei	Polarization :	Horizontal						
Remark :	Spurious emissions within 30-1000MHz were found more than 20dB below limit line.								
Frequency (MHz)	ERP (dBm)	Limit (dBm)	Over Limit (dB)	SPA Reading (dBm)	S.G. Power (dBm)	TX Cable loss (dB)	TX Antenna Gain (dBi)	Polarization (H/V)	Result
1674	-63.76	-13	-50.76	-57.49	-64.41	0.57	3.37	H	Pass
2509	-67.87	-13	-54.87	-66.54	-70.10	0.78	5.16	H	Pass
3344	-65.10	-13	-52.10	-64.73	-68.74	0.87	6.66	H	Pass

Band :	WCDMA Band V for CH4182	Temperature :	22~23°C						
Test Mode :	RMC 12.2Kbps Link (QPSK)	Relative Humidity :	42~43%						
Test Engineer :	Star Wei	Polarization :	Vertical						
Remark :	Spurious emissions within 30-1000MHz were found more than 20dB below limit line.								
Frequency (MHz)	ERP (dBm)	Limit (dBm)	Over Limit (dB)	SPA Reading (dBm)	S.G. Power (dBm)	TX Cable loss (dB)	TX Antenna Gain (dBi)	Polarization (H/V)	Result
1670	-62.14	-13	-49.14	-60.60	-62.79	0.57	3.37	V	Pass
2509	-64.04	-13	-51.04	-66.47	-66.27	0.78	5.16	V	Pass
3344	-65.38	-13	-52.38	-66.44	-69.02	0.87	6.66	V	Pass



Band :	WCDMA Band V for CH4233				Temperature :	22~23°C			
Test Mode :	RMC 12.2Kbps Link (QPSK)				Relative Humidity :	42~43%			
Test Engineer :	Star Wei				Polarization :	Horizontal			
Remark :	Spurious emissions within 30-1000MHz were found more than 20dB below limit line.								
Frequency (MHz)	ERP (dBm)	Limit (dBm)	Over Limit (dB)	SPA Reading (dBm)	S.G. Power (dBm)	TX Cable loss (dB)	TX Antenna Gain (dBi)	Polarization (H/V)	Result
1693	-71.71	-13	-58.71	-62.83	-72.36	0.57	3.37	H	Pass
2540	-65.62	-13	-52.62	-64.29	-67.85	0.78	5.16	H	Pass
3386	-67.00	-13	-54.00	-66.63	-70.64	0.87	6.66	H	Pass

Band :	WCDMA Band V for CH4233				Temperature :	22~23°C			
Test Mode :	RMC 12.2Kbps Link (QPSK)				Relative Humidity :	42~43%			
Test Engineer :	Star Wei				Polarization :	Vertical			
Remark :	Spurious emissions within 30-1000MHz were found more than 20dB below limit line.								
Frequency (MHz)	ERP (dBm)	Limit (dBm)	Over Limit (dB)	SPA Reading (dBm)	S.G. Power (dBm)	TX Cable loss (dB)	TX Antenna Gain (dBi)	Polarization (H/V)	Result
1692	-69.13	-13	-56.13	-65.33	-69.78	0.57	3.37	V	Pass
2539	-63.85	-13	-50.85	-66.28	-66.08	0.78	5.16	V	Pass
3386	-64.73	-13	-51.73	-65.79	-68.37	0.87	6.66	V	Pass



Band :	WCDMA Band IV for CH1312	Temperature :	22~23°C						
Test Mode :	RMC 12.2Kbps Link (QPSK)	Relative Humidity :	42~43%						
Test Engineer :	Star Wei	Polarization :	Horizontal						
Remark :	Spurious emissions within 30-1000MHz were found more than 20dB below limit line.								
Frequency (MHz)	EIRP (dBm)	Limit (dBm)	Over Limit (dB)	SPA Reading (dBm)	S.G. Power (dBm)	TX Cable loss (dB)	TX Antenna Gain (dBi)	Polarization (H/V)	Result
3423	-63.52	-13	-50.52	-65.75	-68.92	2.2	7.60	H	Pass
5137	-56.38	-13	-43.38	-66.25	-63.16	3.12	9.90	H	Pass
6849	-58.15	-13	-45.15	-66.44	-66.04	2.98	10.87	H	Pass

Band :	WCDMA Band IV for CH1312	Temperature :	22~23°C						
Test Mode :	RMC 12.2Kbps Link (QPSK)	Relative Humidity :	42~43%						
Test Engineer :	Star Wei	Polarization :	Vertical						
Remark :	Spurious emissions within 30-1000MHz were found more than 20dB below limit line.								
Frequency (MHz)	EIRP (dBm)	Limit (dBm)	Over Limit (dB)	SPA Reading (dBm)	S.G. Power (dBm)	TX Cable loss (dB)	TX Antenna Gain (dBi)	Polarization (H/V)	Result
3423	-65.19	-13	-52.19	-66.21	-70.59	2.2	7.6	V	Pass
5137	-57.24	-13	-44.24	-65.21	-64.02	3.12	9.9	V	Pass
6849	-55.98	-13	-42.98	-66.5	-63.87	2.98	10.87	V	Pass



Band :	WCDMA Band IV for CH1413	Temperature :	22~23°C						
Test Mode :	RMC 12.2Kbps Link (QPSK)	Relative Humidity :	42~43%						
Test Engineer :	Star Wei	Polarization :	Horizontal						
Remark :	Spurious emissions within 30-1000MHz were found more than 20dB below limit line.								
Frequency (MHz)	EIRP (dBm)	Limit (dBm)	Over Limit (dB)	SPA Reading (dBm)	S.G. Power (dBm)	TX Cable loss (dB)	TX Antenna Gain (dBi)	Polarization (H/V)	Result
3465	-62.99	-13	-49.99	-65.22	-68.39	2.2	7.60	H	Pass
5197	-56.92	-13	-43.92	-66.79	-63.70	3.12	9.90	H	Pass
6930	-58.16	-13	-45.16	-66.45	-66.05	2.98	10.87	H	Pass

Band :	WCDMA Band IV for CH1413	Temperature :	22~23°C						
Test Mode :	RMC 12.2Kbps Link (QPSK)	Relative Humidity :	42~43%						
Test Engineer :	Star Wei	Polarization :	Vertical						
Remark :	Spurious emissions within 30-1000MHz were found more than 20dB below limit line.								
Frequency (MHz)	EIRP (dBm)	Limit (dBm)	Over Limit (dB)	SPA Reading (dBm)	S.G. Power (dBm)	TX Cable loss (dB)	TX Antenna Gain (dBi)	Polarization (H/V)	Result
3465	-64.25	-13	-51.25	-65.27	-69.65	2.2	7.6	V	Pass
5196	-54.98	-13	-41.98	-62.96	-61.76	3.12	9.9	V	Pass
6930	-55.37	-13	-42.37	-65.89	-63.26	2.98	10.87	V	Pass



Band :	WCDMA Band IV for CH1513	Temperature :	22~23°C						
Test Mode :	RMC 12.2Kbps Link (QPSK)	Relative Humidity :	42~43%						
Test Engineer :	Star Wei	Polarization :	Horizontal						
Remark :	Spurious emissions within 30-1000MHz were found more than 20dB below limit line.								
Frequency (MHz)	EIRP (dBm)	Limit (dBm)	Over Limit (dB)	SPA Reading (dBm)	S.G. Power (dBm)	TX Cable loss (dB)	TX Antenna Gain (dBi)	Polarization (H/V)	Result
3504	-62.60	-13	-49.60	-64.83	-68.00	2.2	7.60	H	Pass
5257	-56.04	-13	-43.04	-65.91	-62.82	3.12	9.90	H	Pass
7011	-58.70	-13	-45.70	-66.99	-66.59	2.98	10.87	H	Pass

Band :	WCDMA Band IV for CH1513	Temperature :	22~23°C						
Test Mode :	RMC 12.2Kbps Link (QPSK)	Relative Humidity :	42~43%						
Test Engineer :	Star Wei	Polarization :	Vertical						
Remark :	Spurious emissions within 30-1000MHz were found more than 20dB below limit line.								
Frequency (MHz)	EIRP (dBm)	Limit (dBm)	Over Limit (dB)	SPA Reading (dBm)	S.G. Power (dBm)	TX Cable loss (dB)	TX Antenna Gain (dBi)	Polarization (H/V)	Result
3504	-64.55	-13	-51.55	-65.57	-69.95	2.2	7.6	V	Pass
5257	-59.31	-13	-46.31	-67.28	-66.09	3.12	9.9	V	Pass
7011	-55.86	-13	-42.86	-66.38	-63.75	2.98	10.87	V	Pass



Band :	WCDMA Band II for CH9262	Temperature :	22~23°C						
Test Mode :	RMC 12.2Kbps Link (QPSK)	Relative Humidity :	42~43%						
Test Engineer :	Star Wei	Polarization :	Horizontal						
Remark :	Spurious emissions within 30-1000MHz were found more than 20dB below limit line.								
Frequency (MHz)	EIRP (dBm)	Limit (dBm)	Over Limit (dB)	SPA Reading (dBm)	S.G. Power (dBm)	TX Cable loss (dB)	TX Antenna Gain (dBi)	Polarization (H/V)	Result
3705	-63.42	-13	-50.42	-66.77	-69.80	0.78	7.16	H	Pass
5557	-57.22	-13	-44.22	-67.28	-65.76	1.04	9.58	H	Pass
7410	-53.42	-13	-40.42	-64.96	-63.53	1.35	11.46	H	Pass

Band :	WCDMA Band II for CH9262	Temperature :	22~23°C						
Test Mode :	RMC 12.2Kbps Link (QPSK)	Relative Humidity :	42~43%						
Test Engineer :	Star Wei	Polarization :	Vertical						
Remark :	Spurious emissions within 30-1000MHz were found more than 20dB below limit line.								
Frequency (MHz)	EIRP (dBm)	Limit (dBm)	Over Limit (dB)	SPA Reading (dBm)	S.G. Power (dBm)	TX Cable loss (dB)	TX Antenna Gain (dBi)	Polarization (H/V)	Result
3705	-58.57	-13	-45.57	-66.97	-64.95	0.78	7.16	V	Pass
5557	-54.25	-13	-41.25	-66.9	-62.79	1.04	9.58	V	Pass
7410	-52.89	-13	-39.89	-66.98	-63.00	1.35	11.46	V	Pass



Band :	WCDMA Band II for CH9400	Temperature :	22~23°C						
Test Mode :	RMC 12.2Kbps Link (QPSK)	Relative Humidity :	42~43%						
Test Engineer :	Star Wei	Polarization :	Horizontal						
Remark :	Spurious emissions within 30-1000MHz were found more than 20dB below limit line.								
Frequency (MHz)	EIRP (dBm)	Limit (dBm)	Over Limit (dB)	SPA Reading (dBm)	S.G. Power (dBm)	TX Cable loss (dB)	TX Antenna Gain (dBi)	Polarization (H/V)	Result
3759	-62.61	-13	-49.61	-65.96	-68.99	0.78	7.16	H	Pass
5640	-57.69	-13	-44.69	-67.75	-66.23	1.04	9.58	H	Pass
7521	-54.84	-13	-41.84	-66.38	-64.95	1.35	11.46	H	Pass

Band :	WCDMA Band II for CH9400	Temperature :	22~23°C						
Test Mode :	RMC 12.2Kbps Link (QPSK)	Relative Humidity :	42~43%						
Test Engineer :	Star Wei	Polarization :	Vertical						
Remark :	Spurious emissions within 30-1000MHz were found more than 20dB below limit line.								
Frequency (MHz)	EIRP (dBm)	Limit (dBm)	Over Limit (dB)	SPA Reading (dBm)	S.G. Power (dBm)	TX Cable loss (dB)	TX Antenna Gain (dBi)	Polarization (H/V)	Result
3759	-58.67	-13	-45.67	-67.07	-65.05	0.78	7.16	V	Pass
5640	-54.90	-13	-41.90	-67.55	-63.44	1.04	9.58	V	Pass
7521	-51.95	-13	-38.95	-66.04	-62.06	1.35	11.46	V	Pass



Band :	WCDMA Band II for CH9538	Temperature :	22~23°C						
Test Mode :	RMC 12.2Kbps Link (QPSK)	Relative Humidity :	42~43%						
Test Engineer :	Star Wei	Polarization :	Horizontal						
Remark :	Spurious emissions within 30-1000MHz were found more than 20dB below limit line.								
Frequency (MHz)	EIRP (dBm)	Limit (dBm)	Over Limit (dB)	SPA Reading (dBm)	S.G. Power (dBm)	TX Cable loss (dB)	TX Antenna Gain (dBi)	Polarization (H/V)	Result
3816	-63.86	-13	-50.86	-67.21	-70.24	0.78	7.16	H	Pass
5723	-57.52	-13	-44.52	-67.58	-66.06	1.04	9.58	H	Pass
7629	-54.48	-13	-41.48	-66.02	-64.59	1.35	11.46	H	Pass

Band :	WCDMA Band II for CH9538	Temperature :	22~23°C						
Test Mode :	RMC 12.2Kbps Link (QPSK)	Relative Humidity :	42~43%						
Test Engineer :	Star Wei	Polarization :	Vertical						
Remark :	Spurious emissions within 30-1000MHz were found more than 20dB below limit line.								
Frequency (MHz)	EIRP (dBm)	Limit (dBm)	Over Limit (dB)	SPA Reading (dBm)	S.G. Power (dBm)	TX Cable loss (dB)	TX Antenna Gain (dBi)	Polarization (H/V)	Result
3816	-58.33	-13	-45.33	-66.73	-64.71	0.78	7.16	V	Pass
5723	-55.57	-13	-42.57	-68.22	-64.11	1.04	9.58	V	Pass
7629	-52.87	-13	-39.87	-66.96	-62.98	1.35	11.46	V	Pass



3.8 Frequency Stability Measurement

3.8.1 Description of Frequency Stability Measurement

The frequency stability shall be measured by variation of ambient temperature and variation of primary supply voltage to ensure that the fundamental emission stays within the authorized frequency block. The frequency stability of the transmitter shall be maintained within $\pm 0.00025\%$ ($\pm 2.5\text{ppm}$) of the center frequency.

3.8.2 Measuring Instruments

The measuring equipment is listed in the section 4 of this test report.

3.8.3 Test Procedures for Temperature Variation

1. The testing follows FCC KDB 971168 v02r01 Section 9.0.
2. The EUT was set up in the thermal chamber and connected with the system simulator.
3. With power OFF, the temperature was decreased to -30°C and the EUT was stabilized before testing. Power was applied and the maximum change in frequency was recorded within one minute.
4. With power OFF, the temperature was raised in 10°C steps up to 50°C . The EUT was stabilized at each step for at least half an hour. Power was applied and the maximum frequency change was recorded within one minute.

3.8.4 Test Procedures for Voltage Variation

1. The testing follows FCC KDB 971168 v02r01 Section 9.0.
2. The EUT was placed in a temperature chamber at $25\pm 5^{\circ}\text{C}$ and connected with the system simulator.
3. The power supply voltage to the EUT was varied from BEP to 115% of the nominal value measured at the input to the EUT.
4. The variation in frequency was measured for the worst case.

3.8.5 Test Setup

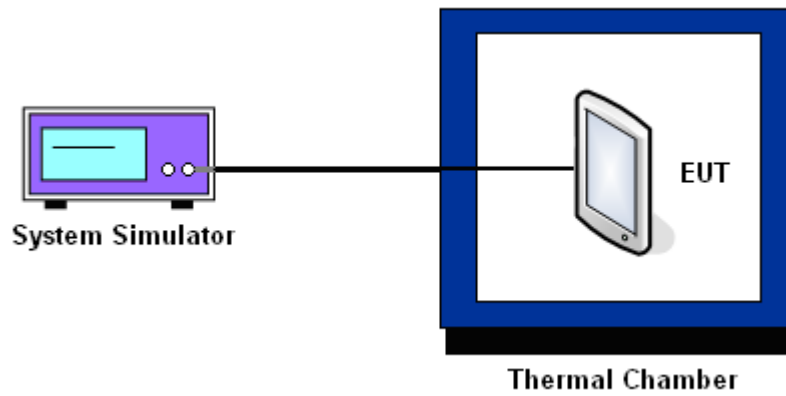



3.8.6 Test Result of Temperature Variation

Band :	GSM 850	Channel :	189
Limit (ppm) :	2.5	Frequency :	836.4 MHz

Temperature (°C)	GPRS class 8	EDGE class 8	Result
	Deviation (ppm)	Deviation (ppm)	
-30	+0.05	+0.04	PASS
-20	+0.04	+0.03	
-10	+0.04	+0.02	
0	+0.02	+0.02	
10	+0.02	+0.02	
20(Ref.)	+0.00	+0.00	
30	+0.02	+0.02	
40	+0.02	+0.02	
50	+0.02	+0.02	

Band :	GSM 1900	Channel :	661
Limit (ppm) :	within authorized band	Frequency :	1880.0 MHz

Temperature (°C)	GPRS class 8	EDGE class 8	Result
	Deviation (ppm)	Deviation (ppm)	
-30	+0.03	+0.02	PASS
-20	+0.03	+0.02	
-10	+0.02	+0.02	
0	+0.02	+0.02	
10	+0.02	+0.02	
20(Ref.)	+0.00	+0.00	
30	+0.02	+0.02	
40	+0.02	+0.02	
50	+0.03	+0.02	



Band :	WCDMA Band V	Channel :	4182
Limit (ppm) :	2.5	Frequency :	836.4 MHz

Temperature (°C)	RMC 12.2Kbps		Result
	Deviation (ppm)		
-30	+0.04		PASS
-20	+0.04		
-10	+0.02		
0	+0.01		
10	+0.02		
20(Ref.)	+0.00		
30	+0.02		
40	+0.02		
50	+0.02		

Band :	WCDMA Band IV	Channel :	1413
Limit (ppm) :	within authorized band	Frequency :	1732.6 MHz

Temperature (°C)	RMC 12.2Kbps		Result
	Deviation (ppm)		
-30	+0.01		PASS
-20	+0.01		
-10	+0.01		
0	+0.01		
10	+0.01		
20(Ref.)	+0.00		
30	+0.01		
40	+0.01		
50	+0.01		



Band :	WCDMA Band II	Channel :	9400
Limit (ppm) :	within authorized band	Frequency :	1880.0 MHz

Temperature (°C)	RMC 12.2Kbps		Result
	Deviation (ppm)		
-30	+0.01		PASS
-20	+0.01		
-10	+0.01		
0	+0.01		
10	+0.01		
20(Ref.)	+0.00		
30	+0.01		
40	+0.01		
50	+0.01		



3.8.7 Test Result of Voltage Variation

Band & Channel	Mode	Voltage (Volt)	Freq. Dev. (Hz)	Deviation (ppm)	Limit (ppm)	Result
GSM 850 CH189	GPRS class 8	3.8	15	+0.02	2.5	PASS
		BEP	17	+0.02		
		4.2	16	+0.02		
	EDGE class 8	3.8	15	+0.02		
		BEP	16	+0.02		
		4.2	18	+0.02		
GSM 1900 CH661	GPRS class 8	3.8	40	+0.02		
		BEP	42	+0.02		
		4.2	44	+0.02		
	EDGE class 8	3.8	35	+0.02		
		BEP	34	+0.02		
		4.2	38	+0.02		
WCDMA Band V CH4182	RMC 12.2Kbps	3.8	15	+0.02		
		BEP	17	+0.02		
		4.2	15	+0.02		
WCDMA Band IV CH1413	RMC 12.2Kbps	3.8	11	+0.01		
		BEP	13	+0.01		
		4.2	11	+0.01		
WCDMA Band II CH9400	RMC 12.2Kbps	3.8	10	+0.01		
		BEP	10	+0.01		
		4.2	12	+0.01		

Note:

1. Normal Voltage = 3.8V.
2. Battery End Point (BEP) = 3.6 V.



4 List of Measuring Equipment

Instrument	Manufacturer	Model No.	Serial No.	Characteristics	Calibration Date	Test Date	Due Date	Remark
Spectrum Analyzer	R&S	FSV40	101078	10Hz~40GHz	May 08, 2014	Jul. 12, 2014~ Aug. 22, 2014	May 07, 2015	Conducted (TH01-SZ)
Spectrum Analyzer	R&S	FSP30	101400	9kHz~30GHz	Mar. 03, 2014	Jul. 12, 2014~ Aug. 22, 2014	Mar. 02, 2015	Conducted (TH01-SZ)
Thermal Chamber	Hongzhangroup	LP-150U	HD20120425	-40℃~150℃	Feb. 21, 2014	Jul. 12, 2014~ Aug. 22, 2014	Feb. 20, 2015	Conducted (TH01-SZ)
EMI Test Receiver	R&S	ESCI	100534	9kHz~3GHz	Nov. 05, 2013	Aug. 12, 2014	Nov. 04, 2014	Radiation (03CH01-KS)
Spectrum Analyzer	R&S	FSP30	101399	9kHz~30GHz	May 04, 2014	Aug. 12, 2014	May 03, 2015	Radiation (03CH01-KS)
Bilog Antenna	SCHAFFNER	CBL6112D	23182	25MHz~2GHz	Jan. 08, 2014	Aug. 12, 2014	Jan. 07, 2015	Radiation (03CH01-KS)
Double Ridge Horn Antenna	ETS-Lindgren	3117	75959	1GHz~18GHz	Jan. 08, 2014	Aug. 12, 2014	Jan. 07, 2015	Radiation (03CH01-KS)
Active Horn Antenna	com-power	AHA-118	701030	1GHz~18GHz	Nov. 18, 2013	Aug. 12, 2014	Nov. 17, 2014	Radiation (03CH01-KS)
SHF-EHF Horn	Schwarzbeck	BBHA 9170	BBHA170249	15GHz~40GHz	Mar. 10, 2014	Aug. 12, 2014	Mar. 09, 2015	Radiation (03CH01-KS)
Amplifier	com-power	PA-103A	161073	1MHz~1GHz	May 04, 2014	Aug. 12, 2014	May 03, 2015	Radiation (03CH01-KS)
Amplifier	Agilent	8449B	3008A02371	1GHz~26.5GHz	Dec. 10, 2013	Aug. 12, 2014	Dec. 09, 2014	Radiation (03CH01-KS)
AC Power Source	Chroma	61601	F104090004	N/A	NCR	Aug. 12, 2014	NCR	Radiation (03CH01-KS)
Turn Table	MF	MF7802	N/A	0~360 degree	NCR	Aug. 12, 2014	NCR	Radiation (03CH01-KS)
Antenna Mast	MF	MF7802	N/A	1 m~4 m	NCR	Aug. 12, 2014	NCR	Radiation (03CH01-KS)



5 Uncertainty of Evaluation

Uncertainty of Radiated Emission Measurement (30 MHz ~ 1000 MHz)

Measuring Uncertainty for a Level of Confidence of 95% ($U = 2Uc(y)$)	2.5
---	-----