



FCC 47 CFR PART 15 SUBPART C

TEST REPORT

For

Notebook Computer

Regulatory Model: PP30LA

Regulatory Type: PP30LA001

Trade Name: DELL

Issued to

**Dell Computer Corporation
ONE DELL WAY, ROUND ROCK, TEXAS 78682, U.S.A.**

Issued by

**Compliance Certification Services Inc.
No. 81-1, Lane 210, Pa-De 2nd Rd., Luchu Hsiang,
Taoyuan Shien, (338) Taiwan, R.O.C.
TEL: 886-3-324-0332
FAX: 886-3-324-5235
<http://www.ccsrf.com>
service@ccsrf.com**



Note: This report shall not be reproduced except in full, without the written approval of Compliance Certification Services Inc. This document may be altered or revised by Compliance Certification Services Inc. personnel only, and shall be noted in the revision section of the document. The client should not use it to claim product endorsement by TAF, A2LA, NIST or any government agencies. The test results in the report only apply to the tested sample.



Revision History

Rev.	Issue Date	Revisions	Effect Page	Revised By
00	Dec. 22, 2009	Initial Issue	ALL	Jill Shiau



TABLE OF CONTENTS

1	TEST RESULT CERTIFICATION	4
2	EUT DESCRIPTION	5
3	TEST METHODOLOGY	6
3.1.	EUT CONFIGURATION	6
3.2.	EUT EXERCISE	6
3.3.	GENERAL TEST PROCEDURES	6
3.4.	FCC PART 15.205 RESTRICTED BANDS OF OPERATIONS.....	7
3.5.	DESCRIPTION OF TEST MODES.....	8
4	INSTRUMENT CALIBRATION	9
4.1.	MEASURING INSTRUMENT CALIBRATION	9
4.2.	MEASUREMENT EQUIPMENT USED	9
4.3.	MEASUREMENT UNCERTAINTY	10
5	FACILITIES AND ACCREDITATIONS	11
5.1.	FACILITIES	11
5.2.	EQUIPMENT	11
5.3.	TABLE OF ACCREDITATIONS AND LISTINGS.....	12
6	SETUP OF EQUIPMENT UNDER TEST	13
6.1.	SETUP CONFIGURATION OF EUT	13
6.2.	SUPPORT EQUIPMENT	13
7	FCC PART 15.225 REQUIREMENTS	14
7.1.	RADIATED EMISSIONS	14
7.2.	FREQUENCY STABILITY	19
7.3.	POWERLINE CONDUCTED EMISSIONS	21
	APPENDIX I PHOTOGRAPHS OF TEST SETUP	24



1 TEST RESULT CERTIFICATION

Applicant: **Dell Computer Corporation**
ONE DELL WAY, ROUND ROCK, TEXAS 78682, U.S.A.

Equipment Under Test: Notebook Computer

Trade Name: DELL

Regulatory Model: PP30LA

Regulatory Type: PP30LA001

Date of Test: December 14, 2009 ~ January 26, 2010

APPLICABLE STANDARDS	
STANDARD	TEST RESULT
FCC 47 CFR Part 15 Subpart C	No non-compliance noted

We hereby certify that:

The above equipment was tested by Compliance Certification Services Inc. The test data, data evaluation, test procedures, and equipment configurations shown in this report were made in accordance with the procedures given in ANSI C63.4: 2003 and the energy emitted by the sample tested as described in this report is in compliance with the requirements of FCC Rules Part 15.207, 15.209, 15.225.

The test results of this report relate only to the tested sample identified in this report.

Approved by:

Ethan Huang
Section Manager

Reviewed by:

Stan Lin
Supervisor



2 EUT DESCRIPTION

Product	Notebook Computer		
Trade Name	DELL		
Regulatory Model	PP30LA		
Regulatory Type	PP30LA001		
Model Difference	N/A		
EUT Power Rating	19.5VDC, 4.62A		
Power Adapter Manufacturer	DELL	Model	LA90PE0-01
Power Adapter Power Rating	I/P: 100-240Vac, 50-60Hz, 1.5A O/P: 19.5V, 4.62A		
Operating Frequency Range	13.56MHz		
Modulation Technique	ASK		
Number of Channels	1 Channels		
Antenna Specification	Coil Antenna		

Remark:

1. The sample selected for test was engineering sample that approximated to production product and was provided by manufacturer.
2. This submittal(s) (test report) is intended for **FCC ID: E2K-PP30LA** filing to comply with Section 15.225 of the FCC Part 15, Subpart C Rules.



3 TEST METHODOLOGY

The tests documented in this report were performed in accordance with ANSI C63.4 (2003) and FCC CFR 47 Part 2, 15.207, 15.209 and 15.225.

3.1. EUT CONFIGURATION

The EUT configuration for testing is installed on RF field strength measurement to meet the Commissions requirement and operating in a manner that intends to maximize its emission characteristics in a continuous normal application.

3.2. EUT EXERCISE

The EUT was operated in the engineering mode to fix the TX frequency that was for the purpose of the measurements.

3.3. GENERAL TEST PROCEDURES

Conducted Emissions

The EUT is placed on the turntable, which is 0.8 m above ground plane. According to the requirements in Section 13.1.4.1 of ANSI C63.4 (2003). Conducted emissions from the EUT measured in the frequency range between 0.15 MHz and 30MHz using CISPR Quasi-peak and average detector modes.

Radiated Emissions

The EUT is placed on a turn table, which is 0.8 m above ground plane. The turntable shall rotate 360 degrees to determine the position of maximum emission level. EUT is set 3m away from the receiving antenna, which varied from 1m to 4m to find out the highest emission. And also, each emission was to be maximized by changing the polarization of receiving antenna both horizontal and vertical. In order to find out the maximum emissions, exploratory radiated emission measurements were made according to the requirements in Section 13.1.4.1 of ANSI C63.4 (2003).



3.4. FCC PART 15.205 RESTRICTED BANDS OF OPERATIONS

(a) Except as shown in paragraph (d) of this section, only spurious emissions are permitted in any of the frequency bands listed below:

Table with 4 columns: MHz, MHz, MHz, GHz. It lists various frequency ranges such as 0.090 - 0.110, 16.42 - 16.423, 399.9 - 410, and 4.5 - 5.15.

1 Until February 1, 1999, this restricted band shall be 0.490-0.510 MHz.

2 Above 38.6

(b) Except as provided in paragraphs (d) and (e), the field strength of emissions appearing within these frequency bands shall not exceed the limits shown in Section 15.209. At frequencies equal to or less than 1000 MHz, compliance with the limits in Section 15.209 shall be demonstrated using measurement instrumentation employing a CISPR quasi-peak detector. Above 1000 MHz, compliance with the emission limits in Section 15.209 shall be demonstrated based on the average value of the measured emissions. The provisions in Section 15.35 apply to these measurements.



3.5. DESCRIPTION OF TEST MODES

The difference of three mother board is VGA Chip, the detail see as below:

Mother Board Type	VGA Chip
Discrete	O
ASICS	O ^{** (01)}
UMA	X

**** (01):** The difference of Discrete and ASICS is VGA Chip.

The three mother board (Discrete, UMA and ASICS) have been pre-scanned during the test.

The mother board (ASICS) was selected as the worst case for final test.

The EUT had been tested under operating condition.

Software used to control the EUT for staying in continuous transmitting and receiving mode was programmed.

After verification, all tests carried out were with the worst-case test modes as shown below except radiated spurious emission worst case was in normal link mode with cradle.

RF ID: Channel 13.56MHz was chosen for full testing.

Pre-test Data

Discrete Type

Frequency (MHz)	Ant. Pol. (H/V)	Detector Mode (PK/QP/AVG)	Reading (dBuV)	Correction Factor (dB/m)	Result		Limit 3m (dBuA/m)	Margin (dBuA/m)
					(dBuV/m)	(dBuA/m)		
13.56	V	Peak	40.24	9.59	49.83	-1.67	80.00	-81.67
13.56	H	Peak	39.60	9.59	49.19	-2.31	80.00	-82.31

UMA Type

Frequency (MHz)	Ant. Pol. (H/V)	Detector Mode (PK/QP/AVG)	Reading (dBuV)	Correction Factor (dB/m)	Result		Limit 3m (dBuA/m)	Margin (dBuA/m)
					(dBuV/m)	(dBuA/m)		
13.56	V	Peak	40.08	9.59	49.67	-1.83	80.00	-81.83
13.56	H	Peak	41.52	9.59	51.11	-0.39	80.00	-80.39

ASICS Type

Frequency (MHz)	Ant. Pol. (H/V)	Detector Mode (PK/QP/AVG)	Reading (dBuV)	Correction Factor (dB/m)	Result		Limit 3m (dBuA/m)	Margin (dBuA/m)
					(dBuV/m)	(dBuA/m)		
13.56	V	Peak	41.42	9.59	51.01	-0.49	80.00	-80.49
13.56	H	Peak	41.71	9.59	51.30	-0.20	80.00	-80.20



4 INSTRUMENT CALIBRATION

4.1. MEASURING INSTRUMENT CALIBRATION

The measuring equipment, which was utilized in performing the tests documented herein, has been calibrated in accordance with the manufacturer's recommendations for utilizing calibration equipment, which is traceable to recognized national standards.

4.2. MEASUREMENT EQUIPMENT USED

Equipment Used for Emissions Measurement

Remark: Each piece of equipment is scheduled for calibration once a year.

Powerline Conducted Emissions Test Site				
Name of Equipment	Manufacturer	Model	Serial Number	Calibration Due
Spectrum Analyzer	Agilent	E4446A	MY48250064	11/05/2010
Spectrum Analyzer	R&S	FSEB	825829/011	11/02/2010
USB Power Sensor	BOONTON	52012	2061194	06/08/2010

3M Chamber Test Site				
Name of Equipment	Manufacturer	Model	Serial Number	Calibration Due
Spectrum Analyzer	Agilent	E4446A	MY48250064	11/05/2010
Spectrum Analyzer	R&S	FSEB	825829/011	10/29/2010
Pre-Amplifier	HP	8447D	2944A06530	12/31/2009
Pre-Amplifier	HP	8449B	3008A01738	04/17/2010
EMI Test Receiver	SCHAFFNER	SCR 3501	436	01/21/2010
Loop Antenna	EMCO	6502	2356	05/28/2010
Bilog Antenna	SCHWAZBECK	VULB9160	3084	09/11/2010
Horn Antenna	EMCO	3115	00022250	05/08/2010
Turn Table	CCS	CC-T-1F	N/A	N.C.R
Antenna Tower	CCS	CC-A-1F	N/A	N.C.R
Controller	CCS	CC-C-1F	N/A	N.C.R
Test S/W	LabVIEW 6.1 (Wugu Chamber EMI Test V1_4.5.3)			



Powerline Conducted Emissions Test Site				
Name of Equipment	Manufacturer	Model	Serial Number	Calibration Due
EMI Test Receiver	R&S	ESCI	100782	06/01/2010
LISN	R&S	ENV216	100066	05/06/2010
LISN	R&S	ENV 4200	830326/016	04/15/2010
Test S/W	CCS-3A1-CE-Luchu			

4.3. MEASUREMENT UNCERTAINTY

Parameter	Uncertainty
Powerline Conducted Emission	± 1.7983
3M Semi Anechoic Chamber / 30MHz ~ 1GHz	± 4.0235
3M Semi Anechoic Chamber / Above 1GHz	± 3.87318

Remark: This uncertainty represents an expanded uncertainty expressed at approximately the 95% confidence level using a coverage factor of $k=2$.



5 FACILITIES AND ACCREDITATIONS

5.1. FACILITIES

All measurement facilities used to collect the measurement data are located at

- No.199, Chunghsen Road, Hsintien City, Taipei Hsien, Taiwan, R.O.C.
Tel: 886-2-2217-0894 / Fax: 886-2-2217-1029

- No.11, Wugong 6th Rd., Wugu Industrial Park, Taipei Hsien 248, Taiwan
Tel: 886-2-2299-9720 / Fax: 886-2-2298-4045

- No. 81-1, Lane 210, Pa-De 2nd Rd., Luchu Hsiang, Taoyuan Shien, (338) Taiwan, R.O.C.
Tel: 886-3-324-0332 / Fax: 886-3-324-5235

The sites are constructed in conformance with the requirements of ANSI C63.7, ANSI C63.4 (2003) and CISPR Publication 22.

5.2. EQUIPMENT



Radiated emissions are measured with one or more of the following types of linearly polarized antennas: tuned dipole, biconical, log periodic, bi-log, and/or ridged waveguide, horn. Spectrum analyzers with pre-selectors and quasi-peak detectors are used to perform radiated measurements.

Conducted emissions are measured with Line Impedance Stabilization Networks and EMI Test Receivers.

Calibrated wideband preamplifiers, coaxial cables, and coaxial attenuators are also used for making measurements.

All receiving equipment conforms to CISPR Publication 16-1, "Radio Interference Measuring Apparatus and Measurement Methods."

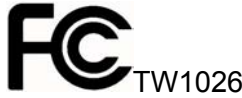
5.3. TABLE OF ACCREDITATIONS AND LISTINGS

Country	Agency	Scope of Accreditation	Logo
USA	A2LA	CFR 47, FCC Part15/18, CISPR 22, EN 55022, ICES-003, AS/NZS CISPR 22, VCCI V-3, EN 55011, CISPR 11, IEC/EN 61000-4-2/3/4/5/6/8/11, EN 61000-6-1/2/3/4, EN 55024, CISPR 24, AS/NZS CISPR 24, AS/NZS 61000.6.2, EN 55014-1/-2, ETSI EN 300 386 v1.3.2/v1.3.3, IEC/EN 61000-3-2, AS/NZS 61000.3.2, IEC/EN 61000-3-3, AS/NZS 61000.3.3	 ACCREDITED No. 0824-01
USA	FCC MRA	3/10 meter Open Area Test Sites to perform FCC Part 15/18 measurements	 TW1026
Japan	VCCI	3/10 meter Open Area Test Sites and conducted test sites to perform radiated/conducted measurements	VCCI R-2882/2541/2798/725/1868 C-402/747/912 T-321/325
Taiwan	TAF	EN 55014-1, CISPR 14, CNS 13781-1, EN 55013, CISPR 13, CNS 13439, EN 55011, CISPR 11, CNS 13803, PLMN09, IS2045-0, LP0002 FCC Part 27/90, Part 15B/C/D/E, RSS-192/193/210/310 ETSI EN 300 328/ 300 220-1/ 300 220-2/ 301 893/ 301 489-01/ 301 489-03/ 301 489-07 / 301 489-17/ 300 440-1/ 300 440-2 AS/NZS 4268, AS/NZS 4771 CISPR 22, EN 55022, CNS 13438, AS/NZS CISPR 22, VCCI, IEC/EN 61000-4-2/3/4/5/6/8/11, CNS 14676-2/3/4/5/6/8, CNS 14934-2/3, CNS 13783-1, CNS 13439, CNS 13803	 Testing Laboratory 0363
Taiwan	BSMI	CNS 13438, CNS 13783-1, CNS 13439, CNS 14115	SL2-IS-E-0014 / IN-E-0014 /A1-E-0014 /R1-E-0014 /R2-E-0014 /L1-E-0014
Canada	Industry Canada	RSS212, Issue 1	 IC 2324C-3 IC 2324C-5

Note: No part of this report may be used to claim or imply product endorsement by A2LA, TAF or other government agency.



6 SETUP OF EQUIPMENT UNDER TEST

6.1. SETUP CONFIGURATION OF EUT

See test photographs attached in Appendix 1 for the actual connections between EUT and support equipment.

6.2. SUPPORT EQUIPMENT

For Radiated Emission test

No.	Device Type	Brand	Model	Series No.	FCC ID	Data Cable	Power Cord
	N/A						

****No any support equipment during the test.**

For Powerline Conducted Emission test

No.	Device Type	Brand	Model	Series No.	FCC ID	Data Cable	Power Cord
1.	LCD Monitor	DELL	2407WFPb	CN-0FC255-46633-660-045S	FCC DoC	D-Sub Cable: Shielded, 1.8m with two cores	Unshielded, 1.8m
2.	USB Mouse	DELL	MO56UOA	F0Q01BKU	FCC DoC	Unshielded, 1.8m	N/A
3.	Traveling Disk	PQI	U172	C072001301649	FCC DoC	Unshielded, 1.8m	N/A
4.	Traveling Disk	PQI	U172	C072001303246	FCC DoC	Unshielded, 1.8m	N/A
5.	Traveling Disk	PQI	U172	C072001301616	FCC DoC	Unshielded, 1.8m	N/A
6.	e-SATA External HDD	ST-M10	A02170-F22-0 003	FCC DoC	Onnto	Unshielded, 1.8m	AC I/P: Unshielded, 1.8m DC O/P: Unshielded, 1.8m with a core
8.	Multimedia Headset	Logitech	ClearChat	N/A	FCC DoC	Shielded, 1.8m	N/A
9	V8	SONY	DCR-TRV320	N/A	FCC DoC	Unshielded, 1.8m	N/A
10	Notebook Computer (Remote)	DELL	D400	0932RY	E2K24GBRL	LAN Cable: Unshielded, 10m	AC I/P: Unshielded, 1.8m DC O/P: Unshielded, 1.8m with a core

Note: Grounding was established in accordance with the manufacturer's requirements and conditions for the intended use.



7 FCC PART 15.225 REQUIREMENTS

7.1. RADIATED EMISSIONS

LIMIT

According to §15.225,

- (a) The field strength of any emissions within the band 13.553 – 13.567 MHz shall not exceed 15,848 microvolts / meter at 30 meters.
- (b) Within the bands 13.410 – 13.553 MHz and 13.567 -13.710 MHz, the field strength of any emissions shall not exceed 334 microvolts / meter at 30 meters.
- (c) Within the bands 13.110 – 13.410 MHz and 13.710 – 14.010 MHz the field strength of any emissions shall not exceed 106 microvolts / meter at 30 meters.
- (d) The field strength of any emissions appearing outside of the 13.110 – 14.010 MHz and shall not exceed the general radiated emission limits in §15.209.

According to §15.225(a), except as provided elsewhere in this Subpart, the emissions from an intentional radiator shall not exceed the field strength levels specified in the following table:

Frequency (MHz)	Field Strength (µV/m at meter)	Measurement Distance (meter)
0.009 – 0.490	2400 / F (kHz)	300
0.490 – 1.705	24000 / F (kHz)	30
1.705 – 30.0	30	30
30 - 88	100**	3
88-216	150**	3
216-960	200**	3
Above 960	500	3

** Except as provided in paragraph (g), fundamental emissions from intentional radiators operating under this Section shall not be located in the frequency bands 54-72 MHz, 76-88 MHz, 174-216 MHz or 470-806 MHz. However, operation within these frequency bands is permitted under other sections of this Part, e.g., Sections 15.231 and 15.241.

TEST CONFIGURATION

9kHz ~ 30MHz

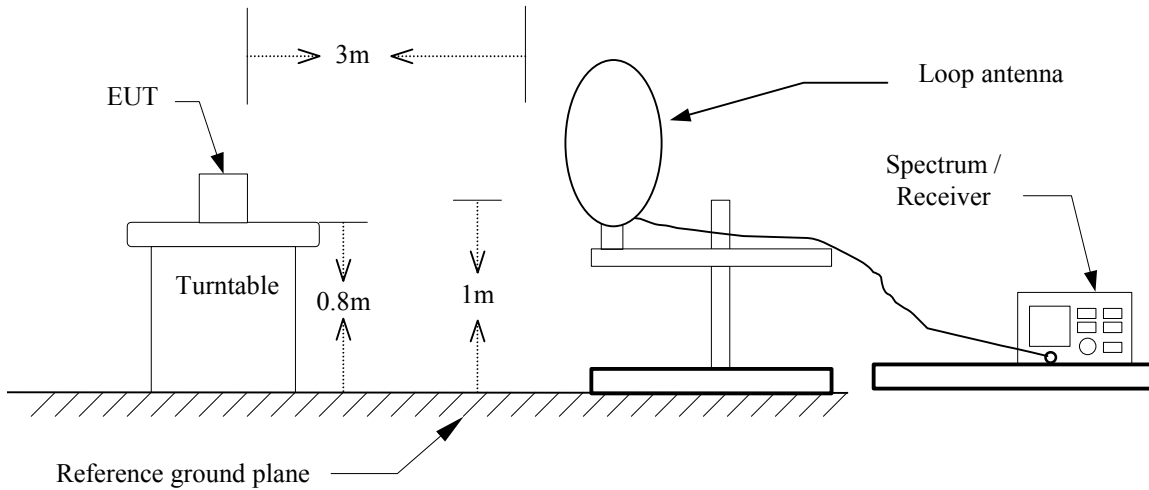

30MHz ~ 1 GHz

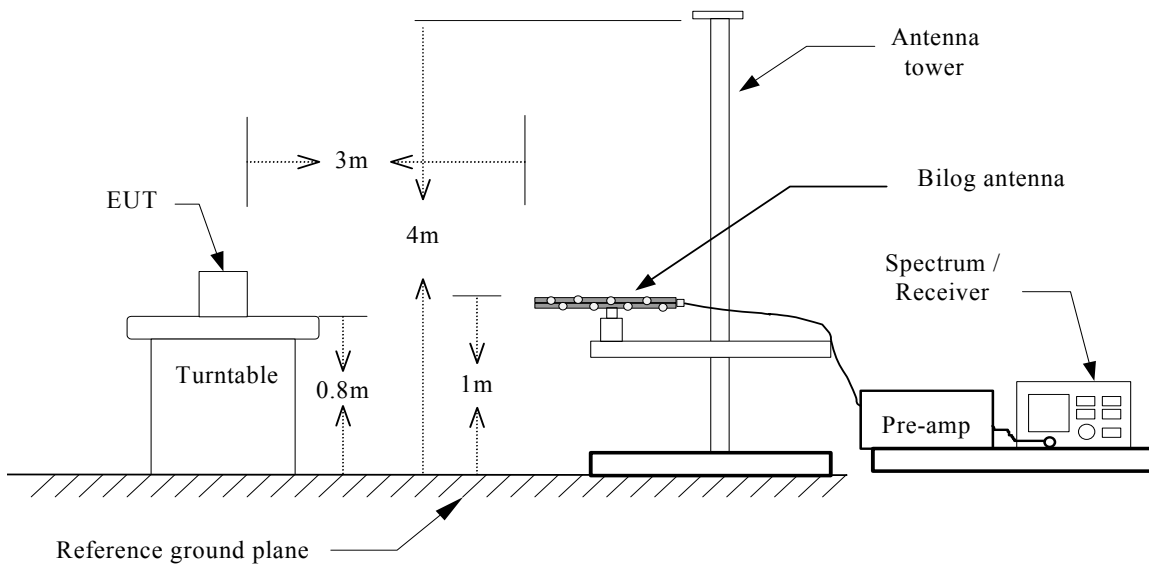



TEST PROCEDURE

1. The EUT is placed on a turntable, which is 0.8m above ground plane.
2. The turntable shall be rotated for 360 degrees to determine the position of maximum emission level.
3. EUT is set 3m away from the receiving antenna, which is varied from 1m to 4m to find out the highest emissions.
4. Maximum procedure was performed on the six highest emissions to ensure EUT compliance.
5. And also, each emission was to be maximized by changing the polarization of receiving antenna both horizontal and vertical.
6. Set the spectrum analyzer in the following setting as:
RBW=100kHz / VBW=300kHz / Sweep=AUTO
7. Repeat above procedures until the measurements for all frequencies are complete.

TEST RESULTS

No non-compliance noted.



TEST DATA

Operation Mode: TX mode **Test Date:** December 14 ~ 16, 2009
Temperature: 18°C **Tested by:** Alonso Lu
Humidity: 60 % RH **Polarity:** Ver. / Hor.

Frequency (MHz)	Ant.Pol. (H/V)	Detector Mode (PK/QP/AVG)	Reading (dBuV)	Correction Factor (dB/m)	Result (dBuV/m)	Limit 3m (dBuV/m)	Margin (dB)
13.5575	V	QP	41.42	9.59	51.01	124.00	-72.99
56.6750	V	QP	43.99	-15.03	28.96	40.00	-11.04
66.3750	V	QP	51.11	-17.29	33.82	40.00	-6.18
139.1250	V	QP	42.88	-12.44	30.44	43.50	-13.06
173.0750	V	QP	44.22	-13.99	30.23	43.50	-13.27
265.2250	V	QP	43.21	-12.17	31.04	46.00	-14.96
313.7250	V	QP	42.31	-10.72	31.59	46.00	-14.41
398.6000	V	QP	42.12	-9.48	32.64	46.00	-13.36
587.7500	V	QP	36.09	-4.54	31.55	46.00	-14.45
975.7500	V	QP	33.72	1.88	35.60	53.90	-18.30
13.5600	H	QP	41.71	9.59	51.30	124.00	-72.70
63.9500	H	QP	39.39	-16.66	22.73	40.00	-17.27
139.1250	H	QP	43.44	-12.44	31.00	43.50	-12.50
265.2250	H	QP	43.63	-12.17	31.46	46.00	-14.54
323.4250	H	QP	43.47	-10.44	33.03	46.00	-12.97
401.0250	H	QP	48.70	-9.45	39.25	46.00	-6.75
633.8250	H	QP	34.12	-4.62	29.50	46.00	-16.50
905.4250	H	QP	34.10	0.42	34.52	46.00	-11.48

Remark:

1. No emission found between lowest internal used / generated frequency to 30 MHz. (9kHz ~ 30MHz)
2. Measuring frequencies from 9 kHz to the 1GHz.
3. Radiated emissions measured in the measured frequency range were made with an instrument using peak detector or quasi-peak detector mode.
4. Data of measurement within this frequency range shown " --- " in the table above means the reading of emissions are attenuated more than 20dB below the permissible limits or the field strength is too small to be measured.
5. The IF bandwidth of SPA between 30MHz to 1GHz was 100kHz.
6. Calculation by Converting 30m to 3meter limits.
 $30m \text{ limit} = 15848 \text{ (uV/m)}$
 $**3m \text{ limit} = 20 * \log(15848) + 40 \log(30m/3m) \text{ (dBuV/m)}$
 $= 84 + 40 \text{ (dBuV/m)}$
 $= 124 \text{ (dBuV/m)}$



TEST PLOT FOR CHANNEL MASK

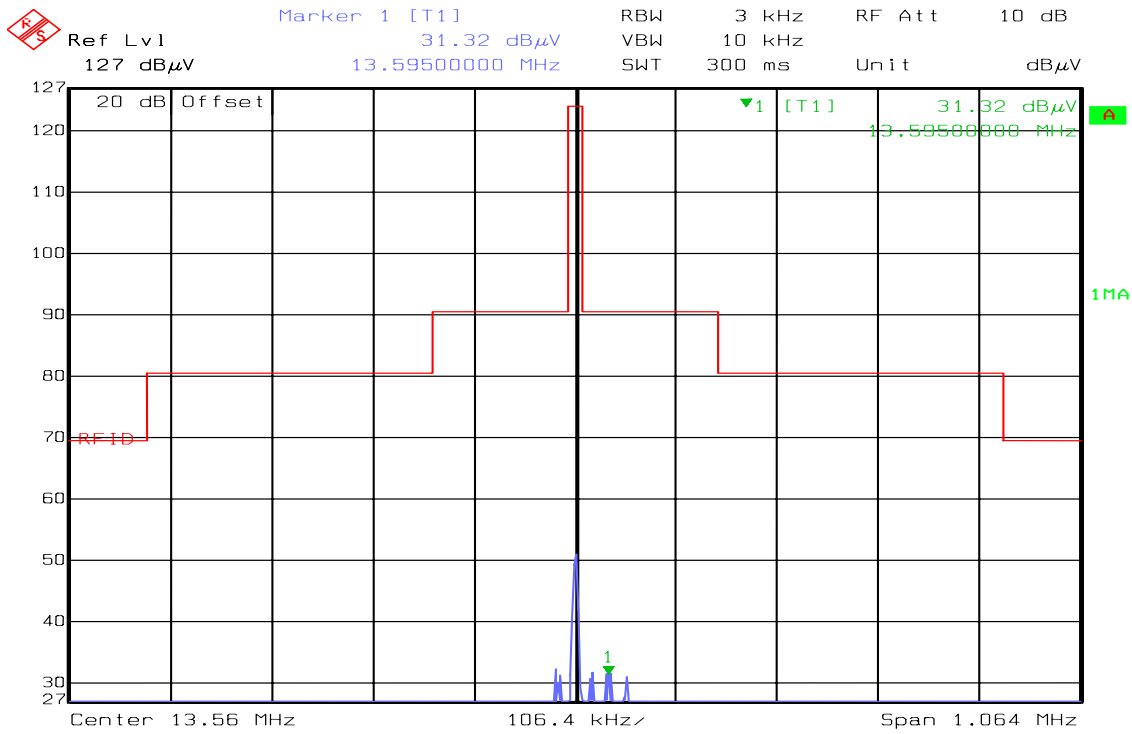

Date: 28.JAN.2010 16:44:20

7.2. FREQUENCY STABILITY

LIMIT

According to §15.207(e), the frequency tolerance of the carrier signal shall be maintained within +/- 0.01% of the operating frequency over a temperature variation of -20 degrees to +50 degrees C at normal supply voltage, and for a variation in the primary supply voltage from 85% to 115% of the rated supply voltage at a temperature of 20 degrees C. For battery operated equipment, the equipment tests shall be performed using a new battery.

TEST CONFIGURATION

Temperature and Voltage Measurement (under normal and extreme test conditions)

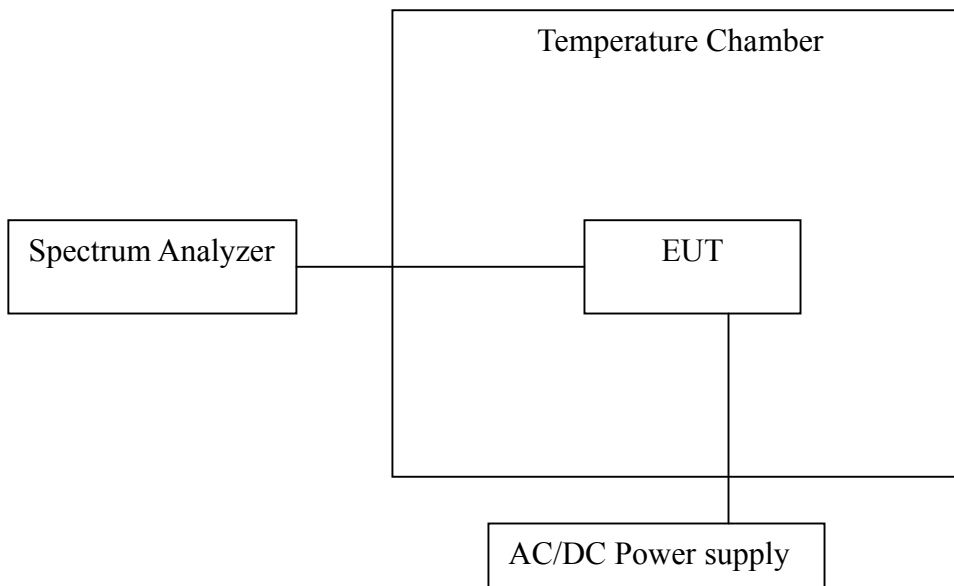

TEST PROCEDURE

1. Place the EUT on the table and set it in the transmitting mode.
2. Remove the antenna from the EUT and then connect a low loss RF cable from the antenna port to the spectrum analyzer.
3. Set the environment into appropriate environment.
4. Set the spectrum analyzer as RBW=1kHz, VBW = RBW, Span = 200kHz, Sweep = auto.
5. Mark the peak frequency and measure the frequency tolerance using frequency counter function.
6. Repeat until all the results are investigated.



TEST RESULTS

No non-compliance noted

TEST DATA

Temperature Variations

Temp. (°C)	Voltage (VAC)	Measured Frequency (MHz)	Delta Frequency (Hz)	Tolerance (%)	Limit (±%)	Result (Pass/Fail)
-20	110	13.560122	122	0.000900	±0.01	Pass
-10		13.560177	177	0.001307	±0.01	Pass
0		13.560100	100	0.000740	±0.01	Pass
10		13.560072	72	0.000531	±0.01	Pass
20		13.560034	34	0.000254	±0.01	Pass
30		13.560041	41	0.000300	±0.01	Pass
40		13.560016	16	0.000115	±0.01	Pass
50		13.560013	13	0.000092	±0.01	Pass

Voltage Variations

Temp. (°C)	Voltage (VAC)	Measured Frequency (MHz)	Delta Frequency (Hz)	Tolerance (%)	Limit (±%)	Result (Pass/Fail)
20	93.5	13.560036	36	0.000265	±0.01	Pass
	110	13.560034	34	0.000251	±0.01	Pass
	126.5	13.560037	37	0.000273	±0.01	Pass



7.3. POWERLINE CONDUCTED EMISSIONS

LIMIT

For an intentional radiator which is designed to be connected to the public utility (AC) power line, the radio frequency voltage that is conducted back onto the AC power line on any frequency or frequencies within the band 150 kHz to 30 MHz shall not exceed 250 microvolts (The limit decreases linearly with the logarithm of the frequency in the range 0.15 MHz to 0.50 MHz). The limits at specific frequency range is listed as follows:

Frequency Range (MHz)	Limits (dB μ V)	
	Quasi-peak	Average
0.15 to 0.50	66 to 56*	56 to 46*
0.50 to 5	56	46
5 to 30	60	50

Compliance with this provision shall be based on the measurement of the radio frequency voltage between each power line (LINE and NEUTRAL) and ground at the power terminals.

TEST CONFIGURATION

See test photographs attached in Appendix I for the actual connections between EUT and support equipment.

TEST PROCEDURE

1. The EUT was placed on a table, which is 0.8m above ground plane.
2. Maximum procedure was performed on the six highest emissions to ensure EUT compliance.
3. Repeat above procedures until all frequency measured were complete.

TEST RESULTS

The initial step in collecting conducted data is a spectrum analyzer peak scan of the measurement range. Significant peaks are then marked as shown on the following data page, and these signals are then quasi-peaked.



TEST DATA

The initial step in collecting conducted data is a spectrum analyzer peak scan of the measurement range. Significant peaks are then marked as shown on the following data page, and these signals are then quasi-peaked.

Operation Mode: Normal Link

Test Date: December 22, 2009

Temperature: 20°C

Tested by: Stan Lin

Humidity: 58% RH

Freq. (MHz)	QP Reading (dBuV)	AV Reading (dBuV)	Corr. factor (dB)	QP Result (dBuV)	AV Result (dBuV)	QP Limit (dBuV)	AV Limit (dBuV)	QP Margin (dB)	AV Margin (dB)	Note
0.1577	40.12	22.11	9.73	49.85	31.84	65.58	55.58	-15.73	-23.74	L1
0.1805	36.05	22.06	9.73	45.78	31.79	64.46	54.46	-18.68	-22.67	L1
0.2565	28.48	17.23	9.72	38.20	26.95	61.54	51.54	-23.34	-24.59	L1
0.3095	27.68	19.49	9.72	37.40	29.21	59.98	49.98	-22.58	-20.77	L1
2.9549	33.26	27.03	9.75	43.01	36.78	56.00	46.00	-12.99	-9.22	L1
4.4068	25.13	19.26	9.80	34.93	29.06	56.00	46.00	-21.07	-16.94	L1
0.1762	33.59	18.05	9.71	43.30	27.76	64.66	54.66	-21.36	-26.90	L2
0.2423	31.73	24.45	9.71	41.44	34.16	62.02	52.02	-20.58	-17.86	L2
0.3351	25.90	12.60	9.71	35.61	22.31	59.32	49.32	-23.71	-27.01	L2
0.4238	23.33	14.15	9.69	33.02	23.84	57.37	47.37	-24.35	-23.53	L2
2.9415	33.17	27.04	9.74	42.91	36.78	56.00	46.00	-13.09	-9.22	L2
4.2716	26.07	20.18	9.78	35.85	29.96	56.00	46.00	-20.15	-16.04	L2

Remark:

1. Measuring frequencies from 0.15 MHz to 30MHz.
2. The emissions measured in frequency range from 0.15 MHz to 30MHz were made with an instrument using Quasi-peak detector and average detector.
3. The IF bandwidth of SPA between 0.15MHz and 30MHz was 10kHz; the IF bandwidth of Test Receiver between 0.15MHz and 30MHz was 9kHz;
4. L1 = Line One (Live Line) / L2 = Line Two (Neutral Line)



Test Plots

Conducted emissions (Line 1)

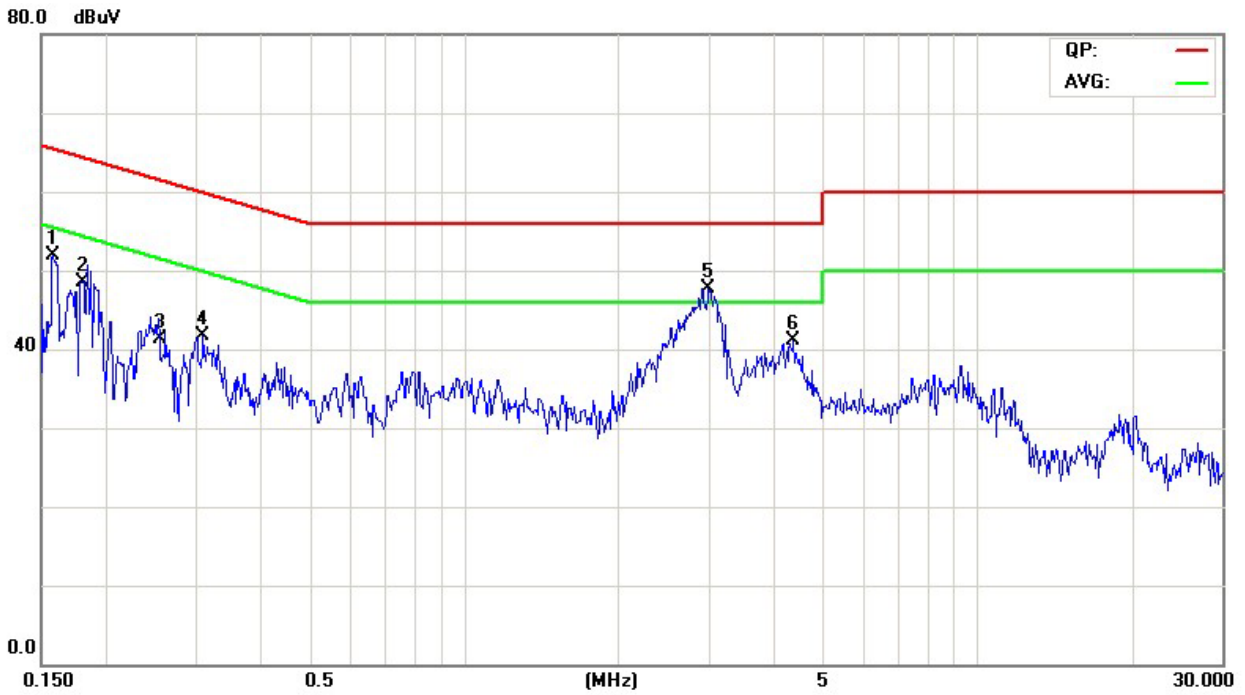

Conducted emissions (Line 2)

