

## FCC Test Report

**Report No.:** RFBDGE-WTW-P23110010

**FCC ID:** E2K-DWRFID2305-01

**Test Model:** DWRFID2305-01

**Received Date:** Nov. 01, 2023

**Test Date:** Nov. 17 ~ Nov. 21, 2023

**Issued Date:** Dec. 14, 2023

**Applicant:** Dell Inc.

**Address:** One Dell Way, Round Rock, Texas 78682, USA

**Issued By:** Bureau Veritas Consumer Products Services (H.K.) Ltd., Taoyuan Branch  
Lin Kou Laboratories

**Lab Address:** No. 47-2, 14th Ling, Chia Pau Vil., Lin Kou Dist., New Taipei City, Taiwan

**Test Location:** No. 19, Hwa Ya 2nd Rd., Wen Hwa Vil., Kwei Shan Dist., Taoyuan City  
33383, Taiwan

### FCC Registration /

**Designation Number:** 788550 / TW0003



This report is governed by, and incorporates by reference, the Conditions of Testing as posted at the date of issuance of this report at <http://www.bureauveritas.com/home/about-us/our-business/cps/about-us/terms-conditions/> and is intended for your exclusive use. Any copying or replication of this report to or for any other person or entity, or use of our name or trademark, is permitted only with our prior written permission. This report sets forth our findings solely with respect to the test samples identified herein. The results set forth in this report are not indicative or representative of the quality or characteristics of the lot from which a test sample was taken or any similar or identical product unless specifically and expressly noted. Our report includes all of the tests requested by you and the results thereof based upon the information that you provided to us. Measurement uncertainty is only provided upon request for accredited tests. Statements of conformity are based on simple acceptance criteria without taking measurement uncertainty into account, unless otherwise requested in writing. You have 60 days from date of issuance of this report to notify us of any material error or omission caused by our negligence or if you require measurement uncertainty; provided, however, that such notice shall be in writing and shall specifically address the issue you wish to raise. A failure to raise such issue within the prescribed time shall constitute your unqualified acceptance of the completeness of this report, the tests conducted and the correctness of the report contents.

## Table of Contents

<b>Release Control Record .....</b>	<b>3</b>
<b>1 Certificate of Conformity .....</b>	<b>4</b>
<b>2 Summary of Test Results .....</b>	<b>5</b>
2.1 Measurement Uncertainty .....	5
2.2 Modification Record .....	5
<b>3 General Information .....</b>	<b>6</b>
3.1 General Description of EUT .....	6
3.2 Description of Test Modes .....	6
3.2.1 Test Mode Applicability and Tested Channel Detail .....	7
3.3 Description of Support Units .....	8
3.3.1 Configuration of System under Test .....	8
3.4 General Description of Applied Standards .....	9
<b>4 Test Types and Results .....</b>	<b>10</b>
4.1 Radiated Emission Measurement .....	10
4.1.1 Limits of Radiated Emission Measurement .....	10
4.1.2 Test Instruments .....	11
4.1.3 Test Procedures .....	12
4.1.4 Deviation from Test Standard .....	12
4.1.5 Test Set Up .....	13
4.1.6 EUT Operating Conditions .....	13
4.1.7 Test Results .....	14
4.2 Conducted Emission Measurement .....	22
4.2.1 Limits of Conducted Emission Measurement .....	22
4.2.2 Test Instruments .....	22
4.2.3 Test Procedures .....	23
4.2.4 Deviation from Test Standard .....	23
4.2.5 Test Setup .....	23
4.2.6 EUT Operating Conditions .....	23
4.2.7 Test Results .....	24
4.3 Frequency Stability .....	26
4.3.1 Limits of Frequency Stability Measurement .....	26
4.3.2 Test Setup .....	26
4.3.3 Test Instruments .....	26
4.3.4 Test Procedure .....	26
4.3.5 Deviation from Test Standard .....	27
4.3.6 EUT Operating Conditions .....	27
4.3.7 Test Result .....	27
4.4 20dB Bandwidth .....	28
4.4.1 Limits of 20dB Bandwidth Measurement .....	28
4.4.2 Test Setup .....	28
4.4.3 Test Instruments .....	28
4.4.4 Test Procedures .....	28
4.4.5 Deviation from Test Standard .....	28
4.4.6 EUT Operating Conditions .....	28
4.4.7 Test Results .....	29
<b>5 Pictures of Test Arrangements .....</b>	<b>30</b>
<b>Appendix – Information of the Testing Laboratories .....</b>	<b>31</b>

**Release Control Record**

Issue No.	Description	Date Issued
RFBGDGE-WTW-P23110010	Original release	Dec. 14, 2023

## 1 Certificate of Conformity

**Product:** RFID 13.56MHz Wireless Module

**Brand:** DELL

**Model:** DWRFID2305-01

**Sample Status:** Engineering Sample

**Applicant:** Dell Inc.

**Test Date:** Nov. 17 ~ Nov. 21, 2023

**Standards:** 47 CFR FCC Part 15, Subpart C (Section 15.225)

47 CFR FCC Part 15, Subpart C (Section 15.215)

ANSI C63.10-2013

The above equipment has been tested by **Bureau Veritas Consumer Products Services (H.K.) Ltd., Taoyuan Branch**, and found compliance with the requirement of the above standards. The test record, data evaluation & Equipment Under Test (EUT) configurations represented herein are true and accurate accounts of the measurements of the sample's RF characteristics under the conditions specified in this report.

**Prepared by :** Gina Liu , **Date:** Dec. 14, 2023  
Gina Liu / Specialist

**Approved by :** Jeremy Lin , **Date:** Dec. 14, 2023  
Jeremy Lin / Project Engineer

## 2 Summary of Test Results

47 CFR FCC Part 15, Subpart C (Section 15.225, 15.215)			
FCC Clause	Test Item	Result	Remarks
15.207	Conducted emission test	Pass	Meet the requirement of limit. Minimum passing margin is -10.62dB at 13.55800MHz
15.225 (a)	The field strength of any emissions within the band 13.553-13.567 MHz	Pass	Meet the requirement of limit. Minimum passing margin is -81.0dB at 13.56MHz.
15.225 (b)	The field strength of any emissions within the bands 13.410-13.553 MHz and 13.567-13.710 MHz	Pass	Meet the requirement of limit.
15.225 (c)	The field strength of any emissions within the bands 13.110-13.410 MHz and 13.710-14.010 MHz	Pass	Meet the requirement of limit.
15.225 (d)	The field strength of any emissions appearing outside of the 13.110-14.010 MHz band	Pass	Meet the requirement of limit. Minimum passing margin is -5.4dB at 39.70MHz.
15.225 (e)	The frequency tolerance	Pass	Meet the requirement of limit.
15.215 (c)	20dB Bandwidth	Pass	Meet the requirement of limit.

Note: Determining compliance based on the results of the compliance measurement, not taking into account measurement instrumentation uncertainty.

### 2.1 Measurement Uncertainty

Where relevant, the following measurement uncertainty levels have been estimated for tests performed on the EUT as specified in CISPR 16-4-2:

Measurement	Frequency	Expanded Uncertainty (k=2) ( $\pm$ )
Conducted Emissions at mains ports	150kHz ~ 30MHz	2.79 dB
Radiated Emissions up to 1 GHz	9kHz ~ 30MHz	2.44 dB
	30MHz ~ 1000MHz	2.95 dB

### 2.2 Modification Record

There were no modifications required for compliance.

### 3 General Information

#### 3.1 General Description of EUT

Product	RFID 13.56MHz Wireless Module
Brand	DELL
Model	DWRFID2305-01
Sample Status	Engineering Sample
Power Supply Rating	3.3Vdc (host equipment)
Modulation Type	ASK
Data Rate	Type A: 106 kbit/s Type B: 106 kbit/s Type F: 212 kbit/s, 424 kbit/s Type V: 26.48 kbit/s
Operating Frequency	13.56MHz
Field Strength	3.0dB $\mu$ V/m (30m)
Antenna Type	Refer to Note as below
Accessory Device	Refer to Note as below
Data Cable Supplied	NA

Note:

1. The EUT is authorized for use in specific End-product. Please refer to below for more details.

Product	Brand	Model
Portable Computer	DELL	P127F

2. The antenna information is listed as below.

Antenna Manufacturer	Antenna Model No.	Antenna Type	Antenna Gain (dBi)
WNC	025.90261.0011	Loop antenna	N/A
SPEED	025.90261.0001	Loop antenna	N/A

\* After the pretesting, the SPEED antenna was the worst case and had been chosen for final test.

\* Due to radiated measurements are made and the antenna gain is already accounted for this device, so provide an antenna datasheet and/or antenna measurement report is not required. The antenna dimensions and pictures (include antenna wire length if have) are stated in EUT photo exhibit.

3. The End-product contains following accessory devices.

Product	Brand	Model	Description
Adapter	DELL	LA65NM190	I/P: 100-240Vac~1.7A 50-60Hz O/P: 5.0V=3.0A/15.0W, 15.0V=3.0A/45.0W 9.0V=3.0A/27.0W, 20.0V=3.25A/65.0W adapter_1.8m / 0 core, power cord_0.85m
Battery	DELL	GRWKG	Rating: 11.4 Vdc; 42 Wh; 3500 mAh

4. Only radiated measurements are used to show compliance with FCC limits for fundamental and spurious emissions.

#### 3.2 Description of Test Modes

1 channel is provided to this EUT

Channel	Freq. (MHz)
1	13.56

### 3.2.1 Test Mode Applicability and Tested Channel Detail

EUT Configure Mode	Applicable to				Description
	RE	PLC	FS	EB	
-	√	√	√	√	EUT with antenna (Brand: SPEED)

Where RE: Radiated Emission  
 FS: Frequency Stability  
 PLC: Power Line Conducted Emission  
 EB: 20dB Bandwidth measurement

Note:

- The EUT had been pre-tested on Type A, Type B, Type F and Type V. The worst case was found when data rate was Type B, Type B was chosen for final test.
- The EUT is designed to be positioned on the NB mode only.

#### **Radiated Emission Test:**

- Pre-Scan has been conducted to determine the worst-case mode from all possible combinations between available modulations, data rates and antenna ports (if EUT with antenna diversity architecture).
- Following channel(s) was (were) selected for the final test as listed below.

EUT Configure Mode	Available Channel	Tested Channel	Modulation Type
-	1	1	ASK

#### **Power Line Conducted Emission Test:**

- Pre-Scan has been conducted to determine the worst-case mode from all possible combinations between available modulations, data rates and antenna ports (if EUT with antenna diversity architecture).
- Following channel(s) was (were) selected for the final test as listed below.

EUT Configure Mode	Available Channel	Tested Channel	Modulation Type
-	1	1	ASK

#### **Frequency Stability:**

- Pre-Scan has been conducted to determine the worst-case mode from all possible combinations between available modulations, data rates and antenna ports (if EUT with antenna diversity architecture).
- Following channel(s) was (were) selected for the final test as listed below.

EUT Configure Mode	Available Channel	Tested Channel	Modulation Type
-	1	1	ASK

#### **20dB Bandwidth:**

- Pre-Scan has been conducted to determine the worst-case mode from all possible combinations between available modulations, data rates and antenna ports (if EUT with antenna diversity architecture).
- Following channel(s) was (were) selected for the final test as listed below.

EUT Configure Mode	Available Channel	Tested Channel	Modulation Type
-	1	1	ASK

#### **Test Condition:**

Applicable to	Environmental Conditions	Input Power	Tested by
RE	23 deg. C, 68% RH, 20 deg. C, 65% RH	120Vac, 60Hz	Vincent Chen
PLC	25 deg. C, 75% RH	120Vac, 60Hz	Rex Wang
FS	23 deg. C, 59% RH	120Vac, 60Hz	Vincent Chen
EB	23 deg. C, 59% RH	120Vac, 60Hz	Vincent Chen

\* There are two pre-test modes: 120Vac and 240Vac. After pre-testing, 120Vac is the worst for the final tests.

### 3.3 Description of Support Units

The EUT has been tested as an independent unit together with other necessary accessories or support units. The following support units or accessories were used to form a representative test configuration during the tests.

ID	Product	Brand	Model No.	Serial No.	FCC ID	Remarks
A.	Portable Computer	DELL	P127F	NA	NA	Provided by client
B.	Adapter	DELL	LA65NM190	NA	NA	Provided by client
C.	Monitor	DELL	A14S2421HSXmTW	CN-01KFWW-WSL00-24C-711B	NA	Provided by lab
D.	Earphone	APPLE	MB77PFEB	NA	NA	Provided by lab
E.	USB Flash	SanDisk	SDDDC3-032G	NA	NA	Type C
F.	USB Flash*2	SanDisk	SDDDC3-032G	NA	NA	Type A
G.	NFC Card	NA	NA	NA	NA	Provided by lab
H.	Load	NA	NA	NA	NA	Provided by lab

Note: All power cords of the above support units are non-shielded (1.8m).

ID	Descriptions	Qty.	Length (m)	Shielding (Yes/No)	Cores (Qty.)	Remarks
1.	USB-C cable	1	1.8	Y	0	Provided by client
2.	Audio cable	1	1.2	N	0	Provided by lab
3.	HDMI cable	1	1.8	Y	0	Provided by lab
4.	AC Power cable	1	0.85	N	0	Provided by client
5.	LAN cable	1	1.5	N	0	Provided by Lab

#### 3.3.1 Configuration of System under Test

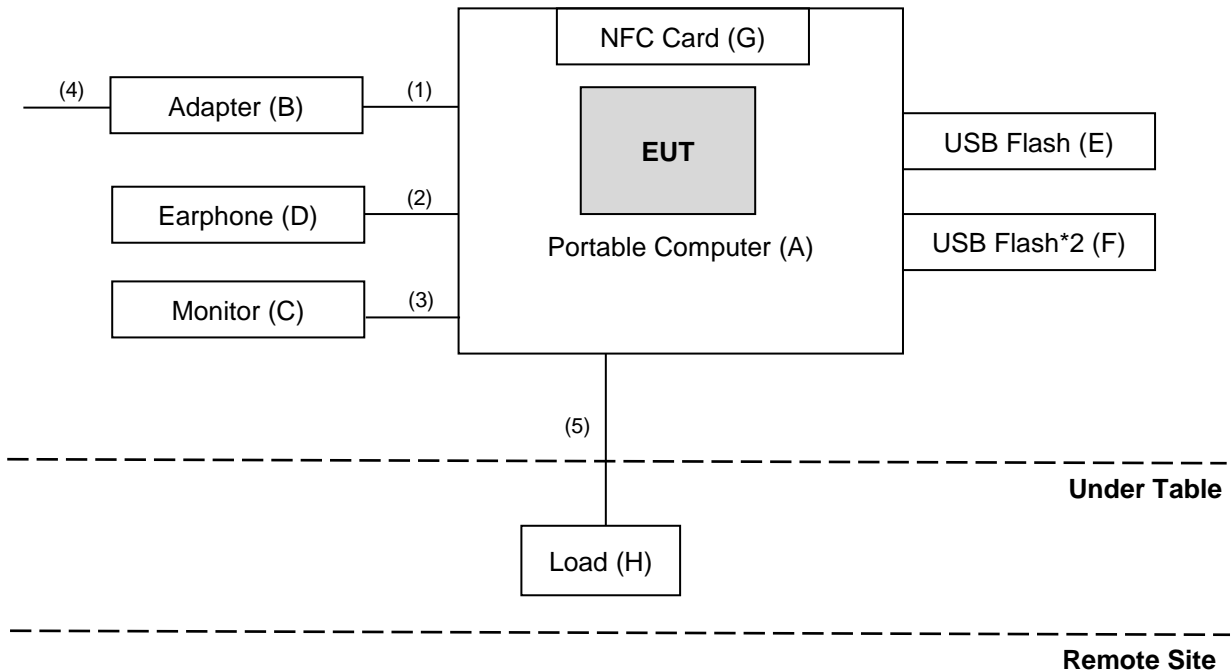



### 3.4 General Description of Applied Standards

The EUT is a RF Product. According to the specifications of the manufacturer, it must comply with the requirements of the following standards:

**FCC Part 15, Subpart C (15.225)**

**FCC Part 15, Subpart C (15.215)**

ANSI C63.10-2013

All test items have been performed and recorded as per the above standards.

## 4 Test Types and Results

### 4.1 Radiated Emission Measurement

#### 4.1.1 Limits of Radiated Emission Measurement

The field strength of any emissions within the band 13.553-13.567 MHz shall not exceed 15,848 microvolts/meter at 30 meters.

Within the bands 13.410-13.553 MHz and 13.567-13.710 MHz, the field strength of any emissions shall not exceed 334 microvolts/meter at 30 meters.

Within the bands 13.110-13.410 MHz and 13.710-14.010 MHz the field strength of any emissions shall not exceed 106 microvolts/meter at 30 meters.

The field strength of any emissions appearing outside of the 13.110-14.010 MHz band shall not exceed the general radiated emission limits in § 15.209.

Frequencies (MHz)	Field Strength (microvolts/meter)	Measurement Distance (meters)
0.009 ~ 0.490	2400/F(kHz)	300
0.490 ~ 1.705	24000/F(kHz)	30
1.705 ~ 30.0	30	30
30 ~ 88	100	3
88 ~ 216	150	3
216 ~ 960	200	3
Above 960	500	3

Note:

1. The lower limit shall apply at the transition frequencies.
2. Emission level (dBuV/m) = 20 log Emission level (uV/m).
3. For frequencies above 1000MHz, the field strength limits are based on average detector, however, the peak field strength of any emission shall not exceed the maximum permitted average limits, specified above by more than 20dB under any condition of modulation.

#### 4.1.2 Test Instruments

Description & Manufacturer	Model No.	Serial No.	Cal. Date	Cal. Due
Software BV ADT	ADT_Radiated_ V7.6.15.9.5	NA	NA	NA
Antenna Tower & Turn Max-Full	MFA-440H	AT93021705	NA	NA
Turn Table Max-Full	MFT-201SS	NA	NA	NA
Turn Table Controller Max-Full	MG-7802	NA	NA	NA
MXE EMI Receiver Keysight	N9038A	MY55420137	May 3, 2023	May 2, 2024
EXA Signal Analyzer Agilent	N9010A	MY52220207	Jan. 3, 2023	Jan. 2, 2024
Loop Antenna TESEQ	HLA 6121	45745	Aug. 8, 2023	Aug. 7, 2024
Loop Antenna Electro-Metrics	EM-6879	269	Sep. 23, 2023	Sep. 22, 2024
Preamplifier EMCI	EMC001340	980201	Sep. 27, 2023	Sep. 26, 2024
RF Coaxial Cable EMCI	5D-NM-BM	140903+140902	Jan. 7, 2023	Jan. 6, 2024
Preamplifier EMCI	EMC 330H	980112	Sep. 27, 2023	Sep. 26, 2024
Bi_Log Antenna Schwarzbeck	VULB 9168	9168-472	Oct. 16, 2023	Oct. 15, 2024
RF Coaxial Cable Woken	8D-FB	Cable-Ch10-01	Sep. 27, 2023	Sep. 26, 2024
Peak Power Analyzer KEYSIGHT	8990B	MY51000485	Jan. 19, 2023	Jan. 18, 2024
Wideband Power Sensor KEYSIGHT	N1923A	MY58020002	Jan. 18, 2023	Jan. 17, 2024

Note: 1. The calibration interval of the above test instruments is 12 months and the calibrations are traceable to NML/ROC and NIST/USA.  
 2. The test was performed in HY - 966 chamber 5.

### 4.1.3 Test Procedures

#### For Radiated emission below 30MHz

- a. The EUT was placed on the top of a rotating table 0.8 meters above the ground at a 3 meter chamber room. The table was rotated 360 degrees to determine the position of the highest radiation.
- b. The EUT was set 3 meters away from the interference-receiving antenna, which was mounted on the top of a variable-height antenna tower.
- c. Parallel, perpendicular, and ground-parallel orientations of the antenna are set to make the measurement.
- d. For each suspected emission, the EUT was arranged to its worst case and the rotatable table was turned from 0 degrees to 360 degrees to find the maximum reading.
- e. The test-receiver system was set to Quasi-Peak Detect Function and Specified Bandwidth with Maximum Hold Mode, except for the frequency band (9kHz-90kHz, 110kHz-490kHz) set to average detect function and peak detect function.

Note:

1. The resolution bandwidth and video bandwidth of test receiver/spectrum analyzer is 200Hz at frequency band (9kHz-150kHz) and 9kHz at frequency below 30MHz (except 9kHz-150kHz).
2. There is a comparison data of both open-field test site and semi-Anechoic chamber, and the result came out very similar.

#### For Radiated emission above 30MHz

- a. The EUT was placed on the top of a rotating table 0.8 meters (for 30MHz ~ 1GHz) above the ground at 3 meter chamber room for test. The table was rotated 360 degrees to determine the position of the highest radiation.
- b. The EUT was set 3 meters away from the interference-receiving antenna, which was mounted on the top of a variable-height antenna tower.
- c. The height of antenna is varied from one meter to four meters above the ground to determine the maximum value of the field strength. Both horizontal and vertical polarizations of the antenna are set to make the measurement.
- d. For each suspected emission, the EUT was arranged to its worst case and then the antenna was tuned to heights from 1 meter to 4 meters and the rotatable table was turned from 0 degrees to 360 degrees to find the maximum reading.
- e. The test-receiver system was set to quasi-peak detect function and specified bandwidth with maximum hold mode when the test frequency is below 1 GHz.

Note:

1. The resolution bandwidth and video bandwidth of test receiver/spectrum analyzer is 120kHz for Quasi-peak detection (QP) at frequency below 1GHz.
2. All modes of operation were investigated and the worst-case emissions are reported.

### 4.1.4 Deviation from Test Standard

No deviation.

#### 4.1.5 Test Set Up

##### For Radiated emission below 30MHz

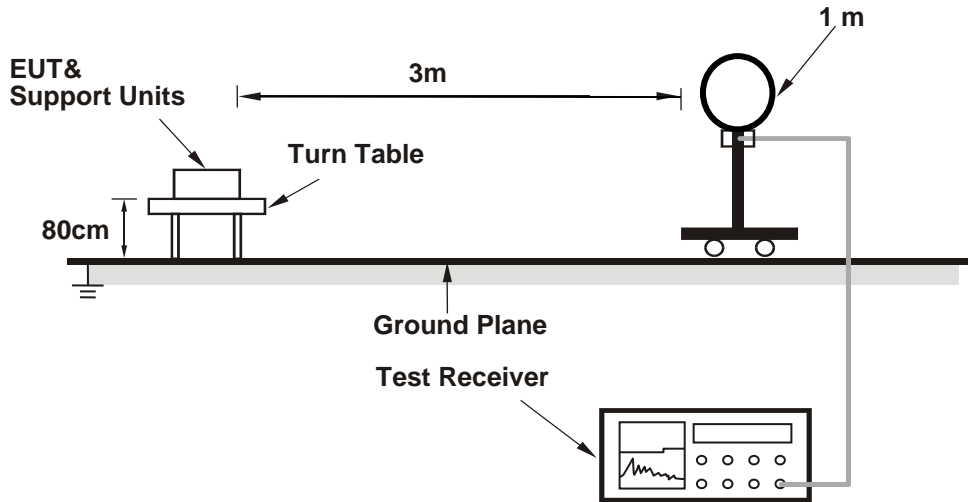

##### For Radiated emission 30MHz to 1GHz

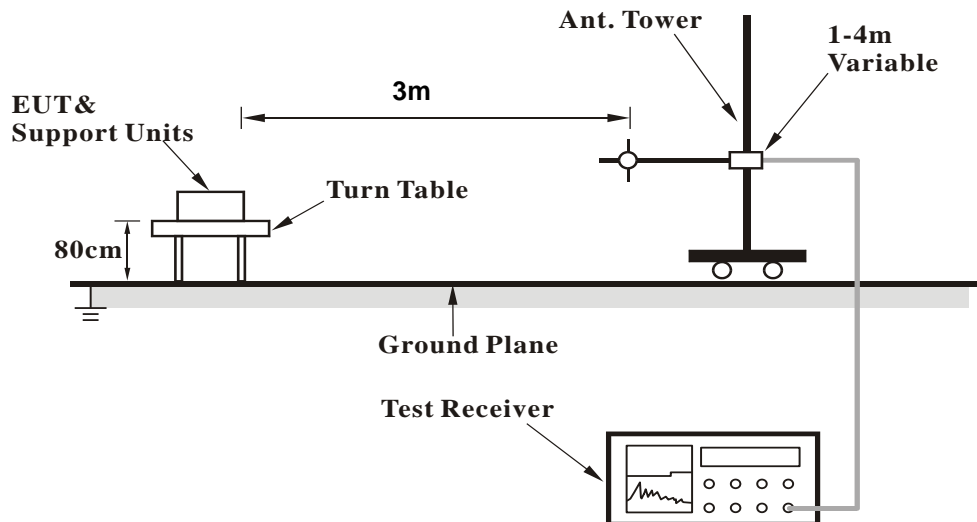

For the actual test configuration, please refer to the attached file (Test Setup Photo).

KDB 414788 OFS and Chamber Correlation Justification

- Based on FCC 15.31 (f) (2): measurements may be performed at a distance closer than that specified in regulations; however, an attempt should be made to avoid making measurements in the near field.
- Open-field site and chamber correlation testing had been performed and chamber measured test result is the worst case test result.

#### 4.1.6 EUT Operating Conditions

- a. Set the EUT under transmission condition continuously at specific channel frequency.

#### 4.1.7 Test Results

##### Type B

EUT Test Condition		Measurement Detail	
Channel	Channel 1	Frequency Range	13.553 ~ 13.567MHz
Input Power	120Vac, 60Hz	Detector Function	Quasi-Peak
Environmental Conditions	23°C, 68% RH	Tested By	Vincent Chen

Antenna Polarity & Test Distance: Loop Antenna Parallel At 3m								
No.	Freq. (MHz)	Emission Level (dBuV/m) (30m)	Limit (dBuV/m)	Margin (dB)	Antenna Height (m)	Table Angle (Degree)	Raw Value (dBuV) (3m)	Correction Factor (dB/m)
1	*13.56	3.0 QP	84.0	-81.0	1.00	166	21.6	-18.6

##### Remarks:

1. Emission Level(dBuV/m) = Raw Value(dBuV) + Correction Factor(dB/m)
2. Correction Factor(dB/m) = Antenna Factor(dB/m) + Cable Factor(dB) – Pre-Amplifier Factor(dB)+Distance Factor
3. The other emission levels were very low against the limit.
4. Margin value = Emission Level – Limit value
5. “ \* ” : Fundamental frequency
6. Above limits have been translated by the formula

The measured field strength was extrapolated to distance 30 meters, using the formula that the limit of field strength varies as the inverse distance square (40dB per decade of distance)

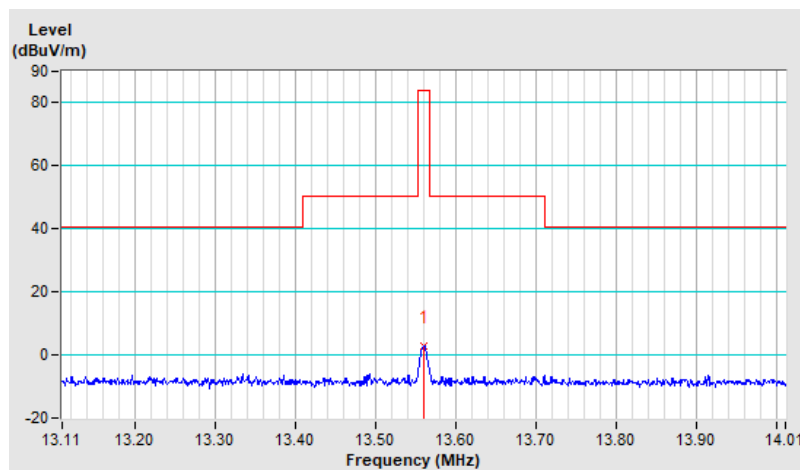

EUT Test Condition		Measurement Detail	
Channel	Channel 1	Frequency Range	13.553 ~ 13.567MHz
Input Power	120Vac, 60Hz	Detector Function	Quasi-Peak
Environmental Conditions	23°C, 68% RH	Tested By	Vincent Chen

Antenna Polarity & Test Distance: Loop Antenna Perpendicular At 3m								
No.	Freq. (MHz)	Emission Level (dBuV/m) (30m)	Limit (dBuV/m)	Margin (dB)	Antenna Height (m)	Table Angle (Degree)	Raw Value (dBuV) (3m)	Correction Factor (dB/m)
1	*13.56	-0.3 QP	84.0	-84.3	1.00	18	18.3	-18.6

Remarks:

1. Emission Level(dBuV/m) = Raw Value(dBuV) + Correction Factor(dB/m)
2. Correction Factor(dB/m) = Antenna Factor(dB/m) + Cable Factor(dB) – Pre-Amplifier Factor(dB)+Distance Factor
3. The other emission levels were very low against the limit.
4. Margin value = Emission Level – Limit value
5. “ \* “ : Fundamental frequency
6. Above limits have been translated by the formula

The measured field strength was extrapolated to distance 30 meters, using the formula that the limit of field strength varies as the inverse distance square (40dB per decade of distance)

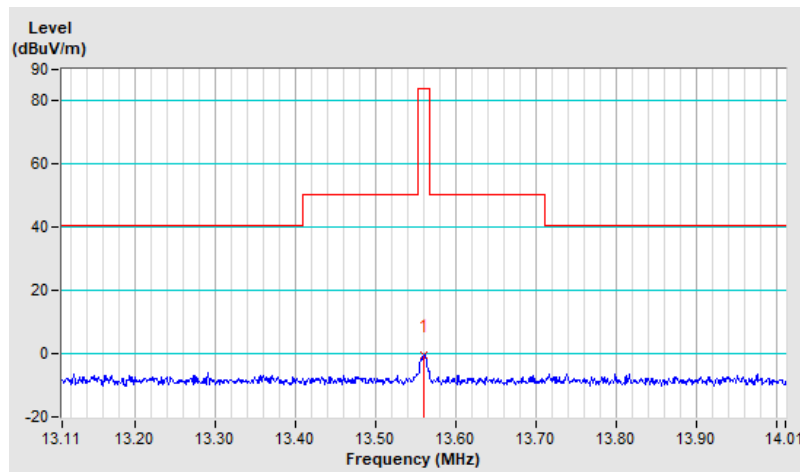

EUT Test Condition		Measurement Detail	
Channel	Channel 1	Frequency Range	13.553 ~ 13.567MHz
Input Power	120Vac, 60Hz	Detector Function	Quasi-Peak
Environmental Conditions	23°C, 68% RH	Tested By	Vincent Chen

Antenna Polarity & Test Distance: Loop Antenna Ground Parallel At 3m								
No.	Freq. (MHz)	Emission Level (dBuV/m) (30m)	Limit (dBuV/m)	Margin (dB)	Antenna Height (m)	Table Angle (Degree)	Raw Value (dBuV) (3m)	Correction Factor (dB/m)
1	*13.56	2.0 QP	84.0	-82.0	1.00	190	20.6	-18.6

Remarks:

1. Emission Level(dBuV/m) = Raw Value(dBuV) + Correction Factor(dB/m)
2. Correction Factor(dB/m) = Antenna Factor(dB/m) + Cable Factor(dB) – Pre-Amplifier Factor(dB)+Distance Factor
3. The other emission levels were very low against the limit.
4. Margin value = Emission Level – Limit value
5. “ \* “ : Fundamental frequency
6. Above limits have been translated by the formula

The measured field strength was extrapolated to distance 30 meters, using the formula that the limit of field strength varies as the inverse distance square (40dB per decade of distance)

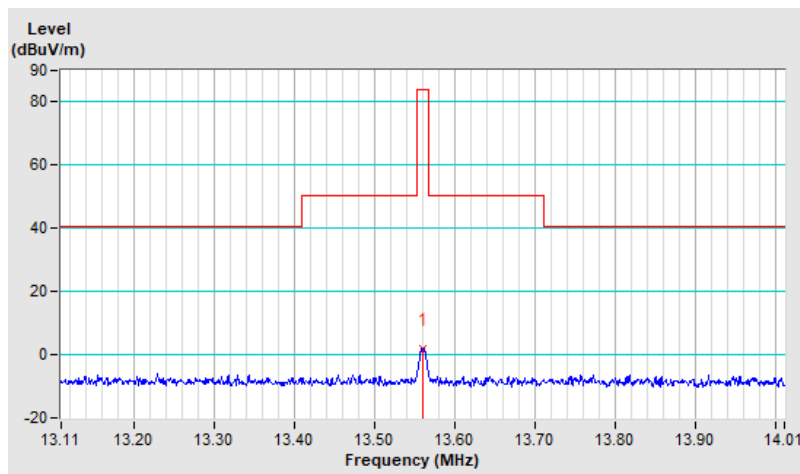



EUT Test Condition		Measurement Detail	
Channel	Channel 1	Frequency Range	Below 30MHz
Input Power	120Vac, 60Hz	Detector Function	Quasi-Peak
Environmental Conditions	23°C, 68% RH	Tested By	Vincent Chen

Antenna Polarity & Test Distance: Loop Antenna Parallel At 3m								
No.	Freq. (MHz)	Emission Level (dBuV/m) (30m)	Limit (dBuV/m)	Margin (dB)	Antenna Height (m)	Table Angle (Degree)	Raw Value (dBuV) (3m)	Correction Factor (dB/m)
1	3.70	-8.9 QP	29.5	-38.4	1.00	153	11.4	-20.3
2	6.58	-6.9 QP	29.5	-36.4	1.00	225	11.9	-18.8
3	10.36	-7.2 QP	29.5	-36.7	1.00	256	11.3	-18.5
4	16.11	-7.0 QP	29.5	-36.5	1.00	3	11.4	-18.4
5	20.34	-6.7 QP	29.5	-36.2	1.00	325	11.3	-18.0
6	27.12	-8.2 QP	29.5	-37.7	1.00	100	9.6	-17.8

Remarks:

1. Emission Level(dBuV/m) = Raw Value(dBuV) + Correction Factor(dB/m)
2. Correction Factor(dB/m) = Antenna Factor(dB/m) + Cable Factor(dB) – Pre-Amplifier Factor(dB) +Distance Factor
3. The other emission levels were very low against the limit.
4. Margin value = Emission Level – Limit value
5. The measured field strength was extrapolated to distance 30 meters, using the formula that the limit of field strength varies as the inverse distance square (40dB per decade of distance)

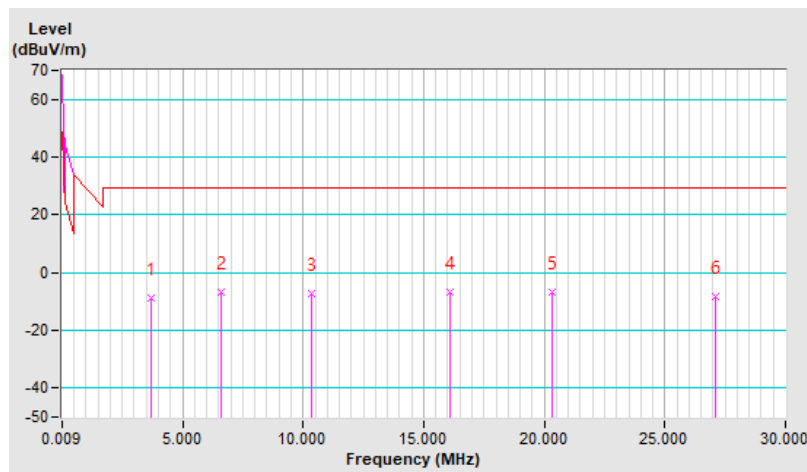

EUT Test Condition		Measurement Detail	
Channel	Channel 1	Frequency Range	Below 30MHz
Input Power	120Vac, 60Hz	Detector Function	Quasi-Peak
Environmental Conditions	23°C, 68% RH	Tested By	Vincent Chen

Antenna Polarity & Test Distance: Loop Antenna Perpendicular At 3m								
No.	Freq. (MHz)	Emission Level (dBuV/m) (30m)	Limit (dBuV/m)	Margin (dB)	Antenna Height (m)	Table Angle (Degree)	Raw Value (dBuV) (3m)	Correction Factor (dB/m)
1	4.72	-8.4 QP	29.5	-37.9	1.00	42	11.7	-20.1
2	8.65	-7.4 QP	29.5	-36.9	1.00	18	11.5	-18.9
3	11.56	-6.4 QP	29.5	-35.9	1.00	37	11.9	-18.3
<b>4</b>	<b>17.91</b>	<b>-6.3 QP</b>	<b>29.5</b>	<b>-35.8</b>	<b>1.00</b>	<b>179</b>	<b>11.6</b>	<b>-17.9</b>
5	21.63	-7.6 QP	29.5	-37.1	1.00	135	10.6	-18.2
6	27.12	-7.7 QP	29.5	-37.2	1.00	256	10.1	-17.8

Remarks:

1. Emission Level(dBuV/m) = Raw Value(dBuV) + Correction Factor(dB/m)
2. Correction Factor(dB/m) = Antenna Factor(dB/m) + Cable Factor(dB) – Pre-Amplifier Factor(dB) +Distance Factor
3. The other emission levels were very low against the limit.
4. Margin value = Emission Level – Limit value
5. The measured field strength was extrapolated to distance 30 meters, using the formula that the limit of field strength varies as the inverse distance square (40dB per decade of distance)

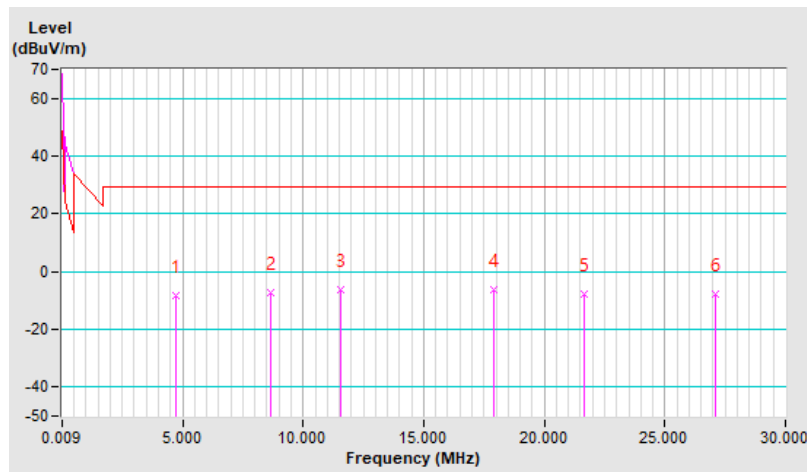

EUT Test Condition		Measurement Detail	
Channel	Channel 1	Frequency Range	Below 30MHz
Input Power	120Vac, 60Hz	Detector Function	Quasi-Peak
Environmental Conditions	23°C, 68% RH	Tested By	Vincent Chen

Antenna Polarity & Test Distance: Loop Antenna Ground Parallel At 3m								
No.	Freq. (MHz)	Emission Level (dBuV/m) (30m)	Limit (dBuV/m)	Margin (dB)	Antenna Height (m)	Table Angle (Degree)	Raw Value (dBuV) (3m)	Correction Factor (dB/m)
1	2.41	-9.1 QP	29.5	-38.6	1.00	21	11.3	-20.4
2	5.47	-7.5 QP	29.5	-37.0	1.00	334	12.0	-19.5
3	9.13	-7.0 QP	29.5	-36.5	1.00	2	11.9	-18.9
4	17.28	-6.4 QP	29.5	-35.9	1.00	11	11.6	-18.0
5	21.48	-7.3 QP	29.5	-36.8	1.00	118	10.9	-18.2
6	27.12	-7.8 QP	29.5	-37.3	1.00	164	10.0	-17.8

Remarks:

1. Emission Level(dBuV/m) = Raw Value(dBuV) + Correction Factor(dB/m)
2. Correction Factor(dB/m) = Antenna Factor(dB/m) + Cable Factor(dB) – Pre-Amplifier Factor(dB) +Distance Factor
3. The other emission levels were very low against the limit.
4. Margin value = Emission Level – Limit value
5. The measured field strength was extrapolated to distance 30 meters, using the formula that the limit of field strength varies as the inverse distance square (40dB per decade of distance)

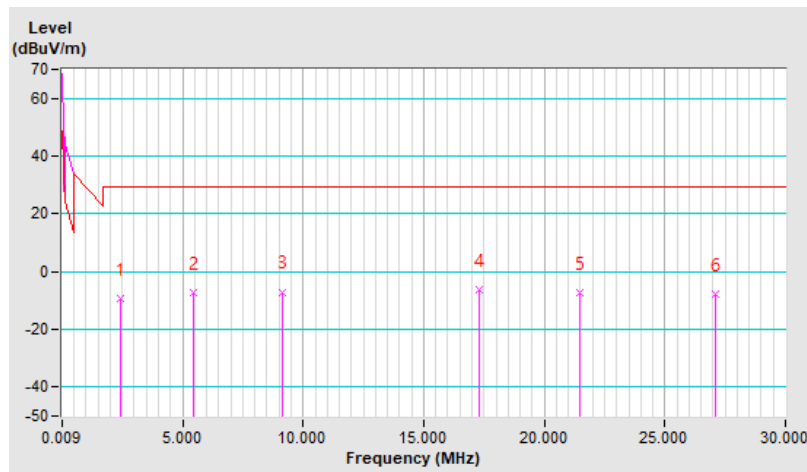

EUT Test Condition		Measurement Detail	
Channel	Channel 1	Frequency Range	Below 1000MHz
Input Power	120Vac, 60Hz	Detector Function	Quasi-Peak
Environmental Conditions	20°C, 65% RH	Tested By	Vincent Chen

Antenna Polarity & Test Distance: Horizontal At 3m								
No.	Freq. (MHz)	Emission Level (dBuV/m)	Limit (dBuV/m)	Margin (dB)	Antenna Height (m)	Table Angle (Degree)	Raw Value (dBuV)	Correction Factor (dB/m)
1	78.50	28.1 QP	40.0	-11.9	2.00 H	303	45.1	-17.0
2	193.95	32.9 QP	43.5	-10.6	1.00 H	334	48.6	-15.7
3	298.72	34.5 QP	46.0	-11.5	1.50 H	43	46.6	-12.1
4	374.39	34.9 QP	46.0	-11.1	1.00 H	57	45.2	-10.3
5	662.51	34.7 QP	46.0	-11.3	1.00 H	151	38.5	-3.8
6	897.27	34.0 QP	46.0	-12.0	2.00 H	284	34.8	-0.8

Remarks:

1. Emission Level(dBuV/m) = Raw Value(dBuV) + Correction Factor(dB/m)
2. Correction Factor(dB/m) = Antenna Factor(dB/m) + Cable Factor(dB) – Pre-Amplifier Factor(dB)
3. The other emission levels were very low against the limit.
4. Margin value = Emission Level – Limit value

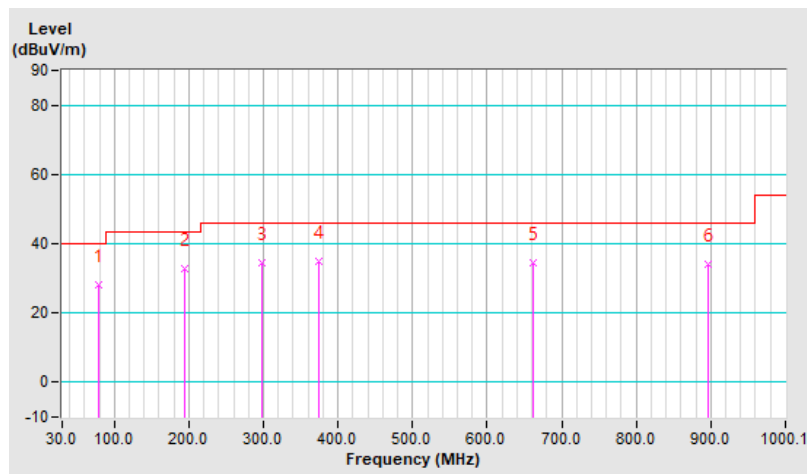

EUT Test Condition		Measurement Detail	
Channel	Channel 1	Frequency Range	Below 1000MHz
Input Power	120Vac, 60Hz	Detector Function	Quasi-Peak
Environmental Conditions	20°C, 65% RH	Tested By	Vincent Chen

Antenna Polarity & Test Distance: Vertical At 3m								
No.	Freq. (MHz)	Emission Level (dBuV/m)	Limit (dBuV/m)	Margin (dB)	Antenna Height (m)	Table Angle (Degree)	Raw Value (dBuV)	Correction Factor (dB/m)
1	39.70	34.6 QP	40.0	-5.4	1.00 V	241	47.5	-12.9
2	89.18	32.5 QP	43.5	-11.0	2.00 V	313	50.9	-18.4
3	293.87	34.9 QP	46.0	-11.1	1.00 V	179	47.1	-12.2
4	374.39	35.5 QP	46.0	-10.5	1.00 V	179	45.8	-10.3
5	672.21	34.8 QP	46.0	-11.2	1.50 V	194	38.6	-3.8
6	881.75	36.8 QP	46.0	-9.2	1.50 V	209	37.7	-0.9

Remarks:

1. Emission Level(dBuV/m) = Raw Value(dBuV) + Correction Factor(dB/m)
2. Correction Factor(dB/m) = Antenna Factor(dB/m) + Cable Factor(dB) – Pre-Amplifier Factor(dB)
3. The other emission levels were very low against the limit.
4. Margin value = Emission Level – Limit value

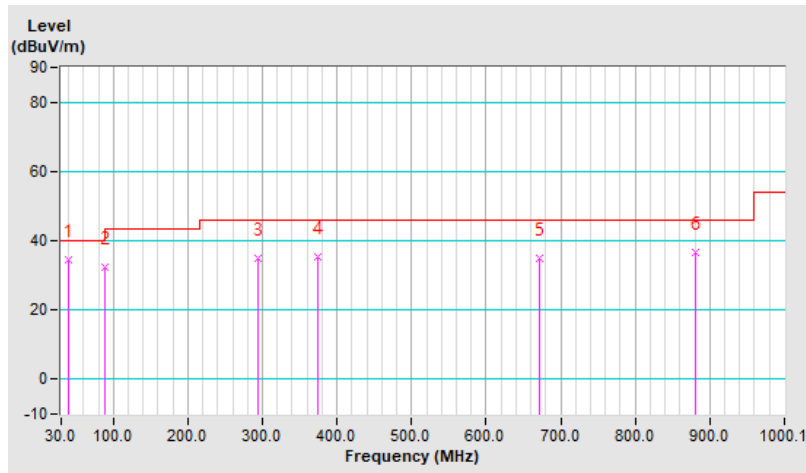

## 4.2 Conducted Emission Measurement

### 4.2.1 Limits of Conducted Emission Measurement

Frequency (MHz)	Conducted Limit (dBuV)	
	Quasi-peak	Average
0.15 - 0.5	66 - 56	56 - 46
0.50 - 5.0	56	46
5.0 - 30.0	60	50

Note: 1. The lower limit shall apply at the transition frequencies.

2. The limit decreases in line with the logarithm of the frequency in the range of 0.15 to 0.50MHz.

### 4.2.2 Test Instruments

Description & Manufacturer	Model No.	Serial No.	Cal. Date	Cal. Due
EMI Test Receiver R&S	ESCS 30	100288	Jan. 3, 2023	Jan. 2, 2024
RF Coaxial Cable Woken	5D-FB	Cable-cond1-01	Jan. 7, 2023	Jan. 6, 2024
LISN R&S	ENV216	101826	Mar. 23, 2023	Mar. 22, 2024
LISN R&S	ESH3-Z5	100311	Sep. 6, 2023	Sep. 5, 2024
Software ADT	BV ADT_Cond_ V7.3.7.4	NA	NA	NA

Note: 1. The calibration interval of the above test instruments is 12 months and the calibrations are traceable to NML/ROC and NIST/USA.

2. The test was performed in HwaYa Shielded Room 1 (Conduction 1).

3. The VCCI Site Registration No. is C-12040.

#### 4.2.3 Test Procedures

- The EUT was placed 0.4 meters from the conducting wall of the shielded room with EUT being connected to the power mains through a line impedance stabilization network (LISN). Other support units were connected to the power mains through another LISN. The two LISNs provide 50 ohm/ 50uH of coupling impedance for the measuring instrument.
- Both lines of the power mains connected to the EUT were checked for maximum conducted interference.
- The frequency range from 150kHz to 30MHz was searched. Emission levels under (Limit - 20dB) was not recorded.

Note: The resolution bandwidth and video bandwidth of test receiver is 9kHz for quasi-peak detection (QP) and average detection (AV) at frequency 0.15MHz-30MHz.

#### 4.2.4 Deviation from Test Standard

No deviation.

#### 4.2.5 Test Setup

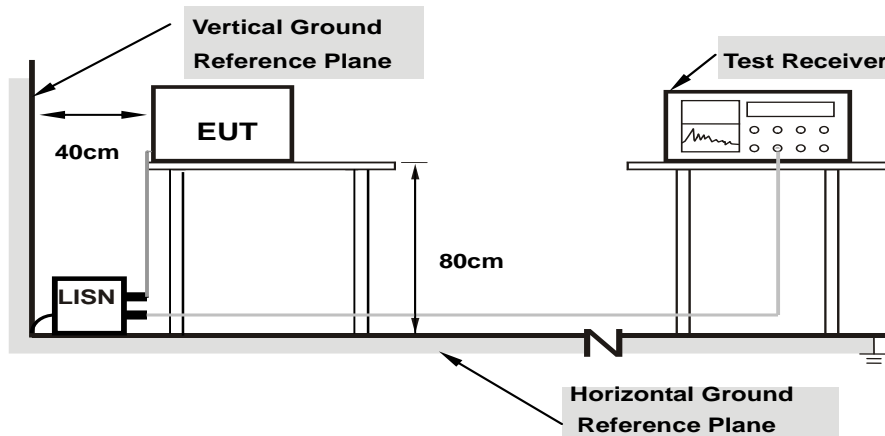

Note: 1.Support units were connected to second LISN.

For the actual test configuration, please refer to the attached file (Test Setup Photo).

#### 4.2.6 EUT Operating Conditions

Same as 4.1.6.

### 4.2.7 Test Results

#### Type B

Phase	Line (L)	Detector Function	Quasi-Peak (QP) / Average (AV)
-------	----------	-------------------	--------------------------------

No	Freq. [MHz]	Corr. Factor (dB)	Reading Value [dB (uV)]		Emission Level [dB (uV)]		Limit [dB (uV)]		Margin (dB)	
			Q.P.	AV.	Q.P.	AV.	Q.P.	AV.	Q.P.	AV.
			1	0.15400	9.62	45.42	26.37	55.04	35.99	65.78
2	0.16200	9.62	42.38	24.05	52.00	33.67	65.36	55.36	-13.36	-21.69
3	0.17708	9.63	40.71	25.22	50.34	34.85	64.62	54.62	-14.28	-19.77
4	0.20200	9.64	33.61	17.96	43.25	27.60	63.53	53.53	-20.28	-25.93
5	0.21400	9.64	33.80	18.57	43.44	28.21	63.05	53.05	-19.61	-24.84
6	13.56200	9.79	30.05	28.95	39.84	38.74	60.00	50.00	-20.16	-11.26

Remarks:

1. Q.P. and AV. are abbreviations of quasi-peak and average individually.
2. The emission levels of other frequencies were very low against the limit.
3. Margin value = Emission level - Limit value
4. Correction factor = Insertion loss + Cable loss
5. Emission Level = Correction Factor + Reading Value.

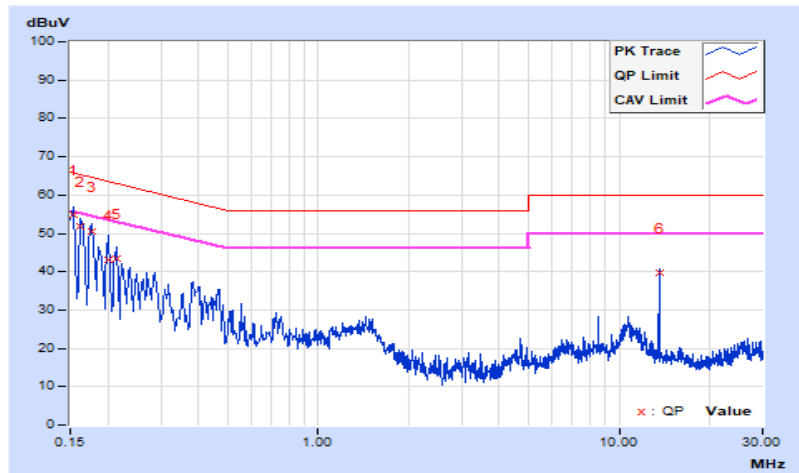



Phase	Neutral (N)	Detector Function	Quasi-Peak (QP) / Average (AV)
-------	-------------	-------------------	--------------------------------

No	Freq. [MHz]	Corr. Factor (dB)	Reading Value [dB (uV)]		Emission Level [dB (uV)]		Limit [dB (uV)]		Margin (dB)	
			Q.P.	AV.	Q.P.	AV.	Q.P.	AV.	Q.P.	AV.
			1	0.15800	9.62	45.13	26.78	54.75	36.40	65.57
2	0.17800	9.63	41.34	24.37	50.97	34.00	64.58	54.58	-13.61	-20.58
3	0.20200	9.64	35.31	18.40	44.95	28.04	63.53	53.53	-18.58	-25.49
4	0.22600	9.64	31.88	16.10	41.52	25.74	62.60	52.60	-21.08	-26.86
5	0.27400	9.65	27.68	16.08	37.33	25.73	61.00	51.00	-23.67	-25.27
<b>6</b>	<b>13.55800</b>	<b>9.84</b>	<b>30.64</b>	<b>29.54</b>	<b>40.48</b>	<b>39.38</b>	<b>60.00</b>	<b>50.00</b>	<b>-19.52</b>	<b>-10.62</b>

Remarks:

1. Q.P. and AV. are abbreviations of quasi-peak and average individually.
2. The emission levels of other frequencies were very low against the limit.
3. Margin value = Emission level - Limit value
4. Correction factor = Insertion loss + Cable loss
5. Emission Level = Correction Factor + Reading Value.

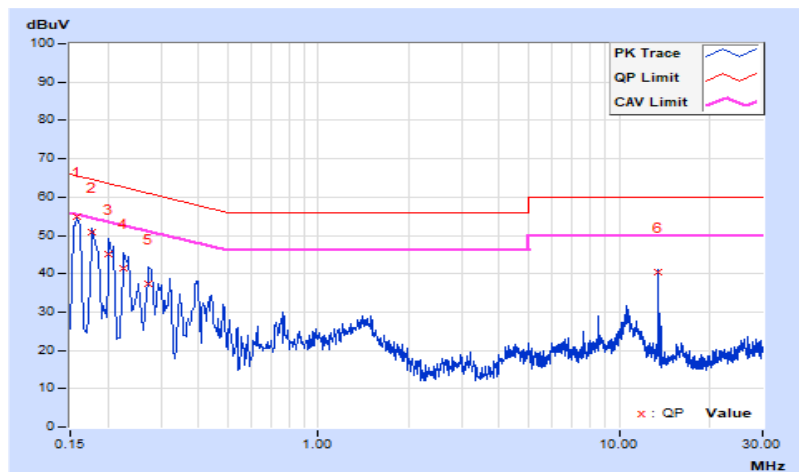

### 4.3 Frequency Stability

#### 4.3.1 Limits of Frequency Stability Measurement

The frequency tolerance of the carrier signal shall be maintained within +/- 0.01% of the operating frequency over a temperature variation of -20 degrees to 50 degrees C at normal supply voltage, and for a variation in the primary supply voltage from 85% to 115% of the rated supply voltage at a temperature of 20 degrees C.

#### 4.3.2 Test Setup

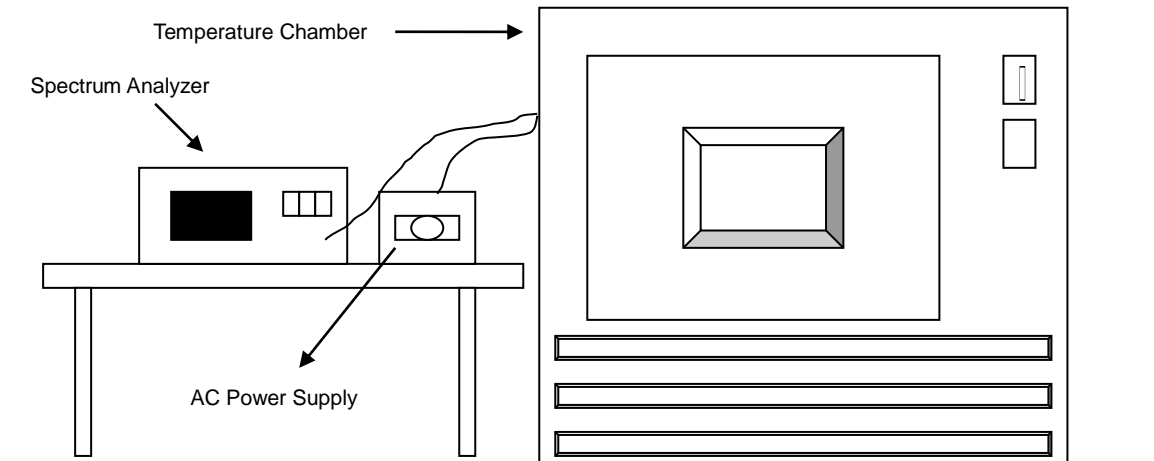

#### 4.3.3 Test Instruments

Description & Manufacturer	Model No.	Serial No.	Cal. Date	Cal. Due
Spectrum Analyzer ROHDE & SCHWARZ	FSP40	100037	Mar. 08, 2023	Mar. 07, 2024
Standard Temperature And Humidity Chamber TERCHY	MHU-225AU	920842	Jun. 17, 2023	Jun. 16, 2024
Three-phase coupling / decoupling network TESEQ	CDN 3063	4006	Mar. 08, 2023	Mar. 07, 2024
AC Power Source ExTech	CFW-105	E000603	NA	NA

Note: 1. The calibration interval of the above test instruments is 12 months and the calibrations are traceable to NML/ROC and NIST/USA.

#### 4.3.4 Test Procedure

- The EUT was placed inside the environmental test chamber and powered by nominal AC voltage.
- Turned the EUT on and coupled its output to a spectrum analyzer.
- Turned the EUT off and set the chamber to the highest temperature specified.
- Allowed sufficient time (approximately 30 min) for the temperature of the chamber to stabilize then turned the EUT on and measured the operating frequency after 2, 5, and 10 minutes.
- Repeat step (d) with the temperature chamber set to the next desired temperature until measurements down to the lowest specified temperature have been completed.
- The test chamber was allowed to stabilize at +20 degree C for a minimum of 30 minutes. The supply voltage was then adjusted on the EUT from 85% to 115% and the frequency record.

#### 4.3.5 Deviation from Test Standard

No deviation.

#### 4.3.6 EUT Operating Conditions

Same as Item 4.1.6.

#### 4.3.7 Test Result

Type B

Frequency Stability Versus Temp.									
TEMP. (°C)	Power Supply (Vac)	0 Minute		2 Minute		5 Minute		10 Minute	
		Measured Frequency	Frequency Drift	Measured Frequency	Frequency Drift	Measured Frequency	Frequency Drift	Measured Frequency	Frequency Drift
		(MHz)	%	(MHz)	%	(MHz)	%	(MHz)	%
50	120	13.55999	-0.00007	13.55999	-0.00007	13.55999	-0.00007	13.55999	-0.00007
40	120	13.55998	-0.00015	13.55998	-0.00015	13.55998	-0.00015	13.55997	-0.00022
30	120	13.55995	-0.00037	13.55996	-0.00029	13.55995	-0.00037	13.55995	-0.00037
20	120	13.55999	-0.00007	13.55998	-0.00015	13.55999	-0.00007	13.55999	-0.00007
10	120	13.56005	0.00037	13.56005	0.00037	13.56005	0.00037	13.56006	0.00044
0	120	13.55996	-0.00029	13.55996	-0.00029	13.55996	-0.00029	13.55996	-0.00029
-10	120	13.56003	0.00022	13.56002	0.00015	13.56002	0.00015	13.56002	0.00015
-20	120	13.55994	-0.00044	13.55993	-0.00052	13.55994	-0.00044	13.55994	-0.00044

Frequency Stability Versus Voltage									
TEMP. (°C)	Power Supply (Vac)	0 Minute		2 Minute		5 Minute		10 Minute	
		Measured Frequency	Frequency Drift	Measured Frequency	Frequency Drift	Measured Frequency	Frequency Drift	Measured Frequency	Frequency Drift
		(MHz)	%	(MHz)	%	(MHz)	%	(MHz)	%
20	138	13.55999	-0.00007	13.55998	-0.00015	13.55999	-0.00007	13.55999	-0.00007
	120	13.55999	-0.00007	13.55998	-0.00015	13.55999	-0.00007	13.55999	-0.00007
	102	13.55999	-0.00007	13.55998	-0.00015	13.55999	-0.00007	13.55999	-0.00007

#### 4.4 20dB Bandwidth

##### 4.4.1 Limits of 20dB Bandwidth Measurement

The 20dB bandwidth shall be specified in operating frequency band.

##### 4.4.2 Test Setup

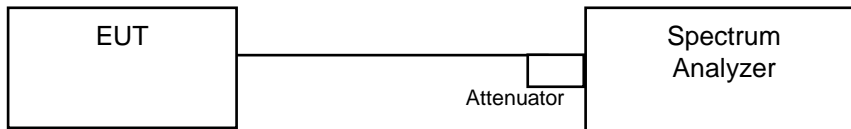

##### 4.4.3 Test Instruments

Refer to section 4.1.2 to get information of above instrument.

##### 4.4.4 Test Procedures

The bandwidth of the fundamental frequency was measured by spectrum analyzer with 1kHz RBW and 3kHz VBW. The 20dB bandwidth is defined as the total spectrum the power of which is higher than peak power minus 20dB.

##### 4.4.5 Deviation from Test Standard

No deviation.

##### 4.4.6 EUT Operating Conditions

Same as Item 4.1.6.

### 4.4.7 Test Results

#### Type B

20dBc Bandwidth (kHz)	Operating frequency band (MHz)	Pass / Fail
2.681	13.553~13.567	Pass

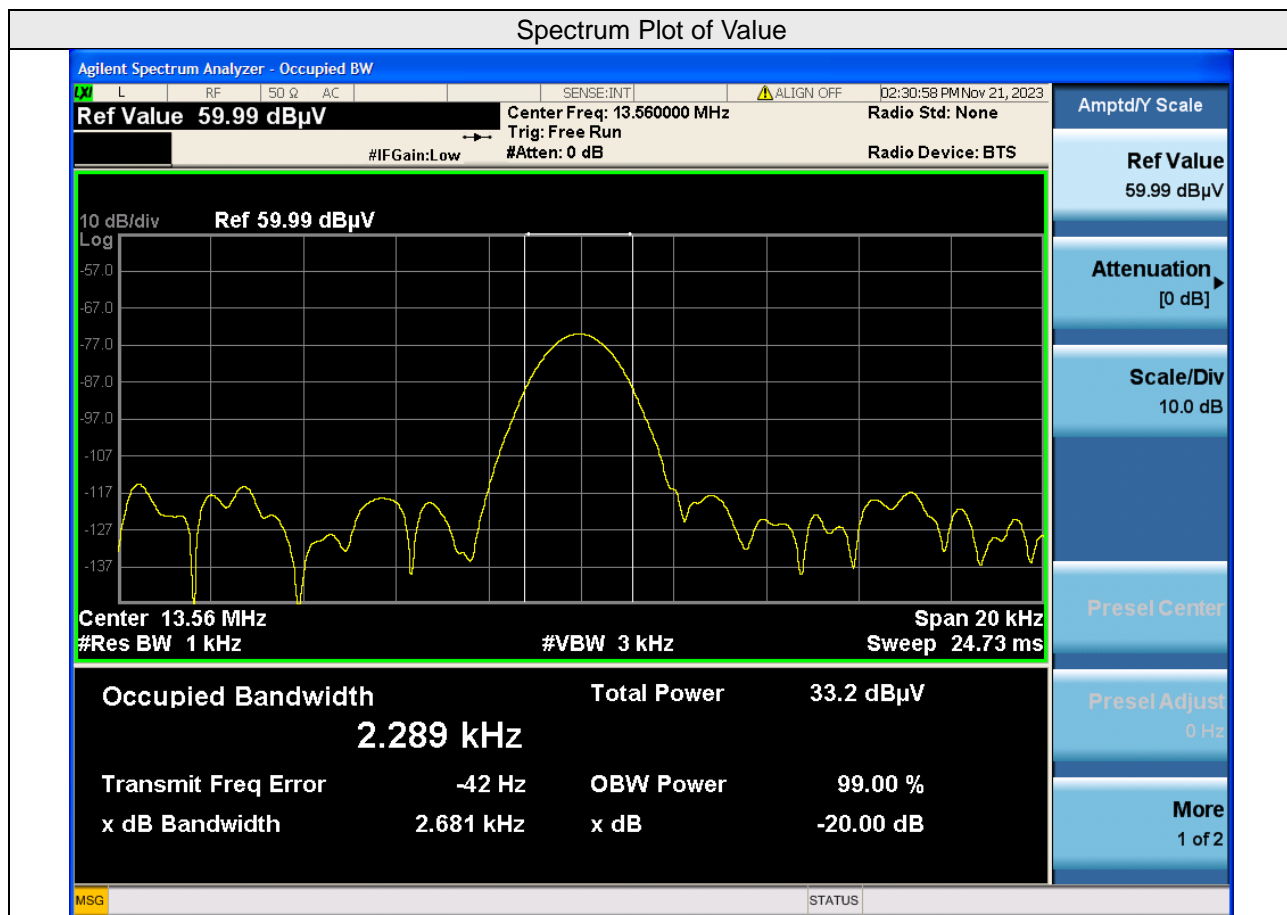

Note: The signal look like CW signal, so RBW can't be match 1~5 % OBW.

## 5 Pictures of Test Arrangements

Please refer to the attached file (Test Setup Photo).

## Appendix – Information of the Testing Laboratories

We, Bureau Veritas Consumer Products Services (H.K.) Ltd., Taoyuan Branch, were founded in 1988 to provide our best service in EMC, Radio, Telecom and Safety consultation. Our laboratories are FCC recognized accredited test firms and accredited and approved according to ISO/IEC 17025.

If you have any comments, please feel free to contact us at the following:

### Lin Kou EMC/RF Lab

Tel: 886-2-26052180

Fax: 886-2-26051924

### Hsin Chu EMC/RF/Telecom Lab

Tel: 886-3-6668565

Fax: 886-3-6668323

### Hwa Ya EMC/RF/Safety Lab

Tel: 886-3-3183232

Fax: 886-3-3270892

**Email:** [service.adt@tw.bureauveritas.com](mailto:service.adt@tw.bureauveritas.com)

**Web Site:** <http://ee.bureauveritas.com.tw>

The address and road map of all our labs can be found in our web site also.

--- END ---