

FCC Test Report

Report No.: RFBEDW-WTW-P21123277

FCC ID: E2K-DWRFID2003

Test Model: DWRFID2003

Received Date: Dec. 22, 2021

Test Date: Dec. 23, 2021 ~ Dec. 28, 2021

Issued Date: Jan. 12, 2022

Applicant: Dell Inc.

Address: One Dell Way, Round Rock, Texas 78682, USA

Issued By: Bureau Veritas Consumer Products Services (H.K.) Ltd., Taoyuan Branch
Lin Kou Laboratories

Lab Address: No. 47-2, 14th Ling, Chia Pau Vil., Lin Kou Dist., New Taipei City, Taiwan

Test Location: No. 19, Hwa Ya 2nd Rd., Wen Hwa Vil., Kwei Shan Dist., Taoyuan City
33383, Taiwan

**FCC Registration /
Designation Number:** 788550 / TW0003



This report is for your exclusive use. Any copying or replication of this report to or for any other person or entity, or use of our name or trademark, is permitted only with our prior written permission. This report sets forth our findings solely with respect to the test samples identified herein. The results set forth in this report are not indicative or representative of the quality or characteristics of the lot from which a test sample was taken or any similar or identical product unless specifically and expressly noted. Our report includes all of the tests requested by you and the results thereof based upon the information that you provided to us. You have 60 days from date of issuance of this report to notify us of any material error or omission caused by our negligence, provided, however, that such notice shall be in writing and shall specifically address the issue you wish to raise. A failure to raise such issue within the prescribed time shall constitute your unqualified acceptance of the completeness of this report, the tests conducted and the correctness of the report contents. Unless specific mention, the uncertainty of measurement has been explicitly taken into account to declare the compliance or non-compliance to the specification.

Table of Contents

Release Control Record	3
1 Certificate of Conformity	4
2 Summary of Test Results	5
2.1 Measurement Uncertainty.....	5
2.2 Modification Record	5
3 General Information	6
3.1 General Description of EUT	6
3.2 Description of Test Modes.....	7
3.2.1 Test Mode Applicability and Tested Channel Detail.....	7
3.3 Description of Support Units	9
3.3.1 Configuration of System under Test	9
3.4 General Description of Applied Standards and references.....	9
4 Test Types and Results	10
4.1 Radiated Emission Measurement.....	10
4.1.1 Limits of Radiated Emission Measurement	10
4.1.2 Test Instruments	11
4.1.3 Test Procedures.....	12
4.1.4 Deviation from Test Standard	12
4.1.5 Test Set Up	13
4.1.6 EUT Operating Conditions.....	13
4.1.7 Test Results	14
4.2 Conducted Emission Measurement.....	22
4.2.1 Limits of Conducted Emission Measurement	22
4.2.2 Test Instruments	22
4.2.3 Test Procedures.....	23
4.2.4 Deviation from Test Standard	23
4.2.5 Test Setup.....	23
4.2.6 EUT Operating Conditions.....	23
4.2.7 Test Results	24
4.3 Frequency Stability	26
4.3.1 Limits of Frequency Stability Measurement	26
4.3.2 Test Setup.....	26
4.3.3 Test Instruments	26
4.3.4 Test Procedure	26
4.3.5 Deviation from Test Standard	26
4.3.6 EUT Operating Conditions.....	26
4.3.7 Test Results	27
4.4 20 dB Bandwidth.....	28
4.4.1 Limits of 20 dB Bandwidth Measurement.....	28
4.4.2 Test Setup.....	28
4.4.3 Test Instruments	28
4.4.4 Test Procedures.....	28
4.4.5 Deviation from Test Standard	28
4.4.6 EUT Operating Conditions.....	28
4.4.7 Test Results	29
5 Pictures of Test Arrangements	30
Appendix – Information of the Testing Laboratories	31



Release Control Record

Issue No.	Description	Date Issued
RFBEDW-WTW-P21123277	Original Release	Jan. 12, 2022

1 Certificate of Conformity

Product: RFID 13.56MHz Wireless Module

Brand: DELL

Test Model: DWRFID2003

Sample Status: Production Unit

Applicant: Dell Inc.

Test Date: Dec. 23, 2021 ~ Dec. 28, 2021

Standards: 47 CFR FCC Part 15, Subpart C (Section 15.225)
47 CFR FCC Part 15, Subpart C (Section 15.215)
ANSI C63.10:2013

The above equipment has been tested by **Bureau Veritas Consumer Products Services (H.K.) Ltd., Taoyuan Branch**, and found compliance with the requirement of the above standards. The test record, data evaluation & Equipment Under Test (EUT) configurations represented herein are true and accurate accounts of the measurements of the sample's RF characteristics under the conditions specified in this report.

Lena Wang
Prepared by : _____, **Date:** _____
Lena Wang / Specialist

Jeremy Lin
Approved by : _____, **Date:** _____
Jeremy Lin / Project Engineer

2 Summary of Test Results

47 CFR FCC Part 15, Subpart C (Section 15.225, 15.215)			
FCC Clause	Test Item	Result	Remarks
15.207	Conducted emission test	Pass	Meet the requirement of limit. Minimum passing margin is -3.34 dB at 0.20577 MHz.
15.225 (a)	The field strength of any emissions within the band 13.553-13.567 MHz	Pass	Meet the requirement of limit. Minimum passing margin is -80.71 dB at 13.56 MHz.
15.225 (b)	The field strength of any emissions within the bands 13.410-13.553 MHz and 13.567-13.710 MHz	Pass	Meet the requirement of limit.
15.225 (c)	The field strength of any emissions within the bands 13.110-13.410 MHz and 13.710-14.010 MHz	Pass	Meet the requirement of limit.
15.225 (d)	The field strength of any emissions appearing outside of the 13.110-14.010 MHz band	Pass	Meet the requirement of limit. Minimum passing margin is -6.51 dB at 56.19 MHz.
15.225 (e)	The frequency tolerance	Pass	Meet the requirement of limit.
15.215 (c)	20 dB Bandwidth	Pass	Meet the requirement of limit.
15.203	Antenna Requirement	Pass	No antenna connector is used.

Note: Determining compliance based on the results of the compliance measurement, not taking into account measurement instrumentation uncertainty.

2.1 Measurement Uncertainty

Where relevant, the following measurement uncertainty levels have been estimated for tests performed on the EUT as specified in CISPR 16-4-2:

Measurement	Frequency	Expanded Uncertainty (k=2) (±)
Conducted Emissions at mains ports	150 kHz ~ 30 MHz	2.79 dB
Radiated Emissions up to 1 GHz	9 kHz ~ 30 MHz	3.04 dB
	30 MHz ~ 200 MHz	2.93 dB
	200 MHz ~ 1000 MHz	2.95 dB

2.2 Modification Record

There were no modifications required for compliance.

3 General Information

3.1 General Description of EUT

Product	RFID 13.56MHz Wireless Module
Brand	DELL
Test Model	DWRFID2003
Status of EUT	Production Unit
Power Supply Rating	3.3 Vdc (host equipment)
Modulation Type	ASK
Data Rate	Type A: 106 kbit/s Type B: 106 kbit/s Type F: 212 kbit/s, 424 kbit/s Type V: 26.48 kbit/s
Operating Frequency	13.56 MHz
Field Strength (Maximum)	3.29 dBuV/m (30m)
Antenna Type	Refer to Note as below
Accessory Device	Refer to Note as below
Data Cable Supplied	NA

Note:

1. The EUT is authorized for use in specific End-product. Please refer to below table for further details.

Product Name	Brand	Model
Portable Computer	DELL	P114F

2. The antenna information is listed as below.

Antenna Manufacturer	Antenna Model No.	Antenna Type	Antenna Gain (dBi)	Note
Hong-Bo	KF0XK (DC33002MT0L)	Loop Antenna	N/A	Main source
Speedwire	KF0XK (DC33002MS0L)	Loop Antenna	N/A	2nd source

*After pre-test, Hong-Bo antenna was the worst for the final tests.

3. The EUT support NFC Type: A, B, F, V. The Type B is the worst for the final tests.

4. The above Antenna information is declared by manufacturer and for more detailed features description, please refer to the manufacturer's specifications, the laboratory shall not be held responsible.

5. The End-product contains following accessory devices.

Product	Brand	Model	Description
Adapter	DELL	LA240PM200	I/P: 100-120 Vac, 50/60 Hz, 3.5 A, 200-240 Vac, 50/60 Hz, 2.5 A O/P: 19.5 Vdc, 12.31A Power Cord: 0.85m
Battery	DELL	RCVVT	6827mAh, 83Wh, 11.55Vdc

6. The above EUT information is declared by manufacturer and for more detailed features description, please refers to the manufacturer's specifications or user's manual.

3.2 Description of Test Modes

One channel was provided to this EUT:

Channel	Frequency (MHz)
1	13.56

3.2.1 Test Mode Applicability and Tested Channel Detail

EUT Configure Mode	Applicable To				Description
	RE	PLC	FS	EB	
-	√	√	√	√	EUT with Hong-Bo Ant

Where **RE:** Radiated Emission **PLC:** Power Line Conducted Emission
FS: Frequency Stability **EB:** 20 dB Bandwidth measurement

NOTE: The EUT had been pre-test on Type A, Type B, Type F and Type V. Type B was the worst case for final test.

Radiated Emission Test:

- Pre-Scan has been conducted to determine the worst-case mode from all possible combinations between available modulations, data rates and antenna ports (if EUT with antenna diversity architecture).
- Following channel(s) was (were) selected for the final test as listed below.

EUT Configure Mode	Available Channel	Tested Channel	Modulation Type
-	1	1	ASK

Power Line Conducted Emission Test:

- Pre-Scan has been conducted to determine the worst-case mode from all possible combinations between available modulations, data rates and antenna ports (if EUT with antenna diversity architecture).
- Following channel(s) was (were) selected for the final test as listed below.

EUT Configure Mode	Available Channel	Tested Channel	Modulation Type
-	1	1	ASK

Frequency Stability:

- This item includes all test value of each mode, but only includes spectrum plot of worst value of each mode.
- Pre-Scan has been conducted to determine the worst-case mode from all possible combinations between available modulations, data rates and antenna ports (if EUT with antenna diversity architecture).
- Following channel(s) was (were) selected for the final test as listed below.

EUT Configure Mode	Available Channel	Tested Channel	Modulation Type
-	1	1	ASK

20 dB Bandwidth:

- This item includes all test value of each mode, but only includes spectrum plot of worst value of each mode.
- Pre-Scan has been conducted to determine the worst-case mode from all possible combinations between available modulations, data rates and antenna ports (if EUT with antenna diversity architecture).
- Following channel(s) was (were) selected for the final test as listed below.

EUT Configure Mode	Available Channel	Tested Channel	Modulation Type
-	1	1	ASK

Test Condition:

Applicable To	Environmental Conditions	Input Power	Tested By
RE	22 deg. C, 69 % RH	120 Vac, 60 Hz	Vincent Chen
FS	22 deg. C, 68 % RH	120 Vac, 60 Hz	Vincent Chen
PLC	21 deg. C, 64 % RH	120 Vac, 60 Hz	Thomas Cheng
EB	22 deg. C, 68 % RH	120 Vac, 60 Hz	Vincent Chen

3.3 Description of Support Units

The EUT has been tested as an independent unit together with other necessary accessories or support units. The following support units or accessories were used to form a representative test configuration during the tests.

ID	Product	Brand	Model No.	Serial No.	FCC ID	Remarks
A.	Portable Computer	DELL	P114F	NA	NA	Provided by client
B.	Adapter	DELL	LA240PM200	NA	NA	Provided by client
C	Earphone	HTC	NA	NA	NA	-
D	Monitor	DELL	SE2416Hc	CN-OWJKMC-64180-66D-013B-A00	NA	-
E	Terminal	NA	NA	NA	NA	-
F	USB Flash	SanDisk	SDDDC3-032G	NA	NA	Type C
		Transcend	32GB	NA	NA	Type A

ID	Descriptions	Qty.	Length (m)	Shielding (Yes/No)	Cores (Qty.)	Remarks
1.	DC Power cable	1	1.8	-	0	Provided by client
2.	Audio cable	1	1.2	N	0	-
3.	HDMI cable	1	1.8	Y	0	-
4.	LAN cable	1	1.5	N	0	-
5.	AC Power cable	1	0.85	N	0	Provided by client

Note: All power cords of the above support units are non-shielded (1.8m).

3.3.1 Configuration of System under Test

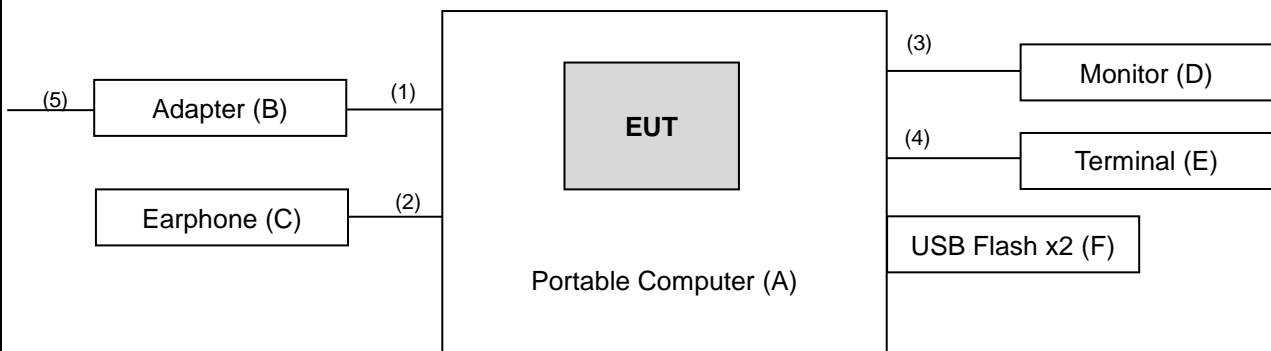

3.4 General Description of Applied Standards and references

The EUT is a RF Product. According to the specifications of the manufacturer, it must comply with the requirements of the following standards and references:

FCC Part 15, Subpart C (15.225)

FCC Part 15, Subpart C (15.215)

ANSI C63.10-2013

All test items have been performed and recorded as per the above standards.

References Test Guidance :

KDB 414788 D01 Radiated Test Site v01r01

All test items have been performed as a reference to the above KDB test guidance.

4 Test Types and Results

4.1 Radiated Emission Measurement

4.1.1 Limits of Radiated Emission Measurement

- a. The field strength of any emissions within the band 13.553-13.567 MHz shall not exceed 15,848 microvolts/meter at 30 meters.
- b. Within the bands 13.410-13.553 MHz and 13.567-13.710 MHz, the field strength of any emissions shall not exceed 334 microvolts/meter at 30 meters.
- c. Within the bands 13.110-13.410 MHz and 13.710-14.010 MHz the field strength of any emissions shall not exceed 106 microvolts/meter at 30 meters.
- d. The field strength of any emissions appearing outside of the 13.110-14.010 MHz band shall not exceed the general radiated emission limits in §15.209 as below table:

Frequencies (MHz)	Field Strength (microvolts/meter)	Measurement Distance (meters)
0.009 ~ 0.490	2400/F (kHz)	300
0.490 ~ 1.705	24000/F (kHz)	30
1.705 ~ 30.0	30	30
30 ~ 88	100	3
88 ~ 216	150	3
216 ~ 960	200	3
Above 960	500	3

NOTE:

1. The lower limit shall apply at the transition frequencies.
2. Emission level (dBuV/m) = 20 log Emission level (uV/m).
3. For frequencies above 1000 MHz, the field strength limits are based on average detector, however, the peak field strength of any emission shall not exceed the maximum permitted average limits, specified above by more than 20 dB under any condition of modulation.

4.1.2 Test Instruments

Description & Manufacturer	Model No.	Serial No.	Date of Calibration	Due Date of Calibration
Test Receiver Agilent	N9038A	MY55420137	Apr. 09, 2021	Apr. 08, 2022
Spectrum Analyzer Agilent	N9010A	MY52220207	Jan. 05, 2021	Jan. 04, 2022
Spectrum Analyzer ROHDE & SCHWARZ	FSU43	101261	Apr. 12, 2021	Apr. 11, 2022
HORN Antenna SCHWARZBECK	BBHA 9120D	9120D-969	Nov. 14, 2021	Nov. 13, 2022
BILOG Antenna SCHWARZBECK	VULB 9168	9168-472	Oct. 28, 2021	Oct. 27, 2022
Fixed Attenuator WOKEN	MDCS18N-10	MDCS18N-10-01	Apr. 13, 2021	Apr. 12, 2022
Loop Antenna	EM-6879	269	Sep. 16, 2021	Sep. 17, 2022
Loop Antenna TESEQ	HLA 6121	45745	Jul. 21, 2021	Jul. 20, 2022
Preamplifier EMCI	EMC001340	980201	Sep. 15, 2021	Sep. 14, 2022
Preamplifier EMCI	EMC 330H	980112	Oct. 05, 2021	Oct. 04, 2022
RF Coaxial Cable EMCI	EMC104-SM-SM-8000	171005	Oct. 05, 2021	Oct. 04, 2022
RF Coaxial Cable HUBER+SUHNNER	SUCOFLEX 104	EMC104-SM-SM-1000(140807)	Oct. 05, 2021	Oct. 04, 2022
RF Coaxial Cable WOKEN	8D-FB	Cable-Ch10-01	Oct. 05, 2021	Oct. 04, 2022
Boresight Antenna Fixture	FBA-01	FBA-SIP01	NA	NA
Software BV ADT	E3 6.120103	NA	NA	NA
Antenna Tower MF	MFA-440H	NA	NA	NA
Turn Table MF	MFT-201SS	NA	NA	NA
Antenna Tower & Turn Table Controller MF	MF-7802	NA	NA	NA
STANDARD TEMPERATURE & HUMIDITY CHAMBER WIT	TH-4S-C	W981030	Jun. 01, 2021	May 31, 2022
AC Power Source Extech	6905S	1991553	NA	NA
Digital Multimeter Fluke	87-III	70360742	Jun. 24, 2021	Jun. 23, 2022

- Note: 1. The calibration interval of the above test instruments is 12 months and the calibrations are traceable to NML/ROC and NIST/USA.
2. The test was performed in HwaYa Chamber 10.

4.1.3 Test Procedures

For Radiated Emission below 30 MHz

- a. The EUT was placed on the top of a rotating table 0.8 meters above the ground at a 3 meter chamber room. The table was rotated 360 degrees to determine the position of the highest radiation.
- b. The EUT was set 3 meters away from the interference-receiving antenna, which was mounted on the top of a variable-height antenna tower.
- c. Parallel, perpendicular, and ground-parallel orientations of the antenna are set to make the measurement.
- d. For each suspected emission, the EUT was arranged to its worst case and the rotatable table was turned from 0 degrees to 360 degrees to find the maximum reading.
- e. The test-receiver system was set to Quasi-Peak Detect Function and Specified Bandwidth with Maximum Hold Mode, except for the frequency band (9kHz-90kHz, 110Hz-490kHz) set to average detect function.

Note:

1. The resolution bandwidth and video bandwidth of test receiver/spectrum analyzer is 9 kHz at frequency below 30 MHz.
2. There is a comparison data of both open-field test site and semi-Anechoic chamber, and the result came out very similar.

For Radiated Emission above 30 MHz

- a. The EUT was placed on the top of a rotating table 0.8 meters above the ground at 3 meter chamber room for test. The table was rotated 360 degrees to determine the position of the highest radiation.
- b. The EUT was set 3 meters away from the interference-receiving antenna, which was mounted on the top of a variable-height antenna tower.
- c. The height of antenna is varied from one meter to four meters above the ground to determine the maximum value of the field strength. Both horizontal and vertical polarizations of the antenna are set to make the measurement.
- d. For each suspected emission, the EUT was arranged to its worst case and then the antenna was tuned to heights from 1 meter to 4 meters and the rotatable table was turned from 0 degrees to 360 degrees to find the maximum reading.
- e. The test-receiver system was set to quasi-peak detect function and specified bandwidth with maximum hold mode when the test frequency is below 1 GHz.

Note:

1. The resolution bandwidth and video bandwidth of test receiver/spectrum analyzer is 120 kHz for Quasi-peak detection (QP) at frequency below 1 GHz.
2. All modes of operation were investigated and the worst-case emissions are reported.

4.1.4 Deviation from Test Standard

No deviation.

4.1.5 Test Set Up

<Radiated Emission below 30 MHz>

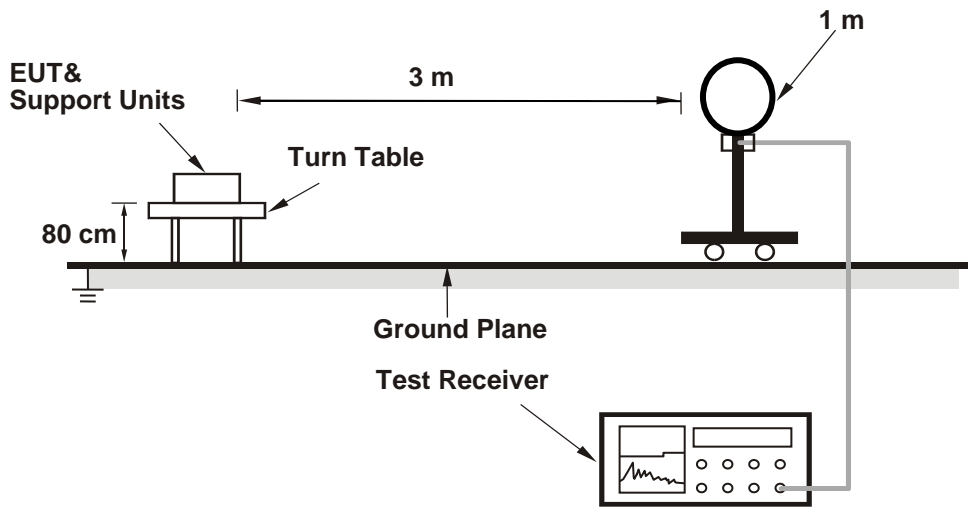

<Radiated Emission 30 MHz to 1 GHz>

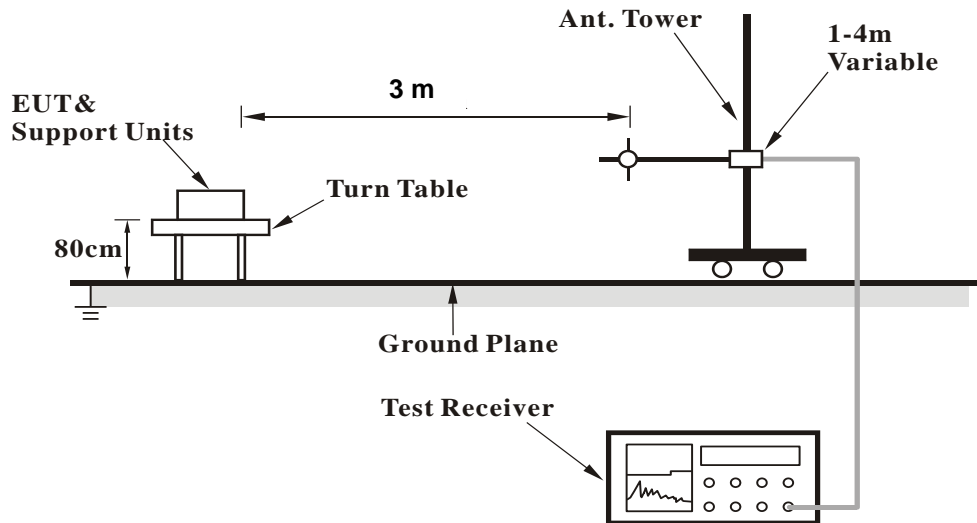

For the actual test configuration, please refer to the attached file (Test Setup Photo).

KDB 414788 OFS and Chamber Correlation Justification

- Base on FCC 15.31 (f) (2): measurements may be performed at a distance closer than that specified in the regulations; however, an attempt should be made to avoid making measurements in the near field.
- Open-field site and chamber correlation testing had been performed and chamber measured test result is the worst case test result.

4.1.6 EUT Operating Conditions

- a. Placed the EUT on the testing table.
- b. Set the EUT under transmission condition continuously at specific channel frequency.

4.1.7 Test Results

Type B

EUT Test Condition		Measurement Detail	
Channel	Channel 1	Frequency Range	13.553 ~ 13.567MHz
Input Power	120Vac, 60Hz	Detector Function	Quasi-Peak
Environmental Conditions	22 deg. C, 69% RH	Tested By	Vincent Chen

Antenna Polarity & Test Distance: Loop Antenna Parallel At 3m								
No.	Freq. (MHz)	Emission Level (dBuV/m) (30m)	Limit (dBuV/m)	Margin (dB)	Antenna Height (m)	Table Angle (Degree)	Raw Value (dBuV) (3m)	Correction Factor (dB/m)
1	*13.560	1.05 QP	84.00	-82.95	1.00	144	19.04	-17.99

Remarks:

1. Emission Level(dBuV/m) = Raw Value(dBuV) + Correction Factor(dB/m)
2. Correction Factor(dB/m) = Antenna Factor(dB/m) + Cable Factor(dB) – Pre-Amplifier Factor(dB)+Distance Factor
3. The other emission levels were very low against the limit.
4. Margin value = Emission Level – Limit value
5. “ * “ : Fundamental frequency
6. Above limits have been translated by the formula

The measured field strength was extrapolated to distance 30 meters distance factor@3m = $40 \times \log(3/10) = -40\text{dB}$, using the formula that the limit of field strength varies as the inverse distance square (40dB per decade of distance)

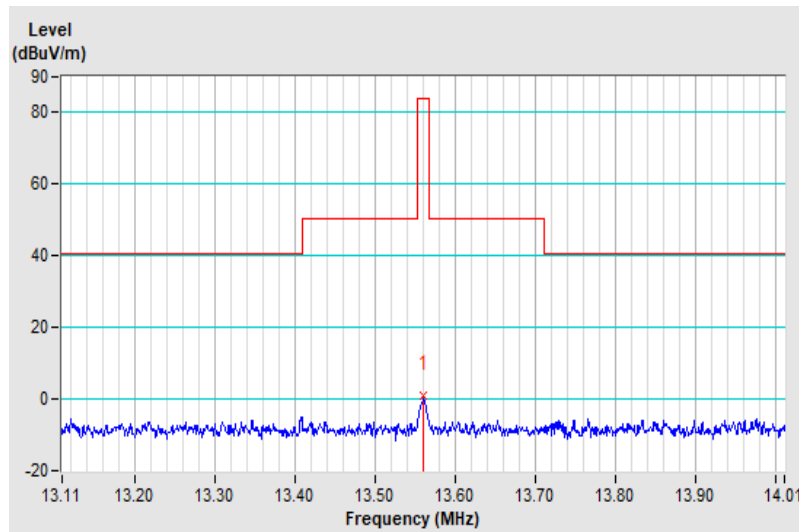

EUT Test Condition		Measurement Detail	
Channel	Channel 1	Frequency Range	13.553 ~ 13.567MHz
Input Power	120Vac, 60Hz	Detector Function	Quasi-Peak
Environmental Conditions	22 deg. C, 69% RH	Tested By	Vincent Chen

Antenna Polarity & Test Distance: Loop Antenna Perpendicular At 3m								
No.	Freq. (MHz)	Emission Level (dBuV/m) (30m)	Limit (dBuV/m)	Margin (dB)	Antenna Height (m)	Table Angle (Degree)	Raw Value (dBuV) (3m)	Correction Factor (dB/m)
1	*13.560	-0.29 QP	84.00	-84.29	1.00	218	17.70	-17.99

Remarks:

1. Emission Level(dBuV/m) = Raw Value(dBuV) + Correction Factor(dB/m)
2. Correction Factor(dB/m) = Antenna Factor(dB/m) + Cable Factor(dB) – Pre-Amplifier Factor(dB)+Distance Factor
3. The other emission levels were very low against the limit.
4. Margin value = Emission Level – Limit value
5. “ * “ : Fundamental frequency
6. Above limits have been translated by the formula

The measured field strength was extrapolated to distance 30 meters distance factor@3m = $40 \cdot \log(3/10) = -40\text{dB}$, using the formula that the limit of field strength varies as the inverse distance square (40dB per decade of distance)

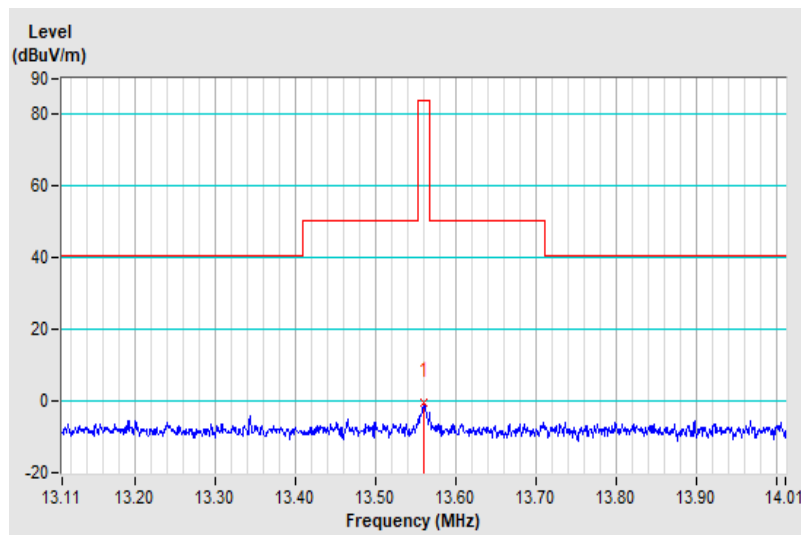

EUT Test Condition		Measurement Detail	
Channel	Channel 1	Frequency Range	13.553 ~ 13.567MHz
Input Power	120Vac, 60Hz	Detector Function	Quasi-Peak
Environmental Conditions	22 deg. C, 69% RH	Tested By	Vincent Chen

Antenna Polarity & Test Distance: Loop Antenna Ground-Parallel At 3m								
No.	Freq. (MHz)	Emission Level (dBuV/m) (30m)	Limit (dBuV/m)	Margin (dB)	Antenna Height (m)	Table Angle (Degree)	Raw Value (dBuV) (3m)	Correction Factor (dB/m)
1	*13.560	3.29 QP	84.00	-80.71	1.00	122	21.28	-17.99

Remarks:

1. Emission Level(dBuV/m) = Raw Value(dBuV) + Correction Factor(dB/m)
2. Correction Factor(dB/m) = Antenna Factor(dB/m) + Cable Factor(dB) – Pre-Amplifier Factor(dB)+Distance Factor
3. The other emission levels were very low against the limit.
4. Margin value = Emission Level – Limit value
5. “ * “ : Fundamental frequency
6. Above limits have been translated by the formula

The measured field strength was extrapolated to distance 30 meters distance factor@3m = $40 * \log(3/10) = -40\text{dB}$, using the formula that the limit of field strength varies as the inverse distance square (40dB per decade of distance)

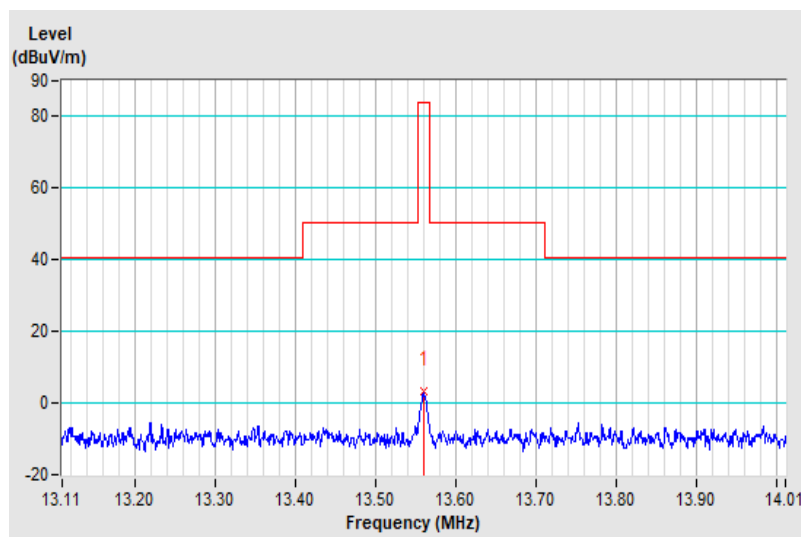

EUT Test Condition		Measurement Detail	
Channel	Channel 1	Frequency Range	Below 30MHz
Input Power	120Vac, 60Hz	Detector Function	Peak
Environmental Conditions	22 deg. C, 69% RH	Tested By	Vincent Chen

Antenna Polarity & Test Distance: Loop Antenna Parallel At 3m								
No.	Freq. (MHz)	Emission Level (dBuV/m) (30m)	Limit (dBuV/m)	Margin (dB)	Antenna Height (m)	Table Angle (Degree)	Raw Value (dBuV) (3m)	Correction Factor (dB/m)
1	5.800	-1.96 PK	29.54	-31.50	1.00	153	17.57	-19.53
2	7.210	-2.52 PK	29.54	-32.06	1.00	252	16.53	-19.05
3	10.090	-2.93 PK	29.54	-32.47	1.00	121	15.17	-18.10
4	16.860	-3.29 PK	29.54	-32.83	1.00	196	14.60	-17.89
5	22.620	-3.38 PK	29.54	-32.92	1.00	57	14.47	-17.85
6	27.120	-4.03 PK	29.54	-33.57	1.00	231	13.91	-17.94

Remarks:

1. Emission Level(dBuV/m) = Raw Value(dBuV) + Correction Factor(dB/m)
2. Correction Factor(dB/m) = Antenna Factor(dB/m) + Cable Factor(dB) – Pre-Amplifier Factor(dB) +Distance Factor
3. The other emission levels were very low against the limit.
4. Margin value = Emission Level – Limit value
5. For 0.49 ~ 30MHz, the measured field strength was extrapolated to distance 30 meters
Distance factor@3m = $40 \cdot \log(3/30) = -40\text{dB}$

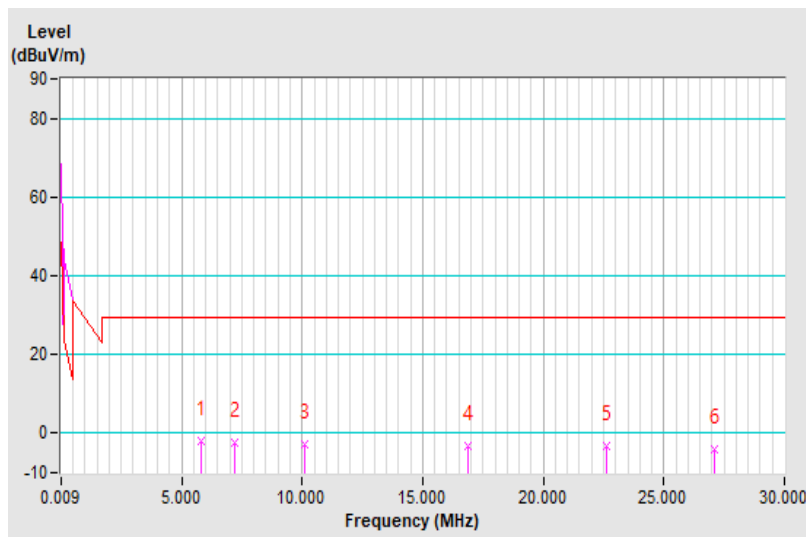

EUT Test Condition		Measurement Detail	
Channel	Channel 1	Frequency Range	Below 30MHz
Input Power	120Vac, 60Hz	Detector Function	Peak
Environmental Conditions	22 deg. C, 69% RH	Tested By	Vincent Chen

Antenna Polarity & Test Distance: Loop Antenna Perpendicular At 3m								
No.	Freq. (MHz)	Emission Level (dBuV/m) (30m)	Limit (dBuV/m)	Margin (dB)	Antenna Height (m)	Table Angle (Degree)	Raw Value (dBuV) (3m)	Correction Factor (dB/m)
1	7.390	-3.80 PK	29.54	-33.34	1.00	142	15.19	-18.99
2	10.780	-4.72 PK	29.54	-34.26	1.00	76	13.36	-18.08
3	16.200	-3.93 PK	29.54	-33.47	1.00	236	13.98	-17.91
4	19.380	-4.18 PK	29.54	-33.72	1.00	222	13.64	-17.82
5	24.510	-3.34 PK	29.54	-32.88	1.00	314	14.55	-17.89
6	27.120	-4.13 PK	29.54	-33.67	1.00	204	13.81	-17.94

Remarks:

1. Emission Level(dBuV/m) = Raw Value(dBuV) + Correction Factor(dB/m)
2. Correction Factor(dB/m) = Antenna Factor(dB/m) + Cable Factor(dB) – Pre-Amplifier Factor(dB) +Distance Factor
3. The other emission levels were very low against the limit.
4. Margin value = Emission Level – Limit value
5. For 0.49 ~ 30MHz, the measured field strength was extrapolated to distance 30 meters
Distance factor@3m = $40 \cdot \log(3/30) = -40\text{dB}$

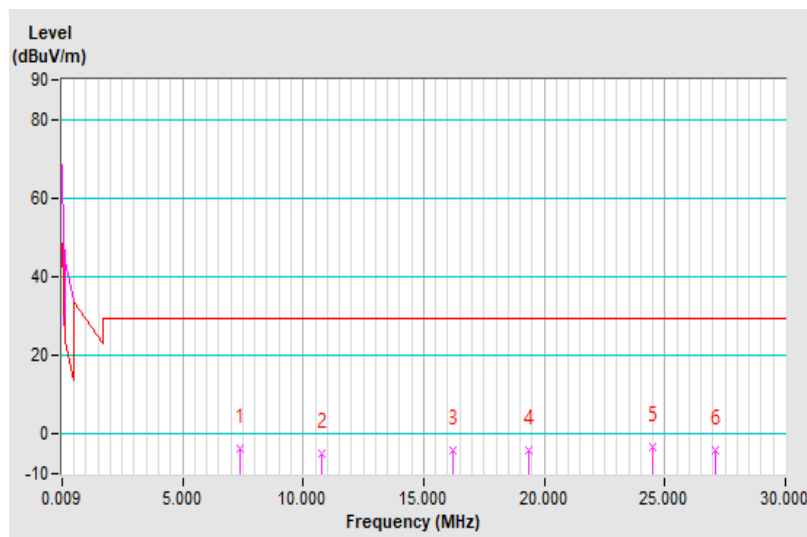

EUT Test Condition		Measurement Detail	
Channel	Channel 1	Frequency Range	Below 30MHz
Input Power	120Vac, 60Hz	Detector Function	Peak
Environmental Conditions	22 deg. C, 69% RH	Tested By	Vincent Chen

Antenna Polarity & Test Distance: Loop Antenna Ground-Parallel At 3m								
No.	Freq. (MHz)	Emission Level (dBuV/m) (30m)	Limit (dBuV/m)	Margin (dB)	Antenna Height (m)	Table Angle (Degree)	Raw Value (dBuV) (3m)	Correction Factor (dB/m)
1	9.970	-2.99 PK	29.54	-32.53	1.00	205	15.12	-18.11
2	12.520	-3.42 PK	29.54	-32.96	1.00	18	14.60	-18.02
3	17.460	-4.37 PK	29.54	-33.91	1.00	323	13.51	-17.88
4	18.360	-4.48 PK	29.54	-34.02	1.00	169	13.37	-17.85
5	25.680	-4.58 PK	29.54	-34.12	1.00	114	13.33	-17.91
6	27.120	-5.50 PK	29.54	-35.04	1.00	236	12.44	-17.94

Remarks:

1. Emission Level(dBuV/m) = Raw Value(dBuV) + Correction Factor(dB/m)
2. Correction Factor(dB/m) = Antenna Factor(dB/m) + Cable Factor(dB) – Pre-Amplifier Factor(dB) +Distance Factor
3. The other emission levels were very low against the limit.
4. Margin value = Emission Level – Limit value
5. For 0.49 ~ 30MHz, the measured field strength was extrapolated to distance 30 meters
Distance factor@3m = $40 \cdot \log(3/30) = -40\text{dB}$

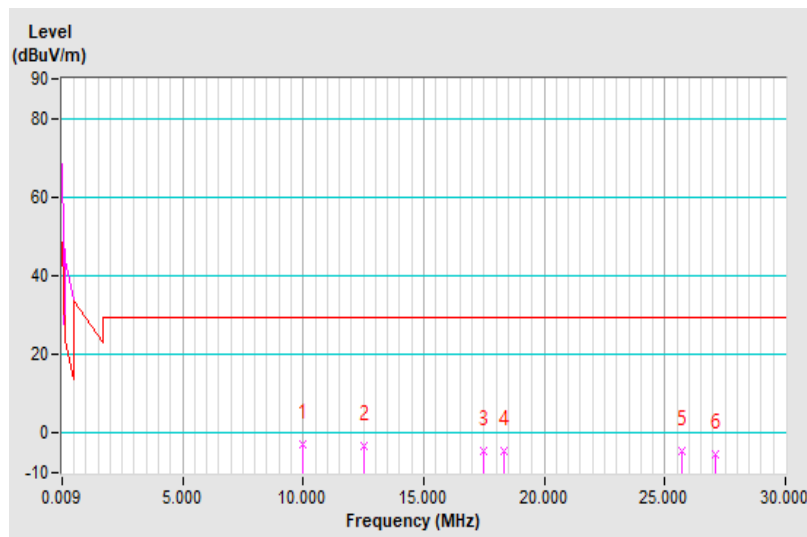

EUT Test Condition		Measurement Detail	
Channel	Channel 1	Frequency Range	Below 1000MHz
Input Power	120Vac, 60Hz	Detector Function	Quasi-Peak
Environmental Conditions	22 deg. C, 69% RH	Tested By	Vincent Chen

Antenna Polarity & Test Distance: Horizontal At 3m								
No.	Freq. (MHz)	Emission Level (dBuV/m)	Limit (dBuV/m)	Margin (dB)	Antenna Height (m)	Table Angle (Degree)	Raw Value (dBuV)	Correction Factor (dB/m)
1	65.89	22.92 QP	40.00	-17.08	2.43 H	91	37.27	-14.35
2	174.54	23.69 QP	43.50	-19.81	1.52 H	315	37.25	-13.56
3	233.72	21.39 QP	46.00	-24.61	2.87 H	225	36.67	-15.28
4	446.17	28.97 QP	46.00	-17.03	2.32 H	229	36.40	-7.43
5	679.97	27.12 QP	46.00	-18.88	1.52 H	12	29.11	-1.99
6	783.77	29.75 QP	46.00	-16.25	1.03 H	243	29.72	0.03

Remarks:

1. Emission Level(dBuV/m) = Raw Value(dBuV) + Correction Factor(dB/m)
2. Correction Factor(dB/m) = Antenna Factor(dB/m) + Cable Factor(dB) – Pre-Amplifier Factor(dB)
3. The other emission levels were very low against the limit.
4. Margin value = Emission Level – Limit value

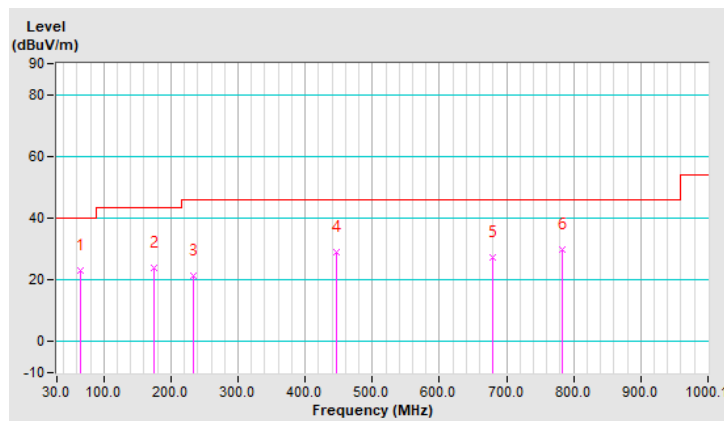

EUT Test Condition		Measurement Detail	
Channel	Channel 1	Frequency Range	Below 1000MHz
Input Power	120Vac, 60Hz	Detector Function	Quasi-Peak
Environmental Conditions	21 deg. C, 66% RH	Tested By	Tim Chen

Antenna Polarity & Test Distance: Vertical At 3m								
No.	Freq. (MHz)	Emission Level (dBuV/m)	Limit (dBuV/m)	Margin (dB)	Antenna Height (m)	Table Angle (Degree)	Raw Value (dBuV)	Correction Factor (dB/m)
1	56.19	33.49 QP	40.00	-6.51	1.02 V	152	46.35	-12.86
2	140.59	29.14 QP	43.50	-14.36	2.32 V	235	41.69	-12.55
3	249.24	27.74 QP	46.00	-18.26	1.45 V	118	42.19	-14.45
4	482.07	27.35 QP	46.00	-18.65	2.32 V	233	34.06	-6.71
5	657.65	33.22 QP	46.00	-12.78	1.79 V	323	35.71	-2.49
6	842.94	30.12 QP	46.00	-15.88	2.04 V	18	29.08	1.04

Remarks:

1. Emission Level(dBuV/m) = Raw Value(dBuV) + Correction Factor(dB/m)
2. Correction Factor(dB/m) = Antenna Factor(dB/m) + Cable Factor(dB) – Pre-Amplifier Factor(dB)
3. The other emission levels were very low against the limit.
4. Margin value = Emission Level – Limit value

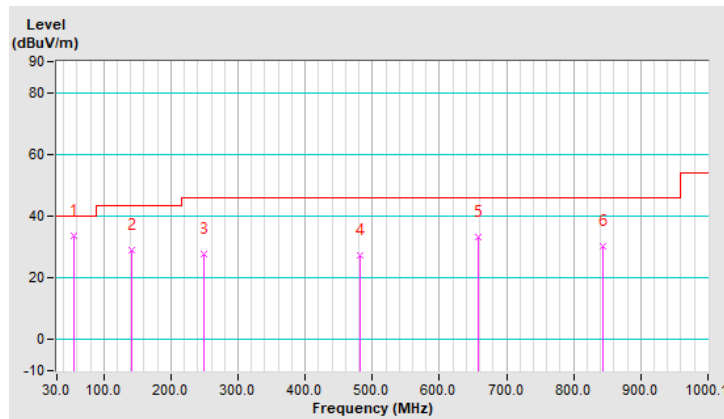

4.2 Conducted Emission Measurement

4.2.1 Limits of Conducted Emission Measurement

Frequency (MHz)	Conducted Limit (dBuV)	
	Quasi-Peak	Average
0.15 - 0.5	66 - 56	56 - 46
0.50 - 5.0	56	46
5.0 - 30.0	60	50

Note:

1. The lower limit shall apply at the transition frequencies.
2. The limit decreases in line with the logarithm of the frequency in the range of 0.15 to 0.50 MHz.
3. All emanations from a class A/B digital device or system, including any network of conductors and apparatus connected thereto, shall not exceed the level of field strengths specified above.

4.2.2 Test Instruments

Description & Manufacturer	Model No.	Serial No.	Date of Calibration	Due Date of Calibration
Test Receiver ROHDE & SCHWARZ	ESR3	102783	Dec. 20, 2021	Dec. 19, 2022
RF signal cable (with 10dB PAD) Woken	5D-FB	Cable-cond2-01	Sep. 04, 2021	Sep. 03, 2022
LISN/AMN ROHDE & SCHWARZ (EUT)	ESH2-Z5	100100	Jan. 28, 2021	Jan. 27, 2022
LISN/AMN ROHDE & SCHWARZ (Peripheral)	ESH3-Z5	100312	Sep. 17, 2021	Sep. 16, 2022
Software ADT	BV ADT_Cond_ V7.3.7.4	NA	NA	NA

- Note: 1. The calibration interval of the above test instruments is 12 months and the calibrations are traceable to NML/ROC and NIST/USA.
2. The test was performed in HwaYa Shielded Room 2. (Conduction 2).
 3. The VCCI Site Registration No. is C-12047.

4.2.3 Test Procedures

- a. The EUT was placed 0.4 meters from the conducting wall of the shielded room with EUT being connected to the power mains through a line impedance stabilization network (LISN). Other support units were connected to the power mains through another LISN. The two LISNs provide 50 ohm/50 uH of coupling impedance for the measuring instrument.
- b. Both lines of the power mains connected to the EUT were checked for maximum conducted interference.
- c. The frequency range from 150 kHz to 30 MHz was searched. Emission levels under (Limit – 20 dB) was not recorded.

Note: The resolution bandwidth and video bandwidth of test receiver is 9 kHz for quasi-peak detection (QP) and average detection (AV) at frequency 0.15 MHz - 30 MHz.

4.2.4 Deviation from Test Standard

No deviation.

4.2.5 Test Setup

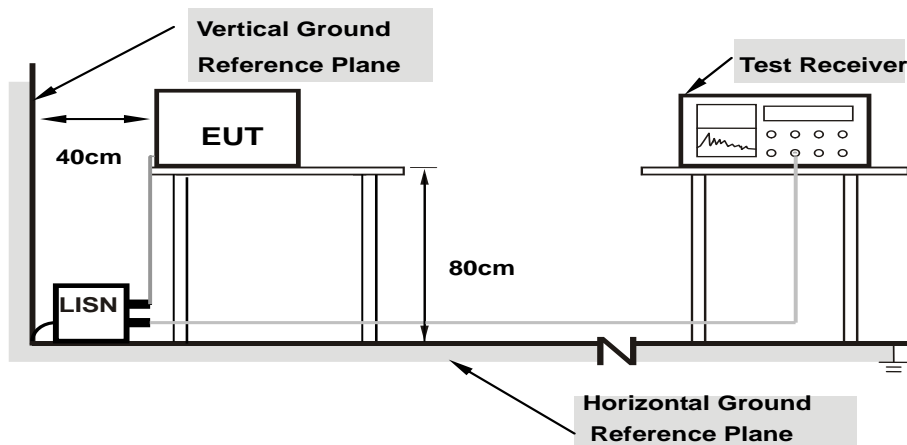

- Note:**
1. Support units were connected to second LISN.
 2. Both of LISNs (AMN) are 80 cm from EUT and at least 80 cm from other units and other metal planes

For the actual test configuration, please refer to the attached file (Test Setup Photo).

4.2.6 EUT Operating Conditions

- a. Placed the EUT on the testing table.
- b. Set the EUT under transmission condition continuously at specific channel frequency.

4.2.7 Test Results

Frequency Range	150kHz ~ 30MHz	Detector Function & Resolution Bandwidth	Quasi-Peak (QP) / Average (AV), 9kHz
Input Power	120Vac, 60Hz	Environmental Conditions	21 °C, 64% RH
Tested by	Thomas Cheng	Test Date	2021/12/24

Phase Of Power : Line (L)										
No	Frequency (MHz)	Correction Factor (dB)	Reading Value (dBuV)		Emission Level (dBuV)		Limit (dBuV)		Margin (dB)	
			Q.P.	AV.	Q.P.	AV.	Q.P.	AV.	Q.P.	AV.
1	0.20523	10.12	44.32	39.66	54.44	49.78	63.40	53.40	-8.96	-3.62
2	0.37400	10.13	33.84	27.21	43.97	37.34	58.41	48.41	-14.44	-11.07
3	0.62200	10.14	35.36	24.58	45.50	34.72	56.00	46.00	-10.50	-11.28
4	1.03000	10.16	34.71	24.65	44.87	34.81	56.00	46.00	-11.13	-11.19
5	13.55800	10.34	31.19	27.70	41.53	38.04	60.00	50.00	-18.47	-11.96
6	20.68600	10.40	38.86	25.79	49.26	36.19	60.00	50.00	-10.74	-13.81

Remarks:

1. Q.P. and AV. are abbreviations of quasi-peak and average individually.
2. The emission levels of other frequencies were very low against the limit.
3. Margin value = Emission level – Limit value
4. Correction factor = Insertion loss + Cable loss
5. Emission Level = Correction Factor + Reading Value

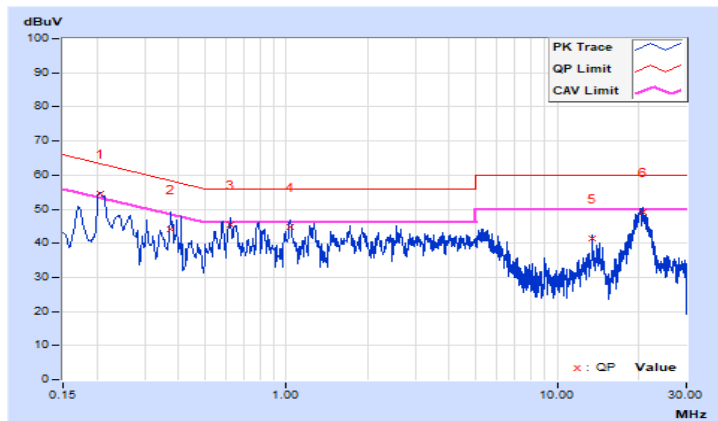

Frequency Range	150kHz ~ 30MHz	Detector Function & Resolution Bandwidth	Quasi-Peak (QP) / Average (AV), 9kHz
Input Power	120Vac, 60Hz	Environmental Conditions	21 °C, 64% RH
Tested by	Thomas Cheng	Test Date	2021/12/24

Phase Of Power : Neutral (N)										
No	Frequency (MHz)	Correction Factor (dB)	Reading Value (dBuV)		Emission Level (dBuV)		Limit (dBuV)		Margin (dB)	
			Q.P.	AV.	Q.P.	AV.	Q.P.	AV.	Q.P.	AV.
1	0.20577	10.12	44.31	39.91	54.43	50.03	63.37	53.37	-8.94	-3.34
2	0.37000	10.13	36.45	22.50	46.58	32.63	58.50	48.50	-11.92	-15.87
3	0.61000	10.14	33.75	24.43	43.89	34.57	56.00	46.00	-12.11	-11.43
4	1.11800	10.17	35.37	15.88	45.54	26.05	56.00	46.00	-10.46	-19.95
5	13.55800	10.43	31.08	27.72	41.51	38.15	60.00	50.00	-18.49	-11.85
6	20.00200	10.57	38.14	19.38	48.71	29.95	60.00	50.00	-11.29	-20.05

Remarks:

1. Q.P. and AV. are abbreviations of quasi-peak and average individually.
2. The emission levels of other frequencies were very low against the limit.
3. Margin value = Emission level – Limit value
4. Correction factor = Insertion loss + Cable loss
5. Emission Level = Correction Factor + Reading Value

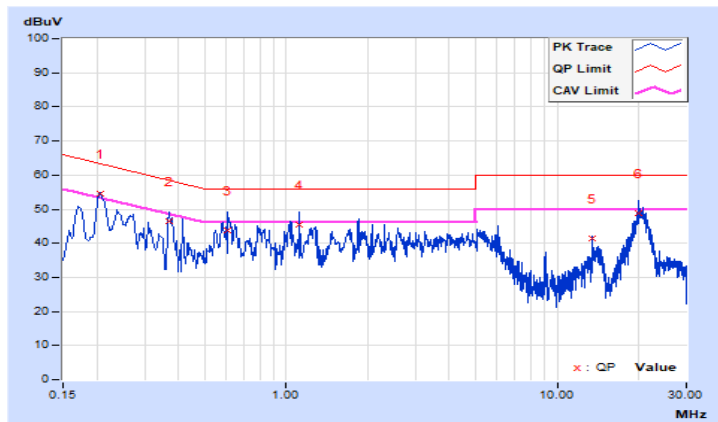

4.3 Frequency Stability

4.3.1 Limits of Frequency Stability Measurement

The frequency tolerance of the carrier signal shall be maintained within +/- 0.01 % of the operating frequency over a temperature variation of -20 degrees to 50 degrees C at normal supply voltage, and for a variation in the primary supply voltage from 85 % to 115 % of the rated supply voltage at a temperature of 20 degrees C.

4.3.2 Test Setup

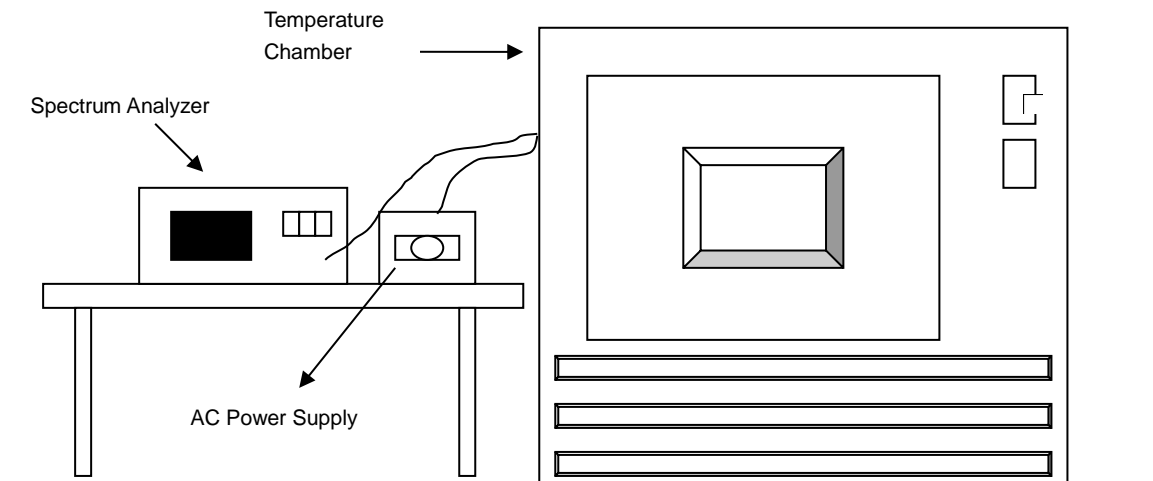

4.3.3 Test Instruments

Refer to section 4.1.2 to get information of above instrument.

4.3.4 Test Procedure

- The EUT was placed inside the environmental test chamber and powered by nominal AC voltage.
- Turned the EUT on and coupled its output to a spectrum analyzer.
- Turned the EUT off and set the chamber to the highest temperature specified.
- Allowed sufficient time (approximately 30 min) for the temperature of the chamber to stabilize then turned the EUT on and measured the operating frequency after 2, 5, and 10 minutes.
- Repeated step c and d with the every 10 degrees reduction until the lowest temperature achieved.
- The test chamber was allowed to stabilize at +20 degree C for a minimum of 30 minutes. The supply voltage was then adjusted on the EUT from 85 % to 115 % and the frequency record.

4.3.5 Deviation from Test Standard

No deviation.

4.3.6 EUT Operating Conditions

- Placed the EUT on the testing table.
- Set the EUT under transmission condition continuously at specific channel frequency.

4.3.7 Test Results

Frequency Stability Versus Temperature									
Temp. (°C)	Power Supply (Vac)	0 Minute		2 Minute		5 Minute		10 Minute	
		Measured Frequency	Frequency Drift	Measured Frequency	Frequency Drift	Measured Frequency	Frequency Drift	Measured Frequency	Frequency Drift
		(MHz)	%	(MHz)	%	(MHz)	%	(MHz)	%
50	110	13.56006	0.00044	13.56007	0.00052	13.56006	0.00044	13.56007	0.00052
40	110	13.55998	-0.00015	13.55998	-0.00015	13.55999	-0.00007	13.55998	-0.00015
30	110	13.56004	0.00029	13.56003	0.00022	13.56004	0.00029	13.56004	0.00029
20	110	13.56003	0.00022	13.56003	0.00022	13.56004	0.00029	13.56003	0.00022
10	110	13.55996	-0.00029	13.55996	-0.00029	13.55995	-0.00037	13.55996	-0.00029
0	110	13.55995	-0.00037	13.55995	-0.00037	13.55995	-0.00037	13.55995	-0.00037
-10	110	13.56003	0.00022	13.56002	0.00015	13.56002	0.00015	13.56003	0.00022
-20	110	13.56006	0.00044	13.56007	0.00052	13.56006	0.00044	13.56006	0.00044

Frequency Stability Versus Voltage									
Temp. (°C)	Power Supply (Vac)	0 Minute		2 Minute		5 Minute		10 Minute	
		Measured Frequency	Frequency Drift	Measured Frequency	Frequency Drift	Measured Frequency	Frequency Drift	Measured Frequency	Frequency Drift
		(MHz)	%	(MHz)	%	(MHz)	%	(MHz)	%
20	126.5	13.56003	0.00022	13.56003	0.00022	13.56004	0.00029	13.56003	0.00022
	110	13.56003	0.00022	13.56003	0.00022	13.56004	0.00029	13.56003	0.00022
	93.5	13.56003	0.00022	13.56003	0.00022	13.56004	0.00029	13.56003	0.00022

4.4 20 dB Bandwidth

4.4.1 Limits of 20 dB Bandwidth Measurement

The 20 dB bandwidth shall be specified in operating frequency band.

4.4.2 Test Setup

Refer to section 4.1.5.

4.4.3 Test Instruments

Refer to section 4.1.2 to get information of above instrument.

4.4.4 Test Procedures

The bandwidth of the fundamental frequency was measured by spectrum analyzer with 1 kHz RBW and 3 kHz VBW. The 20 dB bandwidth is defined as the total spectrum the power of which is higher than peak power minus 20 dB.

4.4.5 Deviation from Test Standard

No deviation.

4.4.6 EUT Operating Conditions

- a. Placed the EUT on the testing table.
- b. Set the EUT under transmission condition continuously at specific channel frequency.

4.4.7 Test Results

Operating Frequency Band (MHz)	20dBc Bandwidth (kHz)
13.553~13.567	2.8310

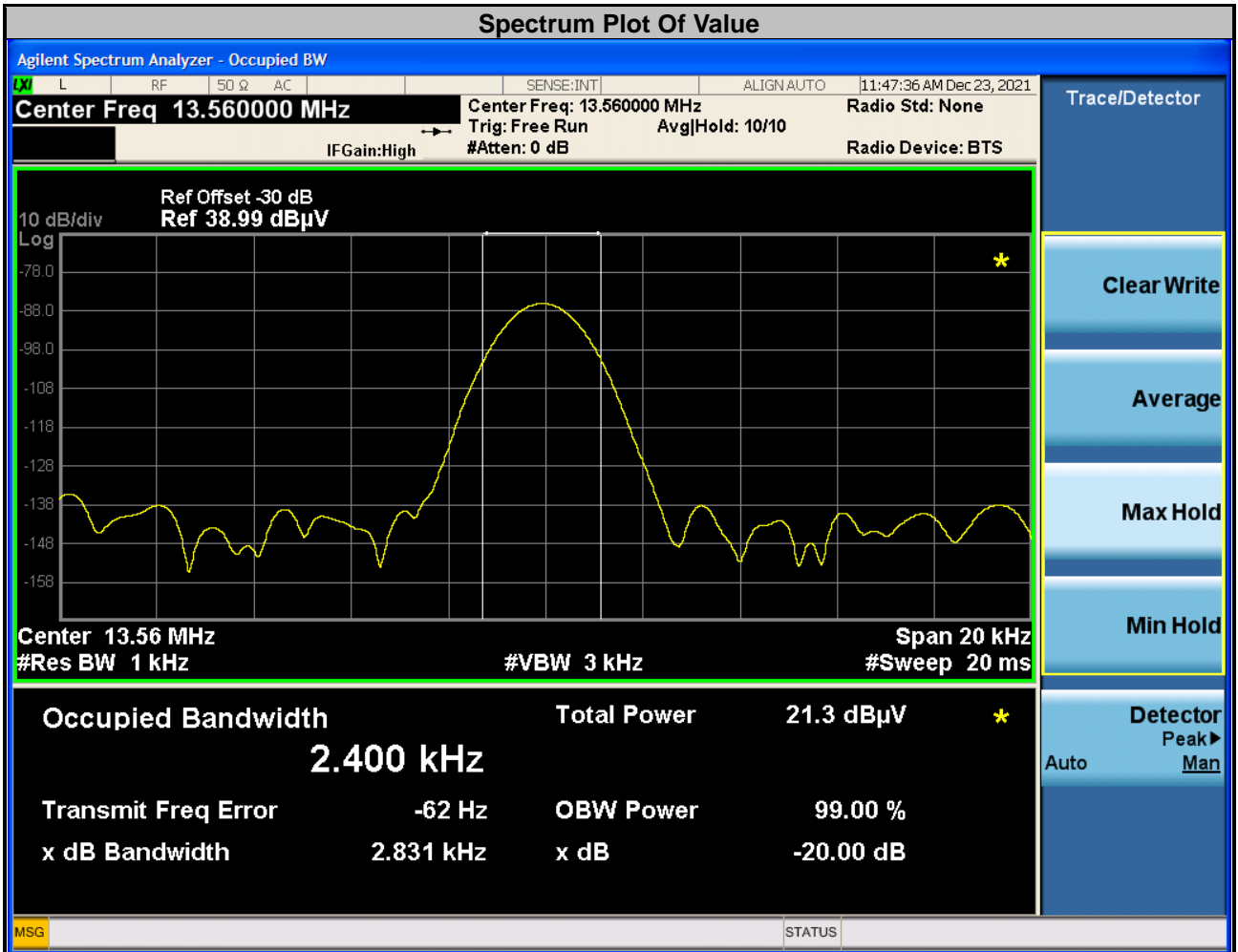

Note: The signal look like CW signal, so RBW can't be match 1~5 % OBW.

5 Pictures of Test Arrangements

Please refer to the attached file (Test Setup Photo).

Appendix – Information of the Testing Laboratories

We, Bureau Veritas Consumer Products Services (H.K.) Ltd., Taoyuan Branch, were founded in 1988 to provide our best service in EMC, Radio, Telecom and Safety consultation. Our laboratories are FCC recognized accredited test firms and accredited according to ISO/IEC 17025.

If you have any comments, please feel free to contact us at the following:

Lin Kou EMC/RF Lab

Tel: 886-2-26052180

Fax: 886-2-26051924

Hsin Chu EMC/RF/Telecom Lab

Tel: 886-3-6668565

Fax: 886-3-6668323

Hwa Ya EMC/RF/Safety Lab

Tel: 886-3-3183232

Fax: 886-3-3270892

Email: service.adt@tw.bureauveritas.com

Web Site: www.bureauveritas-adt.com

The address and road map of all our labs can be found in our web site also.

--- END ---