

## FCC Test Report

**Report No.:** RF191112C03

**FCC ID:** E2K-DWRFID1901

**Test Model:** DWRFID1901

**Received Date:** Nov. 12, 2019

**Test Date:** Nov. 18, 2019 ~ Dec. 16, 2019

**Issued Date:** Dec. 17, 2019

**Applicant:** Dell Inc.

**Address:** One Dell Way, Round Rock, Texas 78682, USA

**Issued By:** Bureau Veritas Consumer Products Services (H.K.) Ltd., Taoyuan Branch  
Lin Kou Laboratories

**Lab Address:** No. 47-2, 14th Ling, Chia Pau Vil., Lin Kou Dist., New Taipei City, Taiwan

**Test Location:** No.19, Hwa Ya 2nd Rd., Wen Hwa Vil., Kwei Shan Dist., Taoyuan City  
33383, Taiwan

**FCC Registration /** 788550 / TW0003

**Designation Number:**



This report is for your exclusive use. Any copying or replication of this report to or for any other person or entity, or use of our name or trademark, is permitted only with our prior written permission. This report sets forth our findings solely with respect to the test samples identified herein. The results set forth in this report are not indicative or representative of the quality or characteristics of the lot from which a test sample was taken or any similar or identical product unless specifically and expressly noted. Our report includes all of the tests requested by you and the results thereof based upon the information that you provided to us. You have 60 days from date of issuance of this report to notify us of any material error or omission caused by our negligence, provided, however, that such notice shall be in writing and shall specifically address the issue you wish to raise. A failure to raise such issue within the prescribed time shall constitute your unqualified acceptance of the completeness of this report, the tests conducted and the correctness of the report contents. Unless specific mention, the uncertainty of measurement has been explicitly taken into account to declare the compliance or non-compliance to the specification. The report must not be used by the client to claim product certification, approval, or endorsement by TAF or any government agencies.

## Table of Contents

<b>Release Control Record .....</b>	<b>3</b>
<b>1 Certificate of Conformity .....</b>	<b>4</b>
<b>2 Summary of Test Results.....</b>	<b>5</b>
2.1 Measurement Uncertainty.....	5
2.2 Modification Record .....	5
<b>3 General Information .....</b>	<b>6</b>
3.1 General Description of EUT .....	6
3.2 Description of Test Modes.....	8
3.2.1 Test Mode Applicability and Tested Channel Detail.....	8
3.3 Description of Support Units .....	10
3.3.1 Configuration of System under Test .....	10
3.4 General Description of Applied Standards and references.....	10
<b>4 Test Types and Results .....</b>	<b>11</b>
4.1 Radiated Emission Measurement.....	11
4.1.1 Limits of Radiated Emission Measurement .....	11
4.1.2 Test Instruments .....	12
4.1.3 Test Procedures.....	13
4.1.4 Deviation from Test Standard .....	13
4.1.5 Test Set Up .....	14
4.1.6 EUT Operating Conditions.....	14
4.1.7 Test Results .....	15
4.2 Conducted Emission Measurement.....	63
4.2.1 Limits of Conducted Emission Measurement .....	63
4.2.2 Test Instruments .....	63
4.2.3 Test Procedures.....	64
4.2.4 Deviation from Test Standard .....	64
4.2.5 Test Setup.....	64
4.2.6 EUT Operating Conditions.....	64
4.2.7 Test Results .....	65
4.3 Frequency Stability .....	77
4.3.1 Limits of Frequency Stability Measurement .....	77
4.3.2 Test Setup.....	77
4.3.3 Test Instruments .....	77
4.3.4 Test Procedure .....	77
4.3.5 Deviation from Test Standard .....	77
4.3.6 EUT Operating Conditions.....	77
4.3.7 Test Results .....	78
4.4 20 dB Bandwidth.....	80
4.4.1 Limits of 20 dB Bandwidth Measurement.....	80
4.4.2 Test Setup.....	80
4.4.3 Test Instruments .....	80
4.4.4 Test Procedures.....	80
4.4.5 Deviation from Test Standard .....	80
4.4.6 EUT Operating Conditions.....	80
4.4.7 Test Results .....	81
<b>5 Pictures of Test Arrangements.....</b>	<b>87</b>
<b>Appendix – Information of the Testing Laboratories .....</b>	<b>88</b>

### Release Control Record

Issue No.	Description	Date Issued
RF191112C03	Original Release	Dec. 17, 2019

## 1 Certificate of Conformity

**Product:** RFID 13.56MHz Wireless Module

**Brand:** DELL

**Test Model:** DWRFID1901

**Sample Status:** Production Unit

**Applicant:** Dell Inc.

**Test Date:** Nov. 18, 2019 ~ Dec. 16, 2019

**Standards:** 47 CFR FCC Part 15, Subpart C (Section 15.225)

47 CFR FCC Part 15, Subpart C (Section 15.215)

ANSI C63.10:2013

The above equipment has been tested by **Bureau Veritas Consumer Products Services (H.K.) Ltd., Taoyuan Branch**, and found compliance with the requirement of the above standards. The test record, data evaluation & Equipment Under Test (EUT) configurations represented herein are true and accurate accounts of the measurements of the sample's RF characteristics under the conditions specified in this report.

**Prepared by :** Shelly Hsueh, **Date:** Dec. 17, 2019  
Shelly Hsueh / Specialist

**Approved by :** Dylan Chiou, **Date:** Dec. 17, 2019  
Dylan Chiou / Project Engineer

## 2 Summary of Test Results

47 CFR FCC Part 15, Subpart C (Section 15.225, 15.215)			
FCC Clause	Test Item	Result	Remarks
15.207	Conducted emission test	Pass	Meet the requirement of limit. Minimum passing margin is -9.77 dB at 13.56 MHz.
15.225 (a)	The field strength of any emissions within the band 13.553-13.567 MHz	Pass	Meet the requirement of limit. Minimum passing margin is -77.5 dB at 13.56 MHz.
15.225 (b)	The field strength of any emissions within the bands 13.410-13.553 MHz and 13.567-13.710 MHz	Pass	Meet the requirement of limit.
15.225 (c)	The field strength of any emissions within the bands 13.110-13.410 MHz and 13.710-14.010 MHz	Pass	Meet the requirement of limit.
15.225 (d)	The field strength of any emissions appearing outside of the 13.110-14.010 MHz band	Pass	Meet the requirement of limit. Minimum passing margin is -6.2 dB at 148.35 MHz.
15.225 (e)	The frequency tolerance	Pass	Meet the requirement of limit.
15.215 (c)	20 dB Bandwidth	Pass	Meet the requirement of limit.

Note: Determining compliance based on the results of the compliance measurement, not taking into account measurement instrumentation uncertainty.

### 2.1 Measurement Uncertainty

Where relevant, the following measurement uncertainty levels have been estimated for tests performed on the EUT as specified in CISPR 16-4-2:

Measurement	Frequency	Expanded Uncertainty (k=2) ( $\pm$ )
Conducted Emissions at mains ports	150 kHz ~ 30 MHz	2.79 dB
Radiated Emissions up to 1 GHz	9 kHz ~ 30 MHz	3.04 dB
	30 MHz ~ 200 MHz	2.93 dB
	200 MHz ~ 1000 MHz	2.95 dB

### 2.2 Modification Record

There were no modifications required for compliance.

### 3 General Information

#### 3.1 General Description of EUT

<b>Product</b>	RFID 13.56MHz Wireless Module
<b>Brand</b>	DELL
<b>Test Model</b>	DWRFID1901
<b>Status of EUT</b>	Production Unit
<b>Power Supply Rating</b>	3.3 Vdc (host equipment)
<b>Modulation Type</b>	ASK
<b>Data Rate</b>	Type A: 106 kbit/s Type B: 106 kbit/s Type F: 212 kbit/s, 424 kbit/s
<b>Operating Frequency</b>	13.56 MHz
<b>Field Strength (Maximum)</b>	Hong-Bo Loop Antenna : Type A:42.5 dB $\mu$ V/m (3m) Type B:40.7 dB $\mu$ V/m (3m) Type F:40.5 dB $\mu$ V/m (3m) Speedwire Loop Antenna : Type A:46.5 dB $\mu$ V/m (3m) Type B:44.5 dB $\mu$ V/m (3m) Type F:42.5 dB $\mu$ V/m (3m)
<b>Antenna Type</b>	Refer to Note as below
<b>Accessory Device</b>	Refer to Note as below
<b>Data Cable Supplied</b>	NA

Note:

- The EUT is authorized for use in specific End-product. Please refer to below table for further details.

Product Name	Model	Hinge
Portable Computer	P94F	Olympic 180
Portable Computer	P95F	Olympic 360

\*The NFC circuit and antenna behind the palm rest of P94F and P95F is the same, the difference is only the hinge of display, the display of P94F is only used straight or bended and can't be rotated by 360 degree, P95F can be rotated by 360 degree. After pre-testing, the model P94F was the worst case for final tests.

\*The RFID with passive tag is worst mode as final test..

- The antenna information is listed as below.

Antenna Manufacturer	Antenna Model No.	Antenna Type	Antenna Gain (dBi)	Note
Hong-Bo	260-24278 (DC33002CQ0L)	Loop Antenna	N/A	Main source
Speedwire	F.0W.FH-6110-001-00 (DC33002E40L)	Loop Antenna	N/A	2nd source

3. The EUT contains following accessory devices.

Product	Brand	Model	Description
Adapter	DELL	LA65NM170	I/P : 100-240 Vac, 50/60 Hz, 1.7 A O/P : 20Vdc, 3.25A or 15Vdc, 3A or 9Vdc, 3A or 5Vdc, 3A 0.85 meter
Battery	DELL	N7HT0	7.6 Vdc, 52 mAh

4. The above EUT information is declared by manufacturer and for more detailed features description, please refers to the manufacturer's specifications or user's manual.

### 3.2 Description of Test Modes

One channel was provided to this EUT:

Channel	Frequency (MHz)
1	13.56

#### 3.2.1 Test Mode Applicability and Tested Channel Detail

EUT Configure Mode	Applicable To				Description
	RE	PLC	FS	EB	
A	√	√	√	√	EUT with Hong Bo Ant
B	√	√	√	√	EUT with Speedwire Ant

Where **RE:** Radiated Emission **PLC:** Power Line Conducted Emission  
**FS:** Frequency Stability **EB:** 20 dB Bandwidth measurement

#### **Radiated Emission Test:**

- Pre-Scan has been conducted to determine the worst-case mode from all possible combinations between available modulations, data rates and antenna ports (if EUT with antenna diversity architecture).
- Following channel(s) was (were) selected for the final test as listed below.

EUT Configure Mode	Available Channel	Tested Channel	Modulation Type	Axis
A, B	1	1	ASK	Z

#### **Power Line Conducted Emission Test:**

- Pre-Scan has been conducted to determine the worst-case mode from all possible combinations between available modulations, data rates and antenna ports (if EUT with antenna diversity architecture).
- Following channel(s) was (were) selected for the final test as listed below.

EUT Configure Mode	Available Channel	Tested Channel	Modulation Type	Axis
A, B	1	1	ASK	Z

#### **Frequency Stability:**

- This item includes all test value of each mode, but only includes spectrum plot of worst value of each mode.
- Pre-Scan has been conducted to determine the worst-case mode from all possible combinations between available modulations, data rates and antenna ports (if EUT with antenna diversity architecture).
- Following channel(s) was (were) selected for the final test as listed below.

EUT Configure Mode	Available Channel	Tested Channel	Modulation Type	Axis
A, B	1	1	ASK	Z



**20 dB Bandwidth:**

- This item includes all test value of each mode, but only includes spectrum plot of worst value of each mode.
- Pre-Scan has been conducted to determine the worst-case mode from all possible combinations between available modulations, data rates and antenna ports (if EUT with antenna diversity architecture).
- Following channel(s) was (were) selected for the final test as listed below.

EUT Configure Mode	Available Channel	Tested Channel	Modulation Type	Axis
A, B	1	1	ASK	Z

**Test Condition:**

Applicable To	Environmental Conditions	Input Power	Tested By
RE	25 deg. C, 65 % RH	120 Vac, 60 Hz	TitanHSU
FS	25 deg. C, 65 % RH	120 Vac, 60 Hz	TitanHSU
PLC	25 deg. C, 65 % RH	120 Vac, 60 Hz	TitanHSU
EB	25 deg. C, 68 % RH	120 Vac, 60 Hz	TitanHSU

### 3.3 Description of Support Units

The EUT has been tested as an independent unit together with other necessary accessories or support units. The following support units or accessories were used to form a representative test configuration during the tests.

ID	Product	Brand	Model No.	Serial No.	FCC ID	Remarks
1.	Portable Computer	DELL	P94F, P95F	N/A	E2K-DWRFID1901	-

#### 3.3.1 Configuration of System under Test

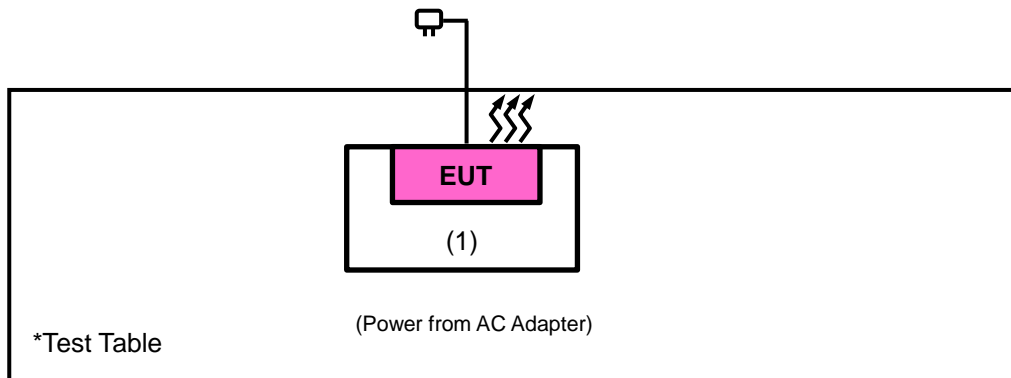

### 3.4 General Description of Applied Standards and references

The EUT is a RF Product. According to the specifications of the manufacturer, it must comply with the requirements of the following standards and references:

**FCC Part 15, Subpart C (15.225)**

**FCC Part 15, Subpart C (15.215)**

ANSI C63.10-2013

All test items have been performed and recorded as per the above standards.

**References Test Guidance :**

**KDB 414788 D01 Radiated Test Site v01r01**

All test items have been performed as a reference to the above KDB test guidance.

## 4 Test Types and Results

### 4.1 Radiated Emission Measurement

#### 4.1.1 Limits of Radiated Emission Measurement

- a. The field strength of any emissions within the band 13.553-13.567 MHz shall not exceed 15,848 microvolts/meter at 30 meters.
- b. Within the bands 13.410-13.553 MHz and 13.567-13.710 MHz, the field strength of any emissions shall not exceed 334 microvolts/meter at 30 meters.
- c. Within the bands 13.110-13.410 MHz and 13.710-14.010 MHz the field strength of any emissions shall not exceed 106 microvolts/meter at 30 meters.
- d. The field strength of any emissions appearing outside of the 13.110-14.010 MHz band shall not exceed the general radiated emission limits in §15.209 as below table:

Frequencies (MHz)	Field Strength (microvolts/meter)	Measurement Distance (meters)
0.009 ~ 0.490	2400/F (kHz)	300
0.490 ~ 1.705	24000/F (kHz)	30
1.705 ~ 30.0	30	30
30 ~ 88	100	3
88 ~ 216	150	3
216 ~ 960	200	3
Above 960	500	3

**NOTE:**

1. The lower limit shall apply at the transition frequencies.
2. Emission level (dBuV/m) = 20 log Emission level (uV/m).
3. For frequencies above 1000 MHz, the field strength limits are based on average detector, however, the peak field strength of any emission shall not exceed the maximum permitted average limits, specified above by more than 20 dB under any condition of modulation.

#### 4.1.2 Test Instruments

Description & Manufacturer	Model No.	Serial No.	Calibrated Date	Calibrated Until
Test Receiver ROHDE & SCHWARZ	ESIB7	100187	May 30, 2019	May 29, 2020
Spectrum Analyzer ROHDE & SCHWARZ	FSP40	100269	Jun.10, 2019	Jun.09, 2020
BILOG Antenna SCHWARZBECK	VULB9168	9168-171	Nov. 11, 2019	Nov. 10, 2020
Loop Antenna TESEQ	HLA 6121	45745	Jul. 01, 2019	Jun. 30, 2020
Preamplifier Agilent (Below 1GHz)	8447D	2944A10738	Aug. 20, 2019	Aug. 19, 2020
RF Coaxial Cable WOKEN With 5dB PAD	8D-FB	Cable-CH3-01	Aug. 20, 2019	Aug. 19, 2020
Software BV ADT	ADT_Radiated_ V7.6.15.9.5	NA	NA	NA
Antenna Tower inn-co GmbH	MA 4000	013303	NA	NA
Antenna Tower Controller BV ADT	AT100	AT93021702	NA	NA
Turn Table BV ADT	TT100	TT93021702	NA	NA
Turn Table Controller BV ADT	SC100	SC93021702	NA	NA
Boresight Antenna Fixture	FBA-01	FBA-SIP01	NA	NA
Temperature & Humidity Chamber	HRM-120RF	931022	Jan. 11, 2019	Jan. 10, 2020
AC Power Source	6905S	1991553	NA	NA

Note: 1. The calibration interval of the above test instruments is 12 months and the calibrations are traceable to NML/ROC and NIST/USA.  
 2. The test was performed in HwaYa Chamber 2.

#### 4.1.3 Test Procedures

##### **For Radiated Emission below 30 MHz**

- a. The EUT was placed on the top of a rotating table 0.8 meters above the ground at a 3 meter chamber room. The table was rotated 360 degrees to determine the position of the highest radiation.
- b. The EUT was set 3 meters away from the interference-receiving antenna, which was mounted on the top of a variable-height antenna tower.
- c. Parallel, perpendicular, and ground-parallel orientations of the antenna are set to make the measurement.
- d. For each suspected emission, the EUT was arranged to its worst case and the rotatable table was turned from 0 degrees to 360 degrees to find the maximum reading.
- e. The test-receiver system was set to Quasi-Peak Detect Function and Specified Bandwidth with Maximum Hold Mode.

##### **Note:**

1. The resolution bandwidth and video bandwidth of test receiver/spectrum analyzer is 9 kHz at frequency below 30 MHz.
2. There is a comparison data of both open-field test site and semi-Anechoic chamber, and the result came out very similar.

##### **For Radiated Emission above 30 MHz**

- a. The EUT was placed on the top of a rotating table 0.8 meters above the ground at 3 meter chamber room for test. The table was rotated 360 degrees to determine the position of the highest radiation.
- b. The EUT was set 3 meters away from the interference-receiving antenna, which was mounted on the top of a variable-height antenna tower.
- c. The height of antenna is varied from one meter to four meters above the ground to determine the maximum value of the field strength. Both horizontal and vertical polarizations of the antenna are set to make the measurement.
- d. For each suspected emission, the EUT was arranged to its worst case and then the antenna was tuned to heights from 1 meter to 4 meters and the rotatable table was turned from 0 degrees to 360 degrees to find the maximum reading.
- e. The test-receiver system was set to quasi-peak detect function and specified bandwidth with maximum hold mode when the test frequency is below 1 GHz.
- f. The test-receiver system was set to peak and average detected function and specified bandwidth with maximum hold mode when the test frequency is above 1 GHz. If the peak reading value also meets average limit, measurement with the average detector is unnecessary.

##### **Note:**

1. The resolution bandwidth and video bandwidth of test receiver/spectrum analyzer is 120 kHz for Quasi-peak detection (QP) or Peak detection (PK) at frequency below 1 GHz.
2. The resolution bandwidth of test receiver/spectrum analyzer is 1 MHz and the video bandwidth is 3 MHz for Peak detection (PK) at frequency above 1 GHz.
3. The resolution bandwidth of test receiver/spectrum analyzer is 1 MHz and the video bandwidth is  $\geq 1/T$  (Duty cycle  $< 98\%$ ) or 10 Hz (Duty cycle  $\geq 98\%$ ) for Average detection (AV) at frequency above 1 GHz.
4. All modes of operation were investigated and the worst-case emissions are reported.

#### 4.1.4 Deviation from Test Standard

No deviation.

#### 4.1.5 Test Set Up

##### <Radiated Emission below 30 MHz>

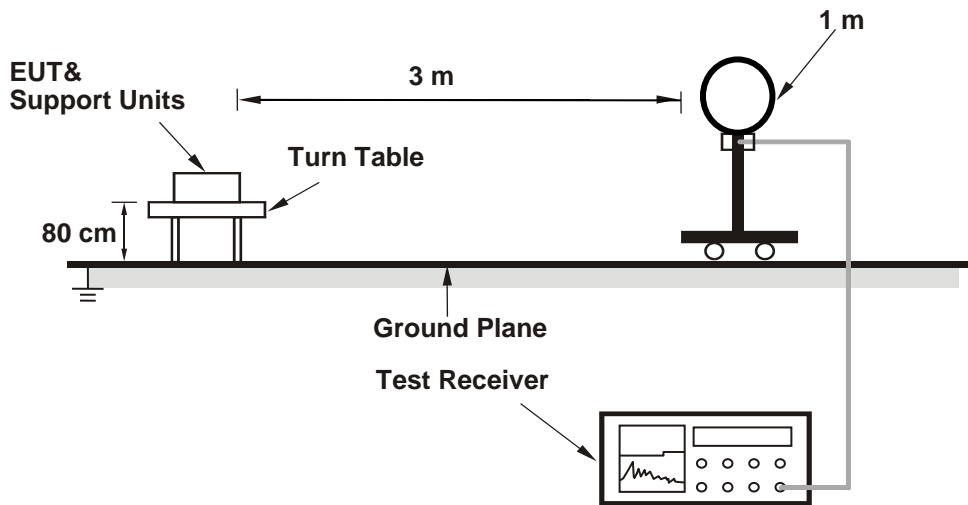

##### <Radiated Emission 30 MHz to 1 GHz>

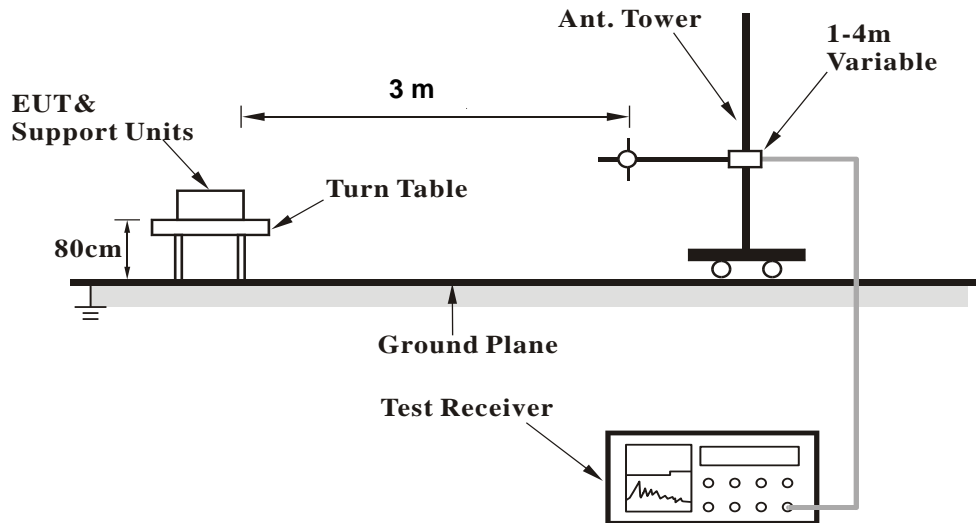

For the actual test configuration, please refer to the attached file (Test Setup Photo).

#### KDB 414788 OFS and Chamber Correlation Justification

- Base on FCC 15.31 (f) (2): measurements may be performed at a distance closer than that specified in the regulations; however, an attempt should be made to avoid making measurements in the near field.
- Open-field site and chamber correlation testing had been performed and chamber measured test result is the worst case test result.

#### 4.1.6 EUT Operating Conditions

- a. Placed the EUT on the testing table.
- b. Set the EUT under transmission condition continuously at specific channel frequency.

4.1.7 Test Results

Mode A  
Type A

EUT Test Condition		Measurement Detail	
Channel	Channel 1	Frequency Range	13.553 ~ 13.567 MHz
Input Power	120 Vac, 60 Hz	Detector Function	Quasi-Peak
Environmental Conditions	23 deg. C, 66 % RH	Tested By	TitanHSU

Antenna Polarity & Test Distance: Loop Antenna Parallel at 3 m								
NO.	Freq. (MHz)	Emission Level (dBuV/m)	Limit (dBuV/m)	Margin (dB)	Antenna Height (m)	Table Angle (Degree)	Raw Value (dBuV)	Correction Factor (dB/m)
1	*13.56	42.5 QP	124 QP	-81.5	1.00 V	263	20.7	21.8

Remarks:

1. Emission level (dBuV/m) = Raw Value (dBuV) + Factor (dB/m)
2. Correction Factor(dB/m) = Antenna Factor(dB/m) + Cable Factor(dB) – Pre-Amplifier Factor(dB)
3. The other emission levels were very low against the limit.
4. Margin value = Emission level – Limit value.
5. Above limits have been translated by the formula

The measured field strength was extrapolated to distance 30 meters, using the formula that the limit of field strength varies as the inverse distance square (40dB per decade of distance)

Example:

$$\begin{aligned}
 13.56 \text{ MHz} &= 15848 \text{ uV/m} && 30\text{m} \\
 &= 84 \text{ dBuV/m} && 30\text{m} \\
 &= 84+20\log(30/3)^2 && 3\text{m} \\
 &= 124 \text{ dBuV/m}
 \end{aligned}$$

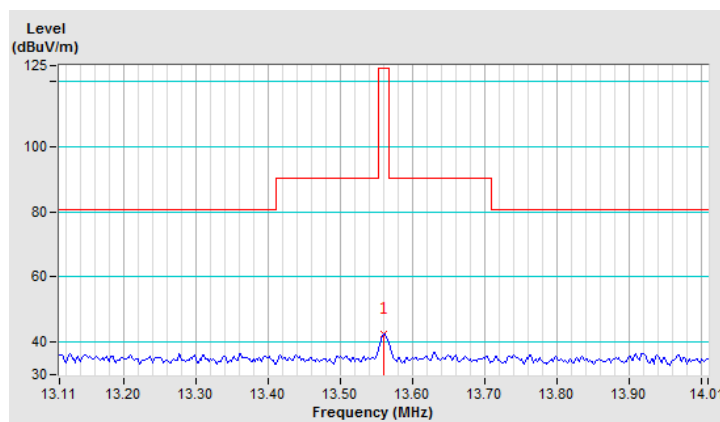

Antenna Polarity & Test Distance: Loop Antenna Parallel at 30 m				
NO.	Frequency (MHz)	Emission Level (dBuV/m)	Limit (dBuV/m)	Margin (dB)
1	*13.56	2.5 QP	84 QP	-81.5

Remarks: Emission Level at 30m = Emission Level at 3m + 20log(3/30)<sup>2</sup>

EUT Test Condition		Measurement Detail	
Channel	Channel 1	Frequency Range	13.553 ~ 13.567 MHz
Input Power	120 Vac, 60 Hz	Detector Function	Quasi-Peak
Environmental Conditions	23 deg. C, 66 % RH	Tested By	TitanHSU

Antenna Polarity & Test Distance: Loop Antenna Perpendicular at 3 m								
NO.	Freq. (MHz)	Emission Level (dBuV/m)	Limit (dBuV/m)	Margin (dB)	Antenna Height (m)	Table Angle (Degree)	Raw Value (dBuV)	Correction Factor (dB/m)
1	*13.56	40.5 QP	124 QP	-83.5	1.00 V	319	18.7	21.8

Remarks:

1. Emission level (dBuV/m) = Raw Value (dBuV) + Factor (dB/m)
2. Correction Factor(dB/m) = Antenna Factor(dB/m) + Cable Factor(dB) – Pre-Amplifier Factor(dB)
3. The other emission levels were very low against the limit.
4. Margin value = Emission level – Limit value.
5. Above limits have been translated by the formula

The measured field strength was extrapolated to distance 30 meters, using the formula that the limit of field strength varies as the inverse distance square (40dB per decade of distance)

Example:

$$\begin{aligned}
 13.56 \text{ MHz} &= 15848 \text{ uV/m} && 30\text{m} \\
 &= 84 \text{ dBuV/m} && 30\text{m} \\
 &= 84 + 20\log(30/3)^2 && 3\text{m} \\
 &= 124 \text{ dBuV/m}
 \end{aligned}$$

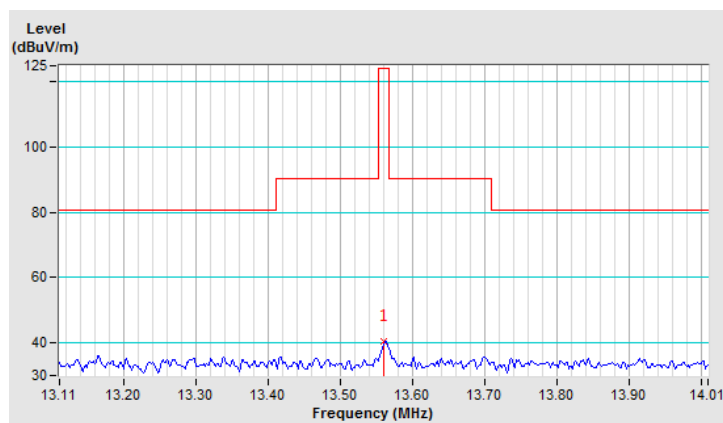

Antenna Polarity & Test Distance: Loop Antenna Perpendicular at 30 m				
NO.	Frequency (MHz)	Emission Level (dBuV/m)	Limit (dBuV/m)	Margin (dB)
1	*13.56	0.5 QP	84 QP	-83.5

Remarks: Emission Level at 30m = Emission Level at 3m + 20log(3/30)<sup>2</sup>



EUT Test Condition		Measurement Detail	
Channel	Channel 1	Frequency Range	13.553 ~ 13.567 MHz
Input Power	120 Vac, 60 Hz	Detector Function	Quasi-Peak
Environmental Conditions	23 deg. C, 66 % RH	Tested By	TitanHSU

Antenna Polarity & Test Distance: Loop Antenna Ground-Parallel Parallel at 3 m								
NO.	Freq. (MHz)	Emission Level (dBuV/m)	Limit (dBuV/m)	Margin (dB)	Antenna Height (m)	Table Angle (Degree)	Raw Value (dBuV)	Correction Factor (dB/m)
1	*13.56	40.1 QP	124 QP	-83.9	1.00 V	18	18.3	21.8

Remarks:

1. Emission level (dBuV/m) = Raw Value (dBuV) + Factor (dB/m)
2. Correction Factor(dB/m) = Antenna Factor(dB/m) + Cable Factor(dB) – Pre-Amplifier Factor(dB)
3. The other emission levels were very low against the limit.
4. Margin value = Emission level – Limit value.
5. Above limits have been translated by the formula

The measured field strength was extrapolated to distance 30 meters, using the formula that the limit of field strength varies as the inverse distance square (40dB per decade of distance)

Example:

$$\begin{aligned}
 13.56 \text{ MHz} &= 15848 \text{ uV/m} && 30\text{m} \\
 &= 84 \text{ dBuV/m} && 30\text{m} \\
 &= 84 + 20\log(30/3)^2 && 3\text{m} \\
 &= 124 \text{ dBuV/m}
 \end{aligned}$$

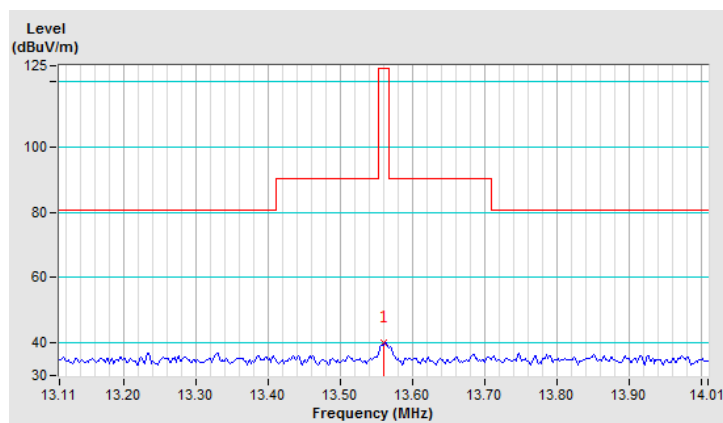

Antenna Polarity & Test Distance: Loop Antenna Ground-Parallel Parallel at 30 m				
NO.	Frequency (MHz)	Emission Level (dBuV/m)	Limit (dBuV/m)	Margin (dB)
1	*13.56	0.1 QP	84 QP	-83.9

Remarks: Emission Level at 30m = Emission Level at 3m + 20log(3/30)<sup>2</sup>

EUT Test Condition		Measurement Detail	
Channel	Channel 1	Frequency Range	Below 30 MHz
Input Power	120 Vac, 60 Hz	Detector Function	Quasi-Peak
Environmental Conditions	23 deg. C, 66 % RH	Tested By	TitanHSU

Antenna Polarity & Test Distance: Loop Antenna Parallel at 3 m								
NO.	Freq. (MHz)	Emission Level (dBuV/m)	Limit (dBuV/m)	Margin (dB)	Antenna Height (m)	Table Angle (Degree)	Raw Value (dBuV)	Correction Factor (dB/m)
1	3.55	41.6 QP	69.5	-27.9	1.00 V	69	21.6	20.0
2	5.23	37.6 QP	69.5	-31.9	1.00 V	52	17.4	20.2
3	9.13	36.5 QP	69.5	-33.0	1.00 V	318	15.1	21.4
4	12.07	37.1 QP	69.5	-32.4	1.00 V	279	15.3	21.8
5	21.06	38.1 QP	69.5	-31.4	1.00 V	279	16.0	22.1
6	24.60	37.6 QP	69.5	-31.9	1.00 V	10	15.5	22.1

Remarks:

1. Emission Level(dBuV/m) = Raw Value(dBuV) + Correction Factor(dB/m)
2. Correction Factor(dB/m) = Antenna Factor(dB/m) + Cable Factor(dB)
3. Margin value = Emission Level – Limit value
4. The other emission levels were very low against the limit.

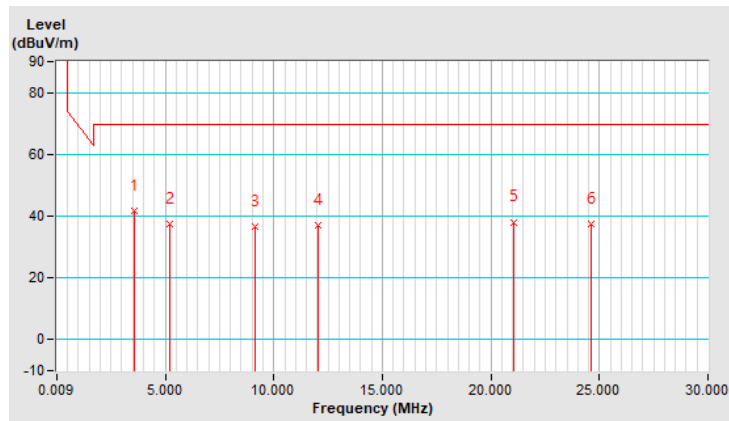

NO.	Frequency (MHz)	Emission Level (dBuV/m)	Limit (dBuV)	Margin
1	3.55	1.6	29.5	-27.9
2	5.23	-2.4	29.5	-31.9
3	9.13	-3.5	29.5	-33
4	12.07	-2.9	29.5	-32.4
5	21.06	-1.9	29.5	-31.4
6	24.06	-2.4	29.5	-31.9

EUT Test Condition		Measurement Detail	
Channel	Channel 1	Frequency Range	Below 30 MHz
Input Power	120 Vac, 60 Hz	Detector Function	Quasi-Peak
Environmental Conditions	23 deg. C, 66 % RH	Tested By	TitanHSU

Antenna Polarity & Test Distance: Loop Antenna Perpendicular at 3 m								
NO.	Freq. (MHz)	Emission Level (dBuV/m)	Limit (dBuV/m)	Margin (dB)	Antenna Height (m)	Table Angle (Degree)	Raw Value (dBuV)	Correction Factor (dB/m)
1	3.31	39.1 QP	69.5	-30.4	1.00 V	106	19.1	20.0
2	12.61	39.9 QP	69.5	-29.6	1.00 V	137	18.1	21.8
3	17.34	36.9 QP	69.5	-32.6	1.00 V	331	14.9	22.0
4	19.32	35.9 QP	69.5	-33.6	1.00 V	331	13.8	22.1
5	21.24	37.9 QP	69.5	-31.6	1.00 V	15	15.8	22.1
6	24.06	37.8 QP	69.5	-31.7	1.00 V	14	15.7	22.1

Remarks:

1. Emission Level(dBuV/m) = Raw Value(dBuV) + Correction Factor(dB/m)
2. Correction Factor(dB/m) = Antenna Factor(dB/m) + Cable Factor(dB) – Pre-Amplifier Factor(dB)
3. Margin value = Emission Level – Limit value
4. The other emission levels were very low against the limit.

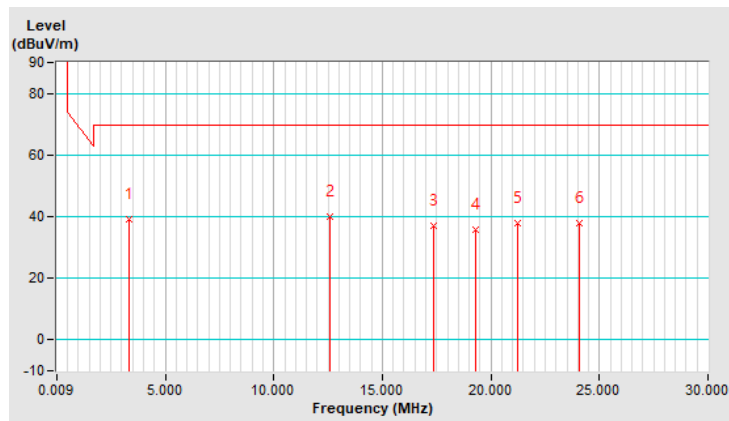

NO.	Frequency (MHz)	Emission Level (dBuV/m)	Limit (dBuV)	Margin
1	3.31	-0.9	29.5	-30.4
2	12.61	-0.1	29.5	-29.6
3	17.34	-3.1	29.5	-32.6
4	19.32	-4.1	29.5	-33.6
5	21.24	-2.1	29.5	-31.6
6	24.06	-2.2	29.5	-31.7

EUT Test Condition		Measurement Detail	
Channel	Channel 1	Frequency Range	Below 30 MHz
Input Power	120 Vac, 60 Hz	Detector Function	Quasi-Peak
Environmental Conditions	23 deg. C, 66 % RH	Tested By	TitanHSU

Antenna Polarity & Test Distance: Loop Antenna Ground-parallel at 3 m								
NO.	Freq. (MHz)	Emission Level (dBuV/m)	Limit (dBuV/m)	Margin (dB)	Antenna Height (m)	Table Angle (Degree)	Raw Value (dBuV)	Correction Factor (dB/m)
1	4.34	36.0 QP	69.5	-33.5	1.00 V	169	16.0	20.0
2	10.27	37.6 QP	69.5	-31.9	1.00 V	235	15.9	21.7
3	14.34	36.4 QP	69.5	-33.1	1.00 V	227	14.5	21.9
4	18.48	36.8 QP	69.5	-32.7	1.00 V	185	14.8	22.0
5	25.02	36.8 QP	69.5	-32.7	1.00 V	272	14.7	22.1
6	29.46	36.5 QP	69.5	-33.0	1.00 V	30	14.3	22.2

Remarks:

1. Emission Level(dBuV/m) = Raw Value(dBuV) + Correction Factor(dB/m)
2. Correction Factor(dB/m) = Antenna Factor(dB/m) + Cable Factor(dB) – Pre-Amplifier Factor(dB)
3. Margin value = Emission Level – Limit value
4. The other emission levels were very low against the limit.

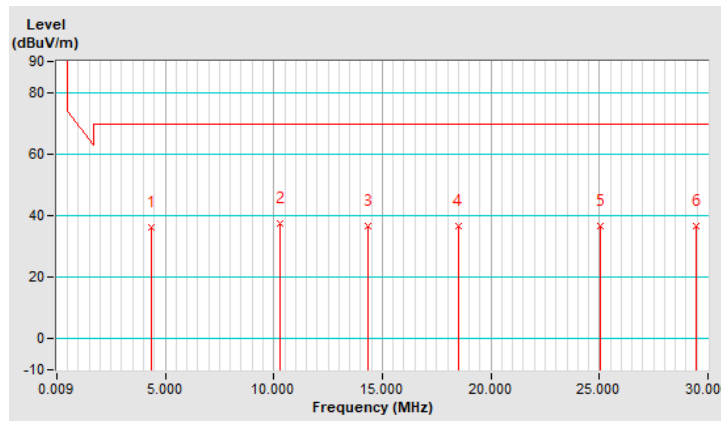

NO.	Frequency (MHz)	Emission Level (dBuV/m)	Limit (dBuV)	Margin
1	4.34	-4	29.5	-33.5
2	10.27	-2.4	29.5	-31.9
3	14.34	-3.6	29.5	-33.1
4	18.48	-1.4	29.5	-30.9
5	25.02	-3.2	29.5	-32.7
6	29.46	-3.5	29.5	-33

EUT Test Condition		Measurement Detail	
Channel	Channel 1	Frequency Range	Below 1000 MHz
Input Power	120 Vac, 60 Hz	Detector Function	Quasi-Peak or Peak
Environmental Conditions	23 deg. C, 66 % RH	Tested By	TitanHSU

Antenna Polarity & Test Distance: Horizontal at 3 m								
NO.	Freq. (MHz)	Emission Level (dBuV/m)	Limit (dBuV/m)	Margin (dB)	Antenna Height (m)	Table Angle (Degree)	Raw Value (dBuV)	Correction Factor (dB/m)
1	65.15	24.8 QP	40.0	-15.2	2.00 H	330	34.9	-10.1
2	84.83	25.2 QP	40.0	-14.8	2.00 H	343	39.0	-13.8
3	104.51	24.3 QP	43.5	-19.2	2.00 H	189	36.7	-12.4
4	150.91	22.6 QP	43.5	-20.9	1.49 H	222	31.3	-8.7
5	202.93	31.8 QP	43.5	-11.7	1.00 H	243	42.8	-11.0
6	714.69	36.6 QP	46.0	-9.4	1.49 H	197	34.5	2.1

Remarks:

1. Emission Level(dBuV/m) = Raw Value(dBuV) + Correction Factor(dB/m)
2. Correction Factor(dB/m) = Antenna Factor(dB/m) + Cable Factor(dB) – Pre-Amplifier Factor(dB)
3. Margin value = Emission Level – Limit value
4. The other emission levels were very low against the limit.

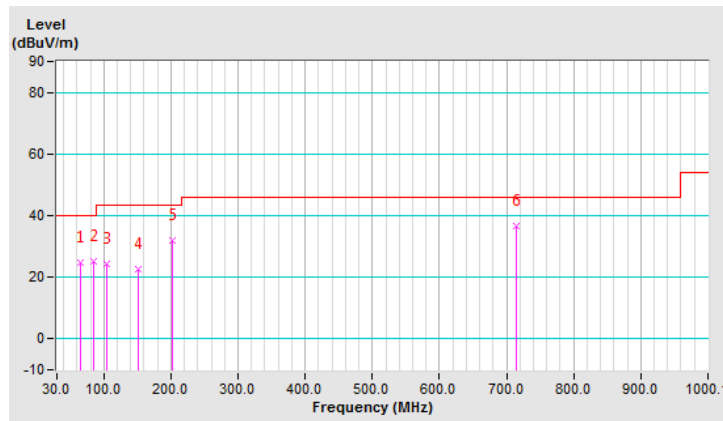

EUT Test Condition		Measurement Detail	
Channel	Channel 1	Frequency Range	Below 1000 MHz
Input Power	120 Vac, 60 Hz	Detector Function	Quasi-Peak or Peak
Environmental Conditions	23 deg. C, 66 % RH	Tested By	TitanHSU

Antenna Polarity & Test Distance: Vertical at 3 m								
NO.	Freq. (MHz)	Emission Level (dBuV/m)	Limit (dBuV/m)	Margin (dB)	Antenna Height (m)	Table Angle (Degree)	Raw Value (dBuV)	Correction Factor (dB/m)
1	49.68	26.1 QP	40.0	-13.9	1.01 V	356	35.1	-9.0
2	76.40	29.2 QP	40.0	-10.8	2.00 V	204	41.7	-12.5
3	104.51	28.9 QP	43.5	-14.6	1.01 V	89	41.3	-12.4
4	131.23	27.9 QP	43.5	-15.6	1.01 V	16	37.9	-10.0
5	204.34	26.3 QP	43.5	-17.2	1.01 V	121	37.2	-10.9
6	617.68	36.9 QP	46.0	-9.1	1.01 V	110	35.6	1.3

Remarks:

1. Emission Level(dBuV/m) = Raw Value(dBuV) + Correction Factor(dB/m)
2. Correction Factor(dB/m) = Antenna Factor(dB/m) + Cable Factor(dB) – Pre-Amplifier Factor(dB)
3. Margin value = Emission Level – Limit value
4. The other emission levels were very low against the limit.

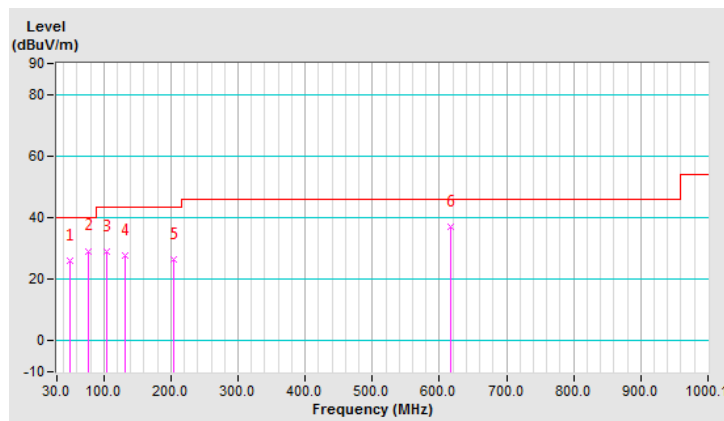

**Type B**

EUT Test Condition		Measurement Detail	
Channel	Channel 1	Frequency Range	13.553 ~ 13.567 MHz
Input Power	120 Vac, 60 Hz	Detector Function	Quasi-Peak
Environmental Conditions	23 deg. C, 66 % RH	Tested By	TitanHSU

Antenna Polarity & Test Distance: Loop Antenna Parallel at 3 m								
NO.	Freq. (MHz)	Emission Level (dBuV/m)	Limit (dBuV/m)	Margin (dB)	Antenna Height (m)	Table Angle (Degree)	Raw Value (dBuV)	Correction Factor (dB/m)
1	*13.56	40.7 QP	124 QP	-83.3	1.00 V	258	18.9	21.8

Remarks:

1. Emission level (dBuV/m) = Raw Value (dBuV) + Factor (dB/m)
2. Correction Factor(dB/m) = Antenna Factor(dB/m) + Cable Factor(dB) – Pre-Amplifier Factor(dB)
3. The other emission levels were very low against the limit.
4. Margin value = Emission level – Limit value.
5. Above limits have been translated by the formula

The measured field strength was extrapolated to distance 30 meters, using the formula that the limit of field strength varies as the inverse distance square (40dB per decade of distance)

Example:

$$\begin{aligned}
 13.56 \text{ MHz} &= 15848 \text{ uV/m} && 30\text{m} \\
 &= 84 \text{ dBuV/m} && 30\text{m} \\
 &= 84+20\log(30/3)^2 && 3\text{m} \\
 &= 124 \text{ dBuV/m}
 \end{aligned}$$

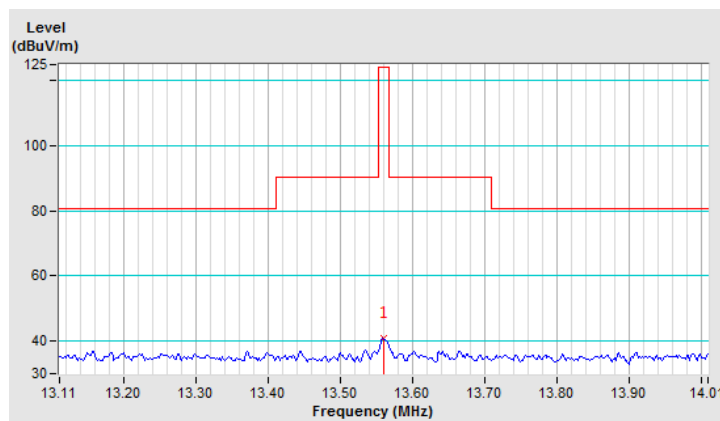

Antenna Polarity & Test Distance: Loop Antenna Parallel at 30 m				
NO.	Frequency (MHz)	Emission Level (dBuV/m)	Limit (dBuV/m)	Margin (dB)
1	*13.56	0.7 QP	84 QP	-83.3

Remarks: Emission Level at 30m = Emission Level at 3m + 20log(3/30)<sup>2</sup>

EUT Test Condition		Measurement Detail	
Channel	Channel 1	Frequency Range	13.553 ~ 13.567 MHz
Input Power	120 Vac, 60 Hz	Detector Function	Quasi-Peak
Environmental Conditions	23 deg. C, 66 % RH	Tested By	TitanHSU

Antenna Polarity & Test Distance: Loop Antenna Perpendicular at 3 m								
NO.	Freq. (MHz)	Emission Level (dBuV/m)	Limit (dBuV/m)	Margin (dB)	Antenna Height (m)	Table Angle (Degree)	Raw Value (dBuV)	Correction Factor (dB/m)
1	*13.56	39.5 QP	124 QP	-84.5	1.00 V	322	17.7	21.8

Remarks:

1. Emission level (dBuV/m) = Raw Value (dBuV) + Factor (dB/m)
2. Correction Factor(dB/m) = Antenna Factor(dB/m) + Cable Factor(dB) – Pre-Amplifier Factor(dB)
3. The other emission levels were very low against the limit.
4. Margin value = Emission level – Limit value.
5. Above limits have been translated by the formula

The measured field strength was extrapolated to distance 30 meters, using the formula that the limit of field strength varies as the inverse distance square (40dB per decade of distance)

Example:

$$\begin{aligned}
 13.56 \text{ MHz} &= 15848 \text{ uV/m} && 30\text{m} \\
 &= 84 \text{ dBuV/m} && 30\text{m} \\
 &= 84 + 20\log(30/3)^2 && 3\text{m} \\
 &= 124 \text{ dBuV/m}
 \end{aligned}$$

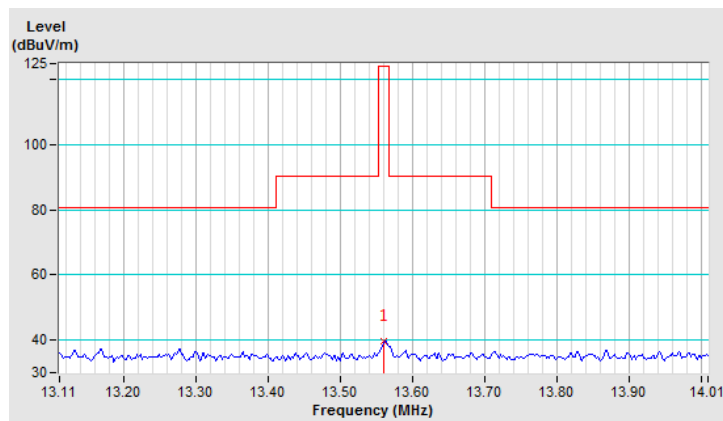

Antenna Polarity & Test Distance: Loop Antenna Perpendicular at 30 m				
NO.	Frequency (MHz)	Emission Level (dBuV/m)	Limit (dBuV/m)	Margin (dB)
1	*13.56	-0.5 QP	84 QP	-84.5

Remarks: Emission Level at 30m = Emission Level at 3m + 20log(3/30)<sup>2</sup>



EUT Test Condition		Measurement Detail	
Channel	Channel 1	Frequency Range	13.553 ~ 13.567 MHz
Input Power	120 Vac, 60 Hz	Detector Function	Quasi-Peak
Environmental Conditions	23 deg. C, 66 % RH	Tested By	TitanHSU

Antenna Polarity & Test Distance: Loop Antenna Ground-Parallel Parallel at 3 m								
NO.	Freq. (MHz)	Emission Level (dBuV/m)	Limit (dBuV/m)	Margin (dB)	Antenna Height (m)	Table Angle (Degree)	Raw Value (dBuV)	Correction Factor (dB/m)
1	*13.56	38.0 QP	124 QP	-86	1.00 V	5	16.2	21.8

Remarks:

1. Emission level (dBuV/m) = Raw Value (dBuV) + Factor (dB/m)
2. Correction Factor(dB/m) = Antenna Factor(dB/m) + Cable Factor(dB) – Pre-Amplifier Factor(dB)
3. The other emission levels were very low against the limit.
4. Margin value = Emission level – Limit value.
5. Above limits have been translated by the formula

The measured field strength was extrapolated to distance 30 meters, using the formula that the limit of field strength varies as the inverse distance square (40dB per decade of distance)

Example:

$$\begin{aligned}
 13.56 \text{ MHz} &= 15848 \text{ uV/m} && 30\text{m} \\
 &= 84 \text{ dBuV/m} && 30\text{m} \\
 &= 84 + 20\log(30/3)^2 && 3\text{m} \\
 &= 124 \text{ dBuV/m}
 \end{aligned}$$

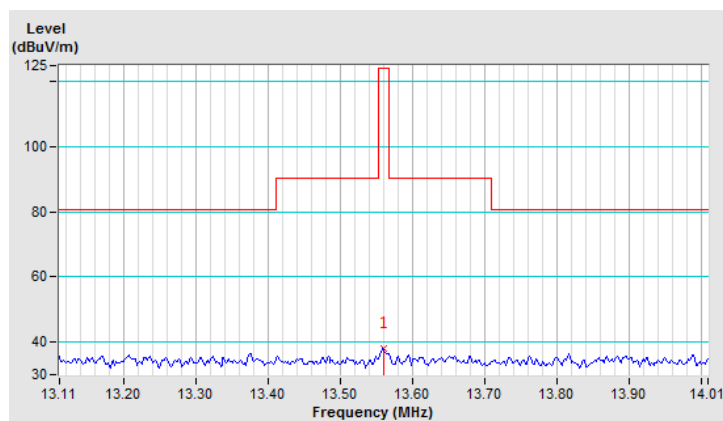

Antenna Polarity & Test Distance: Loop Antenna Ground-parallel at 30 m				
NO.	Frequency (MHz)	Emission Level (dBuV/m)	Limit (dBuV/m)	Margin (dB)
1	*13.56	-2 QP	84 QP	-86

Remarks: Emission Level at 30m = Emission Level at 3m + 20log(3/30)<sup>2</sup>

EUT Test Condition		Measurement Detail	
Channel	Channel 1	Frequency Range	Below 30 MHz
Input Power	120 Vac, 60 Hz	Detector Function	Quasi-Peak
Environmental Conditions	23 deg. C, 66 % RH	Tested By	TitanHSU

Antenna Polarity & Test Distance: Loop Antenna Parallel at 3 m								
NO.	Freq. (MHz)	Emission Level (dBuV/m)	Limit (dBuV/m)	Margin (dB)	Antenna Height (m)	Table Angle (Degree)	Raw Value (dBuV)	Correction Factor (dB/m)
1	5.23	38.8 QP	69.5	-30.7	1.00 V	242	18.6	20.2
2	8.35	38.5 QP	69.5	-31.0	1.00 V	230	17.4	21.1
3	16.86	39.6 QP	69.5	-29.9	1.00 V	26	17.6	22.0
4	20.28	39.1 QP	69.5	-30.4	1.00 V	277	17.0	22.1
5	24.06	39.6 QP	69.5	-29.9	1.00 V	38	17.5	22.1
6	26.46	38.1 QP	69.5	-31.4	1.00 V	40	16.0	22.1

Remarks:

1. Emission level (dBuV/m) = Raw Value (dBuV) + Factor (dB/m)
2. Correction Factor(dB/m) = Antenna Factor(dB/m) + Cable Factor(dB) – Pre-Amplifier Factor(dB)
3. The other emission levels were very low against the limit.
4. Margin value = Emission level – Limit value.

The measured field strength was extrapolated to distance 30 meters, using the formula that the limit of field strength varies as the inverse distance square (40dB per decade of distance)

Example:

$$\begin{aligned}
 1.705 \text{ MHz} \sim 30 \text{ MHz} &= 30 \text{ uV/m} && 30\text{m} \text{ (except } 13.110\text{MHz} \sim 14.010\text{MHz)} \\
 &= 29.54 \text{ dBuV/m} && 30\text{m} \\
 &= 29.54 + 20 \log(30/3)^2 && 3\text{m}
 \end{aligned}$$

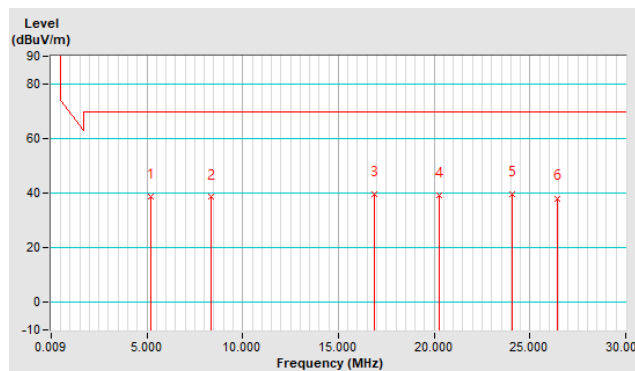

NO.	Frequency (MHz)	Emission Level (dBuV/m)	Limit (dBuV)	Margin
1	5.23	-1.2	29.5	-30.7
2	8.35	-1.5	29.5	-31
3	16.86	-0.4	29.5	-29.9
4	20.28	-0.9	29.5	-30.4
5	24.06	-0.4	29.5	-29.9
6	26.46	-1.9	29.5	-31.4

EUT Test Condition		Measurement Detail	
Channel	Channel 1	Frequency Range	Below 30 MHz
Input Power	120 Vac, 60 Hz	Detector Function	Quasi-Peak
Environmental Conditions	23 deg. C, 66 % RH	Tested By	TitanHSU

Antenna Polarity & Test Distance: Loop Antenna Perpendicular at 3 m								
NO.	Freq. (MHz)	Emission Level (dBuV/m)	Limit (dBuV/m)	Margin (dB)	Antenna Height (m)	Table Angle (Degree)	Raw Value (dBuV)	Correction Factor (dB/m)
1	5.23	37.1 QP	69.5	-32.4	1.00 V	351	16.9	20.2
2	9.85	36.7 QP	69.5	-32.8	1.00 V	170	15.1	21.6
3	15.78	37.0 QP	69.5	-32.5	1.00 V	140	15.1	21.9
4	20.28	37.8 QP	69.5	-31.7	1.00 V	289	15.7	22.1
5	22.20	37.1 QP	69.5	-32.4	1.00 V	4	15.0	22.1
6	24.06	38.5 QP	69.5	-31.0	1.00 V	237	16.4	22.1

Remarks:

1. Emission level (dBuV/m) = Raw Value (dBuV) + Factor (dB/m)
2. Correction Factor(dB/m) = Antenna Factor(dB/m) + Cable Factor(dB) – Pre-Amplifier Factor(dB)
3. The other emission levels were very low against the limit.
4. Margin value = Emission level – Limit value.

The measured field strength was extrapolated to distance 30 meters, using the formula that the limit of field strength varies as the inverse distance square (40dB per decade of distance)

Example:

$$\begin{aligned}
 1.705 \text{ MHz} \sim 30 \text{ MHz} &= 30 \text{ uV/m} && 30\text{m} \text{ (except } 13.110\text{MHz} \sim 14.010\text{MHz)} \\
 &= 29.54 \text{ dBuV/m} && 30\text{m} \\
 &= 29.54 + 20 \log(30/3)^2 && 3\text{m} \\
 &= 69.54 \text{ dBuV/m} && 3\text{m}
 \end{aligned}$$

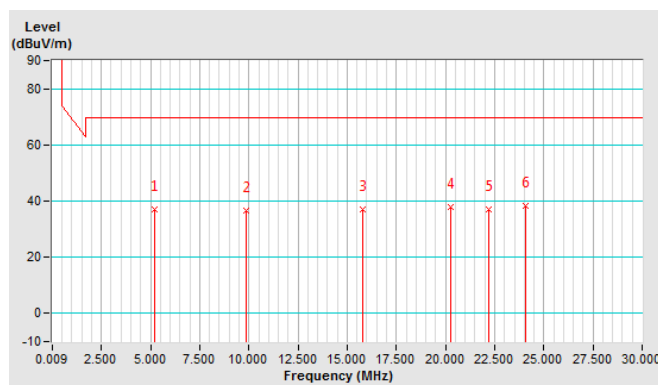

NO.	Frequency (MHz)	Emission Level (dBuV/m)	Limit (dBuV)	Margin
1	5.23	-2.9	29.5	-32.4
2	9.85	-3.3	29.5	-32.8
3	15.78	-3	29.5	-32.5
4	20.28	-2.2	29.5	-31.7
5	22.2	-2.9	29.5	-32.4
6	24.06	-1.5	29.5	-31

EUT Test Condition		Measurement Detail	
Channel	Channel 1	Frequency Range	Below 30 MHz
Input Power	120 Vac, 60 Hz	Detector Function	Quasi-Peak
Environmental Conditions	23 deg. C, 66 % RH	Tested By	TitanHSU

Antenna Polarity & Test Distance: Loop Antenna Ground-parallel at 3 m								
NO.	Freq. (MHz)	Emission Level (dBuV/m)	Limit (dBuV/m)	Margin (dB)	Antenna Height (m)	Table Angle (Degree)	Raw Value (dBuV)	Correction Factor (dB/m)
1	10.51	38.1 QP	69.5	-31.4	1.00 V	153	16.4	21.7
2	12.61	37.9 QP	69.5	-31.6	1.00 V	191	16.1	21.8
3	15.78	38.1 QP	69.5	-31.4	1.00 V	60	16.2	21.9
4	17.58	36.3 QP	69.5	-33.2	1.00 V	30	14.3	22.0
5	18.96	38.1 QP	69.5	-31.4	1.00 V	150	16.1	22.0
6	23.10	37.9 QP	69.5	-31.6	1.00 V	255	15.8	22.1

Remarks:

1. Emission level (dBuV/m) = Raw Value (dBuV) + Factor (dB/m)
2. Correction Factor(dB/m) = Antenna Factor(dB/m) + Cable Factor(dB) – Pre-Amplifier Factor(dB)
3. The other emission levels were very low against the limit.
4. Margin value = Emission level – Limit value.

The measured field strength was extrapolated to distance 30 meters, using the formula that the limit of field strength varies as the inverse distance square (40dB per decade of distance)

Example:

$$\begin{aligned}
 1.705 \text{ MHz} \sim 30 \text{ MHz} &= 30 \text{ uV/m} && 30\text{m} \text{ (except 13.110MHz} \sim 14.010\text{MHz)} \\
 &= 29.54 \text{ dBuV/m} && 30\text{m} \\
 &= 29.54 + 20 \log(30/3)^2 && 3\text{m} \\
 &= 69.54 \text{ dBuV/m} && 3\text{m}
 \end{aligned}$$

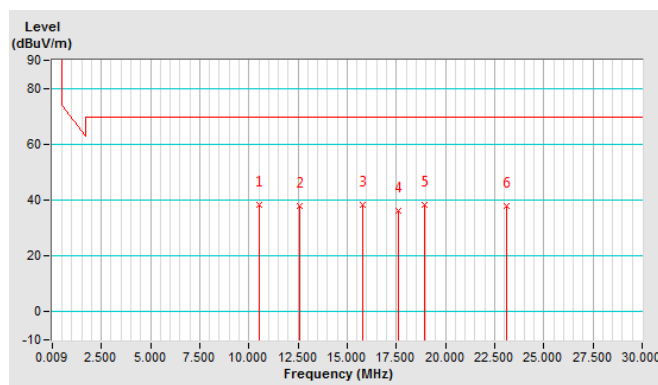

NO.	Frequency (MHz)	Emission Level (dBuV/m)	Limit (dBuV)	Margin
1	10.51	-1.9	29.5	-31.4
2	12.61	-40	29.5	-69.5
3	15.78	-1.9	29.5	-31.4
4	17.58	-3.4	29.5	-32.9
5	18.96	-1.9	29.5	-31.4
6	23.1	-2.1	29.5	-31.6

EUT Test Condition		Measurement Detail	
Channel	Channel 1	Frequency Range	Below 1000 MHz
Input Power	120 Vac, 60 Hz	Detector Function	Quasi-Peak or Peak
Environmental Conditions	23 deg. C, 66 % RH	Tested By	TitanHSU

Antenna Polarity & Test Distance: Horizontal at 3 m								
NO.	Freq. (MHz)	Emission Level (dBuV/m)	Limit (dBuV/m)	Margin (dB)	Antenna Height (m)	Table Angle (Degree)	Raw Value (dBuV)	Correction Factor (dB/m)
1	66.55	24.4 QP	40.0	-15.6	1.50 H	8	34.7	-10.3
2	84.83	21.7 QP	40.0	-18.3	1.00 H	200	35.5	-13.8
3	150.91	22.5 QP	43.5	-21.0	2.00 H	183	31.2	-8.7
4	207.15	30.6 QP	43.5	-12.9	1.00 H	204	41.5	-10.9
5	297.13	25.2 QP	46.0	-20.8	1.50 H	102	32.7	-7.5
6	374.46	27.2 QP	46.0	-18.8	1.00 H	294	32.4	-5.2

Remarks:

1. Emission Level(dBuV/m) = Raw Value(dBuV) + Correction Factor(dB/m)
2. Margin value = Emission level – Limit value.
3. The other emission levels were very low against the limit.
4. Correction Factor(dB/m) = Antenna Factor(dB/m) + Cable Factor(dB) – Pre-Amplifier Factor (dB)

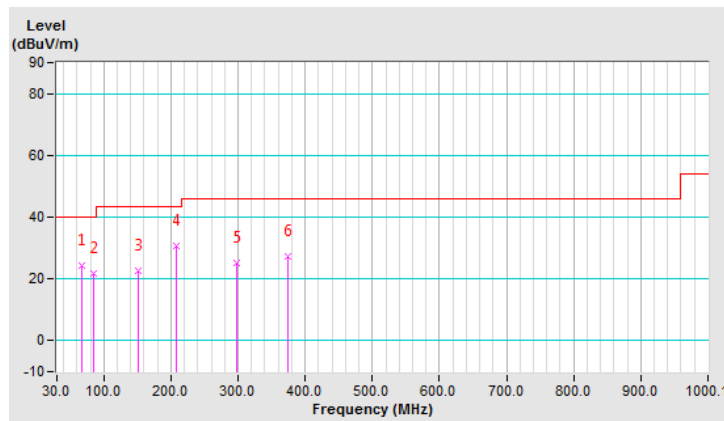

EUT Test Condition		Measurement Detail	
Channel	Channel 1	Frequency Range	Below 1000 MHz
Input Power	120 Vac, 60 Hz	Detector Function	Quasi-Peak or Peak
Environmental Conditions	23 deg. C, 66 % RH	Tested By	TitanHSU

Antenna Polarity & Test Distance: Vertical at 3 m								
NO.	Freq. (MHz)	Emission Level (dBuV/m)	Limit (dBuV/m)	Margin (dB)	Antenna Height (m)	Table Angle (Degree)	Raw Value (dBuV)	Correction Factor (dB/m)
1	49.68	25.6 QP	40.0	-14.4	1.50 V	324	34.6	-9.0
2	65.15	28.0 QP	40.0	-12.0	1.00 V	5	38.1	-10.1
3	104.51	28.6 QP	43.5	-14.9	1.00 V	151	41.0	-12.4
4	118.57	30.2 QP	43.5	-13.3	2.00 V	12	41.3	-11.1
5	207.15	24.9 QP	43.5	-18.6	1.00 V	184	35.8	-10.9
6	297.13	25.6 QP	46.0	-20.4	1.50 V	146	33.1	-7.5

Remarks:

1. Emission Level(dBuV/m) = Raw Value(dBuV) + Correction Factor(dB/m)
2. Margin value = Emission level – Limit value.
3. The other emission levels were very low against the limit.
4. Correction Factor(dB/m) = Antenna Factor(dB/m) + Cable Factor(dB) – Pre-Amplifier Factor (dB)

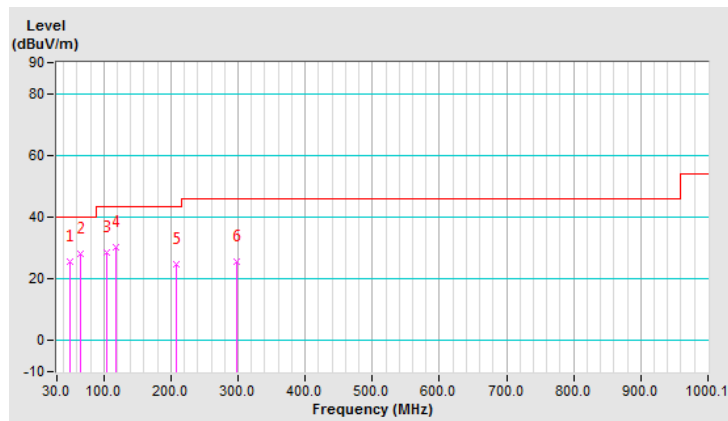

**Type F**

EUT Test Condition		Measurement Detail	
Channel	Channel 1	Frequency Range	13.553 ~ 13.567 MHz
Input Power	120 Vac, 60 Hz	Detector Function	Quasi-Peak
Environmental Conditions	23 deg. C, 66 % RH	Tested By	TitanHSU

Antenna Polarity & Test Distance: Loop Antenna Parallel at 3 m								
NO.	Freq. (MHz)	Emission Level (dBuV/m)	Limit (dBuV/m)	Margin (dB)	Antenna Height (m)	Table Angle (Degree)	Raw Value (dBuV)	Correction Factor (dB/m)
1	*13.56	40.5 QP	124 QP	-83.5	1.00 V	259	18.7	21.8

Remarks:

1. Emission level (dBuV/m) = Raw Value (dBuV) + Factor (dB/m)
2. Correction Factor(dB/m) = Antenna Factor(dB/m) + Cable Factor(dB) – Pre-Amplifier Factor(dB)
3. The other emission levels were very low against the limit.
4. Margin value = Emission level – Limit value.
5. Above limits have been translated by the formula

The measured field strength was extrapolated to distance 30 meters, using the formula that the limit of field strength varies as the inverse distance square (40dB per decade of distance)

Example:

$$\begin{aligned}
 13.56 \text{ MHz} &= 15848 \text{ uV/m} && 30\text{m} \\
 &= 84 \text{ dBuV/m} && 30\text{m} \\
 &= 84+20\log(30/3)^2 && 3\text{m} \\
 &= 124 \text{ dBuV/m}
 \end{aligned}$$

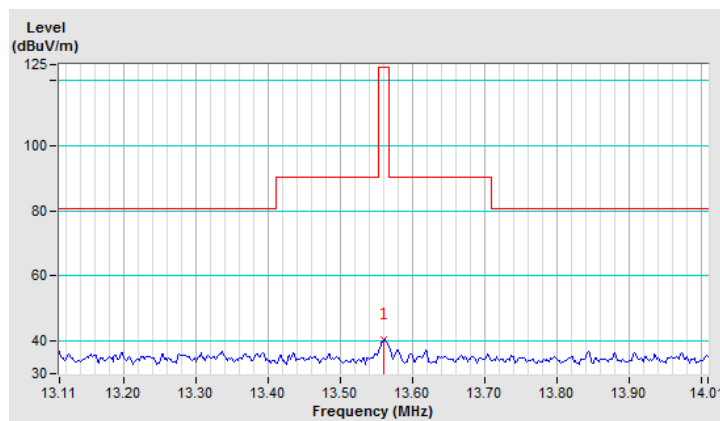

Antenna Polarity & Test Distance: Loop Antenna Parallel at 30 m				
NO.	Frequency (MHz)	Emission Level (dBuV/m)	Limit (dBuV/m)	Margin (dB)
1	*13.56	0.5 QP	84 QP	-83.5

Remarks: Emission Level at 30m = Emission Level at 3m + 20log(3/30)<sup>2</sup>

EUT Test Condition		Measurement Detail	
Channel	Channel 1	Frequency Range	13.553 ~ 13.567 MHz
Input Power	120 Vac, 60 Hz	Detector Function	Quasi-Peak
Environmental Conditions	23 deg. C, 66 % RH	Tested By	TitanHSU

Antenna Polarity & Test Distance: Loop Antenna Perpendicular at 3 m								
NO.	Freq. (MHz)	Emission Level (dBuV/m)	Limit (dBuV/m)	Margin (dB)	Antenna Height (m)	Table Angle (Degree)	Raw Value (dBuV)	Correction Factor (dB/m)
1	*13.56	38.5 QP	124 QP	-85.5	1.00 V	337	16.7	21.8

Remarks:

1. Emission level (dBuV/m) = Raw Value (dBuV) + Factor (dB/m)
2. Correction Factor(dB/m) = Antenna Factor(dB/m) + Cable Factor(dB) – Pre-Amplifier Factor(dB)
3. The other emission levels were very low against the limit.
4. Margin value = Emission level – Limit value.
5. Above limits have been translated by the formula

The measured field strength was extrapolated to distance 30 meters, using the formula that the limit of field strength varies as the inverse distance square (40dB per decade of distance)

Example:

$$\begin{aligned}
 13.56 \text{ MHz} &= 15848 \text{ uV/m} && 30\text{m} \\
 &= 84 \text{ dBuV/m} && 30\text{m} \\
 &= 84 + 20\log(30/3)^2 && 3\text{m} \\
 &= 124 \text{ dBuV/m}
 \end{aligned}$$

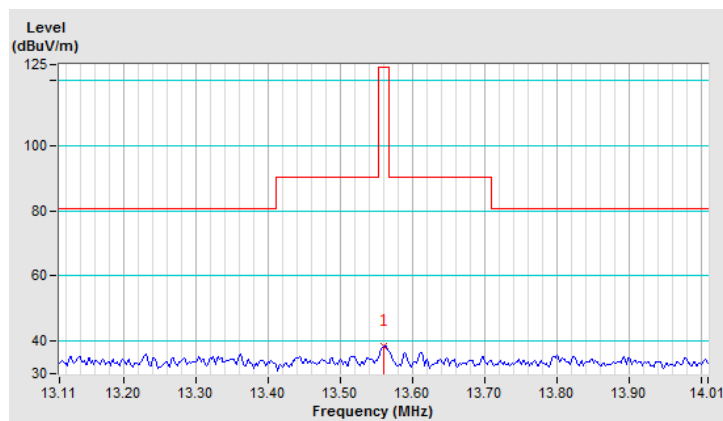

Antenna Polarity & Test Distance: Loop Antenna Perpendicular at 30 m				
NO.	Frequency (MHz)	Emission Level (dBuV/m)	Limit (dBuV/m)	Margin (dB)
1	*13.56	-1.5 QP	84 QP	-85.5

Remarks: Emission Level at 30m = Emission Level at 3m + 20log(3/30)<sup>2</sup>



EUT Test Condition		Measurement Detail	
Channel	Channel 1	Frequency Range	13.553 ~ 13.567 MHz
Input Power	120 Vac, 60 Hz	Detector Function	Quasi-Peak
Environmental Conditions	23 deg. C, 66 % RH	Tested By	TitanHSU

Antenna Polarity & Test Distance: Loop Antenna Ground-Parallel Parallel at 3 m								
NO.	Freq. (MHz)	Emission Level (dBuV/m)	Limit (dBuV/m)	Margin (dB)	Antenna Height (m)	Table Angle (Degree)	Raw Value (dBuV)	Correction Factor (dB/m)
1	*13.56	37.5 QP	124 QP	-86.5	1.00 V	13	15.7	21.8

Remarks:

1. Emission level (dBuV/m) = Raw Value (dBuV) + Factor (dB/m)
2. Correction Factor(dB/m) = Antenna Factor(dB/m) + Cable Factor(dB) – Pre-Amplifier Factor(dB)
3. The other emission levels were very low against the limit.
4. Margin value = Emission level – Limit value.
5. Above limits have been translated by the formula

The measured field strength was extrapolated to distance 30 meters, using the formula that the limit of field strength varies as the inverse distance square (40dB per decade of distance)

Example:

$$\begin{aligned}
 13.56 \text{ MHz} &= 15848 \text{ uV/m} && 30\text{m} \\
 &= 84 \text{ dBuV/m} && 30\text{m} \\
 &= 84 + 20\log(30/3)^2 && 3\text{m} \\
 &= 124 \text{ dBuV/m}
 \end{aligned}$$

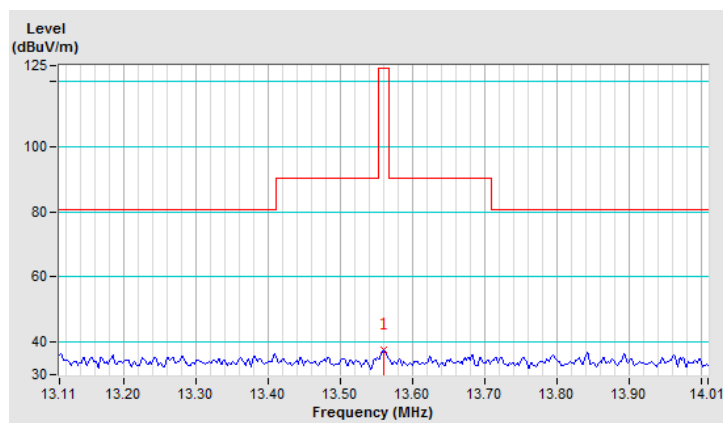

Antenna Polarity & Test Distance: Loop Antenna Ground-parallel at 30 m				
NO.	Frequency (MHz)	Emission Level (dBuV/m)	Limit (dBuV/m)	Margin (dB)
1	*13.56	-2.5 QP	84	-86.5 QP

Remarks: Emission Level at 30m = Emission Level at 3m + 20log(3/30)<sup>2</sup>

EUT Test Condition		Measurement Detail	
Channel	Channel 1	Frequency Range	Below 30 MHz
Input Power	120 Vac, 60 Hz	Detector Function	Quasi-Peak
Environmental Conditions	23 deg. C, 66 % RH	Tested By	TitanHSU

Antenna Polarity & Test Distance: Loop Antenna Parallel at 3 m								
NO.	Freq. (MHz)	Emission Level (dBuV/m)	Limit (dBuV/m)	Margin (dB)	Antenna Height (m)	Table Angle (Degree)	Raw Value (dBuV)	Correction Factor (dB/m)
1	5.23	39.6 QP	69.5	-29.9	1.00 V	118	19.4	20.2
2	10.51	37.2 QP	69.5	-32.3	1.00 V	264	15.5	21.7
3	16.80	39.6 QP	69.5	-29.9	1.00 V	342	17.6	22.0
4	<b>20.04</b>	<b>39.8 QP</b>	<b>69.5</b>	<b>-29.7</b>	<b>1.00 V</b>	<b>161</b>	<b>17.7</b>	<b>22.1</b>
5	24.06	38.9 QP	69.5	-30.6	1.00 V	75	16.8	22.1
6	28.98	37.0 QP	69.5	-32.5	1.00 V	82	14.8	22.2

Remarks:

1. Emission level (dBuV/m) = Raw Value (dBuV) + Factor (dB/m)
2. Correction Factor(dB/m) = Antenna Factor(dB/m) + Cable Factor(dB) – Pre-Amplifier Factor(dB)
3. The other emission levels were very low against the limit.
4. Margin value = Emission level – Limit value.

The measured field strength was extrapolated to distance 30 meters, using the formula that the limit of field strength varies as the inverse distance square (40dB per decade of distance)

Example:

$$\begin{aligned}
 1.705 \text{ MHz} \sim 30 \text{ MHz} &= 30 \text{ uV/m} && 30\text{m} \text{ (except } 13.110\text{MHz} \sim 14.010\text{MHz)} \\
 &= 29.54 \text{ dBuV/m} && 30\text{m} \\
 &= 29.54 + 20 \log(30/3)^2 && 3\text{m} \\
 &= 69.54 \text{ dBuV/m} && 3\text{m}
 \end{aligned}$$

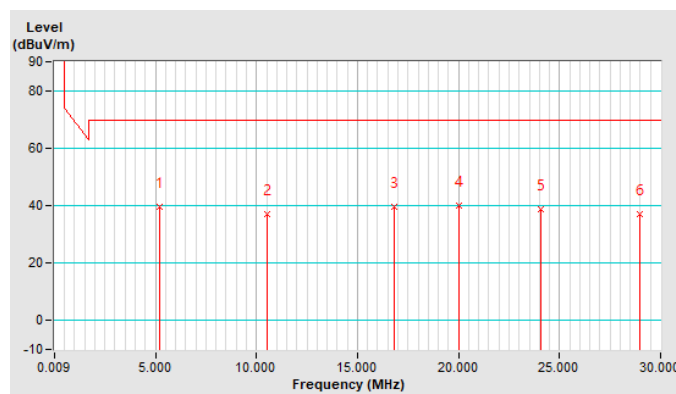

NO.	Frequency (MHz)	Emission Level (dBuV/m)	Limit (dBuV)	Margin
1	5.23	-0.4	29.5	-29.9
2	10.51	-2.8	29.5	-32.3
3	16.8	-0.4	29.5	-29.9
4	20.04	-0.2	29.5	-29.7
5	24.06	-1.1	29.5	-30.6
6	28.98	-3	29.5	-32.5

EUT Test Condition		Measurement Detail	
Channel	Channel 1	Frequency Range	Below 30 MHz
Input Power	120 Vac, 60 Hz	Detector Function	Quasi-Peak
Environmental Conditions	23 deg. C, 66 % RH	Tested By	TitanHSU

Antenna Polarity & Test Distance: Loop Antenna Perpendicular at 3 m								
NO.	Freq. (MHz)	Emission Level (dBuV/m)	Limit (dBuV/m)	Margin (dB)	Antenna Height (m)	Table Angle (Degree)	Raw Value (dBuV)	Correction Factor (dB/m)
1	2.47	37.8 QP	69.5	-31.7	1.00 V	64	17.9	19.9
2	7.03	35.3 QP	69.5	-34.2	1.00 V	275	14.6	20.7
3	10.51	36.3 QP	69.5	-33.2	1.00 V	145	14.6	21.7
4	14.88	36.1 QP	69.5	-33.4	1.00 V	272	14.2	21.9
5	20.28	38.5 QP	69.5	-31.0	1.00 V	120	16.4	22.1
6	24.06	38.9 QP	69.5	-30.6	1.00 V	97	16.8	22.1

Remarks:

1. Emission level (dBuV/m) = Raw Value (dBuV) + Factor (dB/m)
2. Correction Factor(dB/m) = Antenna Factor(dB/m) + Cable Factor(dB) – Pre-Amplifier Factor(dB)
3. The other emission levels were very low against the limit.
4. Margin value = Emission level – Limit value.

The measured field strength was extrapolated to distance 30 meters, using the formula that the limit of field strength varies as the inverse distance square (40dB per decade of distance)

Example:

$$\begin{aligned}
 1.705 \text{ MHz} \sim 30 \text{ MHz} &= 30 \text{ uV/m} && 30\text{m} \text{ (except 13.110MHz} \sim 14.010\text{MHz)} \\
 &= 29.54 \text{ dBuV/m} && 30\text{m} \\
 &= 29.54 + 20 \log(30/3)^2 && 3\text{m} \\
 &= 69.54 \text{ dBuV/m} && 3\text{m}
 \end{aligned}$$

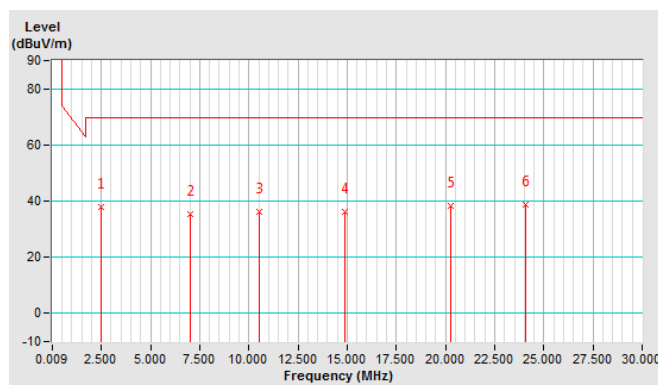

NO.	Frequency (MHz)	Emission Level (dBuV/m)	Limit (dBuV)	Margin
1	2.47	-2.2	29.5	-31.7
2	7.03	-4.7	29.5	-34.2
3	10.51	-3.7	29.5	-33.2
4	14.88	-3.9	29.5	-33.4
5	20.28	-1.7	29.5	-31.2
6	24.06	-1.9	29.5	-31.4

EUT Test Condition		Measurement Detail	
Channel	Channel 1	Frequency Range	Below 30 MHz
Input Power	120 Vac, 60 Hz	Detector Function	Quasi-Peak
Environmental Conditions	23 deg. C, 66 % RH	Tested By	TitanHSU

Antenna Polarity & Test Distance: Loop Antenna Ground-parallel at 3 m								
NO.	Freq. (MHz)	Emission Level (dBuV/m)	Limit (dBuV/m)	Margin (dB)	Antenna Height (m)	Table Angle (Degree)	Raw Value (dBuV)	Correction Factor (dB/m)
1	6.37	37.0 QP	69.5	-32.5	1.00 V	326	16.5	20.5
2	10.63	36.0 QP	69.5	-33.5	1.00 V	227	14.3	21.7
3	18.42	37.5 QP	69.5	-32.0	1.00 V	305	15.5	22.0
4	20.28	39.3 QP	69.5	-30.2	1.00 V	242	17.2	22.1
5	21.24	38.6 QP	69.5	-30.9	1.00 V	312	16.5	22.1
6	23.10	38.4 QP	69.5	-31.1	1.00 V	211	16.3	22.1

Remarks:

- Emission level (dBuV/m) = Raw Value (dBuV) + Factor (dB/m)
- Correction Factor(dB/m) = Antenna Factor(dB/m) + Cable Factor(dB) – Pre-Amplifier Factor(dB)
- The other emission levels were very low against the limit.
- Margin value = Emission level – Limit value.

The measured field strength was extrapolated to distance 30 meters, using the formula that the limit of field strength varies as the inverse distance square (40dB per decade of distance)

Example:

$$\begin{aligned}
 1.705 \text{ MHz} \sim 30 \text{ MHz} &= 30 \text{ uV/m} && 30\text{m} \text{ (except 13.110MHz} \sim 14.010\text{MHz)} \\
 &= 29.54 \text{ dBuV/m} && 30\text{m} \\
 &= 29.54 + 20 \log(30/3)^2 && 3\text{m} \\
 &= 69.54 \text{ dBuV/m} && 3\text{m}
 \end{aligned}$$

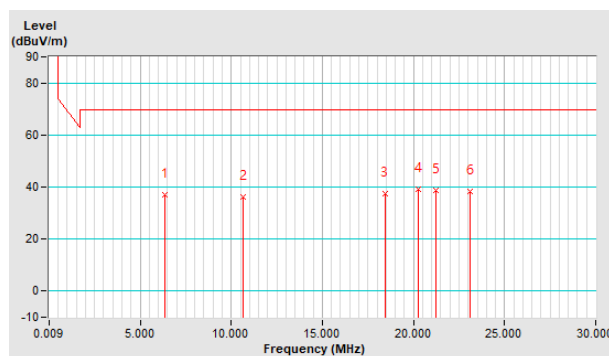

NO.	Frequency (MHz)	Emission Level (dBuV/m)	Limit (dBuV)	Margin
1	6.37	-3	29.5	-32.5
2	10.63	-4	29.5	-33.5
3	18.42	-2.5	29.5	-32
4	20.28	-0.7	29.5	-30.2
5	21.24	-1.4	29.5	-30.9
6	23.1	-1.6	29.5	-31.1

EUT Test Condition		Measurement Detail	
Channel	Channel 1	Frequency Range	Below 1000 MHz
Input Power	120 Vac, 60 Hz	Detector Function	Quasi-Peak or Peak
Environmental Conditions	23 deg. C, 66 % RH	Tested By	TitanHSU

Antenna Polarity & Test Distance: Horizontal at 3 m								
NO.	Freq. (MHz)	Emission Level (dBuV/m)	Limit (dBuV/m)	Margin (dB)	Antenna Height (m)	Table Angle (Degree)	Raw Value (dBuV)	Correction Factor (dB/m)
1	66.55	25.5 QP	40.0	-14.5	1.50 H	18	35.8	-10.3
2	84.83	21.3 QP	40.0	-18.7	1.00 H	62	35.1	-13.8
3	131.23	22.7 QP	43.5	-20.8	1.00 H	219	32.7	-10.0
4	208.55	30.1 QP	43.5	-13.4	1.00 H	231	40.9	-10.8
5	329.47	32.7 QP	46.0	-13.3	2.00 H	108	39.3	-6.6
6	458.81	27.4 QP	46.0	-18.6	1.50 H	192	30.0	-2.6

Remarks:

1. Emission Level(dBuV/m) = Raw Value(dBuV) + Correction Factor(dB/m)
2. Margin value = Emission level – Limit value.
3. The other emission levels were very low against the limit.
4. Correction Factor(dB/m) = Antenna Factor(dB/m) + Cable Factor(dB) – Pre-Amplifier Factor (dB)

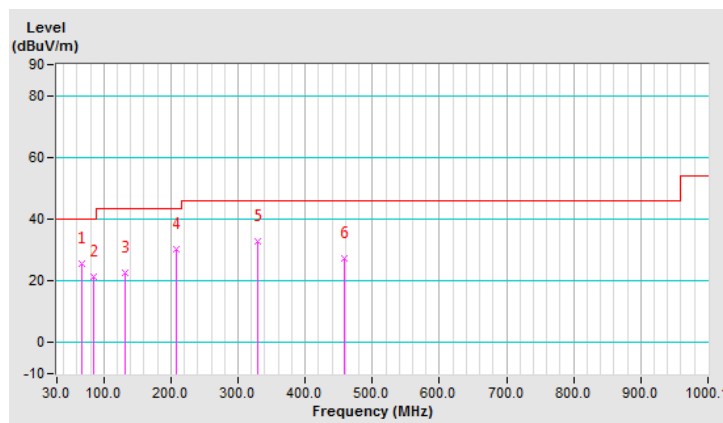

EUT Test Condition		Measurement Detail	
Channel	Channel 1	Frequency Range	Below 1000 MHz
Input Power	120 Vac, 60 Hz	Detector Function	Quasi-Peak or Peak
Environmental Conditions	23 deg. C, 66 % RH	Tested By	TitanHSU

Antenna Polarity & Test Distance: Vertical at 3 m								
NO.	Freq. (MHz)	Emission Level (dBuV/m)	Limit (dBuV/m)	Margin (dB)	Antenna Height (m)	Table Angle (Degree)	Raw Value (dBuV)	Correction Factor (dB/m)
1	67.96	31.9 QP	40.0	-8.1	1.50 V	2	42.5	-10.6
2	138.26	25.5 QP	43.5	-18.0	1.00 V	45	34.7	-9.2
3	205.74	25.9 QP	43.5	-17.6	1.00 V	187	36.8	-10.9
4	297.13	25.6 QP	46.0	-20.4	2.00 V	251	33.1	-7.5
5	479.90	34.9 QP	46.0	-11.1	1.00 V	186	37.0	-2.1
6	717.51	37.9 QP	46.0	-8.1	1.50 V	3	35.8	2.1

Remarks:

1. Emission Level(dBuV/m) = Raw Value(dBuV) + Correction Factor(dB/m)
2. Margin value = Emission level – Limit value.
3. The other emission levels were very low against the limit.
4. Correction Factor(dB/m) = Antenna Factor(dB/m) + Cable Factor(dB) – Pre-Amplifier Factor (dB)

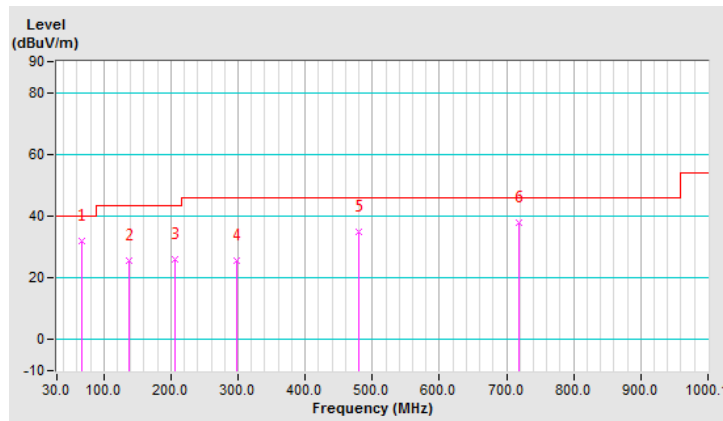

**Mode B**  
**Type A**

EUT Test Condition		Measurement Detail	
Channel	Channel 1	Frequency Range	13.553 ~ 13.567 MHz
Input Power	120 Vac, 60 Hz	Detector Function	Quasi-Peak
Environmental Conditions	23 deg. C, 66 % RH	Tested By	TitanHSU

Antenna Polarity & Test Distance: Loop Antenna Parallel at 3 m								
NO.	Freq. (MHz)	Emission Level (dBuV/m)	Limit (dBuV/m)	Margin (dB)	Antenna Height (m)	Table Angle (Degree)	Raw Value (dBuV)	Correction Factor (dB/m)
1	*13.56	46.5 QP	124 QP	-77.5	1.00 V	234	24.7	21.8

Remarks:

1. Emission level (dBuV/m) = Raw Value (dBuV) + Factor (dB/m)
2. Correction Factor(dB/m) = Antenna Factor(dB/m) + Cable Factor(dB) – Pre-Amplifier Factor(dB)
3. The other emission levels were very low against the limit.
4. Margin value = Emission level – Limit value.
5. Above limits have been translated by the formula

The measured field strength was extrapolated to distance 30 meters, using the formula that the limit of field strength varies as the inverse distance square (40dB per decade of distance)

Example:

$$\begin{aligned}
 13.56 \text{ MHz} &= 15848 \text{ uV/m} && 30\text{m} \\
 &= 84 \text{ dBuV/m} && 30\text{m} \\
 &= 84+20\log(30/3)^2 && 3\text{m} \\
 &= 124 \text{ dBuV/m}
 \end{aligned}$$

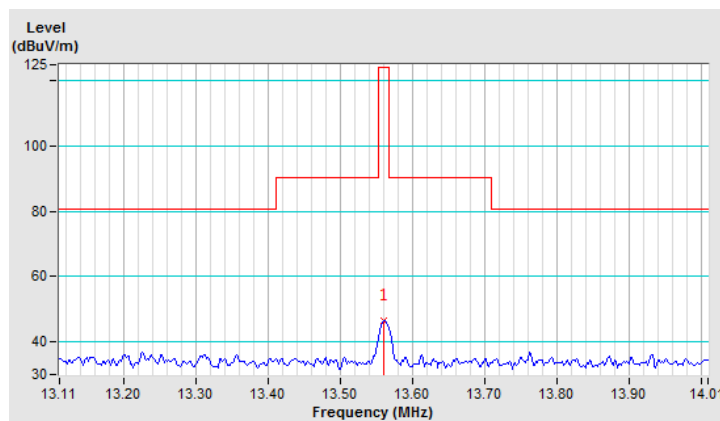

Antenna Polarity & Test Distance: Loop Antenna Parallel at 30 m				
NO.	Frequency (MHz)	Emission Level (dBuV/m)	Limit (dBuV/m)	Margin (dB)
1	*13.56	6.5 QP	84 QP	-77.5

Remarks: Emission Level at 30m = Emission Level at 3m + 20log(3/30)<sup>2</sup>

EUT Test Condition		Measurement Detail	
Channel	Channel 1	Frequency Range	13.553 ~ 13.567 MHz
Input Power	120 Vac, 60 Hz	Detector Function	Quasi-Peak
Environmental Conditions	23 deg. C, 66 % RH	Tested By	TitanHSU

Antenna Polarity & Test Distance: Loop Antenna Perpendicular at 3 m								
NO.	Freq. (MHz)	Emission Level (dBuV/m)	Limit (dBuV/m)	Margin (dB)	Antenna Height (m)	Table Angle (Degree)	Raw Value (dBuV)	Correction Factor (dB/m)
1	*13.56	44.0 QP	124 QP	-80	1.00 V	128	22.2	21.8

Remarks:

1. Emission level (dBuV/m) = Raw Value (dBuV) + Factor (dB/m)
2. Correction Factor(dB/m) = Antenna Factor(dB/m) + Cable Factor(dB) – Pre-Amplifier Factor(dB)
3. The other emission levels were very low against the limit.
4. Margin value = Emission level – Limit value.
5. Above limits have been translated by the formula

The measured field strength was extrapolated to distance 30 meters, using the formula that the limit of field strength varies as the inverse distance square (40dB per decade of distance)

Example:

$$\begin{aligned}
 13.56 \text{ MHz} &= 15848 \text{ uV/m} && 30\text{m} \\
 &= 84 \text{ dBuV/m} && 30\text{m} \\
 &= 84 + 20\log(30/3)^2 && 3\text{m} \\
 &= 124 \text{ dBuV/m}
 \end{aligned}$$

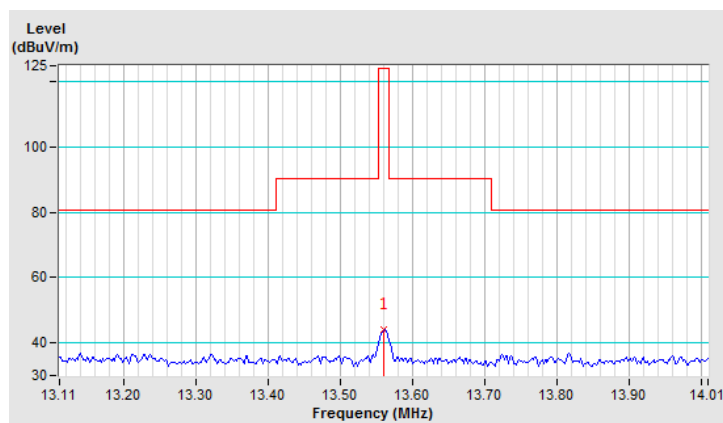

Antenna Polarity & Test Distance: Loop Antenna Perpendicular at 30 m				
NO.	Frequency (MHz)	Emission Level (dBuV/m)	Limit (dBuV/m)	Margin (dB)
1	*13.56	4 QP	84 QP	-80

Remarks: Emission Level at 30m = Emission Level at 3m + 20log(3/30)<sup>2</sup>



EUT Test Condition		Measurement Detail	
Channel	Channel 1	Frequency Range	13.553 ~ 13.567 MHz
Input Power	120 Vac, 60 Hz	Detector Function	Quasi-Peak
Environmental Conditions	23 deg. C, 66 % RH	Tested By	TitanHSU

Antenna Polarity & Test Distance: Loop Antenna Ground-Parallel Parallel at 3 m								
NO.	Freq. (MHz)	Emission Level (dBuV/m)	Limit (dBuV/m)	Margin (dB)	Antenna Height (m)	Table Angle (Degree)	Raw Value (dBuV)	Correction Factor (dB/m)
1	*13.56	39.4 QP	124 QP	-84.6	1.00 V	88	17.6	21.8

Remarks:

1. Emission level (dBuV/m) = Raw Value (dBuV) + Factor (dB/m)
2. Correction Factor(dB/m) = Antenna Factor(dB/m) + Cable Factor(dB) – Pre-Amplifier Factor(dB)
3. The other emission levels were very low against the limit.
4. Margin value = Emission level – Limit value.
5. Above limits have been translated by the formula

The measured field strength was extrapolated to distance 30 meters, using the formula that the limit of field strength varies as the inverse distance square (40dB per decade of distance)

Example:

$$\begin{aligned}
 13.56 \text{ MHz} &= 15848 \text{ uV/m} && 30\text{m} \\
 &= 84 \text{ dBuV/m} && 30\text{m} \\
 &= 84 + 20\log(30/3)^2 && 3\text{m} \\
 &= 124 \text{ dBuV/m}
 \end{aligned}$$

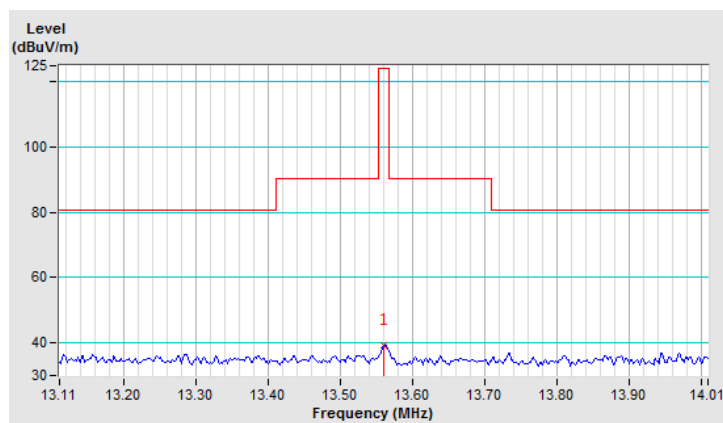

Antenna Polarity & Test Distance: Loop Antenna Ground-parallel at 30 m				
NO.	Frequency (MHz)	Emission Level (dBuV/m)	Limit (dBuV/m)	Margin (dB)
1	*13.56	-0.6 QP	84 QP	-84.6

Remarks: Emission Level at 30m = Emission Level at 3m + 20log(3/30)<sup>2</sup>

EUT Test Condition		Measurement Detail	
Channel	Channel 1	Frequency Range	Below 30 MHz
Input Power	120 Vac, 60 Hz	Detector Function	Quasi-Peak
Environmental Conditions	23 deg. C, 66 % RH	Tested By	TitanHSU

Antenna Polarity & Test Distance: Loop Antenna Parallel at 3 m								
NO.	Freq. (MHz)	Emission Level (dBuV/m)	Limit (dBuV/m)	Margin (dB)	Antenna Height (m)	Table Angle (Degree)	Raw Value (dBuV)	Correction Factor (dB/m)
1	3.55	45.9 QP	69.5	-23.6	1.00 V	295	25.9	20.0
2	10.51	39.9 QP	69.5	-29.6	1.00 V	78	18.2	21.7
3	12.61	44.2 QP	69.5	-25.3	1.00 V	282	22.4	21.8
4	15.78	44.4 QP	69.5	-25.1	1.00 V	176	22.5	21.9
5	17.88	41.7 QP	69.5	-27.8	1.00 V	301	19.7	22.0
6	18.96	45.1 QP	69.5	-24.4	1.00 V	286	23.1	22.0

Remarks:

1. Emission level (dBuV/m) = Raw Value (dBuV) + Factor (dB/m)
2. Correction Factor(dB/m) = Antenna Factor(dB/m) + Cable Factor(dB)
3. The other emission levels were very low against the limit.
4. Margin value = Emission level – Limit value.

The measured field strength was extrapolated to distance 30 meters, using the formula that the limit of field strength varies as the inverse distance square (40dB per decade of distance)

Example:

$$\begin{aligned}
 1.705 \text{ MHz} \sim 30 \text{ MHz} &= 30 \text{ uV/m} && 30\text{m} \text{ (except 13.110MHz} \sim 14.010\text{MHz)} \\
 &= 29.54 \text{ dBuV/m} && 30\text{m} \\
 &= 29.54 + 20 \log(30/3)^2 && 3\text{m} \\
 &= 69.54 \text{ dBuV/m} && 3\text{m}
 \end{aligned}$$

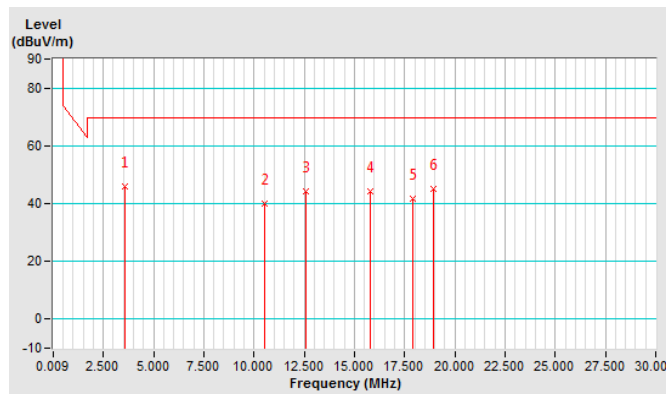

NO.	Frequency (MHz)	Emission Level (dBuV/m)	Limit (dBuV)	Margin
1	3.55	5.9	29.5	-23.6
2	10.51	-0.1	29.5	-29.6
3	12.61	4.2	29.5	-25.3
4	15.78	4.4	29.5	-25.1
5	17.88	1.7	29.5	-27.8
6	18.96	5.1	29.5	-24.4

EUT Test Condition		Measurement Detail	
Channel	Channel 1	Frequency Range	Below 30 MHz
Input Power	120 Vac, 60 Hz	Detector Function	Quasi-Peak
Environmental Conditions	23 deg. C, 66 % RH	Tested By	TitanHSU

Antenna Polarity & Test Distance: Loop Antenna Perpendicular at 3 m								
NO.	Freq. (MHz)	Emission Level (dBuV/m)	Limit (dBuV/m)	Margin (dB)	Antenna Height (m)	Table Angle (Degree)	Raw Value (dBuV)	Correction Factor (dB/m)
1	3.13	43.8 QP	69.5	-25.7	1.00 V	14	23.9	19.9
2	8.11	39.9 QP	69.5	-29.6	1.00 V	168	18.8	21.1
3	10.51	41.1 QP	69.5	-28.4	1.00 V	32	19.4	21.7
4	16.86	44.2 QP	69.5	-25.3	1.00 V	43	22.2	22.0
5	18.96	44.4 QP	69.5	-25.1	1.00 V	283	22.4	22.0
6	28.68	38.2 QP	69.5	-31.3	1.00 V	173	16.0	22.2

Remarks:

1. Emission level (dBuV/m) = Raw Value (dBuV) + Factor (dB/m)
2. Correction Factor(dB/m) = Antenna Factor(dB/m) + Cable Factor(dB) – Pre-Amplifier Factor(dB)
3. The other emission levels were very low against the limit.
4. Margin value = Emission level – Limit value.

The measured field strength was extrapolated to distance 30 meters, using the formula that the limit of field strength varies as the inverse distance square (40dB per decade of distance)

Example:

$$\begin{aligned}
 1.705 \text{ MHz} \sim 30 \text{ MHz} &= 30 \text{ uV/m} && 30\text{m} \quad (\text{except } 13.110\text{MHz} \sim 14.010\text{MHz}) \\
 &= 29.54 \text{ dBuV/m} && 30\text{m} \\
 &= 29.54 + 20 \log(30/3)^2 && 3\text{m} \\
 &= 69.54 \text{ dBuV/m} && 3\text{m}
 \end{aligned}$$

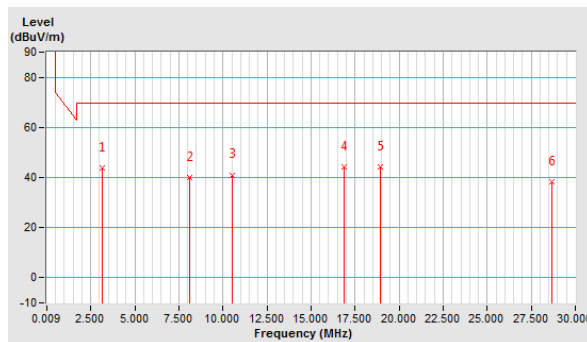

NO.	Frequency (MHz)	Emission Level (dBuV/m)	Limit (dBuV)	Margin
1	3.13	3.8	29.5	-25.7
2	8.11	-0.1	29.5	-29.6
3	10.51	1.1	29.5	-28.4
4	16.86	4.2	29.5	-25.3
5	18.96	4.4	29.5	-25.1
6	28.68	-1.8	29.5	-31.3

EUT Test Condition		Measurement Detail	
Channel	Channel 1	Frequency Range	Below 30 MHz
Input Power	120 Vac, 60 Hz	Detector Function	Quasi-Peak
Environmental Conditions	23 deg. C, 66 % RH	Tested By	TitanHSU

Antenna Polarity & Test Distance: Loop Antenna Ground-parallel at 3 m								
NO.	Freq. (MHz)	Emission Level (dBuV/m)	Limit (dBuV/m)	Margin (dB)	Antenna Height (m)	Table Angle (Degree)	Raw Value (dBuV)	Correction Factor (dB/m)
1	3.55	40.0 QP	69.5	-29.5	1.00 V	129	20.0	20.0
2	15.78	41.4 QP	69.5	-28.1	1.00 V	131	19.5	21.9
3	17.88	38.7 QP	69.5	-30.8	1.00 V	345	16.7	22.0
4	20.28	38.0 QP	69.5	-31.5	1.00 V	315	15.9	22.1
5	23.22	36.0 QP	69.5	-33.5	1.00 V	345	13.9	22.1
6	25.74	37.2 QP	69.5	-32.3	1.00 V	168	15.1	22.1

Remarks:

1. Emission level (dBuV/m) = Raw Value (dBuV) + Factor (dB/m)
2. Correction Factor(dB/m) = Antenna Factor(dB/m) + Cable Factor(dB) – Pre-Amplifier Factor(dB)
3. The other emission levels were very low against the limit.
4. Margin value = Emission level – Limit value.

The measured field strength was extrapolated to distance 30 meters, using the formula that the limit of field strength varies as the inverse distance square (40dB per decade of distance)

Example:

$$\begin{aligned}
 1.705 \text{ MHz} \sim 30 \text{ MHz} &= 30 \text{ uV/m} && 30\text{m} \text{ (except } 13.110\text{MHz} \sim 14.010\text{MHz)} \\
 &= 29.54 \text{ dBuV/m} && 30\text{m} \\
 &= 29.54 + 20 \log(30/3)^2 && 3\text{m} \\
 &= 69.54 \text{ dBuV/m} && 3\text{m}
 \end{aligned}$$

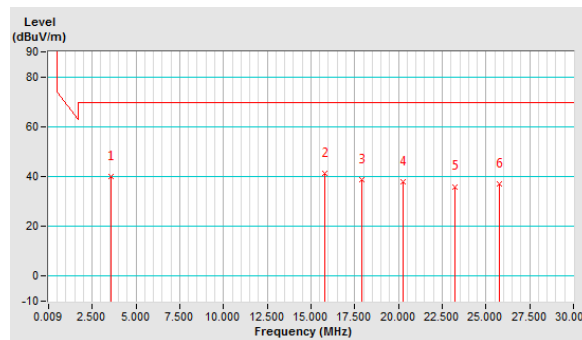

NO.	Frequency (MHz)	Emission Level (dBuV/m)	Limit (dBuV)	Margin
1	3.55	0	29.5	-29.5
2	15.78	1.4	29.5	-28.1
3	17.88	-1.3	29.5	-30.8
4	20.28	-2	29.5	-31.5
5	23.22	-4	29.5	-33.5
6	25.74	-2.8	29.5	-32.3

EUT Test Condition		Measurement Detail	
Channel	Channel 1	Frequency Range	Below 1000 MHz
Input Power	120 Vac, 60 Hz	Detector Function	Quasi-Peak or Peak
Environmental Conditions	23 deg. C, 66 % RH	Tested By	TitanHSU

Antenna Polarity & Test Distance: Horizontal at 3 m								
NO.	Freq. (MHz)	Emission Level (dBuV/m)	Limit (dBuV/m)	Margin (dB)	Antenna Height (m)	Table Angle (Degree)	Raw Value (dBuV)	Correction Factor (dB/m)
1	49.40	33.1 QP	40.0	-6.9	1.00 H	322	42.1	-9.0
2	103.73	37.0 QP	43.5	-6.5	1.00 H	353	49.5	-12.5
3	158.05	33.0 QP	43.5	-10.5	1.00 H	359	41.6	-8.6
4	272.52	29.3 QP	46.0	-16.7	2.00 H	5	37.5	-8.2
5	307.45	36.4 QP	46.0	-9.6	1.00 H	308	43.5	-7.1
6	625.64	34.0 QP	46.0	-12.0	1.00 H	322	32.6	1.4

Remarks:

1. Emission Level(dBuV/m) = Raw Value(dBuV) + Correction Factor(dB/m)
2. Margin value = Emission level – Limit value.
3. The other emission levels were very low against the limit.
4. Correction Factor(dB/m) = Antenna Factor(dB/m) + Cable Factor(dB) – Pre-Amplifier Factor (dB)

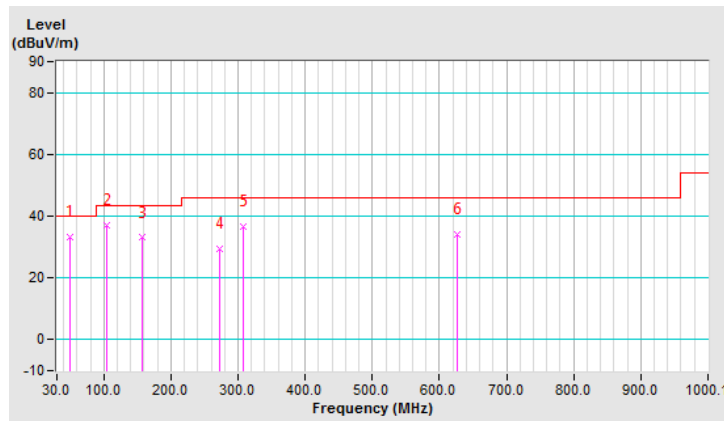

EUT Test Condition		Measurement Detail	
Channel	Channel 1	Frequency Range	Below 1000 MHz
Input Power	120 Vac, 60 Hz	Detector Function	Quasi-Peak or Peak
Environmental Conditions	23 deg. C, 66 % RH	Tested By	TitanHSU

Antenna Polarity & Test Distance: Vertical at 3 m								
NO.	Freq. (MHz)	Emission Level (dBuV/m)	Limit (dBuV/m)	Margin (dB)	Antenna Height (m)	Table Angle (Degree)	Raw Value (dBuV)	Correction Factor (dB/m)
1	64.92	26.6 QP	40.0	-13.4	1.49 V	16	36.7	-10.1
2	107.61	28.8 QP	43.5	-14.7	1.00 V	244	40.8	-12.0
3	295.81	25.4 QP	46.0	-20.6	1.49 V	60	33.0	-7.6
4	493.71	30.7 QP	46.0	-15.3	1.49 V	168	32.4	-1.7
5	516.99	32.1 QP	46.0	-13.9	1.00 V	7	33.1	-1.0
6	695.49	31.3 QP	46.0	-14.7	1.49 V	16	29.4	1.9

Remarks:

1. Emission Level(dBuV/m) = Raw Value(dBuV) + Correction Factor(dB/m)
2. Margin value = Emission level – Limit value.
3. The other emission levels were very low against the limit.
4. Correction Factor(dB/m) = Antenna Factor(dB/m) + Cable Factor(dB) – Pre-Amplifier Factor (dB)

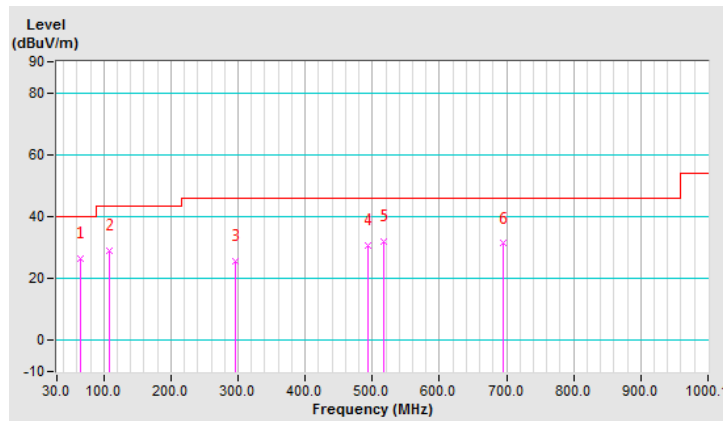

**Type B**

EUT Test Condition		Measurement Detail	
Channel	Channel 1	Frequency Range	13.553 ~ 13.567 MHz
Input Power	120 Vac, 60 Hz	Detector Function	Quasi-Peak
Environmental Conditions	23 deg. C, 66 % RH	Tested By	TitanHSU

Antenna Polarity & Test Distance: Loop Antenna Parallel at 3 m								
NO.	Freq. (MHz)	Emission Level (dBuV/m)	Limit (dBuV/m)	Margin (dB)	Antenna Height (m)	Table Angle (Degree)	Raw Value (dBuV)	Correction Factor (dB/m)
1	*13.56	44.5 QP	124 QP	-79.5	1.00 V	232	22.7	21.8

Remarks:

1. Emission level (dBuV/m) = Raw Value (dBuV) + Factor (dB/m)
2. Correction Factor(dB/m) = Antenna Factor(dB/m) + Cable Factor(dB) – Pre-Amplifier Factor(dB)
3. The other emission levels were very low against the limit.
4. Margin value = Emission level – Limit value.
5. Above limits have been translated by the formula

The measured field strength was extrapolated to distance 30 meters, using the formula that the limit of field strength varies as the inverse distance square (40dB per decade of distance)

Example:

$$\begin{aligned}
 13.56 \text{ MHz} &= 15848 \text{ uV/m} && 30\text{m} \\
 &= 84 \text{ dBuV/m} && 30\text{m} \\
 &= 84+20\log(30/3)^2 && 3\text{m} \\
 &= 124 \text{ dBuV/m}
 \end{aligned}$$

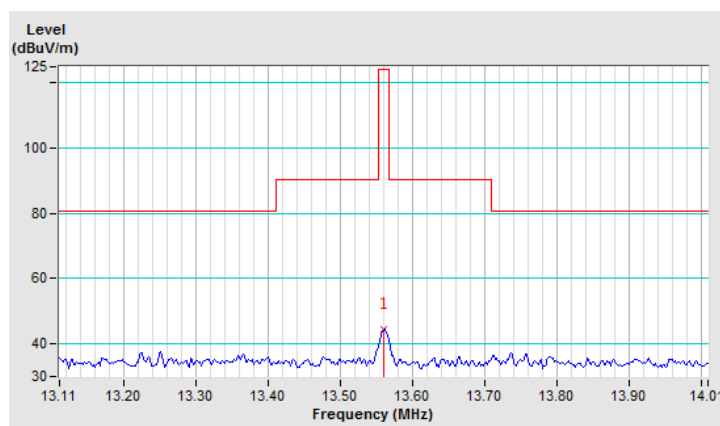

Antenna Polarity & Test Distance: Loop Antenna Parallel at 30 m				
NO.	Frequency (MHz)	Emission Level (dBuV/m)	Limit (dBuV/m)	Margin (dB)
1	*13.56	4.5 QP	84 QP	-79.5

Remarks: Emission Level at 30m = Emission Level at 3m + 20log(3/30)<sup>2</sup>

EUT Test Condition		Measurement Detail	
Channel	Channel 1	Frequency Range	13.553 ~ 13.567 MHz
Input Power	120 Vac, 60 Hz	Detector Function	Quasi-Peak
Environmental Conditions	23 deg. C, 66 % RH	Tested By	TitanHSU

Antenna Polarity & Test Distance: Loop Antenna Perpendicular at 3 m								
NO.	Freq. (MHz)	Emission Level (dBuV/m)	Limit (dBuV/m)	Margin (dB)	Antenna Height (m)	Table Angle (Degree)	Raw Value (dBuV)	Correction Factor (dB/m)
1	*13.56	42.2 QP	124 QP	-81.8	1.00 V	130	20.4	21.8

Remarks:

1. Emission level (dBuV/m) = Raw Value (dBuV) + Factor (dB/m)
2. Correction Factor(dB/m) = Antenna Factor(dB/m) + Cable Factor(dB) – Pre-Amplifier Factor(dB)
3. The other emission levels were very low against the limit.
4. Margin value = Emission level – Limit value.
5. Above limits have been translated by the formula

The measured field strength was extrapolated to distance 30 meters, using the formula that the limit of field strength varies as the inverse distance square (40dB per decade of distance)

Example:

$$\begin{aligned}
 13.56 \text{ MHz} &= 15848 \text{ uV/m} && 30\text{m} \\
 &= 84 \text{ dBuV/m} && 30\text{m} \\
 &= 84 + 20\log(30/3)^2 && 3\text{m} \\
 &= 124 \text{ dBuV/m}
 \end{aligned}$$

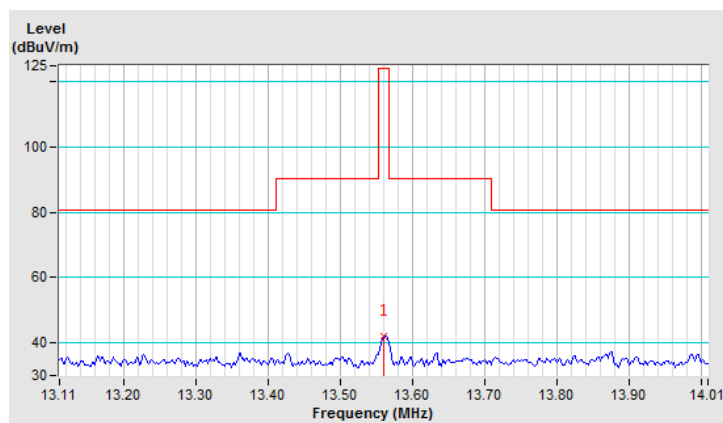

Antenna Polarity & Test Distance: Loop Antenna Perpendicular at 30 m				
NO.	Frequency (MHz)	Emission Level (dBuV/m)	Limit (dBuV/m)	Margin (dB)
1	*13.56	2.2 QP	84 QP	-81.8

Remarks: Emission Level at 30m = Emission Level at 3m + 20log(3/30)<sup>2</sup>



EUT Test Condition		Measurement Detail	
Channel	Channel 1	Frequency Range	13.553 ~ 13.567 MHz
Input Power	120 Vac, 60 Hz	Detector Function	Quasi-Peak
Environmental Conditions	23 deg. C, 66 % RH	Tested By	TitanHSU

Antenna Polarity & Test Distance: Loop Antenna Ground-Parallel Parallel at 3 m								
NO.	Freq. (MHz)	Emission Level (dBuV/m)	Limit (dBuV/m)	Margin (dB)	Antenna Height (m)	Table Angle (Degree)	Raw Value (dBuV)	Correction Factor (dB/m)
1	*13.56	38.7 QP	124 QP	-85.3	1.00 V	83	16.9	21.8

Remarks:

1. Emission level (dBuV/m) = Raw Value (dBuV) + Factor (dB/m)
2. Correction Factor(dB/m) = Antenna Factor(dB/m) + Cable Factor(dB) – Pre-Amplifier Factor(dB)
3. The other emission levels were very low against the limit.
4. Margin value = Emission level – Limit value.
5. Above limits have been translated by the formula

The measured field strength was extrapolated to distance 30 meters, using the formula that the limit of field strength varies as the inverse distance square (40dB per decade of distance)

Example:

$$\begin{aligned}
 13.56 \text{ MHz} &= 15848 \text{ uV/m} && 30\text{m} \\
 &= 84 \text{ dBuV/m} && 30\text{m} \\
 &= 84 + 20\log(30/3)^2 && 3\text{m} \\
 &= 124 \text{ dBuV/m}
 \end{aligned}$$

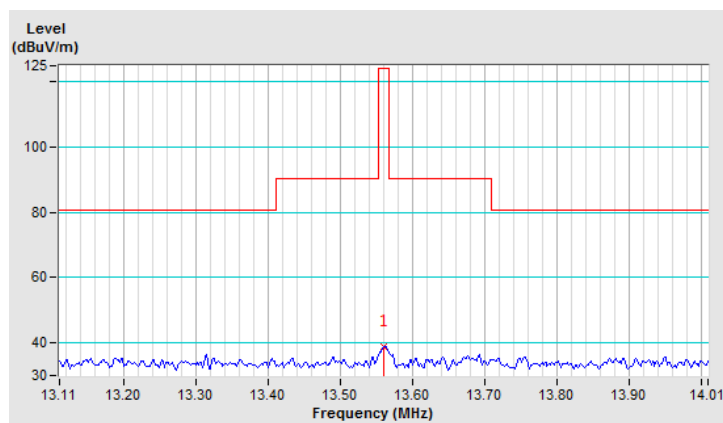

Antenna Polarity & Test Distance: Loop Antenna Ground-parallel at 30 m				
NO.	Frequency (MHz)	Emission Level (dBuV/m)	Limit (dBuV/m)	Margin (dB)
1	*13.56	-1.3 QP	124 QP	-85.3

Remarks: Emission Level at 30m = Emission Level at 3m + 20log(3/30)<sup>2</sup>

EUT Test Condition		Measurement Detail	
Channel	Channel 1	Frequency Range	Below 30 MHz
Input Power	120 Vac, 60 Hz	Detector Function	Quasi-Peak
Environmental Conditions	23 deg. C, 66 % RH	Tested By	TitanHSU

Antenna Polarity & Test Distance: Loop Antenna Parallel at 3 m								
NO.	Freq. (MHz)	Emission Level (dBuV/m)	Limit (dBuV/m)	Margin (dB)	Antenna Height (m)	Table Angle (Degree)	Raw Value (dBuV)	Correction Factor (dB/m)
1	3.13	43.1 QP	69.5	-26.4	1.00 V	270	23.2	19.9
2	10.51	40.9 QP	69.5	-28.6	1.00 V	213	19.2	21.7
3	11.59	42.0 QP	69.5	-27.5	1.00 V	250	20.3	21.7
4	15.78	45.7 QP	69.5	-23.8	1.00 V	246	23.8	21.9
5	16.86	43.5 QP	69.5	-26.0	1.00 V	217	21.5	22.0
<b>6</b>	<b>18.96</b>	<b>46.0 QP</b>	<b>69.5</b>	<b>-23.5</b>	<b>1.00 V</b>	<b>301</b>	<b>24.0</b>	<b>22.0</b>

Remarks:

1. Emission level (dBuV/m) = Raw Value (dBuV) + Factor (dB/m)
2. Correction Factor(dB/m) = Antenna Factor(dB/m) + Cable Factor(dB)
3. The other emission levels were very low against the limit.
4. Margin value = Emission level – Limit value.

The measured field strength was extrapolated to distance 30 meters, using the formula that the limit of field strength varies as the inverse distance square (40dB per decade of distance)

Example:

$$\begin{aligned}
 1.705 \text{ MHz} \sim 30 \text{ MHz} &= 30 \text{ uV/m} && 30\text{m} \text{ (except 13.110MHz} \sim 14.010\text{MHz)} \\
 &= 29.54 \text{ dBuV/m} && 30\text{m} \\
 &= 29.54 + 20 \log(30/3)^2 && 3\text{m} \\
 &= 69.54 \text{ dBuV/m} && 3\text{m}
 \end{aligned}$$

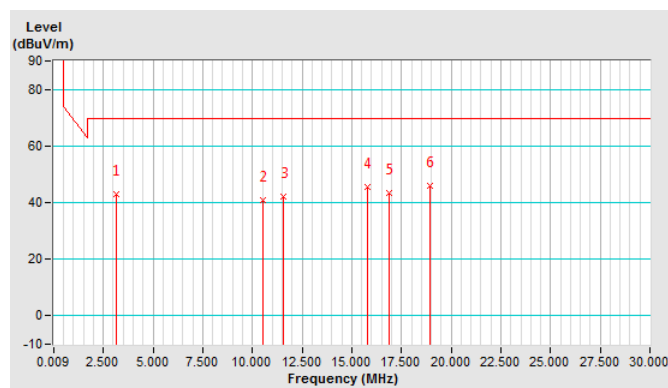

NO.	Frequency (MHz)	Emission Level (dBuV/m)	Limit (dBuV)	Margin
1	3.13	3.1	29.5	-26.4
2	10.51	0.9	29.5	-28.6
3	11.59	2	29.5	-27.5
4	15.78	5.7	29.5	-23.8
5	16.86	3.5	29.5	-26
6	18.96	6	29.5	-23.5

EUT Test Condition		Measurement Detail	
Channel	Channel 1	Frequency Range	Below 30 MHz
Input Power	120 Vac, 60 Hz	Detector Function	Quasi-Peak
Environmental Conditions	23 deg. C, 66 % RH	Tested By	TitanHSU

Antenna Polarity & Test Distance: Loop Antenna Perpendicular at 3 m								
NO.	Freq. (MHz)	Emission Level (dBuV/m)	Limit (dBuV/m)	Margin (dB)	Antenna Height (m)	Table Angle (Degree)	Raw Value (dBuV)	Correction Factor (dB/m)
1	3.13	44.9 QP	69.5	-24.6	1.00 V	350	25.0	19.9
2	12.61	40.6 QP	69.5	-28.9	1.00 V	55	18.8	21.8
3	15.78	42.4 QP	69.5	-27.1	1.00 V	10	20.5	21.9
4	17.88	41.2 QP	69.5	-28.3	1.00 V	322	19.2	22.0
5	18.96	43.7 QP	69.5	-25.8	1.00 V	53	21.7	22.0
6	20.04	43.3 QP	69.5	-26.2	1.00 V	179	21.2	22.1

Remarks:

1. Emission level (dBuV/m) = Raw Value (dBuV) + Factor (dB/m)
2. Correction Factor(dB/m) = Antenna Factor(dB/m) + Cable Factor(dB) – Pre-Amplifier Factor(dB)
3. The other emission levels were very low against the limit.
4. Margin value = Emission level – Limit value.

The measured field strength was extrapolated to distance 30 meters, using the formula that the limit of field strength varies as the inverse distance square (40dB per decade of distance)

Example:

$$\begin{aligned}
 1.705 \text{ MHz} \sim 30 \text{ MHz} &= 30 \text{ uV/m} && 30\text{m} \quad (\text{except } 13.110\text{MHz} \sim 14.010\text{MHz}) \\
 &= 29.54 \text{ dBuV/m} && 30\text{m} \\
 &= 29.54 + 20 \log(30/3)^2 && 3\text{m} \\
 &= 69.54 \text{ dBuV/m} && 3\text{m}
 \end{aligned}$$

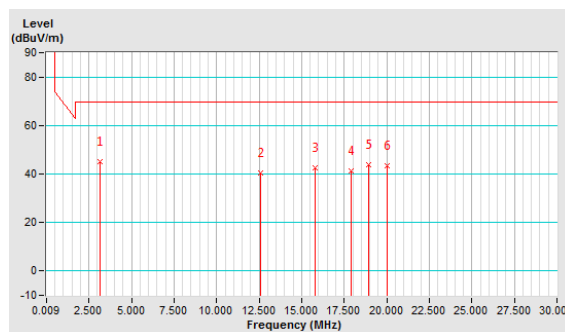

NO.	Frequency (MHz)	Emission Level (dBuV/m)	Limit (dBuV)	Margin
1	3.13	4.9	29.5	-24.6
2	12.61	0.6	29.5	-28.9
3	15.78	2.4	29.5	-27.1
4	17.88	1.2	29.5	-28.3
5	18.96	3.7	29.5	-25.8
6	20.04	3.3	29.5	-26.2

EUT Test Condition		Measurement Detail	
Channel	Channel 1	Frequency Range	Below 30 MHz
Input Power	120 Vac, 60 Hz	Detector Function	Quasi-Peak
Environmental Conditions	23 deg. C, 66 % RH	Tested By	TitanHSU

Antenna Polarity & Test Distance: Loop Antenna Ground-parallel at 3 m								
NO.	Freq. (MHz)	Emission Level (dBuV/m)	Limit (dBuV/m)	Margin (dB)	Antenna Height (m)	Table Angle (Degree)	Raw Value (dBuV)	Correction Factor (dB/m)
1	3.55	40.3 QP	69.5	-29.2	1.00 V	303	20.3	20.0
2	5.23	36.8 QP	69.5	-32.7	1.00 V	329	16.6	20.2
3	7.39	35.4 QP	69.5	-34.1	1.00 V	21	14.6	20.8
4	17.88	39.1 QP	69.5	-30.4	1.00 V	223	17.1	22.0
5	18.96	41.5 QP	69.5	-28.0	1.00 V	320	19.5	22.0
6	23.10	39.4 QP	69.5	-30.1	1.00 V	129	17.3	22.1

Remarks:

- Emission level (dBuV/m) = Raw Value (dBuV) + Factor (dB/m)
- Correction Factor(dB/m) = Antenna Factor(dB/m) + Cable Factor(dB) – Pre-Amplifier Factor(dB)
- The other emission levels were very low against the limit.
- Margin value = Emission level – Limit value.

The measured field strength was extrapolated to distance 30 meters, using the formula that the limit of field strength varies as the inverse distance square (40dB per decade of distance)

Example:

$$\begin{aligned}
 1.705 \text{ MHz} \sim 30 \text{ MHz} &= 30 \text{ uV/m} && 30\text{m} \text{ (except 13.110MHz} \sim 14.010\text{MHz)} \\
 &= 29.54 \text{ dBuV/m} && 30\text{m} \\
 &= 29.54 + 20 \log(30/3)^2 && 3\text{m} \\
 &= 69.54 \text{ dBuV/m} && 3\text{m}
 \end{aligned}$$

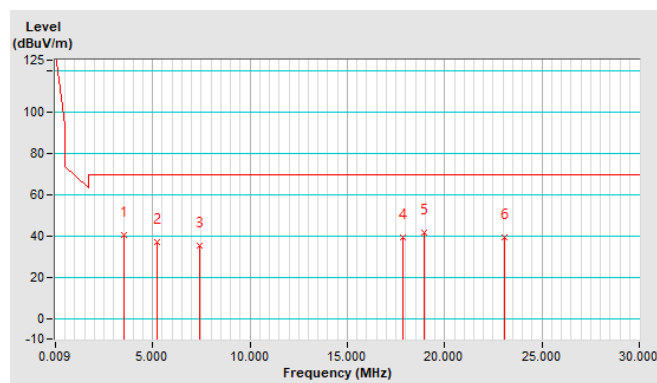

NO.	Frequency (MHz)	Emission Level (dBuV/m)	Limit (dBuV)	Margin
1	3.55	0.3	29.5	-29.2
2	5.23	-3.2	29.5	-32.7
3	7.39	-4.6	29.5	-34.1
4	17.88	-0.9	29.5	-30.4
5	18.96	1.5	29.5	-28
6	23.1	-0.6	29.5	-30.1

EUT Test Condition		Measurement Detail	
Channel	Channel 1	Frequency Range	Below 1000 MHz
Input Power	120 Vac, 60 Hz	Detector Function	Quasi-Peak or Peak
Environmental Conditions	23 deg. C, 66 % RH	Tested By	TitanHSU

Antenna Polarity & Test Distance: Horizontal at 3 m								
NO.	Freq. (MHz)	Emission Level (dBuV/m)	Limit (dBuV/m)	Margin (dB)	Antenna Height (m)	Table Angle (Degree)	Raw Value (dBuV)	Correction Factor (dB/m)
1	64.92	24.8 QP	40.0	-15.2	1.50 H	83	34.9	-10.1
2	105.67	31.7 QP	43.5	-11.8	1.00 H	1	44.0	-12.3
3	198.80	30.2 QP	43.5	-13.3	1.00 H	272	41.2	-11.0
4	255.06	39.3 QP	46.0	-6.7	2.00 H	300	48.3	-9.0
5	332.67	35.7 QP	46.0	-10.3	1.50 H	300	42.1	-6.4
6	383.12	31.9 QP	46.0	-14.1	1.00 H	3	37.0	-5.1

Remarks:

1. Emission Level(dBuV/m) = Raw Value(dBuV) + Correction Factor(dB/m)
2. Margin value = Emission level – Limit value.
3. The other emission levels were very low against the limit.
4. Correction Factor(dB/m) = Antenna Factor(dB/m) + Cable Factor(dB) – Pre-Amplifier Factor (dB)

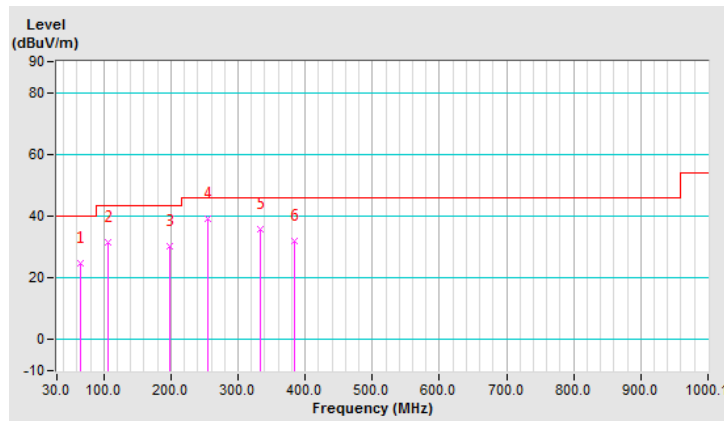

EUT Test Condition		Measurement Detail	
Channel	Channel 1	Frequency Range	Below 1000 MHz
Input Power	120 Vac, 60 Hz	Detector Function	Quasi-Peak or Peak
Environmental Conditions	23 deg. C, 66 % RH	Tested By	TitanHSU

Antenna Polarity & Test Distance: Vertical at 3 m								
NO.	Freq. (MHz)	Emission Level (dBuV/m)	Limit (dBuV/m)	Margin (dB)	Antenna Height (m)	Table Angle (Degree)	Raw Value (dBuV)	Correction Factor (dB/m)
1	111.49	32.8 QP	43.5	-10.7	2.00 V	265	44.6	-11.8
2	134.77	25.3 QP	43.5	-18.2	1.00 V	145	34.8	-9.5
3	229.84	33.1 QP	46.0	-12.9	1.00 V	274	43.4	-10.3
4	247.30	29.4 QP	46.0	-16.6	1.50 V	8	38.7	-9.3
5	311.33	26.0 QP	46.0	-20.0	2.00 V	334	33.0	-7.0
6	439.38	35.2 QP	46.0	-10.8	1.00 V	269	38.0	-2.8

Remarks:

1. Emission Level(dBuV/m) = Raw Value(dBuV) + Correction Factor(dB/m)
2. Margin value = Emission level – Limit value.
3. The other emission levels were very low against the limit.
4. Correction Factor(dB/m) = Antenna Factor(dB/m) + Cable Factor(dB) – Pre-Amplifier Factor (dB)

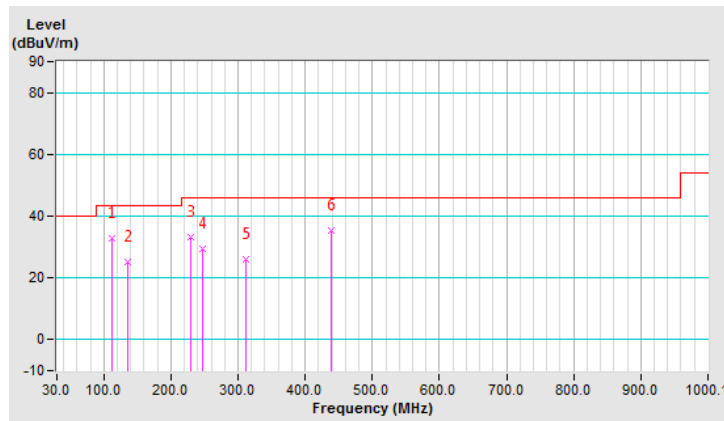

**Type F**

EUT Test Condition		Measurement Detail	
Channel	Channel 1	Frequency Range	13.553 ~ 13.567 MHz
Input Power	120 Vac, 60 Hz	Detector Function	Quasi-Peak
Environmental Conditions	23 deg. C, 66 % RH	Tested By	TitanHSU

Antenna Polarity & Test Distance: Loop Antenna Parallel at 3 m								
NO.	Freq. (MHz)	Emission Level (dBuV/m)	Limit (dBuV/m)	Margin (dB)	Antenna Height (m)	Table Angle (Degree)	Raw Value (dBuV)	Correction Factor (dB/m)
1	*13.56	42.5 QP	124 QP	81.5	1.00 V	236	20.7	21.8

Remarks:

1. Emission level (dBuV/m) = Raw Value (dBuV) + Factor (dB/m)
2. Correction Factor(dB/m) = Antenna Factor(dB/m) + Cable Factor(dB) – Pre-Amplifier Factor(dB)
3. The other emission levels were very low against the limit.
4. Margin value = Emission level – Limit value.
5. Above limits have been translated by the formula

The measured field strength was extrapolated to distance 30 meters, using the formula that the limit of field strength varies as the inverse distance square (40dB per decade of distance)

Example:

$$\begin{aligned}
 13.56 \text{ MHz} &= 15848 \text{ uV/m} && 30\text{m} \\
 &= 84 \text{ dBuV/m} && 30\text{m} \\
 &= 84+20\log(30/3)^2 && 3\text{m} \\
 &= 124 \text{ dBuV/m}
 \end{aligned}$$

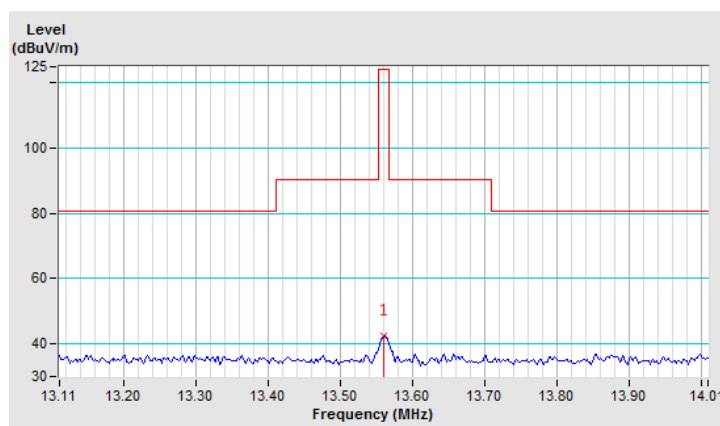

Antenna Polarity & Test Distance: Loop Antenna Parallel at 30 m				
NO.	Frequency (MHz)	Emission Level (dBuV/m)	Limit (dBuV/m)	Margin (dB)
1	*13.56	2.5 QP	84 QP	-81.5

Remarks: Emission Level at 30m = Emission Level at 3m + 20log(3/30)<sup>2</sup>

EUT Test Condition		Measurement Detail	
Channel	Channel 1	Frequency Range	13.553 ~ 13.567 MHz
Input Power	120 Vac, 60 Hz	Detector Function	Quasi-Peak
Environmental Conditions	23 deg. C, 66 % RH	Tested By	TitanHSU

Antenna Polarity & Test Distance: Loop Antenna Perpendicular at 3 m								
NO.	Freq. (MHz)	Emission Level (dBuV/m)	Limit (dBuV/m)	Margin (dB)	Antenna Height (m)	Table Angle (Degree)	Raw Value (dBuV)	Correction Factor (dB/m)
1	*13.56	39.7 QP	124 QP	-84.3	1.00 V	129	17.9	21.8

Remarks:

1. Emission level (dBuV/m) = Raw Value (dBuV) + Factor (dB/m)
2. Correction Factor(dB/m) = Antenna Factor(dB/m) + Cable Factor(dB) – Pre-Amplifier Factor(dB)
3. The other emission levels were very low against the limit.
4. Margin value = Emission level – Limit value.
5. Above limits have been translated by the formula

The measured field strength was extrapolated to distance 30 meters, using the formula that the limit of field strength varies as the inverse distance square (40dB per decade of distance)

Example:

$$\begin{aligned}
 13.56 \text{ MHz} &= 15848 \text{ uV/m} && 30\text{m} \\
 &= 84 \text{ dBuV/m} && 30\text{m} \\
 &= 84 + 20\log(30/3)^2 && 3\text{m} \\
 &= 124 \text{ dBuV/m}
 \end{aligned}$$

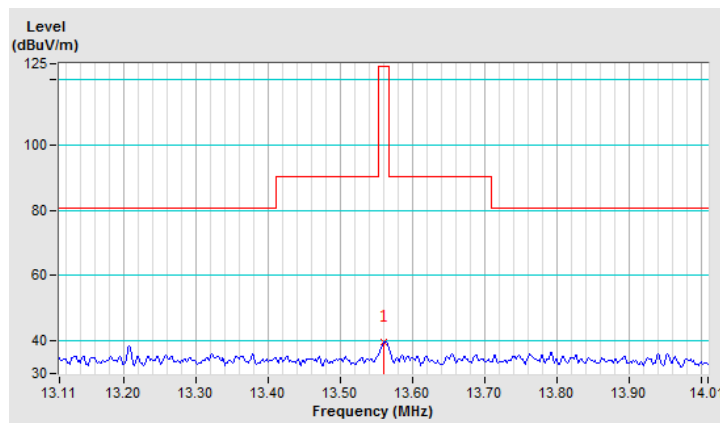

Antenna Polarity & Test Distance: Loop Antenna Perpendicular at 30 m				
NO.	Frequency (MHz)	Emission Level (dBuV/m)	Limit (dBuV/m)	Margin (dB)
1	*13.56	-0.3 QP	84 QP	-84.3

Remarks: Emission Level at 30m = Emission Level at 3m + 20log(3/30)<sup>2</sup>



EUT Test Condition		Measurement Detail	
Channel	Channel 1	Frequency Range	13.553 ~ 13.567 MHz
Input Power	120 Vac, 60 Hz	Detector Function	Quasi-Peak
Environmental Conditions	23 deg. C, 66 % RH	Tested By	TitanHSU

Antenna Polarity & Test Distance: Loop Antenna Ground-Parallel Parallel at 3 m								
NO.	Freq. (MHz)	Emission Level (dBuV/m)	Limit (dBuV/m)	Margin (dB)	Antenna Height (m)	Table Angle (Degree)	Raw Value (dBuV)	Correction Factor (dB/m)
1	*13.56	38.8 QP	124 QP	-85.2	1.00 V	88	17.0	21.8

Remarks:

1. Emission level (dBuV/m) = Raw Value (dBuV) + Factor (dB/m)
2. Correction Factor(dB/m) = Antenna Factor(dB/m) + Cable Factor(dB) – Pre-Amplifier Factor(dB)
3. The other emission levels were very low against the limit.
4. Margin value = Emission level – Limit value.
5. Above limits have been translated by the formula

The measured field strength was extrapolated to distance 30 meters, using the formula that the limit of field strength varies as the inverse distance square (40dB per decade of distance)

Example:

$$\begin{aligned}
 13.56 \text{ MHz} &= 15848 \text{ uV/m} && 30\text{m} \\
 &= 84 \text{ dBuV/m} && 30\text{m} \\
 &= 84 + 20\log(30/3)^2 && 3\text{m} \\
 &= 124 \text{ dBuV/m}
 \end{aligned}$$

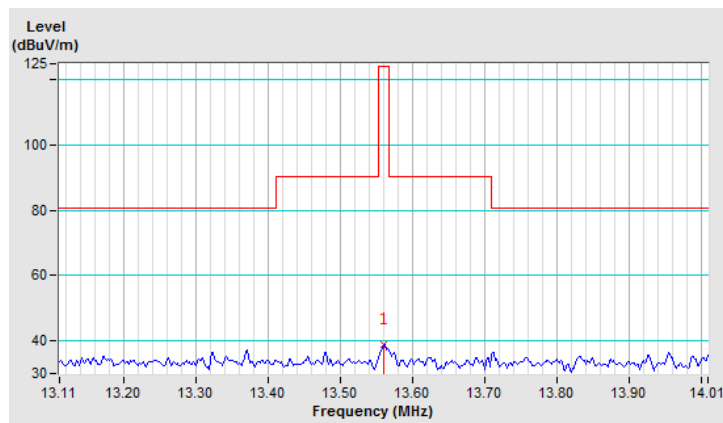

Antenna Polarity & Test Distance: Loop Antenna Ground-parallel at 30 m				
NO.	Frequency (MHz)	Emission Level (dBuV/m)	Limit (dBuV/m)	Margin (dB)
1	*13.56	-1.2 QP	84 QP	-85.2

Remarks: Emission Level at 30m = Emission Level at 3m + 20log(3/30)<sup>2</sup>

EUT Test Condition		Measurement Detail	
Channel	Channel 1	Frequency Range	Below 30 MHz
Input Power	120 Vac, 60 Hz	Detector Function	Quasi-Peak
Environmental Conditions	23 deg. C, 66 % RH	Tested By	TitanHSU

Antenna Polarity & Test Distance: Loop Antenna Parallel at 3 m								
NO.	Freq. (MHz)	Emission Level (dBuV/m)	Limit (dBuV/m)	Margin (dB)	Antenna Height (m)	Table Angle (Degree)	Raw Value (dBuV)	Correction Factor (dB/m)
1	3.55	45.2 QP	69.5	-24.3	1.00 V	260	25.2	20.0
2	12.61	44.7 QP	69.5	-24.8	1.00 V	322	22.9	21.8
3	16.86	41.3 QP	69.5	-28.2	1.00 V	201	19.3	22.0
4	<b>18.96</b>	<b>45.5 QP</b>	<b>69.5</b>	<b>-24.0</b>	<b>1.00 V</b>	<b>141</b>	<b>23.5</b>	<b>22.0</b>
5	23.10	39.4 QP	69.5	-30.1	1.00 V	107	17.3	22.1
6	26.88	37.3 QP	69.5	-32.2	1.00 V	26	15.1	22.2

Remarks:

1. Emission level (dBuV/m) = Raw Value (dBuV) + Factor (dB/m)
2. Correction Factor(dB/m) = Antenna Factor(dB/m) + Cable Factor(dB)
3. The other emission levels were very low against the limit.
4. Margin value = Emission level – Limit value.

The measured field strength was extrapolated to distance 30 meters, using the formula that the limit of field strength varies as the inverse distance square (40dB per decade of distance)

Example:

$$\begin{aligned}
 1.705 \text{ MHz} \sim 30 \text{ MHz} &= 30 \text{ uV/m} && 30\text{m} \text{ (except 13.110MHz} \sim 14.010\text{MHz)} \\
 &= 29.54 \text{ dBuV/m} && 30\text{m} \\
 &= 29.54 + 20 \log(30/3)^2 && 3\text{m} \\
 &= 69.54 \text{ dBuV/m} && 3\text{m}
 \end{aligned}$$

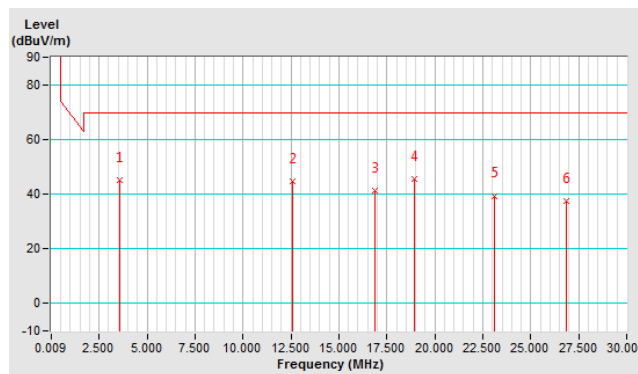

NO.	Frequency (MHz)	Emission Level (dBuV/m)	Limit (dBuV)	Margin
1	3.55	5.2	29.5	-24.3
2	12.61	4.7	29.5	-24.8
3	16.86	1.3	29.5	-28.2
4	18.96	5.5	29.5	-24
5	23.1	-0.6	29.5	-30.1
6	26.88	-2.7	29.5	-32.2

EUT Test Condition		Measurement Detail	
Channel	Channel 1	Frequency Range	Below 30 MHz
Input Power	120 Vac, 60 Hz	Detector Function	Quasi-Peak
Environmental Conditions	23 deg. C, 66 % RH	Tested By	TitanHSU

Antenna Polarity & Test Distance: Loop Antenna Perpendicular at 3 m								
NO.	Freq. (MHz)	Emission Level (dBuV/m)	Limit (dBuV/m)	Margin (dB)	Antenna Height (m)	Table Angle (Degree)	Raw Value (dBuV)	Correction Factor (dB/m)
1	3.13	44.5 QP	69.5	-25.0	1.00 V	183	24.6	19.9
2	12.61	43.1 QP	69.5	-26.4	1.00 V	91	21.3	21.8
3	15.78	42.2 QP	69.5	-27.3	1.00 V	257	20.3	21.9
4	16.86	42.7 QP	69.5	-26.8	1.00 V	241	20.7	22.0
5	17.88	41.2 QP	69.5	-28.3	1.00 V	302	19.2	22.0
6	23.10	39.1 QP	69.5	-30.4	1.00 V	0	17.0	22.1

Remarks:

- Emission level (dBuV/m) = Raw Value (dBuV) + Factor (dB/m)
- Correction Factor(dB/m) = Antenna Factor(dB/m) + Cable Factor(dB) – Pre-Amplifier Factor(dB)
- The other emission levels were very low against the limit.
- Margin value = Emission level – Limit value.

The measured field strength was extrapolated to distance 30 meters, using the formula that the limit of field strength varies as the inverse distance square (40dB per decade of distance)

Example:

$$\begin{aligned}
 1.705 \text{ MHz} \sim 30 \text{ MHz} &= 30 \text{ uV/m} && 30\text{m} \text{ (except 13.110MHz} \sim 14.010\text{MHz)} \\
 &= 29.54 \text{ dBuV/m} && 30\text{m} \\
 &= 29.54 + 20 \log(30/3)^2 && 3\text{m} \\
 &= 69.54 \text{ dBuV/m} && 3\text{m}
 \end{aligned}$$

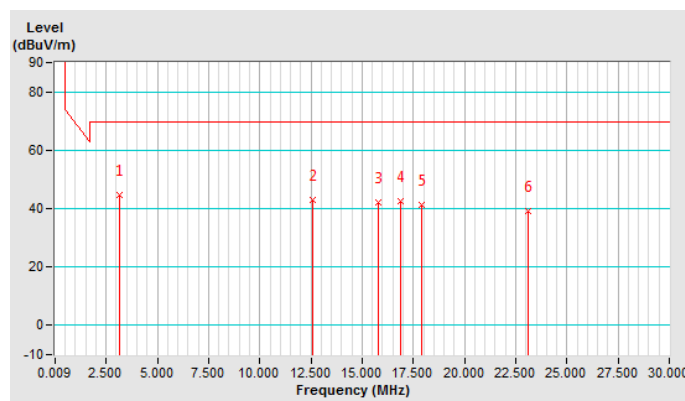

NO.	Frequency (MHz)	Emission Level (dBuV/m)	Limit (dBuV)	Margin
1	3.13	4.5	29.5	-25
2	12.61	3.1	29.5	-26.4
3	15.78	2.2	29.5	-27.3
4	16.86	2.7	29.5	-26.8
5	17.88	1.2	29.5	-28.3
6	23.1	-0.9	29.5	-30.4

EUT Test Condition		Measurement Detail	
Channel	Channel 1	Frequency Range	Below 30 MHz
Input Power	120 Vac, 60 Hz	Detector Function	Quasi-Peak
Environmental Conditions	23 deg. C, 66 % RH	Tested By	TitanHSU

Antenna Polarity & Test Distance: Loop Antenna Ground-parallel at 3 m								
NO.	Freq. (MHz)	Emission Level (dBuV/m)	Limit (dBuV/m)	Margin (dB)	Antenna Height (m)	Table Angle (Degree)	Raw Value (dBuV)	Correction Factor (dB/m)
1	3.13	41.7 QP	69.5	-27.8	1.00 V	340	21.8	19.9
2	15.78	40.7 QP	69.5	-28.8	1.00 V	349	18.8	21.9
3	16.86	38.9 QP	69.5	-30.6	1.00 V	18	16.9	22.0
4	18.48	40.2 QP	69.5	-29.3	1.00 V	274	18.2	22.0
5	18.96	42.0 QP	69.5	-27.5	1.00 V	259	20.0	22.0
6	23.10	39.4 QP	69.5	-30.1	1.00 V	180	17.3	22.1

Remarks:

1. Emission level (dBuV/m) = Raw Value (dBuV) + Factor (dB/m)
2. Correction Factor(dB/m) = Antenna Factor(dB/m) + Cable Factor(dB) – Pre-Amplifier Factor(dB)
3. The other emission levels were very low against the limit.
4. Margin value = Emission level – Limit value.

The measured field strength was extrapolated to distance 30 meters, using the formula that the limit of field strength varies as the inverse distance square (40dB per decade of distance)

Example:

$$\begin{aligned}
 1.705 \text{ MHz} \sim 30 \text{ MHz} &= 30 \text{ uV/m} && 30\text{m} \text{ (except 13.110MHz} \sim 14.010\text{MHz)} \\
 &= 29.54 \text{ dBuV/m} && 30\text{m} \\
 &= 29.54 + 20 \log(30/3)^2 && 3\text{m} \\
 &= 69.54 \text{ dBuV/m} && 3\text{m}
 \end{aligned}$$

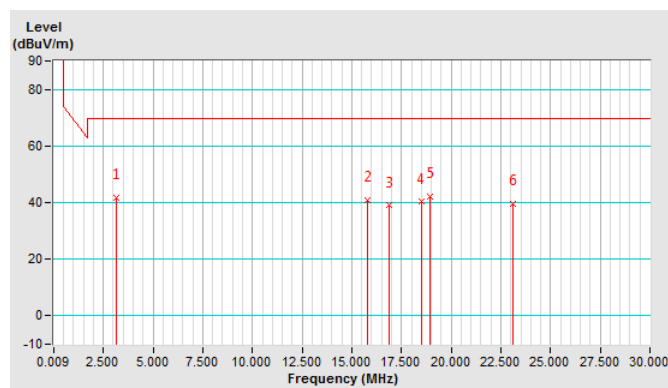

NO.	Frequency (MHz)	Emission Level (dBuV/m)	Limit (dBuV)	Margin
1	3.13	1.7	29.5	-27.8
2	15.78	0.7	29.5	-28.8
3	16.86	-1.1	29.5	-30.6
4	18.48	0.2	29.5	-29.3
5	18.96	2	29.5	-27.5
6	23.1	-0.6	29.5	-30.1

EUT Test Condition		Measurement Detail	
Channel	Channel 1	Frequency Range	Below 1000 MHz
Input Power	120 Vac, 60 Hz	Detector Function	Quasi-Peak or Peak
Environmental Conditions	23 deg. C, 66 % RH	Tested By	TitanHSU

Antenna Polarity & Test Distance: Horizontal at 3 m								
NO.	Freq. (MHz)	Emission Level (dBuV/m)	Limit (dBuV/m)	Margin (dB)	Antenna Height (m)	Table Angle (Degree)	Raw Value (dBuV)	Correction Factor (dB/m)
1	70.74	25.8 QP	40.0	-14.2	1.00 H	10	37.0	-11.2
2	86.27	23.6 QP	40.0	-16.4	1.50 H	40	37.5	-13.9
3	109.55	30.3 QP	43.5	-13.2	2.00 H	8	42.2	-11.9
4	233.72	27.3 QP	46.0	-18.7	1.50 H	10	37.4	-10.1
5	369.54	27.6 QP	46.0	-18.4	1.50 H	10	33.1	-5.5
6	416.10	28.8 QP	46.0	-17.2	1.00 H	9	32.6	-3.8

Remarks:

1. Emission Level(dBuV/m) = Raw Value(dBuV) + Correction Factor(dB/m)
2. Margin value = Emission level – Limit value.
3. The other emission levels were very low against the limit.
4. Correction Factor(dB/m) = Antenna Factor(dB/m) + Cable Factor(dB) – Pre-Amplifier Factor (dB)

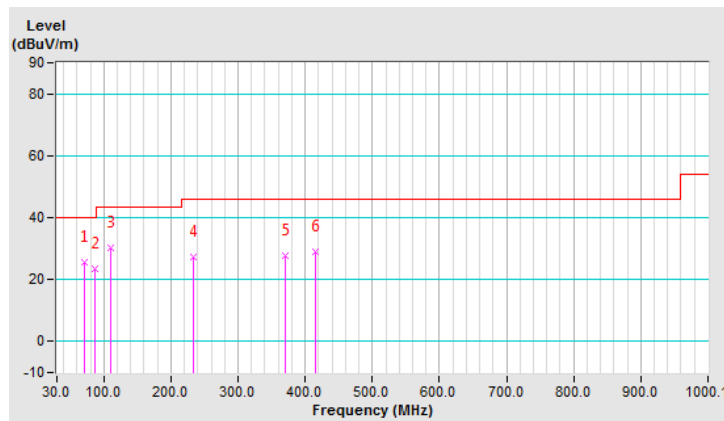

EUT Test Condition		Measurement Detail	
Channel	Channel 1	Frequency Range	Below 1000 MHz
Input Power	120 Vac, 60 Hz	Detector Function	Quasi-Peak or Peak
Environmental Conditions	23 deg. C, 66 % RH	Tested By	TitanHSU

Antenna Polarity & Test Distance: Vertical at 3 m								
NO.	Freq. (MHz)	Emission Level (dBuV/m)	Limit (dBuV/m)	Margin (dB)	Antenna Height (m)	Table Angle (Degree)	Raw Value (dBuV)	Correction Factor (dB/m)
1	62.98	30.1 QP	40.0	-9.9	2.00 V	299	39.7	-9.6
2	76.56	30.4 QP	40.0	-9.6	1.50 V	358	43.0	-12.6
3	148.35	37.3 QP	43.5	-6.2	2.00 V	299	46.1	-8.8
4	518.93	31.5 QP	46.0	-14.5	1.50 V	297	32.5	-1.0
5	639.22	38.1 QP	46.0	-7.9	1.00 V	1	36.6	1.5
6	773.10	33.5 QP	46.0	-12.5	1.50 V	19	30.6	2.9

Remarks:

1. Emission Level(dBuV/m) = Raw Value(dBuV) + Correction Factor(dB/m)
2. Margin value = Emission level – Limit value.
3. The other emission levels were very low against the limit.
4. Correction Factor(dB/m) = Antenna Factor(dB/m) + Cable Factor(dB) – Pre-Amplifier Factor (dB)

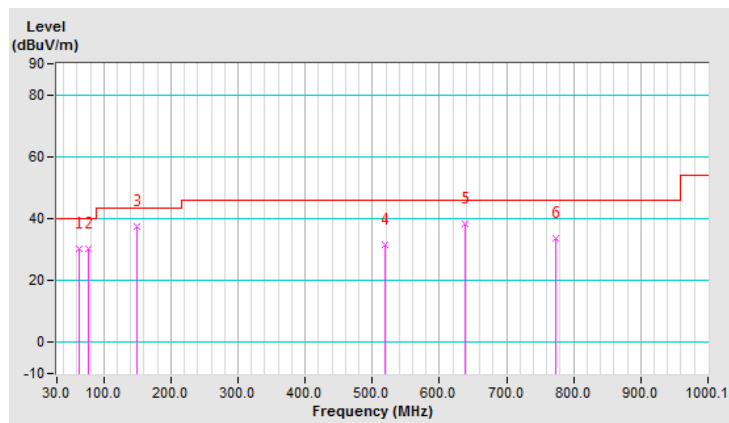

## 4.2 Conducted Emission Measurement

### 4.2.1 Limits of Conducted Emission Measurement

Frequency (MHz)	Conducted Limit (dBuV)	
	Quasi-Peak	Average
0.15 - 0.5	66 - 56	56 - 46
0.50 - 5.0	56	46
5.0 - 30.0	60	50

Note:

1. The lower limit shall apply at the transition frequencies.
2. The limit decreases in line with the logarithm of the frequency in the range of 0.15 to 0.50 MHz.
3. All emanations from a class A/B digital device or system, including any network of conductors and apparatus connected thereto, shall not exceed the level of field strengths specified above.

### 4.2.2 Test Instruments

Description & Manufacturer	Model No.	Serial No.	Date of Calibration	Due Date of Calibration
Test Receiver ROHDE & SCHWARZ	ESCI	100613	Dec. 10, 2018	Dec. 09, 2019
RF signal cable (with 10dB PAD) Woken	5D-FB	Cable-cond1-01	Sep. 05, 2019	Sep. 04, 2020
LISN/AMN ROHDE & SCHWARZ (EUT)	ESH3-Z5	835239/001	Mar. 17, 2019	Mar. 16, 2020
LISN/AMN ROHDE & SCHWARZ (Peripheral)	ENV216	101196	Apr. 16, 2019	Apr. 15, 2020
Software ADT	BV ADT_Cond_ V7.3.7.3	NA	NA	NA

- Note: 1. The calibration interval of the above test instruments is 12 months and the calibrations are traceable to NML/ROC and NIST/USA.
2. The test was performed in HwaYa Shielded Room 1.
  3. The VCCI Site Registration No. is C-12040.

#### 4.2.3 Test Procedures

- a. The EUT was placed 0.4 meters from the conducting wall of the shielded room with EUT being connected to the power mains through a line impedance stabilization network (LISN). Other support units were connected to the power mains through another LISN. The two LISNs provide 50 ohm/50 uH of coupling impedance for the measuring instrument.
- b. Both lines of the power mains connected to the EUT were checked for maximum conducted interference.
- c. The frequency range from 150 kHz to 30 MHz was searched. Emission levels under (Limit – 20 dB) was not recorded.

**Note:** The resolution bandwidth and video bandwidth of test receiver is 9 kHz for quasi-peak detection (QP) and average detection (AV) at frequency 0.15 MHz - 30 MHz.

#### 4.2.4 Deviation from Test Standard

No deviation.

#### 4.2.5 Test Setup

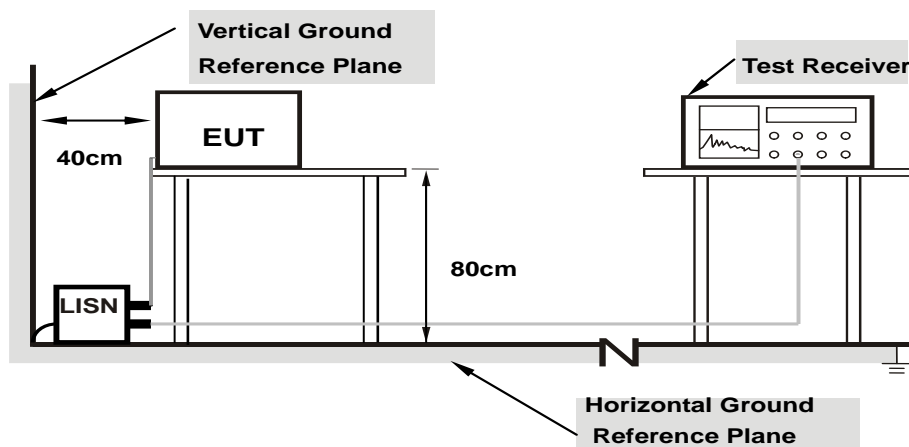

- Note:**
1. Support units were connected to second LISN.
  2. Both of LISNs (AMN) are 80 cm from EUT and at least 80 cm from other units and other metal planes

For the actual test configuration, please refer to the attached file (Test Setup Photo).

#### 4.2.6 EUT Operating Conditions

- a. Placed the EUT on the testing table.
- b. Set the EUT under transmission condition continuously at specific channel frequency.



#### 4.2.7 Test Results

##### Mode A

##### Type A

<b>Frequency Range</b>	150kHz ~ 30MHz	<b>Detector Function &amp; Resolution Bandwidth</b>	Quasi-Peak (QP) / Average (AV), 9kHz
<b>Input Power</b>	120Vac, 60Hz	<b>Environmental Conditions</b>	23°C, 66%RH
<b>Tested by</b>	Titan HSU	<b>Test Date</b>	2019/11/18

Phase Of Power : Line (L)										
No	Frequency (MHz)	Correction Factor (dB)	Reading Value (dBuV)		Emission Level (dBuV)		Limit (dBuV)		Margin (dB)	
			Q.P.	AV.	Q.P.	AV.	Q.P.	AV.	Q.P.	AV.
1	0.16093	10.11	37.11	20.44	47.22	30.55	65.42	55.42	-18.20	-24.87
2	0.18510	10.12	33.70	16.80	43.82	26.92	64.25	54.25	-20.43	-27.33
3	0.66261	10.19	25.23	16.92	35.42	27.11	56.00	46.00	-20.58	-18.89
4	5.04150	10.36	21.18	12.08	31.54	22.44	60.00	50.00	-28.46	-27.56
5	11.27175	10.45	24.07	16.47	34.52	26.92	60.00	50.00	-25.48	-23.08
6	13.56000	10.49	28.58	27.80	39.07	38.29	60.00	50.00	-20.93	-11.71

#### Remarks:

1. Q.P. and AV. are abbreviations of quasi-peak and average individually.
2. The emission levels of other frequencies were very low against the limit.
3. Margin value = Emission level – Limit value
4. Correction factor = Insertion loss + Cable loss
5. Emission Level = Correction Factor + Reading Value

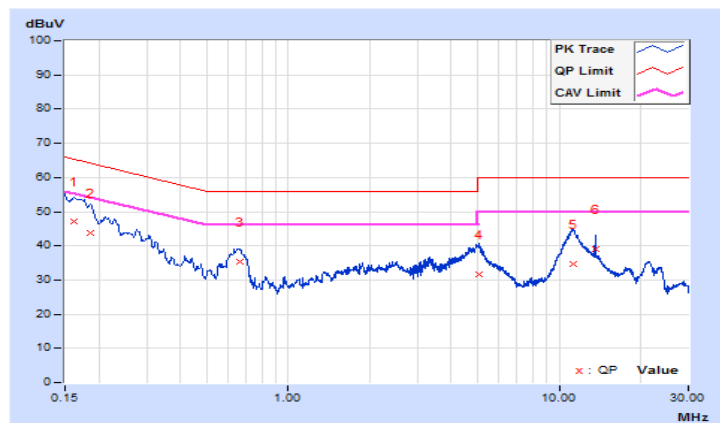

<b>Frequency Range</b>	150kHz ~ 30MHz	<b>Detector Function &amp; Resolution Bandwidth</b>	Quasi-Peak (QP) / Average (AV), 9kHz
<b>Input Power</b>	120Vac, 60Hz	<b>Environmental Conditions</b>	23°C, 66%RH
<b>Tested by</b>	Titan HSU	<b>Test Date</b>	2019/11/18

Phase Of Power : Neutral (N)										
No	Frequency (MHz)	Correction Factor (dB)	Reading Value (dBuV)		Emission Level (dBuV)		Limit (dBuV)		Margin (dB)	
			Q.P.	AV.	Q.P.	AV.	Q.P.	AV.	Q.P.	AV.
1	0.15225	10.16	38.22	21.42	48.38	31.58	65.88	55.88	-17.50	-24.30
2	0.17838	10.17	34.19	17.09	44.36	27.26	64.56	54.56	-20.20	-27.30
3	0.65912	10.25	24.56	16.82	34.81	27.07	56.00	46.00	-21.19	-18.93
4	11.74425	10.59	21.51	15.16	32.10	25.75	60.00	50.00	-27.90	-24.25
5	13.56000	10.62	26.99	26.68	37.61	37.30	60.00	50.00	-22.39	-12.70
6	24.40275	10.66	14.11	9.89	24.77	20.55	60.00	50.00	-35.23	-29.45

Remarks:

1. Q.P. and AV. are abbreviations of quasi-peak and average individually.
2. The emission levels of other frequencies were very low against the limit.
3. Margin value = Emission level – Limit value
4. Correction factor = Insertion loss + Cable loss
5. Emission Level = Correction Factor + Reading Value

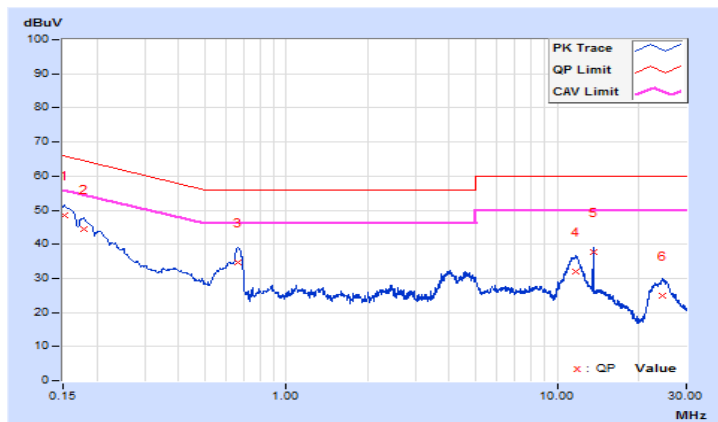

**Type B**

<b>Frequency Range</b>	150kHz ~ 30MHz	<b>Detector Function &amp; Resolution Bandwidth</b>	Quasi-Peak (QP) / Average (AV), 9kHz
<b>Input Power</b>	120Vac, 60Hz	<b>Environmental Conditions</b>	23°C, 66%RH
<b>Tested by</b>	Titan HSU	<b>Test Date</b>	2019/11/18

Phase Of Power : Line (L)										
No	Frequency (MHz)	Correction Factor (dB)	Reading Value (dBuV)		Emission Level (dBuV)		Limit (dBuV)		Margin (dB)	
			Q.P.	AV.	Q.P.	AV.	Q.P.	AV.	Q.P.	AV.
1	0.15900	10.11	37.36	20.69	47.47	30.80	65.52	55.52	-18.05	-24.72
2	0.65175	10.19	25.22	18.61	35.41	28.80	56.00	46.00	-20.59	-17.20
3	4.97400	10.36	20.92	12.41	31.28	22.77	56.00	46.00	-24.72	-23.23
4	13.56000	10.49	24.77	23.30	35.26	33.79	60.00	50.00	-24.74	-16.21
5	22.04475	10.59	12.31	8.55	22.90	19.14	60.00	50.00	-37.10	-30.86
6	27.13650	10.46	6.07	2.66	16.53	13.12	60.00	50.00	-43.47	-36.88

Remarks:

1. Q.P. and AV. are abbreviations of quasi-peak and average individually.
2. The emission levels of other frequencies were very low against the limit.
3. Margin value = Emission level – Limit value
4. Correction factor = Insertion loss + Cable loss
5. Emission Level = Correction Factor + Reading Value

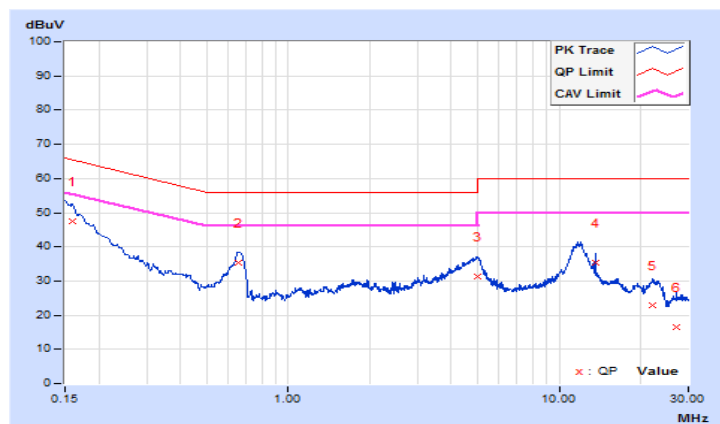

Frequency Range	150kHz ~ 30MHz	Detector Function & Resolution Bandwidth	Quasi-Peak (QP) / Average (AV), 9kHz
Input Power	120Vac, 60Hz	Environmental Conditions	23°C, 66%RH
Tested by	Titan HSU	Test Date	2019/11/18

Phase Of Power : Neutral (N)										
No	Frequency (MHz)	Correction Factor (dB)	Reading Value (dBuV)		Emission Level (dBuV)		Limit (dBuV)		Margin (dB)	
			Q.P.	AV.	Q.P.	AV.	Q.P.	AV.	Q.P.	AV.
1	0.15675	10.16	37.69	20.72	47.85	30.88	65.63	55.63	-17.78	-24.75
2	0.18559	10.17	33.01	15.59	43.18	25.76	64.23	54.23	-21.05	-28.47
3	0.66300	10.25	24.79	16.27	35.04	26.52	56.00	46.00	-20.96	-19.48
4	4.76244	10.44	13.11	5.95	23.55	16.39	56.00	46.00	-32.45	-29.61
5	13.56000	10.62	24.19	23.65	34.81	34.27	60.00	50.00	-25.19	-15.73
6	25.11600	10.64	12.31	8.41	22.95	19.05	60.00	50.00	-37.05	-30.95

Remarks:

1. Q.P. and AV. are abbreviations of quasi-peak and average individually.
2. The emission levels of other frequencies were very low against the limit.
3. Margin value = Emission level – Limit value
4. Correction factor = Insertion loss + Cable loss
5. Emission Level = Correction Factor + Reading Value

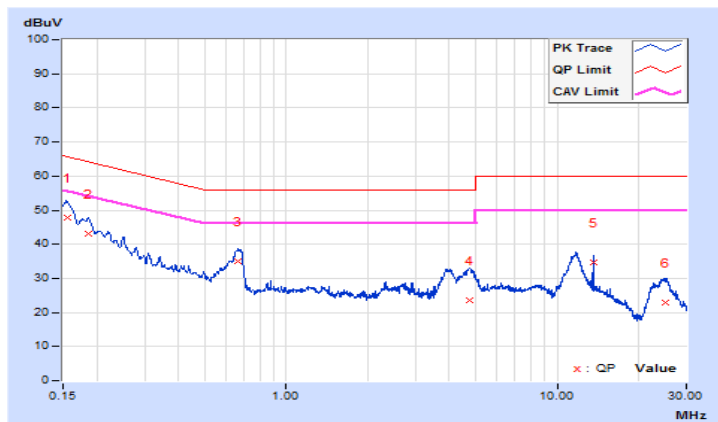

Type F

Frequency Range	150kHz ~ 30MHz	Detector Function & Resolution Bandwidth	Quasi-Peak (QP) / Average (AV), 9kHz
Input Power	120Vac, 60Hz	Environmental Conditions	23°C, 66%RH
Tested by	Titan HSU	Test Date	2019/11/18

Phase Of Power : Line (L)										
No	Frequency (MHz)	Correction Factor (dB)	Reading Value (dBuV)		Emission Level (dBuV)		Limit (dBuV)		Margin (dB)	
			Q.P.	AV.	Q.P.	AV.	Q.P.	AV.	Q.P.	AV.
1	0.15509	10.11	37.67	21.22	47.78	31.33	65.72	55.72	-17.94	-24.39
2	0.19275	10.12	29.52	10.59	39.64	20.71	63.92	53.92	-24.28	-33.21
3	0.65850	10.19	25.82	18.11	36.01	28.30	56.00	46.00	-19.99	-17.70
4	5.01225	10.36	20.69	11.84	31.05	22.20	60.00	50.00	-28.95	-27.80
5	13.56000	10.49	24.75	23.32	35.24	33.81	60.00	50.00	-24.76	-16.19
6	22.38450	10.58	10.60	6.75	21.18	17.33	60.00	50.00	-38.82	-32.67

Remarks:

1. Q.P. and AV. are abbreviations of quasi-peak and average individually.
2. The emission levels of other frequencies were very low against the limit.
3. Margin value = Emission level – Limit value
4. Correction factor = Insertion loss + Cable loss
5. Emission Level = Correction Factor + Reading Value

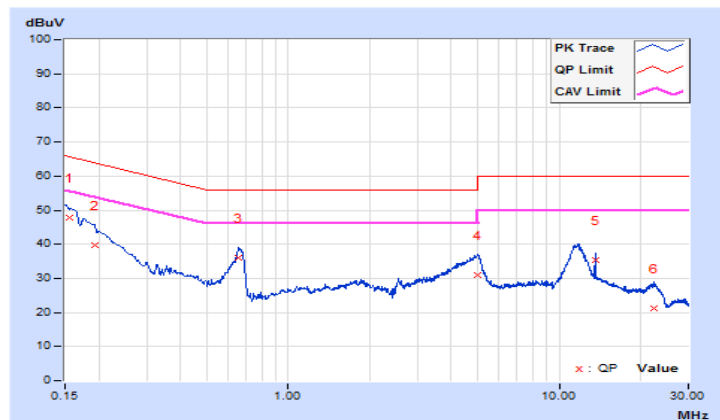

<b>Frequency Range</b>	150kHz ~ 30MHz	<b>Detector Function &amp; Resolution Bandwidth</b>	Quasi-Peak (QP) / Average (AV), 9kHz
<b>Input Power</b>	120Vac, 60Hz	<b>Environmental Conditions</b>	23°C, 66%RH
<b>Tested by</b>	Titan HSU	<b>Test Date</b>	2019/11/18

Phase Of Power : Neutral (N)										
No	Frequency (MHz)	Correction Factor (dB)	Reading Value (dBuV)		Emission Level (dBuV)		Limit (dBuV)		Margin (dB)	
			Q.P.	AV.	Q.P.	AV.	Q.P.	AV.	Q.P.	AV.
1	0.15225	10.16	37.57	20.79	47.73	30.95	65.88	55.88	-18.15	-24.93
2	0.18076	10.17	33.66	16.19	43.83	26.36	64.45	54.45	-20.62	-28.09
3	0.66612	10.25	24.96	16.55	35.21	26.80	56.00	46.00	-20.79	-19.20
4	3.81750	10.41	13.84	3.73	24.25	14.14	56.00	46.00	-31.75	-31.86
5	13.56000	10.62	24.22	23.65	34.84	34.27	60.00	50.00	-25.16	-15.73
6	24.17550	10.67	12.96	8.82	23.63	19.49	60.00	50.00	-36.37	-30.51

Remarks:

1. Q.P. and AV. are abbreviations of quasi-peak and average individually.
2. The emission levels of other frequencies were very low against the limit.
3. Margin value = Emission level – Limit value
4. Correction factor = Insertion loss + Cable loss
5. Emission Level = Correction Factor + Reading Value

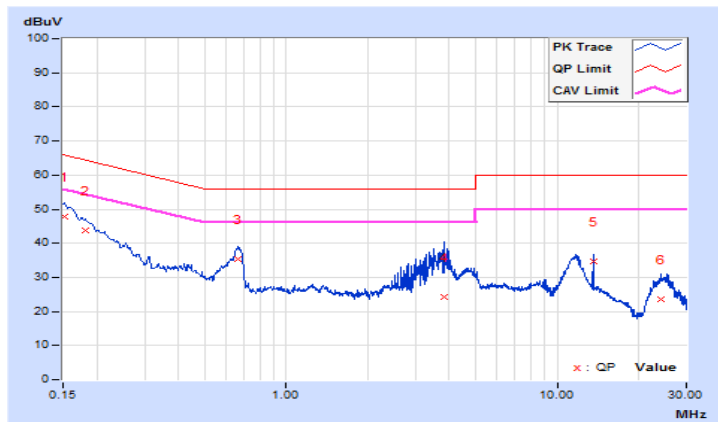

**Mode B**  
**Type A**

<b>Frequency Range</b>	150kHz ~ 30MHz	<b>Detector Function &amp; Resolution Bandwidth</b>	Quasi-Peak (QP) / Average (AV), 9kHz
<b>Input Power</b>	120Vac, 60Hz	<b>Environmental Conditions</b>	23°C, 66%RH
<b>Tested by</b>	Titan HSU	<b>Test Date</b>	2019/11/18

Phase Of Power : Line (L)										
No	Frequency (MHz)	Correction Factor (dB)	Reading Value (dBuV)		Emission Level (dBuV)		Limit (dBuV)		Margin (dB)	
			Q.P.	AV.	Q.P.	AV.	Q.P.	AV.	Q.P.	AV.
1	0.15509	10.11	39.26	22.89	49.37	33.00	65.72	55.72	-16.35	-22.72
2	0.20791	10.12	30.37	14.54	40.49	24.66	63.29	53.29	-22.80	-28.63
3	0.65175	10.19	27.21	20.95	37.40	31.14	56.00	46.00	-18.60	-14.86
4	4.98975	10.36	21.64	13.34	32.00	23.70	56.00	46.00	-24.00	-22.30
5	11.72400	10.46	26.87	19.50	37.33	29.96	60.00	50.00	-22.67	-20.04
<b>6</b>	<b>13.56000</b>	<b>10.49</b>	<b>30.29</b>	<b>29.74</b>	<b>40.78</b>	<b>40.23</b>	<b>60.00</b>	<b>50.00</b>	<b>-19.22</b>	<b>-9.77</b>

Remarks:

1. Q.P. and AV. are abbreviations of quasi-peak and average individually.
2. The emission levels of other frequencies were very low against the limit.
3. Margin value = Emission level – Limit value
4. Correction factor = Insertion loss + Cable loss
5. Emission Level = Correction Factor + Reading Value

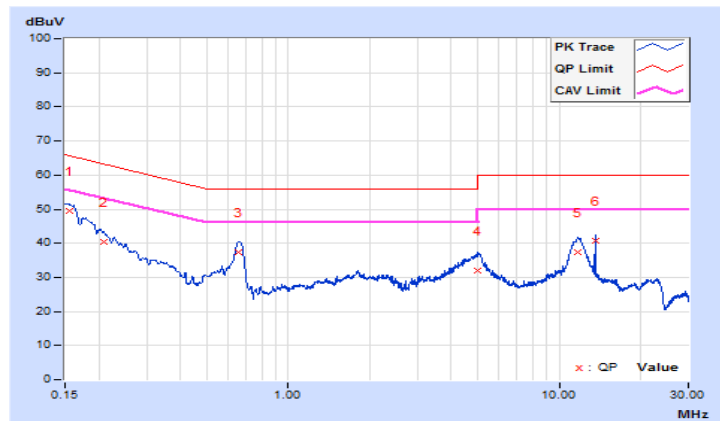

<b>Frequency Range</b>	150kHz ~ 30MHz	<b>Detector Function &amp; Resolution Bandwidth</b>	Quasi-Peak (QP) / Average (AV), 9kHz
<b>Input Power</b>	120Vac, 60Hz	<b>Environmental Conditions</b>	23°C, 66%RH
<b>Tested by</b>	Titan HSU	<b>Test Date</b>	2019/11/18

Phase Of Power : Neutral (N)										
No	Frequency (MHz)	Correction Factor (dB)	Reading Value (dBuV)		Emission Level (dBuV)		Limit (dBuV)		Margin (dB)	
			Q.P.	AV.	Q.P.	AV.	Q.P.	AV.	Q.P.	AV.
1	0.15225	10.16	39.50	21.81	49.66	31.97	65.88	55.88	-16.22	-23.91
2	0.34064	10.21	20.96	7.42	31.17	17.63	59.19	49.19	-28.02	-31.56
3	0.65175	10.25	26.27	20.13	36.52	30.38	56.00	46.00	-19.48	-15.62
4	3.98850	10.42	14.95	3.14	25.37	13.56	56.00	46.00	-30.63	-32.44
5	13.56000	10.62	28.85	28.51	39.47	39.13	60.00	50.00	-20.53	-10.87
6	23.81550	10.68	16.07	11.97	26.75	22.65	60.00	50.00	-33.25	-27.35

Remarks:

1. Q.P. and AV. are abbreviations of quasi-peak and average individually.
2. The emission levels of other frequencies were very low against the limit.
3. Margin value = Emission level – Limit value
4. Correction factor = Insertion loss + Cable loss
5. Emission Level = Correction Factor + Reading Value

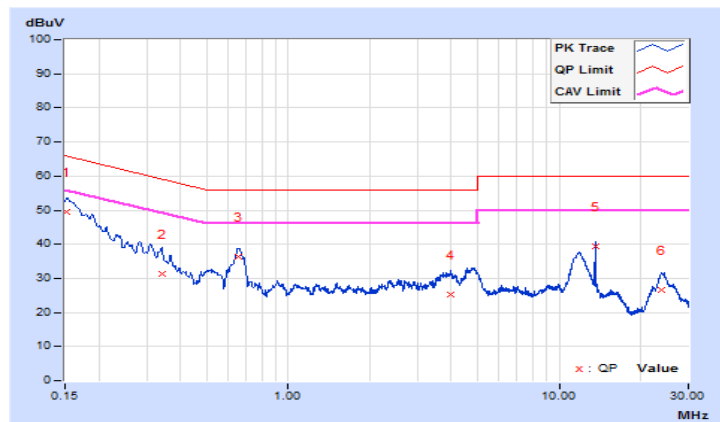



**Type B**

<b>Frequency Range</b>	150kHz ~ 30MHz	<b>Detector Function &amp; Resolution Bandwidth</b>	Quasi-Peak (QP) / Average (AV), 9kHz
<b>Input Power</b>	120Vac, 60Hz	<b>Environmental Conditions</b>	23°C, 66%RH
<b>Tested by</b>	Titan HSU	<b>Test Date</b>	2019/11/18

Phase Of Power : Line (L)										
No	Frequency (MHz)	Correction Factor (dB)	Reading Value (dBuV)		Emission Level (dBuV)		Limit (dBuV)		Margin (dB)	
			Q.P.	AV.	Q.P.	AV.	Q.P.	AV.	Q.P.	AV.
1	0.15900	10.11	38.83	22.51	48.94	32.62	65.52	55.52	-16.58	-22.90
2	0.65738	10.19	27.61	20.35	37.80	30.54	56.00	46.00	-18.20	-15.46
3	5.00100	10.36	23.35	15.14	33.71	25.50	60.00	50.00	-26.29	-24.50
4	11.62275	10.46	26.28	18.78	36.74	29.24	60.00	50.00	-23.26	-20.76
5	13.56000	10.49	30.17	29.60	40.66	40.09	60.00	50.00	-19.34	-9.91
6	23.15850	10.56	13.35	9.33	23.91	19.89	60.00	50.00	-36.09	-30.11

Remarks:

1. Q.P. and AV. are abbreviations of quasi-peak and average individually.
2. The emission levels of other frequencies were very low against the limit.
3. Margin value = Emission level – Limit value
4. Correction factor = Insertion loss + Cable loss
5. Emission Level = Correction Factor + Reading Value

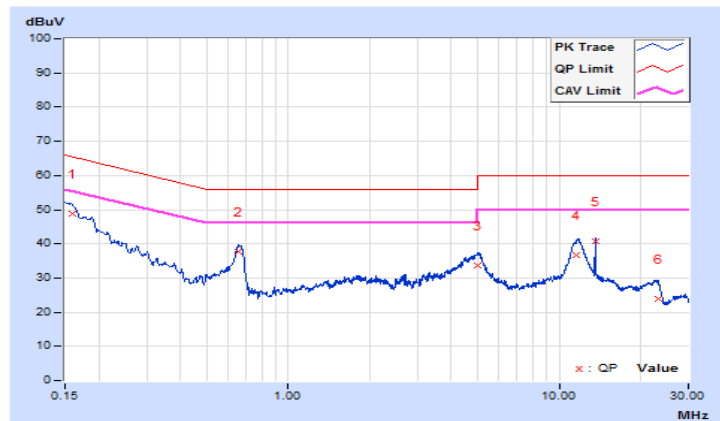

<b>Frequency Range</b>	150kHz ~ 30MHz	<b>Detector Function &amp; Resolution Bandwidth</b>	Quasi-Peak (QP) / Average (AV), 9kHz
<b>Input Power</b>	120Vac, 60Hz	<b>Environmental Conditions</b>	23°C, 66%RH
<b>Tested by</b>	Titan HSU	<b>Test Date</b>	2019/11/18

Phase Of Power : Neutral (N)										
No	Frequency (MHz)	Correction Factor (dB)	Reading Value (dBuV)		Emission Level (dBuV)		Limit (dBuV)		Margin (dB)	
			Q.P.	AV.	Q.P.	AV.	Q.P.	AV.	Q.P.	AV.
1	0.16093	10.16	38.28	21.42	48.44	31.58	65.42	55.42	-16.98	-23.84
2	0.65565	10.25	26.74	19.83	36.99	30.08	56.00	46.00	-19.01	-15.92
3	4.85025	10.44	14.18	6.37	24.62	16.81	56.00	46.00	-31.38	-29.19
4	11.71725	10.59	22.67	16.20	33.26	26.79	60.00	50.00	-26.74	-23.21
5	13.56000	10.62	24.57	24.05	35.19	34.67	60.00	50.00	-24.81	-15.33
6	23.81325	10.68	14.49	10.42	25.17	21.10	60.00	50.00	-34.83	-28.90

Remarks:

1. Q.P. and AV. are abbreviations of quasi-peak and average individually.
2. The emission levels of other frequencies were very low against the limit.
3. Margin value = Emission level – Limit value
4. Correction factor = Insertion loss + Cable loss
5. Emission Level = Correction Factor + Reading Value

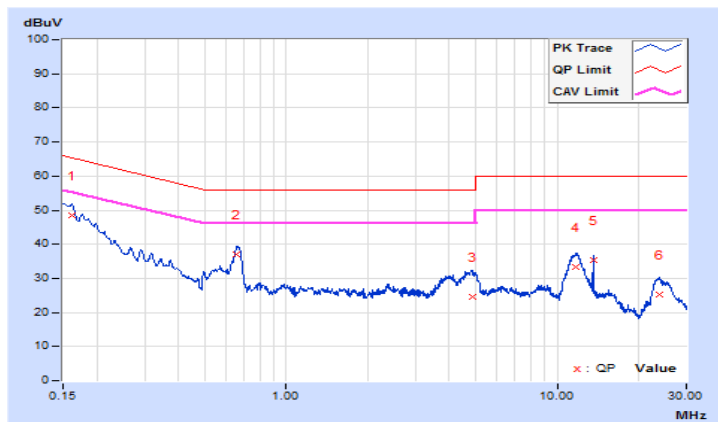

Type F

Frequency Range	150kHz ~ 30MHz	Detector Function & Resolution Bandwidth	Quasi-Peak (QP) / Average (AV), 9kHz
Input Power	120Vac, 60Hz	Environmental Conditions	23°C, 66%RH
Tested by	Titan HSU	Test Date	2019/11/18

Phase Of Power : Line (L)										
No	Frequency (MHz)	Correction Factor (dB)	Reading Value (dBuV)		Emission Level (dBuV)		Limit (dBuV)		Margin (dB)	
			Q.P.	AV.	Q.P.	AV.	Q.P.	AV.	Q.P.	AV.
1	0.15900	10.11	38.54	22.07	48.65	32.18	65.52	55.52	-16.87	-23.34
2	0.20572	10.12	30.72	14.39	40.84	24.51	63.38	53.38	-22.54	-28.87
3	0.66261	10.19	26.31	17.78	36.50	27.97	56.00	46.00	-19.50	-18.03
4	4.95375	10.36	21.64	13.01	32.00	23.37	56.00	46.00	-24.00	-22.63
5	11.62050	10.46	25.59	18.29	36.05	28.75	60.00	50.00	-23.95	-21.25
6	13.56000	10.49	25.22	23.88	35.71	34.37	60.00	50.00	-24.29	-15.63

Remarks:

1. Q.P. and AV. are abbreviations of quasi-peak and average individually.
2. The emission levels of other frequencies were very low against the limit.
3. Margin value = Emission level – Limit value
4. Correction factor = Insertion loss + Cable loss
5. Emission Level = Correction Factor + Reading Value

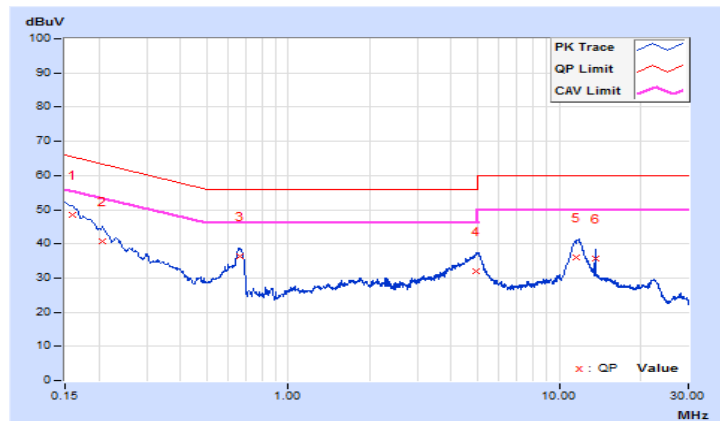

<b>Frequency Range</b>	150kHz ~ 30MHz	<b>Detector Function &amp; Resolution Bandwidth</b>	Quasi-Peak (QP) / Average (AV), 9kHz
<b>Input Power</b>	120Vac, 60Hz	<b>Environmental Conditions</b>	23°C, 66%RH
<b>Tested by</b>	Titan HSU	<b>Test Date</b>	2019/11/18

Phase Of Power : Neutral (N)										
No	Frequency (MHz)	Correction Factor (dB)	Reading Value (dBuV)		Emission Level (dBuV)		Limit (dBuV)		Margin (dB)	
			Q.P.	AV.	Q.P.	AV.	Q.P.	AV.	Q.P.	AV.
1	0.15966	10.16	38.62	21.77	48.78	31.93	65.48	55.48	-16.70	-23.55
2	0.66788	10.25	26.93	18.85	37.18	29.10	56.00	46.00	-18.82	-16.90
3	4.79850	10.44	13.60	6.18	24.04	16.62	56.00	46.00	-31.96	-29.38
4	11.77350	10.59	22.24	15.82	32.83	26.41	60.00	50.00	-27.17	-23.59
5	13.56000	10.62	24.52	24.07	35.14	34.69	60.00	50.00	-24.86	-15.31
6	24.01800	10.68	12.53	8.50	23.21	19.18	60.00	50.00	-36.79	-30.82

Remarks:

1. Q.P. and AV. are abbreviations of quasi-peak and average individually.
2. The emission levels of other frequencies were very low against the limit.
3. Margin value = Emission level – Limit value
4. Correction factor = Insertion loss + Cable loss
5. Emission Level = Correction Factor + Reading Value

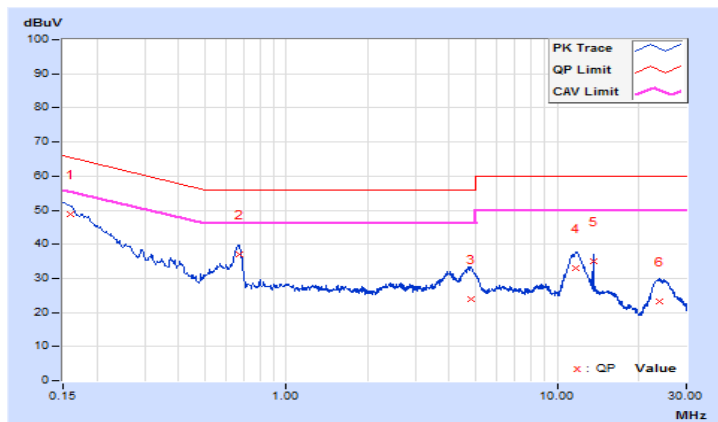

### 4.3 Frequency Stability

#### 4.3.1 Limits of Frequency Stability Measurement

The frequency tolerance of the carrier signal shall be maintained within +/- 0.01 % of the operating frequency over a temperature variation of -20 degrees to 50 degrees C at normal supply voltage, and for a variation in the primary supply voltage from 85 % to 115 % of the rated supply voltage at a temperature of 20 degrees C.

#### 4.3.2 Test Setup

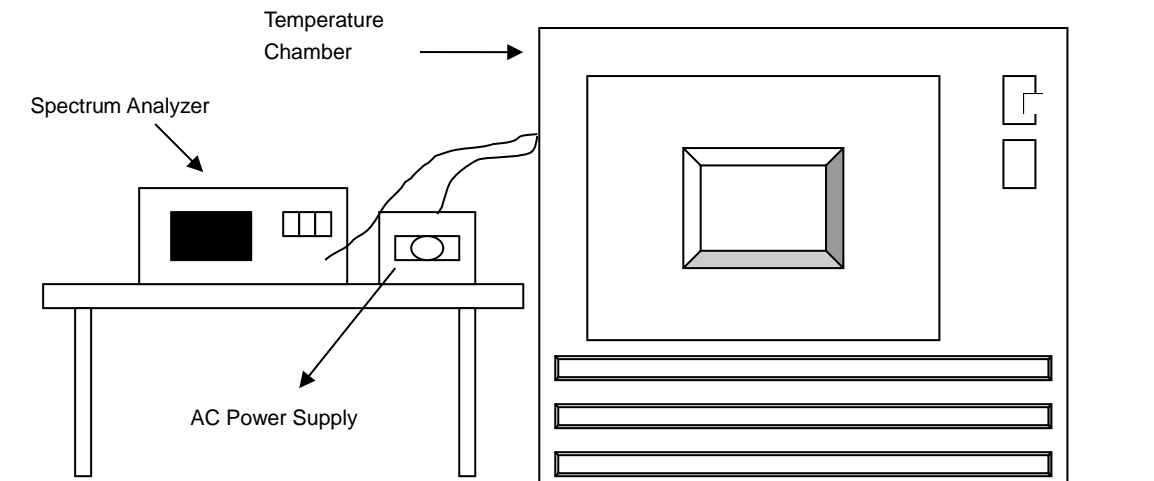

#### 4.3.3 Test Instruments

Refer to section 4.1.2 to get information of above instrument.

#### 4.3.4 Test Procedure

- The EUT was placed inside the environmental test chamber and powered by nominal AC voltage.
- Turned the EUT on and coupled its output to a spectrum analyzer.
- Turned the EUT off and set the chamber to the highest temperature specified.
- Allowed sufficient time (approximately 30 min) for the temperature of the chamber to stabilize then turned the EUT on and measured the operating frequency after 2, 5, and 10 minutes.
- Repeated step c and d with the every 10 degrees reduction until the lowest temperature achieved.
- The test chamber was allowed to stabilize at +20 degree C for a minimum of 30 minutes. The supply voltage was then adjusted on the EUT from 85 % to 115 % and the frequency record.

#### 4.3.5 Deviation from Test Standard

No deviation.

#### 4.3.6 EUT Operating Conditions

- Placed the EUT on the testing table.
- Set the EUT under transmission condition continuously at specific channel frequency.

#### 4.3.7 Test Results

##### Mode A

Frequency Stability Versus Temperature									
Temp. (°C)	Power Supply (Vac)	0 Minute		2 Minute		5 Minute		10 Minute	
		Measured Frequency	Frequency Drift	Measured Frequency	Frequency Drift	Measured Frequency	Frequency Drift	Measured Frequency	Frequency Drift
		(MHz)	%	(MHz)	%	(MHz)	%	(MHz)	%
50	120	13.55994	-0.00044	13.55994	-0.00044	13.55994	-0.00044	13.55994	-0.00044
40	120	13.56001	0.00007	13.56002	0.00015	13.56001	0.00007	13.56001	0.00007
30	120	13.56001	0.00007	13.56001	0.00007	13.56002	0.00015	13.56002	0.00015
20	120	13.56005	0.00037	13.56005	0.00037	13.56006	0.00044	13.56006	0.00044
10	120	13.55996	-0.00029	13.55996	-0.00029	13.55996	-0.00029	13.55996	-0.00029
0	120	13.56004	0.00029	13.56004	0.00029	13.56003	0.00022	13.56004	0.00029
-10	120	13.55996	-0.00029	13.55997	-0.00022	13.55996	-0.00029	13.55995	-0.00037
-20	120	13.55999	-0.00007	13.55999	-0.00007	13.55999	-0.00007	13.55999	-0.00007

Frequency Stability Versus Voltage									
Temp. (°C)	Power Supply (Vac)	0 Minute		2 Minute		5 Minute		10 Minute	
		Measured Frequency	Frequency Drift	Measured Frequency	Frequency Drift	Measured Frequency	Frequency Drift	Measured Frequency	Frequency Drift
		(MHz)	%	(MHz)	%	(MHz)	%	(MHz)	%
20	138	13.56005	0.00037	13.56005	0.00037	13.56006	0.00044	13.56006	0.00044
	120	13.56005	0.00037	13.56005	0.00037	13.56006	0.00044	13.56006	0.00044
	102	13.56005	0.00037	13.56005	0.00037	13.56006	0.00044	13.56006	0.00044

**Mode B**

Frequency Stability Versus Temperature									
Temp. (°C)	Power Supply (Vac)	0 Minute		2 Minute		5 Minute		10 Minute	
		Measured Frequency	Frequency Drift	Measured Frequency	Frequency Drift	Measured Frequency	Frequency Drift	Measured Frequency	Frequency Drift
		(MHz)	%	(MHz)	%	(MHz)	%	(MHz)	%
50	120	13.55998	-0.00015	13.56	0.00000	13.56	0.00000	13.55999	-0.00007
40	120	13.56005	0.00037	13.56005	0.00037	13.56005	0.00037	13.56005	0.00037
30	120	13.55995	-0.00037	13.55996	-0.00029	13.55996	-0.00029	13.55996	-0.00029
20	120	13.55995	-0.00037	13.55995	-0.00037	13.55994	-0.00044	13.55995	-0.00037
10	120	13.55994	-0.00044	13.55995	-0.00037	13.55994	-0.00044	13.55994	-0.00044
0	120	13.55994	-0.00044	13.55994	-0.00044	13.55994	-0.00044	13.55994	-0.00044
-10	120	13.56004	0.00029	13.56004	0.00029	13.56004	0.00029	13.56004	0.00029
-20	120	13.55997	-0.00022	13.55998	-0.00015	13.55997	-0.00022	13.55997	-0.00022

Frequency Stability Versus Voltage									
Temp. (°C)	Power Supply (Vac)	0 Minute		2 Minute		5 Minute		10 Minute	
		Measured Frequency	Frequency Drift	Measured Frequency	Frequency Drift	Measured Frequency	Frequency Drift	Measured Frequency	Frequency Drift
		(MHz)	%	(MHz)	%	(MHz)	%	(MHz)	%
20	138	13.55995	-0.00037	13.55995	-0.00037	13.55994	-0.00044	13.55995	-0.00037
	120	13.55995	-0.00037	13.55995	-0.00037	13.55994	-0.00044	13.55995	-0.00037
	102	13.55995	-0.00037	13.55995	-0.00037	13.55994	-0.00044	13.55995	-0.00037

#### **4.4 20 dB Bandwidth**

##### 4.4.1 Limits of 20 dB Bandwidth Measurement

The 20 dB bandwidth shall be specified in operating frequency band.

##### 4.4.2 Test Setup

Refer to section 4.1.5.

##### 4.4.3 Test Instruments

Refer to section 4.1.2 to get information of above instrument.

##### 4.4.4 Test Procedures

The bandwidth of the fundamental frequency was measured by spectrum analyzer with 1 kHz RBW and 3 kHz VBW. The 20 dB bandwidth is defined as the total spectrum the power of which is higher than peak power minus 20 dB.

##### 4.4.5 Deviation from Test Standard

No deviation.

##### 4.4.6 EUT Operating Conditions

- a. Placed the EUT on the testing table.
- b. Set the EUT under transmission condition continuously at specific channel frequency.



4.4.7 Test Results

Mode A

Type A

20 dBc Point (Low)	20 dBc Point (High)	Operating Frequency Band (MHz)	20 dBc Bandwidth (kHz)	Pass / Fail
13.55876	13.5614	13.553~13.567	2.64	Pass

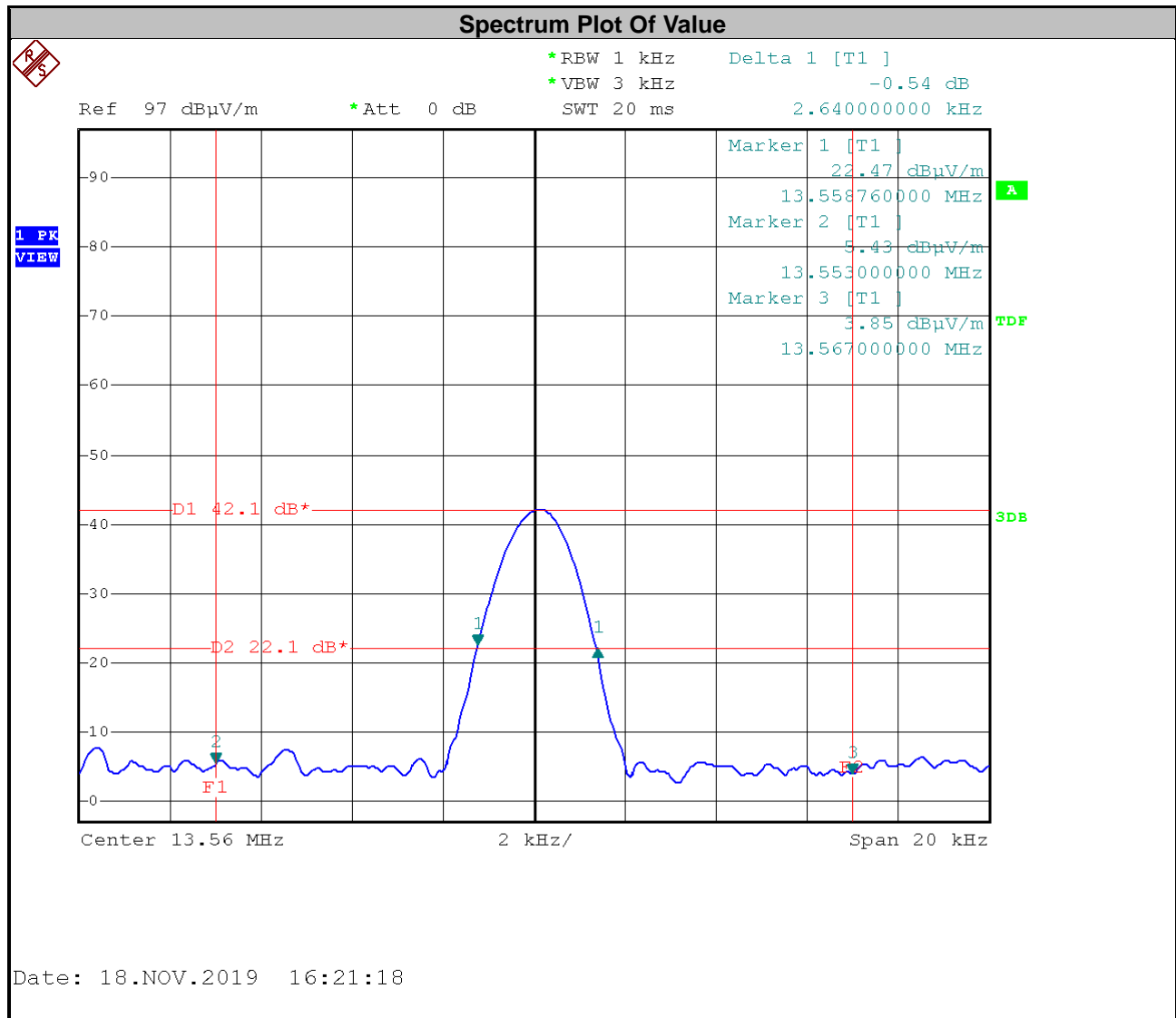

Note: The signal look like CW signal, so RBW can't be match 1~5 % OBW.

Type B

20 dBc Point (Low)	20 dBc Point (High)	Operating Frequency Band (MHz)	20 dBc Bandwidth (kHz)	Pass / Fail
13.55876	13.5614	13.553~13.567	2.64	Pass

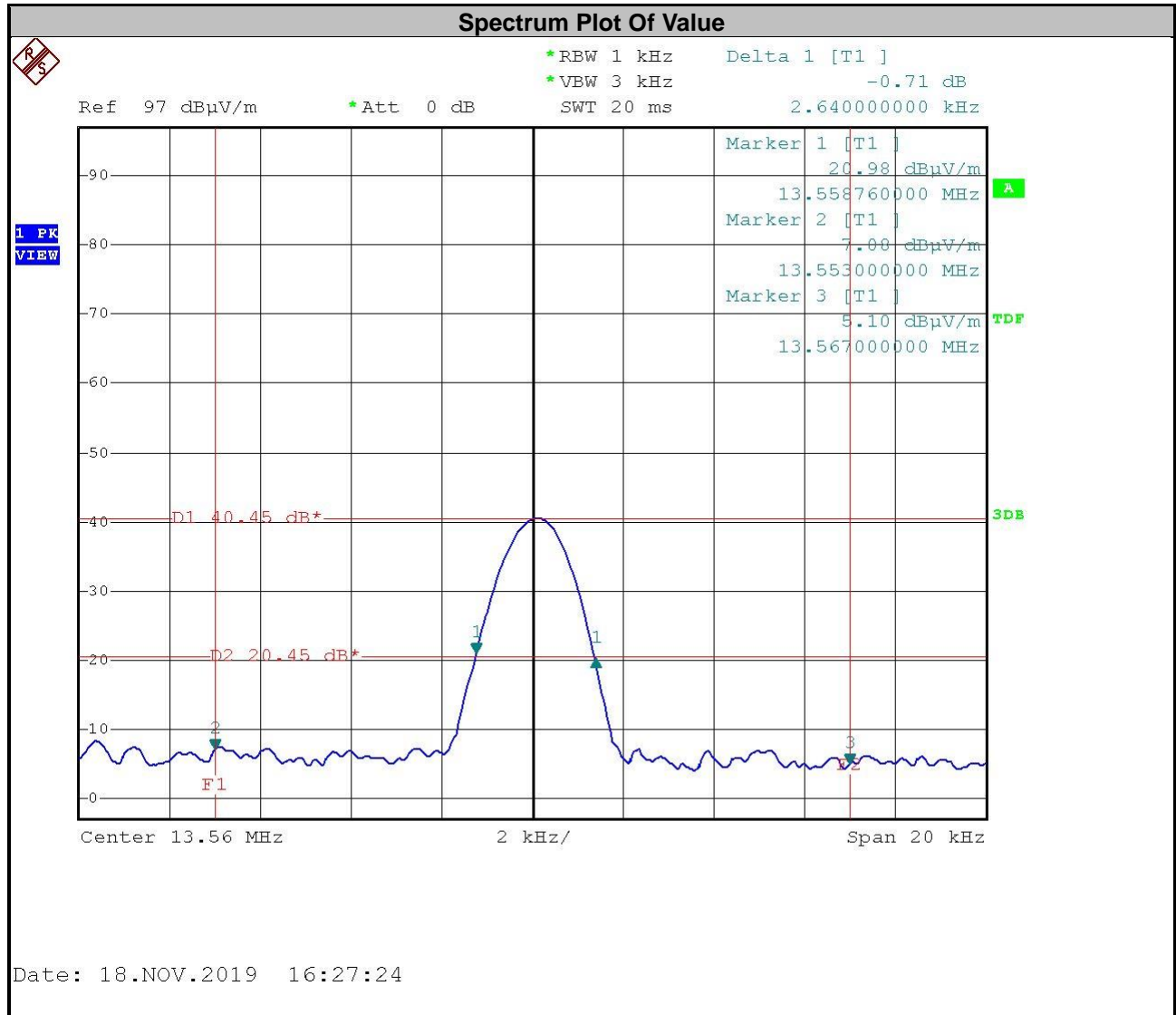

Note: The signal look like CW signal, so RBW can't be match 1~5 % OBW.

Type F

20 dBc Point (Low)	20 dBc Point (High)	Operating Frequency Band (MHz)	20 dBc Bandwidth (kHz)	Pass / Fail
13.55876	13.5614	13.553~13.567	2.64	Pass

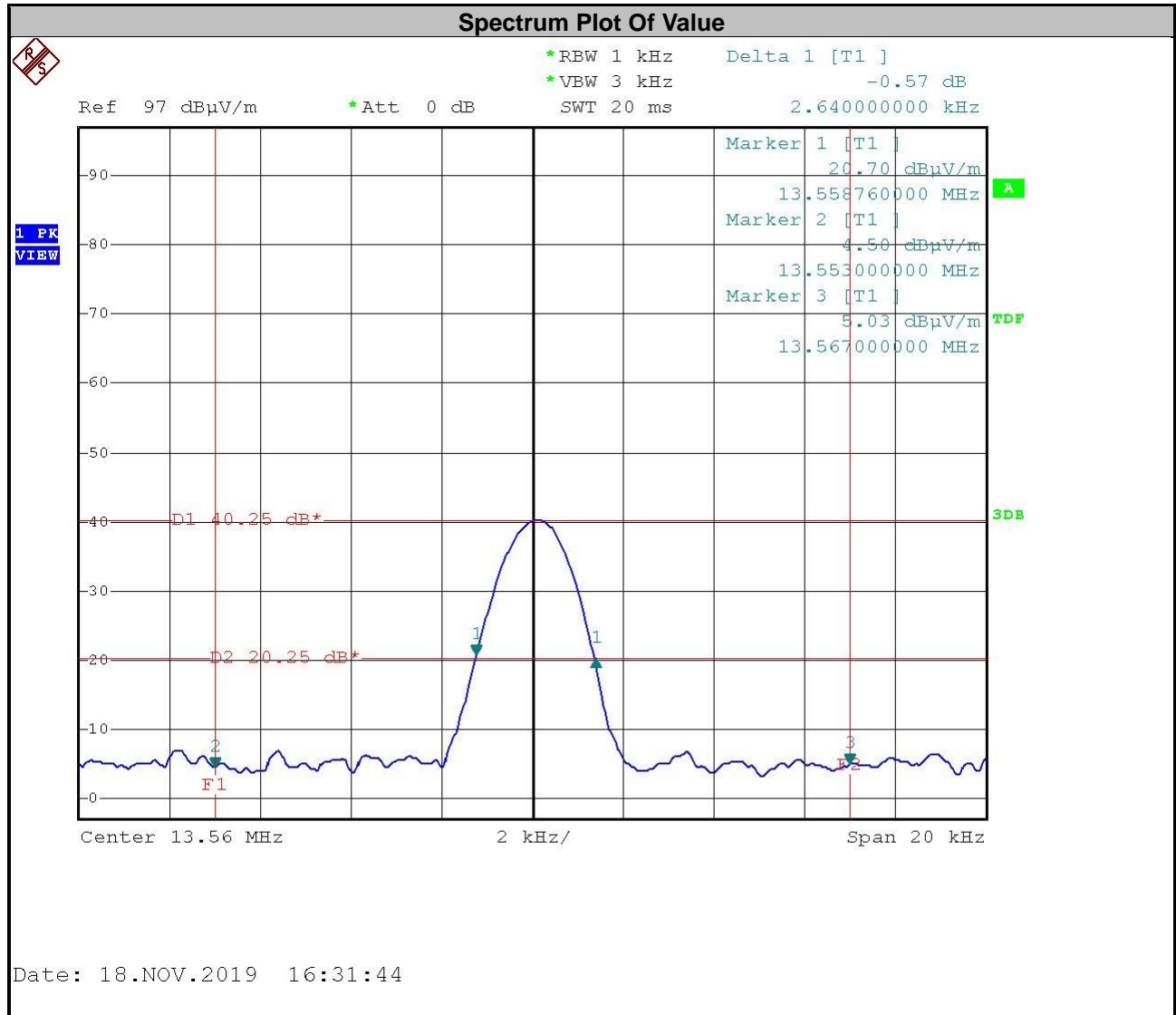

Note: The signal look like CW signal, so RBW can't be match 1~5 % OBW.

Mode B  
Type A

20 dBc Point (Low)	20 dBc Point (High)	Operating Frequency Band (MHz)	20 dBc Bandwidth (kHz)	Pass / Fail
13.55876	13.5614	13.553~13.567	2.64	Pass

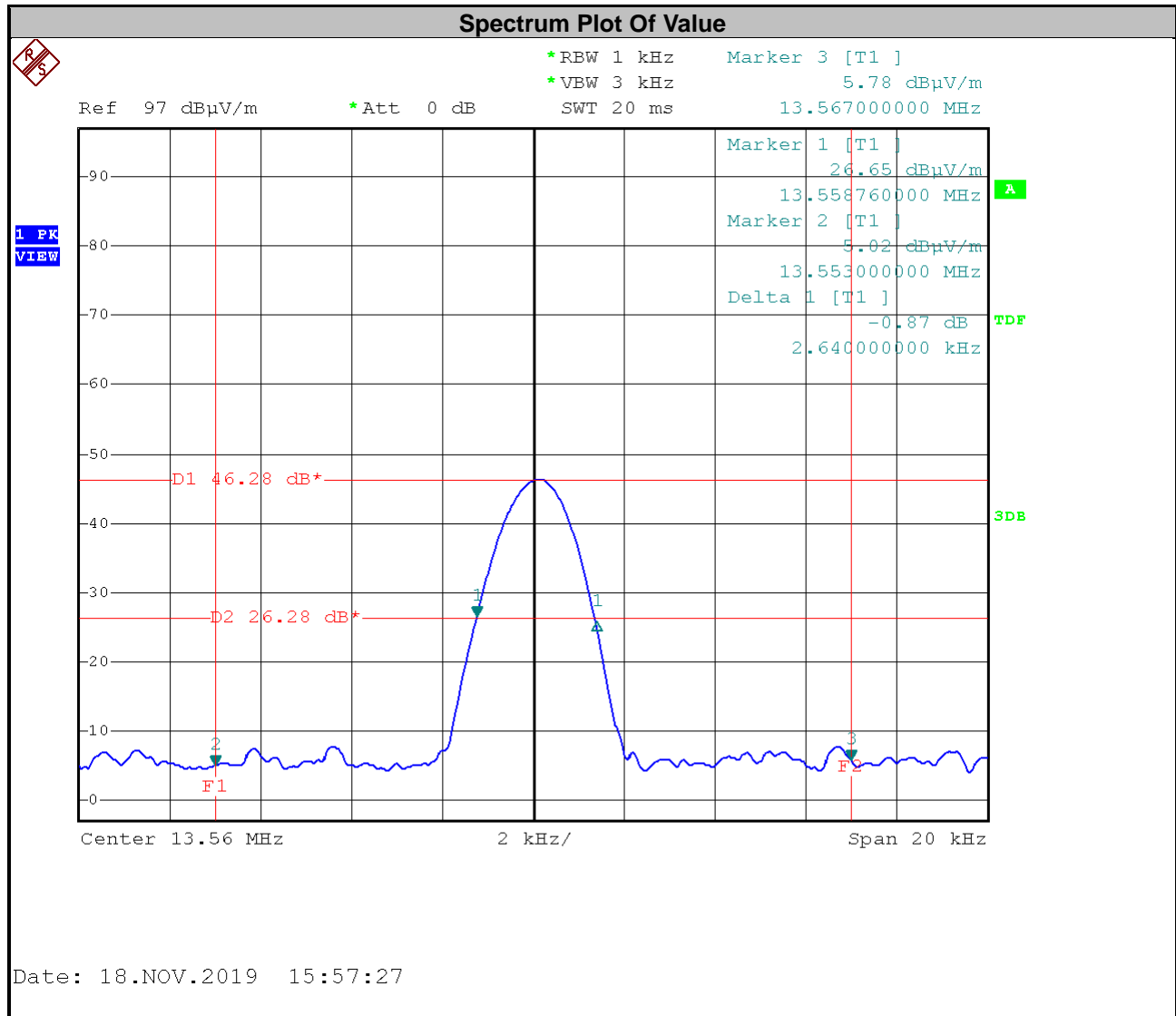

Note: The signal look like CW signal, so RBW can't be match 1~5 % OBW.

Type B

20 dBc Point (Low)	20 dBc Point (High)	Operating Frequency Band (MHz)	20 dBc Bandwidth (kHz)	Pass / Fail
13.55876	13.5614	13.553~13.567	2.64	Pass

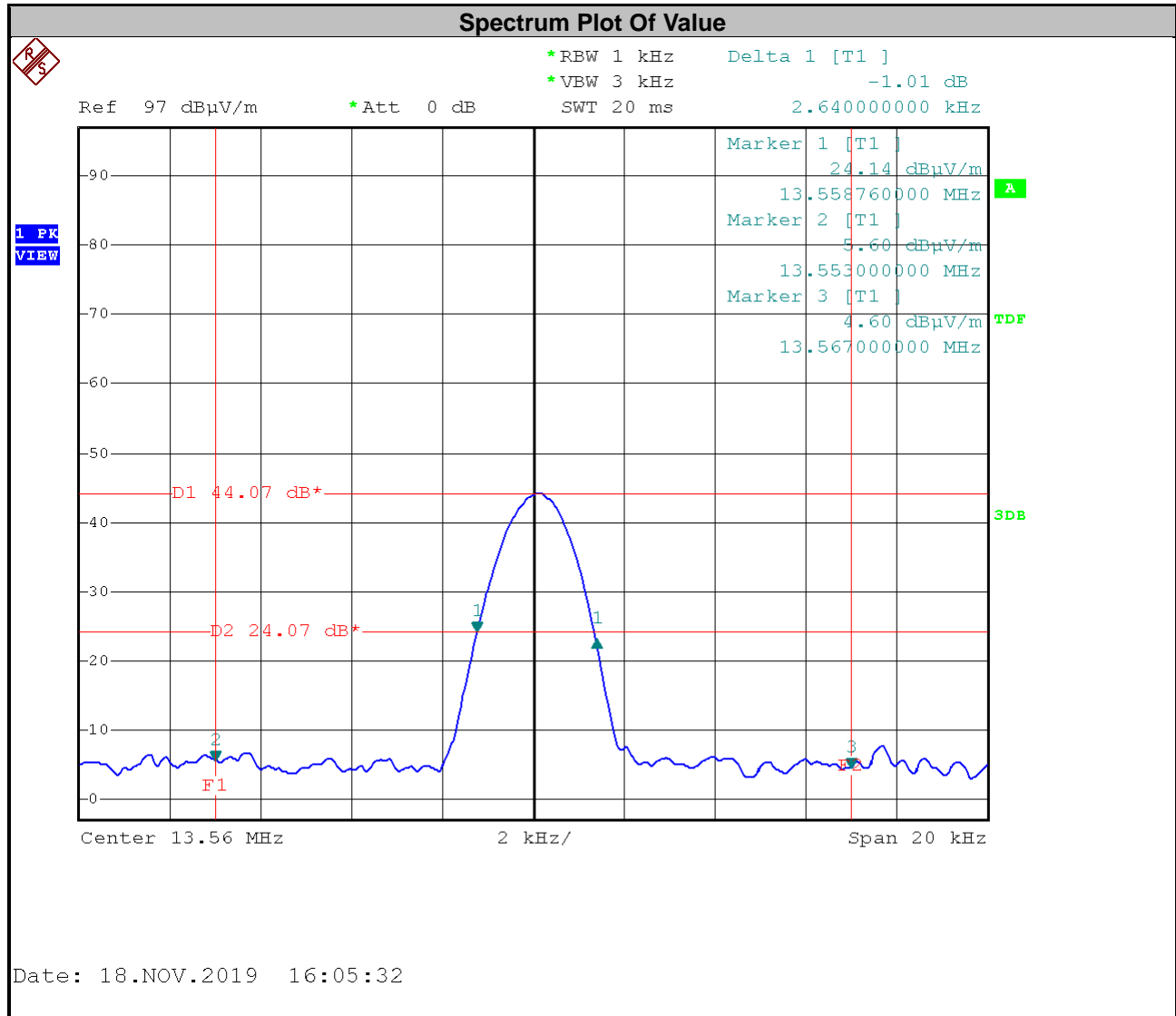

Note: The signal look like CW signal, so RBW can't be match 1~5 % OBW.

Type F

20 dBc Point (Low)	20 dBc Point (High)	Operating Frequency Band (MHz)	20 dBc Bandwidth (kHz)	Pass / Fail
13.55876	13.56144	13.553~13.567	2.68	Pass

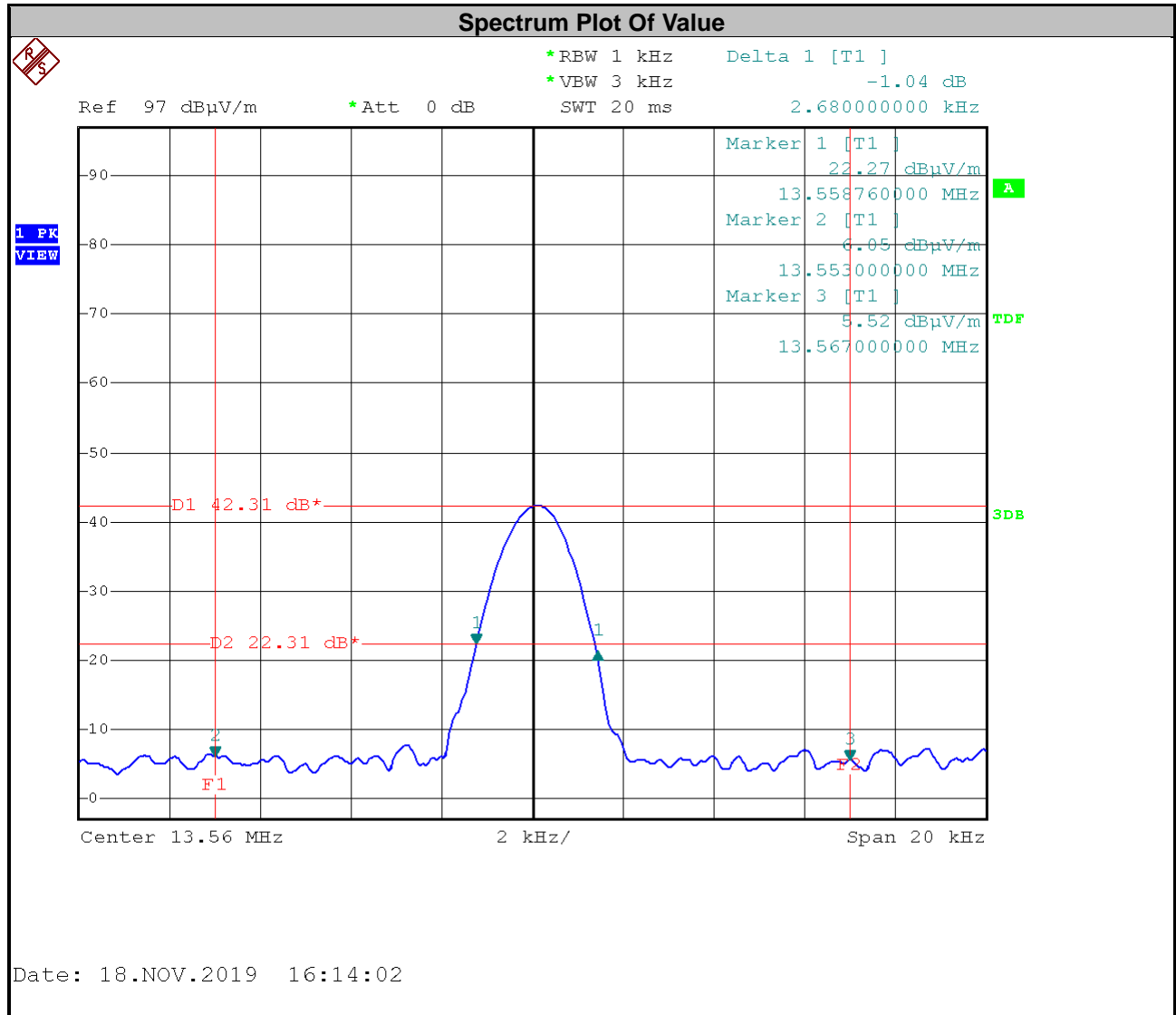

Note: The signal look like CW signal, so RBW can't be match 1~5 % OBW.

## 5 Pictures of Test Arrangements

Please refer to the attached file (Test Setup Photo).

## Appendix – Information of the Testing Laboratories

We, Bureau Veritas Consumer Products Services (H.K.) Ltd., Taoyuan Branch, were founded in 1988 to provide our best service in EMC, Radio, Telecom and Safety consultation. Our laboratories are FCC recognized accredited test firms and accredited according to ISO/IEC 17025.

If you have any comments, please feel free to contact us at the following:

**Lin Kou EMC/RF Lab**

Tel: 886-2-26052180

Fax: 886-2-26051924

**Hsin Chu EMC/RF/Telecom Lab**

Tel: 886-3-6668565

Fax: 886-3-6668323

**Hwa Ya EMC/RF/Safety Lab**

Tel: 886-3-3183232

Fax: 886-3-3270892

**Email:** [service.adt@tw.bureauveritas.com](mailto:service.adt@tw.bureauveritas.com)

**Web Site:** [www.bureauveritas-adt.com](http://www.bureauveritas-adt.com)

The address and road map of all our labs can be found in our web site also.

--- END ---