

FCC Test Report

Report No.: RF160512C20

FCC ID: E2K-DWRFID1602

Test Model: DWRFID1602

Received Date: May 12, 2016

Test Date: Sep. 26, 2016 ~ Oct. 03, 2016

Issued Date: Oct. 07, 2016

Applicant: Dell Inc.

Address: One Dell Way, Round Rock, TX 78682, USA

Issued By: Bureau Veritas Consumer Products Services (H.K.) Ltd., Taoyuan Branch

Lab Address: No. 47-2, 14th Ling, Chia Pau Vil., Lin Kou Dist., New Taipei City, Taiwan
(R.O.C)

Test Location: No. 19, Hwa Ya 2nd Rd, Wen Hwa Tsuen, Kwei Shan Hsiang, Taoyuan
Hsien 333, Taiwan, R.O.C.



This report is for your exclusive use. Any copying or replication of this report to or for any other person or entity, or use of our name or trademark, is permitted only with our prior written permission. This report sets forth our findings solely with respect to the test samples identified herein. The results set forth in this report are not indicative or representative of the quality or characteristics of the lot from which a test sample was taken or any similar or identical product unless specifically and expressly noted. Our report includes all of the tests requested by you and the results thereof based upon the information that you provided to us. You have 60 days from date of issuance of this report to notify us of any material error or omission caused by our negligence, provided, however, that such notice shall be in writing and shall specifically address the issue you wish to raise. A failure to raise such issue within the prescribed time shall constitute your unqualified acceptance of the completeness of this report, the tests conducted and the correctness of the report contents. Unless specific mention, the uncertainty of measurement has been explicitly taken into account to declare the compliance or non-compliance to the specification. The report must not be used by the client to claim product certification, approval, or endorsement by TAF or any government agencies.

Table of Contents

Release Control Record	3
1 Certificate of Conformity	4
2 Summary of Test Results	5
2.1 Measurement Uncertainty.....	5
2.2 Modification Record	5
3 General Information	6
3.1 General Description of EUT	6
3.2 Description of Test Modes.....	7
3.2.1 Test Mode Applicability and Tested Channel Detail.....	7
3.3 Description of Support Units	8
3.3.1 Configuration of System under Test	8
3.4 General Description of Applied Standards.....	9
4 Test Types and Results	10
4.1 Radiated Emission Measurement.....	10
4.1.1 Limits of Radiated Emission Measurement	10
4.1.2 Test Instruments	11
4.1.3 Test Procedures.....	12
4.1.4 Deviation from Test Standard	12
4.1.5 Test Set Up	13
4.1.6 EUT Operating Conditions.....	13
4.1.7 Test Results	14
4.2 Conducted Emission Measurement.....	26
4.2.1 Limits of Conducted Emission Measurement	26
4.2.2 Test Instruments	26
4.2.3 Test Procedures.....	27
4.2.4 Deviation from Test Standard	27
4.2.5 Test Setup.....	27
4.2.6 EUT Operating Conditions.....	27
4.2.7 Test Results	28
4.3 Frequency Stability	32
4.3.1 Limits of Frequency Stability Measurement	32
4.3.2 Test Setup.....	32
4.3.3 Test Instruments	32
4.3.4 Test Procedure	32
4.3.5 Deviation from Test Standard	32
4.3.6 EUT Operating Conditions.....	32
4.3.7 Test Result	33
4.4 20 dB Bandwidth.....	34
4.4.1 Limits of 20 dB Bandwidth Measurement.....	34
4.4.2 Test Setup.....	34
4.4.3 Test Instruments	34
4.4.4 Test Procedures.....	34
4.4.5 Deviation from Test Standard	34
4.4.6 EUT Operating Conditions.....	34
4.4.7 Test Results	35
5 Pictures of Test Arrangements	37
Appendix – Information on the Testing Laboratories	38

Release Control Record

Issue No.	Description	Date Issued
RF160512C20	Original Release	Oct. 07, 2016

1 Certificate of Conformity

Product: RFID 13.56MHz Wireless Module

Brand: DELL

Test Model: DWRFID1602

Sample Status: Identical Prototype

Applicant: Dell Inc.

Test Date: Sep. 26, 2016 ~ Oct. 03, 2016

Standards: 47 CFR FCC Part 15, Subpart C (Section 15.225)
47 CFR FCC Part 15, Subpart C (Section 15.215)
ANSI C63.10:2013

The above equipment has been tested by **Bureau Veritas Consumer Products Services (H.K.) Ltd., Taoyuan Branch**, and found compliance with the requirement of the above standards. The test record, data evaluation & Equipment Under Test (EUT) configurations represented herein are true and accurate accounts of the measurements of the sample's EMC characteristics under the conditions specified in this report.

Prepared by : , **Date:** Oct. 07, 2016
Gina Liu / Specialist

Approved by : , **Date:** Oct. 07, 2016
Stanley Wu / Assistant Manager

2 Summary of Test Results

47 CFR FCC Part 15, Subpart C (Section 15.225, 15.215)			
FCC Clause	Test Item	Result	Remarks
15.207	Conducted emission test	Pass	Meet the requirement of limit. Minimum passing margin is -5.04 dB at 13.56130 MHz.
15.225 (a)	The field strength of any emissions within the band 13.553-13.567 MHz	Pass	Meet the requirement of limit. Minimum passing margin is 13.56 dB at -71.73 MHz.
15.225 (b)	The field strength of any emissions within the bands 13.410-13.553 MHz and 13.567-13.710 MHz	Pass	Meet the requirement of limit.
15.225 (c)	The field strength of any emissions within the bands 13.110-13.410 MHz and 13.710-14.010 MHz	Pass	Meet the requirement of limit.
15.225 (d)	The field strength of any emissions appearing outside of the 13.110-14.010 MHz band	Pass	Meet the requirement of limit. Minimum passing margin is -3.69 dB at 40.67 MHz.
15.225 (e)	The frequency tolerance	Pass	Meet the requirement of limit.
15.215 (c)	20dB Bandwidth	Pass	Meet the requirement of limit.
15.203	Antenna Requirement	Pass	No antenna connector is used.

2.1 Measurement Uncertainty

Where relevant, the following measurement uncertainty levels have been estimated for tests performed on the EUT as specified in CISPR 16-4-2:

Measurement	Frequency	Expanded Uncertainty (k=2) (±)
Conducted Emissions at mains ports	150 kHz ~ 30 MHz	2.44 dB
Radiated Emissions up to 1 GHz	30 MHz ~ 200 MHz	2.93 dB
	200 MHz ~ 1000 MHz	2.95 dB
Radiated Emissions above 1 GHz	1 GHz ~ 18 GHz	2.26 dB
	18 GHz ~ 40 GHz	1.94 dB

2.2 Modification Record

There were no modifications required for compliance.

3 General Information

3.1 General Description of EUT

Product	RFID 13.56MHz Wireless Module
Brand	DELL
Test Model	DWRFID1602
Status of EUT	Identical Prototype
Power Supply Rating	19.5 Vdc (adapter)
Modulation Type	ASK
Operating Frequency	13.56 MHz
Antenna Type	Loop Antenna
Accessory Device	Refer to Note
Data Cable Supplied	Refer to Note

Note:

- The EUT contains following accessory devices.

Product	Brand	Model	Description
Adapter 1	DELL	AA65NM121	I/P: 100-240 Vac, 50-60 Hz, 1.7 A O/P: 19.5 Vdc, 3.34 A
Adapter 2	DELL	DA90PM130	I/P: 100-240 Vac, 50-60 Hz, 1.5 A O/P: 19.5 Vdc, 4.62 A

- The EUT is authorized for use in specific End-product. Please refer to below table for more details.

Item	Brand	Model
Notebook	DELL	P27S

- The antenna vendors for this EUT is listed as below

Antenna 1: ACON

Antenna 2: SPEED

- The above EUT information is declared by manufacturer and for more detailed features description, please refer to the manufacturer's specifications or user's manual.

3.2 Description of Test Modes

One channel was provided to this EUT:

Channel	Frequency (MHz)
1	13.56

3.2.1 Test Mode Applicability and Tested Channel Detail

EUT Configure Mode	Applicable To				Description
	RE	PLC	FS	EB	
A	√	√	-	√	Antenna 1
B	√	√	√	√	Antenna 2

Where

RE: Radiated Emission
FS: Frequency Stability

PLC: Power Line Conducted Emission
EB: 20 dB Bandwidth measurement

Radiated Emission Test:

- Pre-Scan has been conducted to determine the worst-case mode from all possible combinations between available modulations, data rates and antenna ports (if EUT with antenna diversity architecture).
- Following channel(s) was (were) selected for the final test as listed below.

EUT Configure Mode	Available Channel	Tested Channel	Modulation Type	Axis
A, B	1	1	ASK	Z

Power Line Conducted Emission Test:

- Pre-Scan has been conducted to determine the worst-case mode from all possible combinations between available modulations, data rates and antenna ports (if EUT with antenna diversity architecture).
- Following channel(s) was (were) selected for the final test as listed below.

EUT Configure Mode	Available Channel	Tested Channel	Modulation Type	Axis
A, B	1	1	ASK	Z

Frequency Stability:

- This item includes all test value of each mode, but only includes spectrum plot of worst value of each mode.
- Pre-Scan has been conducted to determine the worst-case mode from all possible combinations between available modulations, data rates and antenna ports (if EUT with antenna diversity architecture).
- Following channel(s) was (were) selected for the final test as listed below.

EUT Configure Mode	Available Channel	Tested Channel	Modulation Type	Axis
B	1	1	ASK	Z

20 dB Bandwidth:

- This item includes all test value of each mode, but only includes spectrum plot of worst value of each mode.
- Pre-Scan has been conducted to determine the worst-case mode from all possible combinations between available modulations, data rates and antenna ports (if EUT with antenna diversity architecture).
- Following channel(s) was (were) selected for the final test as listed below.

EUT Configure Mode	Available Channel	Tested Channel	Modulation Type	Axis
A, B	1	1	ASK	Z

Test Condition:

Applicable To	Environmental Conditions	Input Power	Tested By
RE	25 deg. C, 65 % RH	120 Vac, 60 Hz	Getaz Yang
FS	25 deg. C, 65 % RH	19.5 Vdc	Luke Chen
PLC	25 deg. C, 65 % RH	120 Vac, 60 Hz	Toby Tian
EB	25 deg. C, 68 % RH	19.5 Vdc	Luke Chen

3.3 Description of Support Units

The EUT has been tested as an independent unit together with other necessary accessories or support units.

3.3.1 Configuration of System under Test

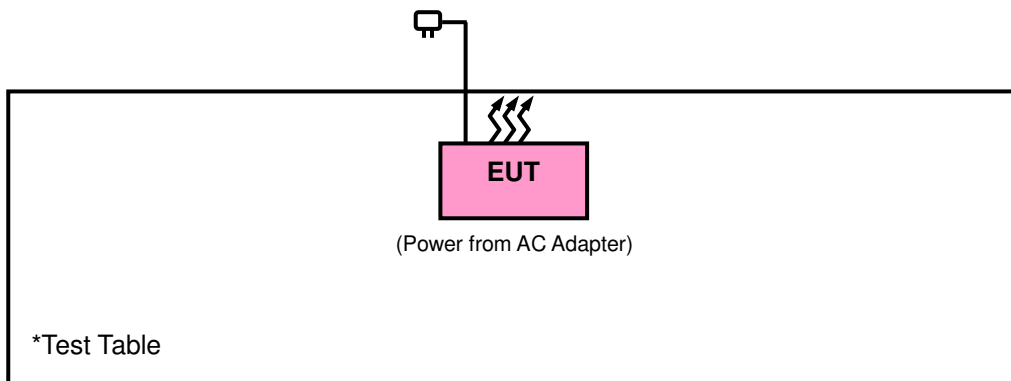

3.4 General Description of Applied Standards

The EUT is a RF Product. According to the specifications of the manufacturer, it must comply with the requirements of the following standards:

FCC Part 15, Subpart C (15.225)

FCC Part 15, Subpart C (15.215)

ANSI C63.10-2013

All test items have been performed and recorded as per the above standards.

NOTE: The EUT has been verified to comply with the requirements of FCC Part 15, Subpart B, Class B (DoC).
The test report has been issued separately.

4 Test Types and Results

4.1 Radiated Emission Measurement

4.1.1 Limits of Radiated Emission Measurement

The field strength of any emissions within the band 13.553-13.567 MHz shall not exceed 15,848 microvolts/meter at 30 meters.

The field strength of any emissions appearing outside of the 13.110-14.010 MHz band shall not exceed the general radiated emission limits in § 15.209.

Frequencies (MHz)	Field Strength (microvolts/meter)	Measurement Distance (meters)
0.009 ~ 0.490	2400/F (kHz)	300
0.490 ~ 1.705	24000/F (kHz)	30
1.705 ~ 30.0	30	30
30 ~ 88	100	3
88 ~ 216	150	3
216 ~ 960	200	3
Above 960	500	3

NOTE:

1. The lower limit shall apply at the transition frequencies.
2. Emission level (dBuV/m) = 20 log Emission level (uV/m).
3. For frequencies above 1000 MHz, the field strength limits are based on average detector, however, the peak field strength of any emission shall not exceed the maximum permitted average limits, specified above by more than 20 dB under any condition of modulation.

4.1.2 Test Instruments

Description & Manufacturer	Model No.	Serial No.	Date of Calibration	Due Date of Calibration
Test Receiver Agilent	N9038A	MY51210203	Jan. 21, 2016	Jan. 20, 2017
Spectrum Analyzer Agilent	N9010A	MY52220314	Oct. 23, 2015	Oct. 22, 2016
Spectrum Analyzer ROHDE & SCHWARZ	FSU43	101261	Dec. 17, 2015	Dec. 16, 2016
BILOG Antenna SCHWARZBECK	VULB9168	9168-472	Jan. 07, 2016	Jan. 06, 2017
HORN Antenna SCHWARZBECK	BBHA 9120 D	9120D-969	Jan. 04, 2016	Jan. 03, 2017
HORN Antenna SCHWARZBECK	BBHA 9170	9170-480	Jan. 08, 2016	Jan. 07, 2017
Loop Antenna	EM-6879	269	Aug. 11, 2016	Aug. 10, 2017
Preamplifier EMCI	EMC 012645	980115	Dec. 21, 2015	Dec. 20, 2016
Preamplifier EMCI	EMC 184045	980116	Dec. 21, 2015	Dec. 20, 2016
Preamplifier EMCI	EMC 330H	980112	Dec. 28, 2015	Dec. 27, 2016
Power Meter Anritsu	ML2495A	1232002	Sep. 08, 2016	Sep.07, 2017
Power Sensor Anritsu	MA2411B	1207325	Sep. 08, 2016	Sep.07, 2017
RF signal cable HUBER+SUHNNER	SUCOFLEX 104	309219/4 2950114	Oct. 12, 2015	Oct. 11, 2016
RF signal cable HUBER+SUHNNER	SUCOFLEX 104	250130/4	Oct. 12, 2015	Oct. 11, 2016
RF Coaxial Cable Worken	8D-FB	Cable-Ch10-01	Oct. 12, 2015	Oct. 11, 2016
Software BV ADT	E3 6.120103	NA	NA	NA
Antenna Tower MF	MFA-440H	NA	NA	NA
Turn Table MF	MFT-201SS	NA	NA	NA
Antenna Tower & Turn Table Controller MF	MF-7802	NA	NA	NA

- Note: 1. The calibration interval of the above test instruments is 12 months and the calibrations are traceable to NML/ROC and NIST/USA.
2. The test was performed in HwaYa Chamber 10.
3. The horn antenna and preamplifier (model: EMC 184045) are used only for the measurement of emission frequency above 1 GHz if tested.
4. The FCC Site Registration No. is 690701.
5. The IC Site Registration No. is IC7450F-10.

4.1.3 Test Procedures

- a. The EUT was placed on the top of a rotating table 0.8 meters above the ground at a 3 meters semi-anechoic chamber. The table was rotated 360 degrees to determine the position of the highest radiation.
- b. The EUT was set 3 meters away from the interference-receiving antenna, which was mounted on the top of a variable-height antenna tower.
- c. Height of receiving antenna is varied from one meter to four meters above the ground to determine the maximum value of the field strength. Both horizontal and vertical polarizations of the antenna are set to make the measurement.
- d. For each suspected emission, the EUT was arranged to its worst case and then the antenna was tuned to heights from 1 meter to 4 meters and the rotatable table was turned from 0 degrees to 360 degrees to find the maximum reading.
- e. The test-receiver system was set to Peak Detect Function and Specified Bandwidth with Maximum Hold Mode.
- f. If the emission level of the EUT in peak mode was lower than the limit specified, then testing could be stopped and the peak values of the EUT would be reported. Otherwise the emissions would be re-tested one by one using peak, quasi-peak or average method as specified and then reported in a data sheet.

NOTE:

1. The resolution bandwidth and video bandwidth of test receiver/spectrum analyzer is 120 kHz for Quasi-peak detection at frequency below 1 GHz.
2. The resolution bandwidth of test receiver/spectrum analyzer is 1 MHz and video bandwidth is 3 MHz for Peak detection at frequency above 1 GHz.
3. The resolution bandwidth of test receiver/spectrum analyzer is 1 MHz and the video bandwidth is $\geq 1/T$ (Duty cycle < 98 %) or 10 Hz (Duty cycle > 98 %) for Average detection (AV) at frequency above 1 GHz.
4. All modes of operation were investigated and the worst-case emissions are reported.

4.1.4 Deviation from Test Standard

No deviation.

4.1.5 Test Set Up

Frequency range 9k~30MHz:

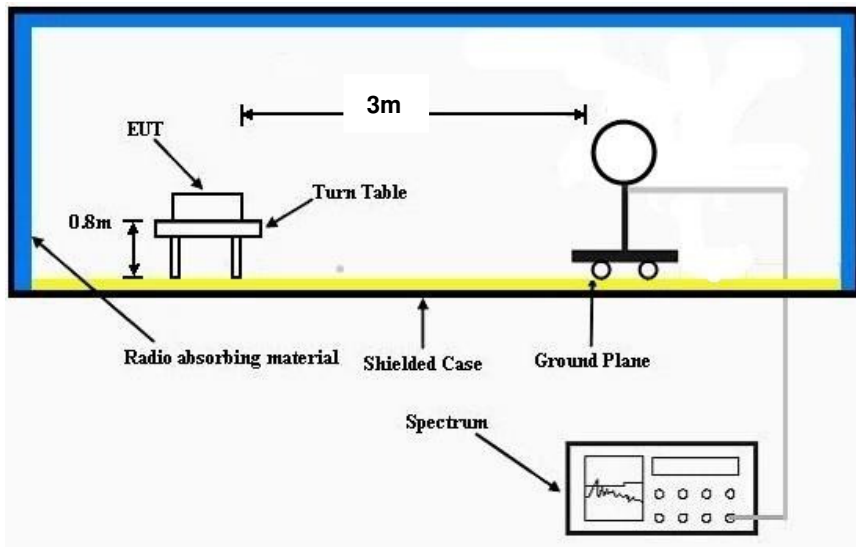

Frequency range 30~1000MHz:

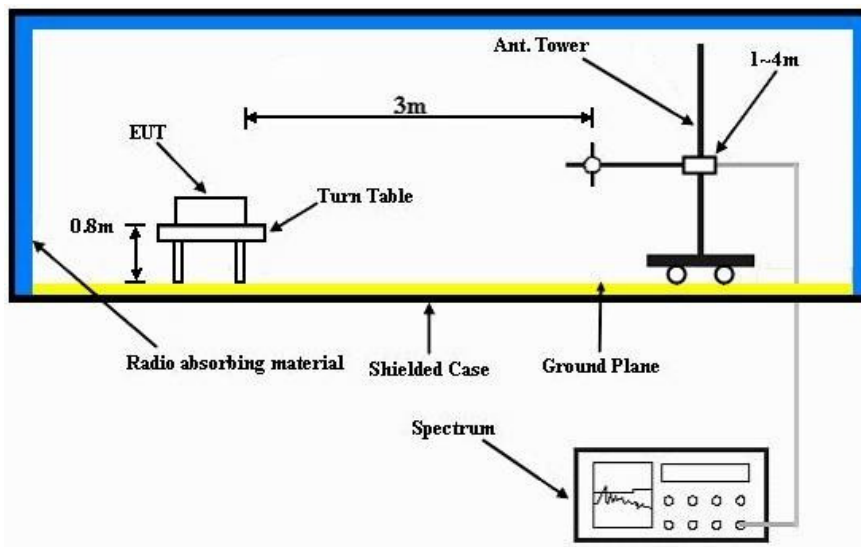

For the actual test configuration, please refer to the attached file (Test Setup Photo).

4.1.6 EUT Operating Conditions

- Placed the EUT on the testing table.
- Set the EUT under transmission condition continuously at specific channel frequency.

4.1.7 Test Results

Mode A

EUT Test Condition		Measurement Detail	
Channel	Channel 1	Frequency Range	13.553 ~ 13.567 MHz
Input Power	120 Vac, 60 Hz	Detector Function	Quasi-Peak
Environmental Conditions	25 deg. C, 65 % RH	Tested By	Getaz Yang

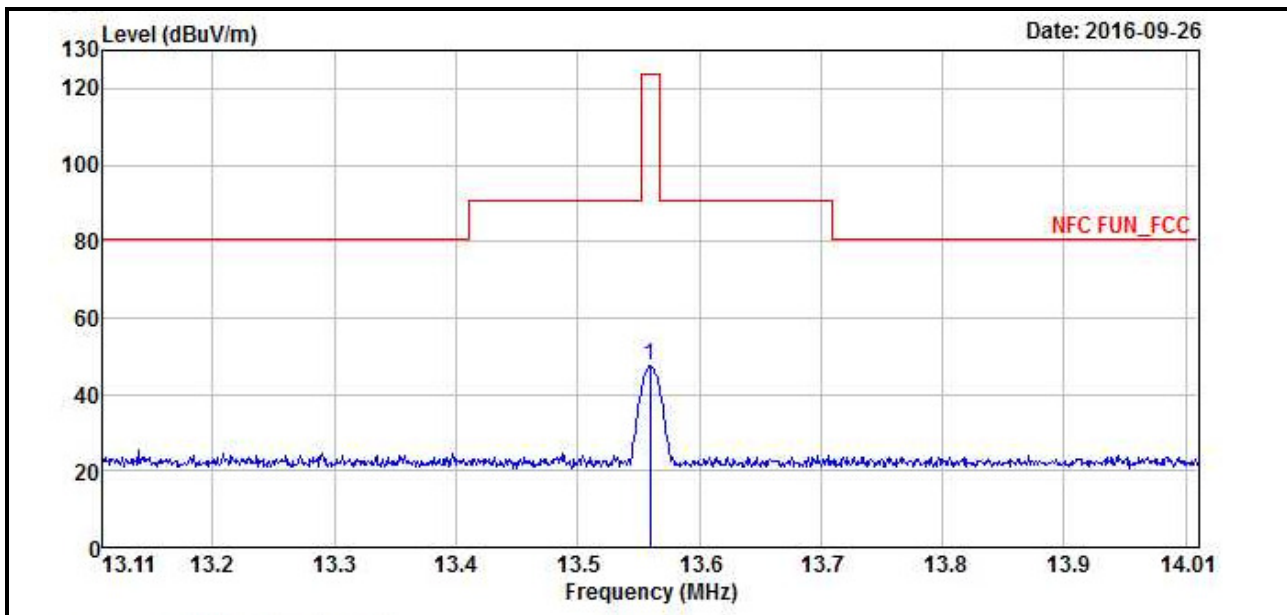

Antenna Polarity & Test Distance: Loop Antenna Open at 3M										
Frequency (MHz)	Emission Level (dBuV/m)	Read Level (dBuV)	Limit (dBuV/m)	Margin (dB)	Antenna Factor (dB/m)	Cable Loss (dB)	Preamp Factor (dB)	Antenna Height (cm)	Table Angle (Degree)	Remark
13.56	47.29	50.67	124.00	-76.71	37.67	0.31	41.36	100	360	Peak

- REMARKS:**
1. Emission level(dBuV/m)=Raw Value(dBuV) + Correction Factor(dB/m)
 2. Correction Factor(dB/m) = Antenna Factor (dB/m) + Cable Factor (dB) – Pre-Amplifier Factor(dB)
 3. The other emission levels were very low against the limit.
 4. Margin value = Emission level – Limit value.
 5. Above limits have been translated by the formula

The measured field strength was extrapolated to distance 30 meters, using the formula that the limit of field strength varies as the inverse distance square (40dB per decade of distance)

Example:

$$\begin{aligned}
 13.56 \text{ MHz} &= 15848 \text{ uV/m} && 30\text{m} \\
 &= 84 \text{ dBuV/m} && 30\text{m} \\
 &= 84+20\log(30/3)^2 && 3\text{m} \\
 &= 124 \text{ dBuV/m}
 \end{aligned}$$

EUT Test Condition		Measurement Detail	
Channel	Channel 1	Frequency Range	13.553 ~ 13.567 MHz
Input Power	120 Vac, 60 Hz	Detector Function	Quasi-Peak
Environmental Conditions	25 deg. C, 65 % RH	Tested By	Getaz Yang

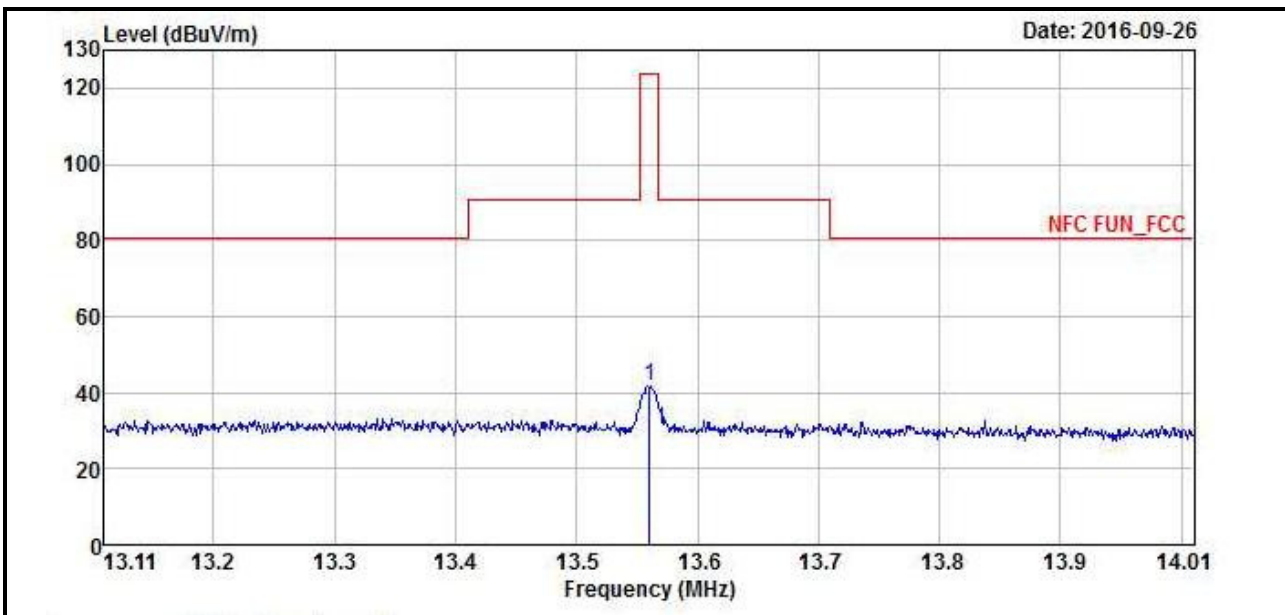

Antenna Polarity & Test Distance: Loop Antenna Close at 3M										
Frequency (MHz)	Emission Level (dBuV/m)	Read Level (dBuV)	Limit (dBuV/m)	Margin (dB)	Antenna Factor (dB/m)	Cable Loss (dB)	Preamp Factor (dB)	Antenna Height (cm)	Table Angle (Degree)	Remark
13.56	41.97	45.35	124.00	-82.03	37.67	0.31	41.36	100	0	Peak

- REMARKS:**
1. Emission level(dBuV/m)=Raw Value(dBuV) + Correction Factor(dB/m)
 2. Correction Factor(dB/m) = Antenna Factor (dB/m) + Cable Factor (dB) – Pre-Amplifier Factor(dB)
 3. The other emission levels were very low against the limit.
 4. Margin value = Emission level – Limit value.
 5. Above limits have been translated by the formula

The measured field strength was extrapolated to distance 30 meters, using the formula that the limit of field strength varies as the inverse distance square (40dB per decade of distance)

Example:

$$\begin{aligned}
 13.56 \text{ MHz} &= 15848 \text{ uV/m} && 30\text{m} \\
 &= 84 \text{ dBuV/m} && 30\text{m} \\
 &= 84+20\log(30/3)^2 && 3\text{m} \\
 &= 124 \text{ dBuV/m}
 \end{aligned}$$

EUT Test Condition		Measurement Detail	
Channel	Channel 1	Frequency Range	Below 30 MHz
Input Power	120 Vac, 60 Hz	Detector Function	Quasi-Peak
Environmental Conditions	25 deg. C, 65 % RH	Tested By	Getaz Yang

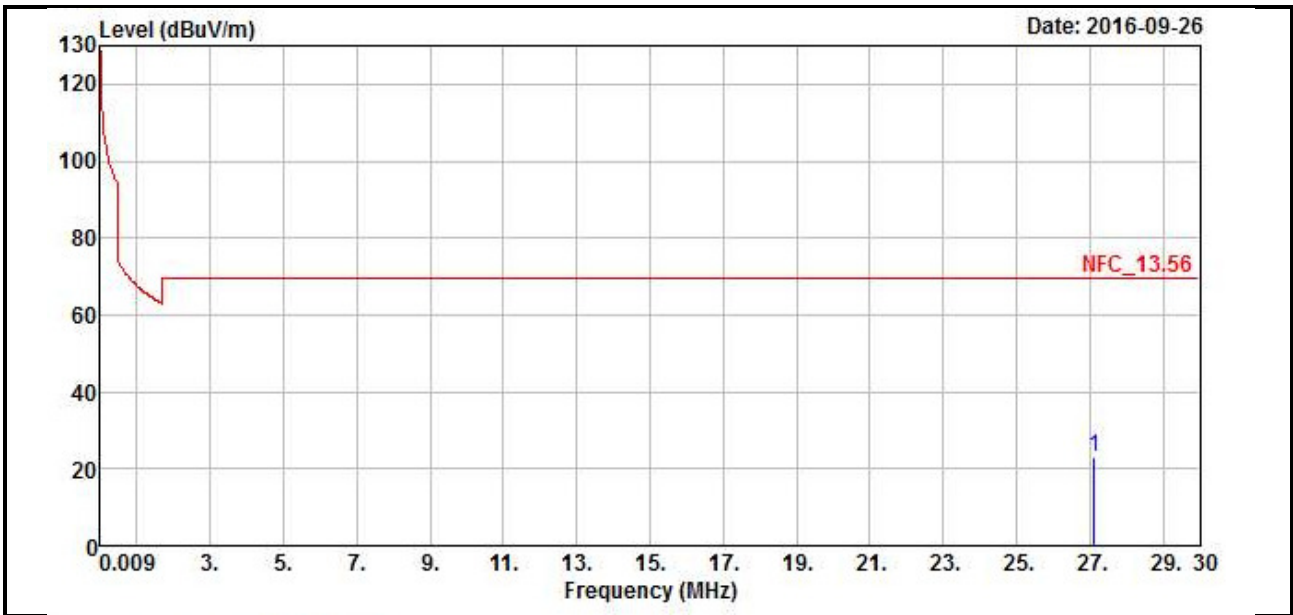

Antenna Polarity & Test Distance: Loop Antenna Open at 3M										
Frequency (MHz)	Emission Level (dBuV/m)	Read Level (dBuV)	Limit (dBuV/m)	Margin (dB)	Antenna Factor (dB/m)	Cable Loss (dB)	Preamp Factor (dB)	Antenna Height (cm)	Table Angle (Degree)	Remark
27.12	22.99	28.39	69.54	-46.55	35.55	0.38	41.33	100	0	Peak

REMARKS:

1. Emission Level(dBuV/m) = Raw Value(dBuV) + Correction Factor(dB/m)
2. Correction Factor(dB/m) = Antenna Factor(dB/m) + Cable Factor(dB) - Pre-Amplifier Factor (dB)
3. The other emission levels were very low against the limit.
4. Margin value = Emission Level - Limit value

EUT Test Condition		Measurement Detail	
Channel	Channel 1	Frequency Range	Below 30 MHz
Input Power	120 Vac, 60 Hz	Detector Function	Quasi-Peak
Environmental Conditions	25 deg. C, 65 % RH	Tested By	Getaz Yang

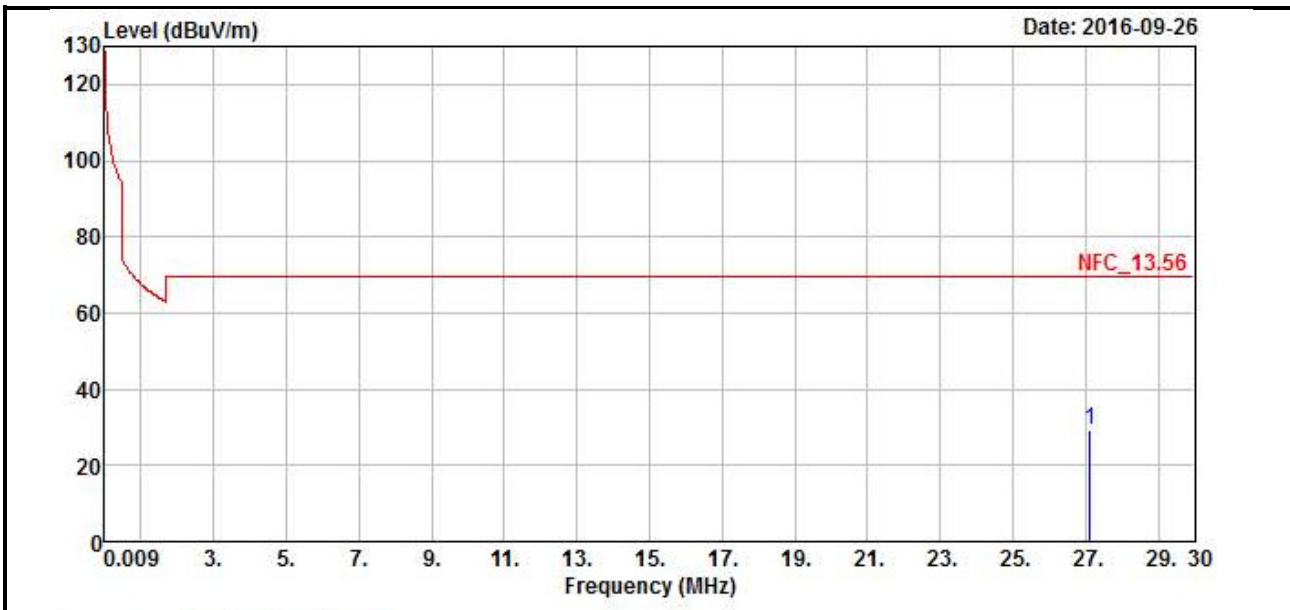

Antenna Polarity & Test Distance: Loop Antenna Close at 3M										
Frequency (MHz)	Emission Level (dBuV/m)	Read Level (dBuV)	Limit (dBuV/m)	Margin (dB)	Antenna Factor (dB/m)	Cable Loss (dB)	Preamp Factor (dB)	Antenna Height (cm)	Table Angle (Degree)	Remark
27.12	29.17	34.57	69.54	-40.37	35.55	0.38	41.33	100	360	Peak

REMARKS:

1. Emission Level(dBuV/m) = Raw Value(dBuV) + Correction Factor(dB/m)
2. Correction Factor(dB/m) = Antenna Factor(dB/m) + Cable Factor(dB)
– Pre-Amplifier Factor (dB)
3. The other emission levels were very low against the limit.
4. Margin value = Emission Level – Limit value

EUT Test Condition		Measurement Detail	
Channel	Channel 1	Frequency Range	Below 1000 MHz
Input Power	120 Vac, 60 Hz	Detector Function	Quasi-Peak
Environmental Conditions	25 deg. C, 65 % RH	Tested By	Getaz Yang

HORIZONTAL

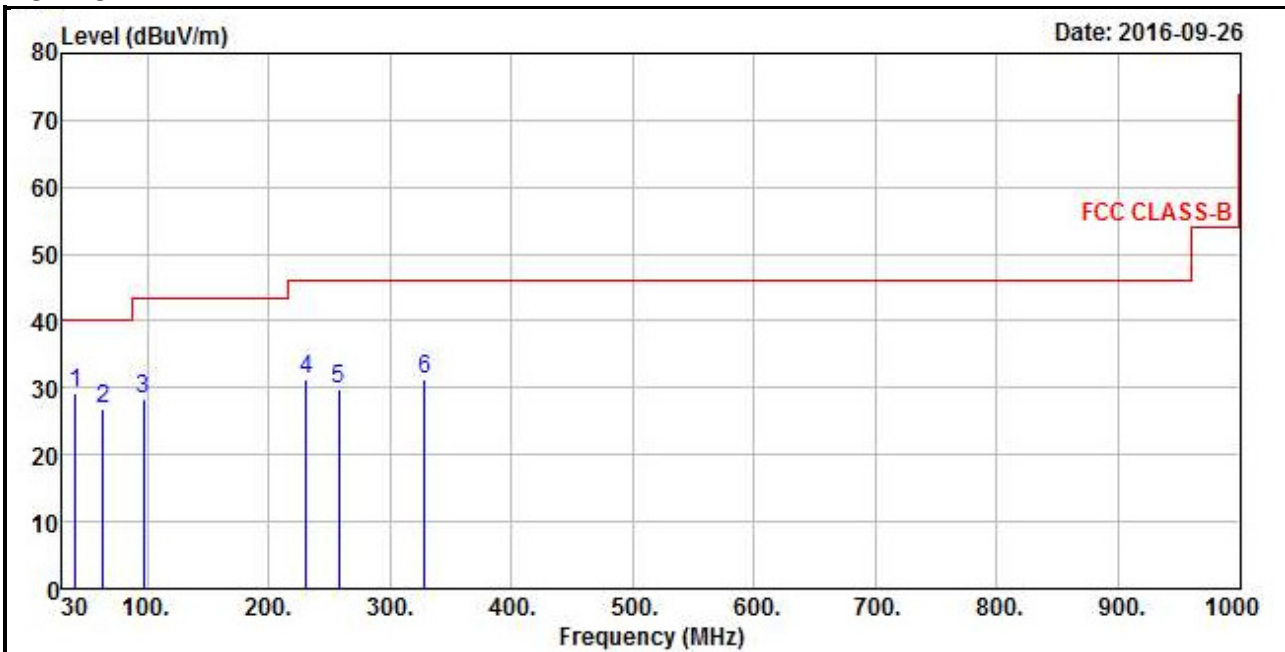

VERTICAL

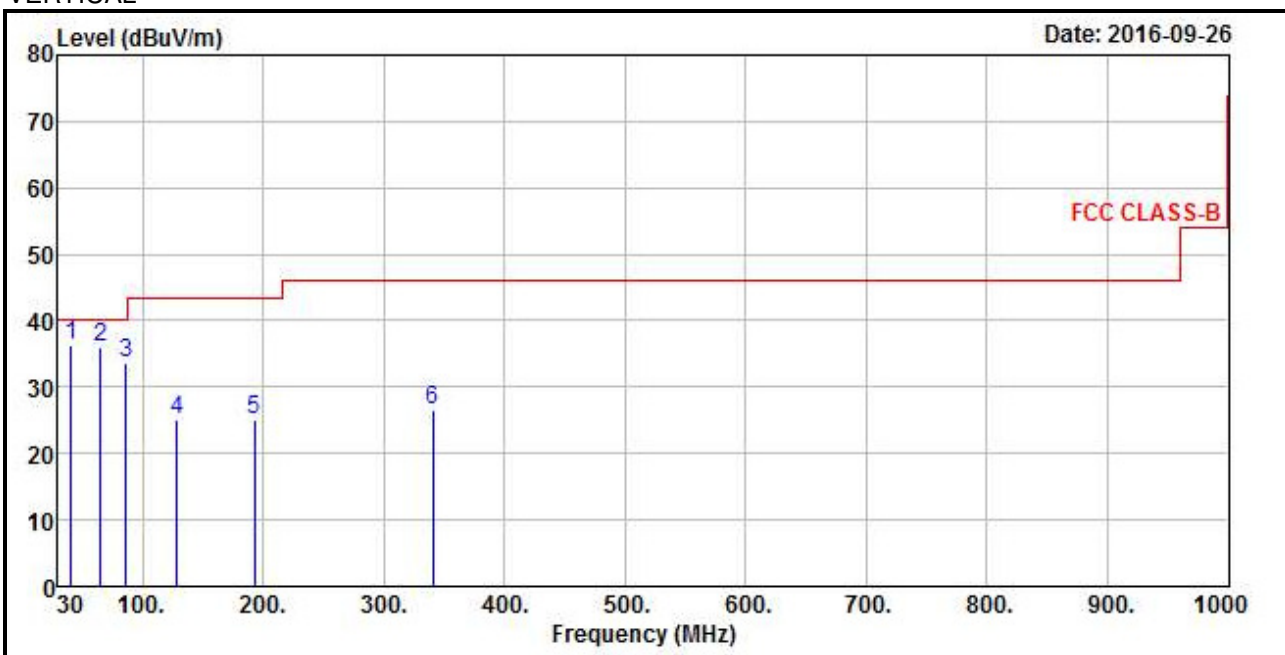

Antenna Polarity & Test Distance: Horizontal at 3 m

Frequency (MHz)	Emission Level (dBuV/m)	Read Level (dBuV)	Limit (dBuV/m)	Margin (dB)	Antenna Factor (dB/m)	Cable Loss (dB)	Preamp Factor (dB)	Antenna Height (cm)	Table Angle (Degree)	Remark
40.67	29.37	46.19	40	-10.63	13.55	0.65	31.02	117	59	Peak
63.95	26.98	46.21	40	-13.02	11.47	0.84	31.54	140	242	Peak
96.93	28.33	50.43	43.5	-15.17	8.83	1.03	31.96	124	201	Peak
230.79	31.18	50.95	46	-14.82	10.66	1.42	31.85	114	2	Peak
257.95	29.8	48.45	46	-16.2	11.71	1.51	31.87	101	27	Peak
328.76	31.29	47.76	46	-14.71	13.64	1.71	31.82	125	13	Peak

Antenna Polarity & Test Distance: Vertical at 3 m

Frequency (MHz)	Emission Level (dBuV/m)	Read Level (dBuV)	Limit (dBuV/m)	Margin (dB)	Antenna Factor (dB/m)	Cable Loss (dB)	Preamp Factor (dB)	Antenna Height (cm)	Table Angle (Degree)	Remark
40.67	36.31	53.13	40	-3.69	13.55	0.65	31.02	122	263	Peak
64.92	36.16	55.56	40	-3.84	11.35	0.84	31.59	124	218	Peak
86.26	33.72	56.33	40	-6.28	8.23	0.94	31.78	107	324	Peak
128.94	25.23	44.36	43.5	-18.27	11.61	1.14	31.88	127	311	Peak
192.96	25.03	45.62	43.5	-18.47	9.84	1.27	31.7	139	124	Peak
340.4	26.67	42.84	46	-19.33	13.91	1.74	31.82	139	60	Peak

REMARKS:

1. Emission Level = Read Level + Antenna Factor + Cable Loss - Preamp Factor
 Margin value = Emission level – Limit value.

Mode B

EUT Test Condition		Measurement Detail	
Channel	Channel 1	Frequency Range	13.553 ~ 13.567 MHz
Input Power	120 Vac, 60 Hz	Detector Function	Quasi-Peak
Environmental Conditions	25 deg. C, 65 % RH	Tested By	Getaz Yang

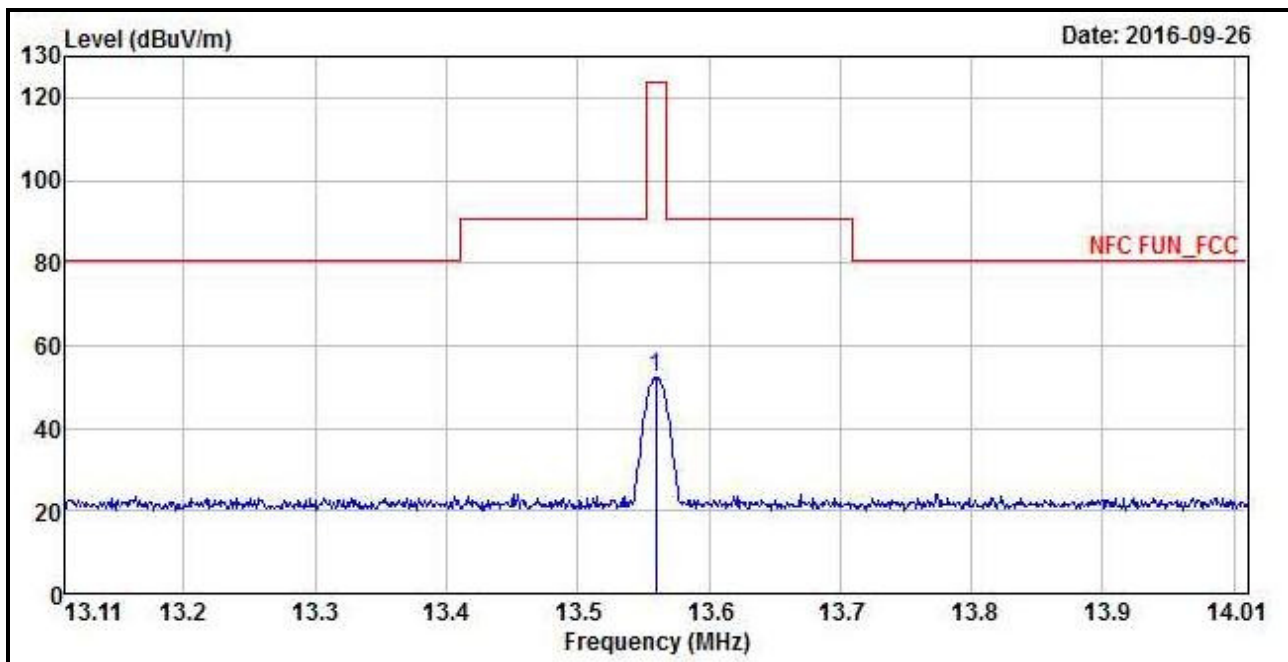

Antenna Polarity & Test Distance: Loop Antenna Open at 3M

Frequency (MHz)	Emission Level (dBuV/m)	Read Level (dBuV)	Limit (dBuV/m)	Margin (dB)	Antenna Factor (dB/m)	Cable Loss (dB)	Preamp Factor (dB)	Antenna Height (cm)	Table Angle (Degree)	Remark
13.56	52.27	55.65	124.00	-71.73	37.67	0.31	41.36	100	360	Peak

- REMARKS:**
1. Emission level(dBuV/m)=Raw Value(dBuV) + Correction Factor(dB/m)
 2. Correction Factor(dB/m) = Antenna Factor (dB/m) + Cable Factor (dB) – Pre-Amplifier Factor(dB)
 3. The other emission levels were very low against the limit.
 4. Margin value = Emission level – Limit value.
 5. Above limits have been translated by the formula

The measured field strength was extrapolated to distance 30 meters, using the formula that the limit of field strength varies as the inverse distance square (40dB per decade of distance)

Example:

$$\begin{aligned}
 13.56 \text{ MHz} &= 15848 \text{ uV/m} && 30\text{m} \\
 &= 84 \text{ dBuV/m} && 30\text{m} \\
 &= 84+20\log(30/3)^2 && 3\text{m} \\
 &= 124 \text{ dBuV/m}
 \end{aligned}$$

EUT Test Condition		Measurement Detail	
Channel	Channel 1	Frequency Range	13.553 ~ 13.567 MHz
Input Power	120 Vac, 60 Hz	Detector Function	Quasi-Peak
Environmental Conditions	25 deg. C, 65 % RH	Tested By	Getaz Yang

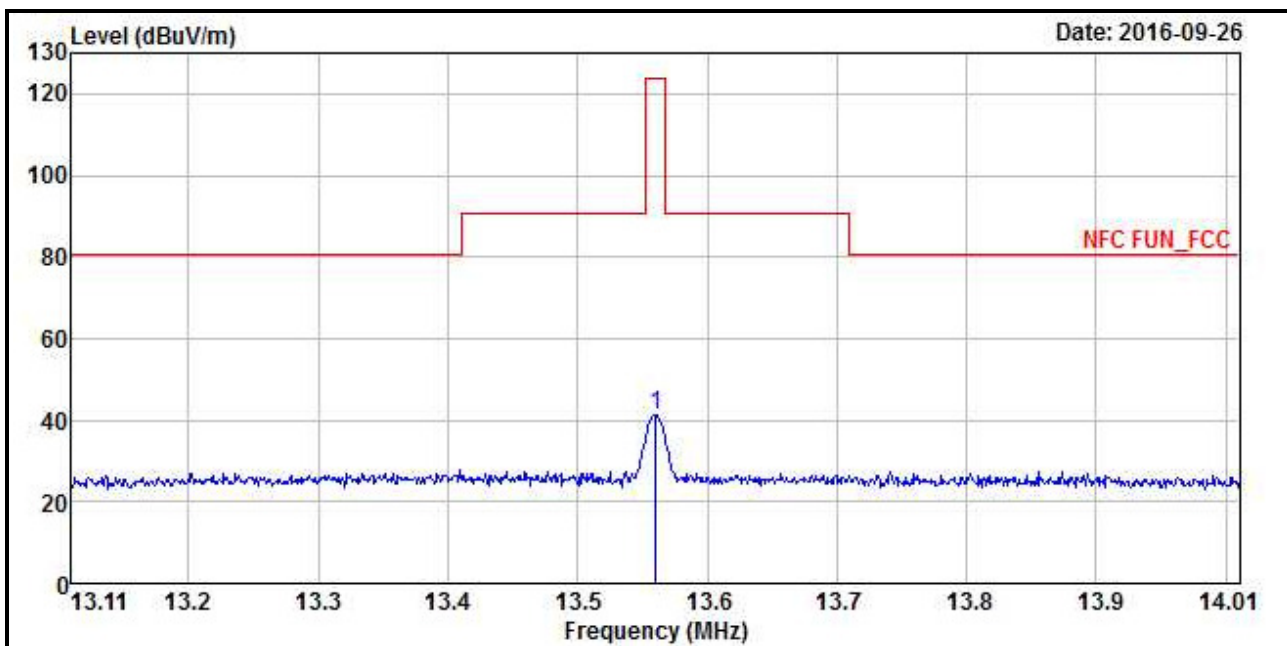

Antenna Polarity & Test Distance: Loop Antenna Close at 3M										
Frequency (MHz)	Emission Level (dBUV/m)	Read Level (dBUV)	Limit (dBUV/m)	Margin (dB)	Antenna Factor (dB/m)	Cable Loss (dB)	Preamp Factor (dB)	Antenna Height (cm)	Table Angle (Degree)	Remark
13.56	41.29	44.67	124.00	-82.71	37.67	0.31	41.36	100	0	Peak

- REMARKS:**
1. Emission level(dBUV/m)=Raw Value(dBuV) + Correction Factor(dB/m)
 2. Correction Factor(dB/m) = Antenna Factor (dB/m) + Cable Factor (dB) – Pre-Amplifier Factor(dB)
 3. The other emission levels were very low against the limit.
 4. Margin value = Emission level – Limit value.
 5. Above limits have been translated by the formula

The measured field strength was extrapolated to distance 30 meters, using the formula that the limit of field strength varies as the inverse distance square (40dB per decade of distance)

Example:

$$\begin{aligned}
 13.56 \text{ MHz} &= 15848 \text{ uV/m} && 30\text{m} \\
 &= 84 \text{ dBUV/m} && 30\text{m} \\
 &= 84 + 20 \log(30/3)^2 && 3\text{m} \\
 &= 124 \text{ dBUV/m}
 \end{aligned}$$

EUT Test Condition		Measurement Detail	
Channel	Channel 1	Frequency Range	Below 30 MHz
Input Power	120 Vac, 60 Hz	Detector Function	Quasi-Peak
Environmental Conditions	25 deg. C, 65 % RH	Tested By	Getaz Yang

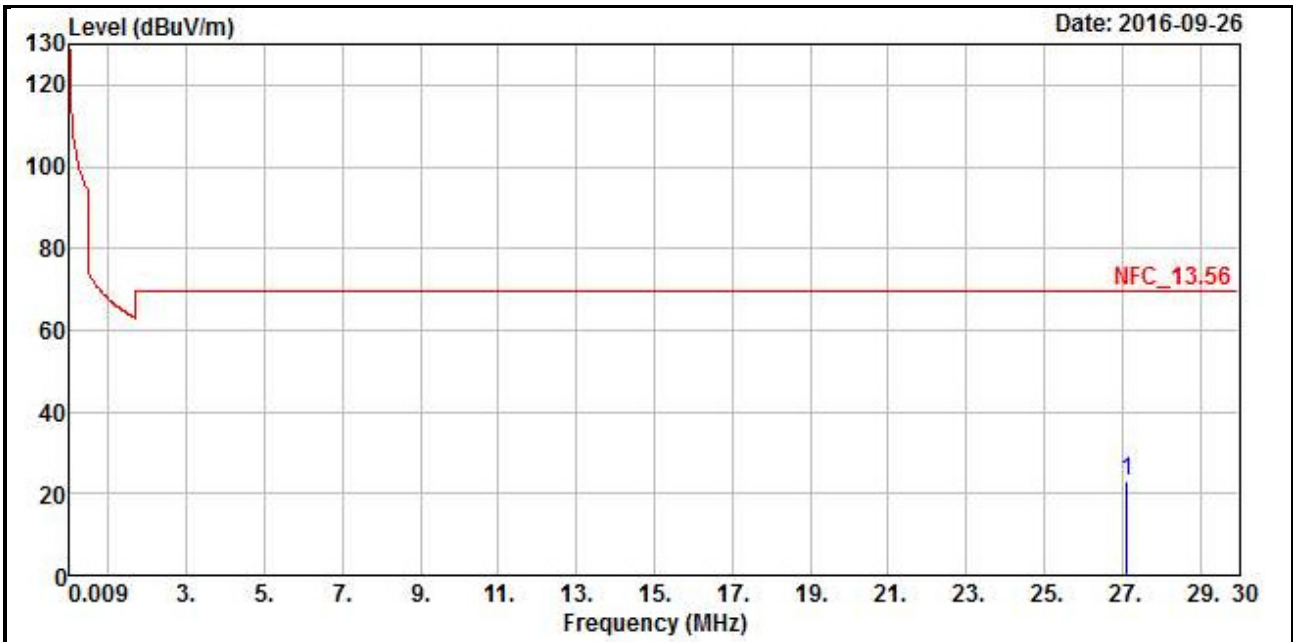

Antenna Polarity & Test Distance: Loop Antenna Open at 3M										
Frequency (MHz)	Emission Level (dBuV/m)	Read Level (dBuV)	Limit (dBuV/m)	Margin (dB)	Antenna Factor (dB/m)	Cable Loss (dB)	Preamp Factor (dB)	Antenna Height (cm)	Table Angle (Degree)	Remark
27.12	23.11	28.51	69.54	-46.43	35.55	0.38	41.33	100	0	Peak

REMARKS:

1. Emission Level(dBuV/m) = Raw Value(dBuV) + Correction Factor(dB/m)
2. Correction Factor(dB/m) = Antenna Factor(dB/m) + Cable Factor(dB) – Pre-Amplifier Factor (dB)
3. The other emission levels were very low against the limit.
4. Margin value = Emission Level – Limit value

EUT Test Condition		Measurement Detail	
Channel	Channel 1	Frequency Range	Below 30 MHz
Input Power	120 Vac, 60 Hz	Detector Function	Quasi-Peak
Environmental Conditions	25 deg. C, 65 % RH	Tested By	Getaz Yang

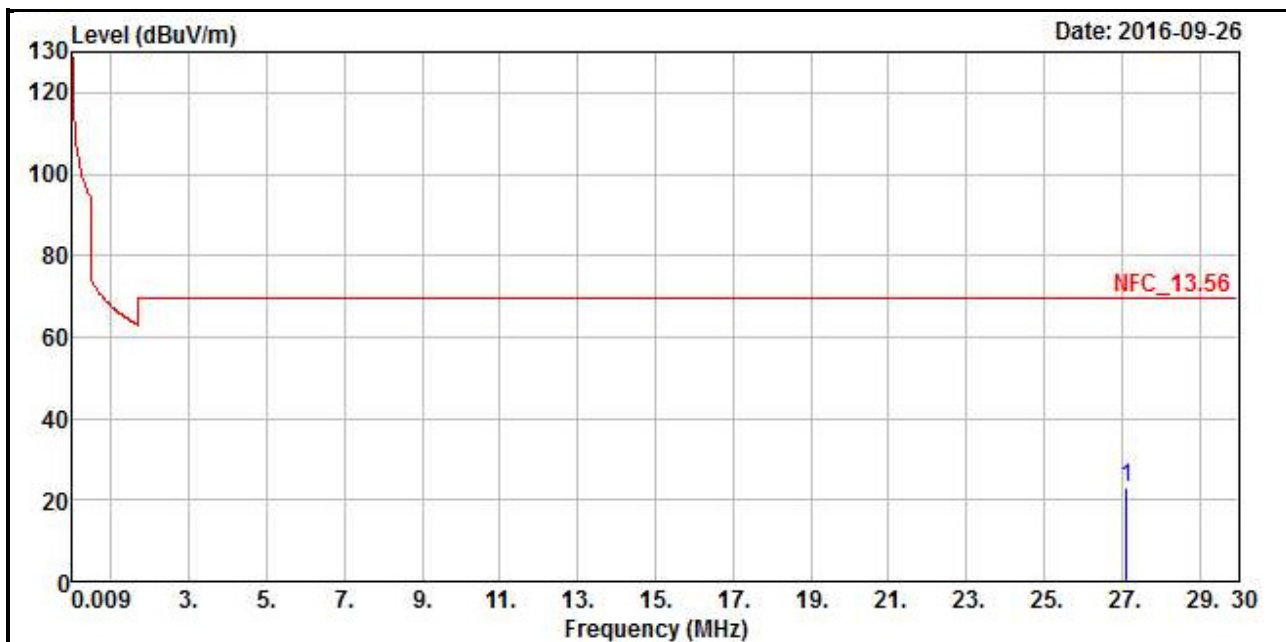

Antenna Polarity & Test Distance: Loop Antenna Close at 3M										
Frequency (MHz)	Emission Level (dBuV/m)	Read Level (dBuV)	Limit (dBuV/m)	Margin (dB)	Antenna Factor (dB/m)	Cable Loss (dB)	Preamp Factor (dB)	Antenna Height (cm)	Table Angle (Degree)	Remark
27.12	23.25	28.65	69.54	-46.29	35.55	0.38	41.33	100	360	Peak

REMARKS:

1. Emission Level(dBuV/m) = Raw Value(dBuV) + Correction Factor(dB/m)
2. Correction Factor(dB/m) = Antenna Factor(dB/m) + Cable Factor(dB)
– Pre-Amplifier Factor (dB)
3. The other emission levels were very low against the limit.
4. Margin value = Emission Level – Limit value

EUT Test Condition		Measurement Detail	
Channel	Channel 1	Frequency Range	Below 1000 MHz
Input Power	120 Vac, 60 Hz	Detector Function	Quasi-Peak
Environmental Conditions	25 deg. C, 65 % RH	Tested By	Getaz Yang

HORIZONTAL

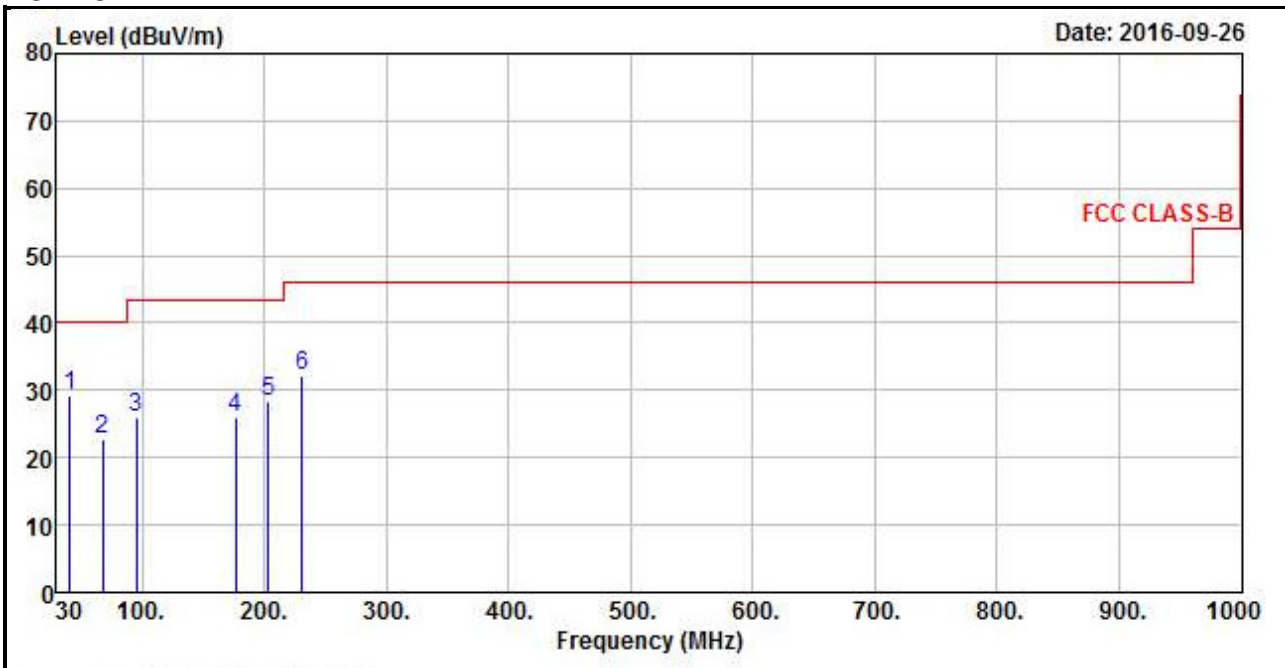

VERTICAL

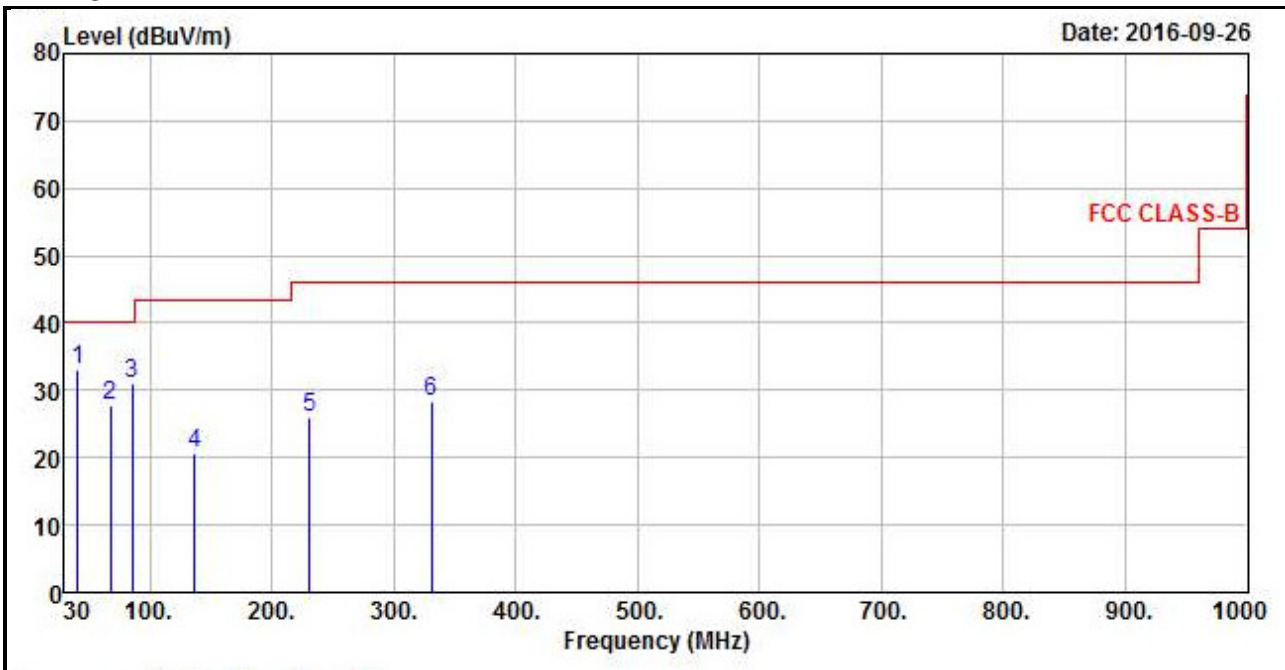

Antenna Polarity & Test Distance: Horizontal at 3 m

Frequency (MHz)	Emission Level (dBuV/m)	Read Level (dBuV)	Limit (dBuV/m)	Margin (dB)	Antenna Factor (dB/m)	Cable Loss (dB)	Preamp Factor (dB)	Antenna Height (cm)	Table Angle (Degree)	Remark
40.67	29.32	46.14	40	-10.68	13.55	0.65	31.02	128	255	Peak
67.83	22.72	42.6	40	-17.28	11	0.85	31.73	109	228	Peak
94.99	26.03	48.29	43.5	-17.47	8.68	1.02	31.96	122	202	Peak
176.47	26.12	45.65	43.5	-17.38	11.1	1.17	31.8	119	137	Peak
203.63	28.44	49.31	43.5	-15.06	9.52	1.31	31.7	114	54	Peak
230.79	32.21	51.98	46	-13.79	10.66	1.42	31.85	104	193	Peak

Antenna Polarity & Test Distance: Vertical at 3 m

Frequency (MHz)	Emission Level (dBuV/m)	Read Level (dBuV)	Limit (dBuV/m)	Margin (dB)	Antenna Factor (dB/m)	Cable Loss (dB)	Preamp Factor (dB)	Antenna Height (cm)	Table Angle (Degree)	Remark
40.67	32.93	49.75	40	-7.07	13.55	0.65	31.02	106	188	Peak
67.83	27.61	47.49	40	-12.39	11	0.85	31.73	125	358	Peak
85.29	30.91	53.5	40	-9.09	8.22	0.93	31.74	112	17	Peak
136.7	20.8	39.23	43.5	-22.7	12.14	1.14	31.71	110	278	Peak
230.79	26.1	45.87	46	-19.9	10.66	1.42	31.85	103	242	Peak
330.7	28.48	44.89	46	-17.52	13.68	1.72	31.81	133	275	Peak

REMARKS:

1. Emission Level = Read Level + Antenna Factor + Cable Loss - Preamp Factor
 Margin value = Emission level – Limit value.

4.2 Conducted Emission Measurement

4.2.1 Limits of Conducted Emission Measurement

Frequency (MHz)	Conducted Limit (dBuV)	
	Quasi-peak	Average
0.15 - 0.5	66 - 56	56 - 46
0.50 - 5.0	56	46
5.0 - 30.0	60	50

Note:

1. The lower limit shall apply at the transition frequencies.
2. The limit decreases in line with the logarithm of the frequency in the range of 0.15 to 0.50 MHz.
3. All emanations from a class A/B digital device or system, including any network of conductors and apparatus connected thereto, shall not exceed the level of field strengths specified above.

4.2.2 Test Instruments

Description & Manufacturer	Model No.	Serial No.	Date Of Calibration	Due Date Of Calibration
Test Receiver ROHDE & SCHWARZ	ESCI	100613	Nov. 16, 2015	Nov. 15, 2016
RF signal cable (with 10dB PAD) Woken	5D-FB	Cable-cond1-01	Dec. 26, 2015	Dec. 25, 2016
LISN ROHDE & SCHWARZ (EUT)	ESH3-Z5	835239/001	Feb. 26, 2016	Feb. 25, 2017
LISN ROHDE & SCHWARZ (Peripheral)	ESH3-Z5	100311	Jul. 28, 2016	Jul. 27, 2017
Software ADT	BV ADT_Cond_ V7.3.7.3	NA	NA	NA

- NOTE:**
1. The calibration interval of the above test instruments is 12 months and the calibrations are traceable to NML/ROC and NIST/USA.
 2. The test was performed in HwaYa Shielded Room 1.
 3. The VCCI Site Registration No. is C-2040.

4.2.3 Test Procedures

- a. The EUT was placed 0.4 meters from the conducting wall of the shielded room with EUT being connected to the power mains through a line impedance stabilization network (LISN). Other support units were connected to the power mains through another LISN. The two LISNs provide 50 ohm/50 uH of coupling impedance for the measuring instrument.
- b. Both lines of the power mains connected to the EUT were checked for maximum conducted interference.
- c. The frequency range from 150 kHz to 30 MHz was searched. Emission levels under (Limit – 20 dB) was not recorded.

NOTE: The resolution bandwidth and video bandwidth of test receiver is 9 kHz for quasi-peak detection (QP) and average detection (AV) at frequency 0.15 MHz - 30 MHz.

4.2.4 Deviation from Test Standard

No deviation.

4.2.5 Test Setup

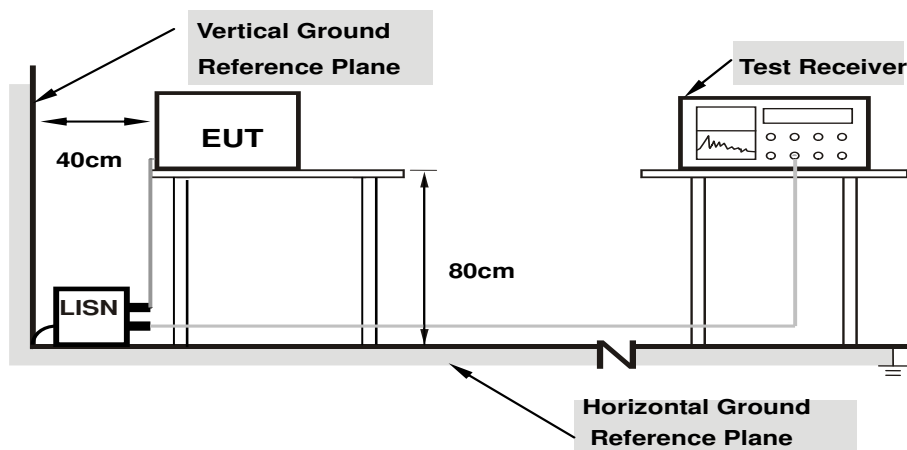

- Note:**
1. Support units were connected to second LISN.
 2. Both of LISNs (AMN) are 80 cm from EUT and at least 80 cm from other units and other metal planes

For the actual test configuration, please refer to the attached file (Test Setup Photo).

4.2.6 EUT Operating Conditions

- a. Placed the EUT on the testing table.
- b. Set the EUT under transmission condition continuously at specific channel frequency.

4.2.7 Test Results

Frequency Range	150kHz ~ 30MHz	Detector Function & Resolution Bandwidth	Quasi-Peak (QP) / Average (AV), 9kHz
Input Power	120Vac, 60Hz	Environmental Conditions	25°C, 65%RH
Tested by	Toby Tian	Test Date	2016/10/1
Test Mode	Mode A		

Phase Of Power : Line (L)										
No	Frequency (MHz)	Correction Factor (dB)	Reading Value (dBuV)		Emission Level (dBuV)		Limit (dBuV)		Margin (dB)	
			Q.P.	AV.	Q.P.	AV.	Q.P.	AV.	Q.P.	AV.
1	0.15000	10.01	41.31	22.97	51.32	32.98	66.00	56.00	-14.68	-23.02
2	0.16569	10.02	37.46	19.79	47.48	29.81	65.17	55.17	-17.69	-25.36
3	0.19692	10.03	31.99	15.56	42.02	25.59	63.74	53.74	-21.72	-28.15
4	0.25557	10.06	23.20	10.08	33.26	20.14	61.57	51.57	-28.31	-31.43
5	1.60061	10.24	20.12	13.73	30.36	23.97	56.00	46.00	-25.64	-22.03
6	13.56130	10.93	32.72	32.87	43.65	43.80	60.00	50.00	-16.35	-6.20

Remarks:

1. Q.P. and AV. are abbreviations of quasi-peak and average individually.
2. The emission levels of other frequencies were very low against the limit.
3. Margin value = Emission level – Limit value
4. Correction factor = Insertion loss + Cable loss
5. Emission Level = Correction Factor + Reading Value

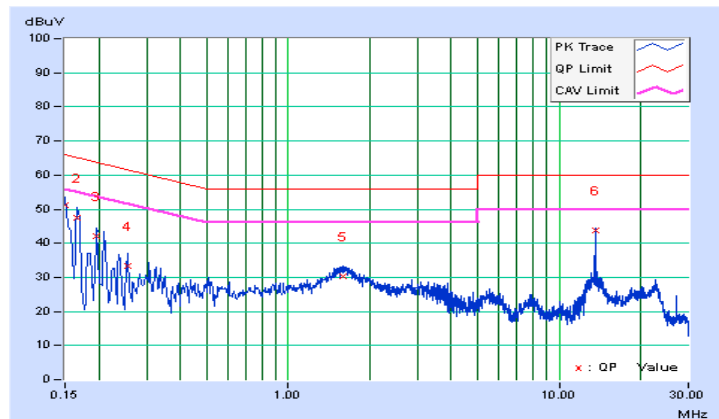

Frequency Range	150kHz ~ 30MHz	Detector Function & Resolution Bandwidth	Quasi-Peak (QP) / Average (AV), 9kHz
Input Power	120Vac, 60Hz	Environmental Conditions	25°C, 65%RH
Tested by	Toby Tian	Test Date	2016/10/1
Test Mode	Mode A		

Phase Of Power : Neutral (N)										
No	Frequency (MHz)	Correction Factor (dB)	Reading Value (dBuV)		Emission Level (dBuV)		Limit (dBuV)		Margin (dB)	
			Q.P.	AV.	Q.P.	AV.	Q.P.	AV.	Q.P.	AV.
1	0.15391	10.03	37.29	18.46	47.32	28.49	65.79	55.79	-18.47	-27.30
2	0.18128	10.03	34.16	16.24	44.19	26.27	64.43	54.43	-20.24	-28.16
3	0.22024	10.05	27.50	10.76	37.55	20.81	62.81	52.81	-25.26	-32.00
4	0.33046	10.10	19.88	6.88	29.98	16.98	59.44	49.44	-29.46	-32.46
5	1.57324	10.25	19.05	13.02	29.30	23.27	56.00	46.00	-26.70	-22.73
6	13.56130	11.02	34.58	31.66	45.60	42.68	60.00	50.00	-14.40	-7.32

Remarks:

1. Q.P. and AV. are abbreviations of quasi-peak and average individually.
2. The emission levels of other frequencies were very low against the limit.
3. Margin value = Emission level – Limit value
4. Correction factor = Insertion loss + Cable loss
5. Emission Level = Correction Factor + Reading Value

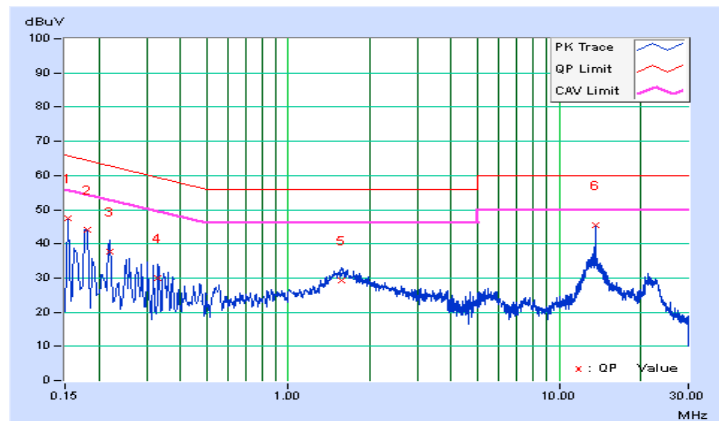

Frequency Range	150kHz ~ 30MHz	Detector Function & Resolution Bandwidth	Quasi-Peak (QP) / Average (AV), 9kHz
Input Power	120Vac, 60Hz	Environmental Conditions	25°C, 65%RH
Tested by	Toby Tian	Test Date	2016/10/1
Test Mode	Mode B		

Phase Of Power : Line (L)										
No	Frequency (MHz)	Correction Factor (dB)	Reading Value (dBuV)		Emission Level (dBuV)		Limit (dBuV)		Margin (dB)	
			Q.P.	AV.	Q.P.	AV.	Q.P.	AV.	Q.P.	AV.
1	0.15000	10.01	42.20	23.06	52.21	33.07	66.00	56.00	-13.79	-22.93
2	0.16955	10.02	38.37	20.98	48.39	31.00	64.98	54.98	-16.59	-23.98
3	0.19717	10.03	33.20	16.60	43.23	26.63	63.73	53.73	-20.50	-27.10
4	0.22434	10.04	28.38	12.22	38.42	22.26	62.66	52.66	-24.24	-30.40
5	1.57324	10.24	20.49	14.12	30.73	24.36	56.00	46.00	-25.27	-21.64
6	13.56130	10.93	33.89	34.03	44.82	44.96	60.00	50.00	-15.18	-5.04

Remarks:

1. Q.P. and AV. are abbreviations of quasi-peak and average individually.
2. The emission levels of other frequencies were very low against the limit.
3. Margin value = Emission level – Limit value
4. Correction factor = Insertion loss + Cable loss
5. Emission Level = Correction Factor + Reading Value

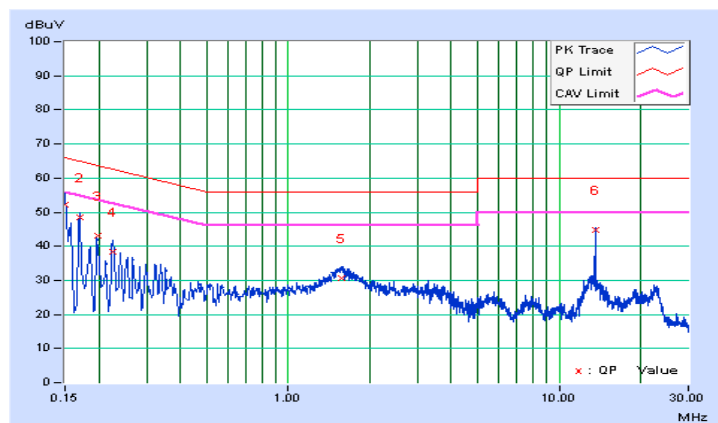

Frequency Range	150kHz ~ 30MHz	Detector Function & Resolution Bandwidth	Quasi-Peak (QP) / Average (AV), 9kHz
Input Power	120Vac, 60Hz	Environmental Conditions	25°C, 65%RH
Tested by	Toby Tian	Test Date	2016/10/1
Test Mode	Mode B		

Phase Of Power : Neutral (N)										
No	Frequency (MHz)	Correction Factor (dB)	Reading Value (dBuV)		Emission Level (dBuV)		Limit (dBuV)		Margin (dB)	
			Q.P.	AV.	Q.P.	AV.	Q.P.	AV.	Q.P.	AV.
1	0.15000	10.03	42.38	22.97	52.41	33.00	66.00	56.00	-13.59	-23.00
2	0.17346	10.03	37.82	19.46	47.85	29.49	64.79	54.79	-16.94	-25.30
3	0.20084	10.04	32.72	15.23	42.76	25.27	63.58	53.58	-20.82	-28.31
4	0.24384	10.06	25.31	9.43	35.37	19.49	61.96	51.96	-26.59	-32.47
5	1.58068	10.25	19.39	12.79	29.64	23.04	56.00	46.00	-26.36	-22.96
6	13.56130	11.02	31.96	31.37	42.98	42.39	60.00	50.00	-17.02	-7.61

Remarks:

1. Q.P. and AV. are abbreviations of quasi-peak and average individually.
2. The emission levels of other frequencies were very low against the limit.
3. Margin value = Emission level – Limit value
4. Correction factor = Insertion loss + Cable loss
5. Emission Level = Correction Factor + Reading Value

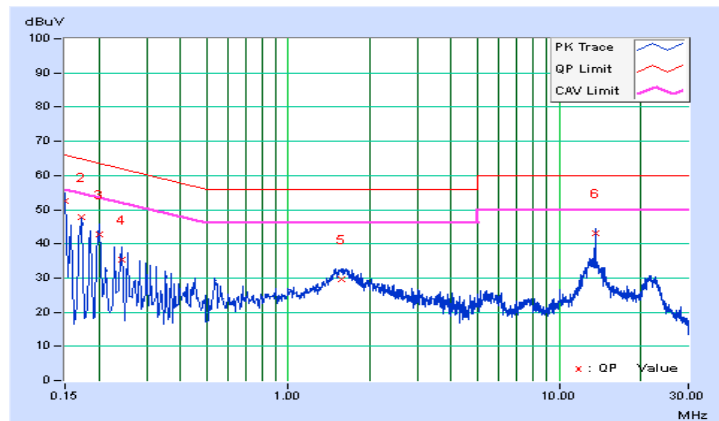

4.3 Frequency Stability

4.3.1 Limits of Frequency Stability Measurement

The frequency tolerance of the carrier signal shall be maintained within +/- 0.01 % of the operating frequency over a temperature variation of -20 degrees to 50 degrees C at normal supply voltage, and for a variation in the primary supply voltage from 85 % to 115% of the rated supply voltage at a temperature of 20 degrees C.

4.3.2 Test Setup

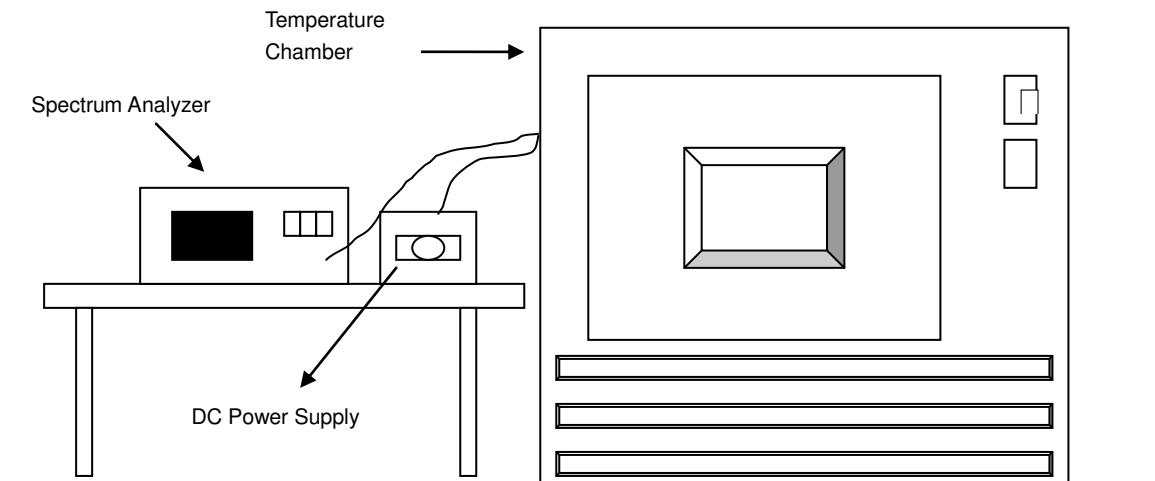

4.3.3 Test Instruments

Refer to section 4.1.2 to get information of above instrument.

4.3.4 Test Procedure

- The EUT was placed inside the environmental test chamber and powered by nominal AC voltage.
- Turned the EUT on and coupled its output to a spectrum analyzer.
- Turned the EUT off and set the chamber to the highest temperature specified.
- Allowed sufficient time (approximately 30 min) for the temperature of the chamber to stabilize then turned the EUT on and measured the operating frequency after 2, 5, and 10 minutes.
- Repeated step 2 and 3 with the temperature chamber set to the lowest temperature.
- The test chamber was allowed to stabilize at +20 degree C for a minimum of 30 minutes. The supply voltage was then adjusted on the EUT from 85 % to 115 % and the frequency record.

4.3.5 Deviation from Test Standard

No deviation.

4.3.6 EUT Operating Conditions

- Placed the EUT on the testing table.
- Set the EUT under transmission condition continuously at specific channel frequency.

4.3.7 Test Result

Frequency Stability Versus Temperature									
Temp. (°C)	Power Supply (Vdc)	0 Minute		2 Minute		5 Minute		10 Minute	
		Measured Frequency	Frequency Drift	Measured Frequency	Frequency Drift	Measured Frequency	Frequency Drift	Measured Frequency	Frequency Drift
		(MHz)	%	(MHz)	%	(MHz)	%	(MHz)	%
55	19.5	13.559986	-0.00010	13.559979	-0.00015	13.559988	-0.00009	13.559981	-0.00014
50	19.5	13.560008	0.00006	13.560015	0.00011	13.560017	0.00013	13.560016	0.00012
40	19.5	13.559958	-0.00031	13.559977	-0.00017	13.559953	-0.00035	13.559978	-0.00016
30	19.5	13.560012	0.00009	13.560008	0.00006	13.560002	0.00001	13.560017	0.00013
20	19.5	13.559934	-0.00049	13.559954	-0.00034	13.559939	-0.00045	13.559959	-0.00030
10	19.5	13.559999	-0.00001	13.560017	0.00013	13.560005	0.00004	13.560016	0.00012
0	19.5	13.560040	0.00029	13.560046	0.00034	13.560033	0.00024	13.560029	0.00021
-10	19.5	13.559998	-0.00001	13.560006	0.00004	13.560019	0.00014	13.560026	0.00019
-20	19.5	13.560051	0.00038	13.560043	0.00032	13.560057	0.00042	13.560050	0.00037
-30	19.5	13.559959	-0.00030	13.559930	-0.00052	13.559944	-0.00041	13.559956	-0.00032

Frequency Stability Versus Voltage									
Temp. (°C)	Power Supply (Vdc)	0 Minute		2 Minute		5 Minute		10 Minute	
		Measured Frequency	Frequency Drift	Measured Frequency	Frequency Drift	Measured Frequency	Frequency Drift	Measured Frequency	Frequency Drift
		(MHz)	%	(MHz)	%	(MHz)	%	(MHz)	%
20	22.425	13.559933	-0.00049	13.559955	-0.00033	13.559938	-0.00046	13.559957	-0.00032
	19.5	13.559934	-0.00049	13.559954	-0.00034	13.559939	-0.00045	13.559959	-0.00030
	16.575	13.559934	-0.00049	13.559957	-0.00032	13.559937	-0.00046	13.559957	-0.00032

4.4 20 dB Bandwidth

4.4.1 Limits of 20 dB Bandwidth Measurement

The 20 dB bandwidth shall be specified in operating frequency band.

4.4.2 Test Setup

Refer to section 4.1.5.

4.4.3 Test Instruments

Refer to section 4.1.2 to get information of above instrument.

4.4.4 Test Procedures

The bandwidth of the fundamental frequency was measured by spectrum analyzer with 1 kHz RBW and 3 kHz VBW. The 20 dB bandwidth is defined as the total spectrum the power of which is higher than peak power minus 20 dB.

4.4.5 Deviation from Test Standard

No deviation.

4.4.6 EUT Operating Conditions

- a. Placed the EUT on the testing table.
- b. Set the EUT under transmission condition continuously at specific channel frequency.

4.4.7 Test Results

Mode A

20 dBc Point (Low)	20 dBc Point (High)	Operating Frequency Band (MHz)	Pass / Fail
13.558653846 MHz	13.561250000 MHz	13.553~13.567	Pass

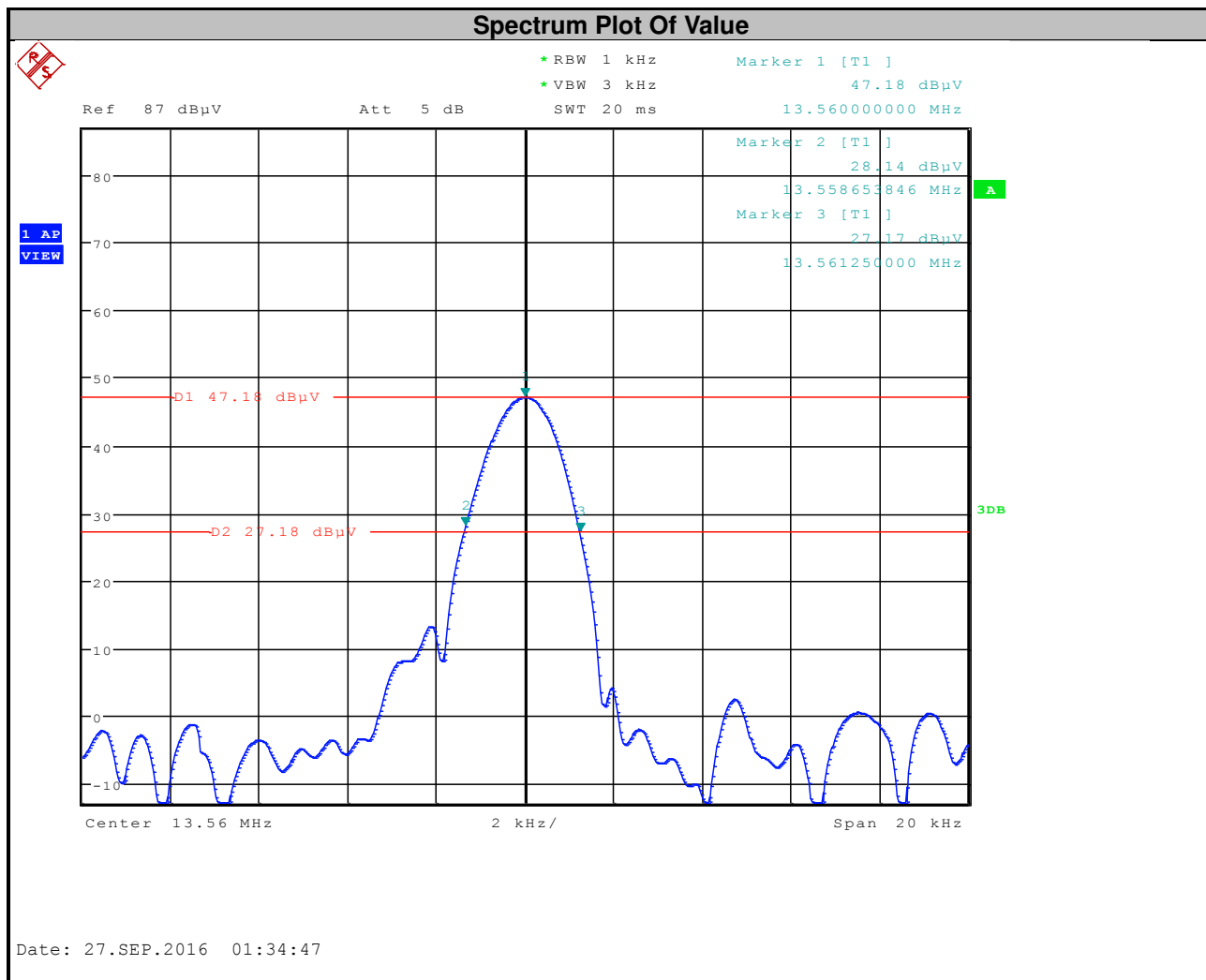

Mode B

20 dBc Point (Low)	20 dBc Point (High)	Operating Frequency Band (MHz)	Pass / Fail
13.558621795 MHz	13.561217949 MHz	13.553~13.567	Pass

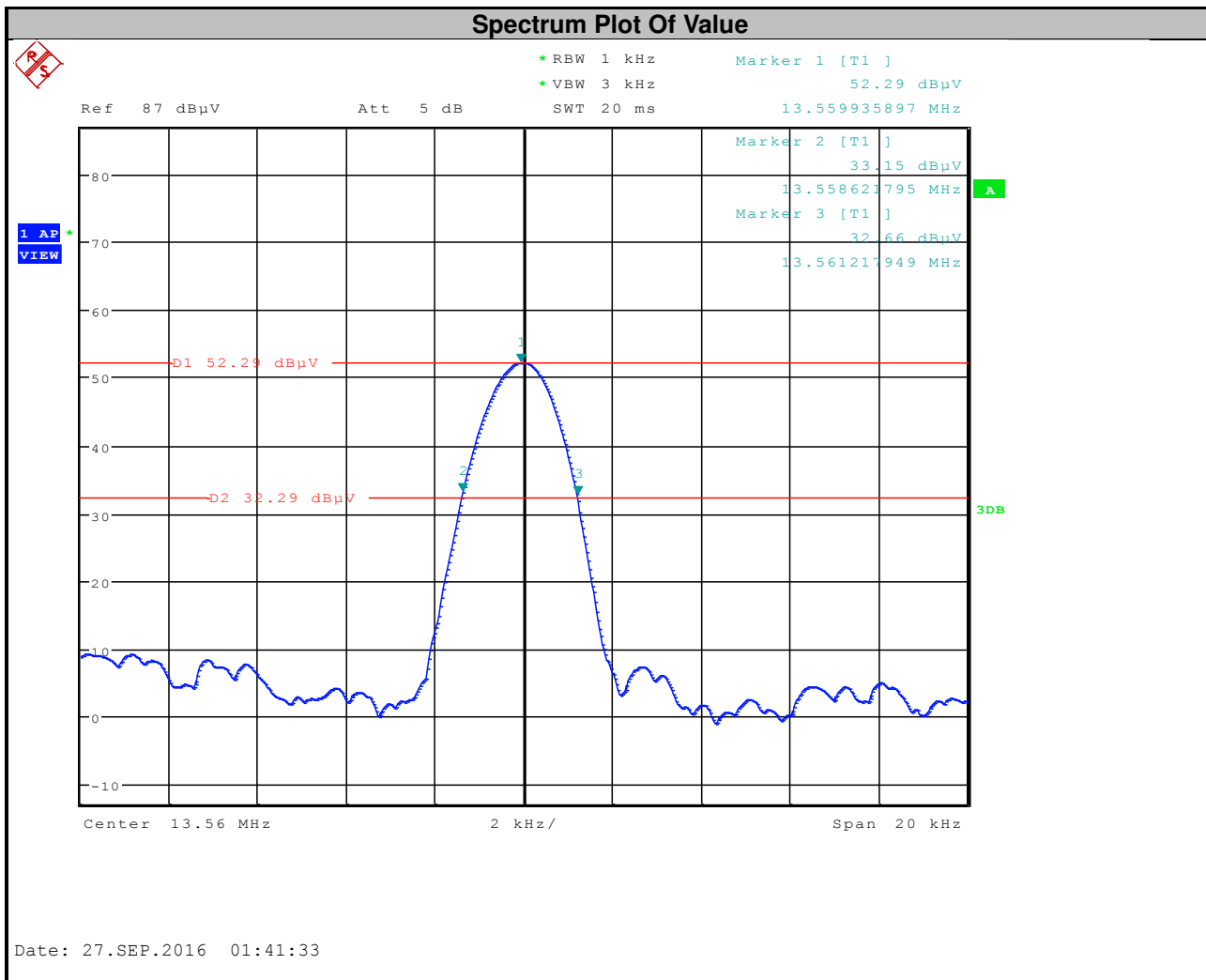

5 Pictures of Test Arrangements

Please refer to the attached file (Test Setup Photo).

Appendix – Information on the Testing Laboratories

We, Bureau Veritas Consumer Products Services (H.K.) Ltd., Taoyuan Branch, were founded in 1988 to provide our best service in EMC, Radio, Telecom and Safety consultation. Our laboratories are accredited and approved according to ISO/IEC 17025.

If you have any comments, please feel free to contact us at the following:

Linko EMC/RF Lab

Tel: 886-2-26052180

Fax: 886-2-26051924

Hsin Chu EMC/RF/Telecom Lab

Tel: 886-3-6668565

Fax: 886-3-6668323

Hwa Ya EMC/RF/Safety

Tel: 886-3-3183232

Fax: 886-3-3270892

Email: service.adt@tw.bureauveritas.com

Web Site: www.bureauveritas-adt.com

The address and road map of all our labs can be found in our web site also.

--- END ---