

ELECTROMAGNETIC EMISSIONS COMPLIANCE REPORT

INTENTIONAL RADIATOR CERTIFICATION TO FCC PART 15 SUBPART C AND INDUSTRY CANADA RSS 210 REQUIREMENT CLASS II & IV PC REPORT

OF

Applicant: Dell Inc.
Product Name: One Dell Way, Round Rock, Texas 78682, USA
Brand Name: RFID13.56MHz Wireless Module
Model Name: DELL
Model No.: DWRFID1601
Model Difference: N/A
FCC ID: E2K-DWRFID1601
IC: 1514B-DWRFID1601
Report Number: ER/2018/60084
FCC Rule Part: §15.225
IC Rule: RSS-210 issue 9 Nov. 2017
Issue Date: Jul. 25, 2018
Date of Test: Jun. 21, 2018 ~ Jul. 20, 2018
Date of EUT Received: Jun. 21, 2018

We hereby certify that:

The above equipment was tested by SGS Taiwan Ltd. The test data, data evaluation, test procedures, and equipment configurations shown in this report were made in accordance with the procedures given in ANSI C63.10:2013 and the energy emitted by the sample EUT tested as described in this report is in compliance with conducted and radiated emission limits.

The test results of this report relate only to the tested sample identified in this report.

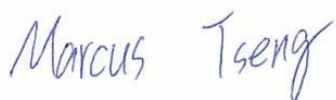
Tested By: 

Marcus Tseng / Sr. Engineer

Approved By: 

Jim Chang / Manager



Unless otherwise stated the results shown in this test report refer only to the sample(s) tested and such sample(s) are retained for 90 days only.
除非另有說明，此報告結果僅對測試之樣品負責，同時此樣品僅保留90天。本報告未經本公司書面許可，不可部份複製。

This document is issued by the Company subject to its General Conditions of Service printed overleaf, available on request or accessible at www.sgs.com/terms_and_conditions.htm and, for electronic format documents, subject to Terms and Conditions for Electronic Documents at www.sgs.com/terms_e-document.htm. Attention is drawn to the limitation of liability, indemnification and jurisdiction issues defined therein. Any holder of this document is advised that information contained hereon reflects the Company's findings at the time of its intervention only and within the limits of Client's instructions, if any. The Company's sole responsibility is to its Client and this document does not exonerate parties to a transaction from exercising all their rights and obligations under the transaction documents. This document cannot be reproduced except in full, without prior written approval of the Company. Any unauthorized alteration, forgery or falsification of the content or appearance of this document is unlawful and offenders may be prosecuted to the fullest extent of the law.

Revision History

Report Number	Revision	Description	Effected Page	Issue Date	Revised By
ER/2018/60084	Rev.00	Initial creation of document	All	Jul. 25, 2018	Violetta Tang

Unless otherwise stated the results shown in this test report refer only to the sample(s) tested and such sample(s) are retained for 90 days only.

除非另有說明，此報告結果僅對測試之樣品負責，同時此樣品僅保留90天。本報告未經本公司書面許可，不可部份複製。

This document is issued by the Company subject to its General Conditions of Service printed overleaf, available on request or accessible at www.sgs.com/terms_and_conditions.htm and, for electronic format documents, subject to Terms and Conditions for Electronic Documents at www.sgs.com/terms_e-document.htm. Attention is drawn to the limitation of liability, indemnification and jurisdiction issues defined therein. Any holder of this document is advised that information contained hereon reflects the Company's findings at the time of its intervention only and within the limits of Client's instructions, if any. The Company's sole responsibility is to its Client and this document does not exonerate parties to a transaction from exercising all their rights and obligations under the transaction documents. This document cannot be reproduced except in full, without prior written approval of the Company. Any unauthorized alteration, forgery or falsification of the content or appearance of this document is unlawful and offenders may be prosecuted to the fullest extent of the law.

SGS Taiwan Ltd. No.134, WuKungRoad, NewTaipeiIndustrialPark, WukuDistrict, NewTaipeiCity, Taiwan24803/新北市五股區新北產業園區五工路134號

台灣檢驗科技股份有限公司 t (886-2) 2299-3279

f (886-2) 2298-0488

www.tw.sgs.com

Member of SGS Group

Contents

1	GENERAL INFORMATION	4
2	SYSTEM TEST CONFIGURATION	6
3	SUMMARY OF TEST RESULTS	8
4	DESCRIPTION OF TEST MODES.....	8
5	MEASUREMENT UNCERTAINTY.....	9
6	CONDUCTED EMISSION TEST.....	10
7	RADIATED TEST ITEMS.....	18
8	FREQUENCY STABILITY	71
9	20 DB & 99% OCCUPIED BANDWIDTH MEASUREMENT.....	96
10	ANTENNA REQUIREMENT	100

Unless otherwise stated the results shown in this test report refer only to the sample(s) tested and such sample(s) are retained for 90 days only.

除非另有說明，此報告結果僅對測試之樣品負責，同時此樣品僅保留90天。本報告未經本公司書面許可，不可部份複製。

This document is issued by the Company subject to its General Conditions of Service printed overleaf, available on request or accessible at www.sgs.com/terms_and_conditions.htm and, for electronic format documents, subject to Terms and Conditions for Electronic Documents at www.sgs.com/terms_e-document.htm. Attention is drawn to the limitation of liability, indemnification and jurisdiction issues defined therein. Any holder of this document is advised that information contained hereon reflects the Company's findings at the time of its intervention only and within the limits of Client's instructions, if any. The Company's sole responsibility is to its Client and this document does not exonerate parties to a transaction from exercising all their rights and obligations under the transaction documents. This document cannot be reproduced except in full, without prior written approval of the Company. Any unauthorized alteration, forgery or falsification of the content or appearance of this document is unlawful and offenders may be prosecuted to the fullest extent of the law.

SGS Taiwan Ltd. No.134, WuKungRoad, NewTaipeiIndustrialPark, WukuDistrict, NewTaipeiCity, Taiwan24803/新北市五股區新北產業園區五工路134號

台灣檢驗科技股份有限公司 t (886-2) 2299-3279

f (886-2) 2298-0488

www.tw.sgs.com

Member of SGS Group

1 GENERAL INFORMATION

1.1 Product Description

General:

Product Name:	RFID13.56MHz Wireless Module	
Brand Name:	DELL	
Model No.:	DWRFID1601	
Model Difference:	N/A	
Product SW/HW version:	N/A / N/A	
Radio SW/HW version:	N/A / N/A	
Test SW Version:	N/A	
RF power setting in TEST SW:	N/A	
Power Supply:	3.6Vdc for High Supply Reader Mode 2.8Vdc for Low Supply Reader Mode	
Test Voltage:	120Vac Adapter (19.5Vdc from Adapter output)	
	Adapter:	1. Model No.: LA90PM130, Supplier: LiteOn 2. Model No.: HA90PM180, Supplier: Chicony
Class II & Class IV Permissive Change:	RFID Module (DWRFID1601) installed in Notebook Computers.	

NFC / RFID:

Operating Frequency:	13.56MHz
Transmit Power:	< 123.90dBuV/m at 3m.
Number of Channels:	1
Antenna Type:	Loop Antenna
Modulation Type:	ASK

Note: The transmitter module is authorized for using in the following specific End-products.

All test results are completed with three hosts named as Test mode_1, 2 and 3.

Product Name	Brand Name	Model No./Type No.	RFID Antenna
Notebook Computer	DELL	P85G	YAGEO/ANTA0DP12320NFCA1
Notebook Computer	DELL	P85G001	YAGEO/ANTA0DP12320NFCA2
Notebook Computer	DELL	P86G/P86G001	YAGEO/ANTA0DP12370NFCA1

Unless otherwise stated the results shown in this test report refer only to the sample(s) tested and such sample(s) are retained for 90 days only.

除非另有說明，此報告結果僅對測試之樣品負責，同時此樣品僅保留90天。本報告未經本公司書面許可，不可部份複製。

This document is issued by the Company subject to its General Conditions of Service printed overleaf, available on request or accessible at www.sgs.com/terms_and_conditions.htm and, for electronic format documents, subject to Terms and Conditions for Electronic Documents at www.sgs.com/terms_e-document.htm. Attention is drawn to the limitation of liability, indemnification and jurisdiction issues defined therein. Any holder of this document is advised that information contained hereon reflects the Company's findings at the time of its intervention only and within the limits of Client's instructions, if any. The Company's sole responsibility is to its Client and this document does not exonerate parties to a transaction from exercising all their rights and obligations under the transaction documents. This document cannot be reproduced except in full, without prior written approval of the Company. Any unauthorized alteration, forgery or falsification of the content or appearance of this document is unlawful and offenders may be prosecuted to the fullest extent of the law.

SGS Taiwan Ltd. No.134, WuKungRoad, NewTaipeiIndustrialPark, WukuDistrict, NewTaipeiCity, Taiwan24803/新北市五股區新北產業園區五工路134號

台灣檢驗科技股份有限公司 t (886-2) 2299-3279

f (886-2) 2298-0488

www.tw.sgs.com

Member of SGS Group

1.2 Test Methodology of Applied Standards

FCC Part 15, Subpart C §15.225

RSS 210 issue 9 Nov. 2017

RSS-Gen. issue 5 Apr. 2018

ANSI C63.10:2013

Note: All test items have been performed and recorded as per the above standards.

1.3 Test Facility

SGS Taiwan Ltd. Electronics & Communication Laboratory No.134, Wu Kung Road, New Taipei Industrial Park, Wuku District, New Taipei City, Taiwan 24803 (TAF code 0513)

FCC Registration Numbers are: 509634 / TW0001

Canada Registration Number: 4620A-5

1.4 Special Accessories

AC Adapter is used while the test is conducted and there is no other accessory attached. This is the worst case condition.

1.5 Equipment Modifications

There was no modification incorporated into the EUT.

Unless otherwise stated the results shown in this test report refer only to the sample(s) tested and such sample(s) are retained for 90 days only.

除非另有說明，此報告結果僅對測試之樣品負責，同時此樣品僅保留90天。本報告未經本公司書面許可，不可部份複製。

This document is issued by the Company subject to its General Conditions of Service printed overleaf, available on request or accessible at www.sgs.com/terms_and_conditions.htm and, for electronic format documents, subject to Terms and Conditions for Electronic Documents at www.sgs.com/terms_e-document.htm. Attention is drawn to the limitation of liability, indemnification and jurisdiction issues defined therein. Any holder of this document is advised that information contained hereon reflects the Company's findings at the time of its intervention only and within the limits of Client's instructions, if any. The Company's sole responsibility is to its Client and this document does not exonerate parties to a transaction from exercising all their rights and obligations under the transaction documents. This document cannot be reproduced except in full, without prior written approval of the Company. Any unauthorized alteration, forgery or falsification of the content or appearance of this document is unlawful and offenders may be prosecuted to the fullest extent of the law.

SGS Taiwan Ltd. No.134, WuKungRoad, NewTaipeiIndustrialPark, WukuDistrict, NewTaipeiCity, Taiwan24803/新北市五股區新北產業園區五工路134號

台灣檢驗科技股份有限公司 t (886-2) 2299-3279

f (886-2) 2298-0488

www.tw.sgs.com

Member of SGS Group

2 SYSTEM TEST CONFIGURATION

2.1 EUT Configuration

The EUT is configured to operate in a continuous transmission mode. EUT placement and various angles were checked to find worst mode where the emission characteristics are maximized.

2.2 EUT Exercise

Enable EUT NFC Function via Windows and use tag close to EUT NFC Antenna, in order to manipulate the EUT into continued exercised and transmit operation in normal mode.

2.3 Test Procedure

2.3.1 Conducted Emissions

EUT is a placed on turn table which is 0.8 m above ground plane. Connected to the public utility (AC) power line, the spacing between EUT is 10cm. Power cable were bundle 30 to 40cm and draped over the back edge of test table, and through section 2.2 the EUT is being exercise. Conducted emissions from the EUT measured in the frequency range between 0.15 MHz and 30MHz, The CISPR Quasi-Peak and Average detector mode is employed according to §15.207. The two LISNs provide 50 ohm/ 50uH of coupling impedance for the measuring instrument. Both lines of the power mains connected to the EUT were checked for maximum conducted interference.

2.3.2 Radiated Emissions

The EUT is a placed on as turn table which is 0.8 m above ground plan. The turn table shall rotate 360 degrees to determine the position of maximum emission level. EUT is set 3m away from the receiving antenna which varied from 1m to 4m to find out the highest emission. And also, each emission was to be maximized by changing the polarization of receiving antenna both horizontal and vertical. In order to find out the max. emission, the relative positions of this hand-held transmitter (EUT) was rotated through one orthogonal axe and measurement procedures for electric field radiated emissions above 1 GHz the EUT measurement is to be made "while keeping the antenna in the 'cone of radiation' from that area and pointed at the area both in azimuth and elevation, with polarization oriented for maximum response." is still within the 3dB illumination BW of the measurement antenna.

2.4 Measurement Results Explanation Example

For all conducted test items:

The offset level is set in the spectrum analyzer to compensate the RF cable loss and attenuation factor between EUT conducted port and spectrum analyzer. With the offset compensation, the spectrum analyzer reading level is exactly EUT RF output level.

Unless otherwise stated the results shown in this test report refer only to the sample(s) tested and such sample(s) are retained for 90 days only.

除非另有說明，此報告結果僅對測試之樣品負責，同時此樣品僅保留90天。本報告未經本公司書面許可，不可部份複製。

This document is issued by the Company subject to its General Conditions of Service printed overleaf, available on request or accessible at www.sgs.com/terms_and_conditions.htm and, for electronic format documents, subject to Terms and Conditions for Electronic Documents at www.sgs.com/terms_e-document.htm. Attention is drawn to the limitation of liability, indemnification and jurisdiction issues defined therein. Any holder of this document is advised that information contained hereon reflects the Company's findings at the time of its intervention only and within the limits of Client's instructions, if any. The Company's sole responsibility is to its Client and this document does not exonerate parties to a transaction from exercising all their rights and obligations under the transaction documents. This document cannot be reproduced except in full, without prior written approval of the Company. Any unauthorized alteration, forgery or falsification of the content or appearance of this document is unlawful and offenders may be prosecuted to the fullest extent of the law.

SGS Taiwan Ltd. No.134, WuKungRoad, NewTaipeiIndustrialPark, WukuDistrict, NewTaipeiCity, Taiwan24803/新北市五股區新北產業園區五工路134號

台灣檢驗科技股份有限公司 t (886-2) 2299-3279

f (886-2) 2298-0488

www.tw.sgs.com

Member of SGS Group

2.5 Configuration of Tested System

Fig. 2-1 Radiated Emission & AC Power Line Conducted Emission

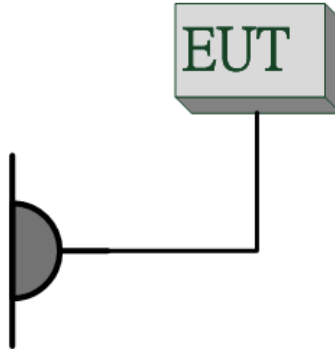

Table 2-1 Equipment Used in Tested System

Item	Equipment	Mfr/Brand	Model / Type No.	Series No.	Data Cable	Power Cord
1.	NFC / RFID Test Software	N/A	N/A	N/A	N/A	N/A

Unless otherwise stated the results shown in this test report refer only to the sample(s) tested and such sample(s) are retained for 90 days only.

除非另有說明，此報告結果僅對測試之樣品負責，同時此樣品僅保留90天。本報告未經本公司書面許可，不可部份複製。

This document is issued by the Company subject to its General Conditions of Service printed overleaf, available on request or accessible at www.sgs.com/terms_and_conditions.htm and, for electronic format documents, subject to Terms and Conditions for Electronic Documents at www.sgs.com/terms_e-document.htm. Attention is drawn to the limitation of liability, indemnification and jurisdiction issues defined therein. Any holder of this document is advised that information contained hereon reflects the Company's findings at the time of its intervention only and within the limits of Client's instructions, if any. The Company's sole responsibility is to its Client and this document does not exonerate parties to a transaction from exercising all their rights and obligations under the transaction documents. This document cannot be reproduced except in full, without prior written approval of the Company. Any unauthorized alteration, forgery or falsification of the content or appearance of this document is unlawful and offenders may be prosecuted to the fullest extent of the law.

SGS Taiwan Ltd. No.134, WuKungRoad, NewTaipeiIndustrialPark, WukuDistrict, NewTaipeiCity, Taiwan24803/新北市五股區新北產業園區五工路134號

台灣檢驗科技股份有限公司 t (886-2) 2299-3279

f (886-2) 2298-0488

www.tw.sgs.com

Member of SGS Group

3 SUMMARY OF TEST RESULTS

FCC Rules	IC Rules	Description Of Test	Result
§15.207	RSS-Gen § 8.8	AC Power Line Conducted Emission	Compliant
§15.225 (a)-(d)	RSS210 Annex B B.6	Radiated Emission	Compliant
§15.209	RSS-Gen § 8.9	Radiated Emission Limits, general requirement	Compliant
§15.225 (e)	RSS-Gen § 8.11	Frequency Stability	Compliant
§2.1049 §15.215 (c)	RSS-Gen § 6.7	20 dB & 99% OCCUPIED BANDWIDTH	Compliant
§15.203	RSS-Gen § 6.8	Antenna Requirement	Compliant

4 DESCRIPTION OF TEST MODES

4.1 The Worst Test Modes and Channel Details

1. The EUT stay in continuous transmitting mode.
2. The frequency 13.56 MHz is the default channel to test, where it is the only manipulative channel as this application supports.
3. Investigation has been done on all the possible configurations for searching the worst case.

RADIATED EMISSION TEST			
MODE	AVAILABLE CHANNEL	TESTED CHANNEL	MODULATION
NFC / RFID	1	1	ASK
FREQUENCY STABILITY			
MODE	AVAILABLE CHANNEL	TESTED CHANNEL	MODULATION
NFC / RFID	1	1	ASK
20dB BANDWIDTH			
MODE	AVAILABLE CHANNEL	TESTED CHANNEL	MODULATION
NFC / RFID	1	1	ASK

The field strength of spurious radiation emission was measured as EUT stand-up position (H, E1 mode) and lie down position (E2 mode) for NFC / RFID Transmitter for channel the worst case E2 position was reported.

Unless otherwise stated the results shown in this test report refer only to the sample(s) tested and such sample(s) are retained for 90 days only.

除非另有說明，此報告結果僅對測試之樣品負責，同時此樣品僅保留90天。本報告未經本公司書面許可，不可部份複製。

This document is issued by the Company subject to its General Conditions of Service printed overleaf, available on request or accessible at www.sgs.com/terms_and_conditions.htm and, for electronic format documents, subject to Terms and Conditions for Electronic Documents at www.sgs.com/terms_e-document.htm. Attention is drawn to the limitation of liability, indemnification and jurisdiction issues defined therein. Any holder of this document is advised that information contained hereon reflects the Company's findings at the time of its intervention only and within the limits of Client's instructions, if any. The Company's sole responsibility is to its Client and this document does not exonerate parties to a transaction from exercising all their rights and obligations under the transaction documents. This document cannot be reproduced except in full, without prior written approval of the Company. Any unauthorized alteration, forgery or falsification of the content or appearance of this document is unlawful and offenders may be prosecuted to the fullest extent of the law.

SGS Taiwan Ltd. No.134, WuKungRoad, NewTaipeiIndustrialPark, WukuDistrict, NewTaipeiCity, Taiwan24803/新北市五股區新北產業園區五工路134號

台灣檢驗科技股份有限公司 t (886-2) 2299-3279

f (886-2) 2298-0488

www.tw.sgs.com

Member of SGS Group

5 MEASUREMENT UNCERTAINTY

Test Items	Uncertainty
AC Power Line Conducted Emission	+/- 2.586 dB
Frequency Stability	+/- 51.33 Hz
20 dB & 99% OCCUPIED BANDWIDTH	+/- 51.33 Hz
Temperature	+/- 0.65 °C
Humidity	+/- 4.6 %
DC / AC Power Source	DC= +/- 0.13%, AC= +/- 0.2%

Radiated Spurious Emission:

Measurement uncertainty (Polarization : Vertical)	9kHz - 30MHz: +/- 2.87dB
	30MHz - 180MHz: +/- 3.37dB
	180MHz -417MHz: +/- 3.19dB
	0.417GHz-1GHz: +/- 3.19dB

Measurement uncertainty (Polarization : Horizontal)	9kHz - 30MHz: +/- 2.87dB
	30MHz - 167MHz: +/- 4.22dB
	167MHz -500MHz: +/- 3.44dB
	0.5GHz-1GHz: +/- 3.39dB

This uncertainty represents an expanded uncertainty expressed at approximately the 95% confidence level using a coverage factor of k=2.

Unless otherwise stated the results shown in this test report refer only to the sample(s) tested and such sample(s) are retained for 90 days only.

除非另有說明，此報告結果僅對測試之樣品負責，同時此樣品僅保留90天。本報告未經本公司書面許可，不可部份複製。

This document is issued by the Company subject to its General Conditions of Service printed overleaf, available on request or accessible at www.sgs.com/terms_and_conditions.htm and, for electronic format documents, subject to Terms and Conditions for Electronic Documents at www.sgs.com/terms_e-document.htm. Attention is drawn to the limitation of liability, indemnification and jurisdiction issues defined therein. Any holder of this document is advised that information contained hereon reflects the Company's findings at the time of its intervention only and within the limits of Client's instructions, if any. The Company's sole responsibility is to its Client and this document does not exonerate parties to a transaction from exercising all their rights and obligations under the transaction documents. This document cannot be reproduced except in full, without prior written approval of the Company. Any unauthorized alteration, forgery or falsification of the content or appearance of this document is unlawful and offenders may be prosecuted to the fullest extent of the law.

SGS Taiwan Ltd. No.134, WuKungRoad, NewTaipeiIndustrialPark, WukuDistrict, NewTaipeiCity, Taiwan24803/新北市五股區新北產業園區五工路134號

台灣檢驗科技股份有限公司 t (886-2) 2299-3279

f (886-2) 2298-0488

www.tw.sgs.com

Member of SGS Group

6 CONDUCTED EMISSION TEST

6.1 Standard Applicable:

Frequency range within 150kHz to 30MHz shall not exceed the Limit table as below.

Frequency range MHz	Limits dB(uV)	
	Quasi-peak	Average
0.15 to 0.50	66 to 56	56 to 46
0.50 to 5	56	46
5 to 30	60	50

Note

- The lower limit shall apply at the transition frequencies
- The limit decreases linearly with the logarithm of the frequency in the range 0.15 MHz to 0.50 MHz.

6.2 Measurement Equipment Used:

EQUIPMENT TYPE	MFR	MODEL NUMBER	SERIAL NUMBER	LAST CAL.	CAL DUE.
EMI Test Receiver	R&S	ESC17	100335	02/02/2018	02/01/2019
LISN	SCHWARZBECK	NSLK 8127	8127-649	05/18/2018	05/17/2019

6.3 EUT Setup:

- The conducted emission tests were performed in the test site, using the setup in accordance with the ANSI C63.10:2013.
- The AC/DC Power adaptor of EUT was plug-in LISN. The EUT was placed flushed with the rear of the table.
- The LISN was connected with 120Vac/60Hz power source.

Unless otherwise stated the results shown in this test report refer only to the sample(s) tested and such sample(s) are retained for 90 days only.

除非另有說明，此報告結果僅對測試之樣品負責，同時此樣品僅保留90天。本報告未經本公司書面許可，不可部份複製。

This document is issued by the Company subject to its General Conditions of Service printed overleaf, available on request or accessible at www.sgs.com/terms_and_conditions.htm and, for electronic format documents, subject to Terms and Conditions for Electronic Documents at www.sgs.com/terms_e-document.htm. Attention is drawn to the limitation of liability, indemnification and jurisdiction issues defined therein. Any holder of this document is advised that information contained hereon reflects the Company's findings at the time of its intervention only and within the limits of Client's instructions, if any. The Company's sole responsibility is to its Client and this document does not exonerate parties to a transaction from exercising all their rights and obligations under the transaction documents. This document cannot be reproduced except in full, without prior written approval of the Company. Any unauthorized alteration, forgery or falsification of the content or appearance of this document is unlawful and offenders may be prosecuted to the fullest extent of the law.

SGS Taiwan Ltd. No.134, WuKungRoad, NewTaipeiIndustrialPark, WukuDistrict, NewTaipeiCity, Taiwan24803/新北市五股區新北產業園區五工路134號

台灣檢驗科技股份有限公司 t (886-2) 2299-3279

f (886-2) 2298-0488

www.tw.sgs.com

Member of SGS Group

6.4 Test SET-UP (Block Diagram of Configuration)

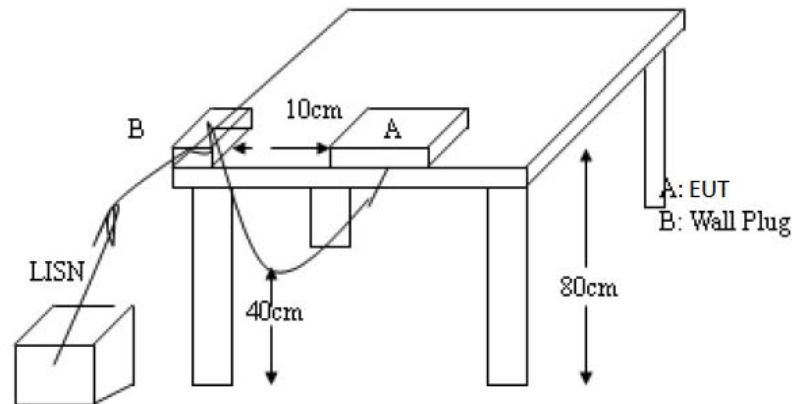

6.5 Measurement Procedure:

1. The EUT was placed on a table which is 0.8m above ground plane.
2. Maximum procedure was performed on the six highest emissions to ensure EUT compliance.
3. Repeat above procedures until all frequency measured were complete.

6.6 Measurement Result:

Note: Refer to next page for measurement data and plots.

Note2: The * reveals the worst-case results that closet to the limit

Unless otherwise stated the results shown in this test report refer only to the sample(s) tested and such sample(s) are retained for 90 days only.

除非另有說明，此報告結果僅對測試之樣品負責，同時此樣品僅保留90天。本報告未經本公司書面許可，不可部份複製。

This document is issued by the Company subject to its General Conditions of Service printed overleaf, available on request or accessible at www.sgs.com/terms_and_conditions.htm and, for electronic format documents, subject to Terms and Conditions for Electronic Documents at www.sgs.com/terms_e-document.htm. Attention is drawn to the limitation of liability, indemnification and jurisdiction issues defined therein. Any holder of this document is advised that information contained hereon reflects the Company's findings at the time of its intervention only and within the limits of Client's instructions, if any. The Company's sole responsibility is to its Client and this document does not exonerate parties to a transaction from exercising all their rights and obligations under the transaction documents. This document cannot be reproduced except in full, without prior written approval of the Company. Any unauthorized alteration, forgery or falsification of the content or appearance of this document is unlawful and offenders may be prosecuted to the fullest extent of the law.

SGS Taiwan Ltd. No.134, WuKungRoad, NewTaipeiIndustrialPark, WukuDistrict, NewTaipeiCity, Taiwan24803/新北市五股區新北產業園區五工路134號

台灣檢驗科技股份有限公司 t (886-2) 2299-3279

f (886-2) 2298-0488

www.tw.sgs.com

Member of SGS Group

AC POWER LINE CONDUCTED EMISSION TEST DATA

Test mode_1

Site: Conduction Room	Phase: L1	Temperature: 25 °C
Limit: FCC Class B Conduction(QP)	Power: AC 120V/60Hz	Humidity: 85 %
Mode: Operation		
Note: Adapter:LA90PM130		

Conducted Emission

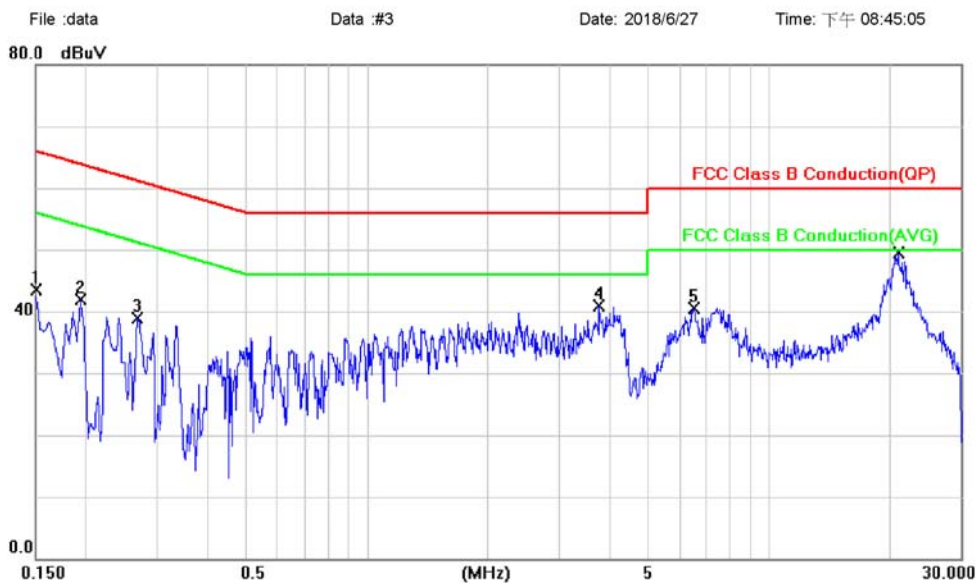

No.	Mk.	Freq.	Reading Level	Correct Factor	Measurement	Limit	Over	Detector	Comment
		MHz	dBuV	dB	dBuV	dBuV	dB		
1		0.1500	43.52	0.04	43.56	66.00	-22.44	peak	
2		0.1940	41.88	0.04	41.92	63.86	-21.94	peak	
3		0.2700	38.84	0.04	38.88	61.12	-22.24	peak	
4		3.7860	40.66	0.15	40.81	56.00	-15.19	peak	
5		6.4900	40.31	0.24	40.55	60.00	-19.45	peak	
6	*	20.9500	46.90	0.43	47.33	60.00	-12.67	QP	
7		20.9500	35.80	0.43	36.23	50.00	-13.77	AVG	

Unless otherwise stated the results shown in this test report refer only to the sample(s) tested and such sample(s) are retained for 90 days only.

除非另有說明，此報告結果僅對測試之樣品負責，同時此樣品僅保留90天。本報告未經本公司書面許可，不可部份複製。

This document is issued by the Company subject to its General Conditions of Service printed overleaf, available on request or accessible at www.sgs.com/terms_and_conditions.htm and, for electronic format documents, subject to Terms and Conditions for Electronic Documents at www.sgs.com/terms_e-document.htm. Attention is drawn to the limitation of liability, indemnification and jurisdiction issues defined therein. Any holder of this document is advised that information contained hereon reflects the Company's findings at the time of its intervention only and within the limits of Client's instructions, if any. The Company's sole responsibility is to its Client and this document does not exonerate parties to a transaction from exercising all their rights and obligations under the transaction documents. This document cannot be reproduced except in full, without prior written approval of the Company. Any unauthorized alteration, forgery or falsification of the content or appearance of this document is unlawful and offenders may be prosecuted to the fullest extent of the law.

SGS Taiwan Ltd. No.134, WuKungRoad, NewTaipeiIndustrialPark, WukuDistrict, NewTaipeiCity, Taiwan24803/新北市五股區新北產業園區五工路134號

台灣檢驗科技股份有限公司 t (886-2) 2299-3279

f (886-2) 2298-0488

www.tw.sgs.com

Member of SGS Group

Site: Conduction Room	Phase: N	Temperature: 25 °C
Limit: FCC Class B Conduction(QP)	Power: AC 120V/60Hz	Humidity: 85 %
Mode: Operation		
Note: Adapter:LA90PM130		

Conducted Emission

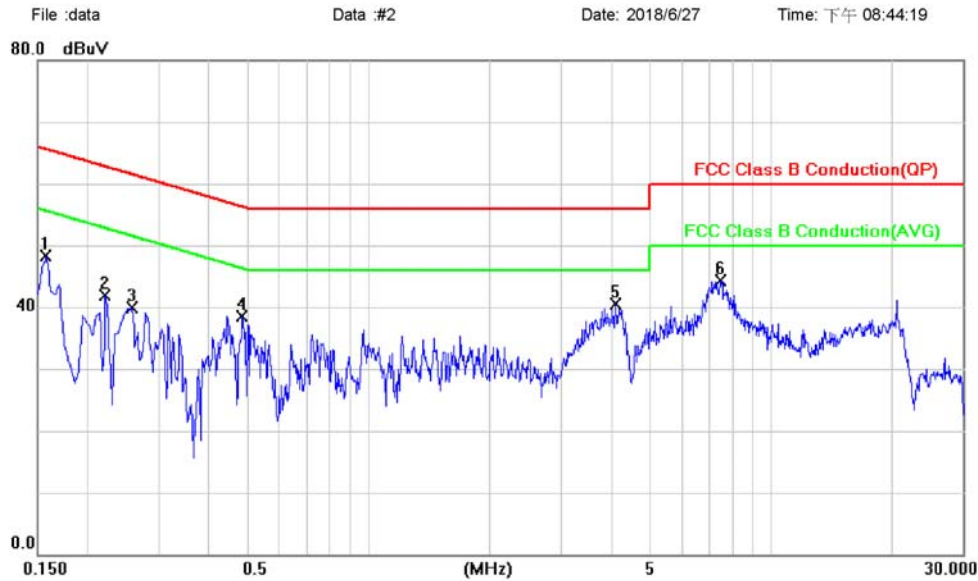

No.	Mk.	Freq. MHz	Reading Level dBuV	Correct Factor dB	Measure- ment dBuV	Limit dBuV	Over dB	Detector	Comment
1		0.1580	48.17	0.04	48.21	65.57	-17.36	peak	
2		0.2220	41.77	0.04	41.81	62.74	-20.93	peak	
3		0.2580	39.91	0.04	39.95	61.50	-21.55	peak	
4		0.4860	38.50	0.04	38.54	56.24	-17.70	peak	
5	*	4.1140	40.37	0.16	40.53	56.00	-15.47	peak	
6		7.5220	43.97	0.25	44.22	60.00	-15.78	peak	

Unless otherwise stated the results shown in this test report refer only to the sample(s) tested and such sample(s) are retained for 90 days only.

除非另有說明，此報告結果僅對測試之樣品負責，同時此樣品僅保留90天。本報告未經本公司書面許可，不可部份複製。

This document is issued by the Company subject to its General Conditions of Service printed overleaf, available on request or accessible at www.sgs.com/terms_and_conditions.htm and, for electronic format documents, subject to Terms and Conditions for Electronic Documents at www.sgs.com/terms_e-document.htm. Attention is drawn to the limitation of liability, indemnification and jurisdiction issues defined therein. Any holder of this document is advised that information contained hereon reflects the Company's findings at the time of its intervention only and within the limits of Client's instructions, if any. The Company's sole responsibility is to its Client and this document does not exonerate parties to a transaction from exercising all their rights and obligations under the transaction documents. This document cannot be reproduced except in full, without prior written approval of the Company. Any unauthorized alteration, forgery or falsification of the content or appearance of this document is unlawful and offenders may be prosecuted to the fullest extent of the law.

SGS Taiwan Ltd. No.134, WuKungRoad, NewTaipeiIndustrialPark, WukuDistrict, NewTaipeiCity, Taiwan24803/新北市五股區新北產業園區五工路134號

台灣檢驗科技股份有限公司 t (886-2) 2299-3279

f (886-2) 2298-0488

www.tw.sgs.com

Member of SGS Group

Test mode_2

Site: Conduction Room	Phase: L1	Temperature: 25 °C
Limit: FCC Class B Conduction(QP)	Power: AC 120V/60Hz	Humidity: 85 %
Mode: Operation		
Note: Adapter:LA90PM130		

Conducted Emission

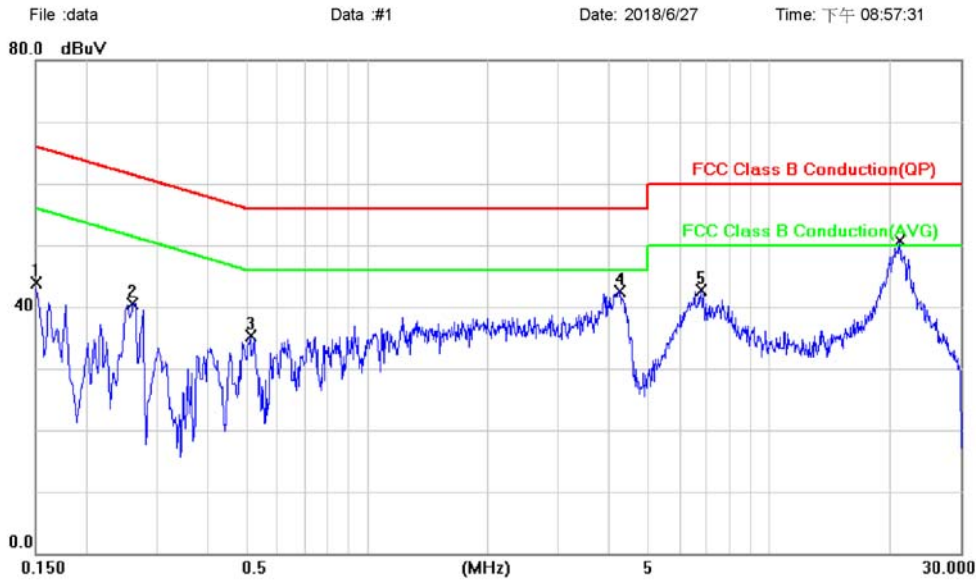

No.	Mk.	Freq. MHz	Reading Level dBuV	Correct Factor dB	Measure- ment dBuV	Limit dBuV	Over dB	Detector	Comment
1		0.1500	43.93	0.03	43.96	66.00	-22.04	peak	
2		0.2620	40.49	0.03	40.52	61.37	-20.85	peak	
3		0.5140	35.24	0.04	35.28	56.00	-20.72	peak	
4 *		4.2580	42.43	0.17	42.60	56.00	-13.40	peak	
5		6.7940	42.41	0.24	42.65	60.00	-17.35	peak	
6		21.1780	44.20	0.42	44.62	60.00	-15.38	QP	
7		21.1780	36.10	0.42	36.52	50.00	-13.48	AVG	

Unless otherwise stated the results shown in this test report refer only to the sample(s) tested and such sample(s) are retained for 90 days only.

除非另有說明，此報告結果僅對測試之樣品負責，同時此樣品僅保留90天。本報告未經本公司書面許可，不可部份複製。

This document is issued by the Company subject to its General Conditions of Service printed overleaf, available on request or accessible at www.sgs.com/terms_and_conditions.htm and, for electronic format documents, subject to Terms and Conditions for Electronic Documents at www.sgs.com/terms_e-document.htm. Attention is drawn to the limitation of liability, indemnification and jurisdiction issues defined therein. Any holder of this document is advised that information contained hereon reflects the Company's findings at the time of its intervention only and within the limits of Client's instructions, if any. The Company's sole responsibility is to its Client and this document does not exonerate parties to a transaction from exercising all their rights and obligations under the transaction documents. This document cannot be reproduced except in full, without prior written approval of the Company. Any unauthorized alteration, forgery or falsification of the content or appearance of this document is unlawful and offenders may be prosecuted to the fullest extent of the law.

SGS Taiwan Ltd. No.134, WuKungRoad, NewTaipeiIndustrialPark, WukuDistrict, NewTaipeiCity, Taiwan24803/新北市五股區新北產業園區五工路134號

台灣檢驗科技股份有限公司 t (886-2) 2299-3279

f (886-2) 2298-0488

www.tw.sgs.com

Member of SGS Group

Site: Conduction Room	Phase: N	Temperature: 25 °C
Limit: FCC Class B Conduction(QP)	Power: AC 120V/60Hz	Humidity: 85 %
Mode: Operation		
Note: Adapter:LA90PM130		

Conducted Emission

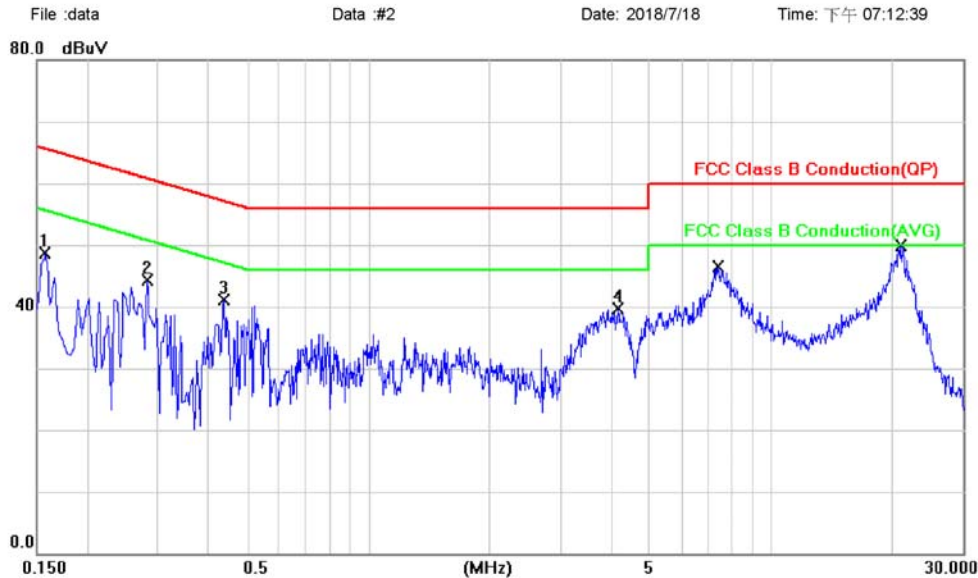

No.	Mk.	Freq. MHz	Reading Level dBuV	Correct Factor dB	Measure- ment dBuV	Limit dBuV	Over dB	Detector	Comment
1		0.1580	48.69	0.04	48.73	65.57	-16.84	peak	
2		0.2820	44.27	0.04	44.31	60.76	-16.45	peak	
3		0.4380	41.11	0.04	41.15	57.10	-15.95	peak	
4		4.1580	39.60	0.16	39.76	56.00	-16.24	peak	
5		7.3740	41.50	0.25	41.75	60.00	-18.25	QP	
6		7.3740	34.90	0.25	35.15	50.00	-14.85	AVG	
7		20.9460	43.60	0.43	44.03	60.00	-15.97	QP	
8 *		20.9460	35.10	0.43	35.53	50.00	-14.47	AVG	

Unless otherwise stated the results shown in this test report refer only to the sample(s) tested and such sample(s) are retained for 90 days only.

除非另有說明，此報告結果僅對測試之樣品負責，同時此樣品僅保留90天。本報告未經本公司書面許可，不可部份複製。

This document is issued by the Company subject to its General Conditions of Service printed overleaf, available on request or accessible at www.sgs.com/terms_and_conditions.htm and, for electronic format documents, subject to Terms and Conditions for Electronic Documents at www.sgs.com/terms_e-document.htm. Attention is drawn to the limitation of liability, indemnification and jurisdiction issues defined therein. Any holder of this document is advised that information contained hereon reflects the Company's findings at the time of its intervention only and within the limits of Client's instructions, if any. The Company's sole responsibility is to its Client and this document does not exonerate parties to a transaction from exercising all their rights and obligations under the transaction documents. This document cannot be reproduced except in full, without prior written approval of the Company. Any unauthorized alteration, forgery or falsification of the content or appearance of this document is unlawful and offenders may be prosecuted to the fullest extent of the law.

SGS Taiwan Ltd. No.134, WuKungRoad, NewTaipeiIndustrialPark, WukuDistrict, NewTaipeiCity, Taiwan24803/新北市五股區新北產業園區五工路134號

台灣檢驗科技股份有限公司 t (886-2) 2299-3279

f (886-2) 2298-0488

www.tw.sgs.com

Member of SGS Group

Test mode_3

Site: Conduction Room	Phase: L1	Temperature: 25 °C
Limit: FCC Class B Conduction(QP)	Power: AC 120V/60Hz	Humidity: 85 %
Mode: Operation		
Note: Adapter: LA90PM130		

Conducted Emission

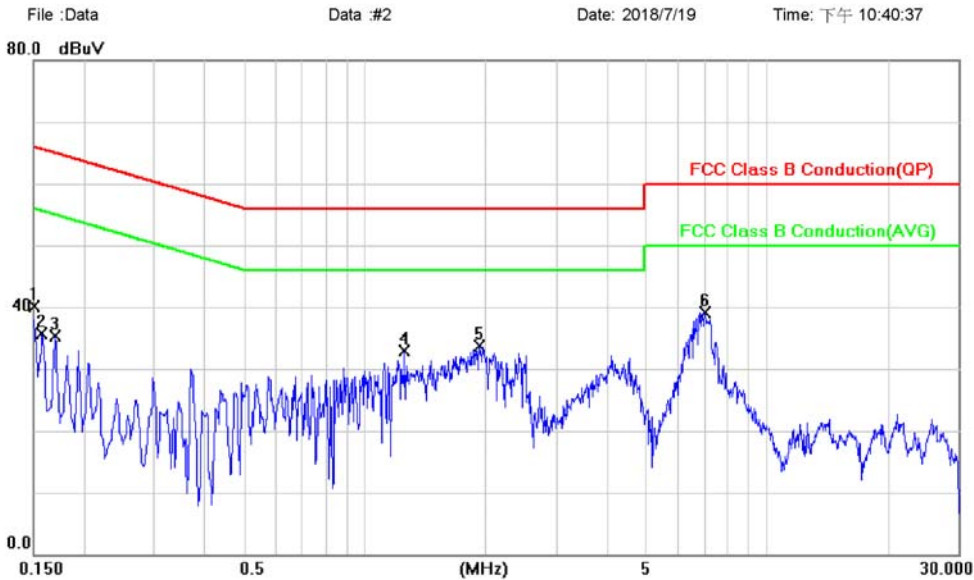

No.	Mk.	Freq.	Reading Level	Correct Factor	Measurement	Limit	Over	Detector	Comment
		MHz	dBuV	dB	dBuV	dBuV	dB		
1		0.1500	40.07	0.04	40.11	66.00	-25.89	peak	
2		0.1580	35.65	0.04	35.69	65.57	-29.88	peak	
3		0.1700	35.27	0.04	35.31	64.96	-29.65	peak	
4		1.2620	32.78	0.06	32.84	56.00	-23.16	peak	
5		1.9340	33.65	0.07	33.72	56.00	-22.28	peak	
6	*	7.0540	38.93	0.25	39.18	60.00	-20.82	peak	

Unless otherwise stated the results shown in this test report refer only to the sample(s) tested and such sample(s) are retained for 90 days only.

除非另有說明，此報告結果僅對測試之樣品負責，同時此樣品僅保留90天。本報告未經本公司書面許可，不可部份複製。

This document is issued by the Company subject to its General Conditions of Service printed overleaf, available on request or accessible at www.sgs.com/terms_and_conditions.htm and, for electronic format documents, subject to Terms and Conditions for Electronic Documents at www.sgs.com/terms_e-document.htm. Attention is drawn to the limitation of liability, indemnification and jurisdiction issues defined therein. Any holder of this document is advised that information contained hereon reflects the Company's findings at the time of its intervention only and within the limits of Client's instructions, if any. The Company's sole responsibility is to its Client and this document does not exonerate parties to a transaction from exercising all their rights and obligations under the transaction documents. This document cannot be reproduced except in full, without prior written approval of the Company. Any unauthorized alteration, forgery or falsification of the content or appearance of this document is unlawful and offenders may be prosecuted to the fullest extent of the law.

SGS Taiwan Ltd. No.134, WuKungRoad, NewTaipeiIndustrialPark, WukuDistrict, NewTaipeiCity, Taiwan24803/新北市五股區新北產業園區五工路134號

台灣檢驗科技股份有限公司 t (886-2) 2299-3279

f (886-2) 2298-0488

www.tw.sgs.com

Member of SGS Group

Site: Conduction Room	Phase: N	Temperature: 25 °C
Limit: FCC Class B Conduction(QP)	Power: AC 120V/60Hz	Humidity: 85 %
Mode: Operation		
Note: Adapter: LA90PM130		

Conducted Emission

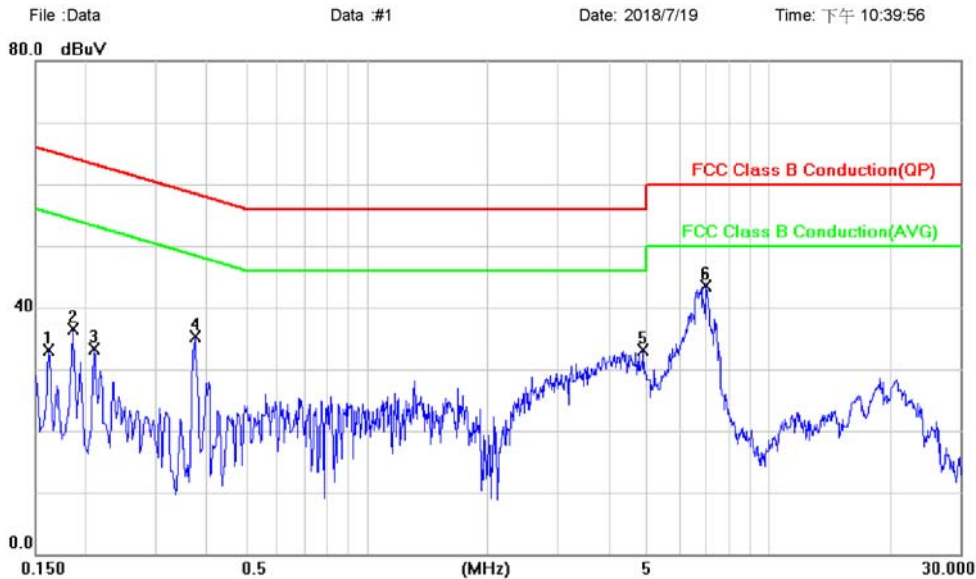

No.	Mk.	Freq.	Reading Level	Correct Factor	Measurement	Limit	Over	Detector	Comment
		MHz	dBuV	dB	dBuV	dBuV	dB		
1		0.1620	33.03	0.04	33.07	65.36	-32.29	peak	
2		0.1860	36.50	0.04	36.54	64.21	-27.67	peak	
3		0.2100	33.34	0.04	33.38	63.21	-29.83	peak	
4		0.3740	35.25	0.04	35.29	58.41	-23.12	peak	
5		4.8900	32.93	0.21	33.14	56.00	-22.86	peak	
6 *		6.9900	43.36	0.24	43.60	60.00	-16.40	peak	

Unless otherwise stated the results shown in this test report refer only to the sample(s) tested and such sample(s) are retained for 90 days only.

除非另有說明，此報告結果僅對測試之樣品負責，同時此樣品僅保留90天。本報告未經本公司書面許可，不可部份複製。

This document is issued by the Company subject to its General Conditions of Service printed overleaf, available on request or accessible at www.sgs.com/terms_and_conditions.htm and, for electronic format documents, subject to Terms and Conditions for Electronic Documents at www.sgs.com/terms_e-document.htm. Attention is drawn to the limitation of liability, indemnification and jurisdiction issues defined therein. Any holder of this document is advised that information contained hereon reflects the Company's findings at the time of its intervention only and within the limits of Client's instructions, if any. The Company's sole responsibility is to its Client and this document does not exonerate parties to a transaction from exercising all their rights and obligations under the transaction documents. This document cannot be reproduced except in full, without prior written approval of the Company. Any unauthorized alteration, forgery or falsification of the content or appearance of this document is unlawful and offenders may be prosecuted to the fullest extent of the law.

SGS Taiwan Ltd. No.134, WuKungRoad, NewTaipeiIndustrialPark, WukuDistrict, NewTaipeiCity, Taiwan24803/新北市五股區新北產業園區五工路134號

台灣檢驗科技股份有限公司 t (886-2) 2299-3279

f (886-2) 2298-0488

www.tw.sgs.com

Member of SGS Group

7 RADIATED TEST ITEMS

7.1 Measurement Procedure

1. Configure the EUT according to ANSI C63.10.
2. The EUT was placed on a turn table which is 0.8m above ground plane.
3. The turn table shall rotate 360 degrees to determine the position of maximum emission level.
4. EUT is set 3m away from the receiving antenna which varied from 1m to 4m to find out the highest emission.
5. Maximum procedure was performed on the six highest emissions to ensure EUT compliance.
6. And also, each emission was to be maximized by changing the polarization of receiving antenna both horizontal and vertical.
7. Repeat above procedures until all default test channel measured were complete

7.2 Test SET-UP

(A) Radiated Emission Test Set-Up, Frequency Below 30MHz

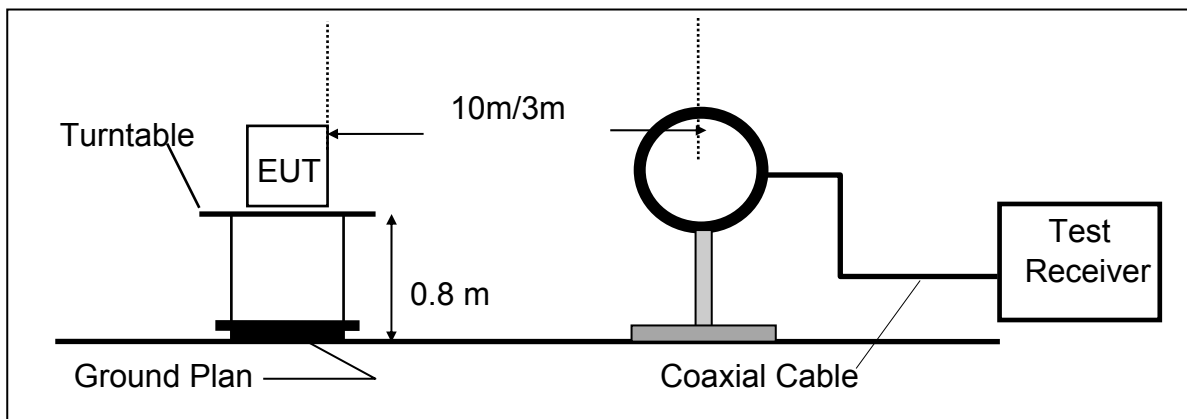

(B) Radiated Emission Test Set-Up, Frequency Below 1000MHz

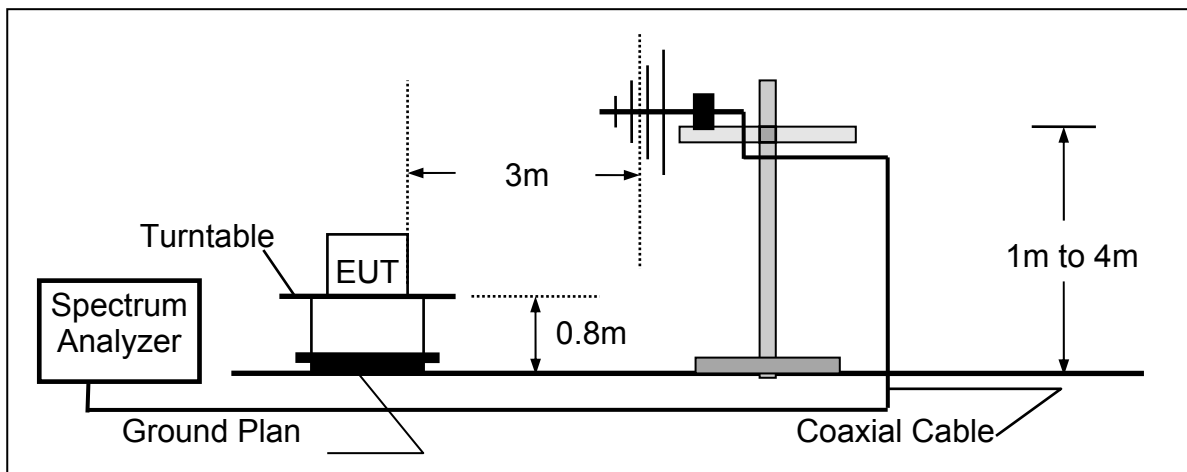

Unless otherwise stated the results shown in this test report refer only to the sample(s) tested and such sample(s) are retained for 90 days only.

除非另有說明，此報告結果僅對測試之樣品負責，同時此樣品僅保留90天。本報告未經本公司書面許可，不可部份複製。

This document is issued by the Company subject to its General Conditions of Service printed overleaf, available on request or accessible at www.sgs.com/terms_and_conditions.htm and, for electronic format documents, subject to Terms and Conditions for Electronic Documents at www.sgs.com/terms_e-document.htm. Attention is drawn to the limitation of liability, indemnification and jurisdiction issues defined therein. Any holder of this document is advised that information contained hereon reflects the Company's findings at the time of its intervention only and within the limits of Client's instructions, if any. The Company's sole responsibility is to its Client and this document does not exonerate parties to a transaction from exercising all their rights and obligations under the transaction documents. This document cannot be reproduced except in full, without prior written approval of the Company. Any unauthorized alteration, forgery or falsification of the content or appearance of this document is unlawful and offenders may be prosecuted to the fullest extent of the law.

SGS Taiwan Ltd. No.134, WuKungRoad, NewTaipeiIndustrialPark, WukuDistrict, NewTaipeiCity, Taiwan24803/新北市五股區新北產業園區五工路134號

台灣檢驗科技股份有限公司 t (886-2) 2299-3279

f (886-2) 2298-0488

www.tw.sgs.com

Member of SGS Group

7.3 Measurement Equipment Used

EQUIPMENT TYPE	MFR	MODEL NUMBER	SERIAL NUMBER	LAST CAL.	CAL DUE.
Bi-log Antenna	SCHWAZBECK	VULB9168	378	12/29/2017	12/28/2018
Horn Antenna	Schwarzbeck	BBHA9120D	1441	08/04/2017	08/03/2018
Loop Antenna	ETS.LINDGREN	6502	148045	09/26/2017	09/25/2018
3m Site NSA	SGS	966 chamber	N/A	01/02/2018	01/01/2019
Spectrum Analyzer	Agilent	E4446A	MY51100003	05/15/2018	05/14/2019
EMI Test Receiver	R&S	ESC17	100335	02/02/2018	02/01/2019
Pre-Amplifier	HP	8449B	3008A00578	01/02/2018	01/01/2019
Pre-Amplifier	HP	8447D	2944A07676	01/02/2018	01/01/2019
Pre-Amplifier	EMC Instruments	EMC184045B	980135	10/27/2017	10/26/2018
Attenuator	Mini-Circuit	BW-S10W2+	3	01/02/2018	01/01/2019
Low Loss Cable	Huber Suhner	966_RX	9	01/02/2018	01/01/2019

7.4 Field Strength Calculation

The field strength is calculated by adding the Antenna Factor and Cable Factor and subtracting the Amplifier Gain and Duty Cycle Correction Factor (if any) from the measured reading. The basic equation with a sample calculation is as follows:

$$FS = RA + AF + CL - AG$$

Where	FS = Field Strength	CL = Cable Attenuation Factor (Cable Loss)
	RA = Reading Amplitude	AG = Amplifier Gain
	AF = Antenna Factor	

The limit of the emission level is expressed in dBuV/m, which converts $20 \cdot \log(\mu\text{V}/\text{m})$

Actual FS(dB μ V/m) = SPA. Reading level(dB μ V) + Factor(dB)

Factor(dB) = Antenna Factor(dB/m) + Cable Loss(dB) – Pre_Amplifier Gain(dB)

Unless otherwise stated the results shown in this test report refer only to the sample(s) tested and such sample(s) are retained for 90 days only.

除非另有說明，此報告結果僅對測試之樣品負責，同時此樣品僅保留90天。本報告未經本公司書面許可，不可部份複製。

This document is issued by the Company subject to its General Conditions of Service printed overleaf, available on request or accessible at www.sgs.com/terms_and_conditions.htm and, for electronic format documents, subject to Terms and Conditions for Electronic Documents at www.sgs.com/terms_e-document.htm. Attention is drawn to the limitation of liability, indemnification and jurisdiction issues defined therein. Any holder of this document is advised that information contained hereon reflects the Company's findings at the time of its intervention only and within the limits of Client's instructions, if any. The Company's sole responsibility is to its Client and this document does not exonerate parties to a transaction from exercising all their rights and obligations under the transaction documents. This document cannot be reproduced except in full, without prior written approval of the Company. Any unauthorized alteration, forgery or falsification of the content or appearance of this document is unlawful and offenders may be prosecuted to the fullest extent of the law.

SGS Taiwan Ltd. No.134, WuKungRoad, NewTaipeiIndustrialPark, WukuDistrict, NewTaipeiCity, Taiwan24803/新北市五股區新北產業園區五工路134號

台灣檢驗科技股份有限公司 t (886-2) 2299-3279

f (886-2) 2298-0488

www.tw.sgs.com

Member of SGS Group

7.5 Field Strength of Fundamental Emissions and Mask Measurement

7.5.1 Standard Applicable

Limit:

Rules and specifications	CFR 47 Part 15 section 15.225(a)-(d)		
	Frequency of Emission (MHz)	Field Strength (μV/m)at 30m	Field Strength (dBμV/m)at 30m
1.705~13.110	30	29.5	69.5
13.110~13.410	106	40.5	80.5
13.410~13.553	334	50.5	90.47
13.553~13.567	15848	84	124
13.567~13.710	334	50.5	90.47
13.710~14.010	106	40.5	80.5
14.010~30.00	30	29.5	69.5

Field strength of fundamental emissions limit:

The field strength of fundamental emissions shall not exceed 15848 microrvolts/meter at 30 meters. The Limit is converted to 124.00dBuV/m by offsetting the distance extrapolation factor as measurement distance is taken place at 3 meters.

Distance extrapolation = $40 \cdot \log(30/3) = 40 \text{ dB}$

Limit is re-adjusted in terms of limit taken in 3m = $20 \cdot \log(15848 \text{ uV/m}) + 40 = 124.00\text{dBuV/m}$

1. Emission level in dBuV/m = $20 \log(\mu\text{V/m})$
2. Distance extrapolation factor = $40 \log(\text{required distance}/\text{test distance}) \text{ (dB)}$
3. The lower limit shall apply at the transition frequencies.
4. The measurement was undertaken in closer distance at 3m, where extrapolation factor is offset to convert the limit of the measurement.

Unless otherwise stated the results shown in this test report refer only to the sample(s) tested and such sample(s) are retained for 90 days only.

除非另有說明，此報告結果僅對測試之樣品負責，同時此樣品僅保留90天。本報告未經本公司書面許可，不可部份複製。

This document is issued by the Company subject to its General Conditions of Service printed overleaf, available on request or accessible at www.sgs.com/terms_and_conditions.htm and, for electronic format documents, subject to Terms and Conditions for Electronic Documents at www.sgs.com/terms_e-document.htm. Attention is drawn to the limitation of liability, indemnification and jurisdiction issues defined therein. Any holder of this document is advised that information contained hereon reflects the Company's findings at the time of its intervention only and within the limits of Client's instructions, if any. The Company's sole responsibility is to its Client and this document does not exonerate parties to a transaction from exercising all their rights and obligations under the transaction documents. This document cannot be reproduced except in full, without prior written approval of the Company. Any unauthorized alteration, forgery or falsification of the content or appearance of this document is unlawful and offenders may be prosecuted to the fullest extent of the law.

SGS Taiwan Ltd. No.134, WuKungRoad, NewTaipeiIndustrialPark, WukuDistrict, NewTaipeiCity, Taiwan24803/新北市五股區新北產業園區五工路134號

台灣檢驗科技股份有限公司 t (886-2) 2299-3279

f (886-2) 2298-0488

www.tw.sgs.com

Member of SGS Group

Radiated Mask for RSS 210 Annex B B6

- (a) 15.848 millivolts/m (84 dB μ V/m) at 30 m, within the band 13.553-13.567 MHz.
- (b) 334 microvolts/m (50.5 dB μ V/m) at 30 m, within the bands 13.410-13.553 MHz and 13.567-13.710 MHz.
- (c) 106 microvolts/m (40.5 dB μ V/m) at 30 m, within the bands 13.110-13.410 MHz and 13.710-14.010 MHz.
- (d) RSS-Gen general field strength limits for frequencies outside the band 13.110-14.010 MHz.

Distance extrapolation = $40 \cdot \log(30/3) = 40$ dB

Limit is re-adjusted in terms of limit taken in 3m for the following frequency segment of the interest:

- a) $20 \cdot \log(15848\mu\text{V/m}) + 40\text{dB} = 124.00\text{dB}\mu\text{V/m}$
- b) $20 \cdot \log(334\mu\text{V/m}) + 40\text{dB} = 90.47\text{dB}\mu\text{V/m}$
- c) $20 \cdot \log(106\mu\text{V/m}) + 40\text{dB} = 80.50\text{dB}\mu\text{V/m}$

Unless otherwise stated the results shown in this test report refer only to the sample(s) tested and such sample(s) are retained for 90 days only.

除非另有說明，此報告結果僅對測試之樣品負責，同時此樣品僅保留90天。本報告未經本公司書面許可，不可部份複製。

This document is issued by the Company subject to its General Conditions of Service printed overleaf, available on request or accessible at www.sgs.com/terms_and_conditions.htm and, for electronic format documents, subject to Terms and Conditions for Electronic Documents at www.sgs.com/terms_e-document.htm. Attention is drawn to the limitation of liability, indemnification and jurisdiction issues defined therein. Any holder of this document is advised that information contained hereon reflects the Company's findings at the time of its intervention only and within the limits of Client's instructions, if any. The Company's sole responsibility is to its Client and this document does not exonerate parties to a transaction from exercising all their rights and obligations under the transaction documents. This document cannot be reproduced except in full, without prior written approval of the Company. Any unauthorized alteration, forgery or falsification of the content or appearance of this document is unlawful and offenders may be prosecuted to the fullest extent of the law.

SGS Taiwan Ltd. No.134, WuKungRoad, NewTaipeiIndustrialPark, WukuDistrict, NewTaipeiCity, Taiwan24803/新北市五股區新北產業園區五工路134號

台灣檢驗科技股份有限公司 t (886-2) 2299-3279

f (886-2) 2298-0488

www.tw.sgs.com

Member of SGS Group

7.5.2 Field Strength of Fundamental Emission Measurement Result

NFC_Test mode_1

Operation Band	:NFC	Test Date	:2018-07-03
Fundamental Frequency	:13.56 MHz	Temp./Humi.	:19.2 deg_C/58RH
Operation Mode	:MAIN	Engineer	:Tin
EUT Pol.	:E2 Plane	Measurement Antenna Pol.	:VERTICAL

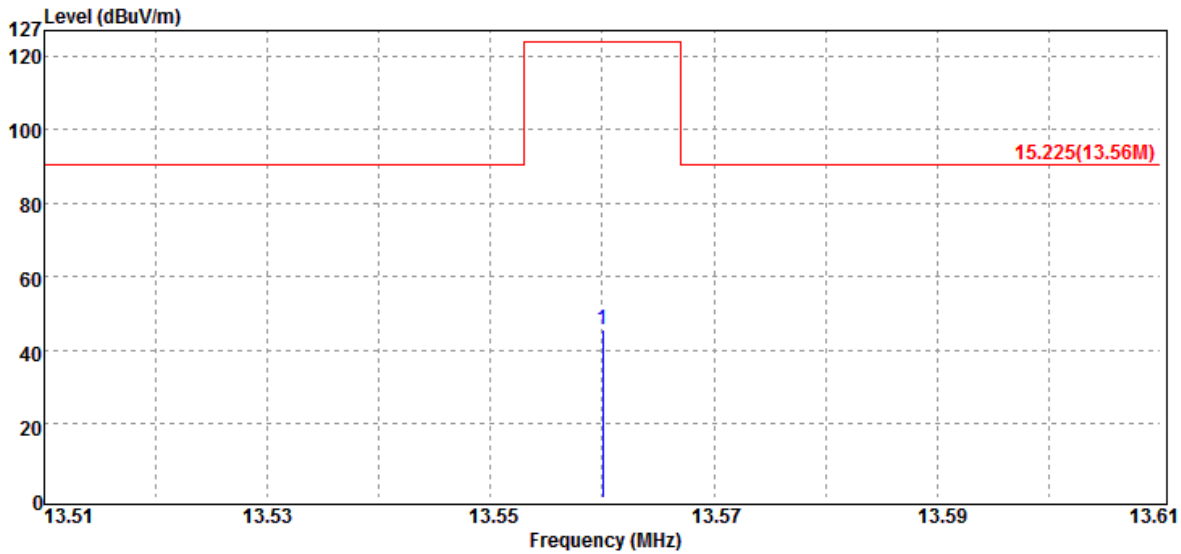

Freq.	Detector Mode	Spectrum Reading Level	Factor	Actual FS	Limit @3m	Margin
MHz	PK/QP/AV	dBuV	dB	dBuV/m	dBuV/m	dB
13.56	Peak	34.34	11.52	45.86	124.00	-78.14

Unless otherwise stated the results shown in this test report refer only to the sample(s) tested and such sample(s) are retained for 90 days only.

除非另有說明，此報告結果僅對測試之樣品負責，同時此樣品僅保留90天。本報告未經本公司書面許可，不可部份複製。

This document is issued by the Company subject to its General Conditions of Service printed overleaf, available on request or accessible at www.sgs.com/terms_and_conditions.htm and, for electronic format documents, subject to Terms and Conditions for Electronic Documents at www.sgs.com/terms_e-document.htm. Attention is drawn to the limitation of liability, indemnification and jurisdiction issues defined therein. Any holder of this document is advised that information contained hereon reflects the Company's findings at the time of its intervention only and within the limits of Client's instructions, if any. The Company's sole responsibility is to its Client and this document does not exonerate parties to a transaction from exercising all their rights and obligations under the transaction documents. This document cannot be reproduced except in full, without prior written approval of the Company. Any unauthorized alteration, forgery or falsification of the content or appearance of this document is unlawful and offenders may be prosecuted to the fullest extent of the law.

SGS Taiwan Ltd. No.134, WuKungRoad, NewTaipeiIndustrialPark, WukuDistrict, NewTaipeiCity, Taiwan24803/新北市五股區新北產業園區五工路134號

台灣檢驗科技股份有限公司 t (886-2) 2299-3279

f (886-2) 2298-0488

www.tw.sgs.com

Member of SGS Group

Operation Band	:NFC	Test Date	:2018-07-03
Fundamental Frequency	:13.56 MHz	Temp./Humi.	:19.2 deg_C/58RH
Operation Mode	:MAIN	Engineer	:Tin
EUT Pol.	:E2 Plane	Measurement Antenna Pol.	:HORIZONTAL

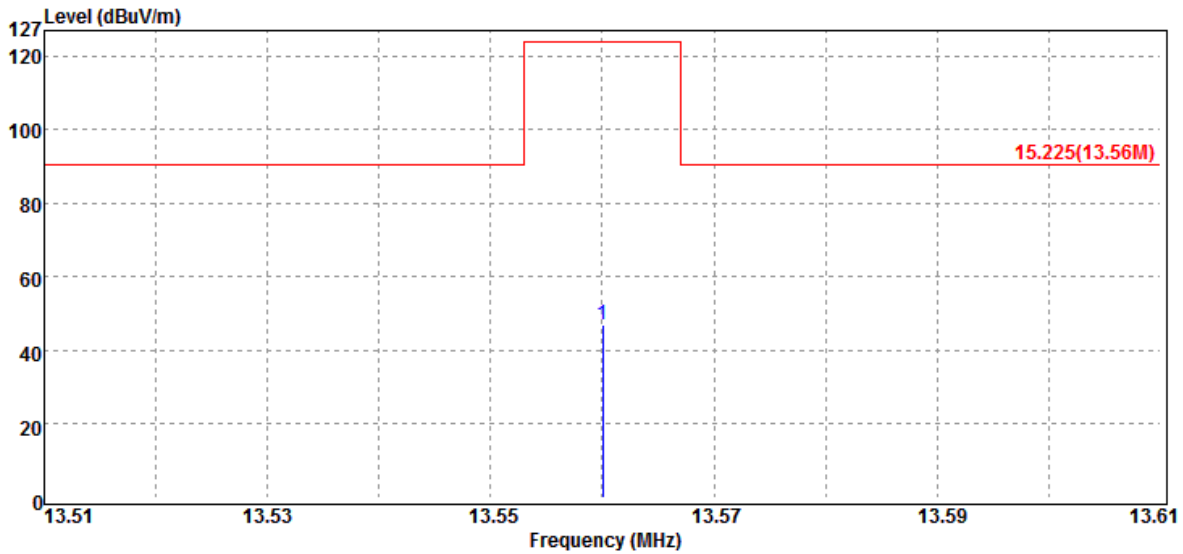

Freq. MHz	Detector Mode	Spectrum Reading Level dB μ V	Factor dB	Actual FS dB μ V/m	Limit @3m dB μ V/m	Margin dB
13.56	Peak	35.70	11.52	47.22	124.00	-76.78

Unless otherwise stated the results shown in this test report refer only to the sample(s) tested and such sample(s) are retained for 90 days only.
除非另有說明，此報告結果僅對測試之樣品負責，同時此樣品僅保留90天。本報告未經本公司書面許可，不可部份複製。

This document is issued by the Company subject to its General Conditions of Service printed overleaf, available on request or accessible at www.sgs.com/terms_and_conditions.htm and, for electronic format documents, subject to Terms and Conditions for Electronic Documents at www.sgs.com/terms_e-document.htm. Attention is drawn to the limitation of liability, indemnification and jurisdiction issues defined therein. Any holder of this document is advised that information contained hereon reflects the Company's findings at the time of its intervention only and within the limits of Client's instructions, if any. The Company's sole responsibility is to its Client and this document does not exonerate parties to a transaction from exercising all their rights and obligations under the transaction documents. This document cannot be reproduced except in full, without prior written approval of the Company. Any unauthorized alteration, forgery or falsification of the content or appearance of this document is unlawful and offenders may be prosecuted to the fullest extent of the law.

SGS Taiwan Ltd. No.134, WuKungRoad, NewTaipeiIndustrialPark, WukuDistrict, NewTaipeiCity, Taiwan24803/新北市五股區新北產業園區五工路134號

台灣檢驗科技股份有限公司 t (886-2) 2299-3279

f (886-2) 2298-0488

www.tw.sgs.com

Member of SGS Group

RFID_Test mode_1

Operation Band	:RFID	Test Date	:2018-06-25
Fundamental Frequency	:13.56 MHz	Temp./Humi.	:19.2 deg_C/58RH
Operation Mode	:MAIN	Engineer	:Tin
EUT Pol.	:E2 Plan	Measurement Antenna Pol.	:VERTICAL

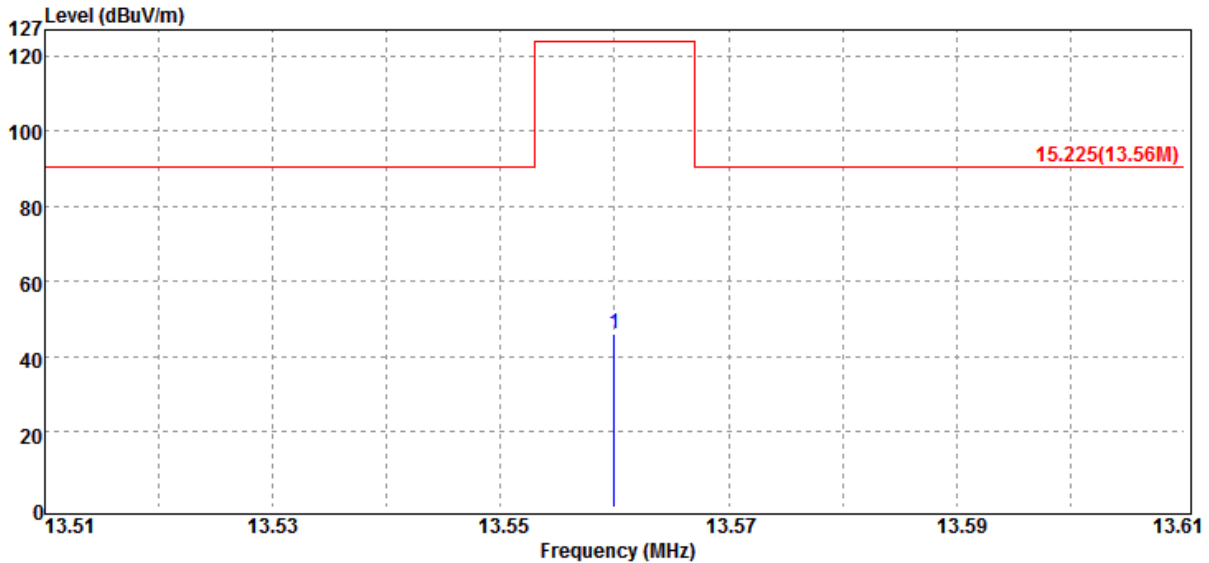

Freq.	Detector	Spectrum	Factor	Actual	Limit	Margin
MHz	Mode	Reading Level	dB	FS	@3m	dB
	PK/QP/AV	dBμV		dBμV/m	dBμV/m	
13.56	Peak	34.76	11.52	46.28	123.90	-77.62

Unless otherwise stated the results shown in this test report refer only to the sample(s) tested and such sample(s) are retained for 90 days only.

除非另有說明，此報告結果僅對測試之樣品負責，同時此樣品僅保留90天。本報告未經本公司書面許可，不可部份複製。

This document is issued by the Company subject to its General Conditions of Service printed overleaf, available on request or accessible at www.sgs.com/terms_and_conditions.htm and, for electronic format documents, subject to Terms and Conditions for Electronic Documents at www.sgs.com/terms_e-document.htm. Attention is drawn to the limitation of liability, indemnification and jurisdiction issues defined therein. Any holder of this document is advised that information contained hereon reflects the Company's findings at the time of its intervention only and within the limits of Client's instructions, if any. The Company's sole responsibility is to its Client and this document does not exonerate parties to a transaction from exercising all their rights and obligations under the transaction documents. This document cannot be reproduced except in full, without prior written approval of the Company. Any unauthorized alteration, forgery or falsification of the content or appearance of this document is unlawful and offenders may be prosecuted to the fullest extent of the law.

SGS Taiwan Ltd. No.134, WuKungRoad, NewTaipeiIndustrialPark, WukuDistrict, NewTaipeiCity, Taiwan24803/新北市五股區新北產業園區五工路134號

台灣檢驗科技股份有限公司 t (886-2) 2299-3279

f (886-2) 2298-0488

www.tw.sgs.com

Member of SGS Group

Operation Band	:RFID	Test Date	:2018-06-25
Fundamental Frequency	:13.56 MHz	Temp./Humi.	:19.2 deg_C/58RH
Operation Mode	:MAIN	Engineer	:Tin
EUT Pol.	:E2 Plan	Measurement Antenna Pol.	:HORIZONTAL

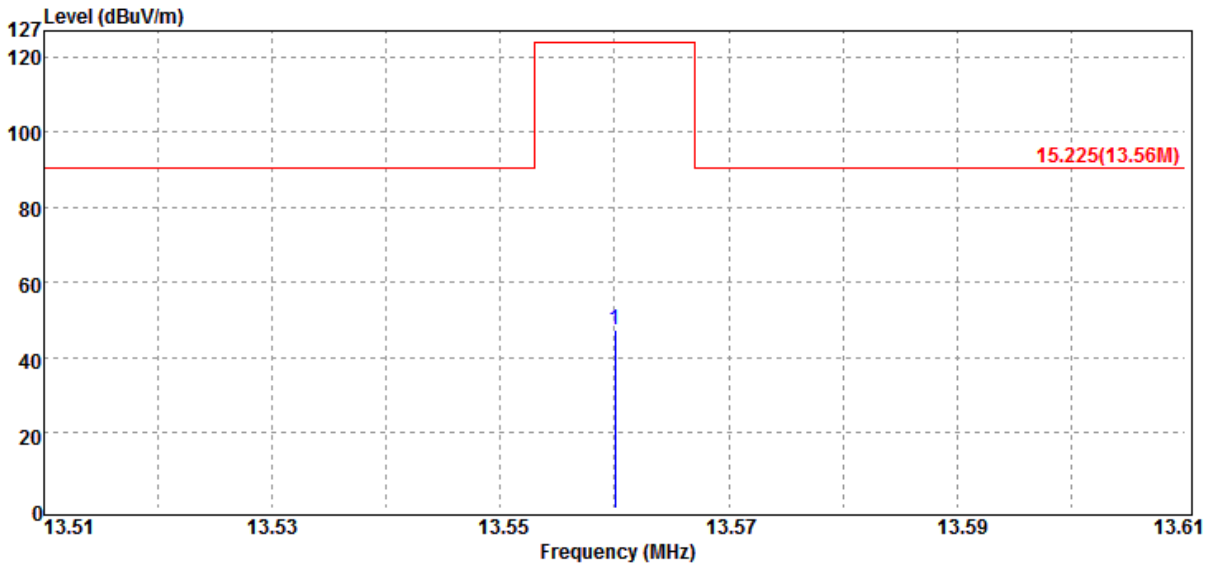

Freq.	Detector	Spectrum	Factor	Actual	Limit	Margin
MHz	Mode	Reading Level	dB	FS	@3m	dB
	PK/QP/AV	dB μ V		dB μ V/m	dB μ V/m	
13.56	Peak	35.88	11.52	47.40	123.90	-76.50

Unless otherwise stated the results shown in this test report refer only to the sample(s) tested and such sample(s) are retained for 90 days only.

除非另有說明，此報告結果僅對測試之樣品負責，同時此樣品僅保留90天。本報告未經本公司書面許可，不可部份複製。

This document is issued by the Company subject to its General Conditions of Service printed overleaf, available on request or accessible at www.sgs.com/terms_and_conditions.htm and, for electronic format documents, subject to Terms and Conditions for Electronic Documents at www.sgs.com/terms_e-document.htm. Attention is drawn to the limitation of liability, indemnification and jurisdiction issues defined therein. Any holder of this document is advised that information contained hereon reflects the Company's findings at the time of its intervention only and within the limits of Client's instructions, if any. The Company's sole responsibility is to its Client and this document does not exonerate parties to a transaction from exercising all their rights and obligations under the transaction documents. This document cannot be reproduced except in full, without prior written approval of the Company. Any unauthorized alteration, forgery or falsification of the content or appearance of this document is unlawful and offenders may be prosecuted to the fullest extent of the law.

SGS Taiwan Ltd. No.134, WuKungRoad, NewTaipeiIndustrialPark, WukuDistrict, NewTaipeiCity, Taiwan24803/新北市五股區新北產業園區五工路134號

台灣檢驗科技股份有限公司 t (886-2) 2299-3279

f (886-2) 2298-0488

www.tw.sgs.com

Member of SGS Group

NFC_Test mode_2

Operation Band	:NFC	Test Date	:2018-07-03
Fundamental Frequency	:13.56 MHz	Temp./Humi.	:21 deg_C / 62 RH
Operation Mode	:MAIN	Engineer	:Tin
EUT Pol.	:E2 Plane	Measurement Antenna Pol.	:VERTICAL

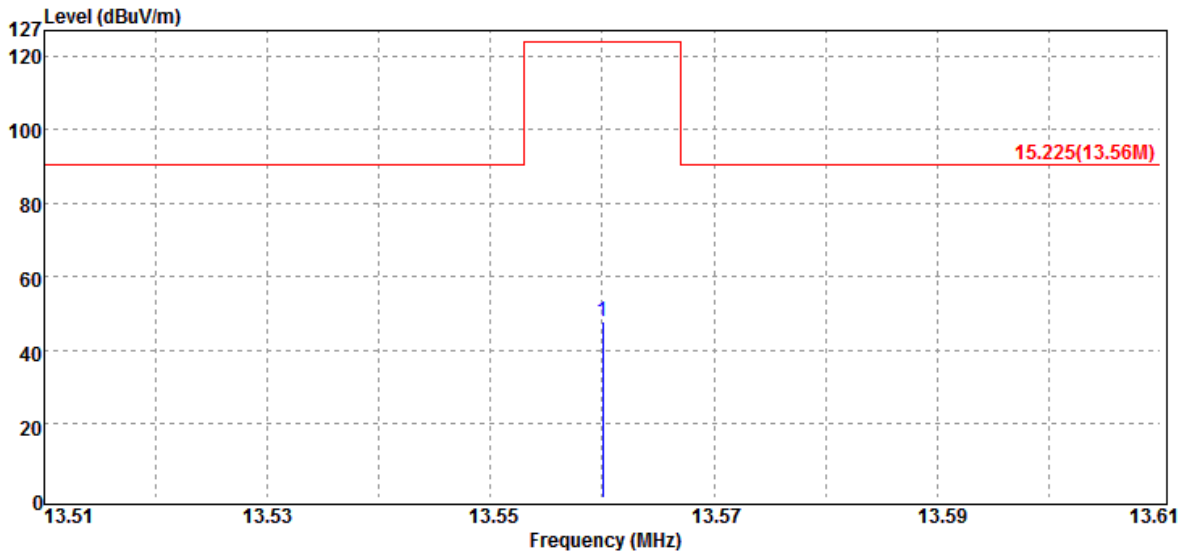

Freq. MHz	Detector Mode PK/QP/AV	Spectrum Reading Level dBμV	Factor dB	Actual FS dBμV/m	Limit @3m dBμV/m	Margin dB
13.56	Peak	36.30	11.52	47.82	124.00	-76.18

Unless otherwise stated the results shown in this test report refer only to the sample(s) tested and such sample(s) are retained for 90 days only.

除非另有說明，此報告結果僅對測試之樣品負責，同時此樣品僅保留90天。本報告未經本公司書面許可，不可部份複製。

This document is issued by the Company subject to its General Conditions of Service printed overleaf, available on request or accessible at www.sgs.com/terms_and_conditions.htm and, for electronic format documents, subject to Terms and Conditions for Electronic Documents at www.sgs.com/terms_e-document.htm. Attention is drawn to the limitation of liability, indemnification and jurisdiction issues defined therein. Any holder of this document is advised that information contained hereon reflects the Company's findings at the time of its intervention only and within the limits of Client's instructions, if any. The Company's sole responsibility is to its Client and this document does not exonerate parties to a transaction from exercising all their rights and obligations under the transaction documents. This document cannot be reproduced except in full, without prior written approval of the Company. Any unauthorized alteration, forgery or falsification of the content or appearance of this document is unlawful and offenders may be prosecuted to the fullest extent of the law.

SGS Taiwan Ltd. No.134, WuKungRoad, NewTaipeiIndustrialPark, WukuDistrict, NewTaipeiCity, Taiwan24803/新北市五股區新北產業園區五工路134號

台灣檢驗科技股份有限公司 t (886-2) 2299-3279

f (886-2) 2298-0488

www.tw.sgs.com

Member of SGS Group

Operation Band	:NFC	Test Date	:2018-07-03
Fundamental Frequency	:13.56 MHz	Temp./Humi.	:21 deg_C / 62 RH
Operation Mode	:MAIN	Engineer	:Tin
EUT Pol.	:E2 Plane	Measurement Antenna Pol.	:HORIZONTAL

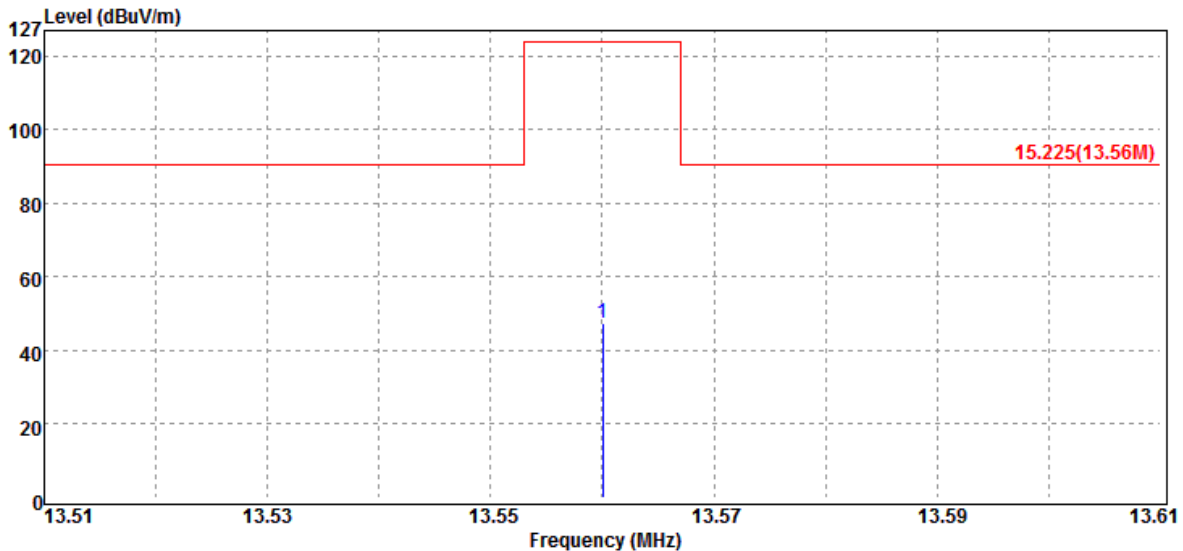

Freq. MHz	Detector Mode PK/QP/AV	Spectrum Reading Level dB μ V	Factor dB	Actual FS dB μ V/m	Limit @3m dB μ V/m	Margin dB
13.56	Peak	35.82	11.52	47.34	124.00	-76.66

Unless otherwise stated the results shown in this test report refer only to the sample(s) tested and such sample(s) are retained for 90 days only.

除非另有說明，此報告結果僅對測試之樣品負責，同時此樣品僅保留90天。本報告未經本公司書面許可，不可部份複製。

This document is issued by the Company subject to its General Conditions of Service printed overleaf, available on request or accessible at www.sgs.com/terms_and_conditions.htm and, for electronic format documents, subject to Terms and Conditions for Electronic Documents at www.sgs.com/terms_e-document.htm. Attention is drawn to the limitation of liability, indemnification and jurisdiction issues defined therein. Any holder of this document is advised that information contained hereon reflects the Company's findings at the time of its intervention only and within the limits of Client's instructions, if any. The Company's sole responsibility is to its Client and this document does not exonerate parties to a transaction from exercising all their rights and obligations under the transaction documents. This document cannot be reproduced except in full, without prior written approval of the Company. Any unauthorized alteration, forgery or falsification of the content or appearance of this document is unlawful and offenders may be prosecuted to the fullest extent of the law.

SGS Taiwan Ltd. No.134, WuKungRoad, NewTaipeiIndustrialPark, WukuDistrict, NewTaipeiCity, Taiwan24803/新北市五股區新北產業園區五工路134號

台灣檢驗科技股份有限公司 t (886-2) 2299-3279

f (886-2) 2298-0488

www.tw.sgs.com

Member of SGS Group

RFID_Test mode_2

Operation Band	:RFID	Test Date	:2018-06-26
Fundamental Frequency	:13.56 MHz	Temp./Humi.	:24.1 deg_C / 65 RH
Operation Mode	:MAIN	Engineer	:Mike
EUT Pol.	:E2 Plane	Measurement Antenna Pol.	:VERTICAL

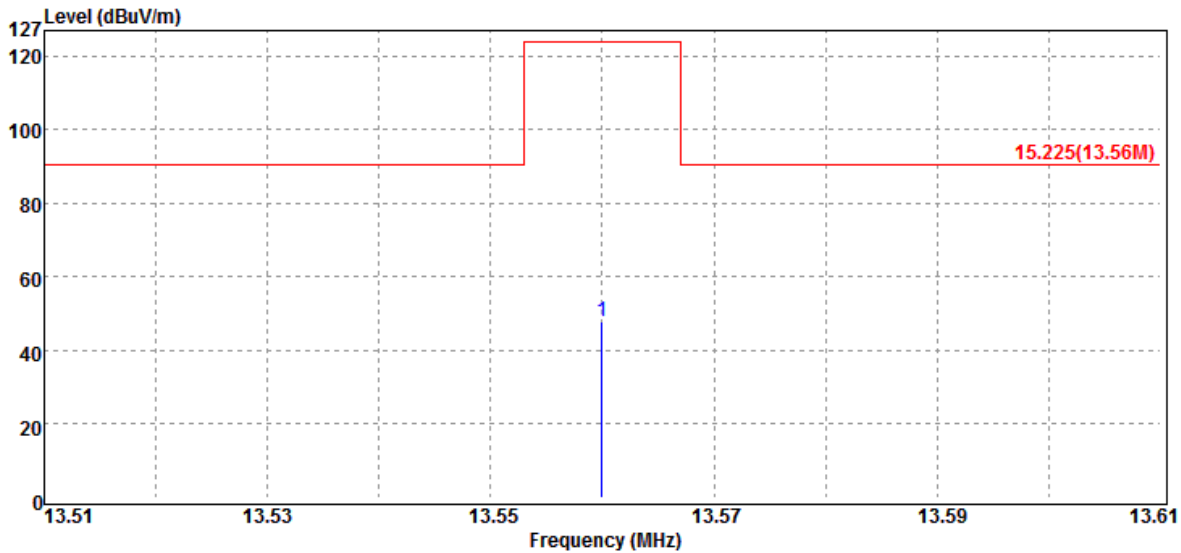

Freq. MHz	Detector Mode PK/QP/AV	Spectrum Reading Level dB μ V	Factor dB	Actual FS dB μ V/m	Limit @3m dB μ V/m	Margin dB
13.56	Peak	36.44	11.52	47.96	123.90	-75.94

Unless otherwise stated the results shown in this test report refer only to the sample(s) tested and such sample(s) are retained for 90 days only.

除非另有說明，此報告結果僅對測試之樣品負責，同時此樣品僅保留90天。本報告未經本公司書面許可，不可部份複製。

This document is issued by the Company subject to its General Conditions of Service printed overleaf, available on request or accessible at www.sgs.com/terms_and_conditions.htm and, for electronic format documents, subject to Terms and Conditions for Electronic Documents at www.sgs.com/terms_e-document.htm. Attention is drawn to the limitation of liability, indemnification and jurisdiction issues defined therein. Any holder of this document is advised that information contained hereon reflects the Company's findings at the time of its intervention only and within the limits of Client's instructions, if any. The Company's sole responsibility is to its Client and this document does not exonerate parties to a transaction from exercising all their rights and obligations under the transaction documents. This document cannot be reproduced except in full, without prior written approval of the Company. Any unauthorized alteration, forgery or falsification of the content or appearance of this document is unlawful and offenders may be prosecuted to the fullest extent of the law.

SGS Taiwan Ltd. No.134, WuKungRoad, NewTaipeiIndustrialPark, WukuDistrict, NewTaipeiCity, Taiwan24803/新北市五股區新北產業園區五工路134號

台灣檢驗科技股份有限公司 t (886-2) 2299-3279

f (886-2) 2298-0488

www.tw.sgs.com

Member of SGS Group

Operation Band	:RFID	Test Date	:2018-06-26
Fundamental Frequency	:13.56 MHz	Temp./Humi.	:24.1 deg_C / 65 RH
Operation Mode	:MAIN	Engineer	:Mike
EUT Pol.	:E2 Plane	Measurement Antenna Pol.	:HORIZONTAL

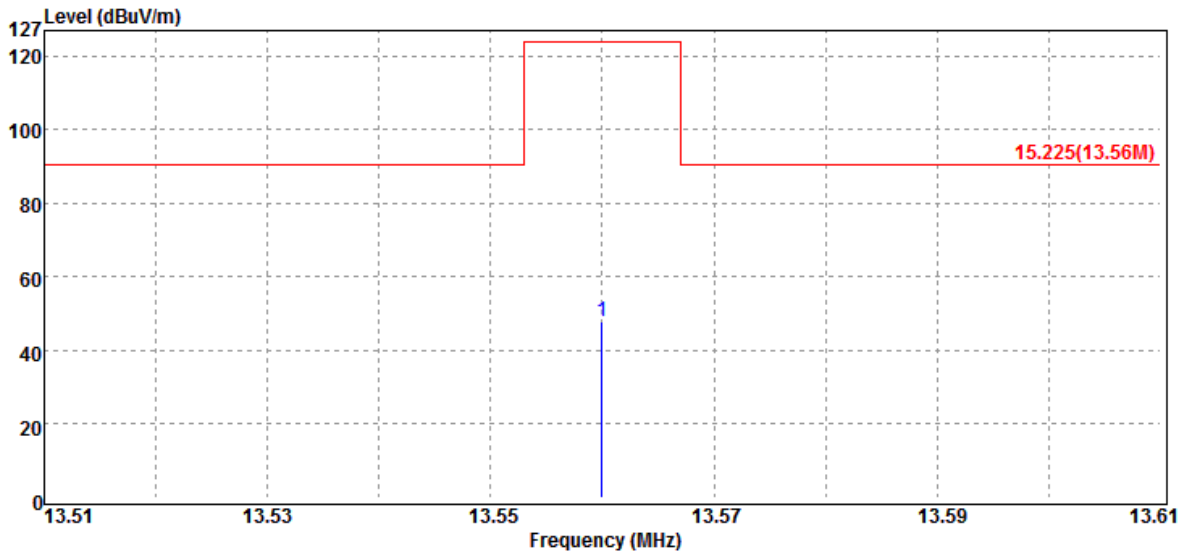

Freq. MHz	Detector Mode	Spectrum Reading Level dB μ V	Factor dB	Actual FS dB μ V/m	Limit @3m dB μ V/m	Margin dB
13.56	Peak	36.17	11.52	47.69	123.90	-76.21

Unless otherwise stated the results shown in this test report refer only to the sample(s) tested and such sample(s) are retained for 90 days only.
除非另有說明，此報告結果僅對測試之樣品負責，同時此樣品僅保留90天。本報告未經本公司書面許可，不可部份複製。

This document is issued by the Company subject to its General Conditions of Service printed overleaf, available on request or accessible at www.sgs.com/terms_and_conditions.htm and, for electronic format documents, subject to Terms and Conditions for Electronic Documents at www.sgs.com/terms_e-document.htm. Attention is drawn to the limitation of liability, indemnification and jurisdiction issues defined therein. Any holder of this document is advised that information contained hereon reflects the Company's findings at the time of its intervention only and within the limits of Client's instructions, if any. The Company's sole responsibility is to its Client and this document does not exonerate parties to a transaction from exercising all their rights and obligations under the transaction documents. This document cannot be reproduced except in full, without prior written approval of the Company. Any unauthorized alteration, forgery or falsification of the content or appearance of this document is unlawful and offenders may be prosecuted to the fullest extent of the law.

SGS Taiwan Ltd. No.134, WuKungRoad, NewTaipeiIndustrialPark, WukuDistrict, NewTaipeiCity, Taiwan24803/新北市五股區新北產業園區五工路134號

台灣檢驗科技股份有限公司 t (886-2) 2299-3279

f (886-2) 2298-0488

www.tw.sgs.com

Member of SGS Group

NFC_Test mode_3

Operation Band	:NFC	Test Date	:2018-07-18
Fundamental Frequency	:13.56 MHz	Temp./Humi.	:21 deg_C / 62 RH
Operation Mode	:MAIN	Engineer	:Kane
EUT Pol.	:E2 Plane	Measurement Antenna Pol.	:VERTICAL

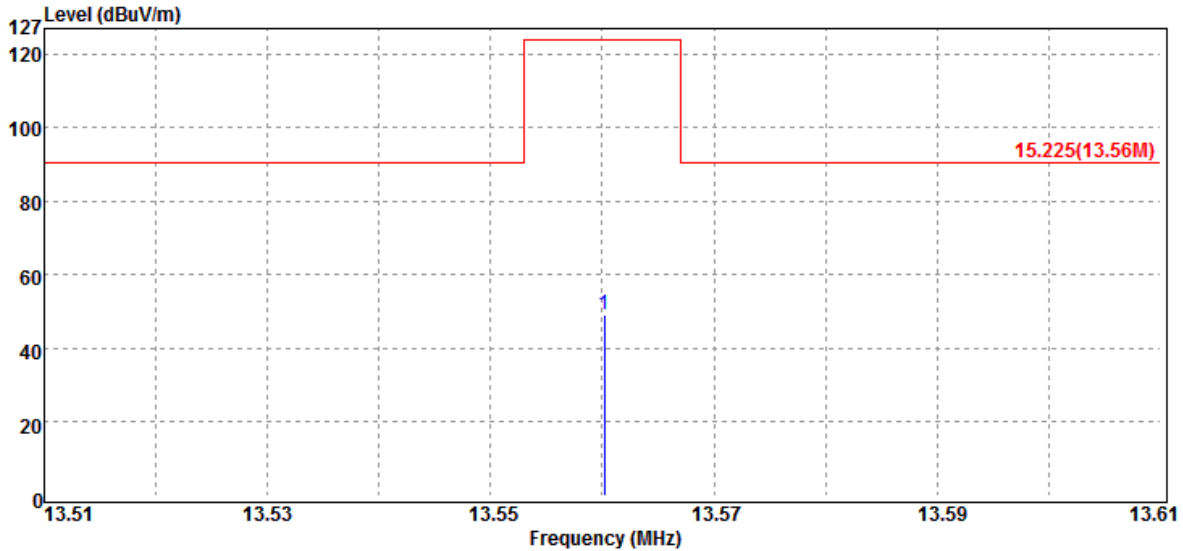

Freq. MHz	Detector Mode PK/QP/AV	Spectrum Reading Level dB μ V	Factor dB	Actual FS dB μ V/m	Limit @3m dB μ V/m	Margin dB
13.56	Peak	37.51	11.52	49.03	123.90	-74.87

Unless otherwise stated the results shown in this test report refer only to the sample(s) tested and such sample(s) are retained for 90 days only.

除非另有說明，此報告結果僅對測試之樣品負責，同時此樣品僅保留90天。本報告未經本公司書面許可，不可部份複製。

This document is issued by the Company subject to its General Conditions of Service printed overleaf, available on request or accessible at www.sgs.com/terms_and_conditions.htm and, for electronic format documents, subject to Terms and Conditions for Electronic Documents at www.sgs.com/terms_e-document.htm. Attention is drawn to the limitation of liability, indemnification and jurisdiction issues defined therein. Any holder of this document is advised that information contained hereon reflects the Company's findings at the time of its intervention only and within the limits of Client's instructions, if any. The Company's sole responsibility is to its Client and this document does not exonerate parties to a transaction from exercising all their rights and obligations under the transaction documents. This document cannot be reproduced except in full, without prior written approval of the Company. Any unauthorized alteration, forgery or falsification of the content or appearance of this document is unlawful and offenders may be prosecuted to the fullest extent of the law.

SGS Taiwan Ltd. No.134, WuKungRoad, NewTaipeiIndustrialPark, WukuDistrict, NewTaipeiCity, Taiwan24803/新北市五股區新北產業園區五工路134號

台灣檢驗科技股份有限公司 t (886-2) 2299-3279

f (886-2) 2298-0488

www.tw.sgs.com

Member of SGS Group

Operation Band	:NFC	Test Date	:2018-07-18
Fundamental Frequency	:13.56 MHz	Temp./Humi.	:21 deg_C / 62 RH
Operation Mode	:MAIN	Engineer	:Kane
EUT Pol.	:E2 Plane	Measurement Antenna Pol.	:HORIZONTAL

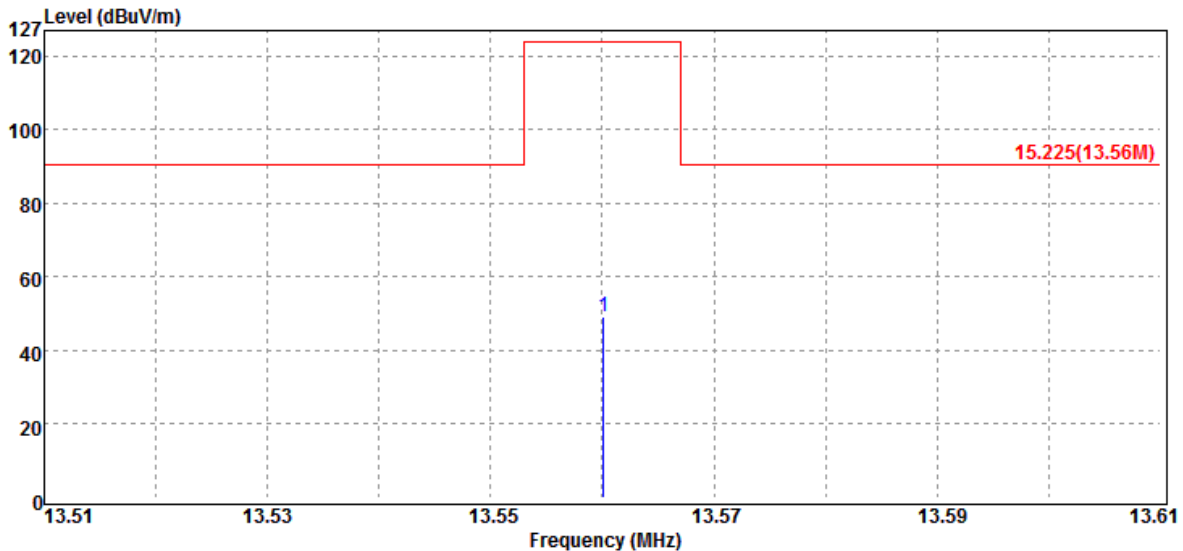

Freq. MHz	Detector Mode PK/QP/AV	Spectrum Reading Level dB μ V	Factor dB	Actual FS dB μ V/m	Limit @3m dB μ V/m	Margin dB
13.56	Peak	37.74	11.52	49.26	123.90	-74.64

Unless otherwise stated the results shown in this test report refer only to the sample(s) tested and such sample(s) are retained for 90 days only.

除非另有說明，此報告結果僅對測試之樣品負責，同時此樣品僅保留90天。本報告未經本公司書面許可，不可部份複製。

This document is issued by the Company subject to its General Conditions of Service printed overleaf, available on request or accessible at www.sgs.com/terms_and_conditions.htm and, for electronic format documents, subject to Terms and Conditions for Electronic Documents at www.sgs.com/terms_e-document.htm. Attention is drawn to the limitation of liability, indemnification and jurisdiction issues defined therein. Any holder of this document is advised that information contained hereon reflects the Company's findings at the time of its intervention only and within the limits of Client's instructions, if any. The Company's sole responsibility is to its Client and this document does not exonerate parties to a transaction from exercising all their rights and obligations under the transaction documents. This document cannot be reproduced except in full, without prior written approval of the Company. Any unauthorized alteration, forgery or falsification of the content or appearance of this document is unlawful and offenders may be prosecuted to the fullest extent of the law.

SGS Taiwan Ltd. No.134, WuKungRoad, NewTaipeiIndustrialPark, WukuDistrict, NewTaipeiCity, Taiwan24803/新北市五股區新北產業園區五工路134號

台灣檢驗科技股份有限公司 t (886-2) 2299-3279

f (886-2) 2298-0488

www.tw.sgs.com

Member of SGS Group

RFID_Test mode_3

Operation Band	:RFID	Test Date	:2018-07-18
Fundamental Frequency	:13.56 MHz	Temp./Humi.	:21 deg_C / 62 RH
Operation Mode	:MAIN	Engineer	:Kane
EUT Pol.	:E2 Plane	Measurement Antenna Pol.	:VERTICAL

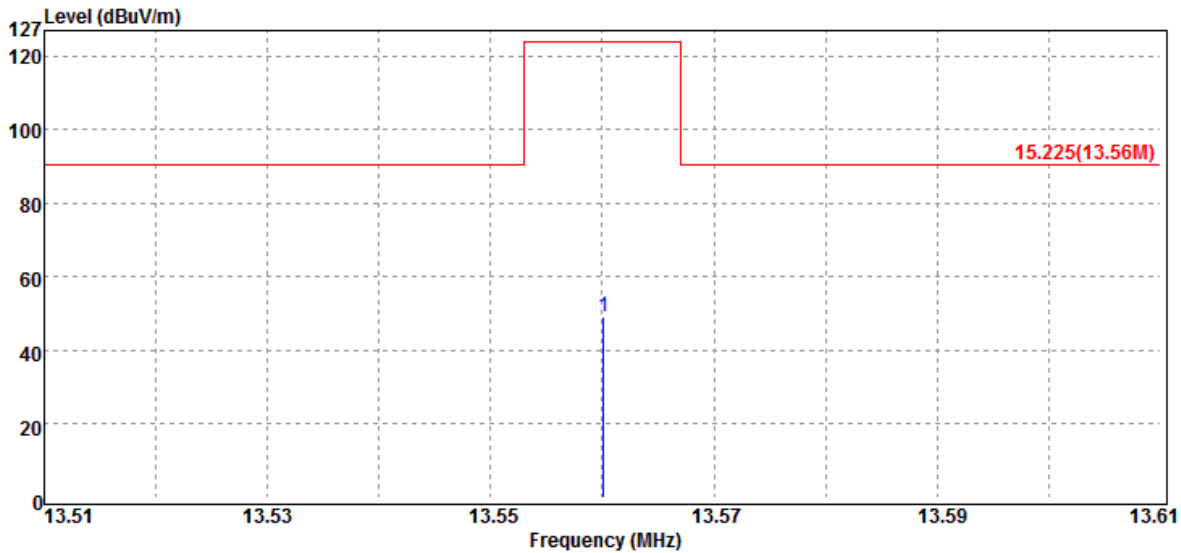

Freq. MHz	Detector Mode PK/QP/AV	Spectrum Reading Level dBuV	Factor dB	Actual FS dBuV/m	Limit @3m dBuV/m	Margin dB
13.56	Peak	37.53	11.52	49.05	123.90	-74.85

Unless otherwise stated the results shown in this test report refer only to the sample(s) tested and such sample(s) are retained for 90 days only.

除非另有說明，此報告結果僅對測試之樣品負責，同時此樣品僅保留90天。本報告未經本公司書面許可，不可部份複製。

This document is issued by the Company subject to its General Conditions of Service printed overleaf, available on request or accessible at www.sgs.com/terms_and_conditions.htm and, for electronic format documents, subject to Terms and Conditions for Electronic Documents at www.sgs.com/terms_e-document.htm. Attention is drawn to the limitation of liability, indemnification and jurisdiction issues defined therein. Any holder of this document is advised that information contained hereon reflects the Company's findings at the time of its intervention only and within the limits of Client's instructions, if any. The Company's sole responsibility is to its Client and this document does not exonerate parties to a transaction from exercising all their rights and obligations under the transaction documents. This document cannot be reproduced except in full, without prior written approval of the Company. Any unauthorized alteration, forgery or falsification of the content or appearance of this document is unlawful and offenders may be prosecuted to the fullest extent of the law.

SGS Taiwan Ltd. No.134, WuKungRoad, NewTaipeiIndustrialPark, WukuDistrict, NewTaipeiCity, Taiwan24803/新北市五股區新北產業園區五工路134號

台灣檢驗科技股份有限公司 t (886-2) 2299-3279

f (886-2) 2298-0488

www.tw.sgs.com

Member of SGS Group

Operation Band	:RFID	Test Date	:2018-07-18
Fundamental Frequency	:13.56 MHz	Temp./Humi.	:21 deg_C / 62 RH
Operation Mode	:MAIN	Engineer	:Kane
EUT Pol.	:E2 Plane	Measurement Antenna Pol.	:HORIZONTAL

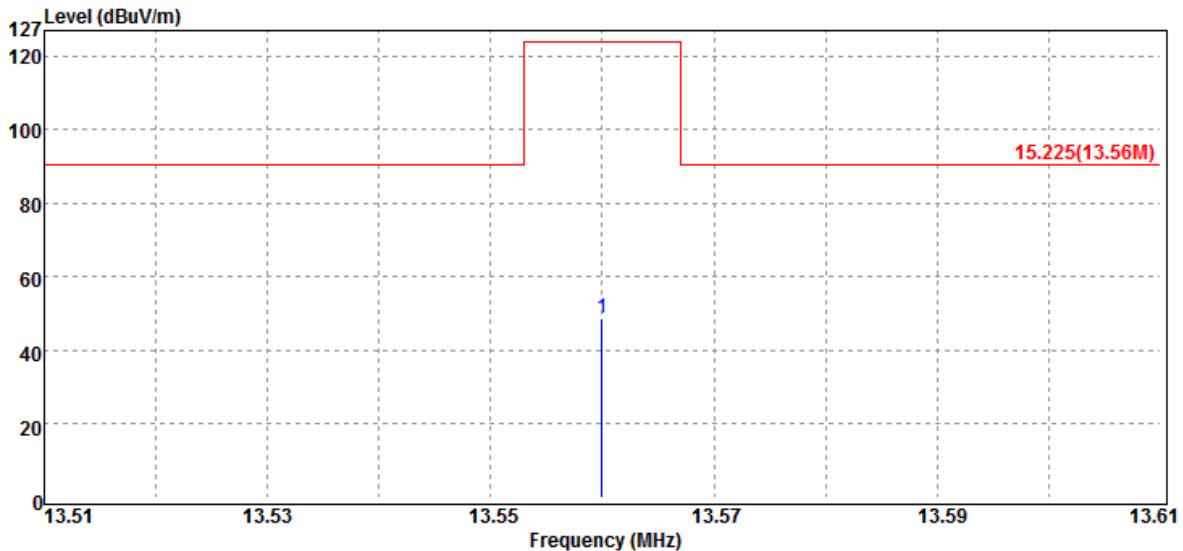

Freq. MHz	Detector Mode PK/QP/AV	Spectrum Reading Level dB μ V	Factor dB	Actual FS dB μ V/m	Limit @3m dB μ V/m	Margin dB
13.56	Peak	37.11	11.52	48.63	123.90	-75.27

Unless otherwise stated the results shown in this test report refer only to the sample(s) tested and such sample(s) are retained for 90 days only.
除非另有說明，此報告結果僅對測試之樣品負責，同時此樣品僅保留90天。本報告未經本公司書面許可，不可部份複製。

This document is issued by the Company subject to its General Conditions of Service printed overleaf, available on request or accessible at www.sgs.com/terms_and_conditions.htm and, for electronic format documents, subject to Terms and Conditions for Electronic Documents at www.sgs.com/terms_e-document.htm. Attention is drawn to the limitation of liability, indemnification and jurisdiction issues defined therein. Any holder of this document is advised that information contained hereon reflects the Company's findings at the time of its intervention only and within the limits of Client's instructions, if any. The Company's sole responsibility is to its Client and this document does not exonerate parties to a transaction from exercising all their rights and obligations under the transaction documents. This document cannot be reproduced except in full, without prior written approval of the Company. Any unauthorized alteration, forgery or falsification of the content or appearance of this document is unlawful and offenders may be prosecuted to the fullest extent of the law.

SGS Taiwan Ltd. No.134, WuKungRoad, NewTaipeiIndustrialPark, WukuDistrict, NewTaipeiCity, Taiwan24803/新北市五股區新北產業園區五工路134號

台灣檢驗科技股份有限公司 t (886-2) 2299-3279

f (886-2) 2298-0488

www.tw.sgs.com

Member of SGS Group

7.5.3 Mask Measurement Result NFC_Test mode_1

Operation Band	:NFC	Test Date	:2018-07-03
Fundamental Frequency	:13.56 MHz	Temp./Humi.	:19.2 deg_C/58RH
Operation Mode	:MASK	Engineer	:Tin
EUT Pol.	:E2 Plane	Measurement Antenna Pol.	:VERTICAL

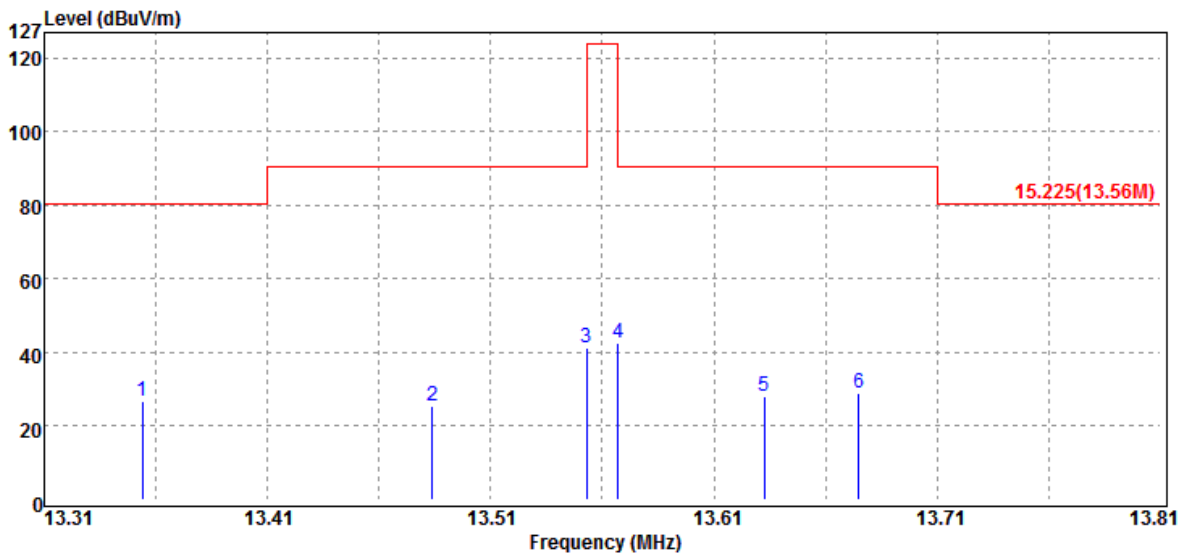

Freq. MHz	Detector Mode PK/QP/AV	Spectrum Reading Level dB μ V	Factor dB	Actual FS dB μ V/m	Limit @3m dB μ V/m	Margin dB
13.35	Peak	15.44	11.52	26.96	69.54	-42.58
13.48	Peak	13.99	11.52	25.51	69.54	-44.03
13.55	Peak	29.87	11.52	41.39	69.54	-28.15
13.57	Peak	31.13	11.52	42.65	69.54	-26.89
13.63	Peak	16.41	11.52	27.93	69.54	-41.61
13.68	Peak	17.40	11.53	28.93	69.54	-40.61

Unless otherwise stated the results shown in this test report refer only to the sample(s) tested and such sample(s) are retained for 90 days only.

除非另有說明，此報告結果僅對測試之樣品負責，同時此樣品僅保留90天。本報告未經本公司書面許可，不可部份複製。

This document is issued by the Company subject to its General Conditions of Service printed overleaf, available on request or accessible at www.sgs.com/terms_and_conditions.htm and, for electronic format documents, subject to Terms and Conditions for Electronic Documents at www.sgs.com/terms_e-document.htm. Attention is drawn to the limitation of liability, indemnification and jurisdiction issues defined therein. Any holder of this document is advised that information contained hereon reflects the Company's findings at the time of its intervention only and within the limits of Client's instructions, if any. The Company's sole responsibility is to its Client and this document does not exonerate parties to a transaction from exercising all their rights and obligations under the transaction documents. This document cannot be reproduced except in full, without prior written approval of the Company. Any unauthorized alteration, forgery or falsification of the content or appearance of this document is unlawful and offenders may be prosecuted to the fullest extent of the law.

SGS Taiwan Ltd. No.134, WuKungRoad, NewTaipeiIndustrialPark, WukuDistrict, NewTaipeiCity, Taiwan24803/新北市五股區新北產業園區五工路134號

台灣檢驗科技股份有限公司 t (886-2) 2299-3279

f (886-2) 2298-0488

www.tw.sgs.com

Member of SGS Group

Operation Band	:NFC	Test Date	:2018-07-03
Fundamental Frequency	:13.56 MHz	Temp./Humi.	:19.2 deg_C/58RH
Operation Mode	:MASK	Engineer	:Tin
EUT Pol.	:E2 Plane	Measurement Antenna Pol.	:HORIZONTAL

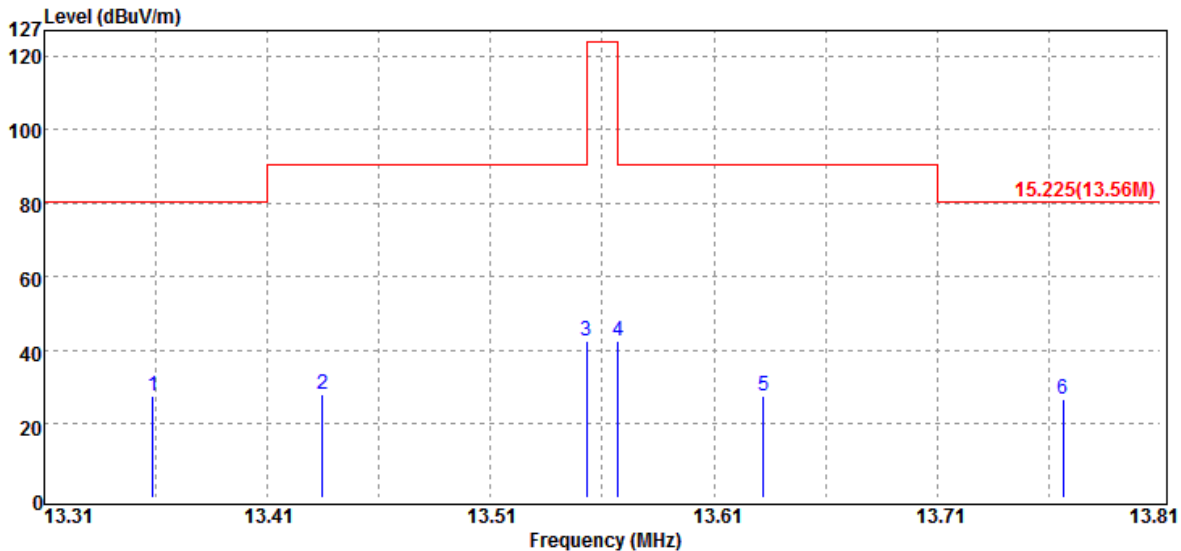

Freq. MHz	Detector Mode PK/QP/AV	Spectrum Reading Level dB μ V	Factor dB	Actual FS dB μ V/m	Limit @3m dB μ V/m	Margin dB
13.36	Peak	16.15	11.52	27.67	69.54	-41.87
13.44	Peak	16.61	11.52	28.13	69.54	-41.41
13.55	Peak	31.22	11.52	42.74	69.54	-26.80
13.57	Peak	31.30	11.52	42.82	69.54	-26.72
13.63	Peak	16.30	11.52	27.82	69.54	-41.72
13.77	Peak	15.41	11.53	26.94	69.54	-42.60

Unless otherwise stated the results shown in this test report refer only to the sample(s) tested and such sample(s) are retained for 90 days only.

除非另有說明，此報告結果僅對測試之樣品負責，同時此樣品僅保留90天。本報告未經本公司書面許可，不可部份複製。

This document is issued by the Company subject to its General Conditions of Service printed overleaf, available on request or accessible at www.sgs.com/terms_and_conditions.htm and, for electronic format documents, subject to Terms and Conditions for Electronic Documents at www.sgs.com/terms_e-document.htm. Attention is drawn to the limitation of liability, indemnification and jurisdiction issues defined therein. Any holder of this document is advised that information contained hereon reflects the Company's findings at the time of its intervention only and within the limits of Client's instructions, if any. The Company's sole responsibility is to its Client and this document does not exonerate parties to a transaction from exercising all their rights and obligations under the transaction documents. This document cannot be reproduced except in full, without prior written approval of the Company. Any unauthorized alteration, forgery or falsification of the content or appearance of this document is unlawful and offenders may be prosecuted to the fullest extent of the law.

SGS Taiwan Ltd. No.134, WuKungRoad, NewTaipeiIndustrialPark, WukuDistrict, NewTaipeiCity, Taiwan24803/新北市五股區新北產業園區五工路134號

台灣檢驗科技股份有限公司 t (886-2) 2299-3279

f (886-2) 2298-0488

www.tw.sgs.com

Member of SGS Group

RFID_Test mode_1

Operation Band	:RFID	Test Date	:2018-06-25
Fundamental Frequency	:13.56 MHz	Temp./Humi.	:19.2 deg_C/58RH
Operation Mode	:MASK	Engineer	:Tin
EUT Pol.	:E2 Plan	Measurement Antenna Pol.	:VERTICAL

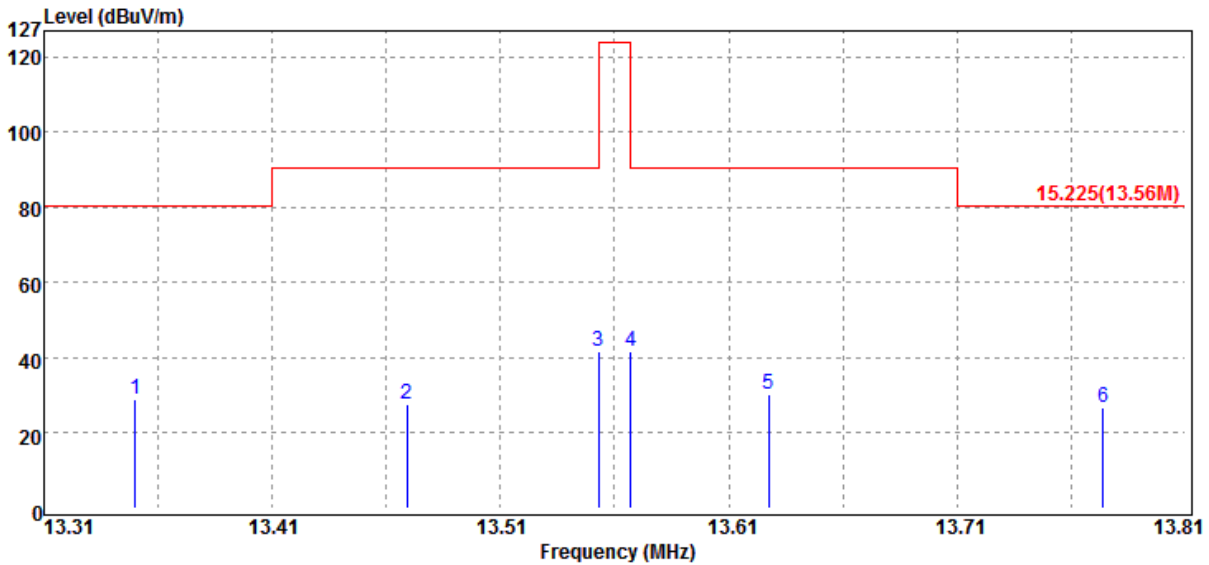

Freq. MHz	Detector Mode PK/QP/AV	Spectrum Reading Level dBuV	Factor dB	Actual FS dBuV/m	Limit @3m dBuV/m	Margin dB
13.35	Peak	17.36	11.52	28.88	80.50	-51.62
13.47	Peak	16.05	11.52	27.57	90.47	-62.90
13.55	Peak	30.11	11.52	41.63	90.47	-48.84
13.57	Peak	30.06	11.52	41.58	90.47	-48.89
13.63	Peak	18.76	11.52	30.28	90.47	-60.19
13.77	Peak	15.48	11.53	27.01	80.50	-53.49

Unless otherwise stated the results shown in this test report refer only to the sample(s) tested and such sample(s) are retained for 90 days only.

除非另有說明，此報告結果僅對測試之樣品負責，同時此樣品僅保留90天。本報告未經本公司書面許可，不可部份複製。

This document is issued by the Company subject to its General Conditions of Service printed overleaf, available on request or accessible at www.sgs.com/terms_and_conditions.htm and, for electronic format documents, subject to Terms and Conditions for Electronic Documents at www.sgs.com/terms_e-document.htm. Attention is drawn to the limitation of liability, indemnification and jurisdiction issues defined therein. Any holder of this document is advised that information contained hereon reflects the Company's findings at the time of its intervention only and within the limits of Client's instructions, if any. The Company's sole responsibility is to its Client and this document does not exonerate parties to a transaction from exercising all their rights and obligations under the transaction documents. This document cannot be reproduced except in full, without prior written approval of the Company. Any unauthorized alteration, forgery or falsification of the content or appearance of this document is unlawful and offenders may be prosecuted to the fullest extent of the law.

Operation Band	:RFID	Test Date	:2018-06-25
Fundamental Frequency	:13.56 MHz	Temp./Humi.	:19.2 deg_C/58RH
Operation Mode	:MASK	Engineer	:Tin
EUT Pol.	:E2 Plan	Measurement Antenna Pol.	:HORIZONTAL

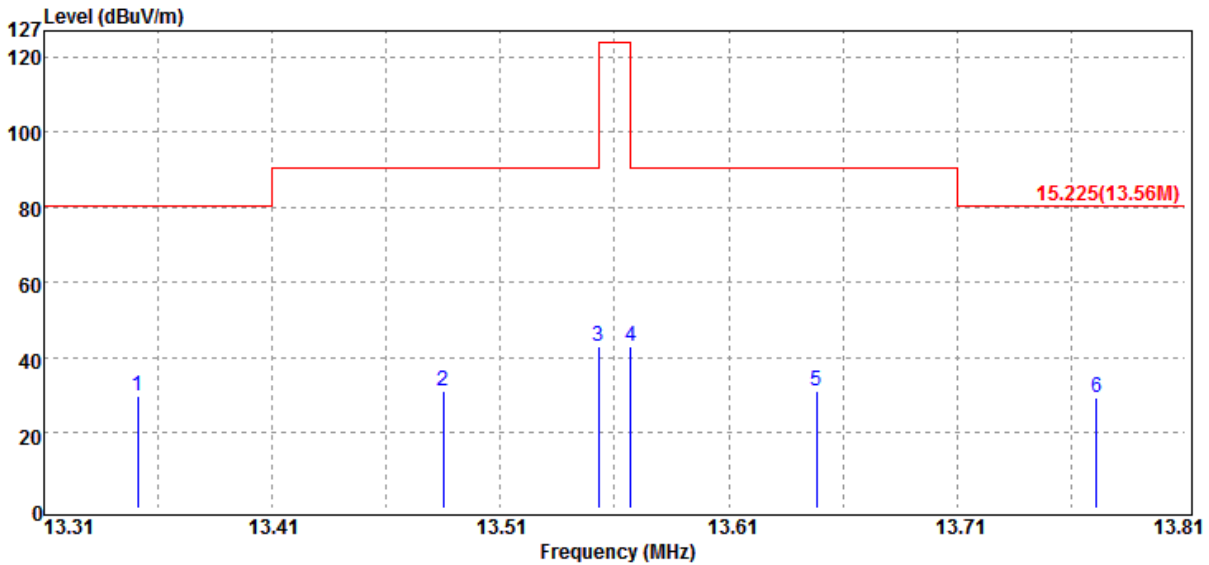

Freq. MHz	Detector Mode PK/QP/AV	Spectrum Reading Level dB μ V	Factor dB	Actual FS dB μ V/m	Limit @3m dB μ V/m	Margin dB
13.35	Peak	18.49	11.52	30.01	80.50	-50.49
13.49	Peak	19.65	11.52	31.17	90.47	-59.30
13.55	Peak	31.35	11.52	42.87	90.47	-47.60
13.57	Peak	31.43	11.52	42.95	90.47	-47.52
13.65	Peak	19.48	11.52	31.00	90.47	-59.47
13.77	Peak	17.84	11.53	29.37	80.50	-51.13

Unless otherwise stated the results shown in this test report refer only to the sample(s) tested and such sample(s) are retained for 90 days only.

除非另有說明，此報告結果僅對測試之樣品負責，同時此樣品僅保留90天。本報告未經本公司書面許可，不可部份複製。

This document is issued by the Company subject to its General Conditions of Service printed overleaf, available on request or accessible at www.sgs.com/terms_and_conditions.htm and, for electronic format documents, subject to Terms and Conditions for Electronic Documents at www.sgs.com/terms_e-document.htm. Attention is drawn to the limitation of liability, indemnification and jurisdiction issues defined therein. Any holder of this document is advised that information contained hereon reflects the Company's findings at the time of its intervention only and within the limits of Client's instructions, if any. The Company's sole responsibility is to its Client and this document does not exonerate parties to a transaction from exercising all their rights and obligations under the transaction documents. This document cannot be reproduced except in full, without prior written approval of the Company. Any unauthorized alteration, forgery or falsification of the content or appearance of this document is unlawful and offenders may be prosecuted to the fullest extent of the law.

SGS Taiwan Ltd. No.134, WuKungRoad, NewTaipeiIndustrialPark, WukuDistrict, NewTaipeiCity, Taiwan24803/新北市五股區新北產業園區五工路134號

台灣檢驗科技股份有限公司 t (886-2) 2299-3279

f (886-2) 2298-0488

www.tw.sgs.com

Member of SGS Group

NFC_Test mode_2

Operation Band	:NFC	Test Date	:2018-07-03
Fundamental Frequency	:13.56 MHz	Temp./Humi.	:21 deg_C / 62 RH
Operation Mode	:MASK	Engineer	:Tin
EUT Pol.	:E2 Plane	Measurement Antenna Pol.	:VERTICAL

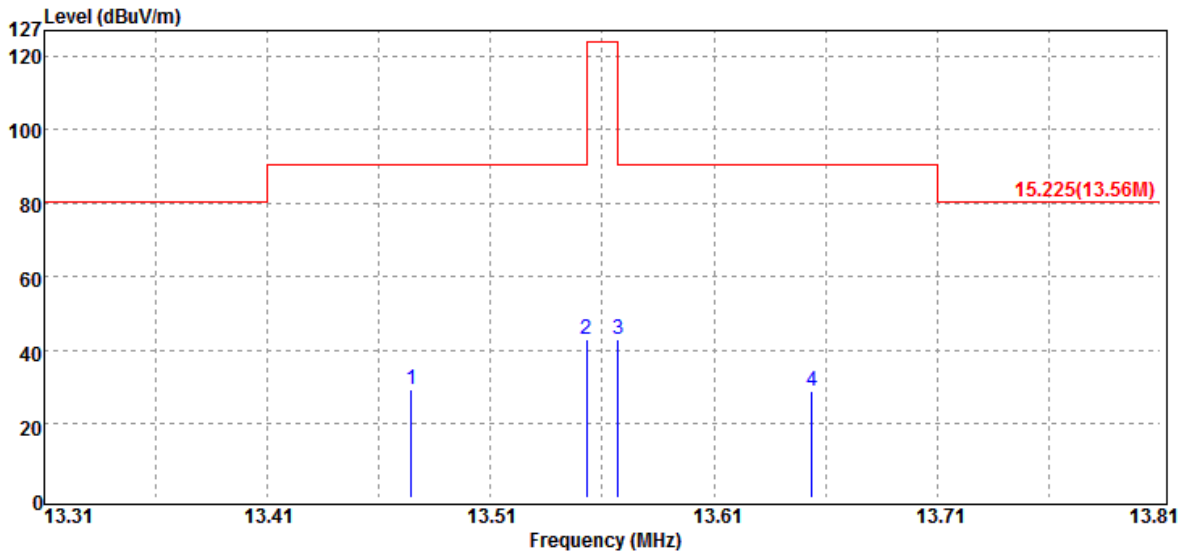

Freq. MHz	Detector Mode	Spectrum Reading Level dB μ V	Factor dB	Actual FS dB μ V/m	Limit @3m dB μ V/m	Margin dB
13.48	Peak	17.84	11.52	29.36	69.54	-40.18
13.55	Peak	31.45	11.52	42.97	69.54	-26.57
13.57	Peak	31.75	11.52	43.27	69.54	-26.27
13.65	Peak	17.46	11.52	28.98	69.54	-40.56

Unless otherwise stated the results shown in this test report refer only to the sample(s) tested and such sample(s) are retained for 90 days only.

除非另有說明，此報告結果僅對測試之樣品負責，同時此樣品僅保留90天。本報告未經本公司書面許可，不可部份複製。

This document is issued by the Company subject to its General Conditions of Service printed overleaf, available on request or accessible at www.sgs.com/terms_and_conditions.htm and, for electronic format documents, subject to Terms and Conditions for Electronic Documents at www.sgs.com/terms_e-document.htm. Attention is drawn to the limitation of liability, indemnification and jurisdiction issues defined therein. Any holder of this document is advised that information contained hereon reflects the Company's findings at the time of its intervention only and within the limits of Client's instructions, if any. The Company's sole responsibility is to its Client and this document does not exonerate parties to a transaction from exercising all their rights and obligations under the transaction documents. This document cannot be reproduced except in full, without prior written approval of the Company. Any unauthorized alteration, forgery or falsification of the content or appearance of this document is unlawful and offenders may be prosecuted to the fullest extent of the law.

SGS Taiwan Ltd. No.134, WuKungRoad, NewTaipeiIndustrialPark, WukuDistrict, NewTaipeiCity, Taiwan24803/新北市五股區新北產業園區五工路134號

台灣檢驗科技股份有限公司 t (886-2) 2299-3279

f (886-2) 2298-0488

www.tw.sgs.com

Member of SGS Group

Operation Band	:NFC	Test Date	:2018-07-03
Fundamental Frequency	:13.56 MHz	Temp./Humi.	:21 deg_C / 62 RH
Operation Mode	:MASK	Engineer	:Tin
EUT Pol.	:E2 Plane	Measurement Antenna Pol.	:HORIZONTAL

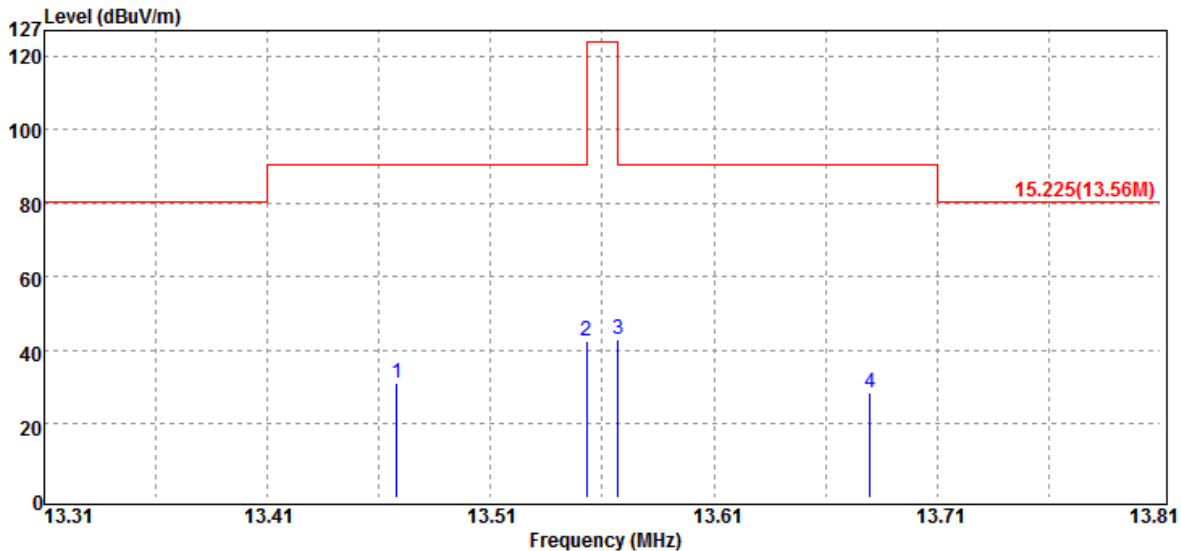

Freq. MHz	Detector Mode	Spectrum Reading Level dB μ V	Factor dB	Actual FS dB μ V/m	Limit @3m dB μ V/m	Margin dB
13.47	Peak	19.57	11.52	31.09	69.54	-38.45
13.55	Peak	31.20	11.52	42.72	69.54	-26.82
13.57	Peak	31.54	11.52	43.06	69.54	-26.48
13.68	Peak	17.22	11.53	28.75	69.54	-40.79

Unless otherwise stated the results shown in this test report refer only to the sample(s) tested and such sample(s) are retained for 90 days only.

除非另有說明，此報告結果僅對測試之樣品負責，同時此樣品僅保留90天。本報告未經本公司書面許可，不可部份複製。

This document is issued by the Company subject to its General Conditions of Service printed overleaf, available on request or accessible at www.sgs.com/terms_and_conditions.htm and, for electronic format documents, subject to Terms and Conditions for Electronic Documents at www.sgs.com/terms_e-document.htm. Attention is drawn to the limitation of liability, indemnification and jurisdiction issues defined therein. Any holder of this document is advised that information contained hereon reflects the Company's findings at the time of its intervention only and within the limits of Client's instructions, if any. The Company's sole responsibility is to its Client and this document does not exonerate parties to a transaction from exercising all their rights and obligations under the transaction documents. This document cannot be reproduced except in full, without prior written approval of the Company. Any unauthorized alteration, forgery or falsification of the content or appearance of this document is unlawful and offenders may be prosecuted to the fullest extent of the law.

SGS Taiwan Ltd. No.134, WuKungRoad, NewTaipeiIndustrialPark, WukuDistrict, NewTaipeiCity, Taiwan24803/新北市五股區新北產業園區五工路134號

台灣檢驗科技股份有限公司 t (886-2) 2299-3279

f (886-2) 2298-0488

www.tw.sgs.com

Member of SGS Group

RFID_Test mode_2

Operation Band	:RFID	Test Date	:2018-06-26
Fundamental Frequency	:13.56 MHz	Temp./Humi.	:24.1 deg_C / 65 RH
Operation Mode	:MASK	Engineer	:Mike
EUT Pol.	:E2 Plane	Measurement Antenna Pol.	:VERTICAL

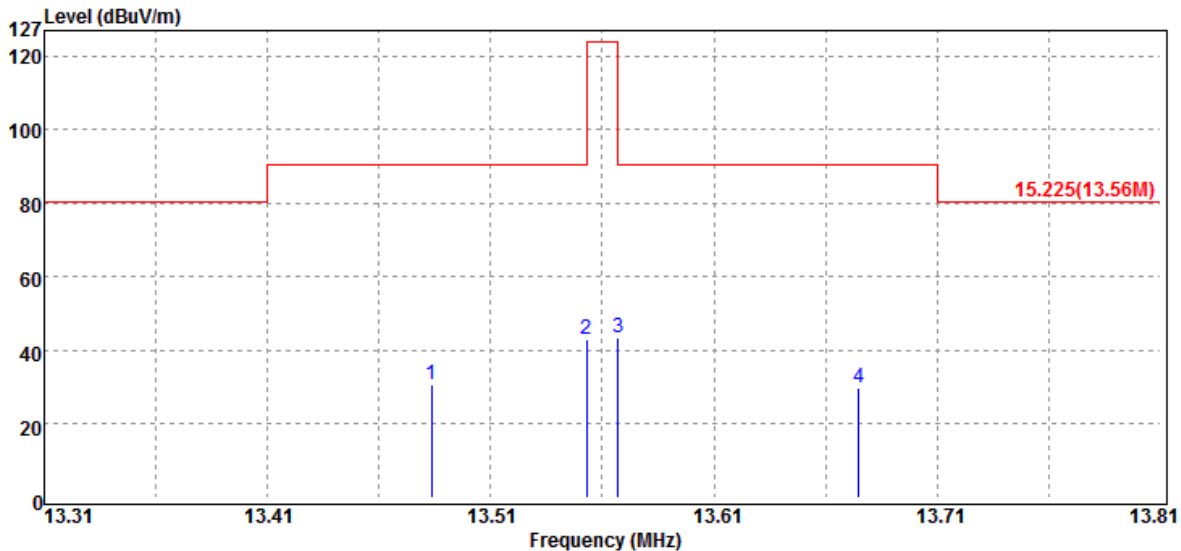

Freq. MHz	Detector Mode PK/QP/AV	Spectrum Reading Level dB μ V	Factor dB	Actual FS dB μ V/m	Limit @3m dB μ V/m	Margin dB
13.48	Peak	19.36	11.52	30.88	90.47	-59.59
13.55	Peak	31.59	11.52	43.11	90.47	-47.36
13.57	Peak	31.97	11.52	43.49	90.47	-46.98
13.68	Peak	18.32	11.53	29.85	90.47	-60.62

Unless otherwise stated the results shown in this test report refer only to the sample(s) tested and such sample(s) are retained for 90 days only.

除非另有說明，此報告結果僅對測試之樣品負責，同時此樣品僅保留90天。本報告未經本公司書面許可，不可部份複製。

This document is issued by the Company subject to its General Conditions of Service printed overleaf, available on request or accessible at www.sgs.com/terms_and_conditions.htm and, for electronic format documents, subject to Terms and Conditions for Electronic Documents at www.sgs.com/terms_e-document.htm. Attention is drawn to the limitation of liability, indemnification and jurisdiction issues defined therein. Any holder of this document is advised that information contained hereon reflects the Company's findings at the time of its intervention only and within the limits of Client's instructions, if any. The Company's sole responsibility is to its Client and this document does not exonerate parties to a transaction from exercising all their rights and obligations under the transaction documents. This document cannot be reproduced except in full, without prior written approval of the Company. Any unauthorized alteration, forgery or falsification of the content or appearance of this document is unlawful and offenders may be prosecuted to the fullest extent of the law.

SGS Taiwan Ltd. No.134, WuKungRoad, NewTaipeiIndustrialPark, WukuDistrict, NewTaipeiCity, Taiwan24803/新北市五股區新北產業園區五工路134號

台灣檢驗科技股份有限公司 t (886-2) 2299-3279

f (886-2) 2298-0488

www.tw.sgs.com

Member of SGS Group

Operation Band	:RFID	Test Date	:2018-06-26
Fundamental Frequency	:13.56 MHz	Temp./Humi.	:24.1 deg_C / 65 RH
Operation Mode	:MASK	Engineer	:Mike
EUT Pol.	:E2 Plane	Measurement Antenna Pol.	:HORIZONTAL

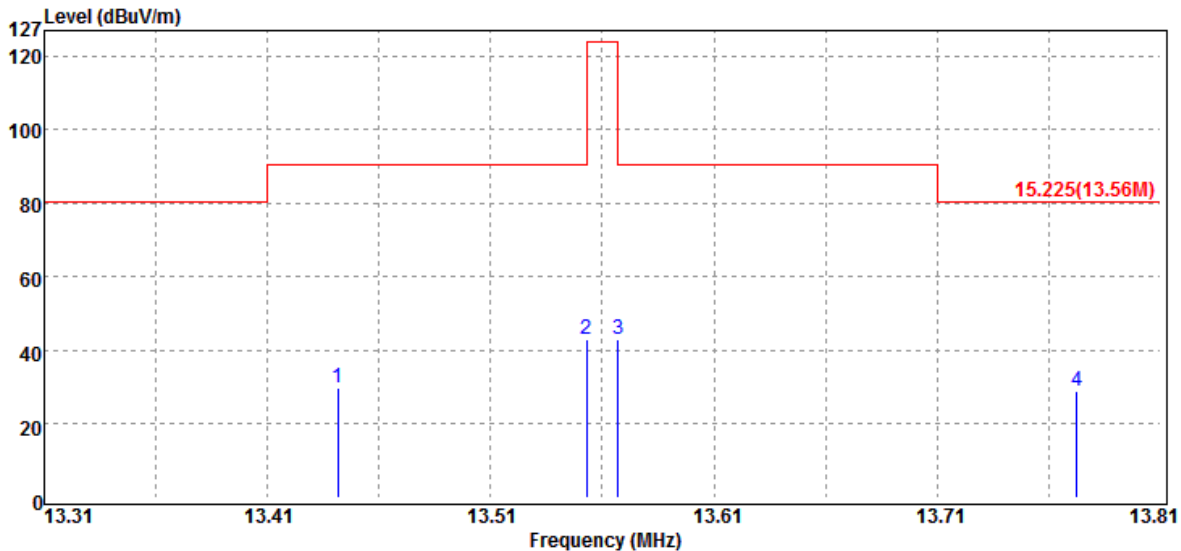

Freq. MHz	Detector Mode PK/QP/AV	Spectrum Reading Level dB μ V	Factor dB	Actual FS dB μ V/m	Limit @3m dB μ V/m	Margin dB
13.44	Peak	18.23	11.52	29.75	90.47	-60.72
13.55	Peak	31.34	11.52	42.86	90.47	-47.61
13.57	Peak	31.74	11.52	43.26	90.47	-47.21
13.77	Peak	17.65	11.53	29.18	80.50	-51.32

Unless otherwise stated the results shown in this test report refer only to the sample(s) tested and such sample(s) are retained for 90 days only.

除非另有說明，此報告結果僅對測試之樣品負責，同時此樣品僅保留90天。本報告未經本公司書面許可，不可部份複製。

This document is issued by the Company subject to its General Conditions of Service printed overleaf, available on request or accessible at www.sgs.com/terms_and_conditions.htm and, for electronic format documents, subject to Terms and Conditions for Electronic Documents at www.sgs.com/terms_e-document.htm. Attention is drawn to the limitation of liability, indemnification and jurisdiction issues defined therein. Any holder of this document is advised that information contained hereon reflects the Company's findings at the time of its intervention only and within the limits of Client's instructions, if any. The Company's sole responsibility is to its Client and this document does not exonerate parties to a transaction from exercising all their rights and obligations under the transaction documents. This document cannot be reproduced except in full, without prior written approval of the Company. Any unauthorized alteration, forgery or falsification of the content or appearance of this document is unlawful and offenders may be prosecuted to the fullest extent of the law.

SGS Taiwan Ltd. No.134, WuKungRoad, NewTaipeiIndustrialPark, WukuDistrict, NewTaipeiCity, Taiwan24803/新北市五股區新北產業園區五工路134號

台灣檢驗科技股份有限公司 t (886-2) 2299-3279

f (886-2) 2298-0488

www.tw.sgs.com

Member of SGS Group

NFC_Test mode_3

Operation Band	:NFC	Test Date	:2018-07-18
Fundamental Frequency	:13.56 MHz	Temp./Humi.	:21 deg_C / 62 RH
Operation Mode	:MASK	Engineer	:Kane
EUT Pol.	:E2 Plane	Measurement Antenna Pol.	:VERTICAL

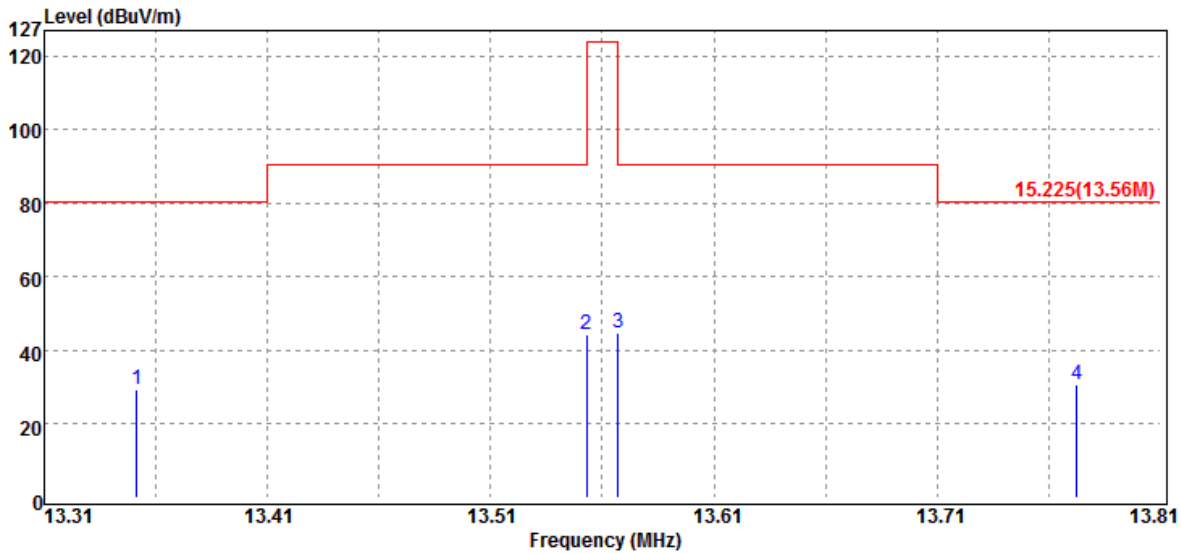

Freq. MHz	Detector Mode	Spectrum Reading Level dB μ V	Factor dB	Actual FS dB μ V/m	Limit @3m dB μ V/m	Margin dB
13.35	Peak	17.84	11.52	29.36	80.50	-51.14
13.55	Peak	32.71	11.52	44.23	90.47	-46.24
13.57	Peak	33.19	11.52	44.71	90.47	-45.76
13.77	Peak	19.13	11.53	30.66	80.50	-49.84

Unless otherwise stated the results shown in this test report refer only to the sample(s) tested and such sample(s) are retained for 90 days only.

除非另有說明，此報告結果僅對測試之樣品負責，同時此樣品僅保留90天。本報告未經本公司書面許可，不可部份複製。

This document is issued by the Company subject to its General Conditions of Service printed overleaf, available on request or accessible at www.sgs.com/terms_and_conditions.htm and, for electronic format documents, subject to Terms and Conditions for Electronic Documents at www.sgs.com/terms_e-document.htm. Attention is drawn to the limitation of liability, indemnification and jurisdiction issues defined therein. Any holder of this document is advised that information contained hereon reflects the Company's findings at the time of its intervention only and within the limits of Client's instructions, if any. The Company's sole responsibility is to its Client and this document does not exonerate parties to a transaction from exercising all their rights and obligations under the transaction documents. This document cannot be reproduced except in full, without prior written approval of the Company. Any unauthorized alteration, forgery or falsification of the content or appearance of this document is unlawful and offenders may be prosecuted to the fullest extent of the law.

SGS Taiwan Ltd. No.134, WuKungRoad, NewTaipeiIndustrialPark, WukuDistrict, NewTaipeiCity, Taiwan24803/新北市五股區新北產業園區五工路134號

台灣檢驗科技股份有限公司 t (886-2) 2299-3279

f (886-2) 2298-0488

www.tw.sgs.com

Member of SGS Group

Operation Band	:NFC	Test Date	:2018-07-18
Fundamental Frequency	:13.56 MHz	Temp./Humi.	:21 deg_C / 62 RH
Operation Mode	:MASK	Engineer	:Kane
EUT Pol.	:E2 Plane	Measurement Antenna Pol.	:HORIZONTAL

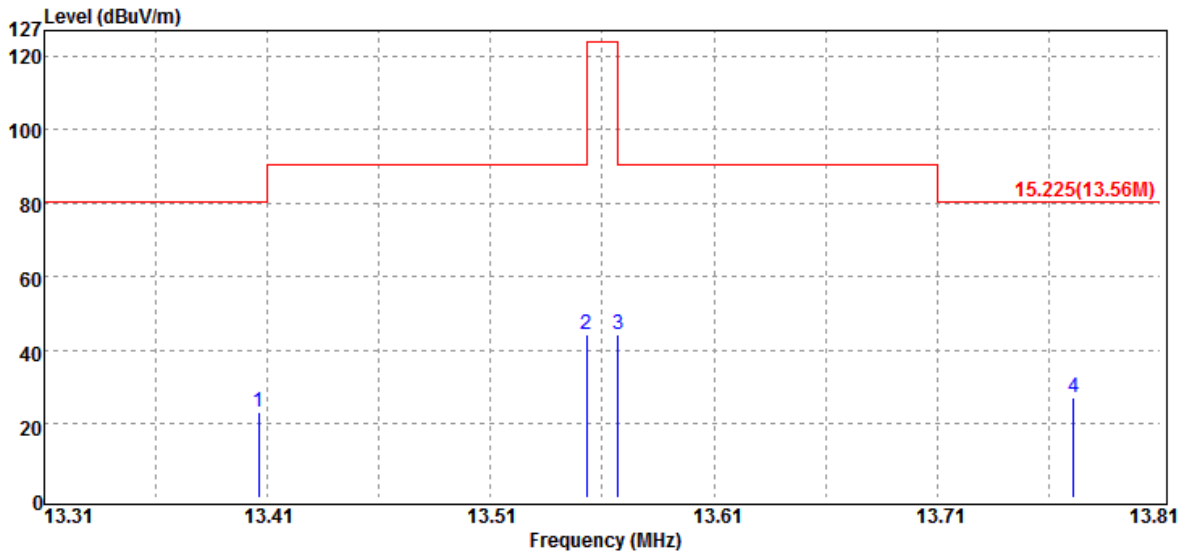

Freq. MHz	Detector Mode PK/QP/AV	Spectrum Reading Level dB μ V	Factor dB	Actual FS dB μ V/m	Limit @3m dB μ V/m	Margin dB
13.41	Peak	11.92	11.52	23.44	80.50	-57.06
13.55	Peak	32.81	11.52	44.33	90.47	-46.14
13.57	Peak	33.00	11.52	44.52	90.47	-45.95
13.77	Peak	15.51	11.53	27.04	80.50	-53.46

Unless otherwise stated the results shown in this test report refer only to the sample(s) tested and such sample(s) are retained for 90 days only.

除非另有說明，此報告結果僅對測試之樣品負責，同時此樣品僅保留90天。本報告未經本公司書面許可，不可部份複製。

This document is issued by the Company subject to its General Conditions of Service printed overleaf, available on request or accessible at www.sgs.com/terms_and_conditions.htm and, for electronic format documents, subject to Terms and Conditions for Electronic Documents at www.sgs.com/terms_e-document.htm. Attention is drawn to the limitation of liability, indemnification and jurisdiction issues defined therein. Any holder of this document is advised that information contained hereon reflects the Company's findings at the time of its intervention only and within the limits of Client's instructions, if any. The Company's sole responsibility is to its Client and this document does not exonerate parties to a transaction from exercising all their rights and obligations under the transaction documents. This document cannot be reproduced except in full, without prior written approval of the Company. Any unauthorized alteration, forgery or falsification of the content or appearance of this document is unlawful and offenders may be prosecuted to the fullest extent of the law.

SGS Taiwan Ltd. No.134, WuKungRoad, NewTaipeiIndustrialPark, WukuDistrict, NewTaipeiCity, Taiwan24803/新北市五股區新北產業園區五工路134號

台灣檢驗科技股份有限公司 t (886-2) 2299-3279

f (886-2) 2298-0488

www.tw.sgs.com

Member of SGS Group

RFID_Test mode_3

Operation Band	:RFID	Test Date	:2018-07-18
Fundamental Frequency	:13.56 MHz	Temp./Humi.	:21 deg_C / 62 RH
Operation Mode	:MASK	Engineer	:Kane
EUT Pol.	:E2 Plane	Measurement Antenna Pol.	:VERTICAL

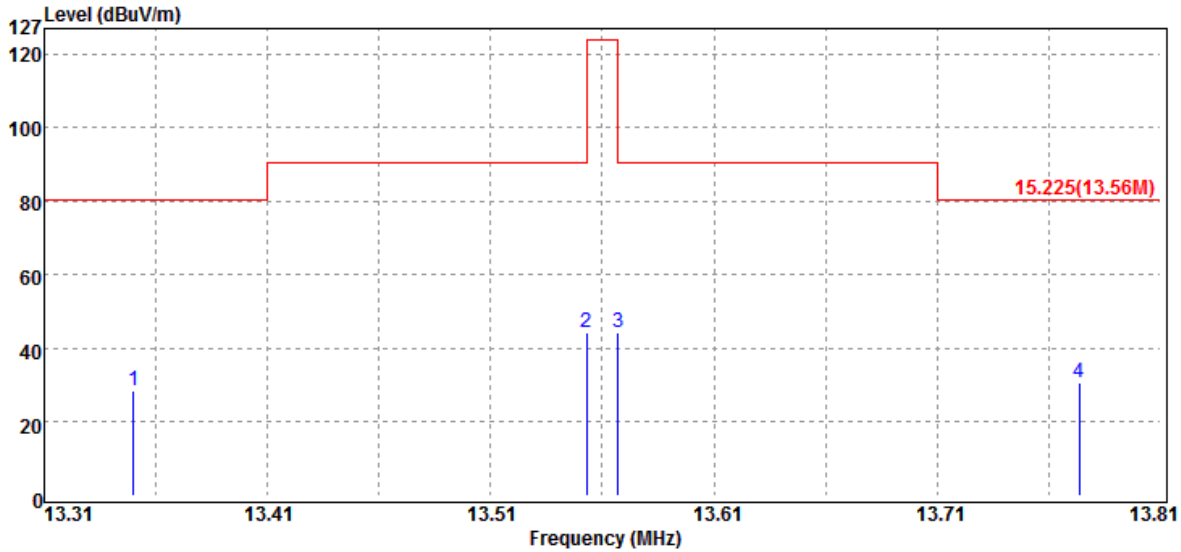

Freq. MHz	Detector Mode PK/QP/AV	Spectrum Reading Level dB μ V	Factor dB	Actual FS dB μ V/m	Limit @3m dB μ V/m	Margin dB
13.35	Peak	17.16	11.52	28.68	80.50	-51.82
13.55	Peak	32.69	11.52	44.21	90.47	-46.26
13.57	Peak	33.06	11.52	44.58	90.47	-45.89
13.77	Peak	19.34	11.53	30.87	80.50	-49.63

Unless otherwise stated the results shown in this test report refer only to the sample(s) tested and such sample(s) are retained for 90 days only.

除非另有說明，此報告結果僅對測試之樣品負責，同時此樣品僅保留90天。本報告未經本公司書面許可，不可部份複製。

This document is issued by the Company subject to its General Conditions of Service printed overleaf, available on request or accessible at www.sgs.com/terms_and_conditions.htm and, for electronic format documents, subject to Terms and Conditions for Electronic Documents at www.sgs.com/terms_e-document.htm. Attention is drawn to the limitation of liability, indemnification and jurisdiction issues defined therein. Any holder of this document is advised that information contained hereon reflects the Company's findings at the time of its intervention only and within the limits of Client's instructions, if any. The Company's sole responsibility is to its Client and this document does not exonerate parties to a transaction from exercising all their rights and obligations under the transaction documents. This document cannot be reproduced except in full, without prior written approval of the Company. Any unauthorized alteration, forgery or falsification of the content or appearance of this document is unlawful and offenders may be prosecuted to the fullest extent of the law.

SGS Taiwan Ltd. No.134, WuKungRoad, NewTaipeiIndustrialPark, WukuDistrict, NewTaipeiCity, Taiwan24803/新北市五股區新北產業園區五工路134號

台灣檢驗科技股份有限公司 t (886-2) 2299-3279

f (886-2) 2298-0488

www.tw.sgs.com

Member of SGS Group

Operation Band	:RFID	Test Date	:2018-07-18
Fundamental Frequency	:13.56 MHz	Temp./Humi.	:21 deg_C / 62 RH
Operation Mode	:MASK	Engineer	:Kane
EUT Pol.	:E2 Plane	Measurement Antenna Pol.	:HORIZONTAL

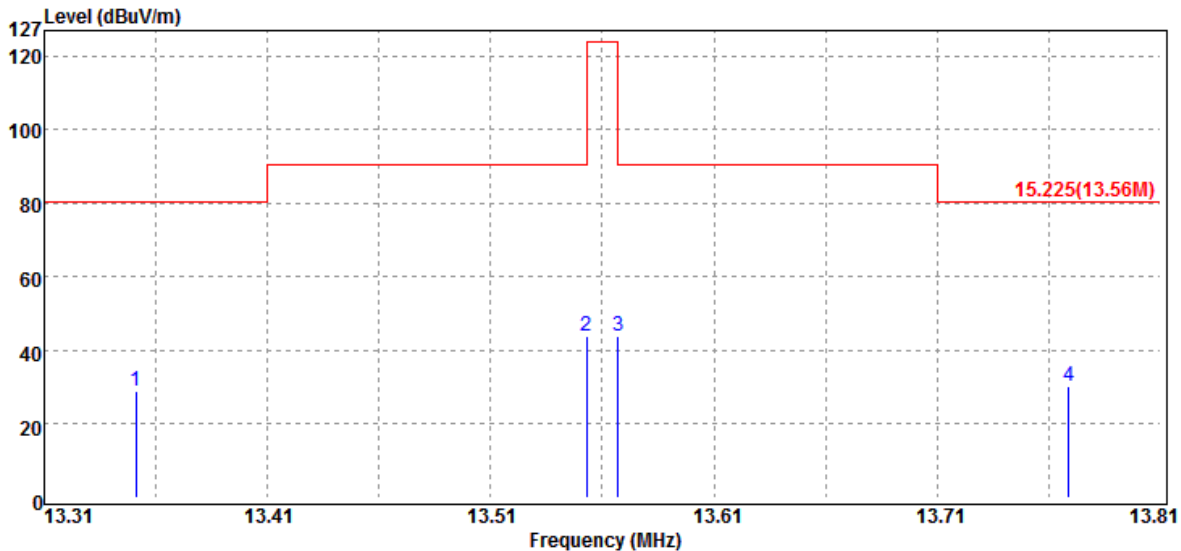

Freq. MHz	Detector Mode	Spectrum Reading Level dB μ V	Factor dB	Actual FS dB μ V/m	Limit @3m dB μ V/m	Margin dB
13.35	Peak	17.48	11.52	29.00	80.50	-51.50
13.55	Peak	32.24	11.52	43.76	90.47	-46.71
13.57	Peak	32.53	11.52	44.05	90.47	-46.42
13.77	Peak	18.79	11.53	30.32	80.50	-50.18

Unless otherwise stated the results shown in this test report refer only to the sample(s) tested and such sample(s) are retained for 90 days only.

除非另有說明，此報告結果僅對測試之樣品負責，同時此樣品僅保留90天。本報告未經本公司書面許可，不可部份複製。

This document is issued by the Company subject to its General Conditions of Service printed overleaf, available on request or accessible at www.sgs.com/terms_and_conditions.htm and, for electronic format documents, subject to Terms and Conditions for Electronic Documents at www.sgs.com/terms_e-document.htm. Attention is drawn to the limitation of liability, indemnification and jurisdiction issues defined therein. Any holder of this document is advised that information contained hereon reflects the Company's findings at the time of its intervention only and within the limits of Client's instructions, if any. The Company's sole responsibility is to its Client and this document does not exonerate parties to a transaction from exercising all their rights and obligations under the transaction documents. This document cannot be reproduced except in full, without prior written approval of the Company. Any unauthorized alteration, forgery or falsification of the content or appearance of this document is unlawful and offenders may be prosecuted to the fullest extent of the law.

SGS Taiwan Ltd. No.134, WuKungRoad, NewTaipeiIndustrialPark, WukuDistrict, NewTaipeiCity, Taiwan24803/新北市五股區新北產業園區五工路134號

台灣檢驗科技股份有限公司 t (886-2) 2299-3279

f (886-2) 2298-0488

www.tw.sgs.com

Member of SGS Group

7.6 Radiated Emission Measurement

7.6.1 Standard Applicable

The field strength of any emission which appear outside of 13.553~13.567MHz Band shall not exceed the general radiated emissions limits.

Frequency (MHz)	Field strength ($\mu\text{V/m}$)	Distance (meters)
0.009~0.490	2400/F(kHz)	300
0.490~1.705	24000/F(kHz)	30
1.705-30	30	30
30-88	100	3
88-216	150	3
216-960	200	3
Above 960	500	3

Note:

1. Emission level in $\text{dB}\mu\text{V/m} = 20 \log (\mu\text{V/m})$
2. Distance extrapolation factor = $40 \log (\text{required distance/ test distance})$ (dB)
3. The lower limit shall apply at the transition frequencies.
4. The measurement was undertaken in closer distance at 3m, where extrapolation factor is offset to convert the limit of the measurement.

Unless otherwise stated the results shown in this test report refer only to the sample(s) tested and such sample(s) are retained for 90 days only.

除非另有說明，此報告結果僅對測試之樣品負責，同時此樣品僅保留90天。本報告未經本公司書面許可，不可部份複製。

This document is issued by the Company subject to its General Conditions of Service printed overleaf, available on request or accessible at www.sgs.com/terms_and_conditions.htm and, for electronic format documents, subject to Terms and Conditions for Electronic Documents at www.sgs.com/terms_e-document.htm. Attention is drawn to the limitation of liability, indemnification and jurisdiction issues defined therein. Any holder of this document is advised that information contained hereon reflects the Company's findings at the time of its intervention only and within the limits of Client's instructions, if any. The Company's sole responsibility is to its Client and this document does not exonerate parties to a transaction from exercising all their rights and obligations under the transaction documents. This document cannot be reproduced except in full, without prior written approval of the Company. Any unauthorized alteration, forgery or falsification of the content or appearance of this document is unlawful and offenders may be prosecuted to the fullest extent of the law.

SGS Taiwan Ltd. No.134, WuKungRoad, NewTaipeiIndustrialPark, WukuDistrict, NewTaipeiCity, Taiwan24803/新北市五股區新北產業園區五工路134號

台灣檢驗科技股份有限公司 t (886-2) 2299-3279

f (886-2) 2298-0488

www.tw.sgs.com

Member of SGS Group

Radiated Emission Measurement Result

NFC_Test mode_1

Operation Band	:NFC	Test Date	:2018-07-03
Fundamental Frequency	:13.56 MHz	Temp./Humi.	:19.2 deg_C/58RH
Operation Mode	:Tx CH MID	Engineer	:Tin
EUT Pol.	:E2 Plane	Measurement Antenna Pol.	:VERTICAL

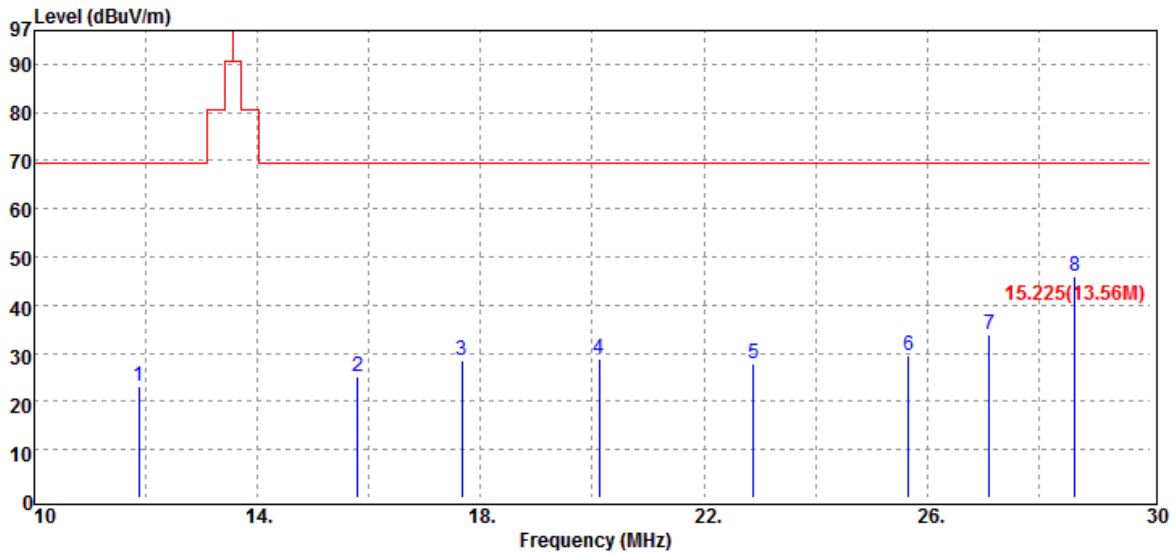

Freq. MHz	Detector Mode PK/QP/AV	Spectrum Reading Level dBuV	Factor dB	Actual FS dBuV/m	Limit @3m dBuV/m	Margin dB
11.88	Peak	11.72	11.48	23.20	69.54	-46.34
15.80	Peak	13.52	11.58	25.10	69.54	-44.44
17.66	Peak	16.78	11.61	28.39	69.54	-41.15
20.12	Peak	17.14	11.63	28.77	69.54	-40.77
22.88	Peak	16.99	10.89	27.88	69.54	-41.66
25.66	Peak	19.15	10.24	29.39	69.54	-40.15
27.12	Peak	23.85	9.94	33.79	69.54	-35.75
28.64	Peak	36.23	9.62	45.85	69.54	-23.69

Unless otherwise stated the results shown in this test report refer only to the sample(s) tested and such sample(s) are retained for 90 days only.

除非另有說明，此報告結果僅對測試之樣品負責，同時此樣品僅保留90天。本報告未經本公司書面許可，不可部份複製。

This document is issued by the Company subject to its General Conditions of Service printed overleaf, available on request or accessible at www.sgs.com/terms_and_conditions.htm and, for electronic format documents, subject to Terms and Conditions for Electronic Documents at www.sgs.com/terms_e-document.htm. Attention is drawn to the limitation of liability, indemnification and jurisdiction issues defined therein. Any holder of this document is advised that information contained hereon reflects the Company's findings at the time of its intervention only and within the limits of Client's instructions, if any. The Company's sole responsibility is to its Client and this document does not exonerate parties to a transaction from exercising all their rights and obligations under the transaction documents. This document cannot be reproduced except in full, without prior written approval of the Company. Any unauthorized alteration, forgery or falsification of the content or appearance of this document is unlawful and offenders may be prosecuted to the fullest extent of the law.

SGS Taiwan Ltd. No.134, WuKungRoad, NewTaipeiIndustrialPark, WukuDistrict, NewTaipeiCity, Taiwan24803/新北市五股區新北產業園區五工路134號

台灣檢驗科技股份有限公司 t (886-2) 2299-3279

f (886-2) 2298-0488

www.tw.sgs.com

Member of SGS Group

Operation Band	:NFC	Test Date	:2018-07-03
Fundamental Frequency	:13.56 MHz	Temp./Humi.	:19.2 deg_C/58RH
Operation Mode	:Tx CH MID	Engineer	:Tin
EUT Pol.	:E2 Plane	Measurement Antenna Pol.	:HORIZONTAL

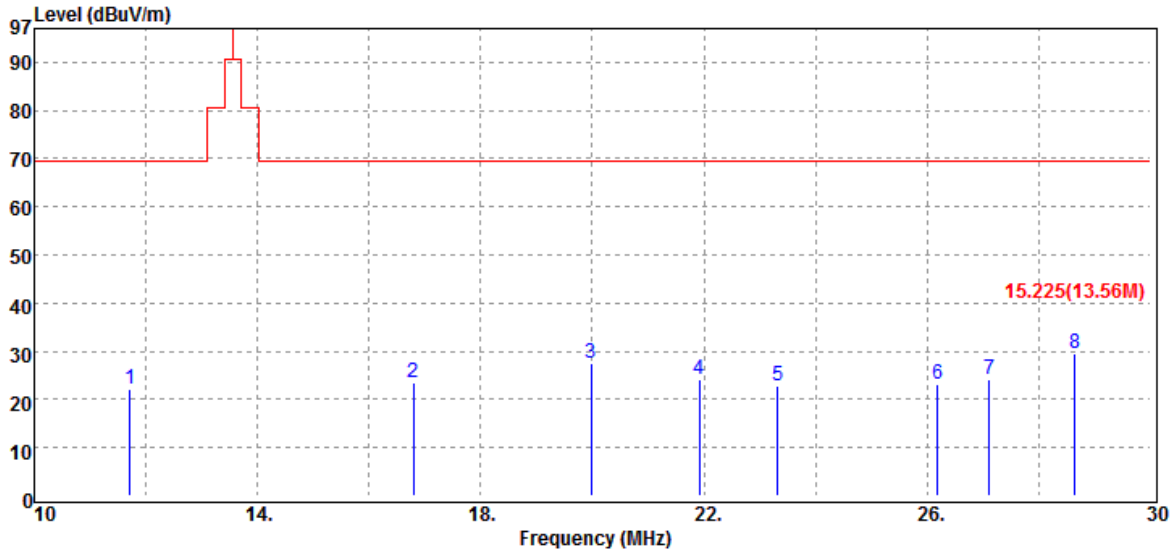

Freq. MHz	Detector Mode PK/QP/AV	Spectrum Reading Level dB μ V	Factor dB	Actual FS dB μ V/m	Limit @3m dB μ V/m	Margin dB
11.72	Peak	10.63	11.47	22.10	69.54	-47.44
16.80	Peak	11.99	11.59	23.58	69.54	-45.96
19.98	Peak	15.96	11.67	27.63	69.54	-41.91
21.92	Peak	12.88	11.14	24.02	69.54	-45.52
23.32	Peak	11.94	10.78	22.72	69.54	-46.82
26.18	Peak	12.88	10.14	23.02	69.54	-46.52
27.12	Peak	14.21	9.94	24.15	69.54	-45.39
28.64	Peak	19.78	9.62	29.40	69.54	-40.14

Unless otherwise stated the results shown in this test report refer only to the sample(s) tested and such sample(s) are retained for 90 days only.

除非另有說明，此報告結果僅對測試之樣品負責，同時此樣品僅保留90天。本報告未經本公司書面許可，不可部份複製。

This document is issued by the Company subject to its General Conditions of Service printed overleaf, available on request or accessible at www.sgs.com/terms_and_conditions.htm and, for electronic format documents, subject to Terms and Conditions for Electronic Documents at www.sgs.com/terms_e-document.htm. Attention is drawn to the limitation of liability, indemnification and jurisdiction issues defined therein. Any holder of this document is advised that information contained hereon reflects the Company's findings at the time of its intervention only and within the limits of Client's instructions, if any. The Company's sole responsibility is to its Client and this document does not exonerate parties to a transaction from exercising all their rights and obligations under the transaction documents. This document cannot be reproduced except in full, without prior written approval of the Company. Any unauthorized alteration, forgery or falsification of the content or appearance of this document is unlawful and offenders may be prosecuted to the fullest extent of the law.

SGS Taiwan Ltd. No.134, WuKungRoad, NewTaipeiIndustrialPark, WukuDistrict, NewTaipeiCity, Taiwan24803/新北市五股區新北產業園區五工路134號

台灣檢驗科技股份有限公司 t (886-2) 2299-3279

f (886-2) 2298-0488

www.tw.sgs.com

Member of SGS Group

Operation Band	:NFC	Test Date	:2018-07-03
Fundamental Frequency	:13.56 MHz	Temp./Humi.	:19.2 deg_C/58RH
Operation Mode	:Tx CH MID	Engineer	:Tin
EUT Pol.	:E2 Plane	Measurement Antenna Pol.	:VERTICAL

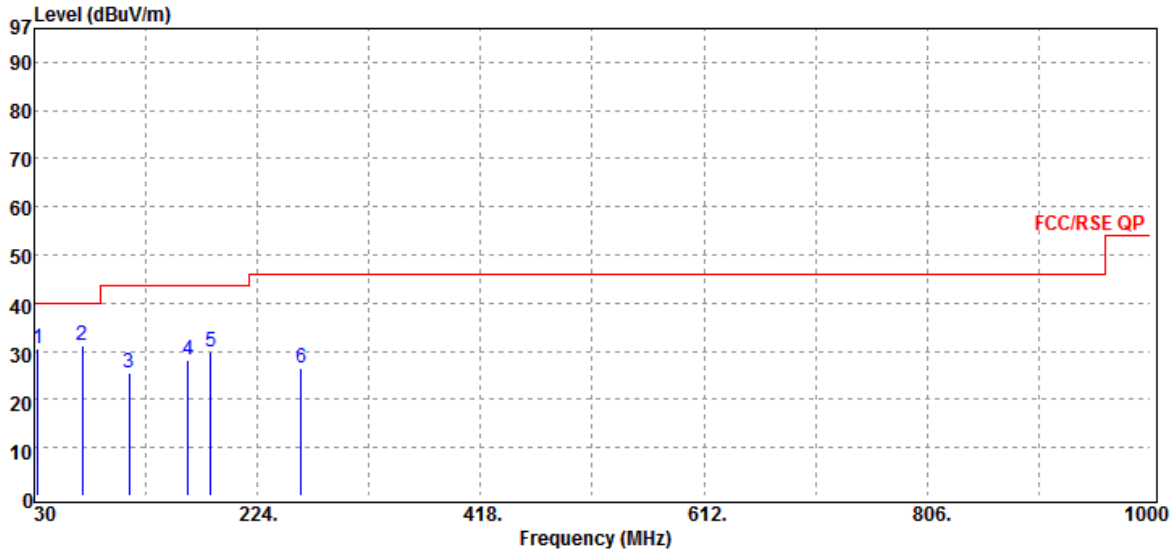

Freq. MHz	Detector Mode PK/QP/AV	Spectrum Reading Level dB μ V	Factor dB	Actual FS dB μ V/m	Limit @3m dB μ V/m	Margin dB
32.91	Peak	39.20	-8.82	30.38	40.00	-9.62
71.71	Peak	41.59	-10.42	31.17	40.00	-8.83
112.45	Peak	36.40	-10.75	25.65	43.50	-17.85
163.86	Peak	35.47	-7.27	28.20	43.50	-15.30
183.26	Peak	38.50	-8.47	30.03	43.50	-13.47
261.83	Peak	33.51	-6.95	26.56	46.00	-19.44

Unless otherwise stated the results shown in this test report refer only to the sample(s) tested and such sample(s) are retained for 90 days only.

除非另有說明，此報告結果僅對測試之樣品負責，同時此樣品僅保留90天。本報告未經本公司書面許可，不可部份複製。

This document is issued by the Company subject to its General Conditions of Service printed overleaf, available on request or accessible at www.sgs.com/terms_and_conditions.htm and, for electronic format documents, subject to Terms and Conditions for Electronic Documents at www.sgs.com/terms_e-document.htm. Attention is drawn to the limitation of liability, indemnification and jurisdiction issues defined therein. Any holder of this document is advised that information contained hereon reflects the Company's findings at the time of its intervention only and within the limits of Client's instructions, if any. The Company's sole responsibility is to its Client and this document does not exonerate parties to a transaction from exercising all their rights and obligations under the transaction documents. This document cannot be reproduced except in full, without prior written approval of the Company. Any unauthorized alteration, forgery or falsification of the content or appearance of this document is unlawful and offenders may be prosecuted to the fullest extent of the law.

SGS Taiwan Ltd. No.134, WuKungRoad, NewTaipeiIndustrialPark, WukuDistrict, NewTaipeiCity, Taiwan24803/新北市五股區新北產業園區五工路134號

台灣檢驗科技股份有限公司 t (886-2) 2299-3279

f (886-2) 2298-0488

www.tw.sgs.com

Member of SGS Group

Operation Band	:NFC	Test Date	:2018-07-03
Fundamental Frequency	:13.56 MHz	Temp./Humi.	:19.2 deg_C/58RH
Operation Mode	:Tx CH MID	Engineer	:Tin
EUT Pol.	:E2 Plane	Measurement Antenna Pol.	:HORIZONTAL

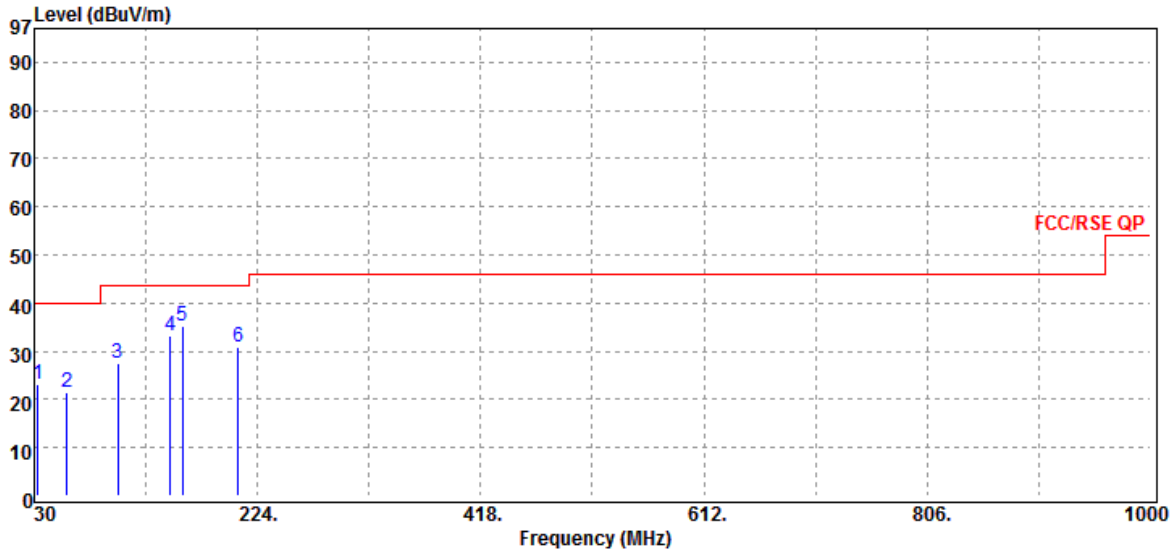

Freq. MHz	Detector Mode PK/QP/AV	Spectrum Reading Level dB μ V	Factor dB	Actual FS dB μ V/m	Limit @3m dB μ V/m	Margin dB
32.91	Peak	31.84	-8.82	23.02	40.00	-16.98
58.13	Peak	29.19	-7.75	21.44	40.00	-18.56
102.75	Peak	39.42	-11.98	27.44	43.50	-16.06
148.34	Peak	40.81	-7.47	33.34	43.50	-10.16
159.01	Peak	42.26	-7.13	35.13	43.50	-8.37
207.51	Peak	40.13	-9.26	30.87	43.50	-12.63

Unless otherwise stated the results shown in this test report refer only to the sample(s) tested and such sample(s) are retained for 90 days only.

除非另有說明，此報告結果僅對測試之樣品負責，同時此樣品僅保留90天。本報告未經本公司書面許可，不可部份複製。

This document is issued by the Company subject to its General Conditions of Service printed overleaf, available on request or accessible at www.sgs.com/terms_and_conditions.htm and, for electronic format documents, subject to Terms and Conditions for Electronic Documents at www.sgs.com/terms_e-document.htm. Attention is drawn to the limitation of liability, indemnification and jurisdiction issues defined therein. Any holder of this document is advised that information contained hereon reflects the Company's findings at the time of its intervention only and within the limits of Client's instructions, if any. The Company's sole responsibility is to its Client and this document does not exonerate parties to a transaction from exercising all their rights and obligations under the transaction documents. This document cannot be reproduced except in full, without prior written approval of the Company. Any unauthorized alteration, forgery or falsification of the content or appearance of this document is unlawful and offenders may be prosecuted to the fullest extent of the law.

SGS Taiwan Ltd. No.134, WuKungRoad, NewTaipeiIndustrialPark, WukuDistrict, NewTaipeiCity, Taiwan24803/新北市五股區新北產業園區五工路134號

台灣檢驗科技股份有限公司 t (886-2) 2299-3279

f (886-2) 2298-0488

www.tw.sgs.com

Member of SGS Group

RFID_Test mode_1

Operation Band	:RFID	Test Date	:2018-07-03
Fundamental Frequency	:13.56 MHz	Temp./Humi.	:19.2 deg_C/58RH
Operation Mode	:Tx CH MID	Engineer	:Tin
EUT Pol.	:E2 Plan	Measurement Antenna Pol.	:VERTICAL

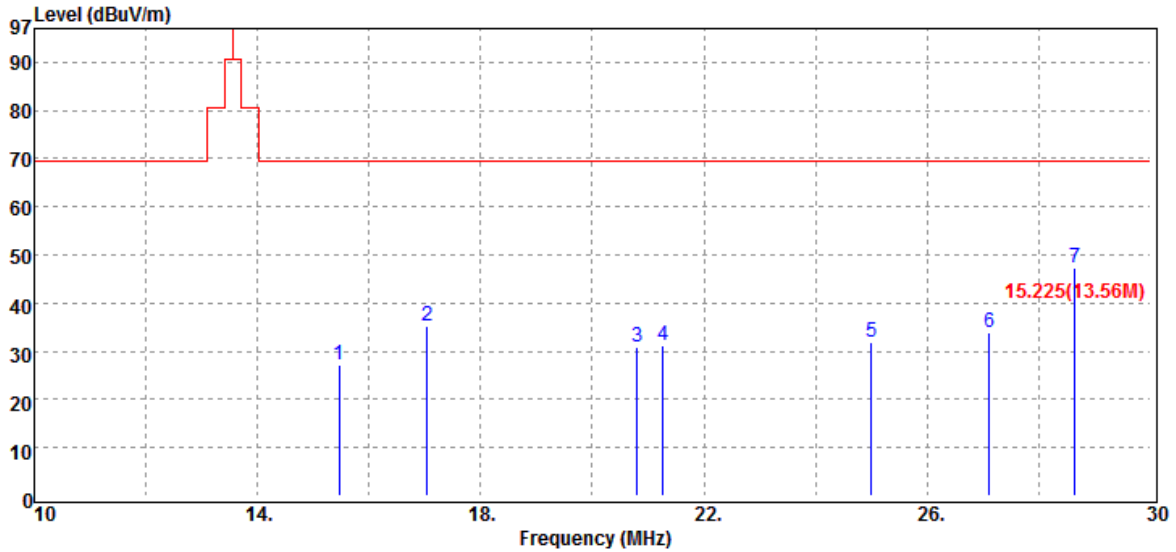

Freq. MHz	Detector Mode PK/QP/AV	Spectrum Reading Level dB μ V	Factor dB	Actual FS dB μ V/m	Limit @3m dB μ V/m	Margin dB
15.46	Peak	15.64	11.56	27.20	69.54	-42.34
17.04	Peak	23.70	11.60	35.30	69.54	-34.24
20.80	Peak	19.48	11.44	30.92	69.54	-38.62
21.26	Peak	20.06	11.32	31.38	69.54	-38.16
25.00	Peak	21.38	10.39	31.77	69.54	-37.77
27.12	Peak	24.12	9.94	34.06	69.54	-35.48
28.64	Peak	37.70	9.62	47.32	69.54	-22.22

Unless otherwise stated the results shown in this test report refer only to the sample(s) tested and such sample(s) are retained for 90 days only.

除非另有說明，此報告結果僅對測試之樣品負責，同時此樣品僅保留90天。本報告未經本公司書面許可，不可部份複製。

This document is issued by the Company subject to its General Conditions of Service printed overleaf, available on request or accessible at www.sgs.com/terms_and_conditions.htm and, for electronic format documents, subject to Terms and Conditions for Electronic Documents at www.sgs.com/terms_e-document.htm. Attention is drawn to the limitation of liability, indemnification and jurisdiction issues defined therein. Any holder of this document is advised that information contained hereon reflects the Company's findings at the time of its intervention only and within the limits of Client's instructions, if any. The Company's sole responsibility is to its Client and this document does not exonerate parties to a transaction from exercising all their rights and obligations under the transaction documents. This document cannot be reproduced except in full, without prior written approval of the Company. Any unauthorized alteration, forgery or falsification of the content or appearance of this document is unlawful and offenders may be prosecuted to the fullest extent of the law.

SGS Taiwan Ltd. No.134, WuKungRoad, NewTaipeiIndustrialPark, WukuDistrict, NewTaipeiCity, Taiwan24803/新北市五股區新北產業園區五工路134號

台灣檢驗科技股份有限公司 t (886-2) 2299-3279

f (886-2) 2298-0488

www.tw.sgs.com

Member of SGS Group

Operation Band	:RFID	Test Date	:2018-07-03
Fundamental Frequency	:13.56 MHz	Temp./Humi.	:19.2 deg_C/58RH
Operation Mode	:Tx CH MID	Engineer	:Tin
EUT Pol.	:E2 Plan	Measurement Antenna Pol.	:HORIZONTAL

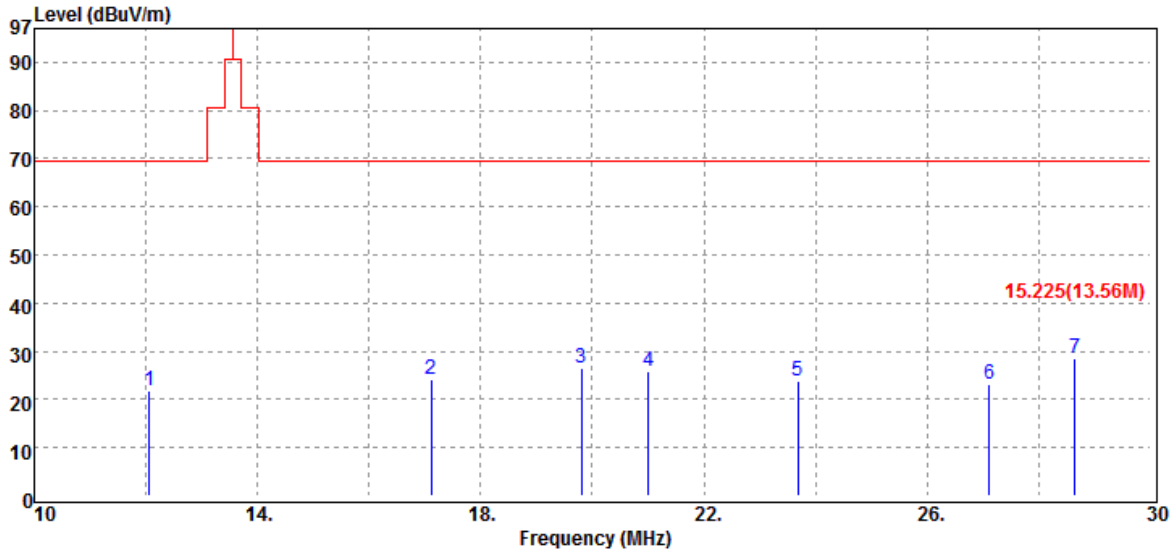

Freq. MHz	Detector Mode PK/QP/AV	Spectrum Reading Level dB μ V	Factor dB	Actual FS dB μ V/m	Limit @3m dB μ V/m	Margin dB
12.06	Peak	10.31	11.49	21.80	69.54	-47.74
17.12	Peak	12.47	11.60	24.07	69.54	-45.47
19.80	Peak	14.76	11.67	26.43	69.54	-43.11
21.00	Peak	14.58	11.38	25.96	69.54	-43.58
23.68	Peak	13.21	10.70	23.91	69.54	-45.63
27.12	Peak	13.11	9.94	23.05	69.54	-46.49
28.64	Peak	18.87	9.62	28.49	69.54	-41.05

Unless otherwise stated the results shown in this test report refer only to the sample(s) tested and such sample(s) are retained for 90 days only.

除非另有說明，此報告結果僅對測試之樣品負責，同時此樣品僅保留90天。本報告未經本公司書面許可，不可部份複製。

This document is issued by the Company subject to its General Conditions of Service printed overleaf, available on request or accessible at www.sgs.com/terms_and_conditions.htm and, for electronic format documents, subject to Terms and Conditions for Electronic Documents at www.sgs.com/terms_e-document.htm. Attention is drawn to the limitation of liability, indemnification and jurisdiction issues defined therein. Any holder of this document is advised that information contained hereon reflects the Company's findings at the time of its intervention only and within the limits of Client's instructions, if any. The Company's sole responsibility is to its Client and this document does not exonerate parties to a transaction from exercising all their rights and obligations under the transaction documents. This document cannot be reproduced except in full, without prior written approval of the Company. Any unauthorized alteration, forgery or falsification of the content or appearance of this document is unlawful and offenders may be prosecuted to the fullest extent of the law.

SGS Taiwan Ltd. No.134, WuKungRoad, NewTaipeiIndustrialPark, WukuDistrict, NewTaipeiCity, Taiwan24803/新北市五股區新北產業園區五工路134號

台灣檢驗科技股份有限公司 t (886-2) 2299-3279

f (886-2) 2298-0488

www.tw.sgs.com

Member of SGS Group

Operation Band	:RFID	Test Date	:2018-06-25
Fundamental Frequency	:13.56 MHz	Temp./Humi.	:19.2 deg_C/58RH
Operation Mode	:Tx CH MID	Engineer	:Tin
EUT Pol.	:E2 Plan	Measurement Antenna Pol.	:VERTICAL

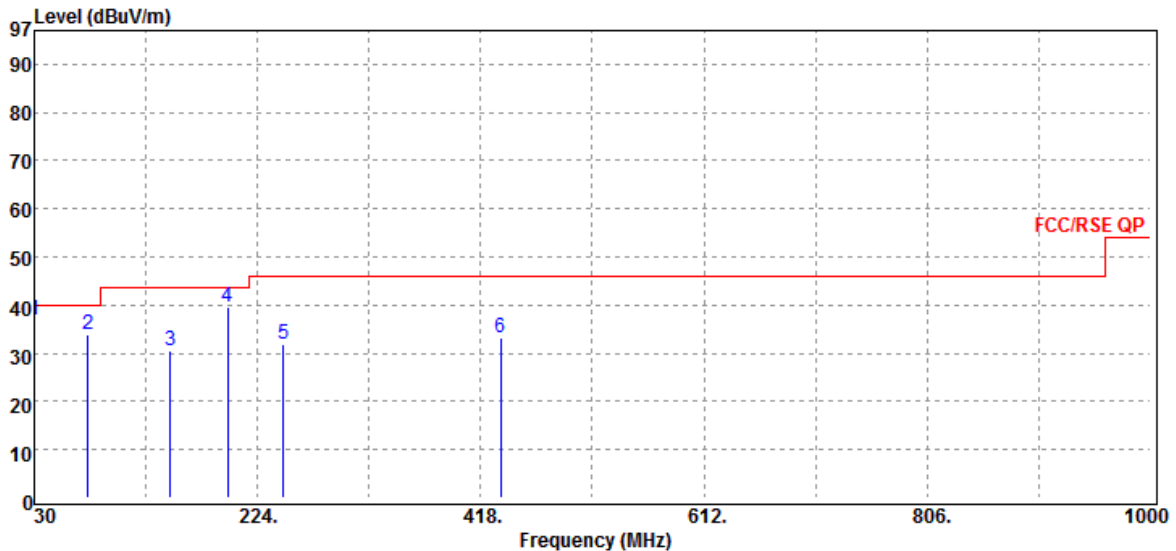

Freq. MHz	Detector Mode PK/QP/AV	Spectrum Reading Level dB μ V	Factor dB	Actual FS dB μ V/m	Limit @3m dB μ V/m	Margin dB
30.00	Peak	45.78	-8.96	36.82	40.00	-3.18
76.56	Peak	45.12	-11.34	33.78	40.00	-6.22
148.34	Peak	37.87	-7.47	30.40	43.50	-13.10
197.81	Peak	48.97	-9.20	39.77	43.50	-3.73
246.31	Peak	39.33	-7.47	31.86	46.00	-14.14
435.46	Peak	36.40	-3.24	33.16	46.00	-12.84

Unless otherwise stated the results shown in this test report refer only to the sample(s) tested and such sample(s) are retained for 90 days only.

除非另有說明，此報告結果僅對測試之樣品負責，同時此樣品僅保留90天。本報告未經本公司書面許可，不可部份複製。

This document is issued by the Company subject to its General Conditions of Service printed overleaf, available on request or accessible at www.sgs.com/terms_and_conditions.htm and, for electronic format documents, subject to Terms and Conditions for Electronic Documents at www.sgs.com/terms_e-document.htm. Attention is drawn to the limitation of liability, indemnification and jurisdiction issues defined therein. Any holder of this document is advised that information contained hereon reflects the Company's findings at the time of its intervention only and within the limits of Client's instructions, if any. The Company's sole responsibility is to its Client and this document does not exonerate parties to a transaction from exercising all their rights and obligations under the transaction documents. This document cannot be reproduced except in full, without prior written approval of the Company. Any unauthorized alteration, forgery or falsification of the content or appearance of this document is unlawful and offenders may be prosecuted to the fullest extent of the law.

SGS Taiwan Ltd. No.134, WuKungRoad, NewTaipeiIndustrialPark, WukuDistrict, NewTaipeiCity, Taiwan24803/新北市五股區新北產業園區五工路134號

台灣檢驗科技股份有限公司 t (886-2) 2299-3279

f (886-2) 2298-0488

www.tw.sgs.com

Member of SGS Group

Operation Band	:RFID	Test Date	:2018-06-25
Fundamental Frequency	:13.56 MHz	Temp./Humi.	:19.2 deg_C/58RH
Operation Mode	:Tx CH MID	Engineer	:Tin
EUT Pol.	:E2 Plan	Measurement Antenna Pol.	:HORIZONTAL

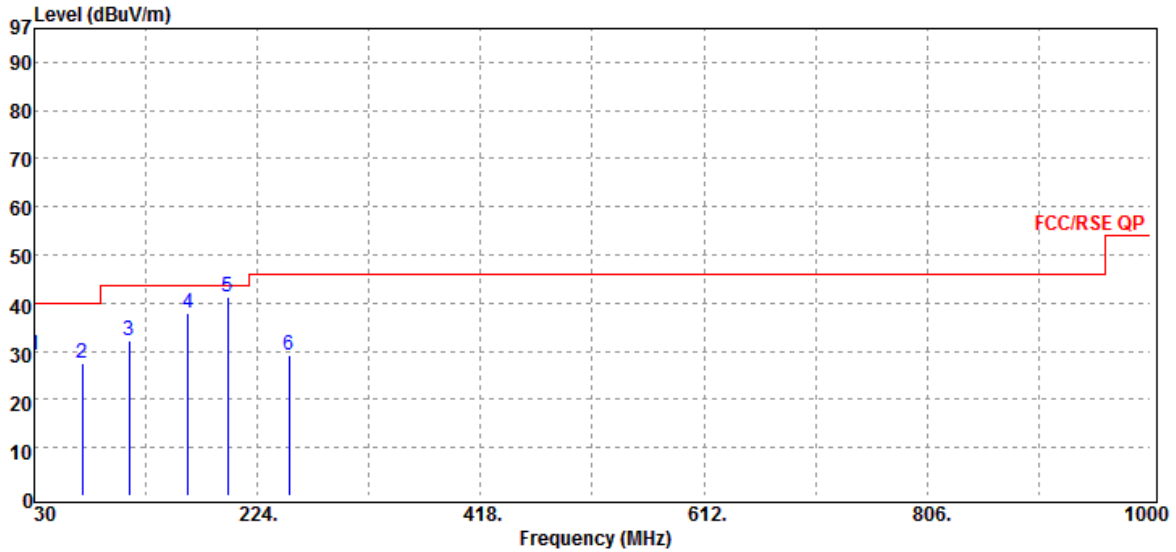

Freq. MHz	Detector Mode PK/QP/AV	Spectrum Reading Level dB μ V	Factor dB	Actual FS dB μ V/m	Limit @3m dB μ V/m	Margin dB
30.00	Peak	38.21	-8.96	29.25	40.00	-10.75
71.71	Peak	37.97	-10.42	27.55	40.00	-12.45
112.45	Peak	43.08	-10.75	32.33	43.50	-11.17
163.86	Peak	45.29	-7.27	38.02	43.50	-5.48
197.81	Peak	50.54	-9.20	41.34	43.50	-2.16
251.16	Peak	36.70	-7.34	29.36	46.00	-16.64

Unless otherwise stated the results shown in this test report refer only to the sample(s) tested and such sample(s) are retained for 90 days only.

除非另有說明，此報告結果僅對測試之樣品負責，同時此樣品僅保留90天。本報告未經本公司書面許可，不可部份複製。

This document is issued by the Company subject to its General Conditions of Service printed overleaf, available on request or accessible at www.sgs.com/terms_and_conditions.htm and, for electronic format documents, subject to Terms and Conditions for Electronic Documents at www.sgs.com/terms_e-document.htm. Attention is drawn to the limitation of liability, indemnification and jurisdiction issues defined therein. Any holder of this document is advised that information contained hereon reflects the Company's findings at the time of its intervention only and within the limits of Client's instructions, if any. The Company's sole responsibility is to its Client and this document does not exonerate parties to a transaction from exercising all their rights and obligations under the transaction documents. This document cannot be reproduced except in full, without prior written approval of the Company. Any unauthorized alteration, forgery or falsification of the content or appearance of this document is unlawful and offenders may be prosecuted to the fullest extent of the law.

SGS Taiwan Ltd. No.134, WuKungRoad, NewTaipeiIndustrialPark, WukuDistrict, NewTaipeiCity, Taiwan24803/新北市五股區新北產業園區五工路134號

台灣檢驗科技股份有限公司 t (886-2) 2299-3279

f (886-2) 2298-0488

www.tw.sgs.com

Member of SGS Group

NFC_Test mode_2

Operation Band	:NFC	Test Date	:2018-07-03
Fundamental Frequency	:13.56 MHz	Temp./Humi.	:21 deg_C / 62 RH
Operation Mode	:Tx CH MID	Engineer	:Tin
EUT Pol.	:E2 Plane	Measurement Antenna Pol.	:VERTICAL

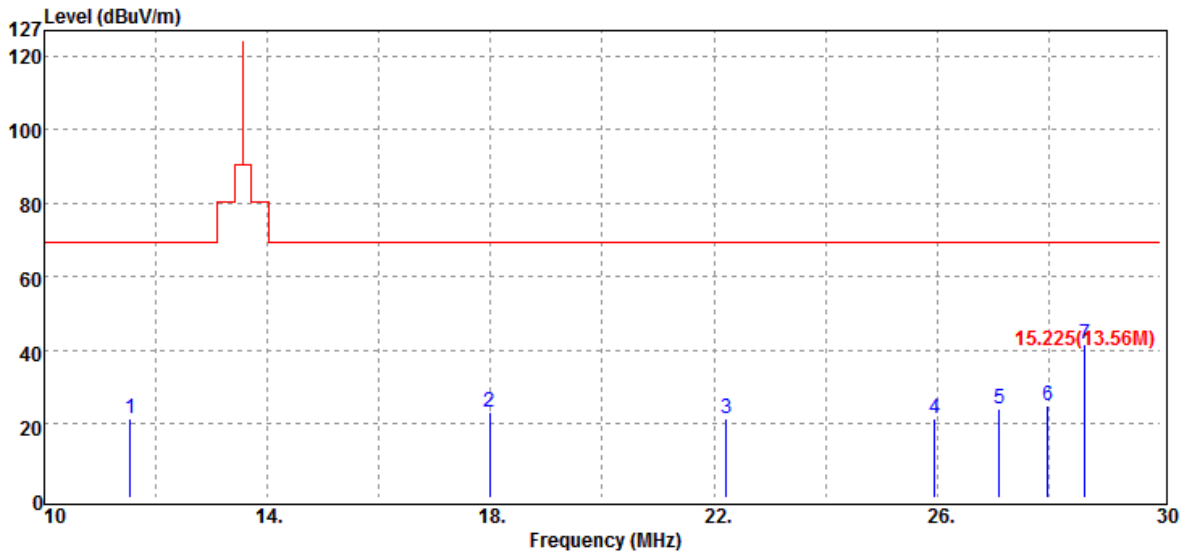

Freq. MHz	Detector Mode PK/QP/AV	Spectrum Reading Level dB μ V	Factor dB	Actual FS dB μ V/m	Limit @3m dB μ V/m	Margin dB
11.54	Peak	10.22	11.47	21.69	69.54	-47.85
17.98	Peak	11.82	11.62	23.44	69.54	-46.10
22.22	Peak	10.28	11.06	21.34	69.54	-48.20
25.96	Peak	11.42	10.19	21.61	69.54	-47.93
27.12	Peak	14.21	9.94	24.15	69.54	-45.39
27.98	Peak	15.28	9.76	25.04	69.54	-44.50
28.64	Peak	32.30	9.62	41.92	69.54	-27.62

Unless otherwise stated the results shown in this test report refer only to the sample(s) tested and such sample(s) are retained for 90 days only.

除非另有說明，此報告結果僅對測試之樣品負責，同時此樣品僅保留90天。本報告未經本公司書面許可，不可部份複製。

This document is issued by the Company subject to its General Conditions of Service printed overleaf, available on request or accessible at www.sgs.com/terms_and_conditions.htm and, for electronic format documents, subject to Terms and Conditions for Electronic Documents at www.sgs.com/terms_e-document.htm. Attention is drawn to the limitation of liability, indemnification and jurisdiction issues defined therein. Any holder of this document is advised that information contained hereon reflects the Company's findings at the time of its intervention only and within the limits of Client's instructions, if any. The Company's sole responsibility is to its Client and this document does not exonerate parties to a transaction from exercising all their rights and obligations under the transaction documents. This document cannot be reproduced except in full, without prior written approval of the Company. Any unauthorized alteration, forgery or falsification of the content or appearance of this document is unlawful and offenders may be prosecuted to the fullest extent of the law.

SGS Taiwan Ltd. No.134, WuKungRoad, NewTaipeiIndustrialPark, WukuDistrict, NewTaipeiCity, Taiwan24803/新北市五股區新北產業園區五工路134號

台灣檢驗科技股份有限公司 t (886-2) 2299-3279

f (886-2) 2298-0488

www.tw.sgs.com

Member of SGS Group

Operation Band	:NFC	Test Date	:2018-07-03
Fundamental Frequency	:13.56 MHz	Temp./Humi.	:21 deg_C / 62 RH
Operation Mode	:Tx CH MID	Engineer	:Tin
EUT Pol.	:E2 Plane	Measurement Antenna Pol.	:HORIZONTAL

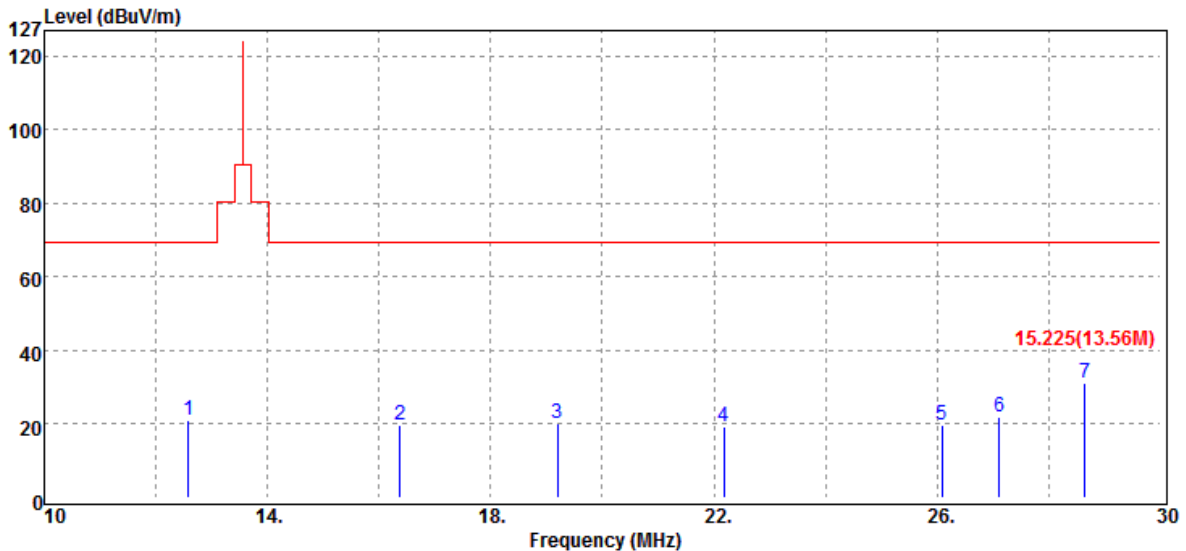

Freq. MHz	Detector Mode PK/QP/AV	Spectrum Reading Level dB μ V	Factor dB	Actual FS dB μ V/m	Limit @3m dB μ V/m	Margin dB
12.58	Peak	9.44	11.50	20.94	69.54	-48.60
16.38	Peak	8.40	11.59	19.99	69.54	-49.55
19.20	Peak	8.44	11.65	20.09	69.54	-49.45
22.18	Peak	8.41	11.07	19.48	69.54	-50.06
26.08	Peak	9.43	10.16	19.59	69.54	-49.95
27.12	Peak	12.19	9.94	22.13	69.54	-47.41
28.64	Peak	21.50	9.62	31.12	69.54	-38.42

Unless otherwise stated the results shown in this test report refer only to the sample(s) tested and such sample(s) are retained for 90 days only.

除非另有說明，此報告結果僅對測試之樣品負責，同時此樣品僅保留90天。本報告未經本公司書面許可，不可部份複製。

This document is issued by the Company subject to its General Conditions of Service printed overleaf, available on request or accessible at www.sgs.com/terms_and_conditions.htm and, for electronic format documents, subject to Terms and Conditions for Electronic Documents at www.sgs.com/terms_e-document.htm. Attention is drawn to the limitation of liability, indemnification and jurisdiction issues defined therein. Any holder of this document is advised that information contained hereon reflects the Company's findings at the time of its intervention only and within the limits of Client's instructions, if any. The Company's sole responsibility is to its Client and this document does not exonerate parties to a transaction from exercising all their rights and obligations under the transaction documents. This document cannot be reproduced except in full, without prior written approval of the Company. Any unauthorized alteration, forgery or falsification of the content or appearance of this document is unlawful and offenders may be prosecuted to the fullest extent of the law.

SGS Taiwan Ltd. No.134, WuKungRoad, NewTaipeiIndustrialPark, WukuDistrict, NewTaipeiCity, Taiwan24803/新北市五股區新北產業園區五工路134號

台灣檢驗科技股份有限公司 t (886-2) 2299-3279

f (886-2) 2298-0488

www.tw.sgs.com

Member of SGS Group

Operation Band	:NFC	Test Date	:2018-07-03
Fundamental Frequency	:13.56 MHz	Temp./Humi.	:21 deg_C / 62 RH
Operation Mode	:Tx CH MID	Engineer	:Tin
EUT Pol.	:E2 Plane	Measurement Antenna Pol.	:VERTICAL

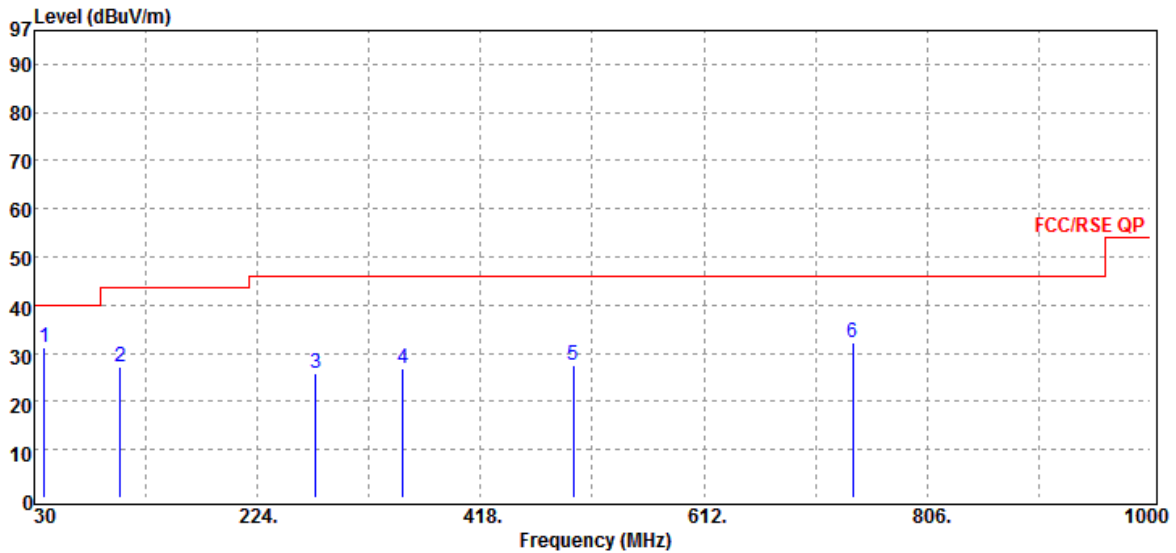

Freq. MHz	Detector Mode PK/QP/AV	Spectrum Reading Level dBμV	Factor dB	Actual FS dBμV/m	Limit @3m dBμV/m	Margin dB
38.73	Peak	39.71	-8.38	31.33	40.00	-8.67
104.69	Peak	39.05	-11.70	27.35	43.50	-16.15
274.44	Peak	32.15	-6.44	25.71	46.00	-20.29
350.10	Peak	31.40	-4.68	26.72	46.00	-19.28
498.51	Peak	30.01	-2.53	27.48	46.00	-18.52
741.01	Peak	28.94	3.35	32.29	46.00	-13.71

Unless otherwise stated the results shown in this test report refer only to the sample(s) tested and such sample(s) are retained for 90 days only.

除非另有說明，此報告結果僅對測試之樣品負責，同時此樣品僅保留90天。本報告未經本公司書面許可，不可部份複製。

This document is issued by the Company subject to its General Conditions of Service printed overleaf, available on request or accessible at www.sgs.com/terms_and_conditions.htm and, for electronic format documents, subject to Terms and Conditions for Electronic Documents at www.sgs.com/terms_e-document.htm. Attention is drawn to the limitation of liability, indemnification and jurisdiction issues defined therein. Any holder of this document is advised that information contained hereon reflects the Company's findings at the time of its intervention only and within the limits of Client's instructions, if any. The Company's sole responsibility is to its Client and this document does not exonerate parties to a transaction from exercising all their rights and obligations under the transaction documents. This document cannot be reproduced except in full, without prior written approval of the Company. Any unauthorized alteration, forgery or falsification of the content or appearance of this document is unlawful and offenders may be prosecuted to the fullest extent of the law.

SGS Taiwan Ltd. No.134, WuKungRoad, NewTaipeiIndustrialPark, WukuDistrict, NewTaipeiCity, Taiwan24803/新北市五股區新北產業園區五工路134號

台灣檢驗科技股份有限公司 t (886-2) 2299-3279

f (886-2) 2298-0488

www.tw.sgs.com

Member of SGS Group

Operation Band	:NFC	Test Date	:2018-07-03
Fundamental Frequency	:13.56 MHz	Temp./Humi.	:21 deg_C / 62 RH
Operation Mode	:Tx CH MID	Engineer	:Tin
EUT Pol.	:E2 Plane	Measurement Antenna Pol.	:HORIZONTAL

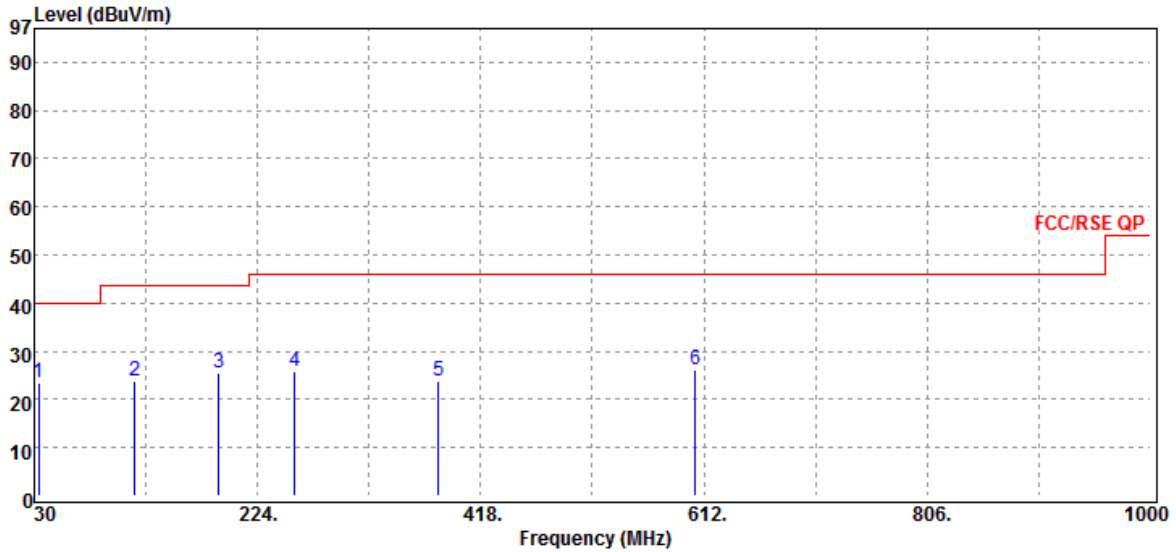

Freq. MHz	Detector Mode PK/QP/AV	Spectrum Reading Level dB μ V	Factor dB	Actual FS dB μ V/m	Limit @3m dB μ V/m	Margin dB
33.88	Peak	32.40	-8.78	23.62	40.00	-16.38
117.30	Peak	34.30	-10.35	23.95	43.50	-19.55
190.05	Peak	34.46	-8.96	25.50	43.50	-18.00
256.01	Peak	32.85	-7.13	25.72	46.00	-20.28
381.14	Peak	27.48	-3.78	23.70	46.00	-22.30
604.24	Peak	26.62	-0.55	26.07	46.00	-19.93

Unless otherwise stated the results shown in this test report refer only to the sample(s) tested and such sample(s) are retained for 90 days only.

除非另有說明，此報告結果僅對測試之樣品負責，同時此樣品僅保留90天。本報告未經本公司書面許可，不可部份複製。

This document is issued by the Company subject to its General Conditions of Service printed overleaf, available on request or accessible at www.sgs.com/terms_and_conditions.htm and, for electronic format documents, subject to Terms and Conditions for Electronic Documents at www.sgs.com/terms_e-document.htm. Attention is drawn to the limitation of liability, indemnification and jurisdiction issues defined therein. Any holder of this document is advised that information contained hereon reflects the Company's findings at the time of its intervention only and within the limits of Client's instructions, if any. The Company's sole responsibility is to its Client and this document does not exonerate parties to a transaction from exercising all their rights and obligations under the transaction documents. This document cannot be reproduced except in full, without prior written approval of the Company. Any unauthorized alteration, forgery or falsification of the content or appearance of this document is unlawful and offenders may be prosecuted to the fullest extent of the law.

SGS Taiwan Ltd. No.134, WuKungRoad, NewTaipeiIndustrialPark, WukuDistrict, NewTaipeiCity, Taiwan24803/新北市五股區新北產業園區五工路134號

台灣檢驗科技股份有限公司 t (886-2) 2299-3279

f (886-2) 2298-0488

www.tw.sgs.com

Member of SGS Group

RFID_Test mode_2

Operation Band	:RFID	Test Date	:2018-06-26
Fundamental Frequency	:13.56 MHz	Temp./Humi.	:24.1 deg_C / 65 RH
Operation Mode	:Tx CH MID	Engineer	:Mike
EUT Pol.	:E2 Plane	Measurement Antenna Pol.	:VERTICAL

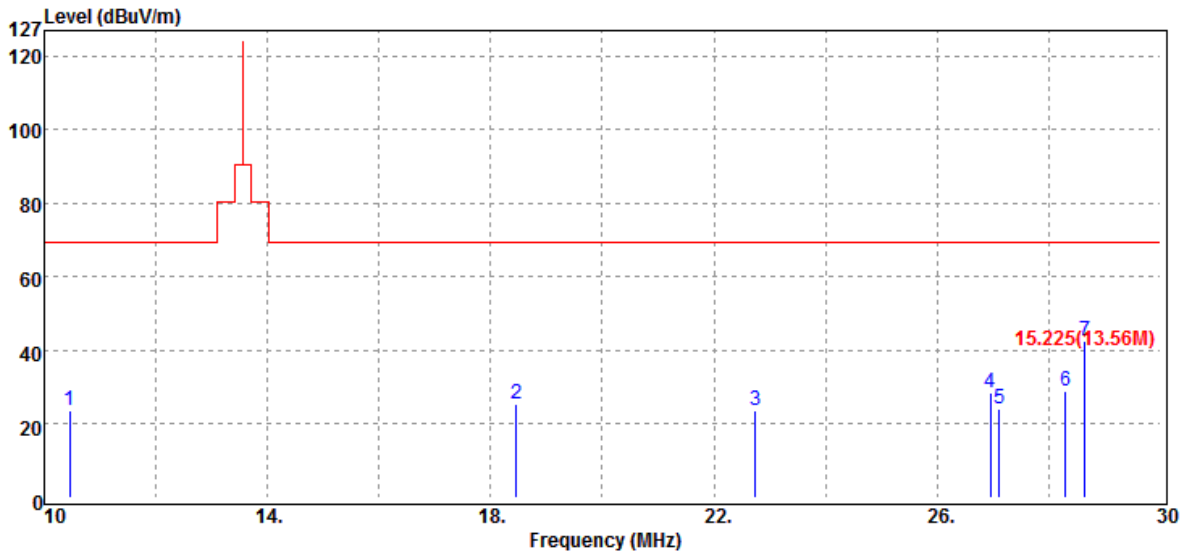

Freq. MHz	Detector Mode PK/QP/AV	Spectrum Reading Level dB μ V	Factor dB	Actual FS dB μ V/m	Limit @3m dB μ V/m	Margin dB
10.46	Peak	12.22	11.44	23.66	69.54	-45.88
18.46	Peak	13.87	11.64	25.51	69.54	-44.03
22.74	Peak	12.89	10.93	23.82	69.54	-45.72
26.96	Peak	18.77	9.97	28.74	69.54	-40.80
27.12	Peak	14.43	9.94	24.37	69.54	-45.17
28.30	Peak	19.21	9.70	28.91	69.54	-40.63
28.64	Peak	33.02	9.62	42.64	69.54	-26.90

Unless otherwise stated the results shown in this test report refer only to the sample(s) tested and such sample(s) are retained for 90 days only.

除非另有說明，此報告結果僅對測試之樣品負責，同時此樣品僅保留90天。本報告未經本公司書面許可，不可部份複製。

This document is issued by the Company subject to its General Conditions of Service printed overleaf, available on request or accessible at www.sgs.com/terms_and_conditions.htm and, for electronic format documents, subject to Terms and Conditions for Electronic Documents at www.sgs.com/terms_e-document.htm. Attention is drawn to the limitation of liability, indemnification and jurisdiction issues defined therein. Any holder of this document is advised that information contained hereon reflects the Company's findings at the time of its intervention only and within the limits of Client's instructions, if any. The Company's sole responsibility is to its Client and this document does not exonerate parties to a transaction from exercising all their rights and obligations under the transaction documents. This document cannot be reproduced except in full, without prior written approval of the Company. Any unauthorized alteration, forgery or falsification of the content or appearance of this document is unlawful and offenders may be prosecuted to the fullest extent of the law.

SGS Taiwan Ltd. No.134, WuKungRoad, NewTaipeiIndustrialPark, WukuDistrict, NewTaipeiCity, Taiwan24803/新北市五股區新北產業園區五工路134號

台灣檢驗科技股份有限公司 t (886-2) 2299-3279

f (886-2) 2298-0488

www.tw.sgs.com

Member of SGS Group

Operation Band	:RFID	Test Date	:2018-06-26
Fundamental Frequency	:13.56 MHz	Temp./Humi.	:24.1 deg_C / 65 RH
Operation Mode	:Tx CH MID	Engineer	:Mike
EUT Pol.	:E2 Plane	Measurement Antenna Pol.	:HORIZONTAL

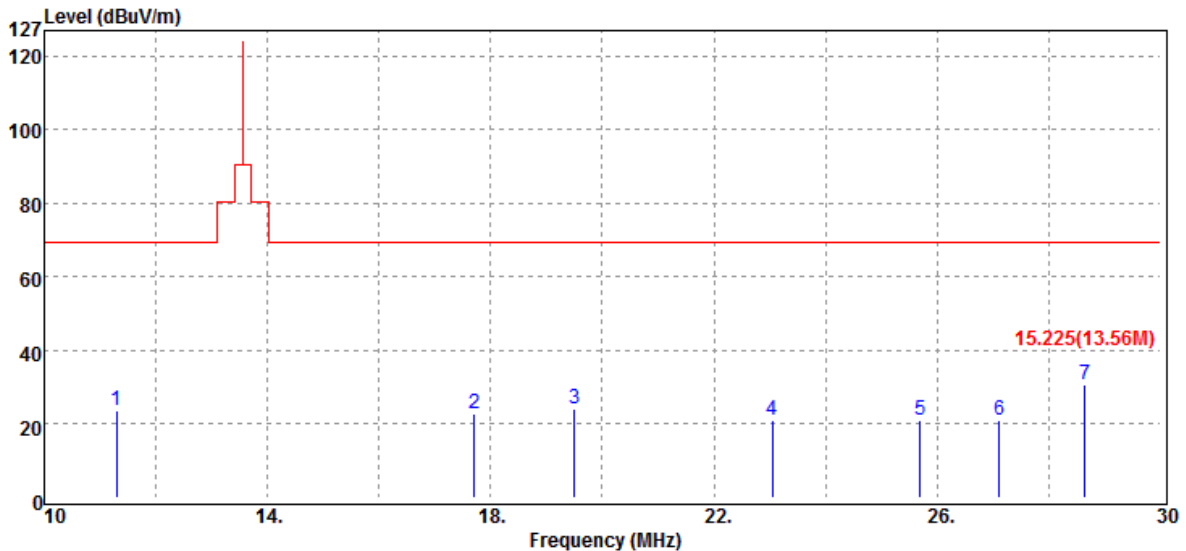

Freq. MHz	Detector Mode PK/QP/AV	Spectrum Reading Level dB μ V	Factor dB	Actual FS dB μ V/m	Limit @3m dB μ V/m	Margin dB
11.30	Peak	12.10	11.47	23.57	69.54	-45.97
17.70	Peak	11.07	11.62	22.69	69.54	-46.85
19.50	Peak	12.54	11.66	24.20	69.54	-45.34
23.04	Peak	10.46	10.85	21.31	69.54	-48.23
25.70	Peak	10.86	10.25	21.11	69.54	-48.43
27.12	Peak	11.36	9.94	21.30	69.54	-48.24
28.64	Peak	21.33	9.62	30.95	69.54	-38.59

Unless otherwise stated the results shown in this test report refer only to the sample(s) tested and such sample(s) are retained for 90 days only.

除非另有說明，此報告結果僅對測試之樣品負責，同時此樣品僅保留90天。本報告未經本公司書面許可，不可部份複製。

This document is issued by the Company subject to its General Conditions of Service printed overleaf, available on request or accessible at www.sgs.com/terms_and_conditions.htm and, for electronic format documents, subject to Terms and Conditions for Electronic Documents at www.sgs.com/terms_e-document.htm. Attention is drawn to the limitation of liability, indemnification and jurisdiction issues defined therein. Any holder of this document is advised that information contained hereon reflects the Company's findings at the time of its intervention only and within the limits of Client's instructions, if any. The Company's sole responsibility is to its Client and this document does not exonerate parties to a transaction from exercising all their rights and obligations under the transaction documents. This document cannot be reproduced except in full, without prior written approval of the Company. Any unauthorized alteration, forgery or falsification of the content or appearance of this document is unlawful and offenders may be prosecuted to the fullest extent of the law.

SGS Taiwan Ltd. No.134, WuKungRoad, NewTaipeiIndustrialPark, WukuDistrict, NewTaipeiCity, Taiwan24803/新北市五股區新北產業園區五工路134號

台灣檢驗科技股份有限公司 t (886-2) 2299-3279

f (886-2) 2298-0488

www.tw.sgs.com

Member of SGS Group

Operation Band	:RFID	Test Date	:2018-06-26
Fundamental Frequency	:13.56 MHz	Temp./Humi.	:24.1 deg_C / 65 RH
Operation Mode	:Tx CH MID	Engineer	:Mike
EUT Pol.	:E2 Plane	Measurement Antenna Pol.	:VERTICAL

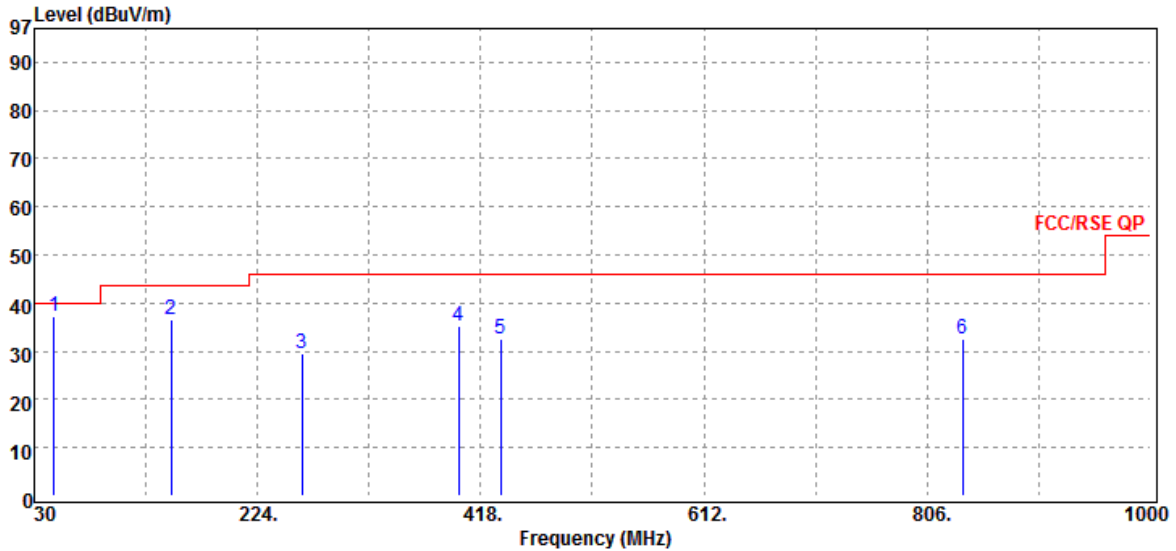

Freq. MHz	Detector Mode PK/QP/AV	Spectrum Reading Level d μ V	Factor dB	Actual FS dB μ V/m	Limit @3m dB μ V/m	Margin dB
47.46	Peak	45.05	-7.64	37.41	40.00	-2.59
149.31	Peak	44.03	-7.41	36.62	43.50	-6.88
262.80	Peak	36.53	-6.91	29.62	46.00	-16.38
398.60	Peak	38.72	-3.41	35.31	46.00	-10.69
435.46	Peak	35.80	-3.24	32.56	46.00	-13.44
837.04	Peak	27.34	5.16	32.50	46.00	-13.50

Unless otherwise stated the results shown in this test report refer only to the sample(s) tested and such sample(s) are retained for 90 days only.

除非另有說明，此報告結果僅對測試之樣品負責，同時此樣品僅保留90天。本報告未經本公司書面許可，不可部份複製。

This document is issued by the Company subject to its General Conditions of Service printed overleaf, available on request or accessible at www.sgs.com/terms_and_conditions.htm and, for electronic format documents, subject to Terms and Conditions for Electronic Documents at www.sgs.com/terms_e-document.htm. Attention is drawn to the limitation of liability, indemnification and jurisdiction issues defined therein. Any holder of this document is advised that information contained hereon reflects the Company's findings at the time of its intervention only and within the limits of Client's instructions, if any. The Company's sole responsibility is to its Client and this document does not exonerate parties to a transaction from exercising all their rights and obligations under the transaction documents. This document cannot be reproduced except in full, without prior written approval of the Company. Any unauthorized alteration, forgery or falsification of the content or appearance of this document is unlawful and offenders may be prosecuted to the fullest extent of the law.

SGS Taiwan Ltd. No.134, WuKungRoad, NewTaipeiIndustrialPark, WukuDistrict, NewTaipeiCity, Taiwan24803/新北市五股區新北產業園區五工路134號

台灣檢驗科技股份有限公司 t (886-2) 2299-3279

f (886-2) 2298-0488

www.tw.sgs.com

Member of SGS Group

Operation Band	:RFID	Test Date	:2018-06-26
Fundamental Frequency	:13.56 MHz	Temp./Humi.	:24.1 deg_C / 65 RH
Operation Mode	:Tx CH MID	Engineer	:Mike
EUT Pol.	:E2 Plane	Measurement Antenna Pol.	:HORIZONTAL

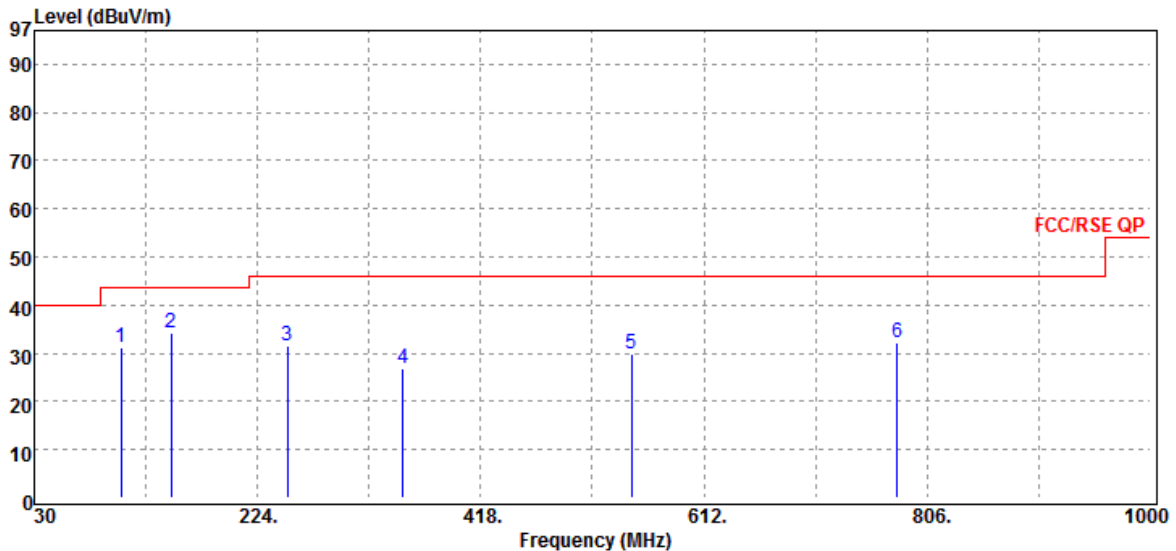

Freq. MHz	Detector Mode PK/QP/AV	Spectrum Reading Level dB μ V	Factor dB	Actual FS dB μ V/m	Limit @3m dB μ V/m	Margin dB
105.66	Peak	42.88	-11.58	31.30	43.50	-12.20
149.31	Peak	41.78	-7.41	34.37	43.50	-9.13
250.19	Peak	38.84	-7.40	31.44	46.00	-14.56
350.10	Peak	31.68	-4.68	27.00	46.00	-19.00
548.95	Peak	31.44	-1.53	29.91	46.00	-16.09
779.81	Peak	28.46	3.84	32.30	46.00	-13.70

Unless otherwise stated the results shown in this test report refer only to the sample(s) tested and such sample(s) are retained for 90 days only.

除非另有說明，此報告結果僅對測試之樣品負責，同時此樣品僅保留90天。本報告未經本公司書面許可，不可部份複製。

This document is issued by the Company subject to its General Conditions of Service printed overleaf, available on request or accessible at www.sgs.com/terms_and_conditions.htm and, for electronic format documents, subject to Terms and Conditions for Electronic Documents at www.sgs.com/terms_e-document.htm. Attention is drawn to the limitation of liability, indemnification and jurisdiction issues defined therein. Any holder of this document is advised that information contained hereon reflects the Company's findings at the time of its intervention only and within the limits of Client's instructions, if any. The Company's sole responsibility is to its Client and this document does not exonerate parties to a transaction from exercising all their rights and obligations under the transaction documents. This document cannot be reproduced except in full, without prior written approval of the Company. Any unauthorized alteration, forgery or falsification of the content or appearance of this document is unlawful and offenders may be prosecuted to the fullest extent of the law.

SGS Taiwan Ltd. No.134, WuKungRoad, NewTaipeiIndustrialPark, WukuDistrict, NewTaipeiCity, Taiwan24803/新北市五股區新北產業園區五工路134號

台灣檢驗科技股份有限公司 t (886-2) 2299-3279

f (886-2) 2298-0488

www.tw.sgs.com

Member of SGS Group

NFC_Test mode_3

Operation Band	:NFC	Test Date	:2018-07-18
Fundamental Frequency	:13.56 MHz	Temp./Humi.	:21 deg_C / 62 RH
Operation Mode	:Tx	Engineer	:Kane
EUT Pol.	:E2 Plane	Measurement Antenna Pol.	:VERTICAL

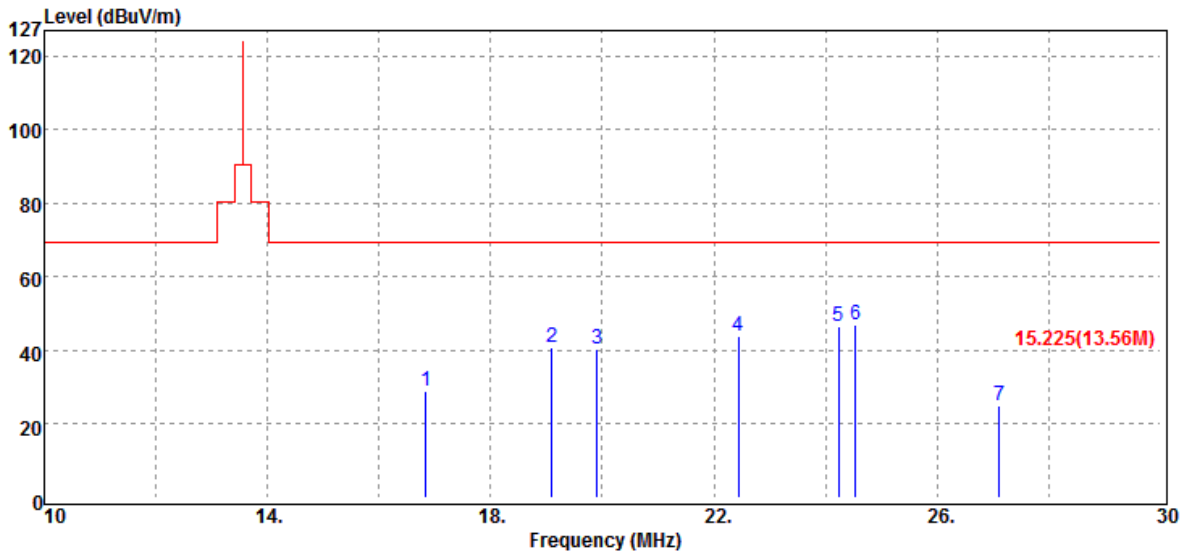

Freq. MHz	Detector Mode PK/QP/AV	Spectrum Reading Level dBuV	Factor dB	Actual FS dBuV/m	Limit @3m dBuV/m	Margin dB
16.84	Peak	17.20	11.60	28.80	69.54	-40.74
19.10	Peak	29.03	11.65	40.68	69.54	-28.86
19.90	Peak	28.71	11.67	40.38	69.54	-29.16
22.44	Peak	33.02	11.00	44.02	69.54	-25.52
24.24	Peak	36.10	10.56	46.66	69.54	-22.88
24.54	Peak	36.31	10.50	46.81	69.54	-22.73
27.12	Peak	15.29	9.94	25.23	69.54	-44.31

Unless otherwise stated the results shown in this test report refer only to the sample(s) tested and such sample(s) are retained for 90 days only.

除非另有說明，此報告結果僅對測試之樣品負責，同時此樣品僅保留90天。本報告未經本公司書面許可，不可部份複製。

This document is issued by the Company subject to its General Conditions of Service printed overleaf, available on request or accessible at www.sgs.com/terms_and_conditions.htm and, for electronic format documents, subject to Terms and Conditions for Electronic Documents at www.sgs.com/terms_e-document.htm. Attention is drawn to the limitation of liability, indemnification and jurisdiction issues defined therein. Any holder of this document is advised that information contained hereon reflects the Company's findings at the time of its intervention only and within the limits of Client's instructions, if any. The Company's sole responsibility is to its Client and this document does not exonerate parties to a transaction from exercising all their rights and obligations under the transaction documents. This document cannot be reproduced except in full, without prior written approval of the Company. Any unauthorized alteration, forgery or falsification of the content or appearance of this document is unlawful and offenders may be prosecuted to the fullest extent of the law.

SGS Taiwan Ltd. No.134, WuKungRoad, NewTaipeiIndustrialPark, WukuDistrict, NewTaipeiCity, Taiwan24803/新北市五股區新北產業園區五工路134號

台灣檢驗科技股份有限公司 t (886-2) 2299-3279

f (886-2) 2298-0488

www.tw.sgs.com

Member of SGS Group

Operation Band	:NFC	Test Date	:2018-07-18
Fundamental Frequency	:13.56 MHz	Temp./Humi.	:21 deg_C / 62 RH
Operation Mode	:Tx	Engineer	:Kane
EUT Pol.	:E2 Plane	Measurement Antenna Pol.	:HORIZONTAL

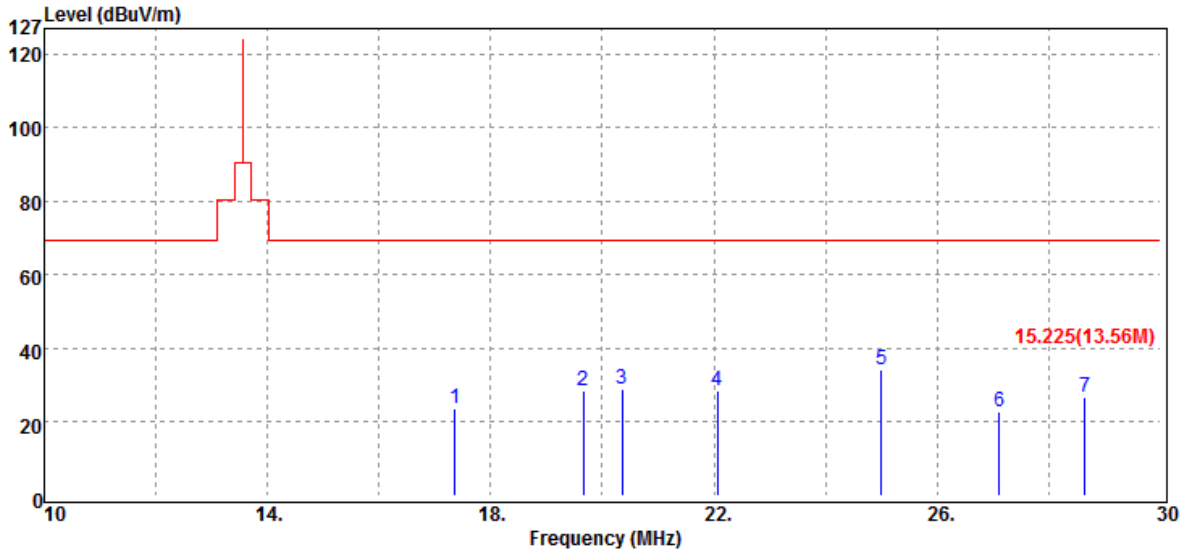

Freq. MHz	Detector Mode PK/QP/AV	Spectrum Reading Level dB μ V	Factor dB	Actual FS dB μ V/m	Limit @3m dB μ V/m	Margin dB
17.36	Peak	11.91	11.61	23.52	69.54	-46.02
19.66	Peak	16.97	11.66	28.63	69.54	-40.91
20.36	Peak	17.62	11.56	29.18	69.54	-40.36
22.06	Peak	17.65	11.10	28.75	69.54	-40.79
25.00	Peak	23.69	10.39	34.08	69.54	-35.46
27.12	Peak	13.10	9.94	23.04	69.54	-46.50
28.64	Peak	17.16	9.62	26.78	69.54	-42.76

Unless otherwise stated the results shown in this test report refer only to the sample(s) tested and such sample(s) are retained for 90 days only.

除非另有說明，此報告結果僅對測試之樣品負責，同時此樣品僅保留90天。本報告未經本公司書面許可，不可部份複製。

This document is issued by the Company subject to its General Conditions of Service printed overleaf, available on request or accessible at www.sgs.com/terms_and_conditions.htm and, for electronic format documents, subject to Terms and Conditions for Electronic Documents at www.sgs.com/terms_e-document.htm. Attention is drawn to the limitation of liability, indemnification and jurisdiction issues defined therein. Any holder of this document is advised that information contained hereon reflects the Company's findings at the time of its intervention only and within the limits of Client's instructions, if any. The Company's sole responsibility is to its Client and this document does not exonerate parties to a transaction from exercising all their rights and obligations under the transaction documents. This document cannot be reproduced except in full, without prior written approval of the Company. Any unauthorized alteration, forgery or falsification of the content or appearance of this document is unlawful and offenders may be prosecuted to the fullest extent of the law.

SGS Taiwan Ltd. No.134, WuKungRoad, NewTaipeiIndustrialPark, WukuDistrict, NewTaipeiCity, Taiwan24803/新北市五股區新北產業園區五工路134號

台灣檢驗科技股份有限公司 t (886-2) 2299-3279

f (886-2) 2298-0488

www.tw.sgs.com

Member of SGS Group

Operation Band	:NFC	Test Date	:2018-07-18
Fundamental Frequency	:13.56 MHz	Temp./Humi.	:21 deg_C / 62 RH
Operation Mode	:Tx	Engineer	:Kane
EUT Pol.	:E2 Plane	Measurement Antenna Pol.	:VERTICAL

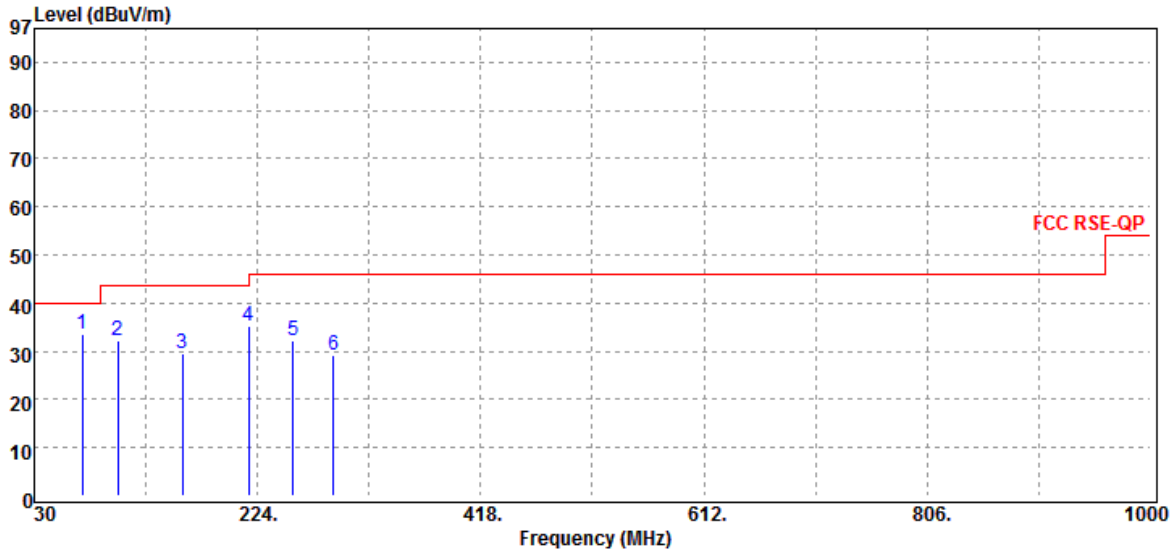

Freq. MHz	Detector Mode PK/QP/AV	Spectrum Reading Level dB μ V	Factor dB	Actual FS dB μ V/m	Limit @3m dB μ V/m	Margin dB
71.71	Peak	43.89	-10.42	33.47	40.00	-6.53
102.75	Peak	44.10	-11.98	32.12	43.50	-11.38
159.01	Peak	36.63	-7.13	29.50	43.50	-14.00
216.24	Peak	44.31	-9.14	35.17	46.00	-10.83
255.04	Peak	39.32	-7.15	32.17	46.00	-13.83
289.96	Peak	34.87	-5.82	29.05	46.00	-16.95

Unless otherwise stated the results shown in this test report refer only to the sample(s) tested and such sample(s) are retained for 90 days only.

除非另有說明，此報告結果僅對測試之樣品負責，同時此樣品僅保留90天。本報告未經本公司書面許可，不可部份複製。

This document is issued by the Company subject to its General Conditions of Service printed overleaf, available on request or accessible at www.sgs.com/terms_and_conditions.htm and, for electronic format documents, subject to Terms and Conditions for Electronic Documents at www.sgs.com/terms_e-document.htm. Attention is drawn to the limitation of liability, indemnification and jurisdiction issues defined therein. Any holder of this document is advised that information contained hereon reflects the Company's findings at the time of its intervention only and within the limits of Client's instructions, if any. The Company's sole responsibility is to its Client and this document does not exonerate parties to a transaction from exercising all their rights and obligations under the transaction documents. This document cannot be reproduced except in full, without prior written approval of the Company. Any unauthorized alteration, forgery or falsification of the content or appearance of this document is unlawful and offenders may be prosecuted to the fullest extent of the law.

SGS Taiwan Ltd. No.134, WuKungRoad, NewTaipeiIndustrialPark, WukuDistrict, NewTaipeiCity, Taiwan24803/新北市五股區新北產業園區五工路134號

台灣檢驗科技股份有限公司 t (886-2) 2299-3279

f (886-2) 2298-0488

www.tw.sgs.com

Member of SGS Group

Operation Band	:NFC	Test Date	:2018-07-18
Fundamental Frequency	:13.56 MHz	Temp./Humi.	:21 deg_C / 62 RH
Operation Mode	:Tx	Engineer	:Kane
EUT Pol.	:E2 Plane	Measurement Antenna Pol.	:HORIZONTAL

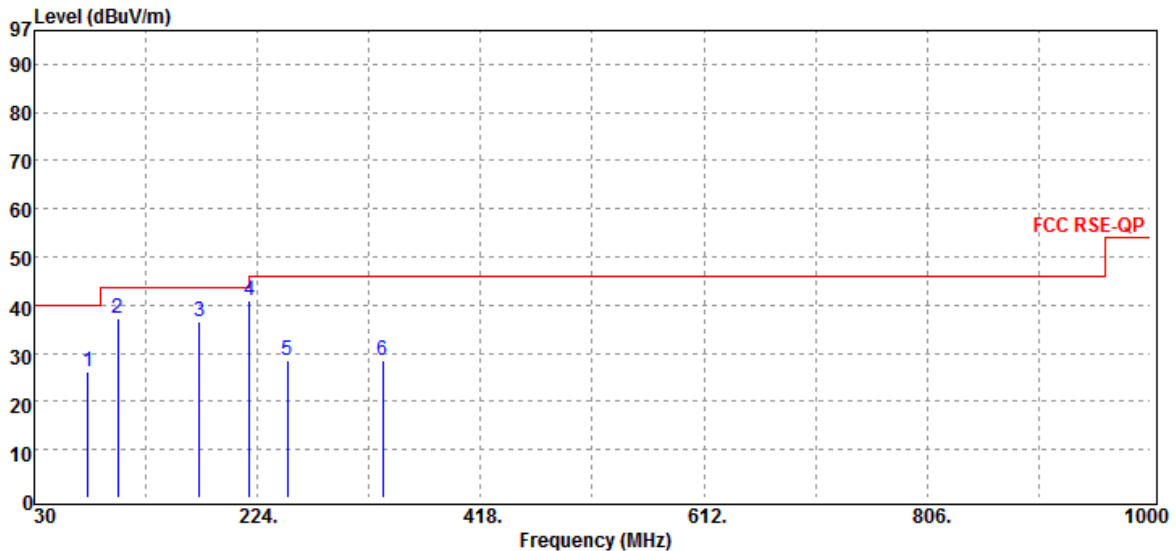

Freq. MHz	Detector Mode PK/QP/AV	Spectrum Reading Level dB μ V	Factor dB	Actual FS dB μ V/m	Limit @3m dB μ V/m	Margin dB
76.56	Peak	37.47	-11.34	26.13	40.00	-13.87
102.75	Peak	49.16	-11.98	37.18	43.50	-6.32
173.56	Peak	44.12	-7.70	36.42	43.50	-7.08
217.21	Peak	50.02	-9.12	40.90	46.00	-5.10
250.19	Peak	35.78	-7.40	28.38	46.00	-17.62
332.64	Peak	33.32	-4.90	28.42	46.00	-17.58

Unless otherwise stated the results shown in this test report refer only to the sample(s) tested and such sample(s) are retained for 90 days only.

除非另有說明，此報告結果僅對測試之樣品負責，同時此樣品僅保留90天。本報告未經本公司書面許可，不可部份複製。

This document is issued by the Company subject to its General Conditions of Service printed overleaf, available on request or accessible at www.sgs.com/terms_and_conditions.htm and, for electronic format documents, subject to Terms and Conditions for Electronic Documents at www.sgs.com/terms_e-document.htm. Attention is drawn to the limitation of liability, indemnification and jurisdiction issues defined therein. Any holder of this document is advised that information contained hereon reflects the Company's findings at the time of its intervention only and within the limits of Client's instructions, if any. The Company's sole responsibility is to its Client and this document does not exonerate parties to a transaction from exercising all their rights and obligations under the transaction documents. This document cannot be reproduced except in full, without prior written approval of the Company. Any unauthorized alteration, forgery or falsification of the content or appearance of this document is unlawful and offenders may be prosecuted to the fullest extent of the law.

SGS Taiwan Ltd. No.134, WuKungRoad, NewTaipeiIndustrialPark, WukuDistrict, NewTaipeiCity, Taiwan24803/新北市五股區新北產業園區五工路134號

台灣檢驗科技股份有限公司 t (886-2) 2299-3279

f (886-2) 2298-0488

www.tw.sgs.com

Member of SGS Group

RFID_Test mode_3

Operation Band	:RFID	Test Date	:2018-07-18
Fundamental Frequency	:13.56 MHz	Temp./Humi.	:21 deg_C / 62 RH
Operation Mode	:Tx	Engineer	:Kane
EUT Pol.	:E2 Plane	Measurement Antenna Pol.	:VERTICAL

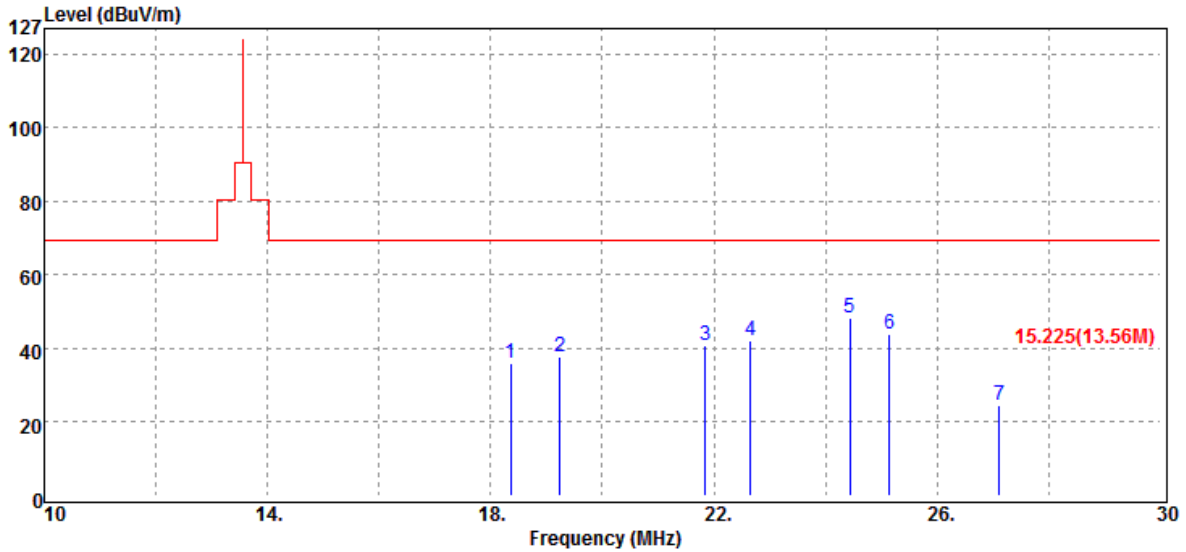

Freq. MHz	Detector Mode PK/QP/AV	Spectrum Reading Level d μ V	Factor dB	Actual FS d μ V/m	Limit @3m d μ V/m	Margin dB
18.36	Peak	24.47	11.64	36.11	69.54	-33.43
19.24	Peak	26.03	11.65	37.68	69.54	-31.86
21.84	Peak	29.69	11.16	40.85	69.54	-28.69
22.66	Peak	31.25	10.95	42.20	69.54	-27.34
24.44	Peak	37.61	10.52	48.13	69.54	-21.41
25.14	Peak	33.53	10.37	43.90	69.54	-25.64
27.12	Peak	14.82	9.94	24.76	69.54	-44.78

Unless otherwise stated the results shown in this test report refer only to the sample(s) tested and such sample(s) are retained for 90 days only.

除非另有說明，此報告結果僅對測試之樣品負責，同時此樣品僅保留90天。本報告未經本公司書面許可，不可部份複製。

This document is issued by the Company subject to its General Conditions of Service printed overleaf, available on request or accessible at www.sgs.com/terms_and_conditions.htm and, for electronic format documents, subject to Terms and Conditions for Electronic Documents at www.sgs.com/terms_e-document.htm. Attention is drawn to the limitation of liability, indemnification and jurisdiction issues defined therein. Any holder of this document is advised that information contained hereon reflects the Company's findings at the time of its intervention only and within the limits of Client's instructions, if any. The Company's sole responsibility is to its Client and this document does not exonerate parties to a transaction from exercising all their rights and obligations under the transaction documents. This document cannot be reproduced except in full, without prior written approval of the Company. Any unauthorized alteration, forgery or falsification of the content or appearance of this document is unlawful and offenders may be prosecuted to the fullest extent of the law.

SGS Taiwan Ltd. No.134, WuKungRoad, NewTaipeiIndustrialPark, WukuDistrict, NewTaipeiCity, Taiwan24803/新北市五股區新北產業園區五工路134號

台灣檢驗科技股份有限公司 t (886-2) 2299-3279

f (886-2) 2298-0488

www.tw.sgs.com

Member of SGS Group

Operation Band	:RFID	Test Date	:2018-07-18
Fundamental Frequency	:13.56 MHz	Temp./Humi.	:21 deg_C / 62 RH
Operation Mode	:Tx	Engineer	:Kane
EUT Pol.	:E2 Plane	Measurement Antenna Pol.	:HORIZONTAL

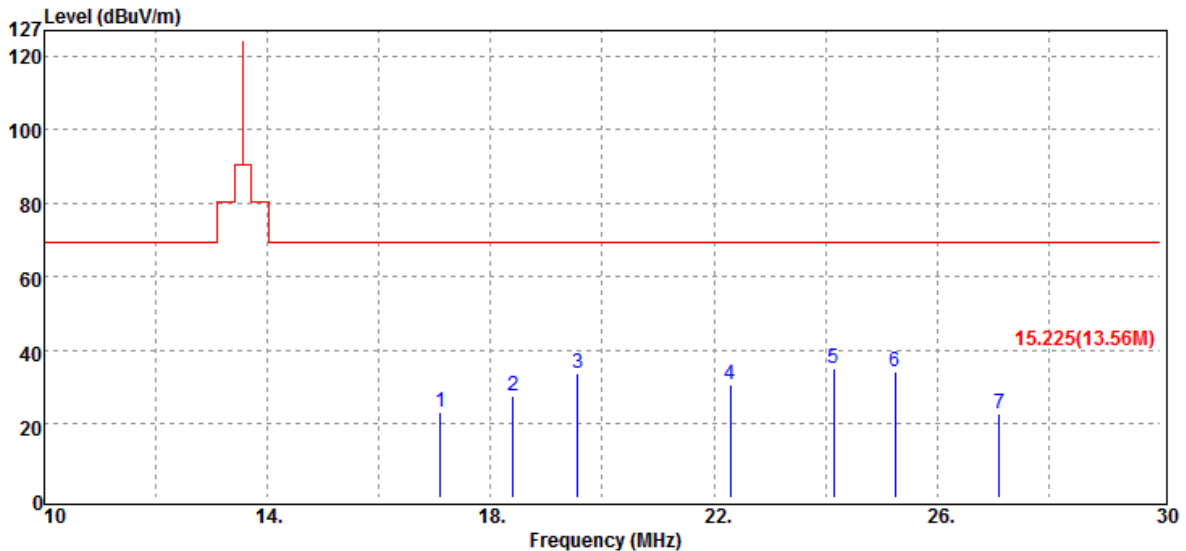

Freq. MHz	Detector Mode PK/QP/AV	Spectrum Reading Level dB μ V	Factor dB	Actual FS dB μ V/m	Limit @3m dB μ V/m	Margin dB
17.10	Peak	11.80	11.60	23.40	69.54	-46.14
18.40	Peak	16.04	11.64	27.68	69.54	-41.86
19.56	Peak	22.03	11.66	33.69	69.54	-35.85
22.30	Peak	19.85	11.04	30.89	69.54	-38.65
24.14	Peak	24.75	10.59	35.34	69.54	-34.20
25.24	Peak	24.03	10.34	34.37	69.54	-35.17
27.12	Peak	12.79	9.94	22.73	69.54	-46.81

Unless otherwise stated the results shown in this test report refer only to the sample(s) tested and such sample(s) are retained for 90 days only.

除非另有說明，此報告結果僅對測試之樣品負責，同時此樣品僅保留90天。本報告未經本公司書面許可，不可部份複製。

This document is issued by the Company subject to its General Conditions of Service printed overleaf, available on request or accessible at www.sgs.com/terms_and_conditions.htm and, for electronic format documents, subject to Terms and Conditions for Electronic Documents at www.sgs.com/terms_e-document.htm. Attention is drawn to the limitation of liability, indemnification and jurisdiction issues defined therein. Any holder of this document is advised that information contained hereon reflects the Company's findings at the time of its intervention only and within the limits of Client's instructions, if any. The Company's sole responsibility is to its Client and this document does not exonerate parties to a transaction from exercising all their rights and obligations under the transaction documents. This document cannot be reproduced except in full, without prior written approval of the Company. Any unauthorized alteration, forgery or falsification of the content or appearance of this document is unlawful and offenders may be prosecuted to the fullest extent of the law.

SGS Taiwan Ltd. No.134, WuKungRoad, NewTaipeiIndustrialPark, WukuDistrict, NewTaipeiCity, Taiwan24803/新北市五股區新北產業園區五工路134號

台灣檢驗科技股份有限公司 t (886-2) 2299-3279

f (886-2) 2298-0488

www.tw.sgs.com

Member of SGS Group

Operation Band	:RFID	Test Date	:2018-07-18
Fundamental Frequency	:13.56 MHz	Temp./Humi.	:21 deg_C / 62 RH
Operation Mode	:Tx	Engineer	:Kane
EUT Pol.	:E2 Plane	Measurement Antenna Pol.	:VERTICAL

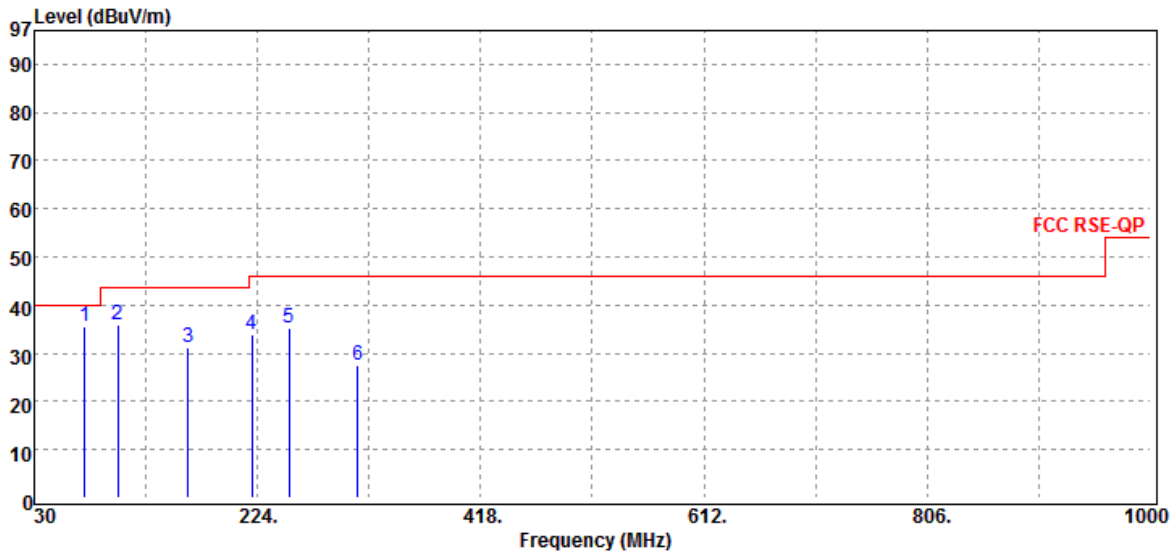

Freq. MHz	Detector Mode PK/QP/AV	Spectrum Reading Level dB μ V	Factor dB	Actual FS dB μ V/m	Limit @3m dB μ V/m	Margin dB
73.65	Peak	46.29	-10.79	35.50	40.00	-4.50
102.75	Peak	47.83	-11.98	35.85	43.50	-7.65
163.86	Peak	38.59	-7.27	31.32	43.50	-12.18
219.15	Peak	42.90	-9.08	33.82	46.00	-12.18
251.16	Peak	42.62	-7.34	35.28	46.00	-10.72
311.30	Peak	32.83	-5.25	27.58	46.00	-18.42

Unless otherwise stated the results shown in this test report refer only to the sample(s) tested and such sample(s) are retained for 90 days only.

除非另有說明，此報告結果僅對測試之樣品負責，同時此樣品僅保留90天。本報告未經本公司書面許可，不可部份複製。

This document is issued by the Company subject to its General Conditions of Service printed overleaf, available on request or accessible at www.sgs.com/terms_and_conditions.htm and, for electronic format documents, subject to Terms and Conditions for Electronic Documents at www.sgs.com/terms_e-document.htm. Attention is drawn to the limitation of liability, indemnification and jurisdiction issues defined therein. Any holder of this document is advised that information contained hereon reflects the Company's findings at the time of its intervention only and within the limits of Client's instructions, if any. The Company's sole responsibility is to its Client and this document does not exonerate parties to a transaction from exercising all their rights and obligations under the transaction documents. This document cannot be reproduced except in full, without prior written approval of the Company. Any unauthorized alteration, forgery or falsification of the content or appearance of this document is unlawful and offenders may be prosecuted to the fullest extent of the law.

SGS Taiwan Ltd. No.134, WuKungRoad, NewTaipeiIndustrialPark, WukuDistrict, NewTaipeiCity, Taiwan24803/新北市五股區新北產業園區五工路134號

台灣檢驗科技股份有限公司 t (886-2) 2299-3279

f (886-2) 2298-0488

www.tw.sgs.com

Member of SGS Group

Operation Band	:RFID	Test Date	:2018-07-18
Fundamental Frequency	:13.56 MHz	Temp./Humi.	:21 deg_C / 62 RH
Operation Mode	:Tx	Engineer	:Kane
EUT Pol.	:E2 Plane	Measurement Antenna Pol.	:HORIZONTAL

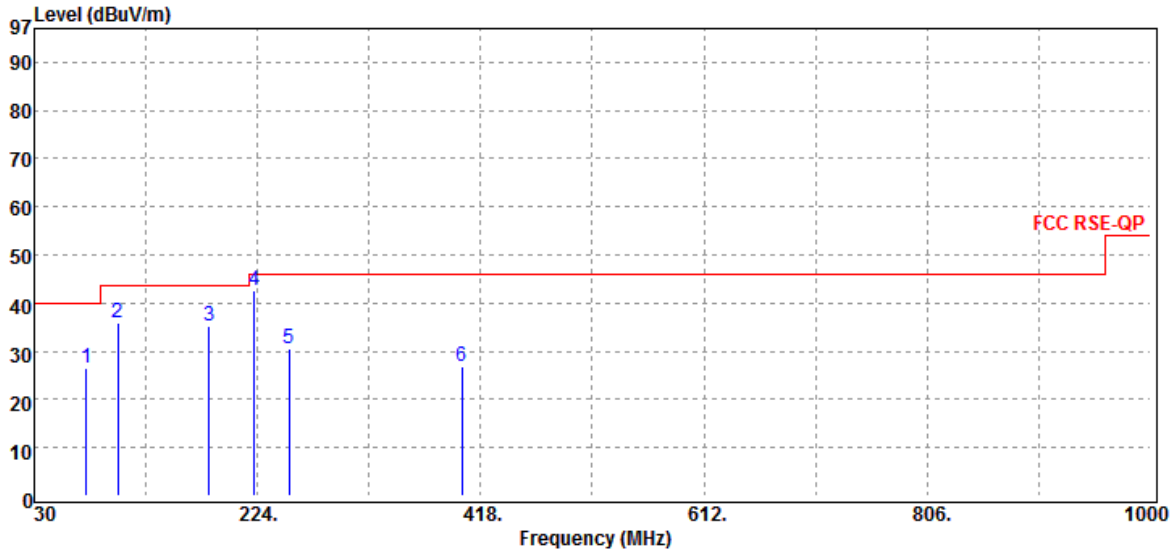

Freq. MHz	Detector Mode PK/QP/AV	Spectrum Reading Level dB μ V	Factor dB	Actual FS dB μ V/m	Limit @3m dB μ V/m	Margin dB
75.59	Peak	37.79	-11.17	26.62	40.00	-13.38
102.75	Peak	48.03	-11.98	36.05	43.50	-7.45
182.29	Peak	43.70	-8.37	35.33	43.50	-8.17
221.09	Peak	51.67	-9.01	42.66	46.00	-3.34
251.16	Peak	37.82	-7.34	30.48	46.00	-15.52
401.51	Peak	30.17	-3.27	26.90	46.00	-19.10

Unless otherwise stated the results shown in this test report refer only to the sample(s) tested and such sample(s) are retained for 90 days only.

除非另有說明，此報告結果僅對測試之樣品負責，同時此樣品僅保留90天。本報告未經本公司書面許可，不可部份複製。

This document is issued by the Company subject to its General Conditions of Service printed overleaf, available on request or accessible at www.sgs.com/terms_and_conditions.htm and, for electronic format documents, subject to Terms and Conditions for Electronic Documents at www.sgs.com/terms_e-document.htm. Attention is drawn to the limitation of liability, indemnification and jurisdiction issues defined therein. Any holder of this document is advised that information contained hereon reflects the Company's findings at the time of its intervention only and within the limits of Client's instructions, if any. The Company's sole responsibility is to its Client and this document does not exonerate parties to a transaction from exercising all their rights and obligations under the transaction documents. This document cannot be reproduced except in full, without prior written approval of the Company. Any unauthorized alteration, forgery or falsification of the content or appearance of this document is unlawful and offenders may be prosecuted to the fullest extent of the law.

SGS Taiwan Ltd. No.134, WuKungRoad, NewTaipeiIndustrialPark, WukuDistrict, NewTaipeiCity, Taiwan24803/新北市五股區新北產業園區五工路134號

台灣檢驗科技股份有限公司 t (886-2) 2299-3279

f (886-2) 2298-0488

www.tw.sgs.com

Member of SGS Group

8 FREQUENCY STABILITY

8.1 Standard Applicable

The frequency tolerance of the carrier signal shall be maintained within +/- 0.01% of the operating frequency over a temperature variation of -20 degrees to +50 degrees C at normal supply voltage, and for a variation in the primary supply voltage from 85% to 115% of the rated supply voltage at a temperature of 20 degrees C. For battery operated equipment, the equipment tests shall be performed using a new battery.

Carrier frequency stability shall be maintained to $\pm 0.01\%$ (± 100 ppm).

For licence-exempt radio apparatus, the frequency stability shall be measured at temperatures of -20°C (-4°F), +20°C (+68°F) and +50°C (+122°F).

8.2 Measurement Procedure

1. The EUT was placed inside temperature chamber and powered and powered by nominal DC voltage.
2. Set EUT as normal operation.
3. Turn the EUT on and couple its output to spectrum.
4. Turn the EUT off and set the chamber to the highest temperature specified.
5. Allow sufficient time (approximately 30 min) for the temperature of the chamber to stabilize, turn the EUT and measure the operating frequency.
6. Repeat step with the temperature chamber set to the lowest temperature.
7. Set spectrum Center Frequency = fundamental frequency, RBW, VBW= 10 kHz, Span =100 kHz, Detector =Max hold, Mark peak.

8.3 Test SET-UP

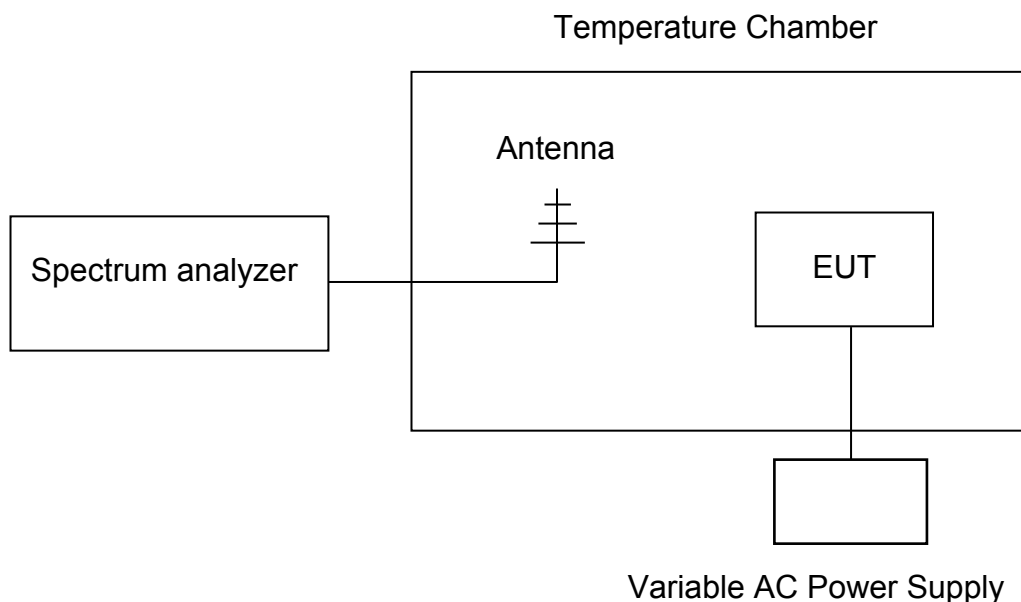

Unless otherwise stated the results shown in this test report refer only to the sample(s) tested and such sample(s) are retained for 90 days only.

除非另有說明，此報告結果僅對測試之樣品負責，同時此樣品僅保留90天。本報告未經本公司書面許可，不可部份複製。

This document is issued by the Company subject to its General Conditions of Service printed overleaf, available on request or accessible at www.sgs.com/terms_and_conditions.htm and, for electronic format documents, subject to Terms and Conditions for Electronic Documents at www.sgs.com/terms_e-document.htm. Attention is drawn to the limitation of liability, indemnification and jurisdiction issues defined therein. Any holder of this document is advised that information contained hereon reflects the Company's findings at the time of its intervention only and within the limits of Client's instructions, if any. The Company's sole responsibility is to its Client and this document does not exonerate parties to a transaction from exercising all their rights and obligations under the transaction documents. This document cannot be reproduced except in full, without prior written approval of the Company. Any unauthorized alteration, forgery or falsification of the content or appearance of this document is unlawful and offenders may be prosecuted to the fullest extent of the law.

SGS Taiwan Ltd. No.134, WuKungRoad, NewTaipeiIndustrialPark, WukuDistrict, NewTaipeiCity, Taiwan24803/新北市五股區新北產業園區五工路134號

台灣檢驗科技股份有限公司 t (886-2) 2299-3279

f (886-2) 2298-0488

www.tw.sgs.com

Member of SGS Group

8.4 Measurement Equipment Used

EQUIPMENT TYPE	MFR	MODEL NUMBER	SERIAL NUMBER	LAST CAL.	CAL DUE.
Loop Antenna	ETS.LINDGREN	6502	148045	09/26/2017	09/25/2018
EXA Spectrum Analyzer	Agilent	N9010A	MY57120290	02/14/208	02/13/2019
Coaxial Cables	N/A	WK CE Cable	N/A	01/02/2018	01/01/2019

8.5 Measurement Results:

NFC_Test mode_1

Startup:

A. Temperature Variation

Power Supply	Environment	Frequency	Delta (Hz)	Limit (KHz)
Vdc	Temperature (°C)	(MHz)		
120	-20	13.560026	-24.00000	+/- 1.356
120	-10	13.560041	-39.00000	+/- 1.356
120	0	13.559966	36.00000	+/- 1.356
120	10	13.559973	29.00000	+/- 1.356
120	20	13.560002	0.00000	+/- 1.356
120	30	13.560078	-76.00000	+/- 1.356
120	40	13.559996	42.00000	+/- 1.356
120	50	13.559942	60.00000	+/- 1.356

B. Supply Voltage Variation

Power Supply	Environment	Frequency	Delta (Hz)	Limit (KHz)
Vdc	Temperature (°C)	(MHz)		
132	20	13.559997	5.30000	+/- 1.356
120	20	13.560002	0.00000	+/- 1.356
108	20	13.559974	27.60000	+/- 1.356

Unless otherwise stated the results shown in this test report refer only to the sample(s) tested and such sample(s) are retained for 90 days only.

除非另有說明，此報告結果僅對測試之樣品負責，同時此樣品僅保留90天。本報告未經本公司書面許可，不可部份複製。

This document is issued by the Company subject to its General Conditions of Service printed overleaf, available on request or accessible at www.sgs.com/terms_and_conditions.htm and, for electronic format documents, subject to Terms and Conditions for Electronic Documents at www.sgs.com/terms_e-document.htm. Attention is drawn to the limitation of liability, indemnification and jurisdiction issues defined therein. Any holder of this document is advised that information contained hereon reflects the Company's findings at the time of its intervention only and within the limits of Client's instructions, if any. The Company's sole responsibility is to its Client and this document does not exonerate parties to a transaction from exercising all their rights and obligations under the transaction documents. This document cannot be reproduced except in full, without prior written approval of the Company. Any unauthorized alteration, forgery or falsification of the content or appearance of this document is unlawful and offenders may be prosecuted to the fullest extent of the law.

2 minutes:

A. Temperature Variation

Power Supply	Environment	Frequency	Delta (Hz)	Limit (KHz)
Vdc	Temperature (°C)	(MHz)		
120	-20	13.56006	-97.00000	+/- 1.356
120	-10	13.559976	-13.00000	+/- 1.356
120	0	13.560007	-44.00000	+/- 1.356
120	10	13.559912	51.00000	+/- 1.356
120	20	13.559963	0.00000	+/- 1.356
120	30	13.559901	62.00000	+/- 1.356
120	40	13.55994	23.00000	+/- 1.356
120	50	13.559929	34.00000	+/- 1.356

B. Supply Voltage Variation

Power Supply	Environment	Frequency	Delta (Hz)	Limit (KHz)
Vdc	Temperature (°C)	(MHz)		
132	20	13.559973	29.30000	+/- 1.356
120	20	13.560002	0.00000	+/- 1.356
108	20	13.559981	20.70000	+/- 1.356

Unless otherwise stated the results shown in this test report refer only to the sample(s) tested and such sample(s) are retained for 90 days only.

除非另有說明，此報告結果僅對測試之樣品負責，同時此樣品僅保留90天。本報告未經本公司書面許可，不可部份複製。

This document is issued by the Company subject to its General Conditions of Service printed overleaf, available on request or accessible at www.sgs.com/terms_and_conditions.htm and, for electronic format documents, subject to Terms and Conditions for Electronic Documents at www.sgs.com/terms_e-document.htm. Attention is drawn to the limitation of liability, indemnification and jurisdiction issues defined therein. Any holder of this document is advised that information contained hereon reflects the Company's findings at the time of its intervention only and within the limits of Client's instructions, if any. The Company's sole responsibility is to its Client and this document does not exonerate parties to a transaction from exercising all their rights and obligations under the transaction documents. This document cannot be reproduced except in full, without prior written approval of the Company. Any unauthorized alteration, forgery or falsification of the content or appearance of this document is unlawful and offenders may be prosecuted to the fullest extent of the law.

SGS Taiwan Ltd. No.134, WuKungRoad, NewTaipeiIndustrialPark, WukuDistrict, NewTaipeiCity, Taiwan24803/新北市五股區新北產業園區五工路134號

台灣檢驗科技股份有限公司 t (886-2) 2299-3279

f (886-2) 2298-0488

www.tw.sgs.com

Member of SGS Group

5 minutes:

A. Temperature Variation

Power Supply	Environment	Frequency	Delta (Hz)	Limit (KHz)
Vdc	Temperature (°C)	(MHz)		
120	-20	13.560045	16.00000	+/- 1.356
120	-10	13.559992	69.00000	+/- 1.356
120	0	13.560088	-27.00000	+/- 1.356
120	10	13.56003	31.00000	+/- 1.356
120	20	13.560061	0.00000	+/- 1.356
120	30	13.560035	26.00000	+/- 1.356
120	40	13.560001	60.00000	+/- 1.356
120	50	13.559955	106.00000	+/- 1.356

B. Supply Voltage Variation

Power Supply	Environment	Frequency	Delta (Hz)	Limit (KHz)
Vdc	Temperature (°C)	(MHz)		
132	20	13.559984	17.80000	+/- 1.356
120	20	13.560002	0.00000	+/- 1.356
108	20	13.559985	17.10000	+/- 1.356

Unless otherwise stated the results shown in this test report refer only to the sample(s) tested and such sample(s) are retained for 90 days only.

除非另有說明，此報告結果僅對測試之樣品負責，同時此樣品僅保留90天。本報告未經本公司書面許可，不可部份複製。

This document is issued by the Company subject to its General Conditions of Service printed overleaf, available on request or accessible at www.sgs.com/terms_and_conditions.htm and, for electronic format documents, subject to Terms and Conditions for Electronic Documents at www.sgs.com/terms_e-document.htm. Attention is drawn to the limitation of liability, indemnification and jurisdiction issues defined therein. Any holder of this document is advised that information contained hereon reflects the Company's findings at the time of its intervention only and within the limits of Client's instructions, if any. The Company's sole responsibility is to its Client and this document does not exonerate parties to a transaction from exercising all their rights and obligations under the transaction documents. This document cannot be reproduced except in full, without prior written approval of the Company. Any unauthorized alteration, forgery or falsification of the content or appearance of this document is unlawful and offenders may be prosecuted to the fullest extent of the law.

SGS Taiwan Ltd. No.134, WuKungRoad, NewTaipeiIndustrialPark, WukuDistrict, NewTaipeiCity, Taiwan24803/新北市五股區新北產業園區五工路134號

台灣檢驗科技股份有限公司 t (886-2) 2299-3279

f (886-2) 2298-0488

www.tw.sgs.com

Member of SGS Group

10 minutes:

A. Temperature Variation

Power Supply	Environment	Frequency	Delta (Hz)	Limit (KHz)
Vdc	Temperature (°C)	(MHz)		
120	-20	13.560093	-70.00000	+/- 1.356
120	-10	13.560089	-66.00000	+/- 1.356
120	0	13.559983	40.00000	+/- 1.356
120	10	13.560098	-75.00000	+/- 1.356
120	20	13.560023	0.00000	+/- 1.356
120	30	13.56001	13.00000	+/- 1.356
120	40	13.559905	118.00000	+/- 1.356
120	50	13.559934	89.00000	+/- 1.356

B. Supply Voltage Variation

Power Supply	Environment	Frequency	Delta (Hz)	Limit (KHz)
Vdc	Temperature (°C)	(MHz)		
132	20	13.560012	-10.10000	+/- 1.356
120	20	13.560002	0.00000	+/- 1.356
108	20	13.560008	-5.80000	+/- 1.356

Unless otherwise stated the results shown in this test report refer only to the sample(s) tested and such sample(s) are retained for 90 days only.

除非另有說明，此報告結果僅對測試之樣品負責，同時此樣品僅保留90天。本報告未經本公司書面許可，不可部份複製。

This document is issued by the Company subject to its General Conditions of Service printed overleaf, available on request or accessible at www.sgs.com/terms_and_conditions.htm and, for electronic format documents, subject to Terms and Conditions for Electronic Documents at www.sgs.com/terms_e-document.htm. Attention is drawn to the limitation of liability, indemnification and jurisdiction issues defined therein. Any holder of this document is advised that information contained hereon reflects the Company's findings at the time of its intervention only and within the limits of Client's instructions, if any. The Company's sole responsibility is to its Client and this document does not exonerate parties to a transaction from exercising all their rights and obligations under the transaction documents. This document cannot be reproduced except in full, without prior written approval of the Company. Any unauthorized alteration, forgery or falsification of the content or appearance of this document is unlawful and offenders may be prosecuted to the fullest extent of the law.

SGS Taiwan Ltd. No.134, WuKungRoad, NewTaipeiIndustrialPark, WukuDistrict, NewTaipeiCity, Taiwan24803/新北市五股區新北產業園區五工路134號

台灣檢驗科技股份有限公司 t (886-2) 2299-3279

f (886-2) 2298-0488

www.tw.sgs.com

Member of SGS Group

RFID_Test mode_1

Startup:

A. Temperature Variation

Power Supply	Environment	Frequency	Delta (Hz)	Limit (KHz)
Vdc	Temperature (°C)	(MHz)		
120	-20	13.559994	2.40000	+/- 1.356
120	-10	13.559992	4.10000	+/- 1.356
120	0	13.559994	1.70000	+/- 1.356
120	10	13.560008	-11.80000	+/- 1.356
120	20	13.559996	0.00000	+/- 1.356
120	30	13.560003	-7.10000	+/- 1.356
120	40	13.560005	-9.10000	+/- 1.356
120	50	13.559997	-1.40000	+/- 1.356

B. Supply Voltage Variation

Power Supply	Environment	Frequency	Delta (Hz)	Limit (KHz)
Vdc	Temperature (°C)	(MHz)		
132	20	13.559994	1.80000	+/- 1.356
120	20	13.559996	0.00000	+/- 1.356
108	20	13.559995	1.40000	+/- 1.356

Unless otherwise stated the results shown in this test report refer only to the sample(s) tested and such sample(s) are retained for 90 days only.

除非另有說明，此報告結果僅對測試之樣品負責，同時此樣品僅保留90天。本報告未經本公司書面許可，不可部份複製。

This document is issued by the Company subject to its General Conditions of Service printed overleaf, available on request or accessible at www.sgs.com/terms_and_conditions.htm and, for electronic format documents, subject to Terms and Conditions for Electronic Documents at www.sgs.com/terms_e-document.htm. Attention is drawn to the limitation of liability, indemnification and jurisdiction issues defined therein. Any holder of this document is advised that information contained hereon reflects the Company's findings at the time of its intervention only and within the limits of Client's instructions, if any. The Company's sole responsibility is to its Client and this document does not exonerate parties to a transaction from exercising all their rights and obligations under the transaction documents. This document cannot be reproduced except in full, without prior written approval of the Company. Any unauthorized alteration, forgery or falsification of the content or appearance of this document is unlawful and offenders may be prosecuted to the fullest extent of the law.

SGS Taiwan Ltd. No.134, WuKungRoad, NewTaipeiIndustrialPark, WukuDistrict, NewTaipeiCity, Taiwan24803/新北市五股區新北產業園區五工路134號

台灣檢驗科技股份有限公司 t (886-2) 2299-3279

f (886-2) 2298-0488

www.tw.sgs.com

Member of SGS Group

2 minutes:

A. Temperature Variation

Power Supply	Environment	Frequency	Delta (Hz)	Limit (KHz)
Vdc	Temperature (°C)	(MHz)		
120	-20	13.559994	15.40000	+/- 1.356
120	-10	13.56	9.60000	+/- 1.356
120	0	13.559992	17.10000	+/- 1.356
120	10	13.559999	10.20000	+/- 1.356
120	20	13.560009	0.00000	+/- 1.356
120	30	13.559993	16.10000	+/- 1.356
120	40	13.560003	6.40000	+/- 1.356
120	50	13.560005	4.30000	+/- 1.356

B. Supply Voltage Variation

Power Supply	Environment	Frequency	Delta (Hz)	Limit (KHz)
Vdc	Temperature (°C)	(MHz)		
132	20	13.559993	3.30000	+/- 1.356
120	20	13.559996	0.00000	+/- 1.356
108	20	13.559999	-3.20000	+/- 1.356

Unless otherwise stated the results shown in this test report refer only to the sample(s) tested and such sample(s) are retained for 90 days only.

除非另有說明，此報告結果僅對測試之樣品負責，同時此樣品僅保留90天。本報告未經本公司書面許可，不可部份複製。

This document is issued by the Company subject to its General Conditions of Service printed overleaf, available on request or accessible at www.sgs.com/terms_and_conditions.htm and, for electronic format documents, subject to Terms and Conditions for Electronic Documents at www.sgs.com/terms_e-document.htm. Attention is drawn to the limitation of liability, indemnification and jurisdiction issues defined therein. Any holder of this document is advised that information contained hereon reflects the Company's findings at the time of its intervention only and within the limits of Client's instructions, if any. The Company's sole responsibility is to its Client and this document does not exonerate parties to a transaction from exercising all their rights and obligations under the transaction documents. This document cannot be reproduced except in full, without prior written approval of the Company. Any unauthorized alteration, forgery or falsification of the content or appearance of this document is unlawful and offenders may be prosecuted to the fullest extent of the law.

SGS Taiwan Ltd. No.134, WuKungRoad, NewTaipeiIndustrialPark, WukuDistrict, NewTaipeiCity, Taiwan24803/新北市五股區新北產業園區五工路134號

台灣檢驗科技股份有限公司 t (886-2) 2299-3279

f (886-2) 2298-0488

www.tw.sgs.com

Member of SGS Group

5 minutes:

A. Temperature Variation

Power Supply	Environment	Frequency	Delta (Hz)	Limit (KHz)
Vdc	Temperature (°C)	(MHz)		
120	-20	13.559998	12.10000	+/- 1.356
120	-10	13.559996	13.50000	+/- 1.356
120	0	13.559994	15.90000	+/- 1.356
120	10	13.560001	8.60000	+/- 1.356
120	20	13.56001	0.00000	+/- 1.356
120	30	13.559995	14.50000	+/- 1.356
120	40	13.56	10.00000	+/- 1.356
120	50	13.560007	2.80000	+/- 1.356

B. Supply Voltage Variation

Power Supply	Environment	Frequency	Delta (Hz)	Limit (KHz)
Vdc	Temperature (°C)	(MHz)		
132	20	13.559998	-1.50000	+/- 1.356
120	20	13.559996	0.00000	+/- 1.356
108	20	13.559997	-1.30000	+/- 1.356

Unless otherwise stated the results shown in this test report refer only to the sample(s) tested and such sample(s) are retained for 90 days only.

除非另有說明，此報告結果僅對測試之樣品負責，同時此樣品僅保留90天。本報告未經本公司書面許可，不可部份複製。

This document is issued by the Company subject to its General Conditions of Service printed overleaf, available on request or accessible at www.sgs.com/terms_and_conditions.htm and, for electronic format documents, subject to Terms and Conditions for Electronic Documents at www.sgs.com/terms_e-document.htm. Attention is drawn to the limitation of liability, indemnification and jurisdiction issues defined therein. Any holder of this document is advised that information contained hereon reflects the Company's findings at the time of its intervention only and within the limits of Client's instructions, if any. The Company's sole responsibility is to its Client and this document does not exonerate parties to a transaction from exercising all their rights and obligations under the transaction documents. This document cannot be reproduced except in full, without prior written approval of the Company. Any unauthorized alteration, forgery or falsification of the content or appearance of this document is unlawful and offenders may be prosecuted to the fullest extent of the law.

SGS Taiwan Ltd. No.134, WuKungRoad, NewTaipeiIndustrialPark, WukuDistrict, NewTaipeiCity, Taiwan24803/新北市五股區新北產業園區五工路134號

台灣檢驗科技股份有限公司 t (886-2) 2299-3279

f (886-2) 2298-0488

www.tw.sgs.com

Member of SGS Group

10 minutes:

A. Temperature Variation

Power Supply	Environment	Frequency	Delta (Hz)	Limit (KHz)
Vdc	Temperature (°C)	(MHz)		
120	-20	13.559995	5.90000	+/- 1.356
120	-10	13.560007	-6.00000	+/- 1.356
120	0	13.560004	-3.40000	+/- 1.356
120	10	13.559995	6.10000	+/- 1.356
120	20	13.560001	0.00000	+/- 1.356
120	30	13.560003	-1.60000	+/- 1.356
120	40	13.560002	-1.40000	+/- 1.356
120	50	13.559998	2.60000	+/- 1.356

B. Supply Voltage Variation

Power Supply	Environment	Frequency	Delta (Hz)	Limit (KHz)
Vdc	Temperature (°C)	(MHz)		
132	20	13.560002	-6.40000	+/- 1.356
120	20	13.559996	0.00000	+/- 1.356
108	20	13.560009	-12.90000	+/- 1.356

Unless otherwise stated the results shown in this test report refer only to the sample(s) tested and such sample(s) are retained for 90 days only.

除非另有說明，此報告結果僅對測試之樣品負責，同時此樣品僅保留90天。本報告未經本公司書面許可，不可部份複製。

This document is issued by the Company subject to its General Conditions of Service printed overleaf, available on request or accessible at www.sgs.com/terms_and_conditions.htm and, for electronic format documents, subject to Terms and Conditions for Electronic Documents at www.sgs.com/terms_e-document.htm. Attention is drawn to the limitation of liability, indemnification and jurisdiction issues defined therein. Any holder of this document is advised that information contained hereon reflects the Company's findings at the time of its intervention only and within the limits of Client's instructions, if any. The Company's sole responsibility is to its Client and this document does not exonerate parties to a transaction from exercising all their rights and obligations under the transaction documents. This document cannot be reproduced except in full, without prior written approval of the Company. Any unauthorized alteration, forgery or falsification of the content or appearance of this document is unlawful and offenders may be prosecuted to the fullest extent of the law.

SGS Taiwan Ltd. No.134, WuKungRoad, NewTaipeiIndustrialPark, WukuDistrict, NewTaipeiCity, Taiwan24803/新北市五股區新北產業園區五工路134號

台灣檢驗科技股份有限公司 t (886-2) 2299-3279

f (886-2) 2298-0488

www.tw.sgs.com

Member of SGS Group

NFC_Test mode_2

Startup:

A. Temperature Variation

Power Supply	Environment	Frequency	Delta (Hz)	Limit (KHz)
Vdc	Temperature (°C)	(MHz)		
120	-20	13.559918	169.00000	+/- 1.356
120	-10	13.560049	38.00000	+/- 1.356
120	0	13.559917	170.00000	+/- 1.356
120	10	13.560068	19.00000	+/- 1.356
120	20	13.560087	0.00000	+/- 1.356
120	30	13.559974	113.00000	+/- 1.356
120	40	13.560074	13.00000	+/- 1.356
120	50	13.560017	70.00000	+/- 1.356

B. Supply Voltage Variation

Power Supply	Environment	Frequency	Delta (Hz)	Limit (KHz)
Vdc	Temperature (°C)	(MHz)		
132	20	13.560002	84.60000	+/- 1.356
120	20	13.560087	0.00000	+/- 1.356
108	20	13.559998	88.60000	+/- 1.356

Unless otherwise stated the results shown in this test report refer only to the sample(s) tested and such sample(s) are retained for 90 days only.

除非另有說明，此報告結果僅對測試之樣品負責，同時此樣品僅保留90天。本報告未經本公司書面許可，不可部份複製。

This document is issued by the Company subject to its General Conditions of Service printed overleaf, available on request or accessible at www.sgs.com/terms_and_conditions.htm and, for electronic format documents, subject to Terms and Conditions for Electronic Documents at www.sgs.com/terms_e-document.htm. Attention is drawn to the limitation of liability, indemnification and jurisdiction issues defined therein. Any holder of this document is advised that information contained hereon reflects the Company's findings at the time of its intervention only and within the limits of Client's instructions, if any. The Company's sole responsibility is to its Client and this document does not exonerate parties to a transaction from exercising all their rights and obligations under the transaction documents. This document cannot be reproduced except in full, without prior written approval of the Company. Any unauthorized alteration, forgery or falsification of the content or appearance of this document is unlawful and offenders may be prosecuted to the fullest extent of the law.

SGS Taiwan Ltd. No.134, WuKungRoad, NewTaipeiIndustrialPark, WukuDistrict, NewTaipeiCity, Taiwan24803/新北市五股區新北產業園區五工路134號

台灣檢驗科技股份有限公司 t (886-2) 2299-3279

f (886-2) 2298-0488

www.tw.sgs.com

Member of SGS Group

2 minutes:

A. Temperature Variation

Power Supply	Environment	Frequency	Delta (Hz)	Limit (KHz)
Vdc	Temperature (°C)	(MHz)		
120	-20	13.559914	94.00000	+/- 1.356
120	-10	13.559906	102.00000	+/- 1.356
120	0	13.559907	101.00000	+/- 1.356
120	10	13.559931	77.00000	+/- 1.356
120	20	13.560008	0.00000	+/- 1.356
120	30	13.559985	23.00000	+/- 1.356
120	40	13.559975	33.00000	+/- 1.356
120	50	13.560082	-74.00000	+/- 1.356

B. Supply Voltage Variation

Power Supply	Environment	Frequency	Delta (Hz)	Limit (KHz)
Vdc	Temperature (°C)	(MHz)		
132	20	13.559998	89.30000	+/- 1.356
120	20	13.560087	0.00000	+/- 1.356
108	20	13.559992	95.20000	+/- 1.356

Unless otherwise stated the results shown in this test report refer only to the sample(s) tested and such sample(s) are retained for 90 days only.

除非另有說明，此報告結果僅對測試之樣品負責，同時此樣品僅保留90天。本報告未經本公司書面許可，不可部份複製。

This document is issued by the Company subject to its General Conditions of Service printed overleaf, available on request or accessible at www.sgs.com/terms_and_conditions.htm and, for electronic format documents, subject to Terms and Conditions for Electronic Documents at www.sgs.com/terms_e-document.htm. Attention is drawn to the limitation of liability, indemnification and jurisdiction issues defined therein. Any holder of this document is advised that information contained hereon reflects the Company's findings at the time of its intervention only and within the limits of Client's instructions, if any. The Company's sole responsibility is to its Client and this document does not exonerate parties to a transaction from exercising all their rights and obligations under the transaction documents. This document cannot be reproduced except in full, without prior written approval of the Company. Any unauthorized alteration, forgery or falsification of the content or appearance of this document is unlawful and offenders may be prosecuted to the fullest extent of the law.

SGS Taiwan Ltd. No.134, WuKungRoad, NewTaipeiIndustrialPark, WukuDistrict, NewTaipeiCity, Taiwan24803/新北市五股區新北產業園區五工路134號

台灣檢驗科技股份有限公司 t (886-2) 2299-3279

f (886-2) 2298-0488

www.tw.sgs.com

Member of SGS Group

5 minutes:

A. Temperature Variation

Power Supply	Environment	Frequency	Delta (Hz)	Limit (KHz)
Vdc	Temperature (°C)	(MHz)		
120	-20	13.559918	173.00000	+/- 1.356
120	-10	13.560073	18.00000	+/- 1.356
120	0	13.559995	96.00000	+/- 1.356
120	10	13.560082	9.00000	+/- 1.356
120	20	13.560091	0.00000	+/- 1.356
120	30	13.560072	19.00000	+/- 1.356
120	40	13.56009	1.00000	+/- 1.356
120	50	13.560022	69.00000	+/- 1.356

B. Supply Voltage Variation

Power Supply	Environment	Frequency	Delta (Hz)	Limit (KHz)
Vdc	Temperature (°C)	(MHz)		
132	20	13.560005	81.60000	+/- 1.356
120	20	13.560087	0.00000	+/- 1.356
108	20	13.560006	80.80000	+/- 1.356

Unless otherwise stated the results shown in this test report refer only to the sample(s) tested and such sample(s) are retained for 90 days only.

除非另有說明，此報告結果僅對測試之樣品負責，同時此樣品僅保留90天。本報告未經本公司書面許可，不可部份複製。

This document is issued by the Company subject to its General Conditions of Service printed overleaf, available on request or accessible at www.sgs.com/terms_and_conditions.htm and, for electronic format documents, subject to Terms and Conditions for Electronic Documents at www.sgs.com/terms_e-document.htm. Attention is drawn to the limitation of liability, indemnification and jurisdiction issues defined therein. Any holder of this document is advised that information contained hereon reflects the Company's findings at the time of its intervention only and within the limits of Client's instructions, if any. The Company's sole responsibility is to its Client and this document does not exonerate parties to a transaction from exercising all their rights and obligations under the transaction documents. This document cannot be reproduced except in full, without prior written approval of the Company. Any unauthorized alteration, forgery or falsification of the content or appearance of this document is unlawful and offenders may be prosecuted to the fullest extent of the law.

SGS Taiwan Ltd. No.134, WuKungRoad, NewTaipeiIndustrialPark, WukuDistrict, NewTaipeiCity, Taiwan24803/新北市五股區新北產業園區五工路134號

台灣檢驗科技股份有限公司 t (886-2) 2299-3279

f (886-2) 2298-0488

www.tw.sgs.com

Member of SGS Group

10 minutes:

A. Temperature Variation

Power Supply	Environment	Frequency	Delta (Hz)	Limit (KHz)
Vdc	Temperature (°C)	(MHz)		
120	-20	13.560091	-123.00000	+/- 1.356
120	-10	13.56006	-92.00000	+/- 1.356
120	0	13.560005	-37.00000	+/- 1.356
120	10	13.56001	-42.00000	+/- 1.356
120	20	13.559968	0.00000	+/- 1.356
120	30	13.559945	23.00000	+/- 1.356
120	40	13.559945	23.00000	+/- 1.356
120	50	13.560065	-97.00000	+/- 1.356

B. Supply Voltage Variation

Power Supply	Environment	Frequency	Delta (Hz)	Limit (KHz)
Vdc	Temperature (°C)	(MHz)		
132	20	13.560005	81.90000	+/- 1.356
120	20	13.560087	0.00000	+/- 1.356
108	20	13.559998	88.60000	+/- 1.356

Unless otherwise stated the results shown in this test report refer only to the sample(s) tested and such sample(s) are retained for 90 days only.

除非另有說明，此報告結果僅對測試之樣品負責，同時此樣品僅保留90天。本報告未經本公司書面許可，不可部份複製。

This document is issued by the Company subject to its General Conditions of Service printed overleaf, available on request or accessible at www.sgs.com/terms_and_conditions.htm and, for electronic format documents, subject to Terms and Conditions for Electronic Documents at www.sgs.com/terms_e-document.htm. Attention is drawn to the limitation of liability, indemnification and jurisdiction issues defined therein. Any holder of this document is advised that information contained hereon reflects the Company's findings at the time of its intervention only and within the limits of Client's instructions, if any. The Company's sole responsibility is to its Client and this document does not exonerate parties to a transaction from exercising all their rights and obligations under the transaction documents. This document cannot be reproduced except in full, without prior written approval of the Company. Any unauthorized alteration, forgery or falsification of the content or appearance of this document is unlawful and offenders may be prosecuted to the fullest extent of the law.

SGS Taiwan Ltd. No.134, WuKungRoad, NewTaipeiIndustrialPark, WukuDistrict, NewTaipeiCity, Taiwan24803/新北市五股區新北產業園區五工路134號

台灣檢驗科技股份有限公司 t (886-2) 2299-3279

f (886-2) 2298-0488

www.tw.sgs.com

Member of SGS Group

RFID_Test mode_2

Startup:

A. Temperature Variation

Power Supply	Environment	Frequency	Delta (Hz)	Limit (KHz)
Vdc	Temperature (°C)	(MHz)		
120	-20	13.560002	-9.60000	+/- 1.356
120	-10	13.560007	-14.30000	+/- 1.356
120	0	13.559994	-1.10000	+/- 1.356
120	10	13.559998	-5.10000	+/- 1.356
120	20	13.559993	0.00000	+/- 1.356
120	30	13.560003	-10.00000	+/- 1.356
120	40	13.560001	-8.40000	+/- 1.356
120	50	13.559995	-2.50000	+/- 1.356

B. Supply Voltage Variation

Power Supply	Environment	Frequency	Delta (Hz)	Limit (KHz)
Vdc	Temperature (°C)	(MHz)		
132	20	13.560003	-10.02200	+/- 1.356
120	20	13.559993	0.00000	+/- 1.356
108	20	13.56	-7.39000	+/- 1.356

Unless otherwise stated the results shown in this test report refer only to the sample(s) tested and such sample(s) are retained for 90 days only.

除非另有說明，此報告結果僅對測試之樣品負責，同時此樣品僅保留90天。本報告未經本公司書面許可，不可部份複製。

This document is issued by the Company subject to its General Conditions of Service printed overleaf, available on request or accessible at www.sgs.com/terms_and_conditions.htm and, for electronic format documents, subject to Terms and Conditions for Electronic Documents at www.sgs.com/terms_e-document.htm. Attention is drawn to the limitation of liability, indemnification and jurisdiction issues defined therein. Any holder of this document is advised that information contained hereon reflects the Company's findings at the time of its intervention only and within the limits of Client's instructions, if any. The Company's sole responsibility is to its Client and this document does not exonerate parties to a transaction from exercising all their rights and obligations under the transaction documents. This document cannot be reproduced except in full, without prior written approval of the Company. Any unauthorized alteration, forgery or falsification of the content or appearance of this document is unlawful and offenders may be prosecuted to the fullest extent of the law.

SGS Taiwan Ltd. No.134, WuKungRoad, NewTaipeiIndustrialPark, WukuDistrict, NewTaipeiCity, Taiwan24803/新北市五股區新北產業園區五工路134號

台灣檢驗科技股份有限公司 t (886-2) 2299-3279

f (886-2) 2298-0488

www.tw.sgs.com

Member of SGS Group

2 minutes:

A. Temperature Variation

Power Supply	Environment	Frequency	Delta (Hz)	Limit (KHz)
Vdc	Temperature (°C)	(MHz)		
120	-20	13.559994	5.50000	+/- 1.356
120	-10	13.560003	-3.10000	+/- 1.356
120	0	13.560004	-4.20000	+/- 1.356
120	10	13.559995	4.60000	+/- 1.356
120	20	13.56	0.00000	+/- 1.356
120	30	13.559995	4.60000	+/- 1.356
120	40	13.559991	9.00000	+/- 1.356
120	50	13.559998	1.60000	+/- 1.356

B. Supply Voltage Variation

Power Supply	Environment	Frequency	Delta (Hz)	Limit (KHz)
Vdc	Temperature (°C)	(MHz)		
132	20	13.559998	-5.70000	+/- 1.356
120	20	13.559993	0.00000	+/- 1.356
108	20	13.559991	1.50000	+/- 1.356

Unless otherwise stated the results shown in this test report refer only to the sample(s) tested and such sample(s) are retained for 90 days only.

除非另有說明，此報告結果僅對測試之樣品負責，同時此樣品僅保留90天。本報告未經本公司書面許可，不可部份複製。

This document is issued by the Company subject to its General Conditions of Service printed overleaf, available on request or accessible at www.sgs.com/terms_and_conditions.htm and, for electronic format documents, subject to Terms and Conditions for Electronic Documents at www.sgs.com/terms_e-document.htm. Attention is drawn to the limitation of liability, indemnification and jurisdiction issues defined therein. Any holder of this document is advised that information contained hereon reflects the Company's findings at the time of its intervention only and within the limits of Client's instructions, if any. The Company's sole responsibility is to its Client and this document does not exonerate parties to a transaction from exercising all their rights and obligations under the transaction documents. This document cannot be reproduced except in full, without prior written approval of the Company. Any unauthorized alteration, forgery or falsification of the content or appearance of this document is unlawful and offenders may be prosecuted to the fullest extent of the law.

SGS Taiwan Ltd. No.134, WuKungRoad, NewTaipeiIndustrialPark, WukuDistrict, NewTaipeiCity, Taiwan24803/新北市五股區新北產業園區五工路134號

台灣檢驗科技股份有限公司 t (886-2) 2299-3279

f (886-2) 2298-0488

www.tw.sgs.com

Member of SGS Group

5 minutes:

A. Temperature Variation

Power Supply	Environment	Frequency	Delta (Hz)	Limit (KHz)
Vdc	Temperature (°C)	(MHz)		
120	-20	13.560006	-5.10000	+/- 1.356
120	-10	13.560007	-5.50000	+/- 1.356
120	0	13.559999	2.30000	+/- 1.356
120	10	13.559995	5.80000	+/- 1.356
120	20	13.560001	0.00000	+/- 1.356
120	30	13.559993	8.40000	+/- 1.356
120	40	13.559995	5.90000	+/- 1.356
120	50	13.560007	-6.10000	+/- 1.356

B. Supply Voltage Variation

Power Supply	Environment	Frequency	Delta (Hz)	Limit (KHz)
Vdc	Temperature (°C)	(MHz)		
132	20	13.560006	-13.50000	+/- 1.356
120	20	13.559993	0.00000	+/- 1.356
108	20	13.560007	-14.10000	+/- 1.356

Unless otherwise stated the results shown in this test report refer only to the sample(s) tested and such sample(s) are retained for 90 days only.

除非另有說明，此報告結果僅對測試之樣品負責，同時此樣品僅保留90天。本報告未經本公司書面許可，不可部份複製。

This document is issued by the Company subject to its General Conditions of Service printed overleaf, available on request or accessible at www.sgs.com/terms_and_conditions.htm and, for electronic format documents, subject to Terms and Conditions for Electronic Documents at www.sgs.com/terms_e-document.htm. Attention is drawn to the limitation of liability, indemnification and jurisdiction issues defined therein. Any holder of this document is advised that information contained hereon reflects the Company's findings at the time of its intervention only and within the limits of Client's instructions, if any. The Company's sole responsibility is to its Client and this document does not exonerate parties to a transaction from exercising all their rights and obligations under the transaction documents. This document cannot be reproduced except in full, without prior written approval of the Company. Any unauthorized alteration, forgery or falsification of the content or appearance of this document is unlawful and offenders may be prosecuted to the fullest extent of the law.

SGS Taiwan Ltd. No.134, WuKungRoad, NewTaipeiIndustrialPark, WukuDistrict, NewTaipeiCity, Taiwan24803/新北市五股區新北產業園區五工路134號

台灣檢驗科技股份有限公司 t (886-2) 2299-3279

f (886-2) 2298-0488

www.tw.sgs.com

Member of SGS Group

10 minutes:

A. Temperature Variation

Power Supply	Environment	Frequency	Delta (Hz)	Limit (KHz)
Vdc	Temperature (°C)	(MHz)		
120	-20	13.559992	5.60000	+/- 1.356
120	-10	13.560006	-7.50000	+/- 1.356
120	0	13.560003	-4.50000	+/- 1.356
120	10	13.559994	4.10000	+/- 1.356
120	20	13.559998	0.00000	+/- 1.356
120	30	13.559996	1.70000	+/- 1.356
120	40	13.560002	-3.50000	+/- 1.356
120	50	13.559992	6.10000	+/- 1.356

B. Supply Voltage Variation

Power Supply	Environment	Frequency	Delta (Hz)	Limit (KHz)
Vdc	Temperature (°C)	(MHz)		
132	20	13.560006	-13.70000	+/- 1.356
120	20	13.559993	0.00000	+/- 1.356
108	20	13.559999	-6.20000	+/- 1.356

Unless otherwise stated the results shown in this test report refer only to the sample(s) tested and such sample(s) are retained for 90 days only.

除非另有說明，此報告結果僅對測試之樣品負責，同時此樣品僅保留90天。本報告未經本公司書面許可，不可部份複製。

This document is issued by the Company subject to its General Conditions of Service printed overleaf, available on request or accessible at www.sgs.com/terms_and_conditions.htm and, for electronic format documents, subject to Terms and Conditions for Electronic Documents at www.sgs.com/terms_e-document.htm. Attention is drawn to the limitation of liability, indemnification and jurisdiction issues defined therein. Any holder of this document is advised that information contained hereon reflects the Company's findings at the time of its intervention only and within the limits of Client's instructions, if any. The Company's sole responsibility is to its Client and this document does not exonerate parties to a transaction from exercising all their rights and obligations under the transaction documents. This document cannot be reproduced except in full, without prior written approval of the Company. Any unauthorized alteration, forgery or falsification of the content or appearance of this document is unlawful and offenders may be prosecuted to the fullest extent of the law.

SGS Taiwan Ltd. No.134,WuKungRoad,NewTaipeiIndustrialPark,WukuDistrict,NewTaipeiCity,Taiwan24803/新北市五股區新北產業園區五工路134號

台灣檢驗科技股份有限公司 t (886-2) 2299-3279

f (886-2) 2298-0488

www.tw.sgs.com

Member of SGS Group

NFC_Test mode_3

Startup:

A. Temperature Variation

Power Supply	Environment	Frequency	Delta (Hz)	Limit (KHz)
Vdc	Temperature (°C)	(MHz)		
120	-20	13.559927	-5.00000	+/- 1.356
120	-10	13.560059	-137.00000	+/- 1.356
120	0	13.560006	-84.00000	+/- 1.356
120	10	13.559904	18.00000	+/- 1.356
120	20	13.559922	0.00000	+/- 1.356
120	30	13.559924	-2.00000	+/- 1.356
120	40	13.56001	-88.00000	+/- 1.356
120	50	13.560094	-172.00000	+/- 1.356

B. Supply Voltage Variation

Power Supply	Environment	Frequency	Delta (Hz)	Limit (KHz)
Vdc	Temperature (°C)	(MHz)		
132	20	13.560063	-141.00000	+/- 1.356
120	20	13.559922	0.00000	+/- 1.356
108	20	13.560029	-107.00000	+/- 1.356

Unless otherwise stated the results shown in this test report refer only to the sample(s) tested and such sample(s) are retained for 90 days only.

除非另有說明，此報告結果僅對測試之樣品負責，同時此樣品僅保留90天。本報告未經本公司書面許可，不可部份複製。

This document is issued by the Company subject to its General Conditions of Service printed overleaf, available on request or accessible at www.sgs.com/terms_and_conditions.htm and, for electronic format documents, subject to Terms and Conditions for Electronic Documents at www.sgs.com/terms_e-document.htm. Attention is drawn to the limitation of liability, indemnification and jurisdiction issues defined therein. Any holder of this document is advised that information contained hereon reflects the Company's findings at the time of its intervention only and within the limits of Client's instructions, if any. The Company's sole responsibility is to its Client and this document does not exonerate parties to a transaction from exercising all their rights and obligations under the transaction documents. This document cannot be reproduced except in full, without prior written approval of the Company. Any unauthorized alteration, forgery or falsification of the content or appearance of this document is unlawful and offenders may be prosecuted to the fullest extent of the law.

SGS Taiwan Ltd. No.134, WuKungRoad, NewTaipeiIndustrialPark, WukuDistrict, NewTaipeiCity, Taiwan24803/新北市五股區新北產業園區五工路134號

台灣檢驗科技股份有限公司 t (886-2) 2299-3279

f (886-2) 2298-0488

www.tw.sgs.com

Member of SGS Group

2 minutes:

A. Temperature Variation

Power Supply	Environment	Frequency	Delta (Hz)	Limit (KHz)
Vdc	Temperature (°C)	(MHz)		
120	-20	13.559995	-47.00000	+/- 1.356
120	-10	13.560001	-53.00000	+/- 1.356
120	0	13.560005	-57.00000	+/- 1.356
120	10	13.559963	-15.00000	+/- 1.356
120	20	13.559948	0.00000	+/- 1.356
120	30	13.560062	-114.00000	+/- 1.356
120	40	13.559986	-38.00000	+/- 1.356
120	50	13.559938	10.00000	+/- 1.356

B. Supply Voltage Variation

Power Supply	Environment	Frequency	Delta (Hz)	Limit (KHz)
Vdc	Temperature (°C)	(MHz)		
132	20	13.559977	-55.00000	+/- 1.356
120	20	13.559922	0.00000	+/- 1.356
108	20	13.560066	-144.00000	+/- 1.356

Unless otherwise stated the results shown in this test report refer only to the sample(s) tested and such sample(s) are retained for 90 days only.

除非另有說明，此報告結果僅對測試之樣品負責，同時此樣品僅保留90天。本報告未經本公司書面許可，不可部份複製。

This document is issued by the Company subject to its General Conditions of Service printed overleaf, available on request or accessible at www.sgs.com/terms_and_conditions.htm and, for electronic format documents, subject to Terms and Conditions for Electronic Documents at www.sgs.com/terms_e-document.htm. Attention is drawn to the limitation of liability, indemnification and jurisdiction issues defined therein. Any holder of this document is advised that information contained hereon reflects the Company's findings at the time of its intervention only and within the limits of Client's instructions, if any. The Company's sole responsibility is to its Client and this document does not exonerate parties to a transaction from exercising all their rights and obligations under the transaction documents. This document cannot be reproduced except in full, without prior written approval of the Company. Any unauthorized alteration, forgery or falsification of the content or appearance of this document is unlawful and offenders may be prosecuted to the fullest extent of the law.

SGS Taiwan Ltd. No.134, WuKungRoad, NewTaipeiIndustrialPark, WukuDistrict, NewTaipeiCity, Taiwan24803/新北市五股區新北產業園區五工路134號

台灣檢驗科技股份有限公司 t (886-2) 2299-3279

f (886-2) 2298-0488

www.tw.sgs.com

Member of SGS Group

5 minutes:

A. Temperature Variation

Power Supply	Environment	Frequency	Delta (Hz)	Limit (KHz)
Vdc	Temperature (°C)	(MHz)		
120	-20	13.560032	-58.00000	+/- 1.356
120	-10	13.559994	-20.00000	+/- 1.356
120	0	13.55992	54.00000	+/- 1.356
120	10	13.559942	32.00000	+/- 1.356
120	20	13.559974	0.00000	+/- 1.356
120	30	13.560047	-73.00000	+/- 1.356
120	40	13.559961	13.00000	+/- 1.356
120	50	13.560013	-39.00000	+/- 1.356

B. Supply Voltage Variation

Power Supply	Environment	Frequency	Delta (Hz)	Limit (KHz)
Vdc	Temperature (°C)	(MHz)		
132	20	13.559994	-72.00000	+/- 1.356
120	20	13.559922	0.00000	+/- 1.356
108	20	13.560054	-132.00000	+/- 1.356

Unless otherwise stated the results shown in this test report refer only to the sample(s) tested and such sample(s) are retained for 90 days only.

除非另有說明，此報告結果僅對測試之樣品負責，同時此樣品僅保留90天。本報告未經本公司書面許可，不可部份複製。

This document is issued by the Company subject to its General Conditions of Service printed overleaf, available on request or accessible at www.sgs.com/terms_and_conditions.htm and, for electronic format documents, subject to Terms and Conditions for Electronic Documents at www.sgs.com/terms_e-document.htm. Attention is drawn to the limitation of liability, indemnification and jurisdiction issues defined therein. Any holder of this document is advised that information contained hereon reflects the Company's findings at the time of its intervention only and within the limits of Client's instructions, if any. The Company's sole responsibility is to its Client and this document does not exonerate parties to a transaction from exercising all their rights and obligations under the transaction documents. This document cannot be reproduced except in full, without prior written approval of the Company. Any unauthorized alteration, forgery or falsification of the content or appearance of this document is unlawful and offenders may be prosecuted to the fullest extent of the law.

SGS Taiwan Ltd. No.134, WuKungRoad, NewTaipeiIndustrialPark, WukuDistrict, NewTaipeiCity, Taiwan24803/新北市五股區新北產業園區五工路134號

台灣檢驗科技股份有限公司 t (886-2) 2299-3279

f (886-2) 2298-0488

www.tw.sgs.com

Member of SGS Group

10 minutes:

A. Temperature Variation

Power Supply	Environment	Frequency	Delta (Hz)	Limit (KHz)
Vdc	Temperature (°C)	(MHz)		
120	-20	13.560028	28.00000	+/- 1.356
120	-10	13.559965	91.00000	+/- 1.356
120	0	13.559988	68.00000	+/- 1.356
120	10	13.560055	1.00000	+/- 1.356
120	20	13.560056	0.00000	+/- 1.356
120	30	13.560048	8.00000	+/- 1.356
120	40	13.560055	1.00000	+/- 1.356
120	50	13.560013	43.00000	+/- 1.356

B. Supply Voltage Variation

Power Supply	Environment	Frequency	Delta (Hz)	Limit (KHz)
Vdc	Temperature (°C)	(MHz)		
132	20	13.560055	-133.00000	+/- 1.356
120	20	13.559922	0.00000	+/- 1.356
108	20	13.559955	-33.00000	+/- 1.356

Unless otherwise stated the results shown in this test report refer only to the sample(s) tested and such sample(s) are retained for 90 days only.

除非另有說明，此報告結果僅對測試之樣品負責，同時此樣品僅保留90天。本報告未經本公司書面許可，不可部份複製。

This document is issued by the Company subject to its General Conditions of Service printed overleaf, available on request or accessible at www.sgs.com/terms_and_conditions.htm and, for electronic format documents, subject to Terms and Conditions for Electronic Documents at www.sgs.com/terms_e-document.htm. Attention is drawn to the limitation of liability, indemnification and jurisdiction issues defined therein. Any holder of this document is advised that information contained hereon reflects the Company's findings at the time of its intervention only and within the limits of Client's instructions, if any. The Company's sole responsibility is to its Client and this document does not exonerate parties to a transaction from exercising all their rights and obligations under the transaction documents. This document cannot be reproduced except in full, without prior written approval of the Company. Any unauthorized alteration, forgery or falsification of the content or appearance of this document is unlawful and offenders may be prosecuted to the fullest extent of the law.

SGS Taiwan Ltd. No.134, WuKungRoad, NewTaipeiIndustrialPark, WukuDistrict, NewTaipeiCity, Taiwan24803/新北市五股區新北產業園區五工路134號

台灣檢驗科技股份有限公司 t (886-2) 2299-3279

f (886-2) 2298-0488

www.tw.sgs.com

Member of SGS Group

RFID_Test mode_3

Startup:

A. Temperature Variation

Power Supply	Environment	Frequency	Delta (Hz)	Limit (KHz)
Vdc	Temperature (°C)	(MHz)		
120	-20	13.560075	-48.00000	+/- 1.356
120	-10	13.559949	78.00000	+/- 1.356
120	0	13.560084	-57.00000	+/- 1.356
120	10	13.560067	-40.00000	+/- 1.356
120	20	13.560027	0.00000	+/- 1.356
120	30	13.560014	13.00000	+/- 1.356
120	40	13.559986	41.00000	+/- 1.356
120	50	13.560055	-28.00000	+/- 1.356

B. Supply Voltage Variation

Power Supply	Environment	Frequency	Delta (Hz)	Limit (KHz)
Vdc	Temperature (°C)	(MHz)		
132	20	13.56005	-23.00000	+/- 1.356
120	20	13.560027	0.00000	+/- 1.356
108	20	13.560047	-20.00000	+/- 1.356

Unless otherwise stated the results shown in this test report refer only to the sample(s) tested and such sample(s) are retained for 90 days only.

除非另有說明，此報告結果僅對測試之樣品負責，同時此樣品僅保留90天。本報告未經本公司書面許可，不可部份複製。

This document is issued by the Company subject to its General Conditions of Service printed overleaf, available on request or accessible at www.sgs.com/terms_and_conditions.htm and, for electronic format documents, subject to Terms and Conditions for Electronic Documents at www.sgs.com/terms_e-document.htm. Attention is drawn to the limitation of liability, indemnification and jurisdiction issues defined therein. Any holder of this document is advised that information contained hereon reflects the Company's findings at the time of its intervention only and within the limits of Client's instructions, if any. The Company's sole responsibility is to its Client and this document does not exonerate parties to a transaction from exercising all their rights and obligations under the transaction documents. This document cannot be reproduced except in full, without prior written approval of the Company. Any unauthorized alteration, forgery or falsification of the content or appearance of this document is unlawful and offenders may be prosecuted to the fullest extent of the law.

SGS Taiwan Ltd. No.134, WuKungRoad, NewTaipeiIndustrialPark, WukuDistrict, NewTaipeiCity, Taiwan24803/新北市五股區新北產業園區五工路134號

台灣檢驗科技股份有限公司 t (886-2) 2299-3279

f (886-2) 2298-0488

www.tw.sgs.com

Member of SGS Group

2 minutes:

A. Temperature Variation

Power Supply	Environment	Frequency	Delta (Hz)	Limit (KHz)
Vdc	Temperature (°C)	(MHz)		
120	-20	13.560053	36.00000	+/- 1.356
120	-10	13.560007	82.00000	+/- 1.356
120	0	13.560028	61.00000	+/- 1.356
120	10	13.5601	-11.00000	+/- 1.356
120	20	13.560089	0.00000	+/- 1.356
120	30	13.559999	90.00000	+/- 1.356
120	40	13.560088	1.00000	+/- 1.356
120	50	13.560096	-7.00000	+/- 1.356

B. Supply Voltage Variation

Power Supply	Environment	Frequency	Delta (Hz)	Limit (KHz)
Vdc	Temperature (°C)	(MHz)		
132	20	13.560085	-58.00000	+/- 1.356
120	20	13.560027	0.00000	+/- 1.356
108	20	13.559973	54.00000	+/- 1.356

Unless otherwise stated the results shown in this test report refer only to the sample(s) tested and such sample(s) are retained for 90 days only.

除非另有說明，此報告結果僅對測試之樣品負責，同時此樣品僅保留90天。本報告未經本公司書面許可，不可部份複製。

This document is issued by the Company subject to its General Conditions of Service printed overleaf, available on request or accessible at www.sgs.com/terms_and_conditions.htm and, for electronic format documents, subject to Terms and Conditions for Electronic Documents at www.sgs.com/terms_e-document.htm. Attention is drawn to the limitation of liability, indemnification and jurisdiction issues defined therein. Any holder of this document is advised that information contained hereon reflects the Company's findings at the time of its intervention only and within the limits of Client's instructions, if any. The Company's sole responsibility is to its Client and this document does not exonerate parties to a transaction from exercising all their rights and obligations under the transaction documents. This document cannot be reproduced except in full, without prior written approval of the Company. Any unauthorized alteration, forgery or falsification of the content or appearance of this document is unlawful and offenders may be prosecuted to the fullest extent of the law.

SGS Taiwan Ltd. No.134, WuKungRoad, NewTaipeiIndustrialPark, WukuDistrict, NewTaipeiCity, Taiwan24803/新北市五股區新北產業園區五工路134號

台灣檢驗科技股份有限公司 t (886-2) 2299-3279

f (886-2) 2298-0488

www.tw.sgs.com

Member of SGS Group

5 minutes:

A. Temperature Variation

Power Supply	Environment	Frequency	Delta (Hz)	Limit (KHz)
Vdc	Temperature (°C)	(MHz)		
120	-20	13.560058	-61.00000	+/- 1.356
120	-10	13.560056	-59.00000	+/- 1.356
120	0	13.559973	24.00000	+/- 1.356
120	10	13.559918	79.00000	+/- 1.356
120	20	13.559997	0.00000	+/- 1.356
120	30	13.55995	47.00000	+/- 1.356
120	40	13.560019	-22.00000	+/- 1.356
120	50	13.560015	-18.00000	+/- 1.356

B. Supply Voltage Variation

Power Supply	Environment	Frequency	Delta (Hz)	Limit (KHz)
Vdc	Temperature (°C)	(MHz)		
132	20	13.560006	21.00000	+/- 1.356
120	20	13.560027	0.00000	+/- 1.356
108	20	13.560076	-49.00000	+/- 1.356

Unless otherwise stated the results shown in this test report refer only to the sample(s) tested and such sample(s) are retained for 90 days only.

除非另有說明，此報告結果僅對測試之樣品負責，同時此樣品僅保留90天。本報告未經本公司書面許可，不可部份複製。

This document is issued by the Company subject to its General Conditions of Service printed overleaf, available on request or accessible at www.sgs.com/terms_and_conditions.htm and, for electronic format documents, subject to Terms and Conditions for Electronic Documents at www.sgs.com/terms_e-document.htm. Attention is drawn to the limitation of liability, indemnification and jurisdiction issues defined therein. Any holder of this document is advised that information contained hereon reflects the Company's findings at the time of its intervention only and within the limits of Client's instructions, if any. The Company's sole responsibility is to its Client and this document does not exonerate parties to a transaction from exercising all their rights and obligations under the transaction documents. This document cannot be reproduced except in full, without prior written approval of the Company. Any unauthorized alteration, forgery or falsification of the content or appearance of this document is unlawful and offenders may be prosecuted to the fullest extent of the law.

SGS Taiwan Ltd. No.134, WuKungRoad, NewTaipeiIndustrialPark, WukuDistrict, NewTaipeiCity, Taiwan24803/新北市五股區新北產業園區五工路134號

台灣檢驗科技股份有限公司 t (886-2) 2299-3279

f (886-2) 2298-0488

www.tw.sgs.com

Member of SGS Group

10 minutes:

A. Temperature Variation

Power Supply	Environment	Frequency	Delta (Hz)	Limit (KHz)
Vdc	Temperature (°C)	(MHz)		
120	-20	13.559929	-22.00000	+/- 1.356
120	-10	13.560061	-154.00000	+/- 1.356
120	0	13.559962	-55.00000	+/- 1.356
120	10	13.559913	-6.00000	+/- 1.356
120	20	13.559907	0.00000	+/- 1.356
120	30	13.560069	-162.00000	+/- 1.356
120	40	13.560084	-177.00000	+/- 1.356
120	50	13.560052	-145.00000	+/- 1.356

B. Supply Voltage Variation

Power Supply	Environment	Frequency	Delta (Hz)	Limit (KHz)
Vdc	Temperature (°C)	(MHz)		
132	20	13.559951	76.00000	+/- 1.356
120	20	13.560027	0.00000	+/- 1.356
108	20	13.560078	-51.00000	+/- 1.356

Unless otherwise stated the results shown in this test report refer only to the sample(s) tested and such sample(s) are retained for 90 days only.

除非另有說明，此報告結果僅對測試之樣品負責，同時此樣品僅保留90天。本報告未經本公司書面許可，不可部份複製。

This document is issued by the Company subject to its General Conditions of Service printed overleaf, available on request or accessible at www.sgs.com/terms_and_conditions.htm and, for electronic format documents, subject to Terms and Conditions for Electronic Documents at www.sgs.com/terms_e-document.htm. Attention is drawn to the limitation of liability, indemnification and jurisdiction issues defined therein. Any holder of this document is advised that information contained hereon reflects the Company's findings at the time of its intervention only and within the limits of Client's instructions, if any. The Company's sole responsibility is to its Client and this document does not exonerate parties to a transaction from exercising all their rights and obligations under the transaction documents. This document cannot be reproduced except in full, without prior written approval of the Company. Any unauthorized alteration, forgery or falsification of the content or appearance of this document is unlawful and offenders may be prosecuted to the fullest extent of the law.

SGS Taiwan Ltd. No.134, WuKungRoad, NewTaipeiIndustrialPark, WukuDistrict, NewTaipeiCity, Taiwan24803/新北市五股區新北產業園區五工路134號

台灣檢驗科技股份有限公司 t (886-2) 2299-3279

f (886-2) 2298-0488

www.tw.sgs.com

Member of SGS Group

9 20 dB & 99% OCCUPIED BANDWIDTH MEASUREMENT

9.1 Standard Applicable:

The 20 dB bandwidth shall be specified in operating frequency band.

9.2 Limit:

None

9.3 Test Set-up

Refer to section 8.3 in this report

9.4 Measurement Procedure

1. Placed the EUT on the testing table.
2. Set the EUT under transmission condition continuously at specific channel frequency.
3. 20dB Bandwidth the resolution bandwidth of 1 kHz and the video bandwidth of 3 kHz were used.
4. Measured the spectrum width with power higher than 20dB below carrier.

9.5 Measurement Equipment Used

Refer to section 8.4 in this report

Unless otherwise stated the results shown in this test report refer only to the sample(s) tested and such sample(s) are retained for 90 days only.

除非另有說明，此報告結果僅對測試之樣品負責，同時此樣品僅保留90天。本報告未經本公司書面許可，不可部份複製。

This document is issued by the Company subject to its General Conditions of Service printed overleaf, available on request or accessible at www.sgs.com/terms_and_conditions.htm and, for electronic format documents, subject to Terms and Conditions for Electronic Documents at www.sgs.com/terms_e-document.htm. Attention is drawn to the limitation of liability, indemnification and jurisdiction issues defined therein. Any holder of this document is advised that information contained hereon reflects the Company's findings at the time of its intervention only and within the limits of Client's instructions, if any. The Company's sole responsibility is to its Client and this document does not exonerate parties to a transaction from exercising all their rights and obligations under the transaction documents. This document cannot be reproduced except in full, without prior written approval of the Company. Any unauthorized alteration, forgery or falsification of the content or appearance of this document is unlawful and offenders may be prosecuted to the fullest extent of the law.

SGS Taiwan Ltd. No.134, WuKungRoad, NewTaipeiIndustrialPark, WukuDistrict, NewTaipeiCity, Taiwan24803/新北市五股區新北產業園區五工路134號

台灣檢驗科技股份有限公司 t (886-2) 2299-3279

f (886-2) 2298-0488

www.tw.sgs.com

Member of SGS Group

9.6 Measurement Result: NFC_Test mode_1

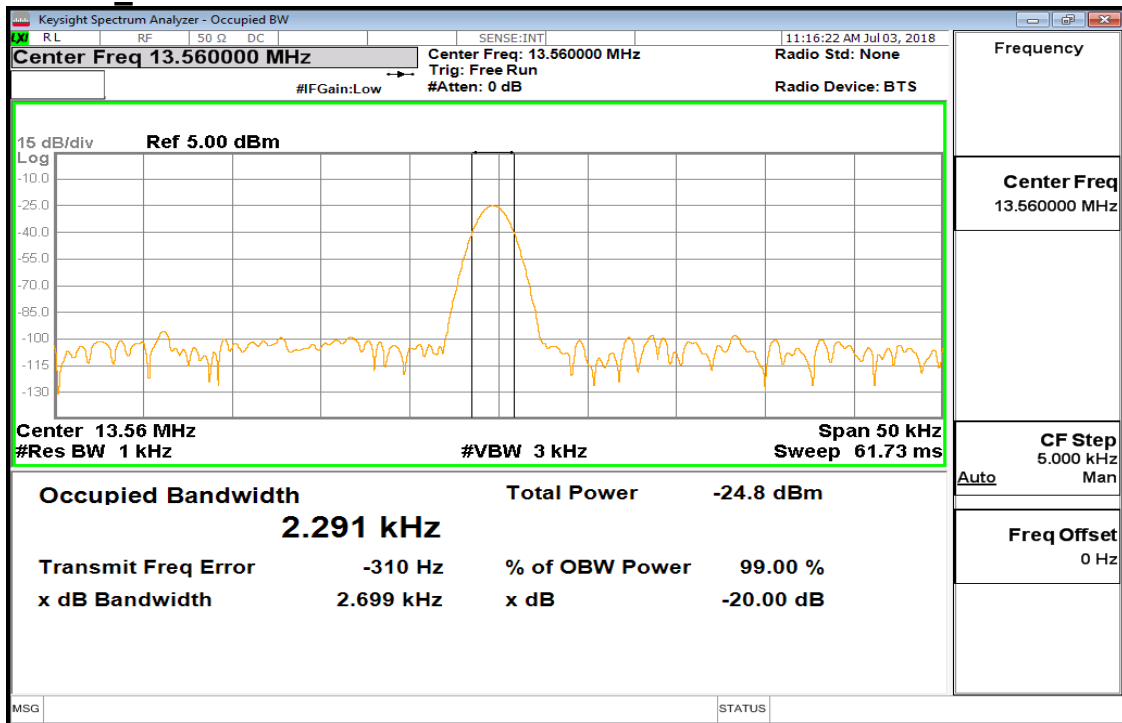

RFID_Test mode_1

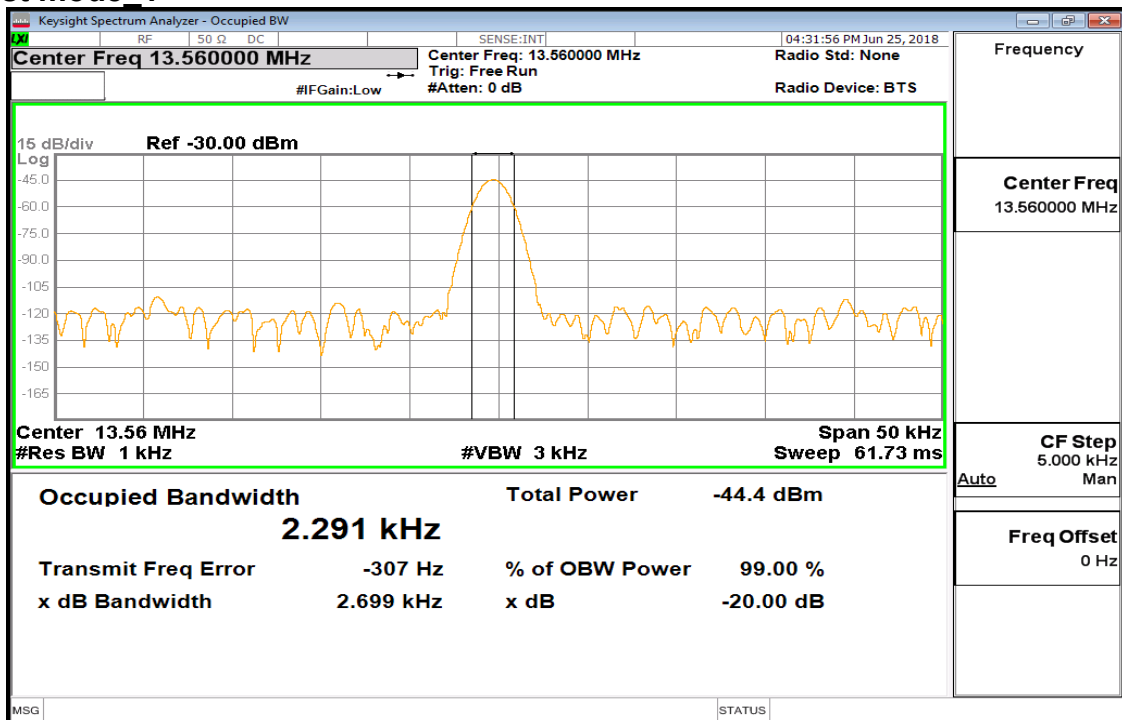

Unless otherwise stated the results shown in this test report refer only to the sample(s) tested and such sample(s) are retained for 90 days only.

除非另有說明，此報告結果僅對測試之樣品負責，同時此樣品僅保留90天。本報告未經本公司書面許可，不可部份複製。

This document is issued by the Company subject to its General Conditions of Service printed overleaf, available on request or accessible at www.sgs.com/terms_and_conditions.htm and, for electronic format documents, subject to Terms and Conditions for Electronic Documents at www.sgs.com/terms_e-document.htm. Attention is drawn to the limitation of liability, indemnification and jurisdiction issues defined therein. Any holder of this document is advised that information contained hereon reflects the Company's findings at the time of its intervention only and within the limits of Client's instructions, if any. The Company's sole responsibility is to its Client and this document does not exonerate parties to a transaction from exercising all their rights and obligations under the transaction documents. This document cannot be reproduced except in full, without prior written approval of the Company. Any unauthorized alteration, forgery or falsification of the content or appearance of this document is unlawful and offenders may be prosecuted to the fullest extent of the law.

SGS Taiwan Ltd. No.134, Wukung Road, New Taipei Industrial Park, Wuku District, New Taipei City, Taiwan 24803/新北市五股區新北產業園區五工路134號

台灣檢驗科技股份有限公司 t (886-2) 2299-3279

f (886-2) 2298-0488

www.tw.sgs.com

Member of SGS Group

NFC_Test mode 2

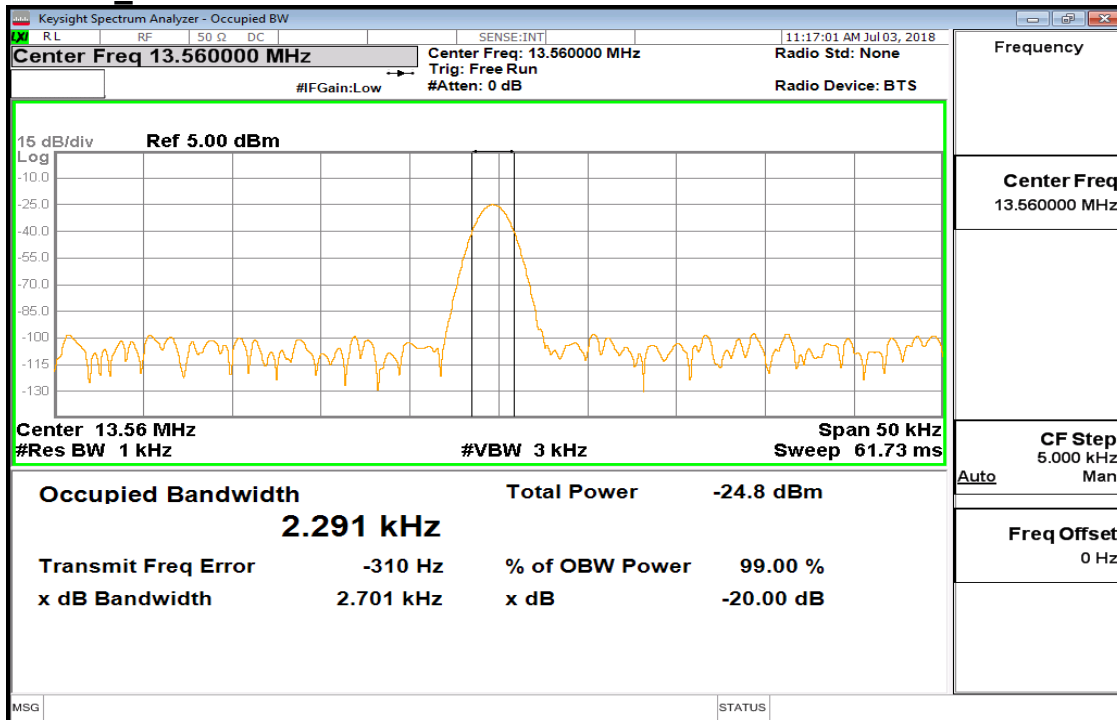

RFID_Test mode 2

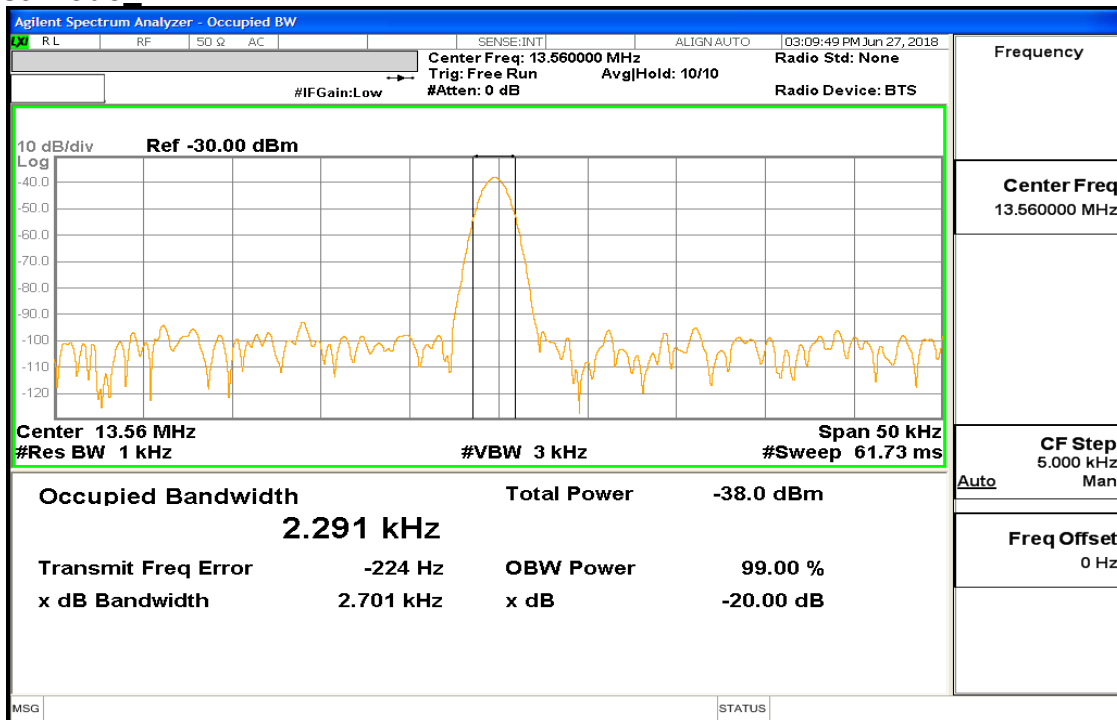

Unless otherwise stated the results shown in this test report refer only to the sample(s) tested and such sample(s) are retained for 90 days only.

除非另有說明，此報告結果僅對測試之樣品負責，同時此樣品僅保留90天。本報告未經本公司書面許可，不可部份複製。

This document is issued by the Company subject to its General Conditions of Service printed overleaf, available on request or accessible at www.sgs.com/terms_and_conditions.htm and, for electronic format documents, subject to Terms and Conditions for Electronic Documents at www.sgs.com/terms_e-document.htm. Attention is drawn to the limitation of liability, indemnification and jurisdiction issues defined therein. Any holder of this document is advised that information contained hereon reflects the Company's findings at the time of its intervention only and within the limits of Client's instructions, if any. The Company's sole responsibility is to its Client and this document does not exonerate parties to a transaction from exercising all their rights and obligations under the transaction documents. This document cannot be reproduced except in full, without prior written approval of the Company. Any unauthorized alteration, forgery or falsification of the content or appearance of this document is unlawful and offenders may be prosecuted to the fullest extent of the law.

SGS Taiwan Ltd. No.134, WuKungRoad, NewTaipeiIndustrialPark, WukuDistrict, NewTaipeiCity, Taiwan24803/新北市五股區新北產業園區五工路134號

台灣檢驗科技股份有限公司 t (886-2) 2299-3279

f (886-2) 2298-0488

www.tw.sgs.com

Member of SGS Group

NFC_Test mode_3

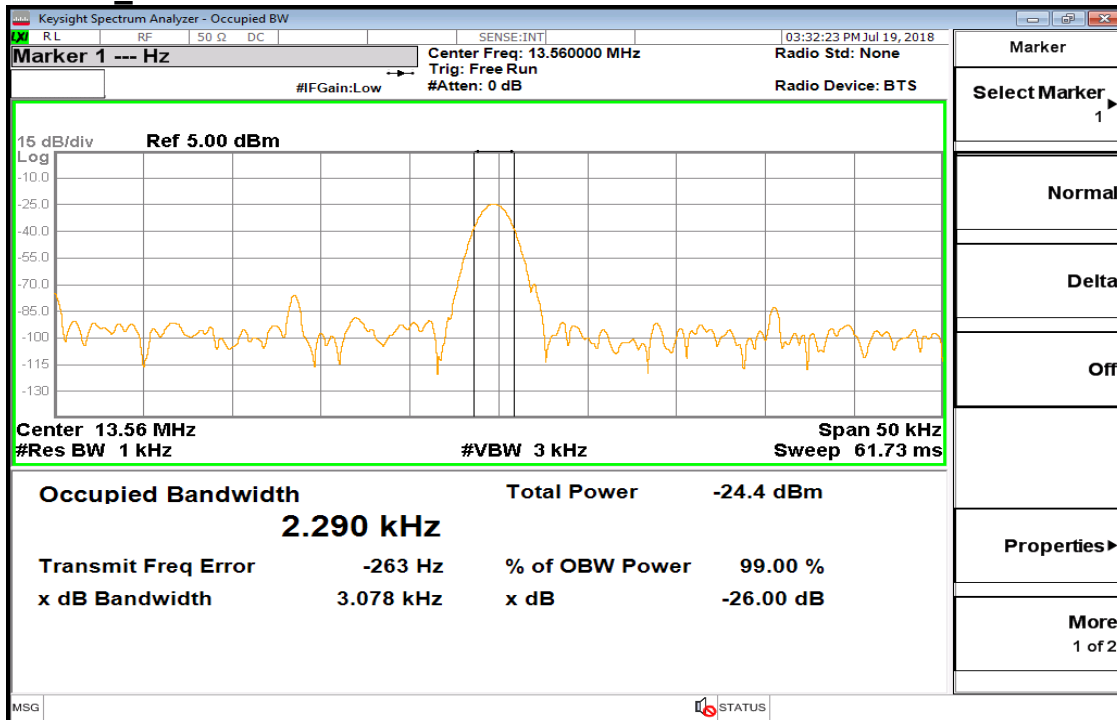

RFID_Test mode_3

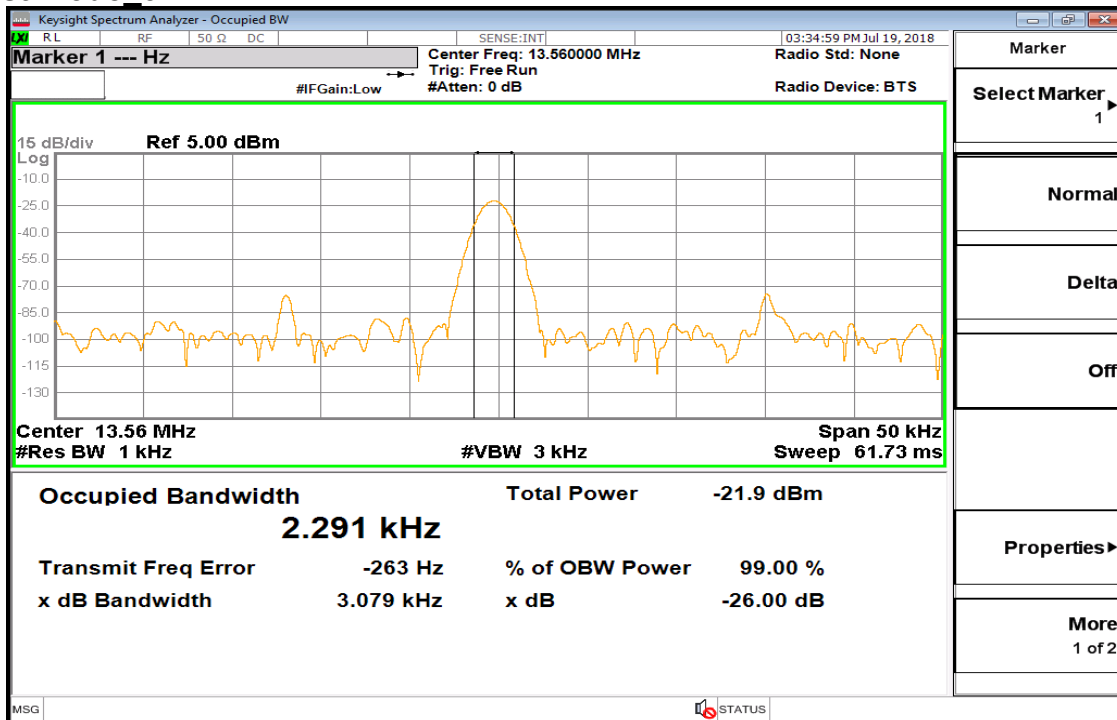

Unless otherwise stated the results shown in this test report refer only to the sample(s) tested and such sample(s) are retained for 90 days only.

除非另有說明，此報告結果僅對測試之樣品負責，同時此樣品僅保留90天。本報告未經本公司書面許可，不可部份複製。

This document is issued by the Company subject to its General Conditions of Service printed overleaf, available on request or accessible at www.sgs.com/terms_and_conditions.htm and, for electronic format documents, subject to Terms and Conditions for Electronic Documents at www.sgs.com/terms_e-document.htm. Attention is drawn to the limitation of liability, indemnification and jurisdiction issues defined therein. Any holder of this document is advised that information contained hereon reflects the Company's findings at the time of its intervention only and within the limits of Client's instructions, if any. The Company's sole responsibility is to its Client and this document does not exonerate parties to a transaction from exercising all their rights and obligations under the transaction documents. This document cannot be reproduced except in full, without prior written approval of the Company. Any unauthorized alteration, forgery or falsification of the content or appearance of this document is unlawful and offenders may be prosecuted to the fullest extent of the law.

SGS Taiwan Ltd. No.134, WuKungRoad, NewTaipeiIndustrialPark, WukuDistrict, NewTaipeiCity, Taiwan24803/新北市五股區新北產業園區五工路134號

台灣檢驗科技股份有限公司 t (886-2) 2299-3279

f (886-2) 2298-0488

www.tw.sgs.com

Member of SGS Group

10 ANTENNA REQUIREMENT

10.1. Standard Applicable

An intentional radiator shall be designed to ensure that no antenna other than that furnished by the responsible party shall be used with the device. The use of a permanently attached antenna or of an antenna that uses a unique coupling to the intentional radiator shall be considered sufficient to comply with the provisions of this Section. The manufacturer may design the unit so that a broken antenna can be replaced by the user, but the use of a standard antenna jack or electrical connector is prohibited. This requirement does not apply to carrier current devices or to devices operated under the provisions of Sections 15.211, 15.213, 15.217, 15.219, or 15.221. Further, this requirement does not apply to intentional radiators that must be professionally installed, such as perimeter protection systems and some field disturbance sensors, or to other intentional radiators which, in accordance with Section 15.31(d), must be measured at the installation site. However, the installer shall be responsible for ensuring that the proper antenna is employed so that the limits in this Part are not exceeded.

When a measurement at the antenna connector is used to determine RF output power, the effective gain of the device's antenna shall be stated, based on measurement or on data from the antenna manufacturer.

For transmitters of RF output power of 10 milliwatts or less, only the portion of the antenna gain that is in excess of 6 dBi (6 dB above isotropic gain) shall be added to the measured RF output power to demonstrate compliance with the radiated power limits specified in the applicable standard. For transmitters of output power greater than 10 milliwatts, the total antenna gain shall be added to the measured RF output power to demonstrate compliance to the specified radiated power limits.

According to RSS-GEN 8.3

The applicant for equipment certification, as per RSP-100, must provide a list of all antenna types that may be used with the licence-exempt transmitter, indicating the maximum permissible antenna gain (in dBi) and the required impedance for each antenna.

Licence-exempt transmitters that have received equipment certification may operate with different types of antennas. However, it is not permissible to exceed the maximum equivalent isotropically radiated power (e.i.r.p.) limits specified in the applicable standard (RSS) for the licence-exempt apparatus.

Testing shall be performed using the highest gain antenna of each combination of licence-exempt transmitter and antenna type, with the transmitter output power set at the maximum level.9 When a measurement at the antenna connector is used to determine RF output power, the effective gain of the device's antenna shall be stated, based on a measurement or on data from the antenna manufacturer.

10.2. Antenna Connected Construction

The antenna connector is designed with unique type loop antenna and no consideration of replacement. Please see EUT photo for details.

~ End of Report ~

Unless otherwise stated the results shown in this test report refer only to the sample(s) tested and such sample(s) are retained for 90 days only.

除非另有說明，此報告結果僅對測試之樣品負責，同時此樣品僅保留90天。本報告未經本公司書面許可，不可部份複製。

This document is issued by the Company subject to its General Conditions of Service printed overleaf, available on request or accessible at www.sgs.com/terms_and_conditions.htm and, for electronic format documents, subject to Terms and Conditions for Electronic Documents at www.sgs.com/terms_e-document.htm. Attention is drawn to the limitation of liability, indemnification and jurisdiction issues defined therein. Any holder of this document is advised that information contained hereon reflects the Company's findings at the time of its intervention only and within the limits of Client's instructions, if any. The Company's sole responsibility is to its Client and this document does not exonerate parties to a transaction from exercising all their rights and obligations under the transaction documents. This document cannot be reproduced except in full, without prior written approval of the Company. Any unauthorized alteration, forgery or falsification of the content or appearance of this document is unlawful and offenders may be prosecuted to the fullest extent of the law.

SGS Taiwan Ltd. No.134, WuKungRoad, NewTaipeiIndustrialPark, WukuDistrict, NewTaipeiCity, Taiwan24803/新北市五股區新北產業園區五工路134號

台灣檢驗科技股份有限公司 t (886-2) 2299-3279

f (886-2) 2298-0488

www.tw.sgs.com

Member of SGS Group