



**FCC 47 CFR PART 15 SUBPART C  
(Class II Permissive Change)**

**TEST REPORT**

**For**

**RFID 13.56MHz Wireless Module**

**Model: DWRFID1202**

**Trade Name: DELL**

*Issued to*

**Dell Inc.**

**One Dell Way Round Rock Texas 78682 United States**

*Issued by*

**Compliance Certification Services Inc.**

**No.11, Wugong 6th Rd., Wugu Dist.,  
New Taipei City 24891, Taiwan. (R.O.C.)**

**<http://www.ccsrf.com>**

**[service@ccsrf.com](mailto:service@ccsrf.com)**

**Issued Date: December 24, 2012**



**Testing Laboratory  
1309**

---

*Note: This report shall not be reproduced except in full, without the written approval of Compliance Certification Services Inc. This document may be altered or revised by Compliance Certification Services Inc. personnel only, and shall be noted in the revision section of the document.*



**Revision History**

Rev.	Issue Date	Revisions	Effect Page	Revised By
00	December 24, 2012	Initial Issue	ALL	Eunice Shen



## TABLE OF CONTENTS

<b>1. TEST RESULT CERTIFICATION.....</b>	<b>4</b>
<b>2. EUT DESCRIPTION .....</b>	<b>5</b>
<b>3. TEST METHODOLOGY .....</b>	<b>6</b>
3.1 EUT CONFIGURATION .....	6
3.2 EUT EXERCISE .....	6
3.3 GENERAL TEST PROCEDURES .....	6
3.4 FCC PART 15.205 RESTRICTED BANDS OF OPERATIONS .....	7
3.5 DESCRIPTION OF TEST MODES .....	8
<b>4. INSTRUMENT CALIBRATION.....</b>	<b>9</b>
4.1 MEASURING INSTRUMENT CALIBRATION .....	9
4.2 MEASUREMENT EQUIPMENT USED .....	9
4.3 MEASUREMENT UNCERTAINTY .....	10
<b>5. FACILITIES AND ACCREDITATIONS .....</b>	<b>11</b>
5.1 FACILITIES .....	11
5.2 EQUIPMENT .....	11
5.3 TABLE OF ACCREDITATIONS AND LISTINGS .....	12
<b>6. SETUP OF EQUIPMENT UNDER TEST .....</b>	<b>13</b>
6.1 SETUP CONFIGURATION OF EUT .....	13
6.2 SUPPORT EQUIPMENT.....	13
<b>7. FCC PART 15.225 REQUIREMENTS.....</b>	<b>14</b>
7.1 20 DB BANDWIDTH .....	14
7.2 RADIATED EMISSIONS .....	16
7.3 FREQUENCY STABILITY .....	21
7.4 POWERLINE CONDUCTED EMISSIONS .....	23
<b>APPENDIX I PHOTOGRAPHS OF TEST SETUP .....</b>	<b>26</b>
<b>APPENDIX 1 - PHOTOGRAPHS OF EUT</b>	



# 1. TEST RESULT CERTIFICATION

**Applicant:** Dell Inc.  
 One Dell Way Round Rock Texas 78682 United States

**Equipment Under Test:** RFID 13.56MHz Wireless Module

**Trade Name:** DELL

**Model:** DWRFID1202

**Date of Test:** December 19 ~ 24, 2012

APPLICABLE STANDARDS	
STANDARD	TEST RESULT
FCC 47 CFR Part 15 Subpart C	No non-compliance noted

## We hereby certify that:

The above equipment was tested by Compliance Certification Services Inc. The test data, data evaluation, test procedures, and equipment configurations shown in this report were made in accordance with the procedures given in ANSI C63.4: 2009 and the energy emitted by the sample tested as described in this report is in compliance with the requirements of FCC Rules Part 15.225.

The test results of this report relate only to the tested sample identified in this report.

Approved by:

Reviewed by:

\_\_\_\_\_  
 Miller Lee  
 Section Manager  
 Compliance Certification Services Inc.

\_\_\_\_\_  
 Gina Lo  
 Section Manager  
 Compliance Certification Services Inc.



## 2. EUT DESCRIPTION

<b>Product</b>	RFID 13.56MHz Wireless Module
<b>Trade Name</b>	DELL
<b>Model Number</b>	DWRFID1202
<b>Model Difference</b>	N/A
<b>Received Date</b>	December 17, 2012
<b>Power Supply</b>	Powered by host device.
<b>Frequency Range</b>	13.56MHz
<b>Modulation Technique</b>	ASK
<b>Number of Channels</b>	1 Channel
<b>Antenna Designation</b>	Loop Antenna / Gain: 0 dBi
<b>Class II Permissive Change</b>	The product DWRFID1202 will be installed in the following models of notebooks/laptops: Model: P29F Product name: Notebook Computer / Brand name: DELL / Model: P29F

**Remark:**

1. The sample selected for test was engineering sample that approximated to production product and was provided by manufacturer.
2. This submittal(s) (test report) is intended for FCC ID: **E2K-DWRFID1202** filing to comply with Section 15.225 of the FCC Part 15, Subpart C Rules.



### **3. TEST METHODOLOGY**

The tests documented in this report were performed in accordance with ANSI C63.4: 2009 and FCC CFR 47 Part 15.207, 15.209 and 15.225.

#### **3.1 EUT CONFIGURATION**

The EUT configuration for testing is installed on RF field strength measurement to meet the Commissions requirement and operating in a manner that intends to maximize its emission characteristics in a continuous normal application.

#### **3.2 EUT EXERCISE**

The EUT was operated in the engineering mode to fix the TX frequency that was for the purpose of the measurements.

#### **3.3 GENERAL TEST PROCEDURES**

##### **Conducted Emissions**

The EUT is placed on the turntable, which is 0.8 m above ground plane. According to the requirements in Section 13.1.4.1 of ANSI C63.4: 2009. Conducted emissions from the EUT measured in the frequency range between 0.15 MHz and 30MHz using CISPR Quasi-peak and average detector modes.

##### **Radiated Emissions**

The EUT is placed on a turn table, which is 0.8 m above ground plane. The turntable shall rotate 360 degrees to determine the position of maximum emission level. EUT is set 3m away from the receiving antenna, which varied from 1m to 4m to find out the highest emission. And also, each emission was to be maximized by changing the polarization of receiving antenna both horizontal and vertical. In order to find out the maximum emissions, exploratory radiated emission measurements were made according to the requirements in Section 13.1.4.1 of ANSI C63.4: 2009.



### 3.4 FCC PART 15.205 RESTRICTED BANDS OF OPERATIONS

(a) Except as shown in paragraph (d) of this section, only spurious emissions are permitted in any of the frequency bands listed below:

MHz	MHz	MHz	GHz
0.090 - 0.110	16.42 - 16.423	399.9 - 410	4.5 - 5.15
<sup>1</sup> 0.495 - 0.505	16.69475 - 16.69525	608 - 614	5.35 - 5.46
2.1735 - 2.1905	16.80425 - 16.80475	960 - 1240	7.25 - 7.75
4.125 - 4.128	25.5 - 25.67	1300 - 1427	8.025 - 8.5
4.17725 - 4.17775	37.5 - 38.25	1435 - 1626.5	9.0 - 9.2
4.20725 - 4.20775	73 - 74.6	1645.5 - 1646.5	9.3 - 9.5
6.215 - 6.218	74.8 - 75.2	1660 - 1710	10.6 - 12.7
6.26775 - 6.26825	108 - 121.94	1718.8 - 1722.2	13.25 - 13.4
6.31175 - 6.31225	123 - 138	2200 - 2300	14.47 - 14.5
8.291 - 8.294	149.9 - 150.05	2310 - 2390	15.35 - 16.2
8.362 - 8.366	156.52475 -	2483.5 - 2500	17.7 - 21.4
8.37625 - 8.38675	156.52525	2655 - 2900	22.01 - 23.12
8.41425 - 8.41475	156.7 - 156.9	3260 - 3267	23.6 - 24.0
12.29 - 12.293	162.0125 - 167.17	3332 - 3339	31.2 - 31.8
12.51975 - 12.52025	167.72 - 173.2	3345.8 - 3358	36.43 - 36.5
12.57675 - 12.57725	240 - 285	3600 - 4400	( <sup>2</sup> )
13.36 - 13.41	322 - 335.4		

<sup>1</sup> Until February 1, 1999, this restricted band shall be 0.490-0.510 MHz.

<sup>2</sup> Above 38.6

(b) Except as provided in paragraphs (d) and (e), the field strength of emissions appearing within these frequency bands shall not exceed the limits shown in Section 15.209. At frequencies equal to or less than 1000 MHz, compliance with the limits in Section 15.209 shall be demonstrated using measurement instrumentation employing a CISPR quasi-peak detector. Above 1000 MHz, compliance with the emission limits in Section 15.209 shall be demonstrated based on the average value of the measured emissions. The provisions in Section 15.35 apply to these measurements.



### **3.5 DESCRIPTION OF TEST MODES**

The EUT (model: DWRFID1202) had been tested under operating condition.

Software used to control the EUT for staying in continuous transmitting and receiving mode was programmed.

After verification, all tests carried out were with the worst-case test modes as shown below except radiated spurious emission worst case was in normal link mode.

RF ID: Channel 13.56MHz was chosen for full testing.





## 4. INSTRUMENT CALIBRATION

### 4.1 MEASURING INSTRUMENT CALIBRATION

The measuring equipment, which was utilized in performing the tests documented herein, has been calibrated in accordance with the manufacturer's recommendations for utilizing calibration equipment, which is traceable to recognized national standards.

### 4.2 MEASUREMENT EQUIPMENT USED

#### Equipment Used for Emissions Measurement

*Remark: Each piece of equipment is scheduled for calibration once a year and Loop Antenna is scheduled for calibration once three years.*

Conducted Emissions Test Site				
Name of Equipment	Manufacturer	Model	Serial Number	Calibration Due
Spectrum Analyzer	Agilent	E4446A	US42510268	11/14/2013
Power Meter	Anritsu	ML2495A	1012009	04/26/2013
Power Sensor	Anritsu	MA2411A	0917072	04/26/2013

Wugu 966 Chamber A				
Name of Equipment	Manufacturer	Model	Serial Number	Calibration Due
Spectrum Analyzer	Agilent	E4446A	US42510268	11/06/2013
EMI Test Receiver	R&S	ESCI	100064	03/01/2013
Pre-Amplifier	Mini-Circuits	ZFL-1000LN	SF350700823	01/13/2013
Pre-Amplifier	MITEQ	AFS44-00102650-42-10P-44	1415367	11/19/2013
Bilog Antenna	Sunol Sciences	JB3	A030105	10/02/2013
Horn Antenna	EMCO	3117	00055165	02/14/2013
Turn Table	CCS	CC-T-1F	N/A	N.C.R
Antenna Tower	CCS	CC-A-1F	N/A	N.C.R
Controller	CCS	CC-C-1F	N/A	N.C.R
Site NSA	CCS	N/A	N/A	12/22/2013
Test S/W	EZ-EMC (CCS-3A1RE)			

Conducted Emission room # A				
Name of Equipment	Manufacturer	Model	Serial Number	Calibration Due
EMI Test Receiver	R&S	ESCI	101203	09/13/2013
LISN	R&S	ESH3-Z5	848773/014	12/06/2013
LISN	SCHWARZBECK	NSLK 8127	8127-541	12/13/2013
Coaxial Cable	Commate	CFD300-NL	NA	12/06/2013
Test S/W	CCS-3A1-CE			



### 4.3 MEASUREMENT UNCERTAINTY

PARAMETER	UNCERTAINTY
Powerline Conducted Emission	+/- 1.2159
3M Semi Anechoic Chamber / 30M~200M	+/- 4.0138
3M Semi Anechoic Chamber / 200M~1000M	+/- 3.9483
3M Semi Anechoic Chamber / 1G~8G	+/- 2.5975
3M Semi Anechoic Chamber / 8G~18G	+/- 2.6112
3M Semi Anechoic Chamber / 18G~26G	+/- 2.7389
3M Semi Anechoic Chamber / 26G~40G	+/- 2.9683

**Remark:** This uncertainty represents an expanded uncertainty expressed at approximately the 95% confidence level using a coverage factor of  $k=2$ .



## **5. FACILITIES AND ACCREDITATIONS**

### **5.1 FACILITIES**

All measurement facilities used to collect the measurement data are located at

No.199, Chunghsen Road, Hsintien City, Taipei Hsien, Taiwan, R.O.C.  
Tel: 886-2-2217-0894 / Fax: 886-2-2217-1029

No.11, Wugong 6th Rd., Wugu Dist., New Taipei City 24891, Taiwan. (R.O.C.)  
Tel: 886-2-2299-9720 / Fax: 886-2-2298-4045

No.81-1, Lane 210, Bade 2nd Rd., Lujhu Township, Taoyuan County 33841,  
TAIWAN, R.O.C.  
Tel: 886-3-324-0332 / Fax: 886-3-324-5235

The sites are constructed in conformance with the requirements of ANSI C63.7, ANSI C63.4 and CISPR Publication 22.

### **5.2 EQUIPMENT**

Radiated emissions are measured with one or more of the following types of linearly polarized antennas: tuned dipole, biconical, log periodic, bi-log, and/or ridged waveguide, horn. Spectrum analyzers with pre-selectors and quasi-peak detectors are used to perform radiated measurements.



Conducted emissions are measured with Line Impedance Stabilization Networks and EMI Test Receivers.

Calibrated wideband preamplifiers, coaxial cables, and coaxial attenuators are also used for making measurements.

All receiving equipment conforms to CISPR Publication 16-1, "Radio Interference Measuring Apparatus and Measurement Methods."



### 5.3 TABLE OF ACCREDITATIONS AND LISTINGS

Country	Agency	Scope of Accreditation	Logo
USA	FCC	3M Semi Anechoic Chamber (FCC MRA: TW1039) to perform FCC Part 15 measurements	 FCC MRA: TW1039
Taiwan	TAF	LP0002, RTTE01, FCC Method-47 CFR Part 15 Subpart C, D, E, RSS-210, RSS-310 IDA TS SRD, AS/NZS 4268, AS/NZS 4771, TS 12.1 & 12.2, ETSI EN 300 440-1, ETSI EN 300 440-2, ETSI EN 300 328, ETSI EN 300 220-1, ETSI EN 300 220-2, ETSI EN 301 893, ETSI EN 301 489-1/3/7/17 FCC OET Bulletin 65 + Supplement C, EN 50360, EN 50361, EN 50371, RSS 102, EN 50383, EN 50385, EN 50392, IEC 62209, CNS 14958-1, CNS 14959 FCC Method -47 CFR Part 15 Subpart B IEC / EN 61000-3-2, IEC / EN 61000-3-3, IEC / EN 61000-4-2/3/4/5/6/8/11	
Canada	Industry Canada	3M Semi Anechoic Chamber (IC 2324G-1 / IC 2324G-2) to perform	 IC 2324G-1 IC 2324G-2

\* No part of this report may be used to claim or imply product endorsement by A2LA or any agency of the US Government.



## 6. SETUP OF EQUIPMENT UNDER TEST

### 6.1 SETUP CONFIGURATION OF EUT

See test photographs attached in Appendix I for the actual connections between EUT and support equipment.

### 6.2 SUPPORT EQUIPMENT

No.	Device Type	Brand	Model	Series No.	FCC ID	Data Cable	Power Cord
1.	LCD Monitor	DELL	2408WFPb	CN-OG293H-7426 1-95M-1KGS	FCC DoC	Shielded, 1.8m with 2 cores	Unshielded, 1.8m
2.	LCD Monitor	DELL	2408WFPb	CN-OG293H-7426 1-95M-1KGS	FCC DoC	Shielded, 1.8m with 2 cores	Unshielded, 1.8m
3.	Printer	HP	C8952D	CN26R182GJ	FCC DoC	Shielded, 1.8m	Unshielded, 1.8m
4.	1TB 3.5" HDD	Buffalo	HD-HX1.0TU3-AP	15564891207204	FCC DoC	Shielded, 1m	N/A
5.	1TB 3.5" HDD	Buffalo	HD-HX1.0TU3-AP	15564891208089	FCC DoC	Shielded, 1m	N/A
6.	USB Mouse	DELL	M-UV69a	323617-001	FCC DoC	Shielded, 1.8m	N/A

**Remark:**

1. All the equipment/cables were placed in the worst-case configuration to maximize the emission during the test.
2. Grounding was established in accordance with the manufacturer's requirements and conditions for the intended use.



## 7. FCC PART 15.225 REQUIREMENTS

### 7.1 20 DB BANDWIDTH

#### LIMIT

None; for reporting purposes only.

#### Test Configuration

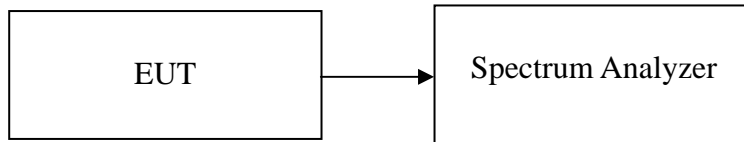

#### TEST PROCEDURE

1. Place the EUT on the table and set it in the transmitting mode.
2. Remove the antenna from the EUT and then connect a low loss RF cable from the antenna port to the spectrum analyzer.
3. Set the spectrum analyzer as RBW= 3kHz, VBW = 10kHz, Span = 500kHz, Sweep = auto.
4. Mark the peak frequency and 20dB (upper and lower) frequency.
5. Repeat until all the rest channels are investigated.

#### TEST RESULTS

*No non-compliance noted.*



### Test Plot

Agilent 16:32:56 Dec 20, 2012

R T

Mkr2 93.1 kHz  
-0.26 dB

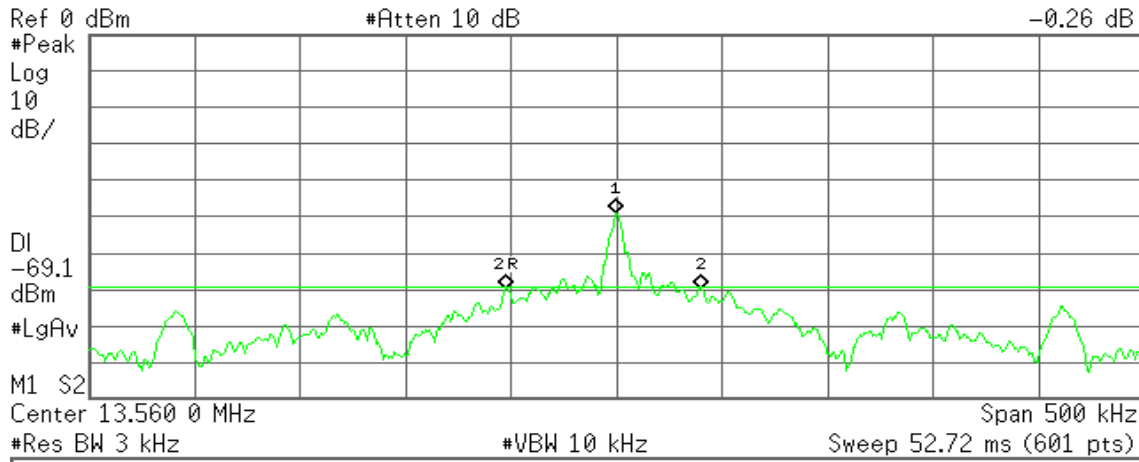

Marker	Trace	Type	X Axis	Amplitude
1	(1)	Freq	13.560 0 MHz	-49.12 dBm
2R	(1)	Freq	13.507 1 MHz	-69.53 dBm
2Δ	(1)	Freq	93.1 kHz	-0.26 dB



## 7.2 RADIATED EMISSIONS

### LIMIT

According to §15.225,

- (a) The field strength of any emissions within the band 13.553 – 13.567 MHz shall not exceed 15,848 microvolts / meter at 30 meters.
- (b) Within the bands 13.410 – 13.553 MHz and 13.567 -13.710 MHz, the field strength of any emissions shall not exceed 334 microvolts / meter at 30 meters.
- (c) Within the bands 13.110 – 13.410 MHz and 13.710 – 14.010 MHz the field strength of any emissions shall not exceed 106 microvolts / meter at 30 meters.
- (d) The field strength of any emissions appearing outside of the 13.110 – 14.010 MHz and shall not exceed the general radiated emission limits in §15.209.

According to §15.225(a), except as provided elsewhere in this Subpart, the emissions from an intentional radiator shall not exceed the field strength levels specified in the following table:

Frequency (MHz)	Field Strength ( $\mu\text{V}/\text{m}$ at meter)	Measurement Distance (meter)
0.009 – 0.490	2400 / F (kHz)	300
0.490 – 1.705	24000 / F (kHz)	30
1.705 – 30.0	30	30
30 - 88	100**	3
88-216	150**	3
216-960	200**	3
Above 960	500	3

\*\* Except as provided in paragraph (g), fundamental emissions from intentional radiators operating under this Section shall not be located in the frequency bands 54-72 MHz, 76-88 MHz, 174-216 MHz or 470-806 MHz. However, operation within these frequency bands is permitted under other sections of this Part, e.g., Sections 15.231 and 15.241.





### Test Configuration

#### 9kHz ~ 30MHz

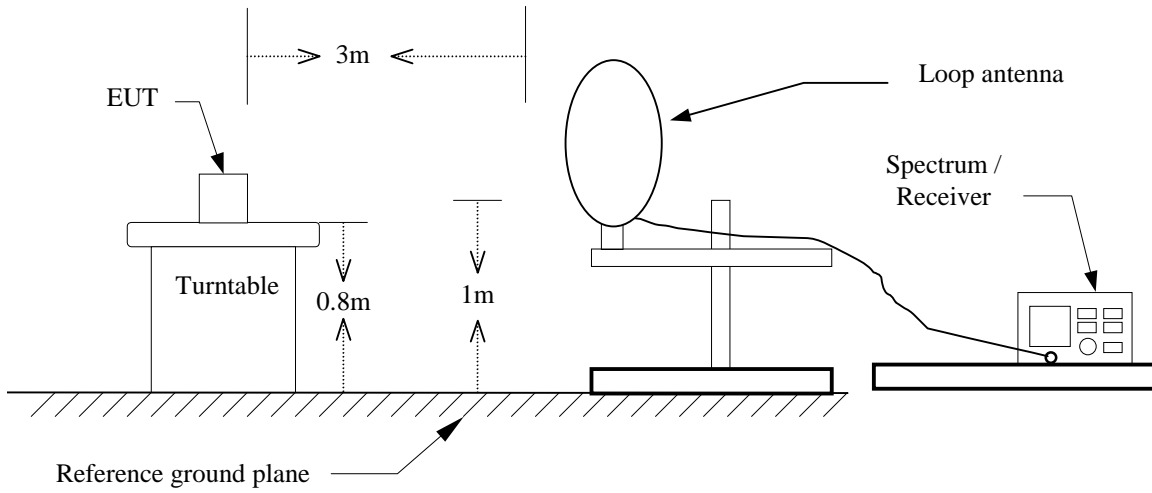

#### 30MHz ~ 1GHz

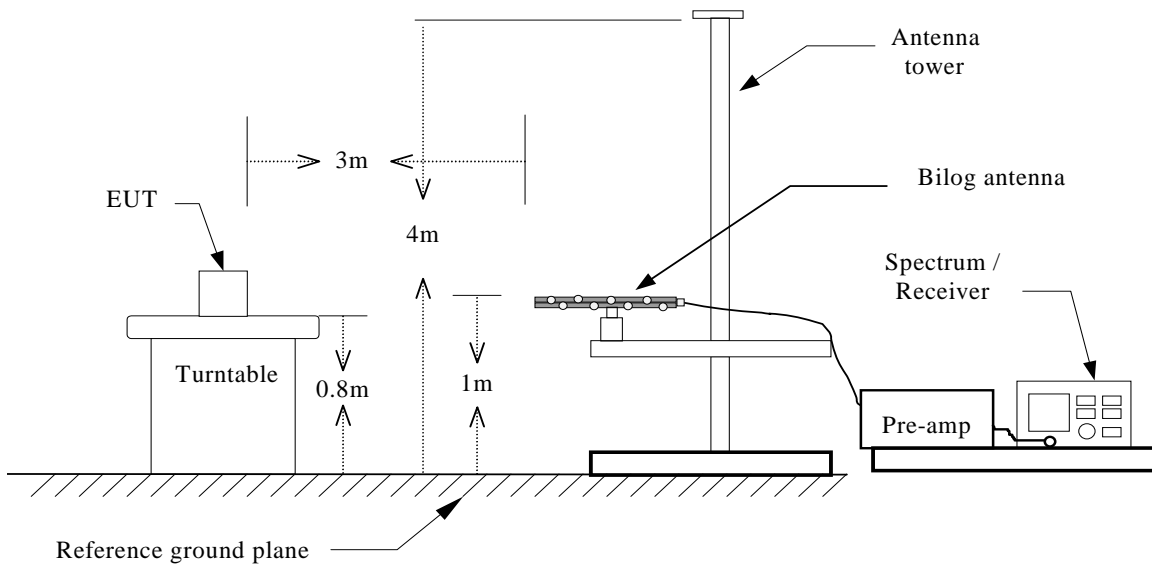



## **TEST PROCEDURE**

### **For 9kHz ~ 30MHz**

1. The EUT is placed on a turntable, which is 0.8m above ground plane.
2. The turntable shall be rotated for 360 degrees to determine the position of maximum emission level.
3. EUT is set 3m away from the receiving antenna, The center of the loop shall be 1 m above the ground then to find out the highest emissions.
4. Maximum procedure was performed on the six highest emissions to ensure EUT compliance.
5. And also, each emission was to be maximized by rotated of receiving antenna axis
6. Set the spectrum analyzer in the following setting as:  
RBW=10kHz / VBW=30kHz / Sweep=AUTO
7. Repeat above procedures until the measurements for all frequencies are complete.

### **For 30MHz ~ 1GHz**

1. The EUT is placed on a turntable, which is 0.8m above ground plane.
2. The turntable shall be rotated for 360 degrees to determine the position of maximum emission level.
3. EUT is set 3m away from the receiving antenna, which is varied from 1m to find out the highest emissions.
4. Maximum procedure was performed on the six highest emissions to ensure EUT compliance.
5. And also, each emission was to be maximized by changing the polarization of receiving antenna both horizontal and vertical.
6. Set the spectrum analyzer in the following setting as:  
RBW=100kHz / VBW=300kHz / Sweep=AUTO
7. Repeat above procedures until the measurements for all frequencies are complete.

**9kHz ~ 30MHz**

**Operation Mode:** TX mode                      **Test Date:** December 19, 2012  
**Temperature:** 27°C                              **Tested by:** Shawn Wu  
**Humidity:** 53 % RH                              **Polarity:** Ver. / Hor.

Frequency (MHz)	Ant.Pol. (H/V)	Detector Mode (PK/QP/AVG)	Reading (dBuV)	Correction Factor (dB/m)	Result (dBuV/m)	Limit 3m (dBuV/m)	Margin (dB)
0.0956	V	peak	50.62	37.54	88.16	122.26	-34.10
0.1445	V	peak	47.03	33.93	80.96	118.73	-37.77
0.2070	V	peak	43.27	31.65	74.92	114.22	-39.30
0.2511	V	peak	43.26	30.17	73.43	111.04	-37.61
0.2727	V	peak	42.30	29.78	72.08	109.48	-37.40
0.3521	V	peak	39.08	28.33	67.41	103.75	-36.34
1.2277	V	peak	32.80	17.66	50.46	67.22	-16.76
3.6377	V	peak	23.42	9.25	32.67	69.50	-36.83
6.6379	V	peak	25.91	6.97	32.88	69.50	-36.62
8.4085	V	peak	19.65	6.56	26.21	69.50	-43.29
17.5074	V	peak	9.49	5.47	14.96	69.50	-54.54
22.9176	V	peak	21.38	5.44	26.82	69.50	-42.68
0.2166	H	Peak	44.08	31.32	75.40	113.53	-38.13
0.2583	H	Peak	44.35	30.04	74.39	110.52	-36.13
0.2824	H	Peak	40.77	29.60	70.37	108.78	-38.41
0.3393	H	Peak	40.02	28.57	68.59	104.67	-36.08
0.3673	H	Peak	40.13	28.06	68.19	102.65	-34.46
0.3986	H	Peak	39.90	27.49	67.39	100.40	-33.01
1.2277	H	Peak	36.70	17.66	54.36	67.22	-12.86
3.6869	H	Peak	23.60	9.17	32.77	69.50	-36.73
6.5887	H	Peak	23.95	6.98	30.93	69.50	-38.57
7.5232	H	Peak	21.69	6.76	28.45	69.50	-41.05
12.4907	H	Peak	16.01	5.87	21.88	69.50	-47.62
22.1307	H	Peak	17.05	5.43	22.48	69.50	-47.02

**Remark:**

1. Measuring frequencies from 9kHz to the 1GHz.
2. Radiated emissions measured were made with an instrument using peak/quasi-peak/average detector mode.
3. Measurements above show only up to 6 maximum emissions noted, or would be lesser, with " N/A " remark, if no specific emissions from the EUT are recorded (ie: margin>20dB from the applicable limit) and considered that's already beyond the background noise floor.
4. Margin (dB) = Result (dBuV/m) – Limit (dBuV/m).

**30MHz ~ 1GHz**

**Operation Mode:** TX mode                      **Test Date:** December 19, 2012  
**Temperature:** 27°C                              **Tested by:** Shawn Wu  
**Humidity:** 53 % RH                              **Polarity:** Ver. / Hor.

Frequency (MHz)	Ant.Pol. (H/V)	Detector Mode (PK/QP/AVG)	Reading (dBuV)	Correction Factor (dB/m)	Result (dBuV/m)	Limit 3m (dBuV/m)	Margin (dB)
13.56	V	QP	40.48	5.73	46.21	124.00	-77.79
41.3167	V	peak	61.83	-28.78	33.05	40.00	-6.95
280.5833	V	peak	56.84	-28.03	28.81	46.00	-17.19
419.6167	V	peak	56.22	-25.01	31.21	46.00	-14.79
560.2667	V	peak	49.02	-22.72	26.30	46.00	-19.70
629.7833	V	peak	54.72	-21.42	33.30	46.00	-12.70
799.5333	V	peak	53.99	-19.04	34.95	46.00	-11.05
13.56	H	QP	36.72	5.73	42.45	124.00	-81.55
209.4500	H	Peak	59.68	-29.36	30.32	43.50	-13.18
249.8667	H	Peak	62.10	-29.65	32.45	46.00	-13.55
379.2000	H	Peak	55.69	-25.96	29.73	46.00	-16.27
419.6167	H	Peak	51.97	-25.01	26.96	46.00	-19.04
629.7833	H	Peak	49.70	-21.42	28.28	46.00	-17.72
799.5333	H	Peak	52.04	-19.04	33.00	46.00	-13.00

**Remark:**

1. Measuring frequencies from 9kHz to the 1GHz.
2. Radiated emissions measured were made with an instrument using peak/quasi-peak/average detector mode.
3. Measurements above show only up to 6 maximum emissions noted, or would be lesser; with " N/A " remark, if no specific emissions from the EUT are recorded (ie: margin > 20dB from the applicable limit) and considered that's already beyond the background noise floor.
4. Margin (dB) = Result (dBuV/m) – Limit (dBuV/m).



## 7.3 FREQUENCY STABILITY

### LIMIT

According to §15.225(e), the frequency tolerance of the carrier signal shall be maintained within +/- 0.01% of the operating frequency over a temperature variation of -20 degrees to +50 degrees C at normal supply voltage, and for a variation in the primary supply voltage from 85% to 115% of the rated supply voltage at a temperature of 20 degrees C. For battery operated equipment, the equipment tests shall be performed using a new battery.

### Test Configuration

**Temperature and Voltage Measurement (under normal and extreme test conditions)**

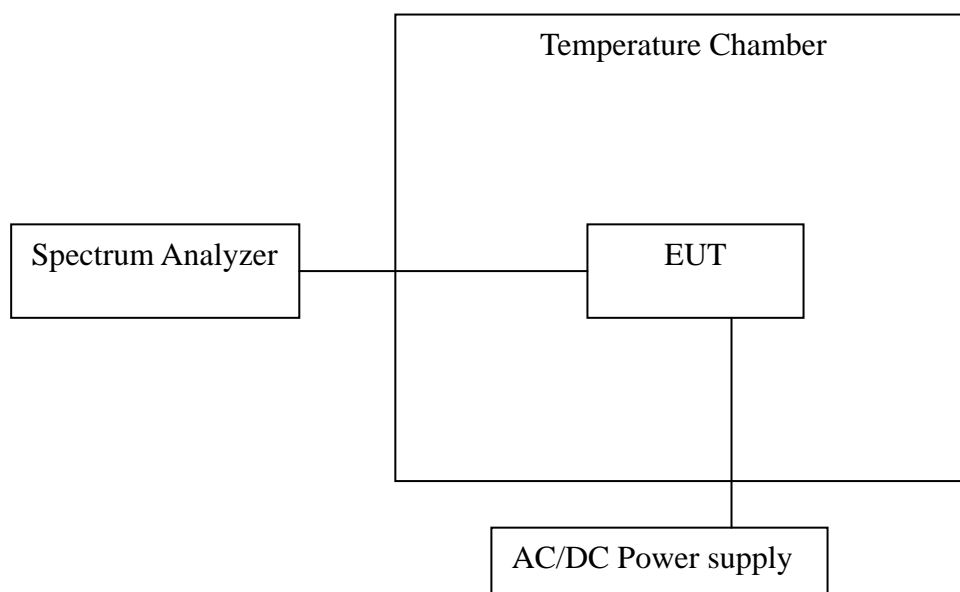

### TEST PROCEDURE

1. Place the EUT on the table and set it in the transmitting mode.
2. Remove the antenna from the EUT and then connect a low loss RF cable from the antenna port to the spectrum analyzer.
3. Set the environment into appropriate environment.
4. Set the spectrum analyzer as RBW=1kHz, VBW = RBW, Span = 200kHz, Sweep = auto.
5. Mark the peak frequency and measure the frequency tolerance using frequency counter function.
6. Repeat until all the results are investigated.



## TEST RESULTS

*No non-compliance noted.*

### Temperature Variations

Temp. (°C)	Voltage (V)	Measured Frequency (MHz)	Delta Frequency (Hz)	Tolerance (%)	Limit (±%)	Margin (%)	Result (Pass/Fail)
-20	110	13.56120	1200	0.00885	0.01	-0.00115	Pass
-10		13.56123	1231	0.00908	0.01	-0.00092	Pass
0		13.56121	1210	0.00892	0.01	-0.00108	Pass
10		13.56120	1200	0.00885	0.01	-0.00115	Pass
20		13.56122	1220	0.00900	0.01	-0.00100	Pass
30		13.56125	1250	0.00922	0.01	-0.00078	Pass
40		13.56126	1260	0.00929	0.01	-0.00071	Pass
50		13.56125	1250	0.00922	0.01	-0.00078	Pass

### Voltage Variations

Temp. (°C)	Voltage (V)	Measured Frequency (MHz)	Delta Frequency (Hz)	Tolerance (%)	Limit (±%)	Margin (%)	Result (Pass/Fail)
20	99	13.56124	1240	0.00914	0.01	-0.00086	Pass
	110	13.56125	1250	0.00922	0.01	-0.00078	Pass
	121	13.56125	1250	0.00922	0.01	-0.00078	Pass



## 7.4 POWERLINE CONDUCTED EMISSIONS

### LIMIT

According to §15.207(a), except as shown in paragraphs (b) and (c) of this section, for an intentional radiator that is designed to be connected to the public utility (AC) power line, the radio frequency voltage that is conducted back onto the AC power line on any frequency or frequencies within the band 150 kHz to 30 MHz shall not exceed the limits in the following table, as measured using a 50  $\mu$ H/50 ohms line impedance stabilization network (LISN). Compliance with the provisions of this paragraph shall be based on the measurement of the radio frequency voltage between each power line and ground at the power terminal. The lower limit applies at the boundary between the frequency ranges.

Frequency Range (MHz)	Limits (dB $\mu$ V)	
	Quasi-peak	Average
0.15 to 0.50	66 to 56*	56 to 46*
0.50 to 5	56	46
5 to 30	60	50

\* Decreases with the logarithm of the frequency.

### TEST PROCEDURE

1. The EUT was placed on a table, which is 0.8m above ground plane.
2. Maximum procedure was performed on the six highest emissions to ensure EUT compliance.
3. Repeat above procedures until all frequency measured were complete.

**TEST RESULTS**

The initial step in collecting conducted data is a spectrum analyzer peak scan of the measurement range. Significant peaks are then marked as shown on the following data page, and these signals are then quasi-peaked.

**Operation Mode:** Normal Link                      **Test Date:** December 24, 2012  
**Temperature:** 26°C                                      **Tested by:** Wayne Tsai  
**Humidity:** 60% RH

Freq. (MHz)	QP Reading (dBuV)	AV Reading (dBuV)	Corr. factor (dB)	QP Result (dBuV)	AV Result (dBuV)	QP Limit (dBuV)	AV Limit (dBuV)	QP Margin (dB)	AV Margin (dB)	Note
0.2384	42.40	35.51	0.09	42.49	35.60	62.15	52.15	-19.66	-16.55	L1
0.4804	42.03	34.39	0.10	42.13	34.49	56.33	46.33	-14.20	-11.84	L1
0.5527	43.49	33.28	0.10	43.59	33.38	56.00	46.00	-12.41	-12.62	L1
0.7779	40.13	30.70	0.11	40.24	30.81	56.00	46.00	-15.76	-15.19	L1
1.3646	37.67	31.00	0.12	37.79	31.12	56.00	46.00	-18.21	-14.88	L1
13.5062	32.54	26.13	0.57	33.11	26.70	60.00	50.00	-26.89	-23.30	L1
0.1584	39.11	31.92	0.09	39.20	32.01	65.54	55.55	-26.34	-23.54	L2
0.2362	41.96	33.57	0.09	42.05	33.66	62.23	52.23	-20.18	-18.57	L2
0.4875	43.14	30.73	0.09	43.23	30.82	56.21	46.21	-12.98	-15.39	L2
0.5796	42.26	29.18	0.09	42.35	29.27	56.00	46.00	-13.65	-16.73	L2
0.7918	38.80	32.68	0.10	38.90	32.78	56.00	46.00	-17.10	-13.22	L2
0.9470	38.90	30.89	0.10	39.00	30.99	56.00	46.00	-17.00	-15.01	L2

**Remark:**

1. The measuring frequencies range between 0.15 MHz and 30 MHz.
2. The emissions measured in the frequency range between 0.15 MHz and 30MHz were made with an instrument using Quasi-peak detector and Average detector.
3. The IF bandwidth of SPA between 0.15MHz and 30MHz was 10kHz. The IF bandwidth of Test Receiver between 0.15MHz and 30MHz was 9kHz.
4. L1 = Line One (Live Line) / L2 = Line Two (Neutral Line)
5. "-" means Quasi-peak reading value also meets average limit and measurement with the average detector is unnecessary.





### Test Plots

#### Conducted emissions (Line 1)

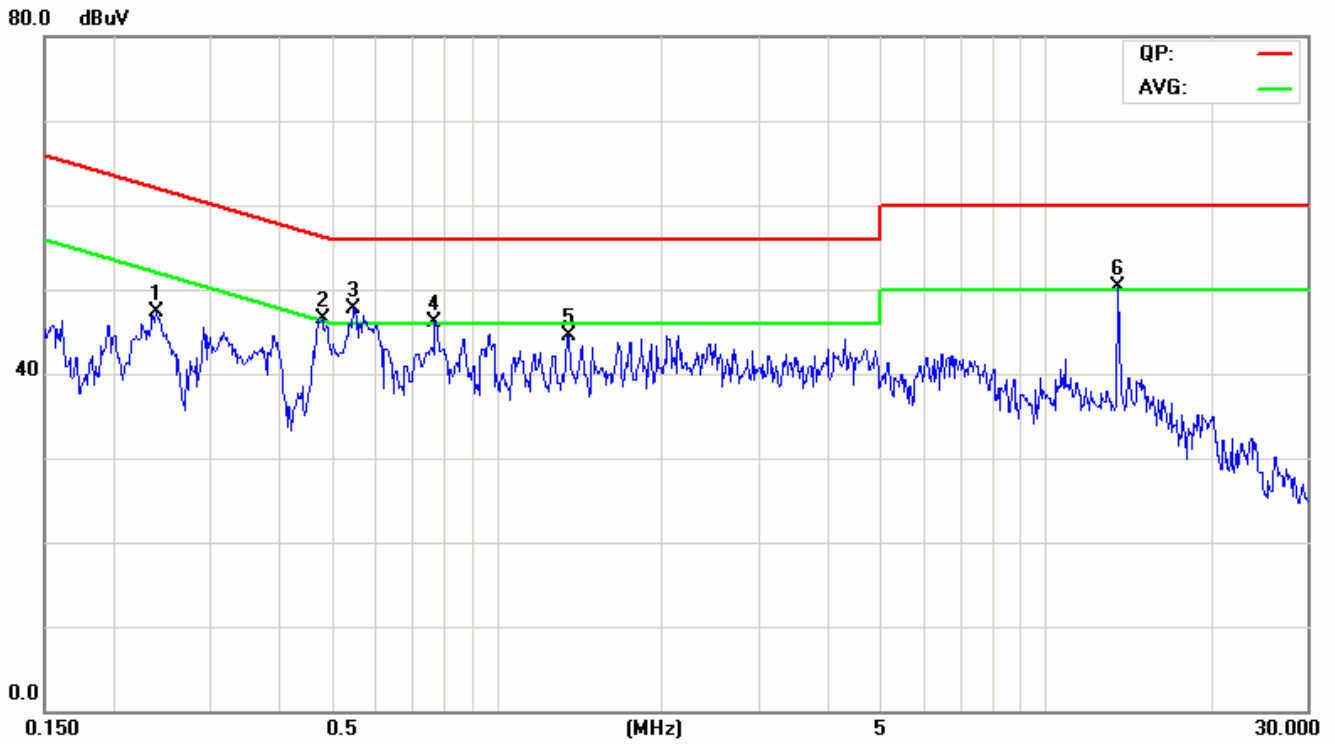

#### Conducted emissions (Line 2)

