

# FCC Radio Test Report

## FCC ID: E2K-APL260AE

This report concerns (check one):  Original Grant  Class II Change

**Project No.** : 1410025D  
**Equipment** : Access Point  
**Model Name** : APL26-0AE  
**Applicant** : Dell Inc.  
**Address** : One Dell Way Round Rock, Texas 78682 United States

**Date of Receipt** : Nov. 06, 2015  
**Date of Test** : Nov. 06, 2015 ~ Dec. 07, 2015  
**Issued Date** : Dec. 08, 2015  
**Tested by** : BTL Inc.

**Testing Engineer**

:   
(Josh Lin)

**Technical Manager**

:   
(Jeff Yang)

**Authorized Signatory**

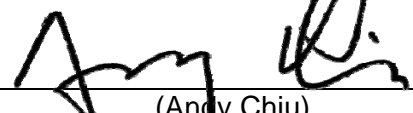
:   
(Andy Chiu)

# **B T L I N C .**

B1, No.37, Lane 365, Yang Guang St.,  
Nei-Hu District, Taipei City 114, Taiwan.  
TEL: +886-2-2657-3299 FAX: +886-2-2657-3331

### **Declaration**

**BTL** represents to the client that testing is done in accordance with standard procedures as applicable and that test instruments used has been calibrated with the standards traceable to National Measurement Laboratory (**NML**) of **R.O.C.**, or National Institute of Standards and Technology (**NIST**) of **U.S.A.**

**BTL's** reports apply only to the specific samples tested under conditions. It is manufacture's responsibility to ensure that additional production units of this model are manufactured with the identical electrical and mechanical components. **BTL** shall have no liability for any declarations, inferences or generalizations drawn by the client or others from **BTL** issued reports.

**BTL's** report must not be used by the client to claim product certification, approval, or endorsement by NVLAP, NIST, or any agency of the Federal Government.

This report is the confidential property of the client. As a mutual protection to the clients, the public and **BTL-self**, extracts from the test report shall not be reproduced except in full with **BTL's** authorized written approval.

**BTL's** laboratory quality assurance procedures are in compliance with the **ISO Guide17025** requirements, and accredited by the conformity assessment authorities listed in this test report.

### **Limitation**

For the use of the authority's logo is limited unless the Test Standard(s)/Scope(s)/Item(s) mentioned in this test report is (are) included in the conformity assessment authorities acceptance respective.

<b>Table of Contents</b>	<b>Page</b>
<b>1 . CERTIFICATION</b>	<b>5</b>
<b>2 . EUT INFORMATION</b>	<b>6</b>
2.1 EUT SPECIFICATION TABLE	6
2.2 DESCRIPTION OF AVAILABLE ANTENNAS TO THE EUT	6
2.3 CONDUCTED OUTPUT POWER AND EIRP POWER	7
2.4 EUT MAXIMUM AND MINIMUM E.I.R.P. POWER	8
<b>3 .U-NII DFS RULE REQUIREMENTS</b>	<b>9</b>
3.1 WORKING MODES AND REQUIRED TEST ITEMS	9
3.2 TEST LIMITS AND RADAR SIGNAL PARAMETERS	10
<b>4 . TEST INSTRUMENTS</b>	<b>13</b>
<b>5 .EMC EMISSION TEST</b>	<b>14</b>
5.1 DFS MEASUREMENT SYSTEM:	14
5.2 CALIBRATION OF DFS DETECTION THRESHOLD LEVEL:	16
5.3 DEVIATION FROM TEST STANDARD	16
<b>6 . TEST RESULTS</b>	<b>17</b>
6.1 SUMMARY OF TEST RESULT	17
6.2 TEST MODE: DEVICE OPERATING IN MASTER MODE.	17
6.3 DFS DETECTION THRESHOLD	17
6.4 CHANNEL AVAILABILITY CHECK TIME	29
6.5 CHANNEL CLOSING TRANSMISSION AND CHANNEL MOVE TIME WLAN TRAFFIC	38
6.6 STATISTICAL PERFORMANCE CHECK	41
6.7 NON- OCCUPANCY PERIOD	44
6.8 UNIFORM SPREADING	46
6.9 U-NII DETECTION BANDWIDTH	46
<b>7 . EUT TEST PHOTO</b>	<b>52</b>

### REPORT ISSUED HISTORY

Issued No.	Description	Issued Date
BTL-FCCP-2-1410025A	Original Report.	Jan. 21, 2015
BTL-FCCP-1-1410025D	Compared with previous report (BTL-FCCP-2-1410025A), The standards are updated to the latest .All test item has been retested and recored in this report.	Dec. 08, 2015

## 1. CERTIFICATION

Equipment : Access Point  
Brand Name : DELL  
Model Name : APL26-0AE  
Applicant : Dell Inc.  
Date of Test: : Nov. 06, 2015 ~ Dec. 07, 2015  
Test Sample : Engineering Sample  
Standard(s) : FCC Part 15, Subpart E (Section 15.407)  
FCC KDB 789033 D02 General UNII Test Procedures New Rules v01  
905462 D02 UNII DFS Compliance Procedures New Rules v01r02

The above equipment has been tested and found compliance with the requirement of the relative standards by BTL Inc.

The test data, data evaluation, and equipment configuration contained in our test report (Ref No. BTL-FCCP-1-1410025D) were obtained utilizing the test procedures, test instruments, test sites that has been accredited by the Authority of TAF according to the ISO-17025 quality assessment standard and technical standard(s).

**Test result included in this report is only for the DFS Mode part of the product.**

## 2. EUT INFORMATION

### 2.1 EUT SPECIFICATION TABLE



Table 1: Specification of EUT

<b>Product name</b>	Access Point
<b>Brand Name</b>	DELL
<b>Model</b>	APL26-0AE
<b>Operational Mode</b>	Master
<b>Operating Frequency Range</b>	5260~5320MHz&5500~5700MHz
<b>Modulation</b>	OFDM

**Note:** This device was functioned as a  Master  Slave device during the DF

### 2.2 DESCRIPTION OF AVAILABLE ANTENNAS TO THE EUT

Antenna Specification:

Ant.	Brand	Part NO.	Antenna Type	Connector	Gain (dBi)	Note
4		C147-510905B	Dipole	Reversed TNC	5.89	TX/RX
5		C147-510905B	Dipole	Reversed TNC	5.89	TX/RX
6		C147-510905B	Dipole	Reversed TNC	5.89	TX/RX

Note:

1. The EUT incorporates a MIMO function. Physically, the EUT provides three completed transmitters and receivers (3T3R). All transmit signals are completely uncorrelated, then, Direction gain =  $G_{ANT}$ , that is Directional gain=5.89

## 2.3 CONDUCTED OUTPUT POWER AND EIRP POWER

TABLE 3: THE CONDUCTED OUTPUT POWER LIST

TX (11a)

FREQUENCY BAND (MHz)	MAX. POWER	
	OUTPUT POWER(dBm)	OUTPUT POWER(mW)
5260~5320	19.33	85.70
5500~5700	18.66	73.45

TX (11n 40MHz)

FREQUENCY BAND (MHz)	MAX. POWER	
	OUTPUT POWER(dBm)	OUTPUT POWER(mW)
5270~5310	20.21	104.95
5510~5670	18.05	63.83

TX (11ac 80 MHz)

FREQUENCY BAND (MHz)	MAX. POWER	
	OUTPUT POWER(dBm)	OUTPUT POWER(mW)
5290	21.39	137.72
5530	18.59	72.28

## 2.4 EUT MAXIMUM AND MINIMUM E.I.R.P. POWER

TABLE 4: THE MAX EIRP LIST

TX (11a)

FREQUENCY BAND (MHz)	MAX. POWER	
	OUTPUT POWER(dBm)	OUTPUT POWER(mW)
5260~5320	25.22	332.66
5500~5700	24.55	285.10

TX (11n40MHz)

FREQUENCY BAND (MHz)	MAX. POWER	
	OUTPUT POWER(dBm)	OUTPUT POWER(mW)
5270~5310	26.10	407.38
5510~5670	23.94	247.74

TX (11ac 80 MHz)

FREQUENCY BAND (MHz)	MAX. POWER	
	OUTPUT POWER(dBm)	OUTPUT POWER(mW)
5290	27.28	534.56
5530	24.48	280.54



### 3.U-NII DFS RULE REQUIREMENTS

#### 3.1 WORKING MODES AND REQUIRED TEST ITEMS

The manufacturer shall state whether the UUT is capable of operating as a Master and/or a Client. If the UUT is capable of operating in more than one operating mode then each operating mode shall be tested separately. See tables 1 and 2 for the applicability of DFS requirements for each of the operational modes.

Table 5: Applicability of DFS requirements prior to use a channel

Requirement	Operational Mode		
	Master	Client without radar detection	Client with radar detection
Non-Occupancy Period	✓	Not required	✓
DFS Detection Threshold	✓	Not required	✓
Channel Availability Check Time	✓	Not required	Not required
Uniform Spreading	✓	Not required	Not required
U-NII Detection Bandwidth	✓	Not required	✓

Table 6: Applicability of DFS requirements during normal operation.

Requirement	Operational Mode		
	Master	Client without radar detection	Client with radar detection
DFS Detection Threshold	✓	Not required	✓
Channel Closing Transmission Time	✓	✓	✓
Channel Move Time	✓	✓	✓
U-NII Detection Bandwidth	✓	Not required	✓

### 3.2 TEST LIMITS AND RADAR SIGNAL PARAMETERS

#### DETECTION THRESHOLD VALUES

Table 7: DFS Detection Thresholds for Master Devices and Client Devices With Radar Detection.

Maximum Transmit Power	Value (See Notes 1 and 2)
EIRP $\geq$ 200 milliwatt	-64 dBm
EIRP < 200 milliwatt and power spectral density < 10 dBm/MHz	-62 dBm
EIRP < 200 milliwatt that do not meet the power spectral density requirement	-64 dBm

**Note 1:** This is the level at the input of the receiver assuming a 0 dBi receive antenna.

**Note 2:** Throughout these test procedures an additional 1 dB has been added to the amplitude of the test transmission waveforms to account for variations in measurement equipment. This will ensure that the test signal is at or above the detection threshold level to trigger a DFS response.

**Note3:** EIRP is based on the highest antenna gain. For MIMO devices refer to KDB Publication 662911 D01.

Table 8: DFS Response Requirement Values

Parameter	Value
Non-occupancy period	Minimum 30 minutes
Channel Availability Check Time	60 seconds
Channel Move Time	10 seconds See Note 1.
Channel Closing Transmission Time	200 milliseconds + an aggregate of 60 milliseconds over remaining 10 second period. See Notes 1 and 2.
U-NII Detection Bandwidth	Minimum 100% of the UNII 99% transmission power bandwidth. See Note 3.

**Note 1:** Channel Move Time and the Channel Closing Transmission Time should be performed with Radar Type 0. The measurement timing begins at the end of the Radar Type 0 burst.

**Note 2:** The Channel Closing Transmission Time is comprised of 200 milliseconds starting at the beginning of the Channel Move Time plus any additional intermittent control signals required to facilitate a Channel move (an aggregate of 60 milliseconds) during the remainder of the 10 second period. The aggregate duration of control signals will not count quiet periods in between transmissions.

**Note 3:** During the U-NII Detection Bandwidth detection test, radar type 0 should be used. For each frequency step the minimum percentage of detection is 90 percent. Measurements are performed with no data traffic.

## PARAMETERS OF DFS TEST SIGNALS

Step intervals of 0.1 microsecond for Pulse Width, 1 microsecond for PRI, 1 MHz for chirp width and 1 for the number of pulses will be utilized for the random determination of specific test waveforms.

Table 9: Short Pulse Radar Test Waveforms.

Radar Type	Pulse Width (μsec)	PRI (μsec)	Number of Pulses	Minimum Percentage of Successful Detection	Minimum Number of Trials
0	1	1428	18	See Note 1	See Note 1
1	1	Test A: 15 unique PRI values randomly selected from the list of 23 PRI values in Table 5a	Roundup $\left\{ \begin{array}{l} \left( \frac{1}{360} \right) \\ \left( \frac{19 \cdot 10^6}{\text{PRI}_{\mu\text{sec}}} \right) \end{array} \right\}$	60%	30
		Test B: 15 unique PRI values randomly selected within the range of 518-3066 μsec, with a minimum increment of 1 μsec, excluding PRI values selected in Test A			
2	1-5	150-230	23-29	60%	30
3	6-10	200-500	16-18	60%	30
4	11-20	200-500	12-16	60%	30
Aggregate (Radar Types 1-4)				80%	120
<b>Note 1:</b> Short Pulse Radar Type 0 should be used for the detection bandwidth test, channel move time, and channel closing time tests.					

A minimum of 30 unique waveforms are required for each of the Short Pulse Radar Types 2 through 4. If more than 30 waveforms are used for Short Pulse Radar Types 2 through 4, then each additional waveform must also be unique and not repeated from the previous waveforms. If more than 30 waveforms are used for Short Pulse Radar Type 1, then each additional waveform is generated with Test B and must also be unique and not repeated from the previous waveforms in Tests A or B.

Table 10: Long Pulse Radar Test Waveform

Radar Type	Pulse Width (μsec)	Chirp Width (MHz)	PRI (μsec)	Number of Pulses per Burst	Number of Bursts	Minimum Percentage of Successful Detection	Minimum Number of Trials
5	50-100	5-20	1000-2000	1-3	8-20	80%	30

The parameters for this waveform are randomly chosen (The center frequency for each of the 30 trials of the Bin 5 radar shall be randomly selected within 80% of the Occupied Bandwidth.) Thirty unique waveforms are required for the Long Pulse Radar Type waveforms. If more than 30 waveforms are used for the Long Pulse Radar Type waveforms, then each additional waveform must also be unique and not repeated from the previous waveforms.

Table 11: Frequency Hopping Radar Test Waveform

Radar Type	Pulse Width (μsec)	Chirp Width (MHz)	PRI (μsec)	Number of Pulses per Burst	Number of Bursts	Minimum Percentage of Successful Detection	Minimum Number of Trials
6	1	333	9	0.333	300	70%	30

#### 4. TEST INSTRUMENTS

Table 1: Test instruments list.

DESCRIPTION	MANUFACTURER	MODEL NO.	Serial No	Calibration Until
MXG Vector Signal Generator	Agilent	N5182B	MY51350711	May 18, 2016
Spectrum Analyzer	Agilent	N9010A	MY54200240	Aug. 25, 2016
10dB Attenuators	Mini-Circuits	VAT-10+	N/A	May 17, 2016
10dB Attenuators	Mini-Circuits	VAT-10+	N/A	May 17, 2016
30dB Attenuators	Mini-Circuits	VAT-30+	N/A	May 17, 2016
30dB Attenuators	Mini-Circuits	VAT-30+	N/A	May 17, 2016
POWER SPLITTER	Mini-Circuits	ZFRSC-123-S+	N/A	May 17, 2016
POWER SPLITTER	Mini-Circuits	ZFRSC-123-S+	N/A	May 17, 2016

Note: Calibration interval of instruments listed above is one year.

## 5. EMC EMISSION TEST

### 5.1 DFS MEASUREMENT SYSTEM

#### CONDUCTED METHOD SYSTEM BLOCK DIAGRAM

##### Master Conducted Measurement

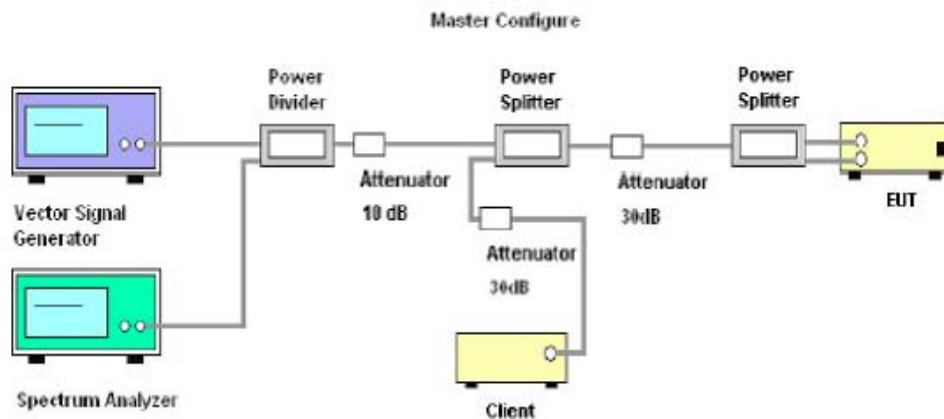

#### SYSTEM OVERVIEW

The short pulse and long pulse signal generating system utilizes the NTIA software. The Vector Signal Generator has been validated by the NTIA. The hopping signal generating system utilizes the CCS simulated hopping method and system, which has been validated by the DoD, FCC and NTIA. The software selects waveform parameters from within the bounds of the signal type on a random basis using uniform distribution.

The short pulse types 2, 3 and 4, and the long pulse type 5 parameters are randomized at run-time.

The hopping type 6 pulse parameters are fixed while the hopping sequence is based on the August 2005 NTIA Hopping Frequency List. The initial starting point randomized at run-time and each subsequent starting point is incremented by 475. Each frequency in the 100-length segment is compared to the boundaries of the EUT Detection Bandwidth and the software creates a hopping burst pattern in accordance with Section 7.4.1.3 Method #2 Simulated Frequency Hopping Radar Waveform Generating Subsystem of FCC 06-96. The frequency of the signal generator is incremented in 1 MHz steps from FL to FH for each successive trial. This incremental sequence is repeated as required to generate a minimum of 30 total trials and to maintain a uniform frequency distribution over the entire Detection Bandwidth.

The signal monitoring equipment consists of a spectrum analyzer set to display 8001 bins on the horizontal axis. The time-domain resolution is 2 msec / bin with a 16 second sweep time, meeting the 10 second short pulse reporting criteria. The aggregate ON time is calculated by multiplying the number of bins above a threshold during a particular observation period by the dwell time per bin, with the analyzer set to peak detection and max hold.

Should multiple RF ports be utilized for the Master and/or Slave devices (for example, for diversity or MIMO implementations), additional combiner/dividers are inserted between the Master Combiner/Divider and the pad connected to the Master Device (and/or between the Slave Combiner/Divider and the pad connected to the Slave Device). Additional pads are utilized such that there is one pad at each RF port on each EUT.

## 5.2 CALIBRATION OF DFS DETECTION THRESHOLD LEVEL

A 50 ohm load is connected in place of the spectrum analyzer, and the spectrum analyzer is connected in place of the master device and the signal generator is set to CW mode. The amplitude of the signal generator is adjusted to yield a level of  $-62$  dBm as measured on the spectrum analyzer.

Without changing any of the instrument settings, the spectrum analyzer is reconnected to the Common port of the Spectrum Analyzer Combiner/Divider. Measure the amplitude and calculate the difference from  $-62$  dBm. Adjust the Reference Level Offset of the spectrum analyzer to this difference.

The spectrum analyzer displays the level of the signal generator as received at the antenna ports of the Master Device. The interference detection threshold may be varied from the calibrated value of  $-62$  dBm and the spectrum analyzer will still indicate the level as received by the Master Device.

Set the signal generator to produce a radar waveform, trigger a burst manually and measure the level on the spectrum analyzer. Readjust the amplitude of the signal generator as required so that the peak level of the waveform is at a displayed level equal to the required or desired interference detection threshold. Separate signal generator amplitude settings are determined as required for each radar type.

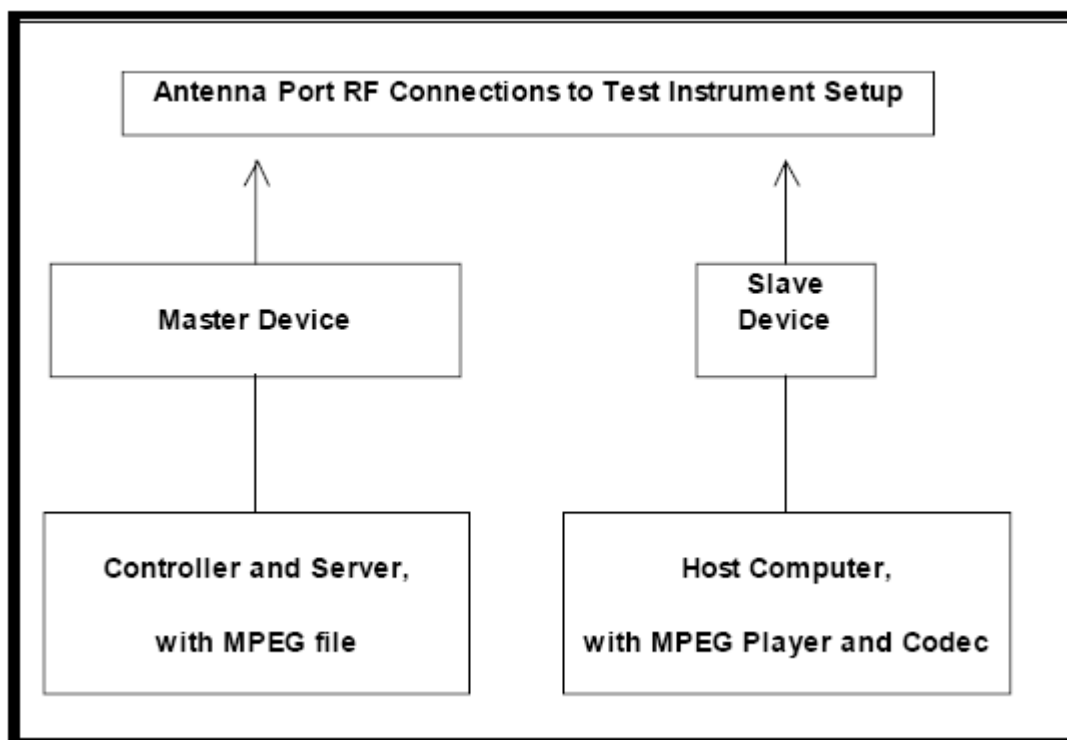

## 5.3 DEVIATION FROM TEST STANDARD

No deviation.



## 6. TEST RESULTS

### 6.1 SUMMARY OF TEST RESULT

Clause	Test Parameter	Remarks	Pass/Fail
15.407	DFS Detection Threshold	Applicable	Pass
15.407	Channel Availability Check Time	Applicable	Pass
15.407	Channel Move Time	Applicable	Pass
15.407	Channel Closing Transmission Time	Applicable	Pass
15.407	Non- Occupancy Period	Applicable	Pass
15.407	Uniform Spreading	Applicable	Pass
15.407	U-NII Detection Bandwidth	Applicable	Pass

### 6.2 TEST MODE: DEVICE OPERATING IN MASTER MODE.

Master with injection at the Master. (Radar Test Waveforms are injected into the Master)

### 6.3 DFS DETECTION THRESHOLD

Calibration:

For a detection threshold level of -64dBm and the Master antenna gain is 5.89dBi, required detection threshold is -58.11 dBm (= -64+5.89).

Note: Maximum Transmit Power is more than 200 milliwatt in this report, so detection threshold level is -64dBm (please refer to Table 7 [page 10]).

### Radar Signal 0

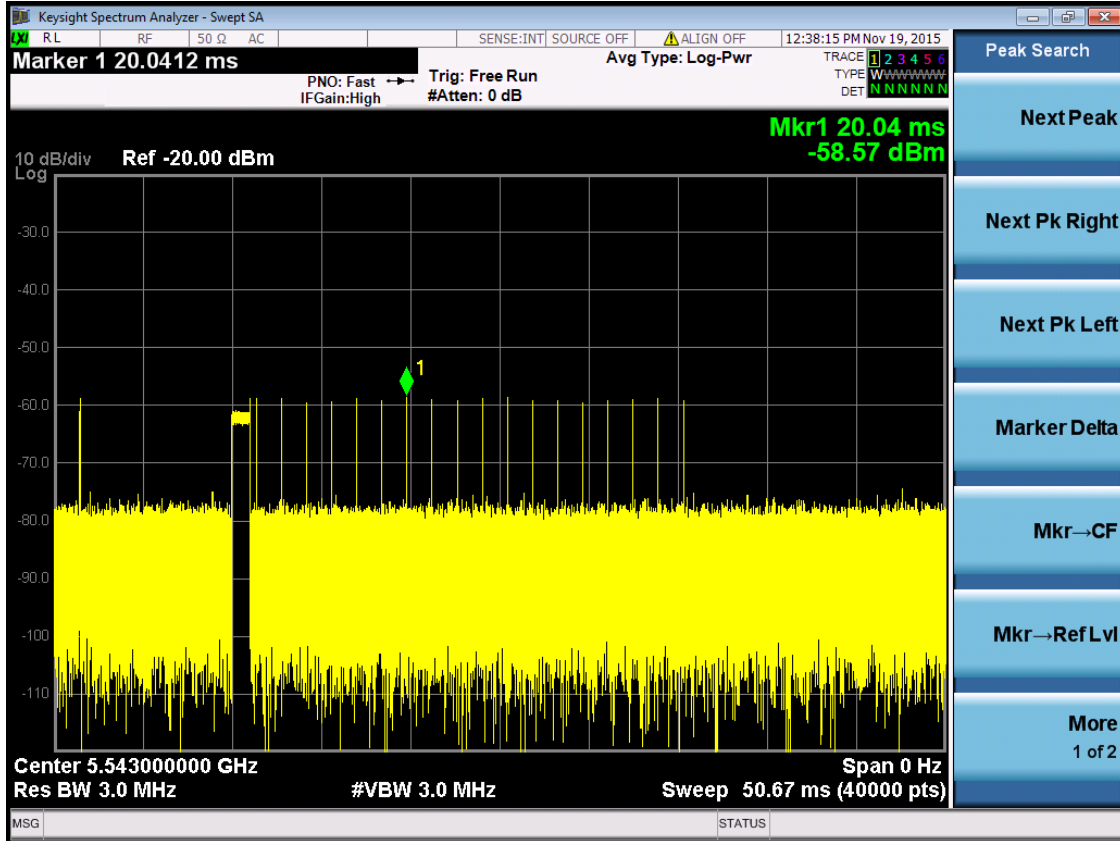

### Radar Signal 1

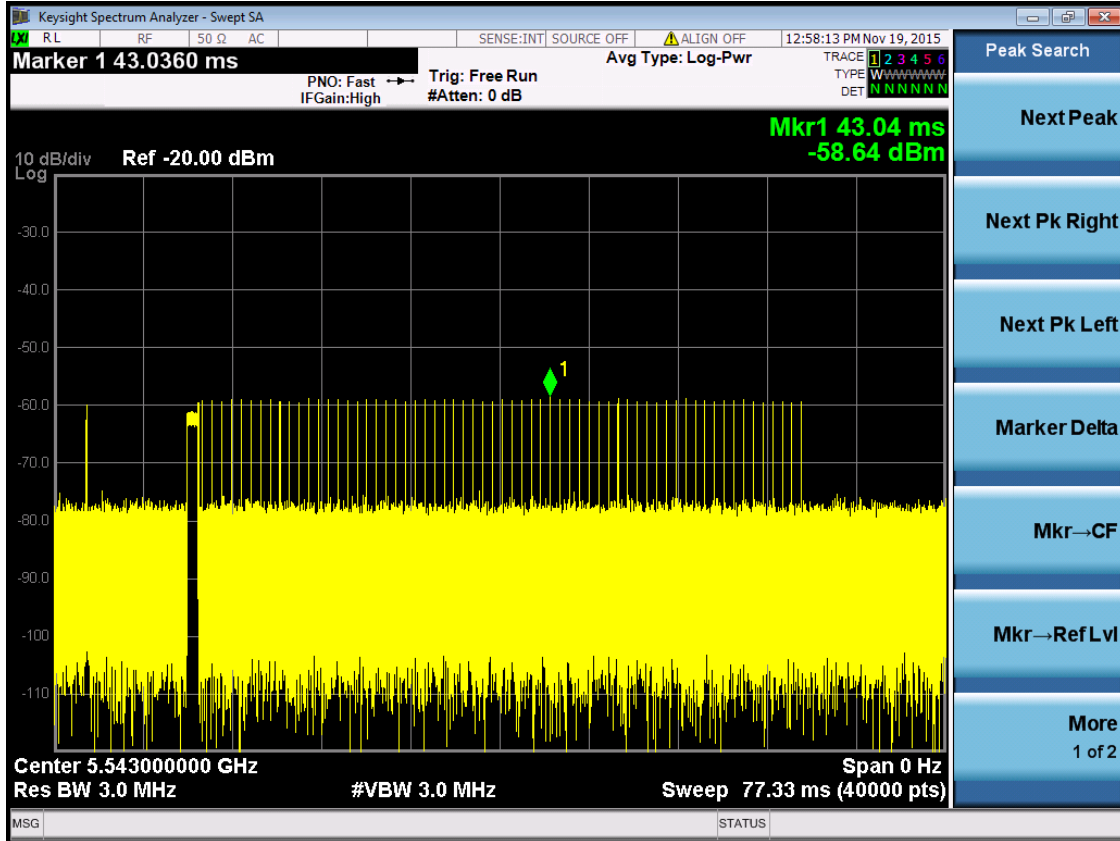

### Radar Signal 2

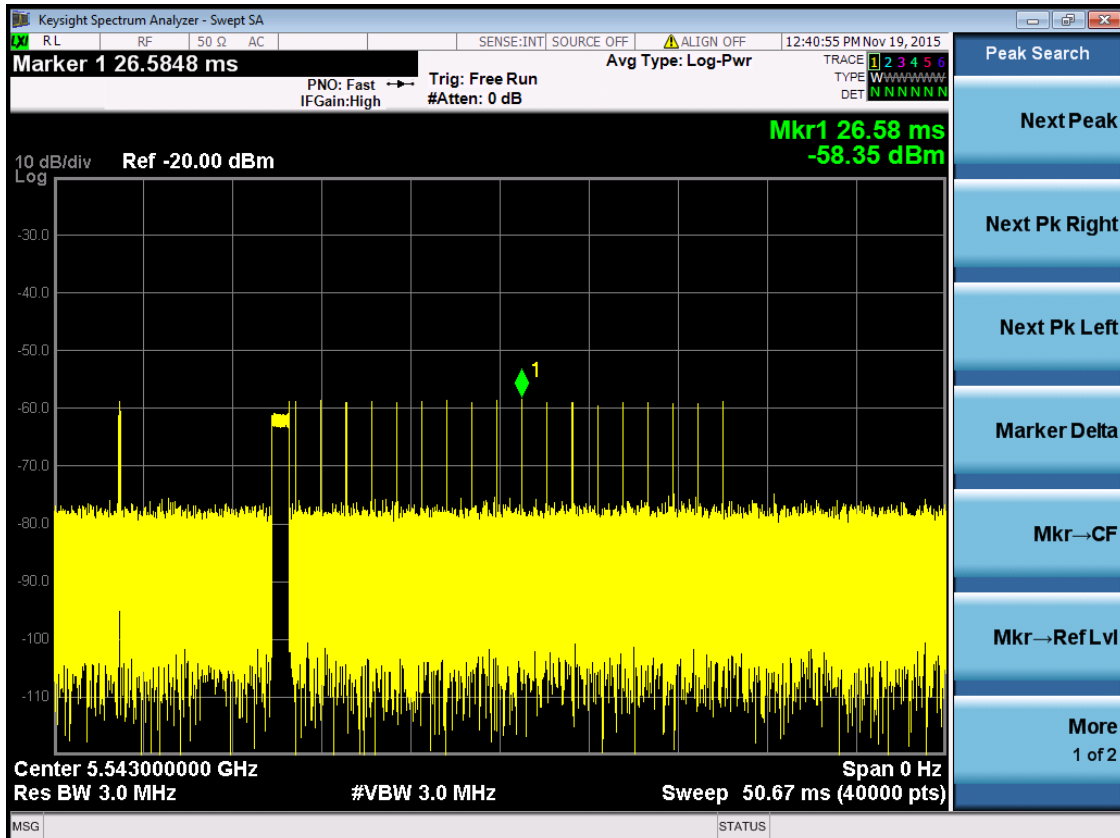

### Radar Signal 3

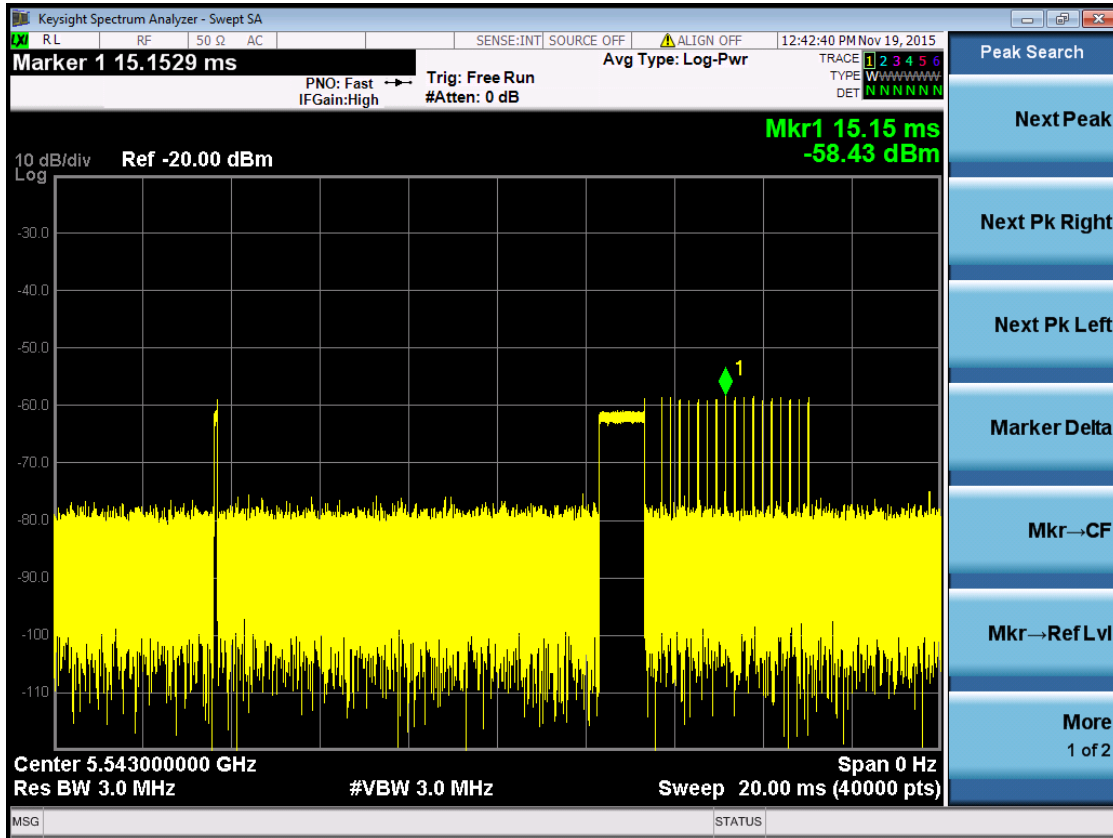

### Radar Signal 4

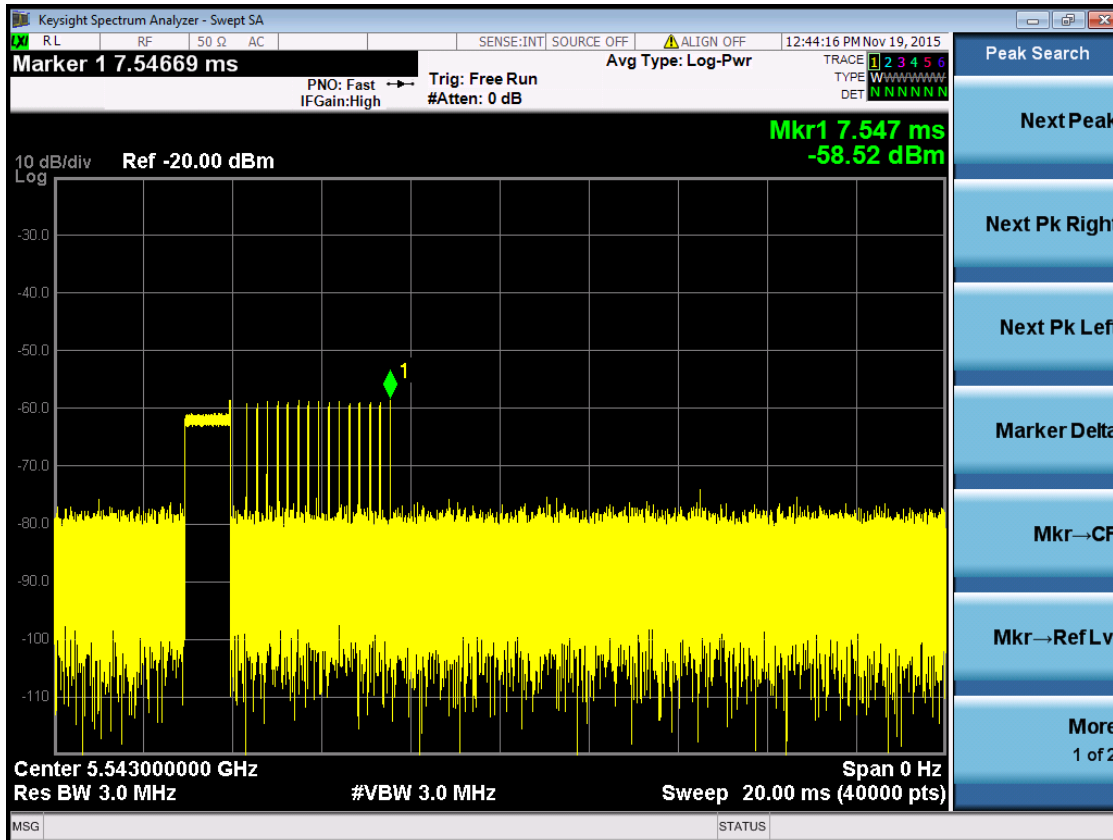

### Radar Signal 5

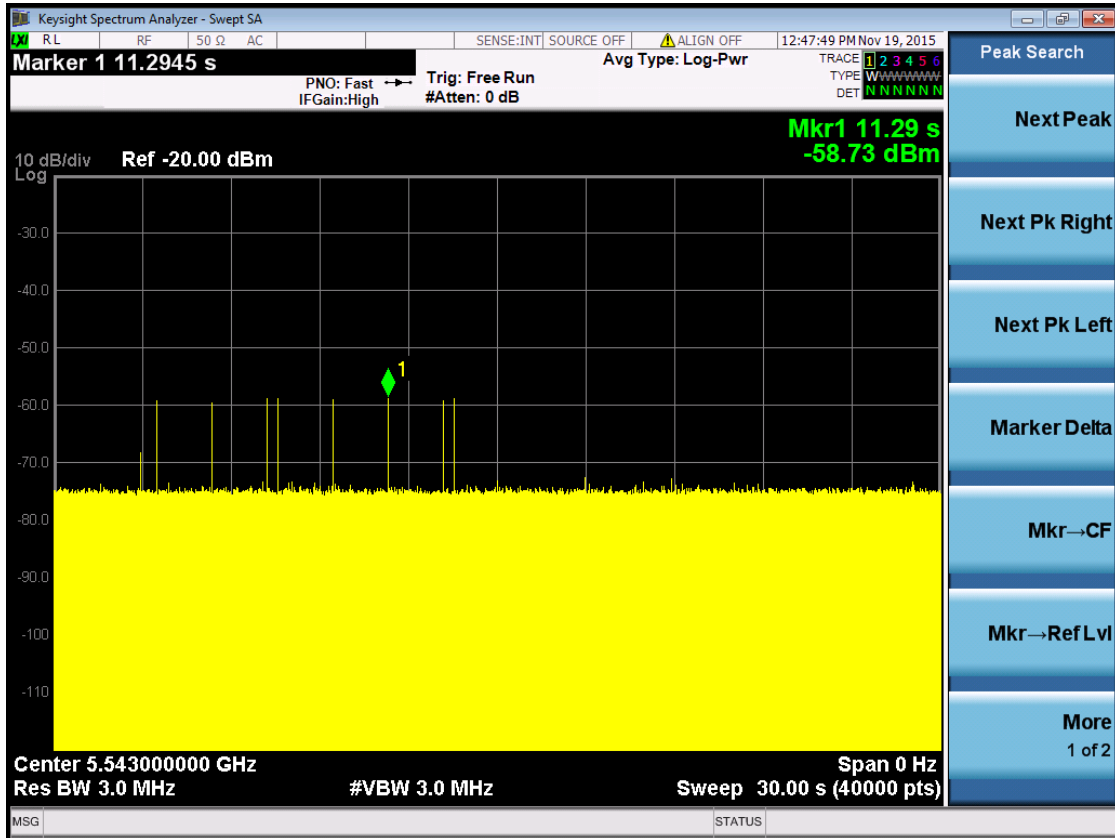

### Radar Signal 6

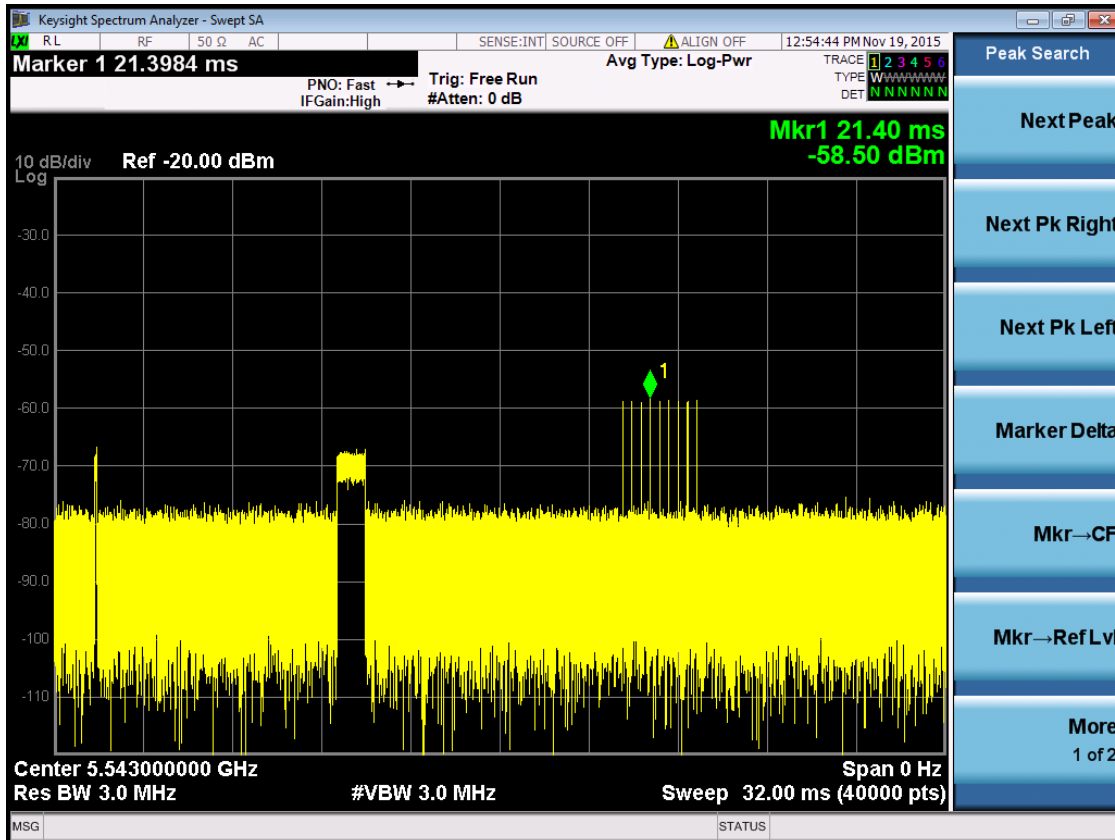

### Radar Signal 0

Trual ID	Radar Typo	Pulse Width (us)	PRI (us)	Number of Pulses	Wavefirm Length (us)
0	Type 0	1	1428	18	25704
1	Type 0	1	1428	18	25704
2	Type 0	1	1428	18	25704
3	Type 0	1	1428	18	25704
4	Type 0	1	1428	18	25704
5	Type 0	1	1428	18	25704
6	Type 0	1	1428	18	25704
7	Type 0	1	1428	18	25704
8	Type 0	1	1428	18	25704
9	Type 0	1	1428	18	25704
10	Type 0	1	1428	18	25704
11	Type 0	1	1428	18	25704
12	Type 0	1	1428	18	25704
13	Type 0	1	1428	18	25704
14	Type 0	1	1428	18	25704
15	Type 0	1	1428	18	25704
16	Type 0	1	1428	18	25704
17	Type 0	1	1428	18	25704
18	Type 0	1	1428	18	25704
19	Type 0	1	1428	18	25704
20	Type 0	1	1428	18	25704
21	Type 0	1	1428	18	25704
22	Type 0	1	1428	18	25704
23	Type 0	1	1428	18	25704
24	Type 0	1	1428	18	25704
25	Type 0	1	1428	18	25704
26	Type 0	1	1428	18	25704
27	Type 0	1	1428	18	25704
28	Type 0	1	1428	18	25704
29	Type 0	1	1428	18	25704

### Radar Signal 1

Trual ID	Radar Typo	Pulse Width (us)	PRI (us)	Number of Pulses	Wavefirm Length (us)
0	Type 1	1	938	57	53466
1	Type 1	1	698	76	53048
2	Type 1	1	618	86	53148
3	Type 1	1	538	99	53262
4	Type 1	1	878	61	53558
5	Type 1	1	3066	18	55188
6	Type 1	1	638	83	52954
7	Type 1	1	918	58	53244
8	Type 1	1	838	63	52794
9	Type 1	1	858	62	53196
10	Type 1	1	798	67	53466
11	Type 1	1	718	74	53132
12	Type 1	1	578	92	53176
13	Type 1	1	598	89	53222
14	Type 1	1	558	95	53010
15	Type 1	1	2536	21	53256
16	Type 1	1	966	55	53130
17	Type 1	1	827	64	52928
18	Type 1	1	2501	22	55022
19	Type 1	1	2595	21	54495
20	Type 1	1	1114	48	53472
21	Type 1	1	1302	41	53382
22	Type 1	1	3045	18	54810
23	Type 1	1	1624	33	53592
24	Type 1	1	2878	19	54682
25	Type 1	1	1027	52	53404
26	Type 1	1	2485	22	54670
27	Type 1	1	1600	33	52800
28	Type 1	1	1172	46	53912
29	Type 1	1	1177	45	52965

### Radar Signal 2

Trual ID	Radar Typo	Pulse Width (us)	PRI (us)	Number of Pulses	Wavefirm Length (us)
0	Type 2	3.2	179	26	4654
1	Type 2	1.1	207	23	4761
2	Type 2	2.1	230	24	5520
3	Type 2	4.8	200	29	5800
4	Type 2	3.9	214	28	5992
5	Type 2	2.9	222	26	5772
6	Type 2	3.2	204	26	5304
7	Type 2	2.5	192	25	4800
8	Type 2	3.1	164	26	4264
9	Type 2	1.2	156	23	3588
10	Type 2	3.9	210	27	5670
11	Type 2	4.6	201	29	5829
12	Type 2	3.2	162	26	4212
13	Type 2	2.2	197	25	4925
14	Type 2	4.5	163	29	4727
15	Type 2	3	203	26	5278
16	Type 2	5	168	29	4872
17	Type 2	2.4	217	25	5425
18	Type 2	2.9	191	26	4966
19	Type 2	2.3	166	25	4150
20	Type 2	3.7	150	27	4050
21	Type 2	2.2	176	25	4400
22	Type 2	4.9	195	29	5655
23	Type 2	2.9	202	26	5252
24	Type 2	2.5	178	25	4450
25	Type 2	1.1	206	23	4738
26	Type 2	3.8	155	27	4185
27	Type 2	4.7	157	29	4553
28	Type 2	2.4	224	25	5600
29	Type 2	4.2	159	28	4452



### Radar Signal 3

Trual ID	Radar Typo	Pulse Width (us)	PRI (us)	Number of Pulses	Wavefirm Length (us)
0	Type 3	8.2	355	17	6035
1	Type 3	6.1	487	16	7792
2	Type 3	7.1	344	16	5504
3	Type 3	9.8	288	18	5184
4	Type 3	8.9	230	18	4140
5	Type 3	7.9	432	17	7344
6	Type 3	8.2	207	17	3519
7	Type 3	7.5	443	17	7531
8	Type 3	8.1	439	17	7463
9	Type 3	6.2	223	16	3568
10	Type 3	8.9	208	18	3744
11	Type 3	9.6	463	18	8334
12	Type 3	8.2	441	17	7497
13	Type 3	7.2	323	16	5168
14	Type 3	9.5	297	18	5346
15	Type 3	8	412	17	7004
16	Type 3	10	324	18	5832
17	Type 3	7.4	271	17	4607
18	Type 3	7.9	349	17	5933
19	Type 3	7.3	409	16	6544
20	Type 3	8.7	373	18	6714
21	Type 3	7.2	254	16	4064
22	Type 3	9.9	274	18	4932
23	Type 3	7.9	278	17	4726
24	Type 3	7.5	317	17	5389
25	Type 3	6.1	260	16	4160
26	Type 3	8.8	211	18	3798
27	Type 3	9.7	272	18	4896
28	Type 3	7.4	264	17	4488
29	Type 3	9.2	284	18	5112

### Radar Signal 4

Trual ID	Radar Typo	Pulse Width (us)	PRI (us)	Number of Pulses	Wavefirm Length (us)
0	Type 4	16	355	14	4970
1	Type 4	11.3	487	12	5844
2	Type 4	13.5	344	13	4472
3	Type 4	19.4	288	16	4608
4	Type 4	17.5	230	15	3450
5	Type 4	15.3	432	14	6048
6	Type 4	15.9	207	14	2898
7	Type 4	14.3	443	13	5759
8	Type 4	15.8	439	14	6146
9	Type 4	11.5	223	12	2676
10	Type 4	17.4	208	15	3120
11	Type 4	19	463	16	7408
12	Type 4	16	441	14	6174
13	Type 4	13.8	323	13	4199
14	Type 4	18.9	297	16	4752
15	Type 4	15.5	412	14	5768
16	Type 4	19.9	324	16	5184
17	Type 4	14.1	271	13	3523
18	Type 4	15.2	349	14	4886
19	Type 4	13.8	409	13	5317
20	Type 4	17.1	373	15	5595
21	Type 4	13.8	254	13	3302
22	Type 4	19.8	274	16	4384
23	Type 4	15.3	278	14	3892
24	Type 4	14.5	317	13	4121
25	Type 4	11.3	260	12	3120
26	Type 4	17.3	211	15	3165
27	Type 4	19.2	272	16	4352
28	Type 4	14.2	264	13	3432
29	Type 4	18.2	284	15	4260

### Radar Signal 5

Trual ID	Radar Typo	Pulse Width (us)	PRI (us)	Number of Pulses	Center Frequency(GHz)
0	Type 5	15	0.8	12	5.534
1	Type 5	8	1.5	12	5.494
2	Type 5	11	1.0909091	12	5.513
3	Type 5	20	0.6	12	5.563
4	Type 5	17	0.7058824	12	5.547
5	Type 5	14	0.8571429	12	5.528
6	Type 5	15	0.8	12	5.533
7	Type 5	12	1	12	5.520
8	Type 5	14	0.8571429	12	5.533
9	Type 5	8	1.5	12	5.496
10	Type 5	17	0.7058824	12	5.546
11	Type 5	19	0.6315789	12	5.560
12	Type 5	15	0.8	12	5.534
13	Type 5	12	1	12	5.516
14	Type 5	19	0.6315789	12	5.558
15	Type 5	14	0.8571429	12	5.530
16	Type 5	20	0.6	12	5.567
17	Type 5	12	1	12	5.518
18	Type 5	14	0.8571429	12	5.528
19	Type 5	12	1	12	5.516
20	Type 5	16	0.75	12	5.543
21	Type 5	12	1	12	5.515
22	Type 5	20	0.6	12	5.566
23	Type 5	14	0.8571429	12	5.528
24	Type 5	13	0.9230769	12	5.521
25	Type 5	8	1.5	12	5.494
26	Type 5	17	0.7058824	12	5.545
27	Type 5	19	0.6315789	12	5.561
28	Type 5	12	1	12	5.519
29	Type 5	18	0.6666667	12	5.522

### Radar Signal 6

Trual ID	Radar Typo	Pulse Width (μs)	PRI (μs)	Pulses per Hop	Hopping Rate (kHz)	Hopping Sequence Length (ms)	Number of Pulses
0	Type 6	1	333.3	9	0.3333	300	16
1	Type 6	1	333.3	9	0.3333	300	10
2	Type 6	1	333.3	9	0.3333	300	14
3	Type 6	1	333.3	9	0.3333	300	19
4	Type 6	1	333.3	9	0.3333	300	15
5	Type 6	1	333.3	9	0.3333	300	18
6	Type 6	1	333.3	9	0.3333	300	14
7	Type 6	1	333.3	9	0.3333	300	14
8	Type 6	1	333.3	9	0.3333	300	21
9	Type 6	1	333.3	9	0.3333	300	15
10	Type 6	1	333.3	9	0.3333	300	16
11	Type 6	1	333.3	9	0.3333	300	24
12	Type 6	1	333.3	9	0.3333	300	13
13	Type 6	1	333.3	9	0.3333	300	20
14	Type 6	1	333.3	9	0.3333	300	17
15	Type 6	1	333.3	9	0.3333	300	20
16	Type 6	1	333.3	9	0.3333	300	16
17	Type 6	1	333.3	9	0.3333	300	18
18	Type 6	1	333.3	9	0.3333	300	14
19	Type 6	1	333.3	9	0.3333	300	16
20	Type 6	1	333.3	9	0.3333	300	20
21	Type 6	1	333.3	9	0.3333	300	19
22	Type 6	1	333.3	9	0.3333	300	23
23	Type 6	1	333.3	9	0.3333	300	17
24	Type 6	1	333.3	9	0.3333	300	16
25	Type 6	1	333.3	9	0.3333	300	13
26	Type 6	1	333.3	9	0.3333	300	13
27	Type 6	1	333.3	9	0.3333	300	18
28	Type 6	1	333.3	9	0.3333	300	19
29	Type 6	1	333.3	9	0.3333	300	20

### 6.4 CHANNEL AVAILABILITY CHECK TIME

If the UUT successfully detected the radar burst, it should be observed as the UUT has no transmissions occurred until the UUT starts transmitting on another channel.

#### 11a Mode

Initial Channel Availability Check Time

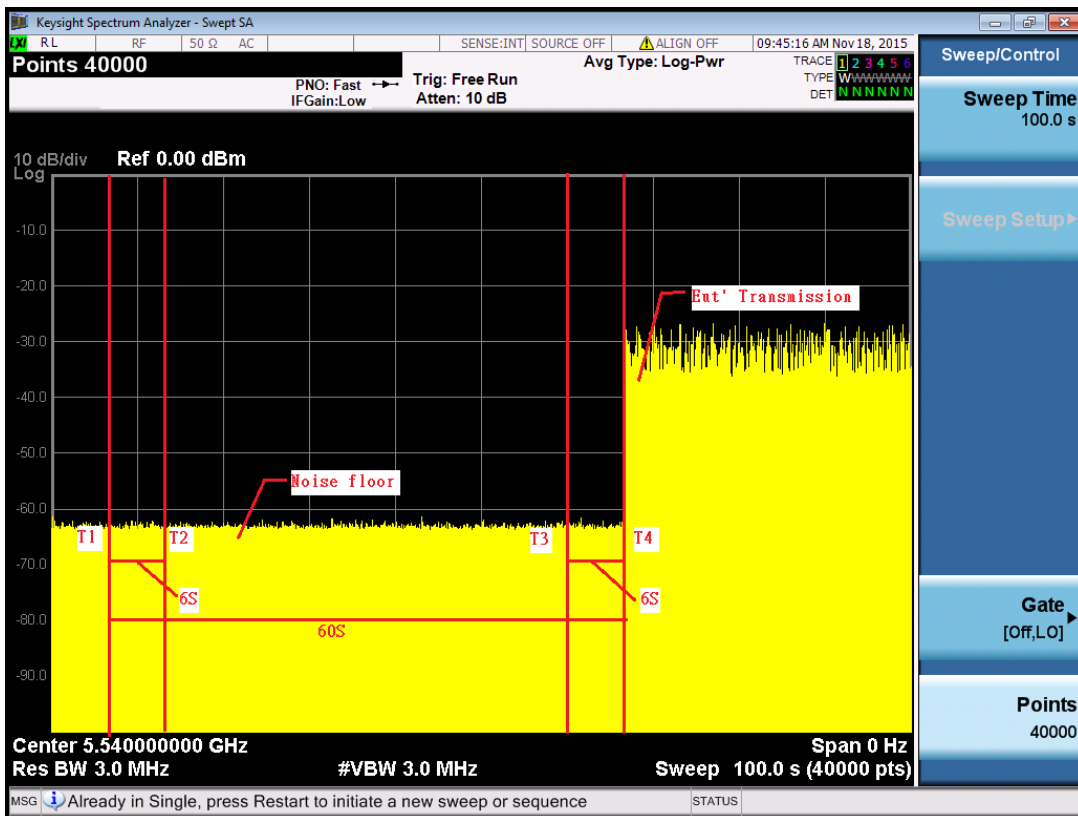

**Note:** T1 denotes the end of power-up time period is 6 second.

T4 denotes the end of Channel Availability Check time is 66 second. Channel Availability Check time is equal to (T4 – T1) 60 seconds.

### 11a Mode

Radar Burst at the Beginning of the Channel Availability Check Time

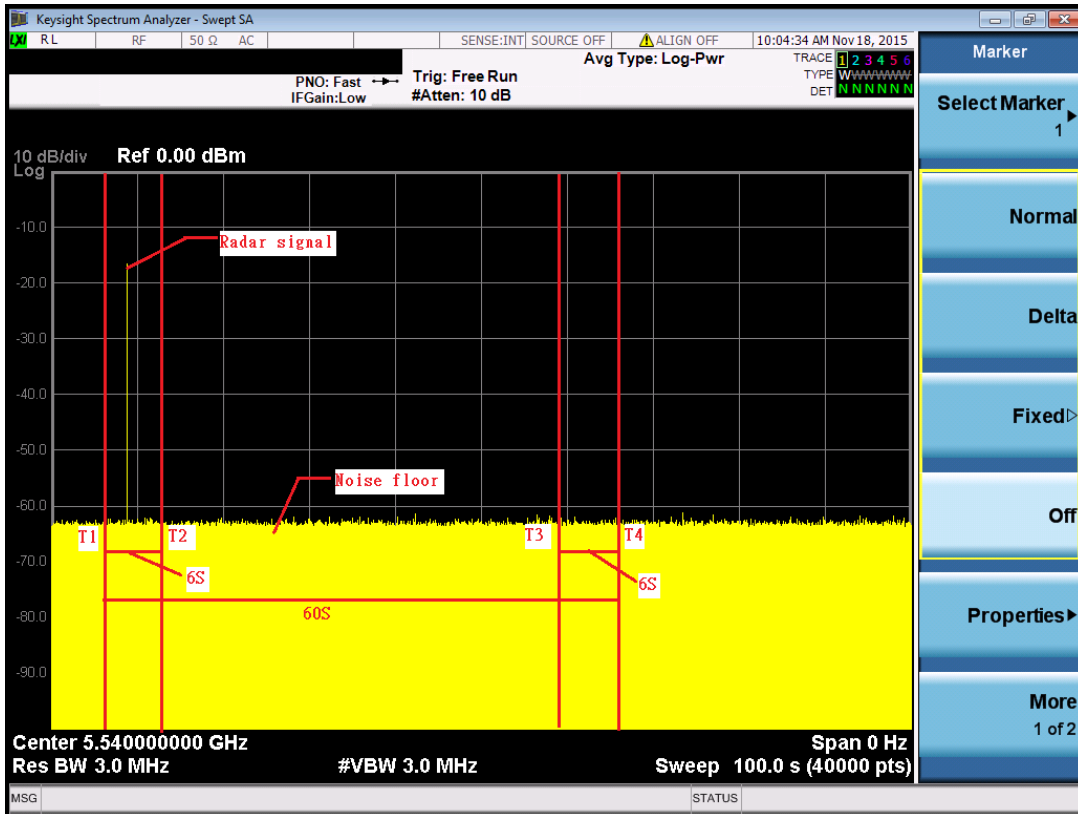

**Note:** T1 denotes the end of power up time period is 6 second.  
T2 denotes 12 second. the radar burst was commenced within a 6 second window starting from the end of power-up sequence.  
T4 denotes the 66 second.

### 11a Mode

Radar Burst at the End of the Channel Availability Check Time

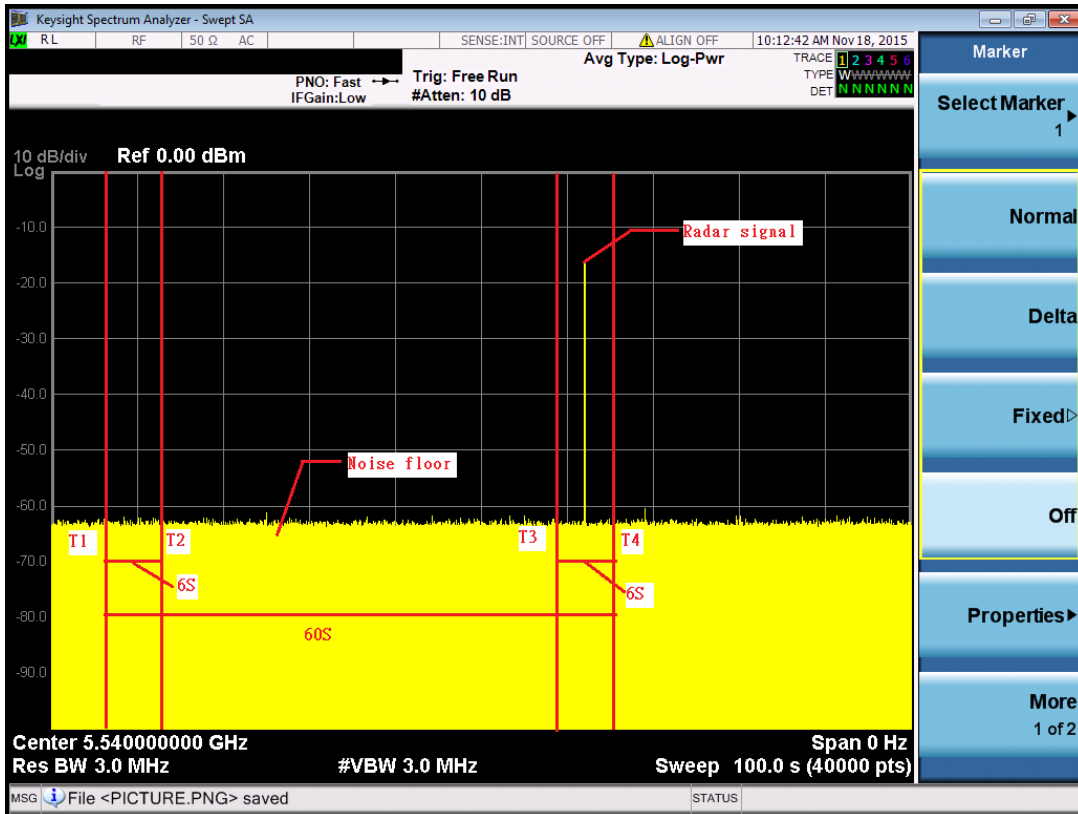

**Note:** T1 denotes the end of power up time period is 6 second.  
 T3 denotes 66 second and radar burst was commenced within 54<sup>th</sup>second to 60<sup>th</sup>second window starting from the end of power-up sequence.  
 T4 denotes the 66 second

### 11n 40MHz Mode

#### Initial Channel Availability Check Time

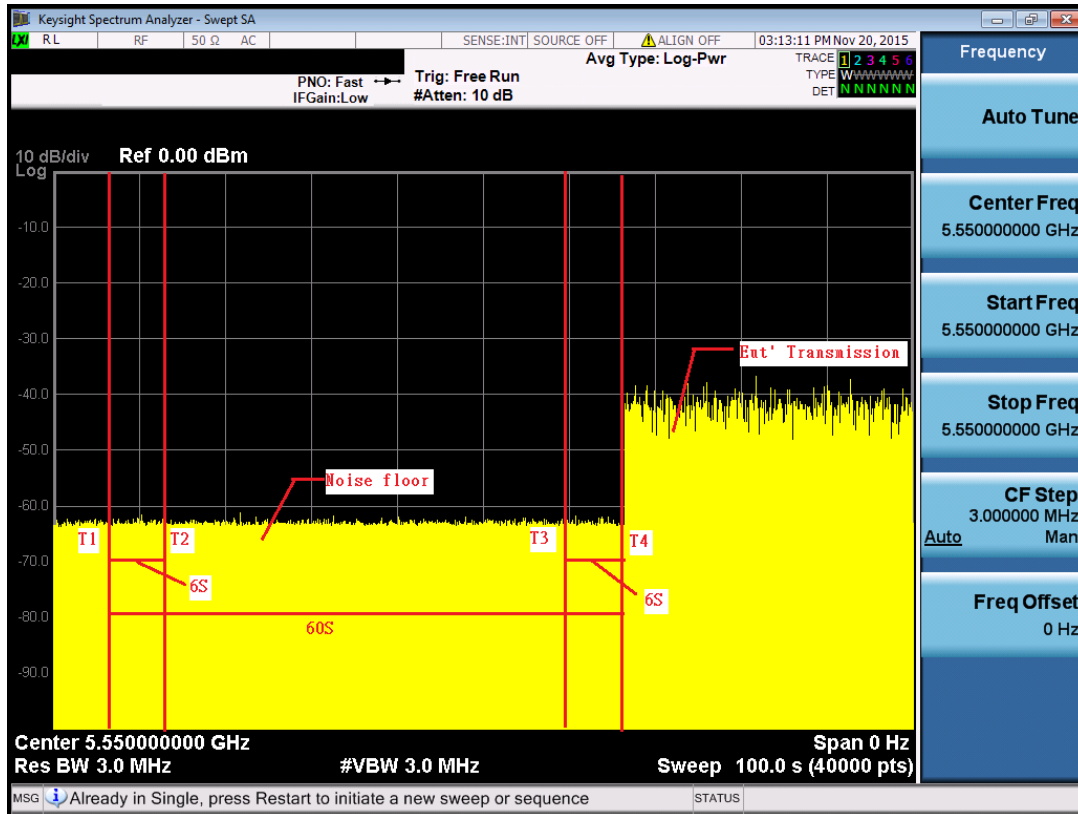

**Note:** T1 denotes the end of power-up time period is 6 second.  
T4 denotes the end of Channel Availability Check time is 66 second. Channel Availability Check time is equal to (T4 – T1) 60 seconds.



### 11n 40MHz Mode

Radar Burst at the Beginning of the Channel Availability Check Time

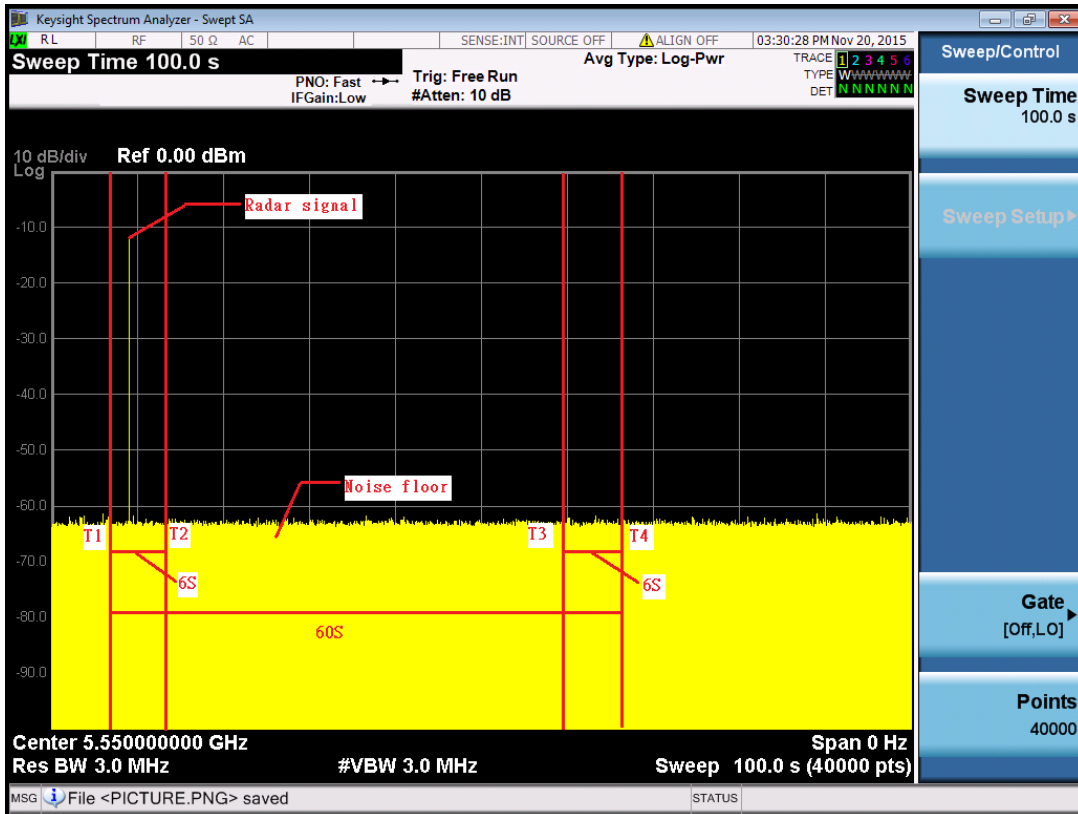

**Note:** T1 denotes the end of power up time period is 6 second.  
 T2 denotes 12 second. the radar burst was commenced within a 6 second window starting from the end of power-up sequence.  
 T4 denotes the 66 second.

### 11n 40MHz Mode

Radar Burst at the End of the Channel Availability Check Time

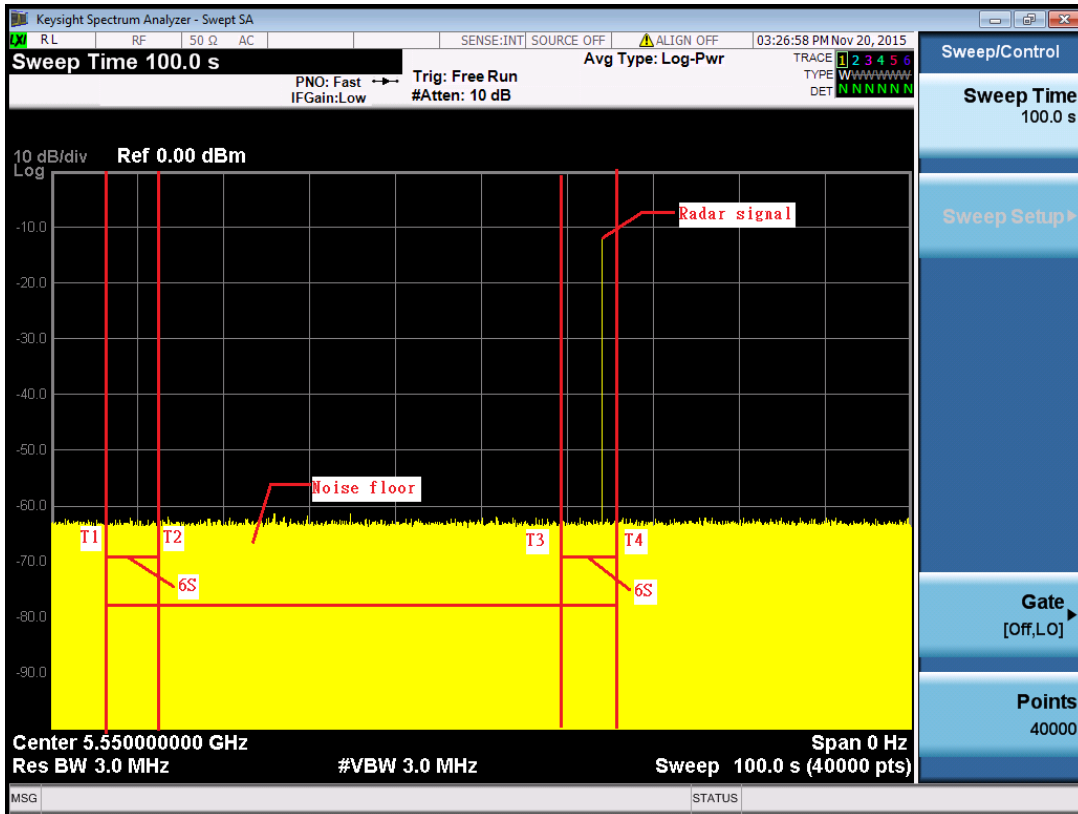

**Note:** T1 denotes the end of power up time period is 6 second.  
 T3 denotes 66 second and radar burst was commenced within 54<sup>th</sup>second to 60<sup>th</sup>second window starting from the end of power-up sequence.  
 T4 denotes the 66 second

### 11ac 80MHz Mode

#### Initial Channel Availability Check Time

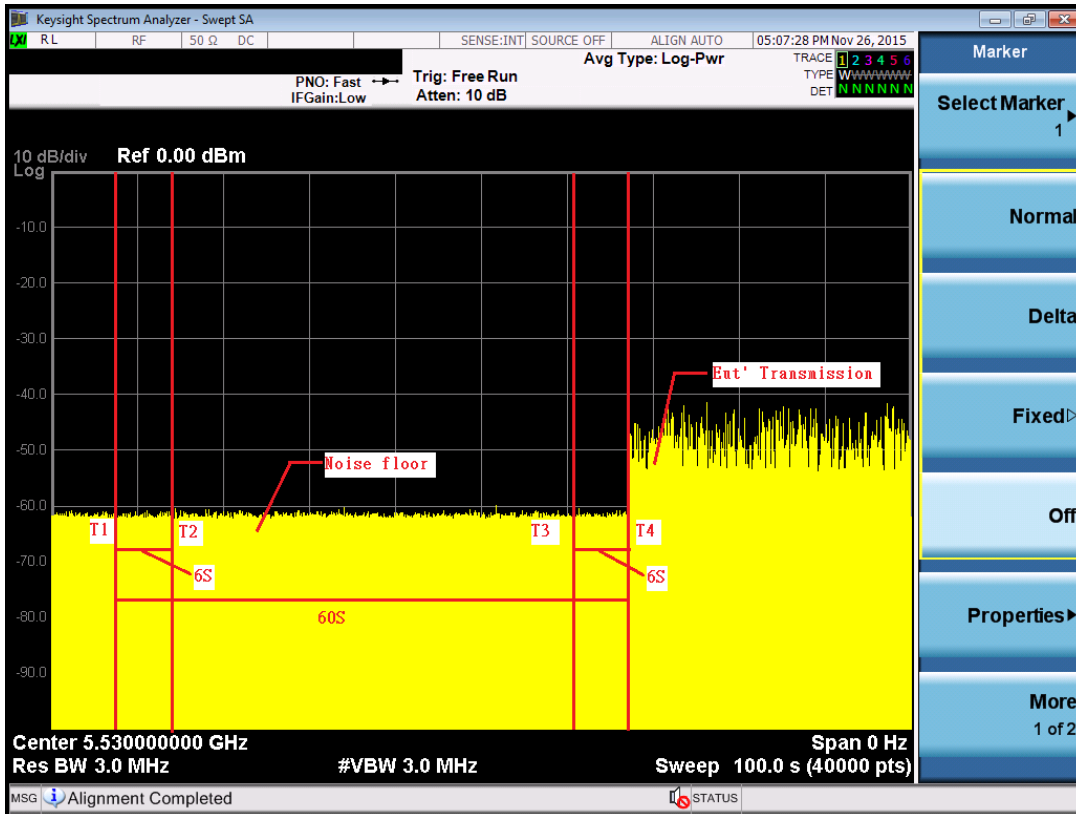

**Note:** T1 denotes the end of power-up time period is 6 second.  
T4 denotes the end of Channel Availability Check time is 66 second. Channel Availability Check time is equal to (T4 – T1) 60 seconds.

### 11ac 80MHz Mode

Radar Burst at the Beginning of the Channel Availability Check Time

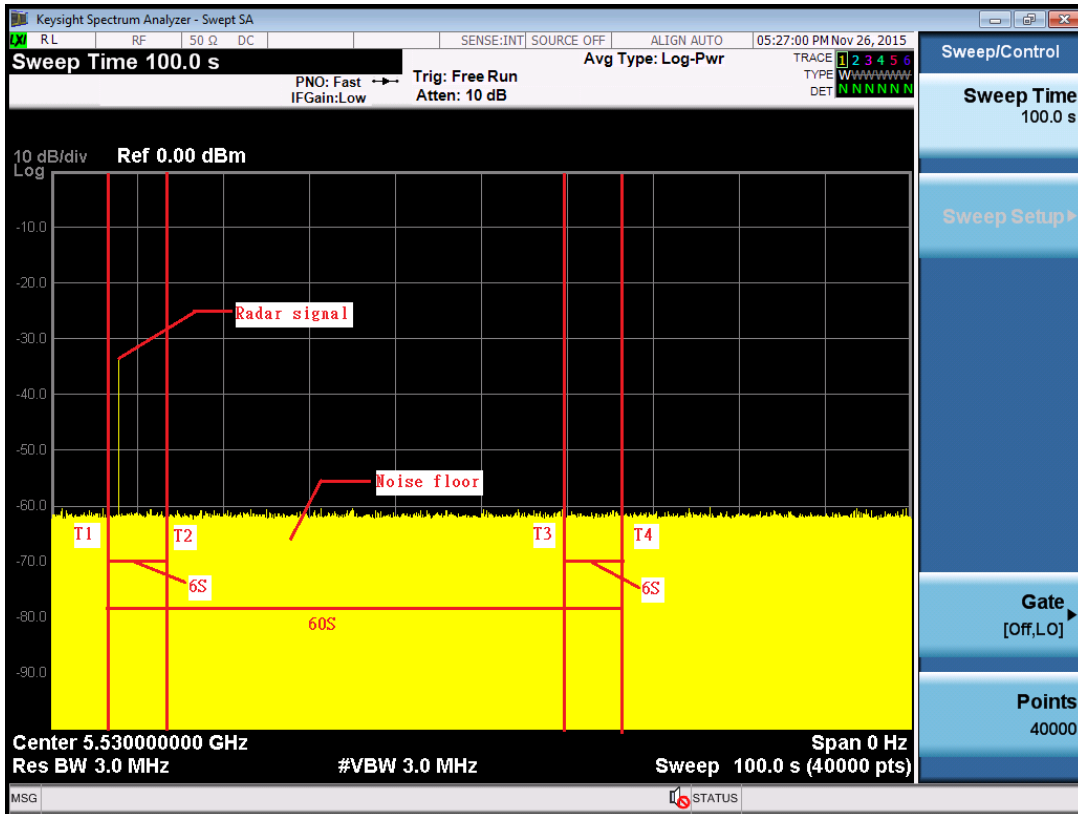

**Note:** T1 denotes the end of power up time period is 6 second.  
T2 denotes 12 second. the radar burst was commenced within a 6 second window starting from the end of power-up sequence.  
T4 denotes the 66 second.

### 11ac 80MHz Mode

Radar Burst at the End of the Channel Availability Check Time

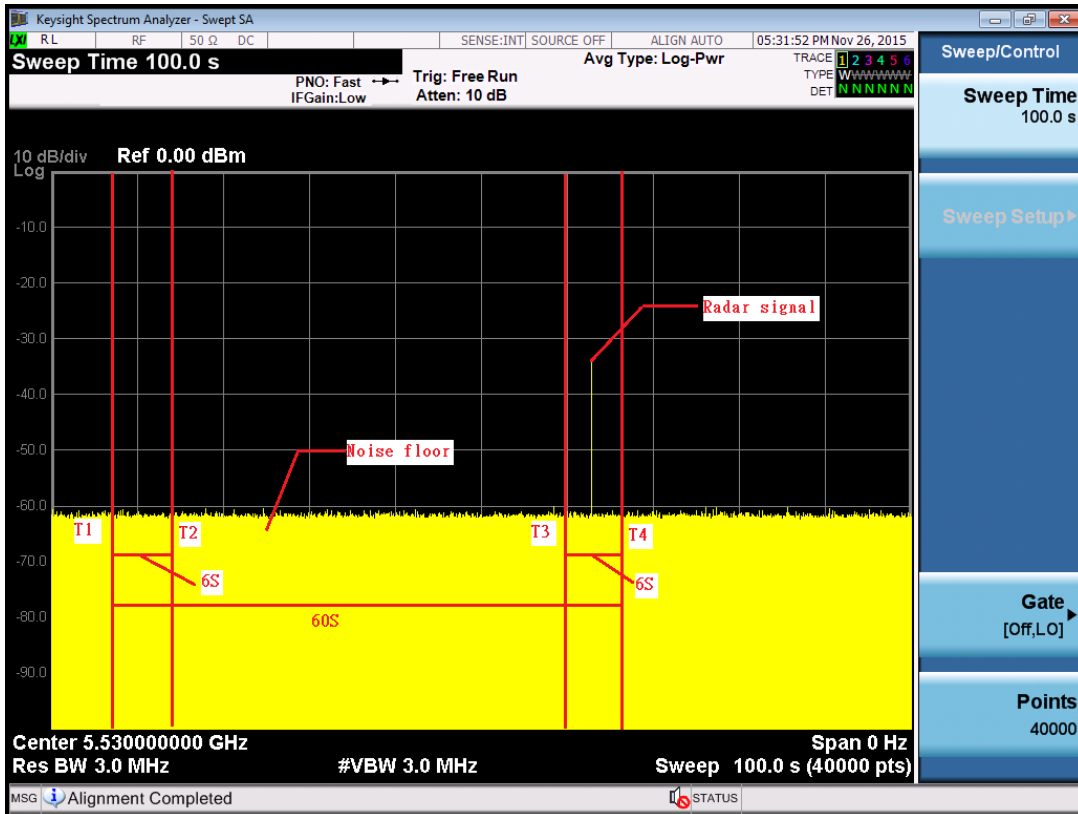

**Note:** T1 denotes the end of power up time period is 6 second.  
 T3 denotes 66 second and radar burst was commenced within 54<sup>th</sup>second to 60<sup>th</sup>second window starting from the end of power-up sequence.  
 T4 denotes the 66 second

### 6.5 CHANNEL CLOSING TRANSMISSION AND CHANNEL MOVE TIME WLAN TRAFFIC

TX (11a Mode )

Radar signal 0

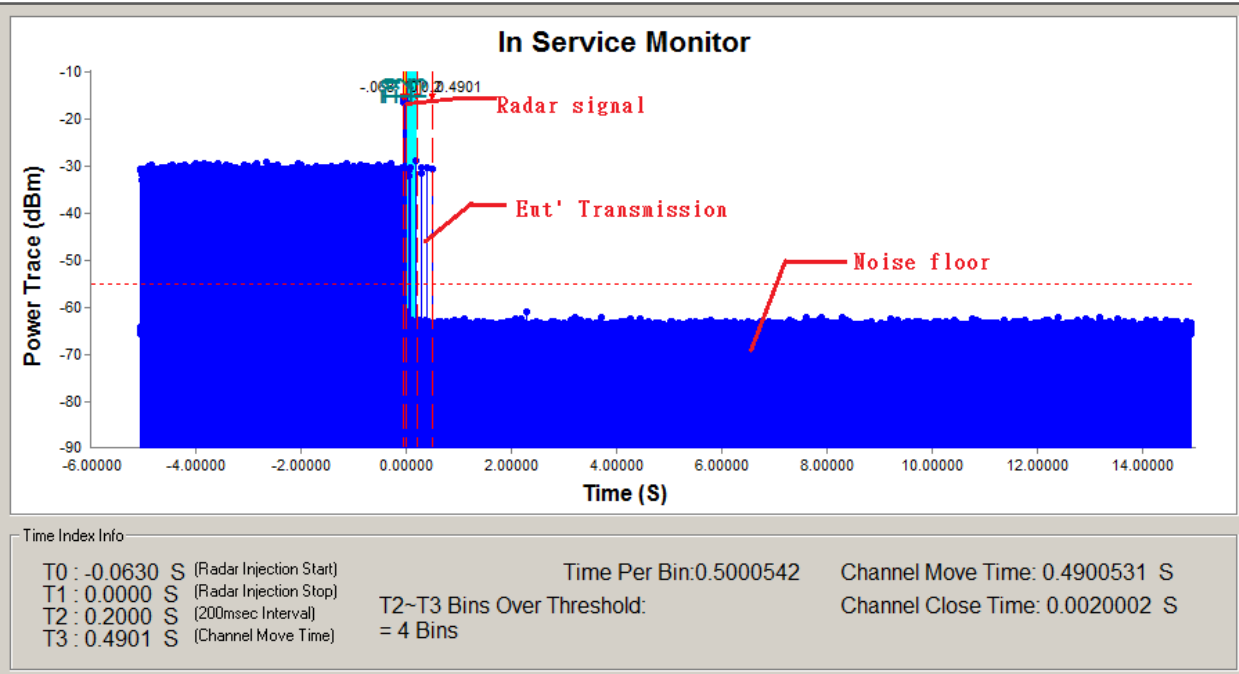

**Note:** T0 denotes the start of Channel Move Time upon the end of the last Radar burst.  
 T1 denotes the data transmission time of 200ms from T0.  
 T2 denotes the end of Channel Move Time.  
 T3 denotes the 10 second from T0 to observe the aggregate duration of transmissions.

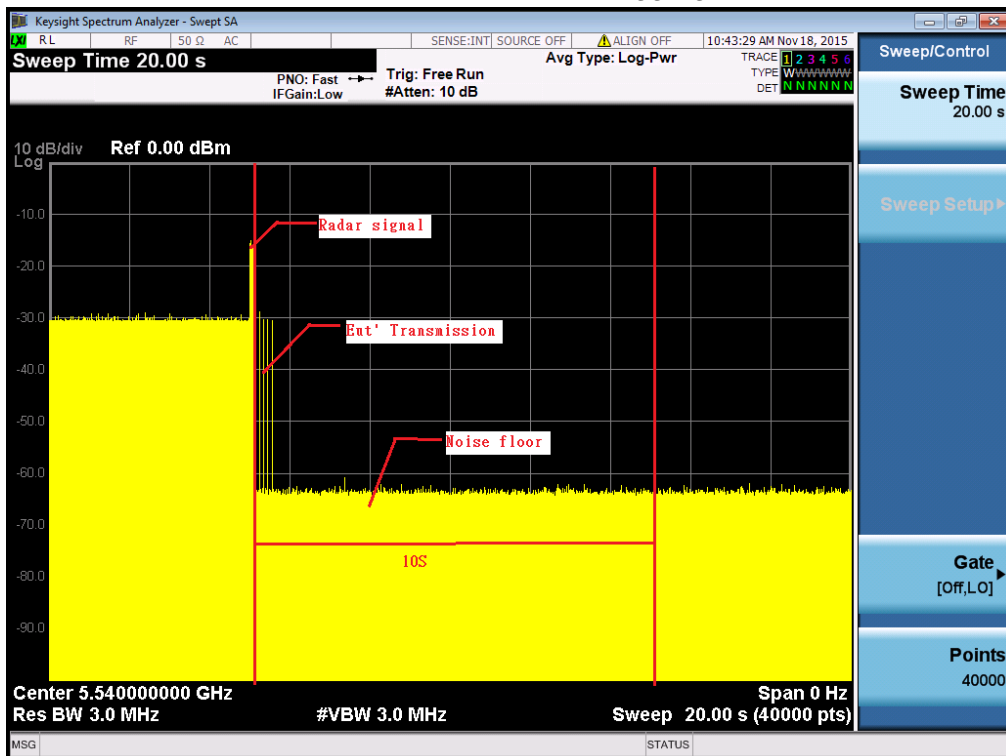

**Note:** An expanded plot for the device vacates the channel in the required 500ms

TX (11n 40MHz Mode)

Radar signal 0

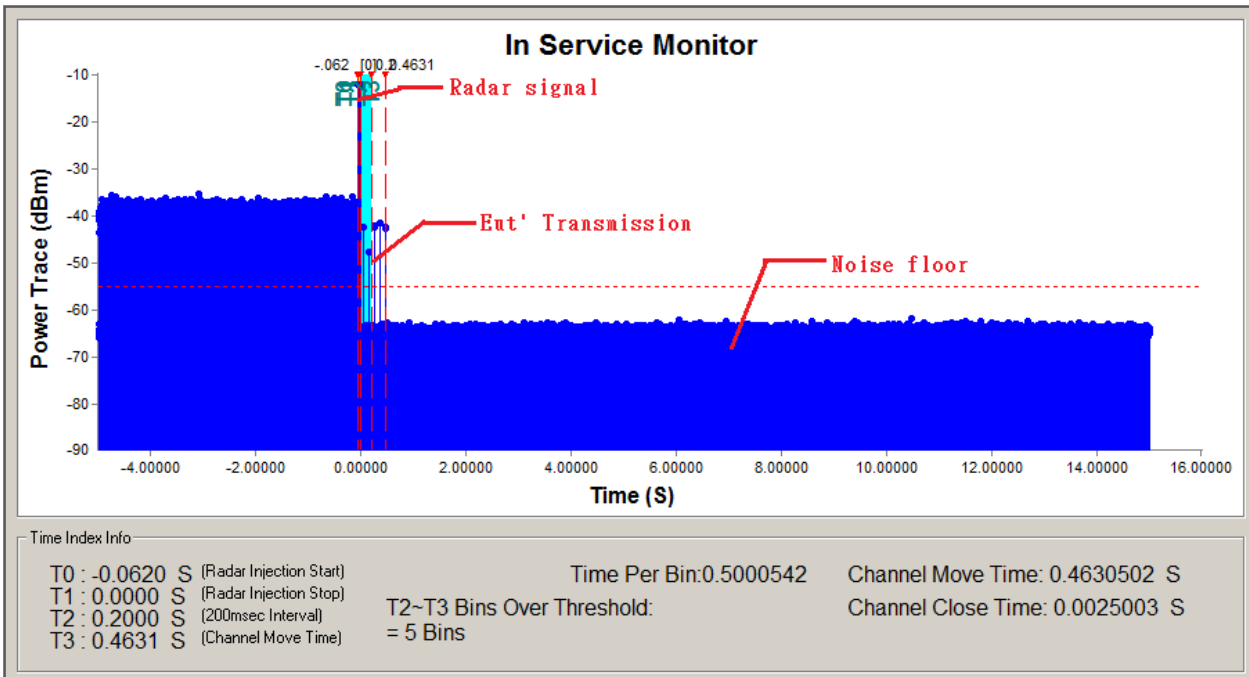

**Note:** T0 denotes the start of Channel Move Time upon the end of the last Radar burst.  
 T1 denotes the data transmission time of 200ms from T0.  
 T2 denotes the end of Channel Move Time.  
 T3 denotes the 10 second from T0 to observe the aggregate duration of transmissions.

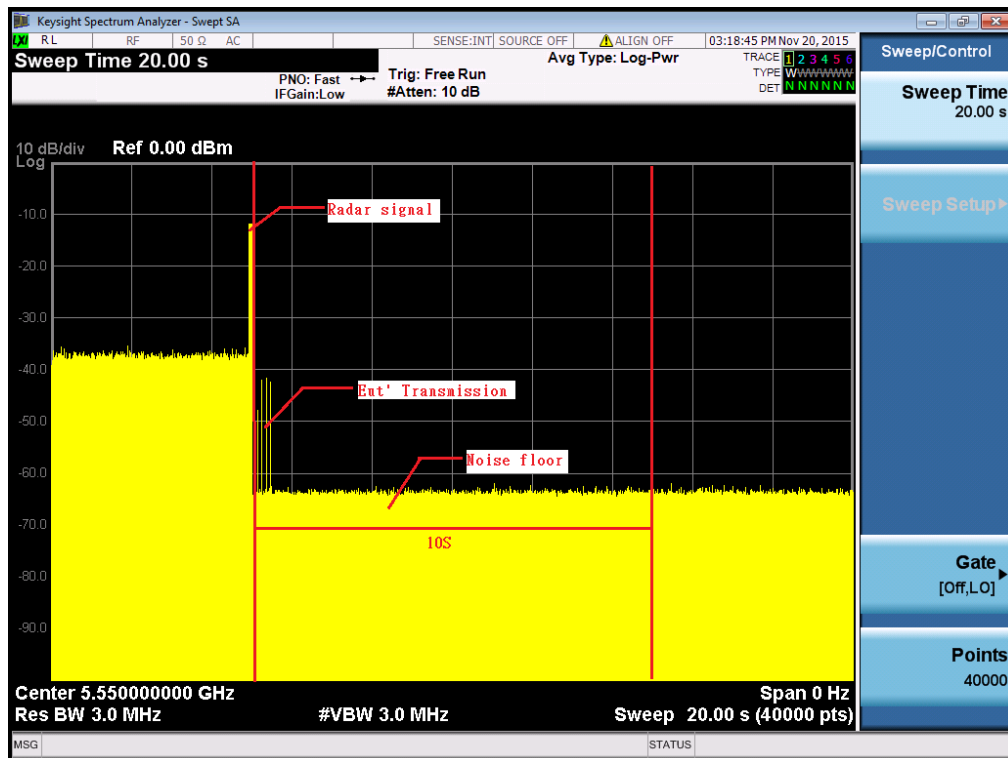

**Note:** An expanded plot for the device vacates the channel in the required 500ms

TX (11ac 80MHz Mode)

Radar signal 0

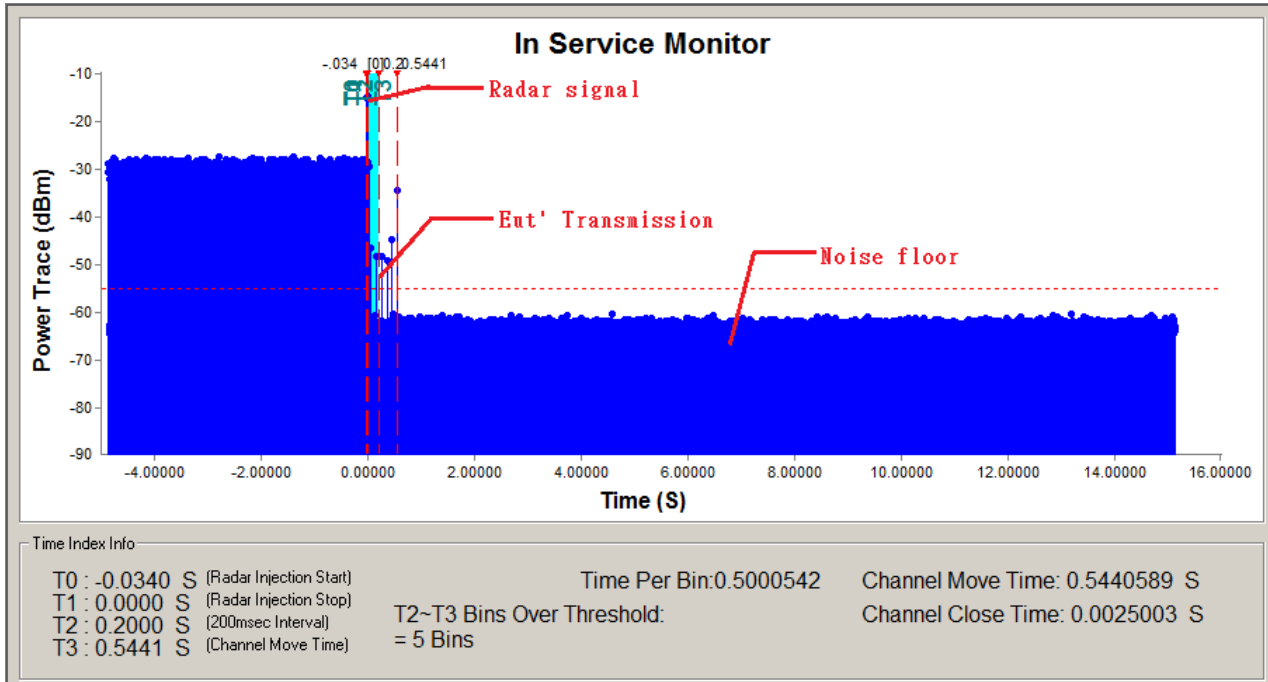

**Note:** T0 denotes the start of Channel Move Time upon the end of the last Radar burst.  
 T1 denotes the data transmission time of 200ms from T0.  
 T2 denotes the end of Channel Move Time.  
 T3 denotes the 10 second from T0 to observe the aggregate duration of transmissions.

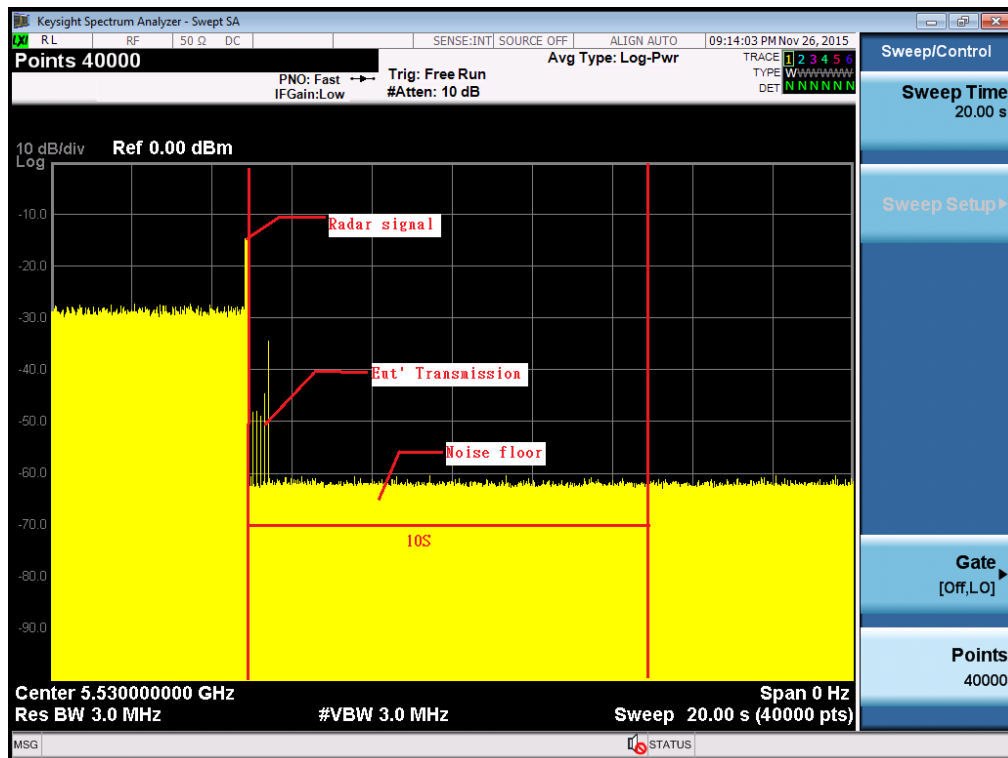

**Note:** An expanded plot for the device vacates the channel in the required 500ms



## 6.6 STATISTICAL PERFORMANCE CHECK

TX (11a Mode)

Table 1: Short Pulse Radar Test Waveforms.

Radar Type	Pulse Width (µsec)	PRI (µsec)	Number of Pulses	Pass times	Fail times	Percentage of Successful Detection (%)
1	1	Test A: 15 unique PRI values randomly selected from the list of 23 PRI values in Table 5a <hr/> Test B: 15 unique PRI values randomly selected within the range of 518-3066 µsec, with a minimum increment of 1 µsec, excluding PRI values selected in Test A	$\text{Roundup} \left\{ \frac{\left( \frac{1}{360} \right)^2 \cdot 19 \cdot 10^6}{\text{PRI}_{\mu\text{sec}}} \right\}$	29	1	97
2	1-5	150-230	23-29	28	2	93
3	6-10	200-500	16-18	29	1	97
4	11-20	200-500	12-16	28	2	93
Aggregate (Radar Types 1-4)			-	114	6	95

Table 2: Long Pulse Radar Test Waveform

Radar Type	Pulse Width (µsec)	Chirp Width (MHz)	PRI (µsec)	Number of Pulses Per Burst	Number of Bursts	Pass times	Fail times	Percentage of Successful Detection (%)
5	50-100	5-20	1000-2000	1-3	8-20	30	0	100

Table 3: Frequency Hopping Radar Test Waveform

Radar Type	Pulse Width (µsec)	PRI (µsec)	Pulses per Hop	Hopping Rate (kHz)	Hopping Sequence Length (msec)	Pass times	Fail times	Percentage of Successful Detection (%)
6	1	333	9	0.333	300	30	0	100

TX (11n 40MHz Mode)

Table 1: Short Pulse Radar Test Waveforms.

Radar Type	Pulse Width (µsec)	PRI (µsec)	Number of Pulses	Pass times	Fail times	Percentage of Successful Detection (%)
1	1	Test A: 15 unique PRI values randomly selected from the list of 23 PRI values in Table 5a <hr/> Test B: 15 unique PRI values randomly selected within the range of 518-3066 µsec, with a minimum increment of 1 µsec, excluding PRI values selected in Test A	$\text{Roundup} \left( \frac{1}{360} \cdot \frac{19 \cdot 10^6}{\text{PRI}_{\mu\text{sec}}} \right)$	29	1	97
2	1-5	150-230	23-29	27	3	90
3	6-10	200-500	16-18	26	4	87
4	11-20	200-500	12-16	27	3	90
Aggregate (Radar Types 1-4)			-	109	11	91

Table 2: Long Pulse Radar Test Waveform

Radar Type	Pulse Width (µsec)	Chirp Width (MHz)	PRI (µsec)	Number of Pulses Per Burst	Number of Bursts	Pass times	Fail times	Percentage of Successful Detection (%)
5	50-100	5-20	1000-2000	1-3	8-20	30	0	100

Table 3: Frequency Hopping Radar Test Waveform

Radar Type	Pulse Width (µsec)	PRI (µsec)	Pulses per Hop	Hopping Rate (kHz)	Hopping Sequence Length (msec)	Pass times	Fail times	Percentage of Successful Detection (%)
6	1	333	9	0.333	300	30	0	100

TX (11ac 80MHz Mode)

Table 1: Short Pulse Radar Test Waveforms.

Radar Type	Pulse Width (µsec)	PRI (µsec)	Number of Pulses	Pass times	Fail times	Percentage of Successful Detection (%)
1	1	Test A: 15 unique PRI values randomly selected from the list of 23 PRI values in Table 5a <hr/> Test B: 15 unique PRI values randomly selected within the range of 518-3066 µsec, with a minimum increment of 1 µsec, excluding PRI values selected in Test A	$\text{Roundup} \left\{ \frac{1}{360} \cdot \frac{19 \cdot 10^6}{\text{PRI}_{\mu\text{sec}}} \right\}$	28	2	93
2	1-5	150-230	23-29	22	8	73
3	6-10	200-500	16-18	28	2	93
4	11-20	200-500	12-16	27	3	90
Aggregate (Radar Types 1-4)			-	105	15	88

Table 2: Long Pulse Radar Test Waveform

Radar Type	Pulse Width (µsec)	Chirp Width (MHz)	PRI (µsec)	Number of Pulses Per Burst	Number of Bursts	Pass times	Fail times	Percentage of Successful Detection (%)
5	50-100	5-20	1000-2000	1-3	8-20	30	0	100

Table 3: Frequency Hopping Radar Test Waveform

Radar Type	Pulse Width (µsec)	PRI (µsec)	Pulses per Hop	Hopping Rate (kHz)	Hopping Sequence Length (msec)	Pass times	Fail times	Percentage of Successful Detection (%)
6	1	333	9	0.333	300	30	0	100

## 6.7 NON- OCCUPANCY PERIOD

During the 30 minutes observation time, UUT did not make any transmissions on a channel after a radar signal was detected on that channel by either the Channel Availability Check or the In-Service Monitoring.

5530 Non-Occupancy period

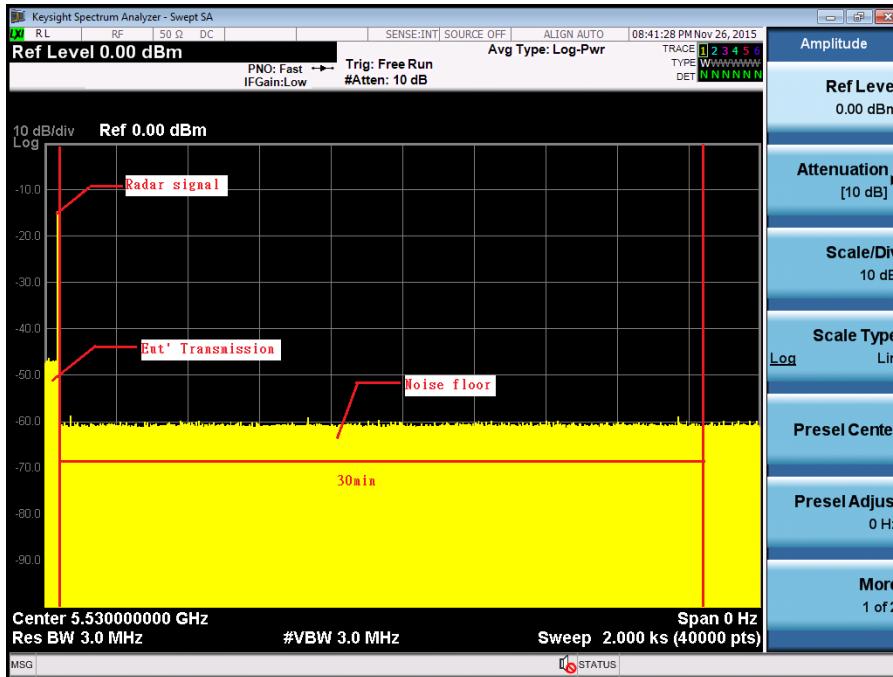

5540 Non-Occupancy period

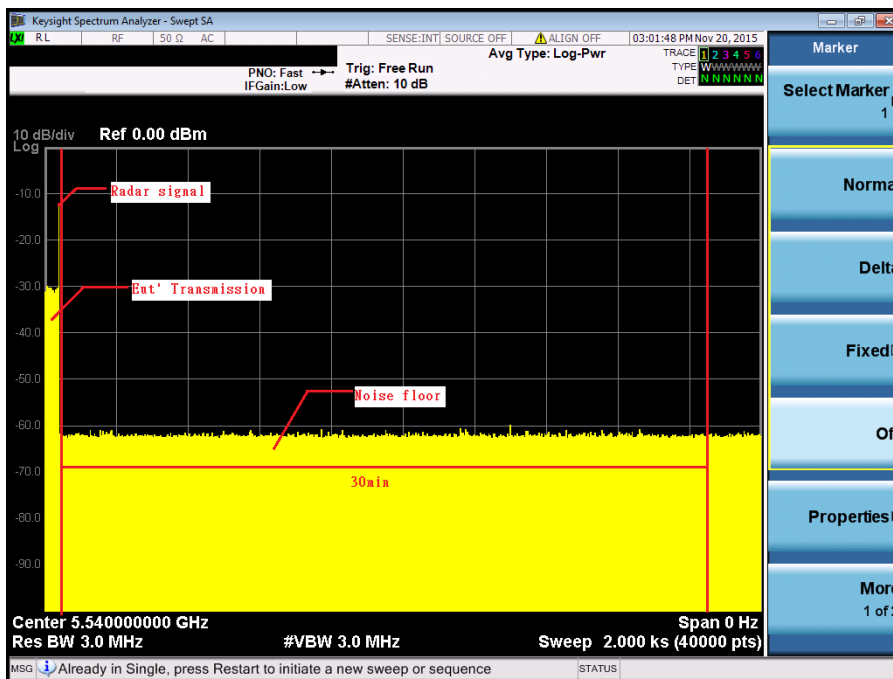

### 5550 Non-Occupancy period

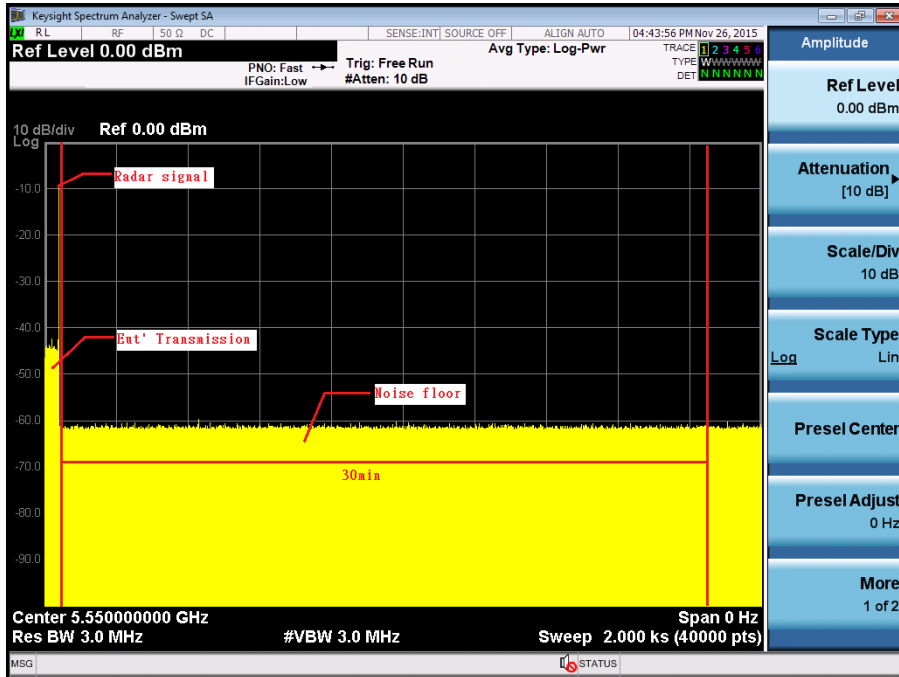

### 6.8 UNIFORM SPREADING

The intention of the uniform spreading is to provide, on aggregate, a uniform loading of the spectrum. The UUT using the bands 5250 to 5350MHz and 5470 to 5600 MHz channels so that the probability of selecting a given channel shall be the same for channels. The UUT will select channel by random mode and remember this channel when detect radar signal, so that will select unused channel by random mode.

### 6.9 U-NII DETECTION BANDWIDTH

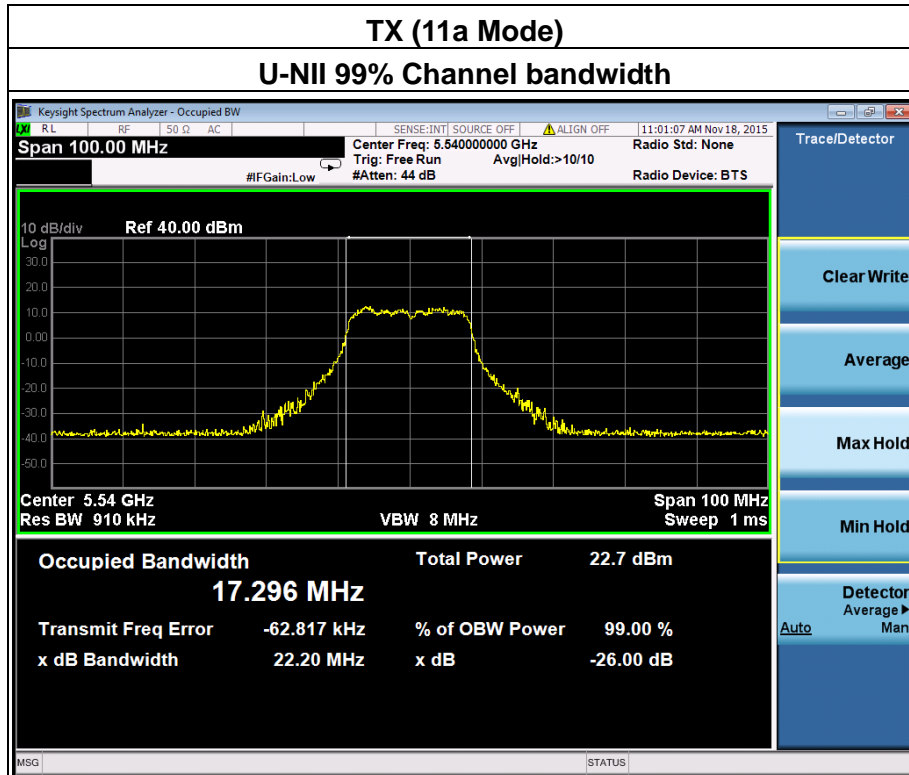

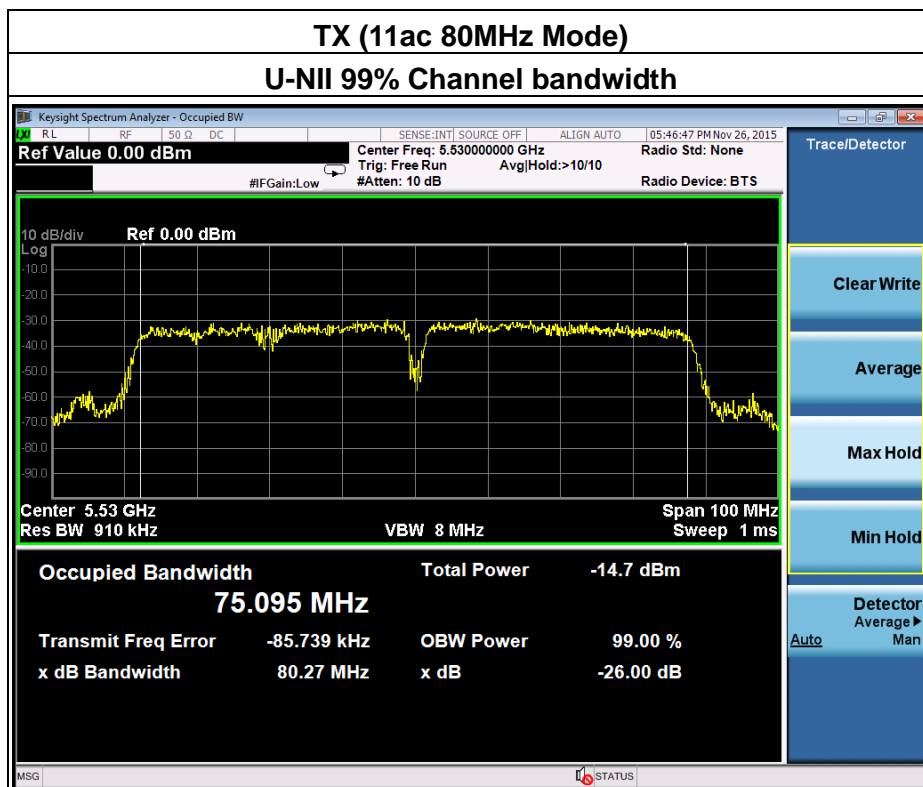
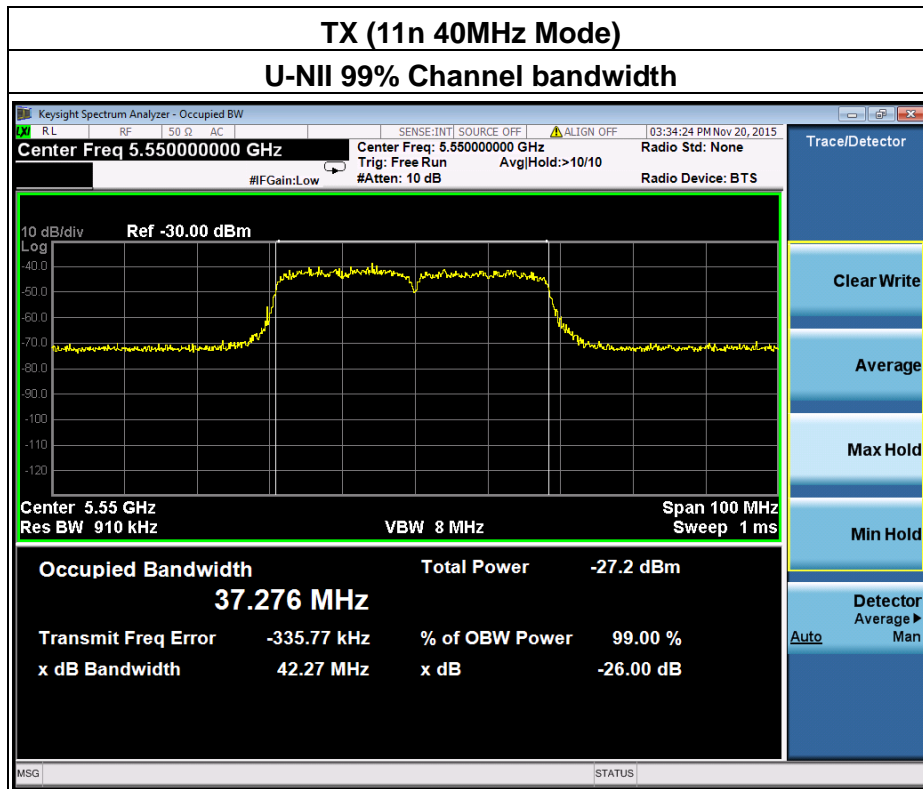

11a Mode

Detection Bandwidth test transmission 20M												
EUT FREQUENCY	5540M											
EUT power bandwidth	17.296											
Detection Bandwidth limit(100%of EUT 99% Power band)	17.296											
Detection Bandwidth	5549(FH)	5531(FL)										21
Test Result	PASS											
Radar Freq (MHz)	DFS Detection Trials (1=Detection, 0= No Detection)										Detection Rate (%)	
	1	2	3	4	5	6	7	8	9	10		
5529	0	0	0	0	0	0	0	0	0	0	0	
5530	1	1	1	1	1	1	1	1	1	1	1	
5531(FL)	1	1	1	1	1	1	1	1	1	1	1	
5532	1	1	1	1	1	1	1	1	1	1	1	
5533	1	1	1	1	1	1	1	1	1	1	1	
5534	1	1	1	1	1	1	1	1	1	1	1	
5535	1	1	1	1	1	1	1	1	1	1	1	
5536	1	1	1	1	1	1	1	1	1	1	1	
5537	1	1	1	1	1	1	1	1	1	1	1	
5538	1	1	1	1	1	1	1	1	1	1	1	
5539	1	1	1	1	1	1	1	1	1	1	1	
5540	1	1	1	1	1	1	1	1	1	1	1	
5541	1	1	1	1	1	1	1	1	1	1	1	
5542	1	1	1	1	1	1	1	1	1	1	1	
5543	1	1	1	1	1	1	1	1	1	1	1	
5544	1	1	1	1	1	1	1	1	1	1	1	
5545	1	1	1	1	1	1	1	1	1	1	1	
5546	1	1	1	1	1	1	1	1	1	1	1	
5547	1	1	1	1	1	1	1	1	1	1	1	
5548	1	1	1	1	1	1	1	1	1	1	1	
5549(FH)	1	1	1	1	1	1	1	1	1	1	1	



11n 40MHz Mode

Detection Bandwidth test transmission		40M									
EUT FREQUENCY		5550M									
EUT power bandwidth		37.276MHz									
Detection Bandwidth limit(100%of EUT 99% Power bandwidth)		37.276									
Detection Bandwidth(5569(FH)-5531(FL))		39									
Test Result	PASS										
	DFS Detection Trials (1=Detection, 0= No Detection)										
Radar Freq (MHz)	1	2	3	4	5	6	7	8	9	10	Detection Rate (%)
5529	1	1	1	1	1	1	1	1	1	1	100
5530	1	1	1	1	1	1	1	1	1	1	100
5531(FL)	1	1	1	1	1	1	1	1	1	1	100
5532	1	1	1	1	1	1	1	1	1	1	100
5533	1	1	1	1	1	1	1	1	1	1	100
5534	1	1	1	1	1	1	1	1	1	1	100
5535	1	1	1	1	1	1	1	1	1	1	100
5536	1	1	1	1	1	1	1	1	1	1	100
5537	1	1	1	1	1	1	1	1	1	1	100
5538	1	1	1	1	1	1	1	1	1	1	100
5539	1	1	1	1	1	1	1	1	1	1	100
5540	1	1	1	1	1	1	1	1	1	1	100
5541	1	1	1	1	1	1	1	1	1	1	100
5542	1	1	1	1	1	1	1	1	1	1	100
5543	1	1	1	1	1	1	1	1	1	1	100
5544	1	1	1	1	1	1	1	1	1	1	100
5545	1	1	1	1	1	1	1	1	1	1	100
5546	1	1	1	1	1	1	1	1	1	1	100
5547	1	1	1	1	1	1	1	1	1	1	100
5548	1	1	1	1	1	1	1	1	1	1	100
5549	1	1	1	1	1	1	1	1	1	1	100
5550	1	1	1	1	1	1	1	1	1	1	100
5551	1	1	1	1	1	1	1	1	1	1	100
5552	1	1	1	1	1	1	1	1	1	1	100
5553	1	1	1	1	1	1	1	1	1	1	100
5554	1	1	1	1	1	1	1	1	1	1	100
5555	1	1	1	1	1	1	1	1	1	1	100
5556	1	1	1	1	1	1	1	1	1	1	100
5557	1	1	1	1	1	1	1	1	1	1	100
5558	1	1	1	1	1	1	1	1	1	1	100
5559	1	1	1	1	1	1	1	1	1	1	100
5560	1	1	1	1	1	1	1	1	1	1	100
5561	1	1	1	1	1	1	1	1	1	1	100
5562	1	1	1	1	1	1	1	1	1	1	100
5563	1	1	1	1	1	1	1	1	1	1	100
5564	1	1	1	1	1	1	1	1	1	1	100
5565	1	1	1	1	1	1	1	1	1	1	100
5566	1	1	1	1	1	1	1	1	1	1	100
5567	1	1	1	1	1	1	1	1	1	1	100
5568	1	1	1	1	1	1	1	1	1	1	100
5569(FL)	1	1	1	1	1	1	1	1	1	1	100
5570	1	1	1	1	1	1	1	1	1	1	100
5571	1	1	1	1	1	1	1	1	1	1	100

11ac 80MHz Mode

Detection Bandwidth test transmission	80M										
EUT FREQUENCY	5530M										
EUT power bandwidth	75.095										
Detection Bandwidth limit(100%of EUT 99% Power bandwidth)	75.095										
Detection Bandwidth(5568(FH)-5492(FL))	77										
Test Result	PASS										
	DFS Detection Trials (1=Detection, 0= No Detection)										
Radar Freq (MHz)	1	2	3	4	5	6	7	8	9	10	Detection Rate (%)
5489	0	0	0	0	0	0	0	0	0	0	0
5490	1	1	1	1	1	1	1	1	1	1	100
5491	1	1	1	1	1	1	1	1	1	1	100
5492(FL)	1	1	1	1	1	1	1	1	1	1	100
5493	1	1	1	1	1	1	1	1	1	1	100
5494	1	1	1	1	1	1	1	1	1	1	100
5495	1	1	1	1	1	1	1	1	1	1	100
5496	1	1	1	1	1	1	1	1	1	1	100
5497	1	1	1	1	1	1	1	1	1	1	100
5498	1	1	1	1	1	1	1	1	1	1	100
5499	1	1	1	1	1	1	1	1	1	1	100
5500	1	1	1	1	1	1	1	1	1	1	100
5501	1	1	1	1	1	1	1	1	1	1	100
5502	1	1	1	1	1	1	1	1	1	1	100
5503	1	1	1	1	1	1	1	1	1	1	100
5504	1	1	1	1	1	1	1	1	1	1	100
5505	1	1	1	1	1	1	1	1	1	1	100
5506	1	1	1	1	1	1	1	1	1	1	100
5507	1	1	1	1	1	1	1	1	1	1	100
5508	1	1	1	1	1	1	1	1	1	1	100
5509	1	1	1	1	1	1	1	1	1	1	100
5510	1	1	1	1	1	1	1	1	1	1	100
5511	1	1	1	1	1	1	1	1	1	1	100
5512	1	1	1	1	1	1	1	1	1	1	100
5513	1	1	1	1	1	1	1	1	1	1	100
5514	1	1	1	1	1	1	1	1	1	1	100
5515	1	1	1	1	1	1	1	1	1	1	100
5516	1	1	1	1	1	1	1	1	1	1	100
5517	1	1	1	1	1	1	1	1	1	1	100
5518	1	1	1	1	1	1	1	1	1	1	100
5519	1	1	1	1	1	1	1	1	1	1	100
5520	1	1	1	1	1	1	1	1	1	1	100
5521	1	1	1	1	1	1	1	1	1	1	100
5522	1	1	1	1	1	1	1	1	1	1	100
5523	1	1	1	1	1	1	1	1	1	1	100
5524	1	1	1	1	1	1	1	1	1	1	100
5525	1	1	1	1	1	1	1	1	1	1	100
5526	1	1	1	1	1	1	1	1	1	1	100
5527	1	1	1	1	1	1	1	1	1	1	100
5528	1	1	1	1	1	1	1	1	1	1	100
5529	1	1	1	1	1	1	1	1	1	1	100
5530	1	1	1	1	1	1	1	1	1	1	100
5531	1	1	1	1	1	1	1	1	1	1	100
5532	1	1	1	1	1	1	1	1	1	1	100
5533	1	1	1	1	1	1	1	1	1	1	100
5534	1	1	1	1	1	1	1	1	1	1	100
5535	1	1	1	1	1	1	1	1	1	1	100
5536	1	1	1	1	1	1	1	1	1	1	100
5537	1	1	1	1	1	1	1	1	1	1	100
5538	1	1	1	1	1	1	1	1	1	1	100

5539	1	1	1	1	1	1	1	1	1	1	1	100
5540	1	1	1	1	1	1	1	1	1	1	1	100
5541	1	1	1	1	1	1	1	1	1	1	1	100
5542	1	1	1	1	1	1	1	1	1	1	1	100
5543	1	1	1	1	1	1	1	1	1	1	1	100
5544	1	1	1	1	1	1	1	1	1	1	1	100
5545	1	1	1	1	1	1	1	1	1	1	1	100
5546	1	1	1	1	1	1	1	1	1	1	1	100
5547	1	1	1	1	1	1	1	1	1	1	1	100
5548	1	1	1	1	1	1	1	1	1	1	1	100
5549	1	1	1	1	1	1	1	1	1	1	1	100
5550	1	1	1	1	1	1	1	1	1	1	1	100
5551	1	1	1	1	1	1	1	1	1	1	1	100
5552	1	1	1	1	1	1	1	1	1	1	1	100
5553	1	1	1	1	1	1	1	1	1	1	1	100
5554	1	1	1	1	1	1	1	1	1	1	1	100
5555	1	1	1	1	1	1	1	1	1	1	1	100
5556	1	1	1	1	1	1	1	1	1	1	1	100
5557	1	1	1	1	1	1	1	1	1	1	1	100
5558	1	1	1	1	1	1	1	1	1	1	1	100
5559	1	1	1	1	1	1	1	1	1	1	1	100
5560	1	1	1	1	1	1	1	1	1	1	1	100
5561	1	1	1	1	1	1	1	1	1	1	1	100
5562	1	1	1	1	1	1	1	1	1	1	1	100
5563	1	1	1	1	1	1	1	1	1	1	1	100
5564	1	1	1	1	1	1	1	1	1	1	1	100
5565	1	1	1	1	1	1	1	1	1	1	1	100
5566	1	1	1	1	1	1	1	1	1	1	1	100
5567	1	1	1	1	1	1	1	1	1	1	1	100
5568(FL)	1	1	1	1	1	1	1	1	1	1	1	100
5569	1	1	1	1	1	1	1	1	1	1	1	100
5570	1	1	1	1	1	1	1	1	1	1	1	100
5571	0	0	0	0	0	0	0	0	0	0	0	0

7. EUT TEST PHOTO

