



(10) Antenna Info for DZLA00023

- (a) Per FCC 15.203, the antenna is internal and permanently attached. It is not intended to be serviced by the customer and is, therefore only serviceable by Logitech, Inc. authorized personnel.
- (b) The antennas are quarter-wavelength monopole wires. See next pages for drawings and pictures of the antennas.

Vertical Antenna

Manufacturer: Logitech, Inc.  
Part Number: 340-000556  
Gain (dBi): 3.90 dBi  
Description: Monopole (quarter-wavelength)

Horizontal Antenna

Manufacturer: Logitech, Inc.  
Part Number: 340-000557  
Gain (dBi): 3.20 dBi  
Description: Monopole (quarter-wavelength)

customer code

RoHs Request:  
 1. Grade I Environmental substance is prohibited.  
 2. To compliant with SY-2-GP-Q-001 Environment Management Standard of Shinyuan.

item	Revised Description	Revision	Date	Revised Details

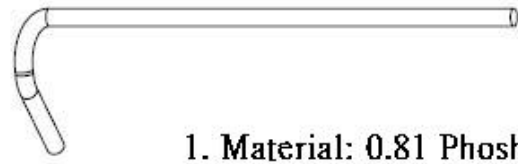
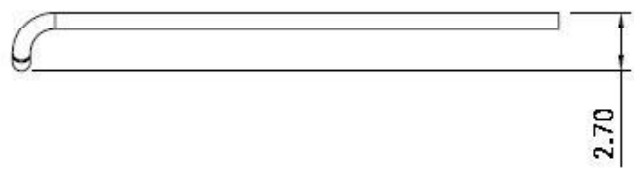

- 1. Material: 0.81 Phospor Bronze Wire
- 2. Surface: Bright Tin (3~5Um)
- 3. Unit: mm

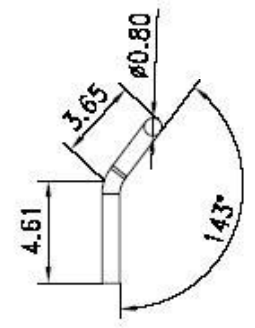
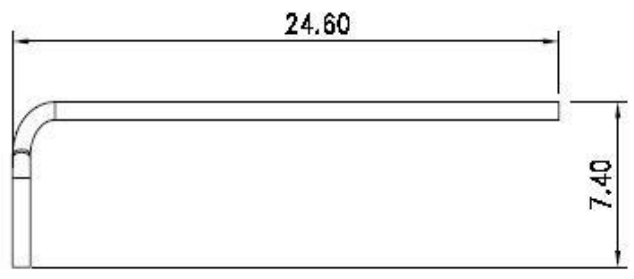

QC Important Dimension				
NO.	specification	tolerance	Test Tooling	Remarks



東莞信澤電子五金有限公司  
 SHIN YUAN ELECTRONIC CO., LTD

Production Sealed      Drawing Issuing Sealed

Technical level	Grade	Packing	Team	Material	Heat Treatment	Surface	Approved by	Checked by	Made by	Part Name	Part No.	Unit Weight	Scale	Version
				0.81 Phospor Bronze Wire		Bright Tin(3~5Um)			Liyue				1 / 1	A

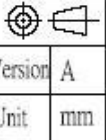

customer code

RoHs Request:  
 1. Grade I Environmental substance is prohibited.  
 2. To compliant with SY-2-GP-Q-001 Environment Management Standard of Shinyuan.

item	Revised Description	Revision	Date	Revised Details

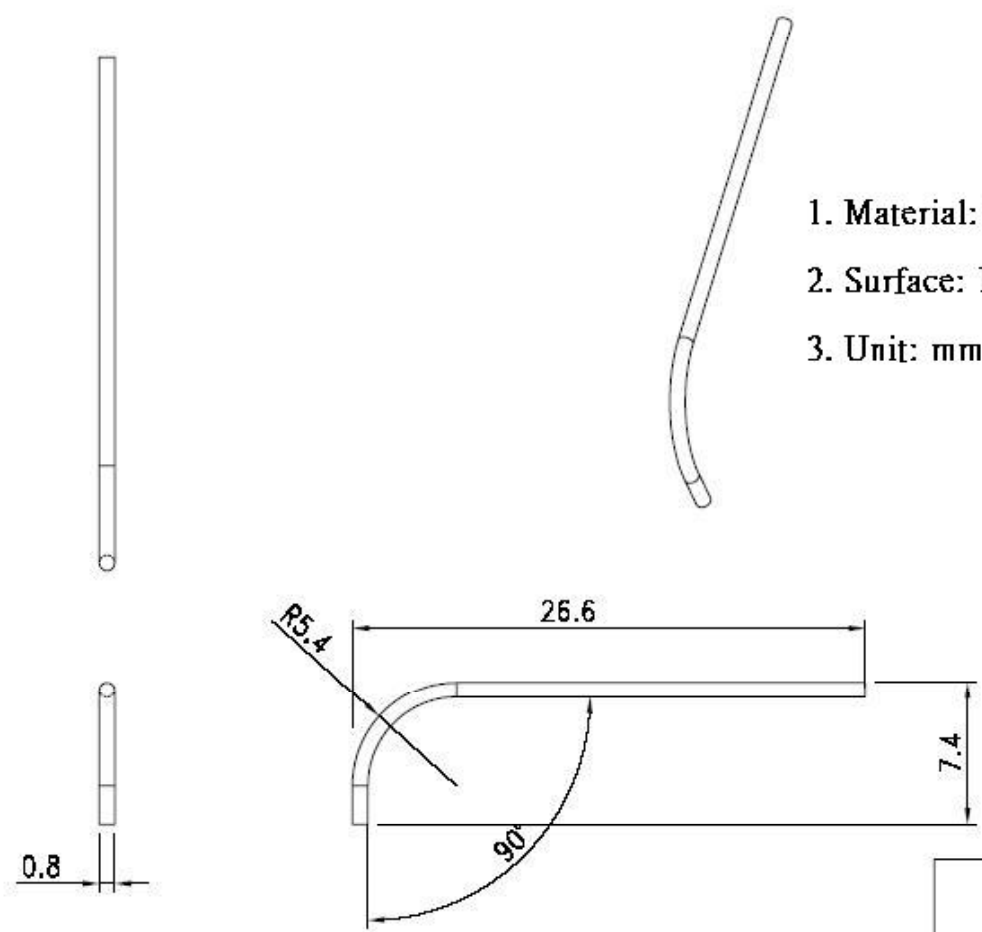

- 1. Material: 0.81 Phospor Bronze Wire
- 2. Surface: Bright Tin (3~5Um)
- 3. Unit: mm

QC Important Dimension				
NO.	specification	tolerance	Test Tooling	Remarks

Technical level	Grade	Packing	Team	Material	0.81 Phospor Bronze Wire	Approved by	
			RPM	Heat Treatment		Checked by	
			Operating Time	Surface	Bright Tin(3~5Um)	Made by	Liyue

Production Sealed		Drawing Issuing Sealed	
Part Name		Part No.	
Unit Weight		Scale	1 / 1
Unit	mm	Version	A



東莞信澤電子五金有限公司  
 SHIN YUAN ELECTRONIC CO., LTD

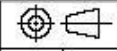

Antenna #1

RF Chip AV7202

Antenna #2

PLOTECH 6 94V-0  
E169497 15 CH

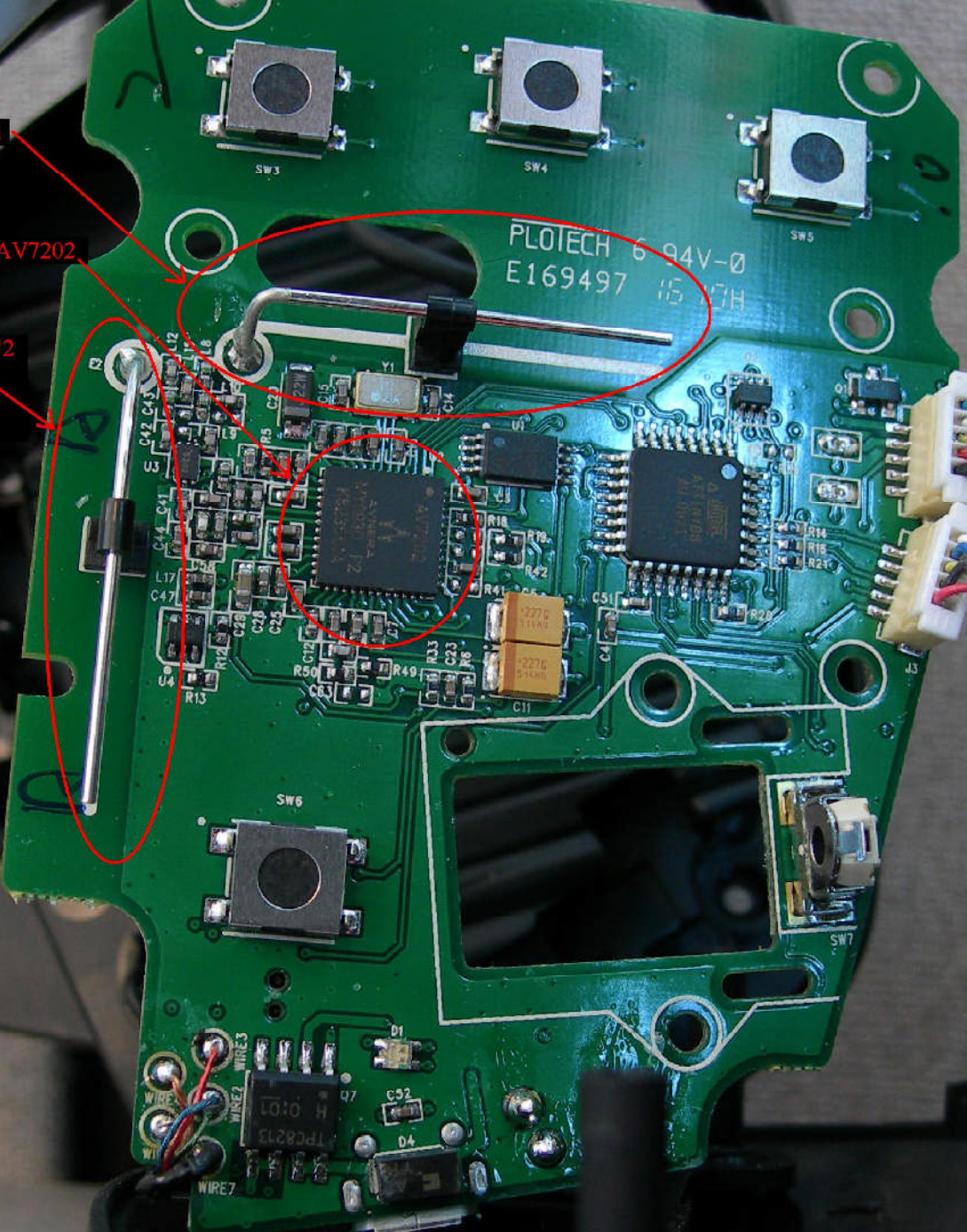

TPC8213  
H 0101

AV7202  
AV7202

2276  
2276