

BV Somfy Zigbee RCU Ysia TDBU 2023 antenna matching

By Jingdong Bi
Universal Electronic Inc.



REDEFINING **CONTROL**

PCBA and case

REDEFINING CONTROL

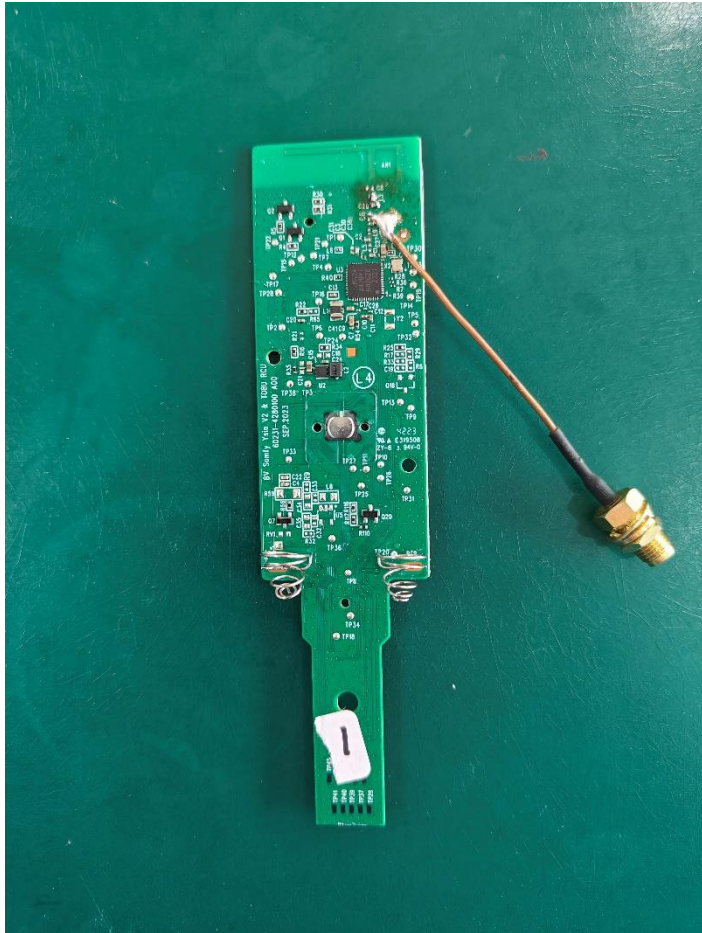

PCBA



PCBA with case

Antenna matching circuits

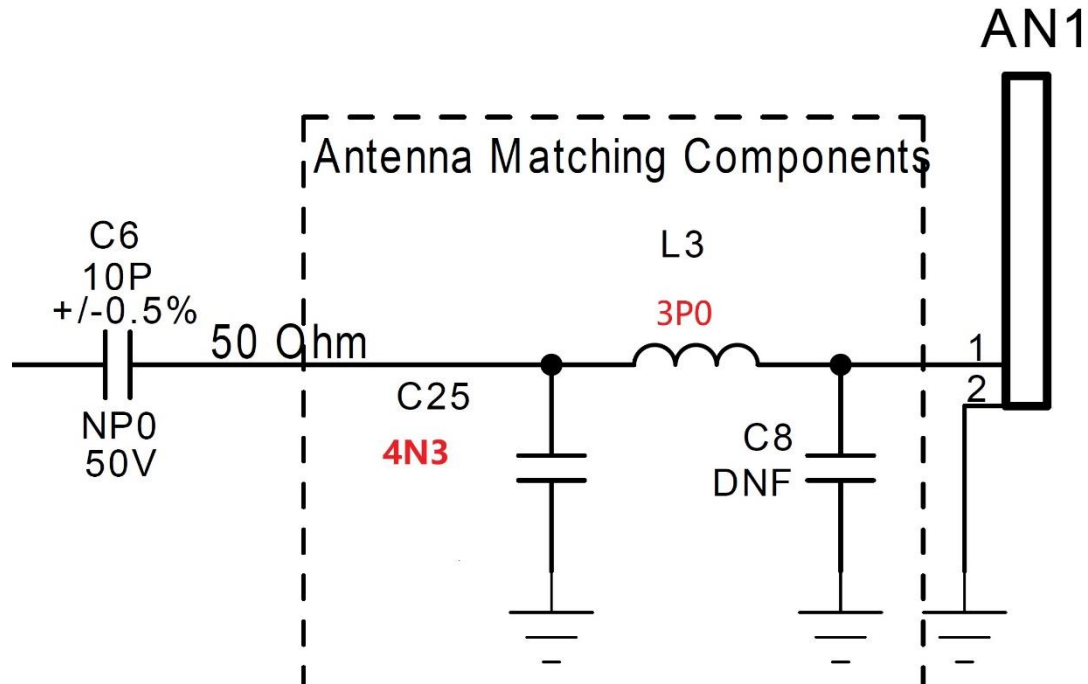

C8: DNF

L3: ceramic cap 0402 , $3.0\text{PF} \pm 0.1\text{PF}$, 50V,NPO

C25: inductor 0402 , $4.3\text{nH} \pm 0.1\text{nH}$,750mA, LQG15HS4N3B02

S parameters without hand

REDEFINING CONTROL

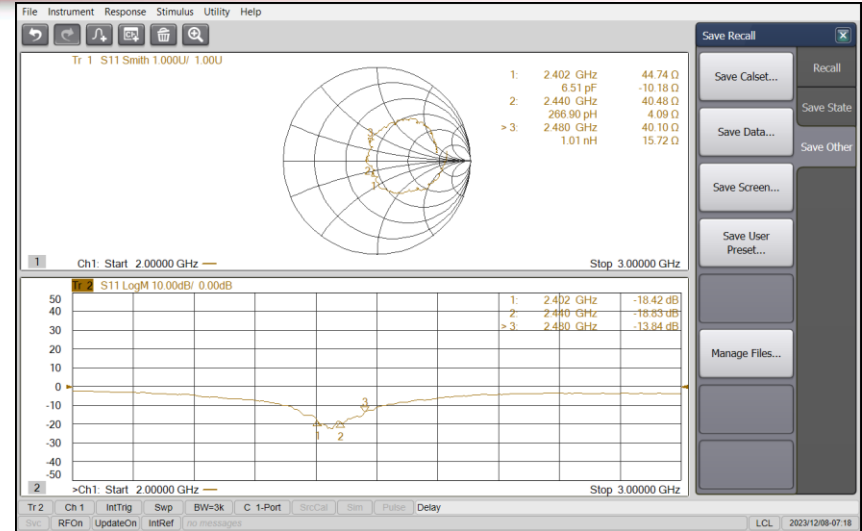
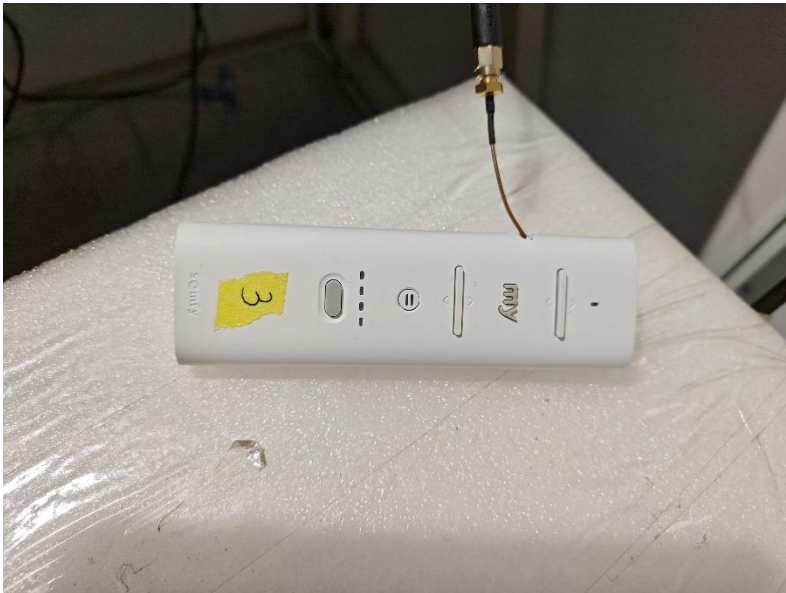

unit1

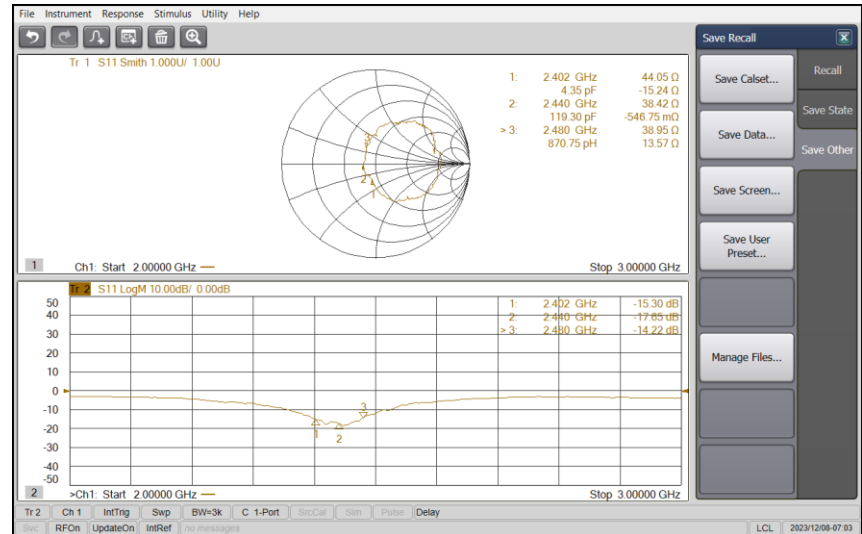

unit2

S parameters with right hand

REDEFINING CONTROL

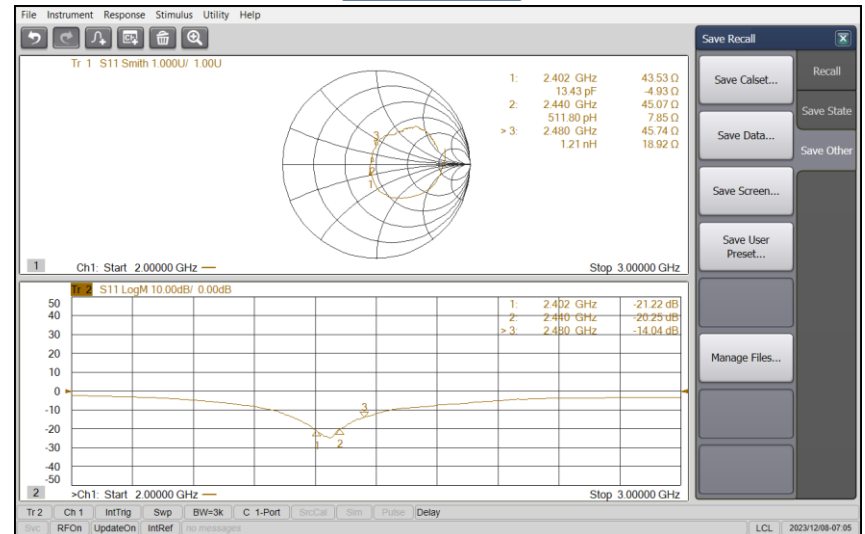
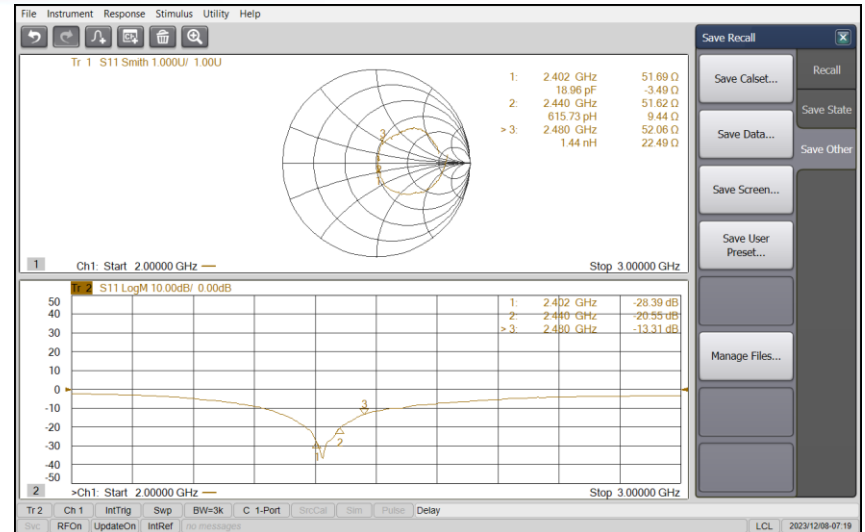
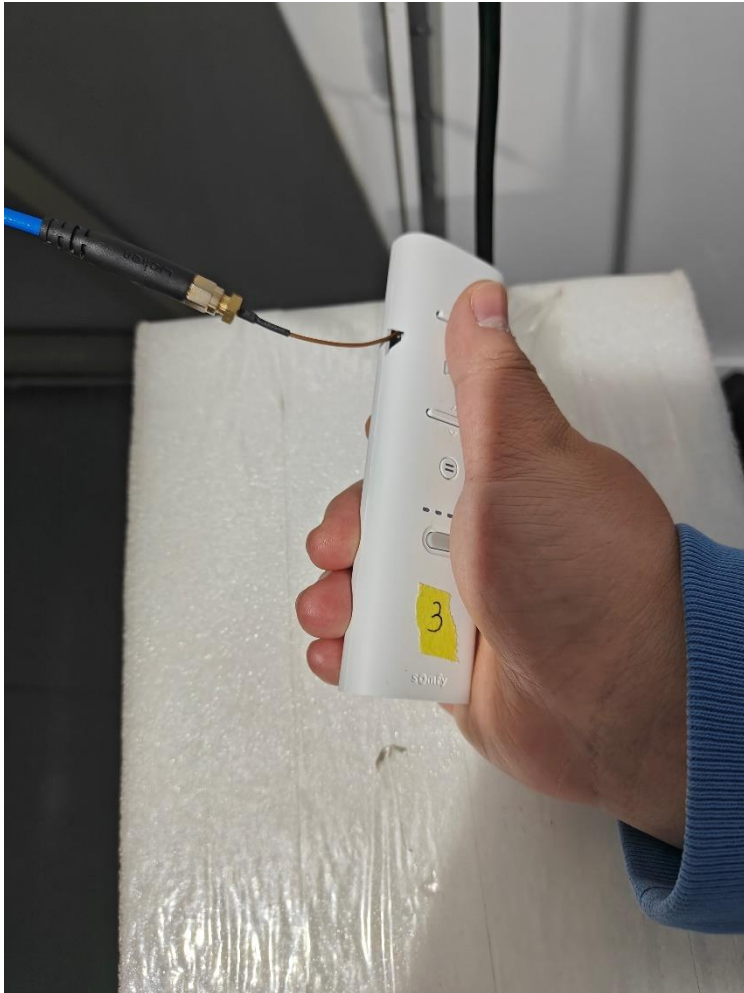

S parameters with left hand

REDEFINING CONTROL

