

Table of Contents

Report Cover Page.....	1
Table of Contents	2
Figures.....	3
1. GENERAL INFORMATION	4
1.1 Verification of Compliance	4
1.2 Equipment Modifications.....	5
1.3 Product Information.....	6
1.4 Test Methodology.....	6
1.5 Test Facility	6
1.6 Test Equipment	6
1.7 Statement for the Document Use.....	7
2. PRODUCT LABELING.....	8
3. SYSTEM TEST CONFIGURATION	9
3.1 Justification	9
3.2 Special Accessories.....	9
3.3 Configuration of Tested System	9
4. SYSTEM SCHEMATICS	12
5. CONDUCTED EMISSION DATA	13
5.1 Test Methods and Conditions	13
5.2 Measurement Instrument Configuration for Conducted Emission.....	13
5.3 Testing Data.....	14
6. RADIATED EMISSION DATA	17
6.1 Field Strength Calculation	17
6.2 Test Methods and Conditions	17
6.3 Test Data	17
6.4 Occupied Bandwidth	18
7. PHOTOS OF TESTED EUT	23

Figures

Figure 2.1 FCC ID Label.....	8
Figure 2.2 Location of Label on Back of the EUT	8
Figure 3.1 Radiated Test Setup	11
Figure 3.2 Conducted Test Setup	11
Figure 4.1 EUT Schematics.....	12
Figure 5.1 Line Conducted.....	15
Figure 5.2 Neutral Conducted	16
Figure 6.1 Bandwidth Plot	19
Figure 6.2 Pulse Train Timing.....	22
Figure 7.1 Front View.....	24
Figure 7.2 Rear View	25
Figure 7.3 Insider View	26
Figure 7.4 Component Side.....	27
Figure 7.5 Foil Side	28

1. GENERAL INFORMATION

1.1 Verification of Compliance

EUT: SOLAR RAIN SENSOR-RTS

Model: 9019617

Applicant: SOMFY SYSTEMS INC.

Result: PASS

Tested by: ADVANCED COMPLIANCE LABORATORY

Test Completion Date: May 19, 2015

Report Number: 0048-150504-01

The above equipment was tested by Compliance Laboratory, Advanced Technologies, Inc. for compliance with the requirement set forth in the FCC rules and regulations Part 15 subpart C. This said equipment in the configuration described in the report, shows the maximum emission levels emanating from equipment are within the compliance requirements.

The estimated uncertainty of the test result is given as following. The method of uncertainty calculation is provided in Advanced Compliance Lab. Doc. No. 0048-01-01.

	Prob. Dist.	Uncertainty(dB)	Uncertainty(dB)	Uncertainty(dB)
		30-1000MHz	1-6.5GHz	Conducted
Combined Std. Uncertainty u_c	norm.	± 2.36	± 2.99	± 1.83

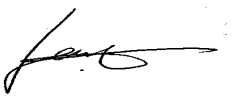

Wei Li
Lab Manager
Advanced Compliance Lab

Date: November 12, 2014

1.2 Equipment Modifications

N/A

1.3 Product Information

System Configuration

ITEM	DESCRIPTION	FCC ID	CABLE
Product	SOLAR RAIN SENSOR-RTS (1)	DWNSRS	
Housing	PLASTICS		
Power Supply	3V DC by Solar Cell		
Operation Freq.	433.4 MHz		
Device Type	Periodic Operation		

(1) EUT submitted for grant.

1.4 Test Methodology

Radiated tests were performed according to the procedures in ANSI C63.4-2009 at an antenna to EUT distance of 3 meters.

1.5 Test Facility

The open area test site and conducted measurement facility used to collect the radiated and conducted data are located at Hillsborough, New Jersey. This site has been accepted by FCC to perform measurements under Part 15 or 18 in a letter dated May 19, 1997 (Refer to: 31040/PRV 1300F2). The NVLAP Lab code for accreditation of FCC EMC Test Method is: 200101-0.

1.6 Test Equipment

Manufacture	Model	Serial No.	Description	Cal Due dd/mm/yy
Hewlett-Packard	HP8546A	3448A00290	EMI Receiver	15/10/15
EMCO	3104C	9307-4396	20-300MHz Biconical Antenna	15/01/16
EMCO	3146	9008-2860	200-1000MHz Log-Periodic Antenna	15/01/16
Electro-Meterics	ALR-25M/30	289	10KHz-30MHz Active Loop Antenna	28/05/15
Fischer Custom	LISN-2	900-4-0008	Line Impedance Stabilization Networks	18/03/16
Fischer Custom	LISN-2	900-4-0009	Line Impedance Stabilization Networks	24/03/16
EMCO	3115	4945	Double Ridge Guide Horn Antenna	22/01/16
Agilent	E4440A	US40420700	PSA Spectrum Analyzer	25/08/15

All Test Equipment Used are Calibrated Traceable to NIST Standards. Calibration interval: 2 year.

1.7 Statement for the Document Use

This report shall not be reproduced except in full, without the written approval of the laboratory. And this report must not be used by the client to claim product endorsement by NVLAP or any agency of the U.S. Government.

2. PRODUCT LABELING

**SOMFY Solar Rain Sensor-RTS
Model: 9019617**

FCC ID: DWNSRS

This device complies with part 15 of the FCC Rules. Operating is subject to the following two conditions: (1) This device may not cause harmful interference, and (2) this device must accept any interference received, including interference that may cause undesired operation.

Figure 2.1 FCC ID Label (statement shown in the manual)

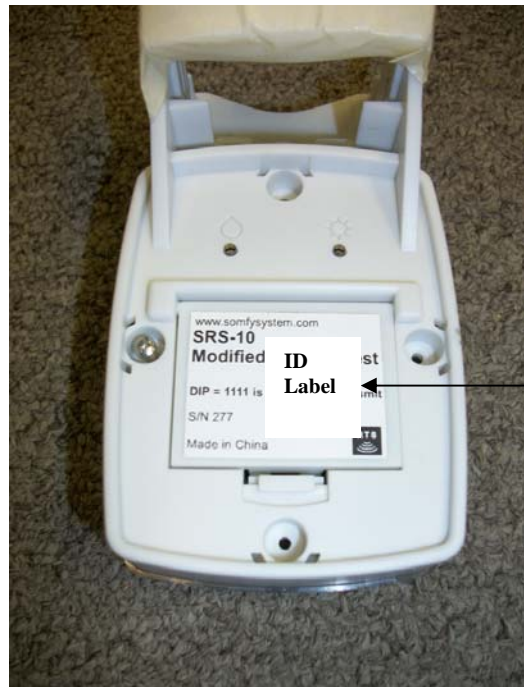

Figure 2.2 FCC ID Label Location

3. SYSTEM TEST CONFIGURATION

3.1 Justification

The product was configured for testing in a typical fashion (as a customer would normally use it). EUT was properly orientated for being tested in the correct plane. Its antenna is permanently connected to PCB.

For this certification, the RTX module drives an external RF circuit whose carrier frequency is 433.42 MHz +/- 100 KHz. The power level of the RF circuit has been set to operate at the level described in FCC 15.231(a). It does not send data.

In normal operation mode, the transmission does stop within 5 seconds after the completion of the transmitting frame.

Emission test was performed as 433.42MHz Tx was operated continuously . Fully charged batteries was used.

3.2 Special Accessories

N/A

3.3 Configuration of Tested System

Figure 3.x illustrate this system, which is tested standing along.





Figure 3.1 Radiated Test Setup

N/A

Figure 3.2 Conducted Test Setup

4. SYSTEM SCHEMATICS

See Attachment.

Figure 4.1 System Schematics

5. CONDUCTED EMISSION DATA

5.1 Test Methods and Conditions

The EUT was under normal operational mode during the conducted emission test. EMI Receiver was scanned from 150KHz to 30MHz with maximum hold mode for maximum emission. Recorded data was sent to the plotter to generate output in linear format. At the input of the spectrum analyzer, a HP transient limiter is inserted for protective purpose. This limiter has a 10 dB attenuation in the range of 150KHZ to 30MHZ. That factor was automatically compensated by the receiver, so the readings are the corrected readings. The reference of the plot is the CISPR 22 Class B limit in Figure 5.1 through Figure 5.2.

Conducted Emission Technical Requirements				
Frequency Range	Class A		Class B	
	Quasi-Peak dBuV	Average dBuV	Quasi-Peak DBuV	Average dBuV
150kHz -0.5MHz	79 (8912uV)	66 (1995uV)	66-56	56-46
0.5MHz-30MHz	73 (4467uV)	60 (1000uV)	---	---
0.5MHz- 5MHz	---	---	56	46 (250uV)
5MHz-30MHz	---	---	60	50

Emissions that have peak values close to the specification limit (if any) are also measured in the quasi-peak mode to determine compliance.

5.2 Measurement Instrument Configuration for Conducted Emission

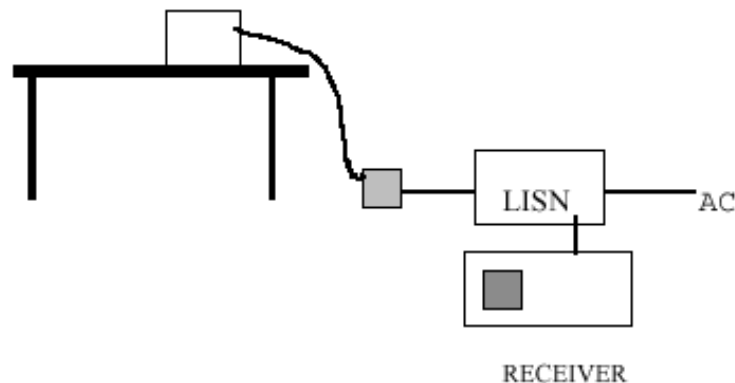

5.3 Testing Data

The following plots show the neutral and line conducted emissions for the typical operation condition (Transmitting and receiving). The conducted test data shows the worst case emissions still below the FCC Part 15/CISPR22 Class B limits.

Not applicable to this product.

Operation Mode: Normal

Fig. 5.1 Line Conducted Emission

NA

Operation Mode: Normal

Fig. 5.2 Neutral Conducted Emission

NA

6. RADIATED EMISSION DATA

6.1 Field Strength Calculation

The corrected field strength is automatically calculated by EMI Receiver using following:

$$FS = RA + AF + CF + AG$$

where FS: Corrected Field Strength in dB μ V/m

RA: Amplitude of EMI Receiver before correction in dB μ V

AF: Antenna Factor in dB/m

CF: Cable Attenuation Factor in dB

AG: Built-in Preamplifier Gain in dB (Stored in receiver as part of the calibration data)

The pulse train timing plots are showed in Figure 6.2.

The pulse train timing plots as follows:

The total time for each pulse train is 139.62 ms, The short pulse is 0.640ms, The middle pulse is 2.5 ms, The long pulse is 4.8ms.

Coeff. = $(55 \times 0.640 + 1 \times 4.8 + 5 \times 2.5) / 100 = 0.525$

The maximum average field strength should be 0.525 of the peak field strength measured. So we use peak value minus 5.6dB as calculated maximum average field strength.

6.2 Test Methods and Conditions

The initial step in collecting radiated data is a EMI Receiver scan of the measurement range below 30MHz using peak detector and 9KHz IF bandwidth / 30KHz video bandwidth. For the range under 1GHz, 120KHz IF bandwidth / 120KHz video bandwidth are used. Both bandwidths are 1MHz for above 1GHz measurement. The frequency range from the lowest clock frequency in EUT circuitry to 10th harmonics were investigated.

6.3 Test Data

The following data lists the significant emission frequencies, polarity and position, peak reading of the EMI Receiver, the FCC limit, and the difference between the peak reading and the limit. Explanation of the correction and calculation are given in section 6.1.

Test Personnel:



Typed/Printed Name: Edward Lee

Date: May 19, 2015

Radiated Test Data

Freq. (MHz)	Worst H/V, Z(1)	Height. (m)	Azimuth	Peak@3m (dBuV/m)	QP/Avg @3m (dBuV/m)	PK Lim (dBuV/m)	QP /Avg. Lim (dBuV/m)	PK Mar (dBuV/m)	QP /Avg.Mar. (dBuV/m)
434(3)	H	1.2	150	78.8	73.2	100.80	80.80	-22	-7.6
868(4)	H	1.1	700	43.5	37.9	80.80	60.80	-37.3	-22.9
1302(2)	H	1.2	160	49.7	44.1	74	54.0	-24.3	-9.9
1736	H	1.1	150	53.1	47.5	80.80	60.80	-27.7	-13.3
2170	H	1.1	140	52.4	46.8	80.80	60.80	-28.4	-14
2604	H	1.1	030	49.7	44.1	74	54.0	-24.3	-9.9
434	V	1.1	220	80.3	74.7	100.80	80.80	-20.5	-6.1
868	V	1.1	240	40.5	34.9	80.80	60.80	-40.3	-25.9
1302	V	1.1	230	47.9	42.3	74	54.0	-26.1	-11.7
1736	V	1.1	220	50.3	44.7	80.80	60.80	-30.5	-16.1
2170	V	1.1	200	48.7	43.1	80.80	60.80	-32.1	-17.7
2604	V	1.1	180	49.5	43.9	74	54.0	-24.5	-10.1

(1) See Figure 3.1, 3.2 and 3.3 for definition of position

(2) Restricted band.

(3) Fundamental limit is 1500-5000 microvolts/meter linear interpolations (average reading) for 260-470 MHz fundamental frequency range; 10965uV/m for 433.4MHz Fundamental. Per FCC 15.231(b).

(4) Spurious limit is 150-500 microvolts/meter linear interpolations (average reading). Per 15.231(b).

6.4 Occupied Bandwidth

The bandwidth of the emission shall be no wider than 0.25% of the center frequency, in this case, 1.0835Hz(433.42x0.25%). Bandwidth is determined at the points 20dB down from the modulated carrier or by containing 99% of the total power of the signal. The occupied bandwidth plots are given as following.



MARKER Δ
355 kHz
-.49 dB

ACTV DET: PEAK
MEAS DET: PEAK QP AVG
MKR Δ 355 kHz
-.49 dB

LOG REF 80.0 dB μ V/m

10
dB/
ATN
10 dB

DL
52.7
dB μ V/m
VA SB
SC FC
ACORR

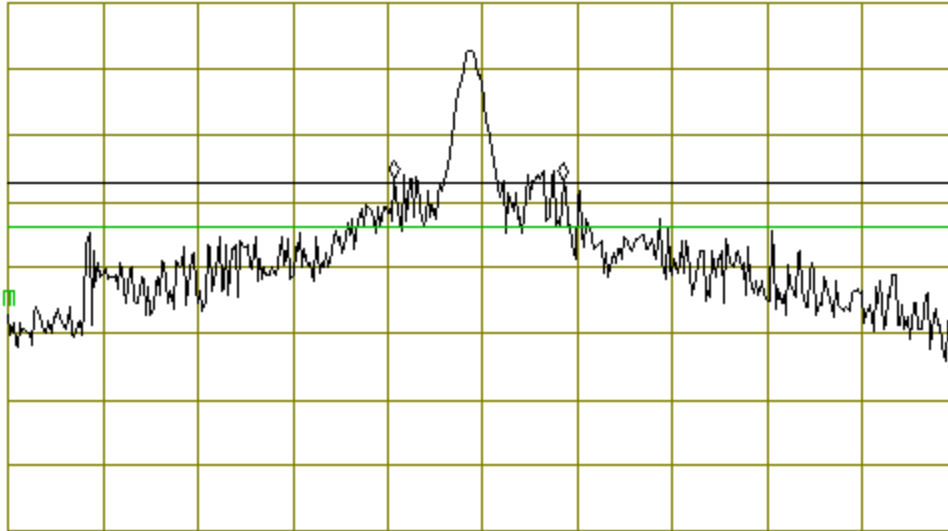

CENTER 433.430 MHz
#IF BW 30 kHz

AVG BW 30 kHz

SPAN 2.000 MHz
SWP 20.0 msec

Figure 6.1 20 dB Occupied Bandwidth



MARKER Δ
147.00 msec
-.05 dB

ACTV DET: PEAK
MEAS DET: PEAK QP AVG
MKR Δ 147.00 msec
-.05 dB

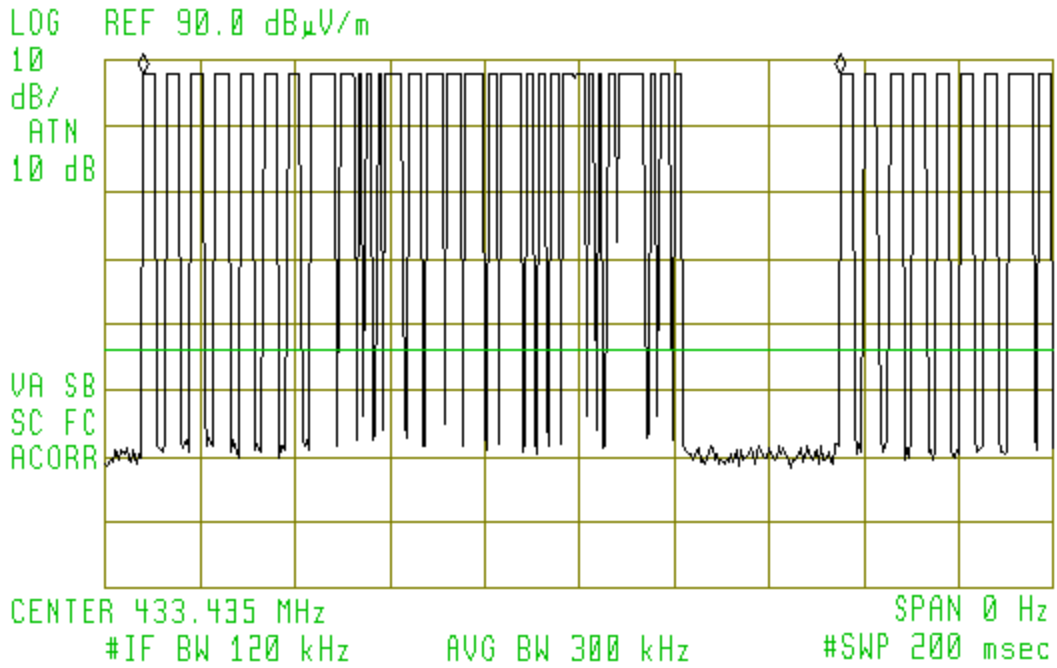

RTS Frame (6 frames in one transmission, min. interval is 5 minutes)

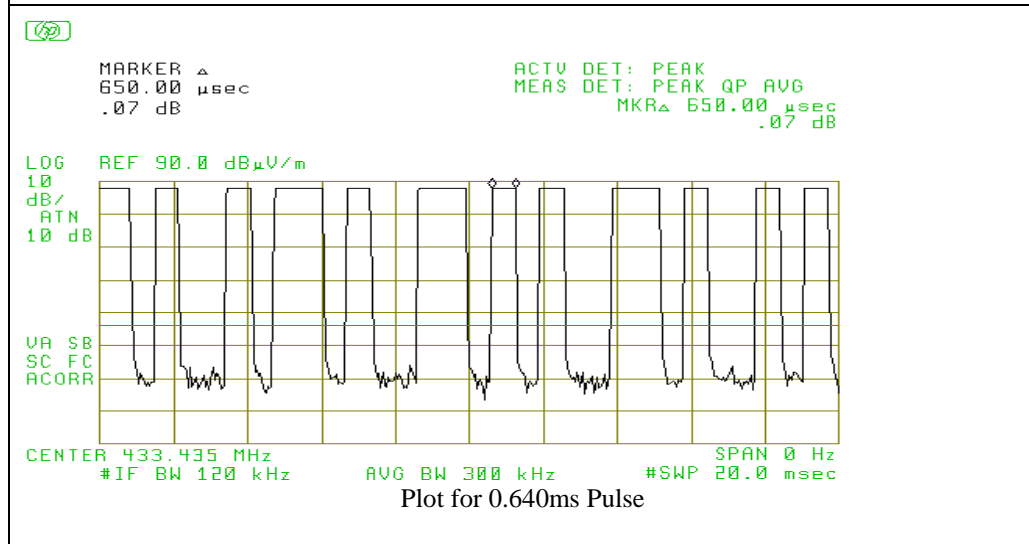
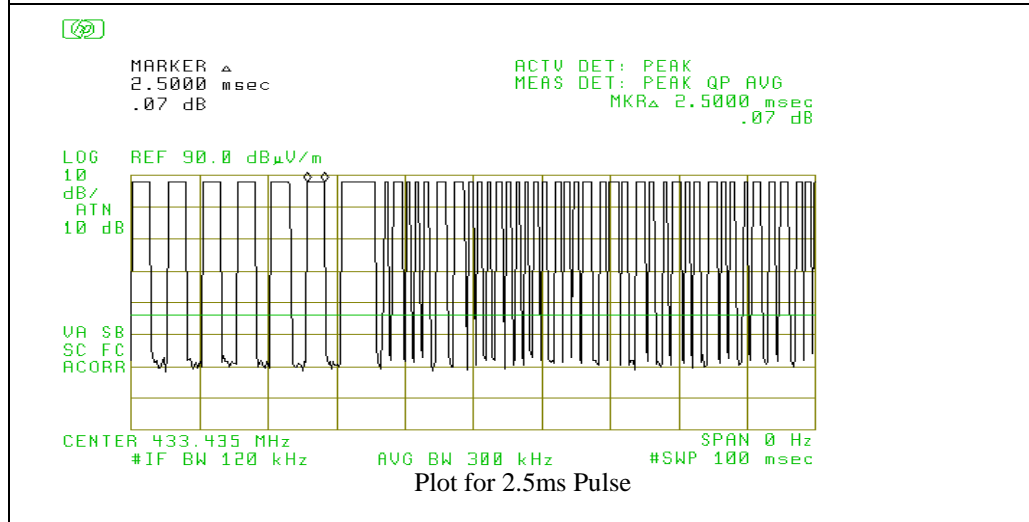
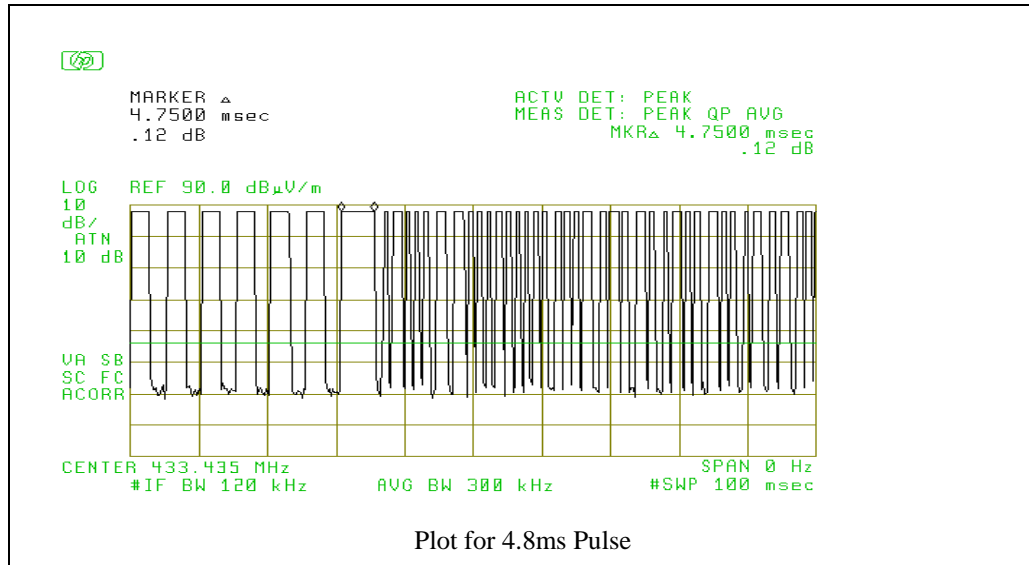

Details and calculations are provided in Operational Description File

Figure 6.2 Pulse Train Timing

7. PHOTOS OF TESTED EUT

The following photos show the inside details of the EUT.