

**Advanced
Compliance Laboratory**

210 Cougar Court
Hillsborough, NJ 08844
Tel: (908) 927 9288
Fax: (908) 927 0728

**ELECTROMAGNETIC EMISSION COMPLIANCE
REPORT**
of

PRODUCT NAME: SITUO 1/SITUO 5/SITUO 5 SOL RTS PURE/IRON
II FCC
MODEL: **SITUORTSII Family**
FCC ID: DWNSITUORTSII IC: 12049A-SITUORTSII (C2PC)

December 6, 2023

<p>This report concerns (check one): Original grant <input type="checkbox"/> Class II change <input checked="" type="checkbox"/></p> <p>Equipment type: <u>Low Power Intentional Radiator</u></p>
<p>Deferred grant requested per 47 CF 0.457(d)(1)(ii)? yes <input type="checkbox"/> no <input checked="" type="checkbox"/></p> <p style="padding-left: 150px;">If yes, defer until: _____ (date)</p> <p>Company agrees to notify the Commission by _____ (date)</p> <p>of the intended date of announcement of the product so that the grant can be issued on that date.</p>
<p>Transition Rules Request per 15.37? yes <input type="checkbox"/> no <input checked="" type="checkbox"/></p> <p>If no, assumed Part 15, Subpart B for unintentional radiators - the new 47 CFR [10-1-90 Edition] provision.</p>
<p>Report prepared for: SOMFY SYSTEMS Inc. Report prepared by: Advanced Compliance Lab Report number: 0048-231114-01</p>



The test result in this report IS supported and covered by the NVLAP accreditation

Table of Contents

Report Cover Page.....	1
Table of Contents	2
Figures.....	3
1. GENERAL INFORMATION	4
1.1 Verification of Compliance	4
1.2 Equipment Modifications	5
1.3 Product Information.....	6
1.4 Test Methodology.....	6
1.5 Test Facility	6
1.6 Test Equipment.....	7
1.7 Statement for the Document Use	7
2. PRODUCT LABELING.....	8
3. SYSTEM TEST CONFIGURATION.....	9
3.1 Justification	9
3.2 Special Accessories.....	9
3.3 Configuration of Tested System	9
4. SYSTEM SCHEMATICS	14
5. CONDUCTED EMISSION DATA	15
5.1 Test Methods and Conditions	15
5.2 Measurement Instrument Configuration for Conducted Emission	15
5.3 Testing Data.....	16
6. RADIATED EMISSION DATA	17
6.1 Field Strength Calculation	17
6.2 Test Methods and Conditions	17
6.3 Test Data	17
6.4 Occupied Bandwidth	19
7. PHOTOS OF TESTED EUT	24

Figures

Figure 2.1 ID Label	8
Figure 2.2 Location of ID Label	8
Figure 3.1 Radiated Test Setup	12
Figure 3.2 Conducted Test Setup	12
Figure 4.1 EUT Schematics	13
Figure 5.1 Line Conducted	15
Figure 5.2 Neutral Conducted	15
Figure 6.1 Bandwidth Plot	19
Figure 6.2 Pulse Train Timing	22
Figure 7.1 Top View	24
Figure 7.2 Bottom View	25
Figure 7.3 Side View	26
Figure 7.4 Cover Open Inside View	27
Figure 7.5 Component Side	28
Figure 7.6 Foil Side	29

1. GENERAL INFORMATION

1.1 Verification of Compliance

EUT: SITUO 1/SITUO 5/SITUO 5 SOL RTS
PURE/IRON II FCC

Model: SITUORTSII Family

Applicant: SOMFY SYSTEMS INC.

Standards: FCC Part 15.231(a) &
IC RSS-210 Issue 10/RSS-Gen Issue 5

Result: PASS (C2PC)

Tested by: ADVANCED COMPLIANCE LABORATORY

Test Completion Date: December 6, 2023

Report Number: 0048-231114-01

The above equipment was tested by Compliance Laboratory, Advanced Technologies, Inc. for compliance with the requirement set forth in the FCC & IC rules and regulations. This said equipment in the configuration described in the report, shows the maximum emission levels emanating from equipment are within the compliance requirements.

The estimated uncertainty of the test result is given as following. The method of uncertainty calculation is provided in Advanced Compliance Lab. Doc. No. 0048-01-01.

	Prob. Dist.	Uncertainty(dB)	Uncertainty(dB)	Uncertainty(dB)
		30-1000MHz	1-6.5GHz	Conducted
Combined Std. Uncertainty u_c	norm.	± 2.36	± 2.99	± 1.83

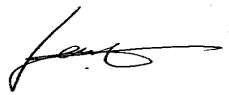

Wei Li
Lab Manager
Advanced Compliance Lab

Date: December 6, 2023

1.2 Equipment Modifications

N/A

1.3 Product Information

System Configuration

ITEM	DESCRIPTION	ID	CABLE
Product	Situo 1/Situo 5/Situo 5 Sol RTS Pure/Iron II FCC: SITUORTSII	FCC ID: DWN-SITUORTSII IC: 12049A-SITUORTSII	
Housing	PLASTICS		
Power Supply	3Vdc CR2032 Lithium Battery		
Operation Freq.	433.42 MHz		
Device Type	Periodic Operation		

(1) EUT submitted for Family Grant with following models:

Remote Control	Parts #
Situo 1 RTS Pure II FCC Situo 1 RTS Iron II FCC	5165720A 5166612A
Situo 5 RTS Pure II FCC Situo 5 RTS Iron II FCC	5165727A 5166615A
Situo 5 Sol RTS Pure II FCC	5165729A

Model differences:

Situo 1 has 1 RF address. Situo 5 has 5 RF addresses. Situo 5 Sol has 5 RF Addresses along with sun control function. All of them have the same Radio PCB layout, radio frequency & RF power setting. There are minor difference in digital PCB circuitry (non-radio function) among Situo 1, Situo 5 and Situo 5 Sol.

Pure and Iron represent different colors of plastic enclosures but electrical identical.

This version of EUT has minor changes on PCB component values.

1.4 Test Methodology

Radiated tests were performed according to the procedures in ANSI C63.4-2014/C63.10-2013 at an antenna to EUT distance of 3 meters.

1.5 Test Facility

The open area test site and conducted measurement facility used to collect the radiated and conducted data are located at Hillsborough, New Jersey, USA. This site is accepted by FCC to perform measurements under Part 15 or 18 (MRA designation No. US5347)

and also designated by ISED with CAB ID# US0100 (test site # IC 3130A). The NVLAP Lab code for accreditation of FCC EMC Test Method is: 200101-0.

1.6 Test Equipment

Manufacture	Model	Serial No.	Description	Cal Due dd/mm/yy
Hewlett-Packard	HP8546A	3448A00290	EMI Receiver	15/10/24
EMCO	3104C	9307-4396	20-300MHz Biconical Antenna	15/01/24
EMCO	3146	9008-2860	200-1000MHz Log-Periodic Antenna	15/01/24
Electro-Meterics	ALR-25M/30	289	10KHz-30MHz Active Loop Antenna	28/05/24
Fischer Custom	LISN-2	900-4-0008	Line Impedance Stabilization Networks	18/03/24
Fischer Custom	LISN-2	900-4-0009	Line Impedance Stabilization Networks	24/03/24
EMCO	3115	4945	Double Ridge Guide Horn Antenna	22/01/24
Agilent	E4440A	US40420700	PSA Spectrum Analyzer	25/08/24

All Test Equipment Used are Calibrated Traceable to NIST Standards.
Standard Calibration interval: 2 year.

1.7 Statement for the Document Use

This report shall not be reproduced except in full, without the written approval of the laboratory. And this report must not be used by the client to claim product endorsement by NVLAP or any agency of the U.S. & Canada Governments.

2. PRODUCT LABELING

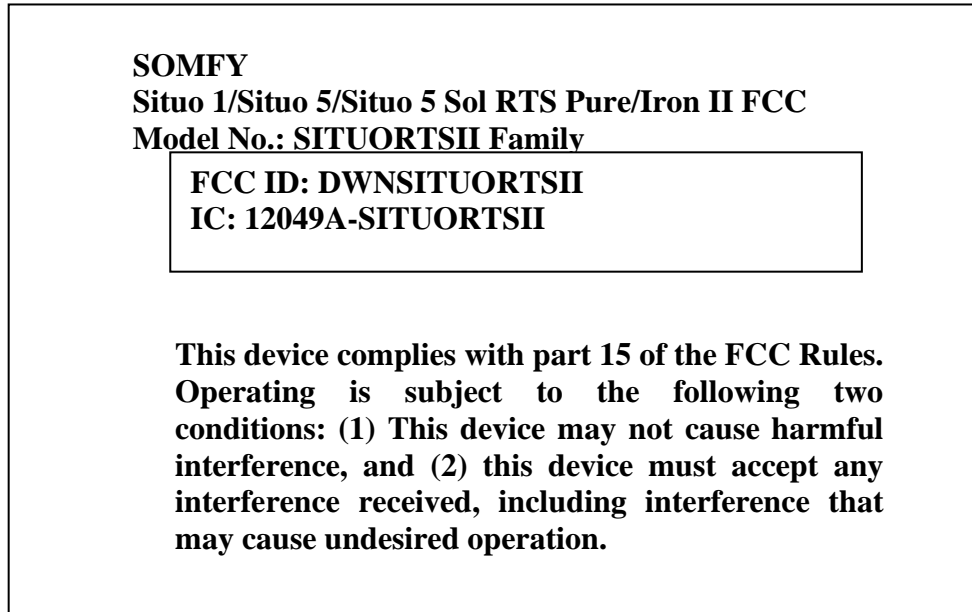

Figure 2.1 ID Label
(statement shown in the manual)



Figure 2.2 ID Label Location

3. SYSTEM TEST CONFIGURATION

3.1 Justification

The product was configured for testing in a typical fashion (as a customer would normally use it). EUT was properly orientated for being tested in the correct plane. Its antenna is permanently affixed on PCB.

For this certification, the RTX module drives an external RF circuit whose carrier frequency is 433.42 MHz +/- 100 KHz. The power level of the RF circuit has been set to operate at the level described in FCC 15.231(a). It does not send data.

In normal operation mode, the transmission does stop within 5 seconds after the transmission is deactivated.

Emission test was performed as 433.42MHz Tx was operated continuously. Fresh batteries were used during the test.

3.2 Special Accessories

N/A

3.3 Configuration of Tested System

Figure 3.x illustrate this system, which is tested standing along.



Z Orientation



Y Orientation



X Orientation



Figure 3.1 Radiated Test Setup

N/A

Figure 3.2 Conducted Test Setup

4. SYSTEM SCHEMATICS

See Attachment.

Figure 4.1 System Schematics

5. CONDUCTED EMISSION DATA

5.1 Test Methods and Conditions

The EUT was under normal operational mode during the conducted emission test. EMI Receiver was scanned from 150KHz to 30MHz with maximum hold mode for maximum emission. Recorded data was sent to the plotter to generate output in linear format. At the input of the spectrum analyzer, a HP transient limiter is inserted for protective purpose. This limiter has a 10 dB attenuation in the range of 150KHZ to 30MHZ. That factor was automatically compensated by the receiver, so the readings are the corrected readings. The reference of the plot is the CISPR 22 Class B limit in Figure 5.1 through Figure 5.2.

Conducted Emission Technical Requirements				
Frequency Range	Class A		Class B	
	Quasi-Peak dBuV	Average dBuV	Quasi-Peak DBuV	Average dBuV
150kHz -0.5MHz	79 (8912uV)	66 (1995uV)	66-56	56-46
0.5MHz-30MHz	73 (4467uV)	60 (1000uV)	---	---
0.5MHz- 5MHz	---	---	56	46 (250uV)
5MHz-30MHz	---	---	60	50

Emissions that have peak values close to the specification limit (if any) are also measured in the quasi-peak mode to determine compliance.

5.2 Measurement Instrument Configuration for Conducted Emission

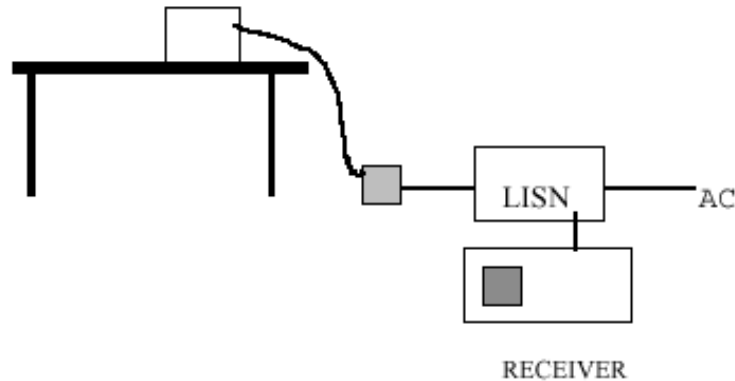

5.3 Testing Data

The following plots show the neutral and line conducted emissions for the typical operation condition (Transmitting and receiving). The conducted test data shows the worst case emissions still below the FCC Part 15/ CISPR32 Class B limits.

Not applicable to this product.

Operation Mode: Normal

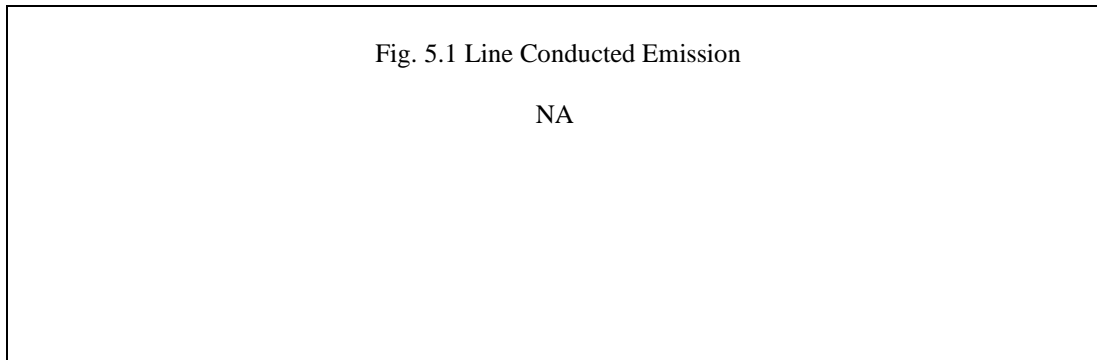

Operation Mode: Normal

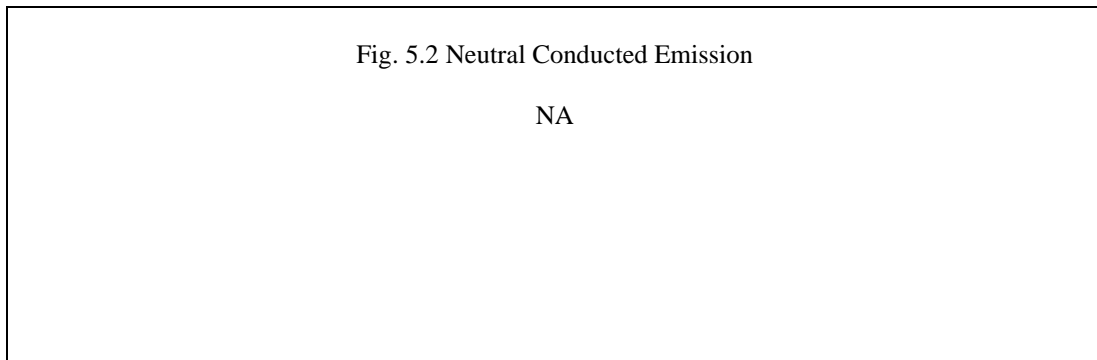

6. RADIATED EMISSION DATA

6.1 Field Strength Calculation

The corrected field strength is automatically calculated by EMI Receiver using following:

$$FS = RA + AF + CF + AG$$

where FS: Corrected Field Strength in dB μ V/m

RA: Amplitude of EMI Receiver before correction in dB μ V

AF: Antenna Factor in dB/m

CF: Cable Attenuation Factor in dB

AG: Built-in Pre-amplifier Gain in dB (Stored in receiver as part of the calibration data)

The pulse train timing plots are showed in Figure 6.2.

The pulse train timing plots as follows:

The total time for each pulse train is 139.62 ms, The short pulse is 0.640ms, The middle pulse is 2.5 ms, The long pulse is 4.8ms.

Coeff. $= (55 \times 0.640 + 1 \times 4.8 + 5 \times 2.5) / 100 = 0.525$

The maximum average field strength should be 0.525 of the peak field strength measured. So we use peak value minus 5.6dB as calculated maximum average field strength.

6.2 Test Methods and Conditions

The initial step in collecting radiated data is a EMI Receiver scan of the measurement range below 30MHz using peak detector and 9KHz IF bandwidth / 30KHz video bandwidth. For the range under 1GHz, 120KHz IF bandwidth / 120KHz video bandwidth are used. Both bandwidths are 1MHz for above 1GHz measurement. The frequency range from the lowest clock frequency in EUT circuitry to 10th harmonics were investigated.

6.3 Test Data

The following data lists the significant emission frequencies, polarity and position, peak reading of the EMI Receiver, the FCC limit, and the difference between the peak reading and the limit. Explanation of the correction and calculation are given in section 6.1.

Test Personnel:



Typed/Printed Name: Edward Lee

Date: December 6, 2023,

Radiated Test Data (worst case): LET Version 5C

Position : X

Freq. (MHz)	Worst H/V, X(1)	Height. (m)	Azimuth	Peak@3m (dBuV/m)	QP/Avg @3m (dBuV/m)	PK Lim (dBuV/m)	QP /Avg. Lim (dBuV/m)	PK Mar (dBuV/m)	QP /Avg.Mar. (dBuV/m)
433.4(3)	H	1.1	090	79.5	73.9	100.8	80.8	-21.3	-6.9
866.9(4)	H	1.1	235	33.6	28	80.8	60.8	-47.2	-32.8
1300.4(2)	H	1.1	000	39.2	33.6	74.0	54.0	-34.8	-20.4
1733.9(4)	H	1.1	000	42.1	36.5	80.8	60.8	-38.7	-24.3
2167(4)	H	1.1	000	48.5	42.9	80.8	60.8	-32.3	-17.9
433.4	V	1.2	090	67.8	62.2	100.8	80.8	-33	-18.6
866.9	V	1.1	090	33.5	27.9	80.8	60.8	-47.3	-32.9
1300.4	V	1.1	090	38.6	33	74.0	54.0	-35.4	-21
1733.9	V	1.1	000	39.0	33.4	80.8	60.8	-41.8	-27.4
2167	V	1.1	000	41.2	35.6	80.8	60.8	-39.6	-25.2

(1) See Figure 3.1, 3.2 and 3.3 for definition of position

(2) Restricted band.

(3) Fundamental limit is 1500-5000 microvolts/meter linear interpolations (average reading) for 260-470 MHz fundamental frequency range; 10965uV/m for 433.4MHz Fundamental. Per FCC 15.231(b) & RSS-210 A1.1 Table A.

(4) Spurious limit is 150-500 microvolts/meter linear interpolations (average reading). Per 15.231(b) & RSS-210 A1.1 Table A.

Position : Y

Freq. (MHz)	Worst H/V, Y(1)	Height. (m)	Azimuth	Peak@3m (dBuV/m)	QP/Avg @3m (dBuV/m)	PK Lim (dBuV/m)	QP /Avg. Lim (dBuV/m)	PK Mar (dBuV/m)	QP /Avg.Mar. (dBuV/m)
433.4(3)	H	1.1	180	85.7	80.1	100.8	80.8	-15.1	-0.7
866.9(4)	H	1.1	180	34.0	28.4	80.8	60.8	-46.8	-32.4
1300.4(2)	H	1.1	135	43.0	37.4	74.0	54.0	-31	-16.6
1733.9(4)	H	1.1	135	43.9	38.3	80.8	60.8	-36.9	-22.5
2167(4)	H	1.1	235	48.8	43.2	80.8	60.8	-32	-17.6
433.4	V	1.2	045	69.7	64.1	100.8	80.8	-31.1	-16.7
866.9	V	1.1	045	32.5	26.9	80.8	60.8	-48.3	-33.9
1300.4	V	1.1	045	32.6	27	74.0	54.0	-41.4	-27
1733.9	V	1.1	000	40.2	34.6	80.8	60.8	-40.6	-26.2
2167	V	1.1	180	45.7	40.1	80.8	60.8	-35.1	-20.7

(1) See Figure 3.1, 3.2 and 3.3 for definition of position

(2) Restricted band.

(3) Fundamental limit is 1500-5000 microvolts/meter linear interpolations (average reading) for 260-470 MHz fundamental frequency range; 10965uV/m for 433.4MHz Fundamental. Per FCC 15.231(b) & RSS-210 A1.1 Table A.

(4) Spurious limit is 150-500 microvolts/meter linear interpolations (average reading). Per 15.231(b) & RSS-210 A1.1 Table A.

Position : Z

Freq. (MHz)	Worst H/V, Z(1)	Height. (m)	Azimuth	Peak@3m (dBuV/m)	QP/Avg @3m (dBuV/m)	PK Lim (dBuV/m)	QP /Avg. Lim (dBuV/m)	PK Mar (dBuV/m)	QP /Avg.Mar. (dBuV/m)
433.4(3)	H	1.1	180	64.9	59.3	100.8	80.8	-35.9	-21.5
866.9(4)	H	1.1	180	32.0	26.4	80.8	60.8	-48.8	-34.4
1300.4(2)	H	1.1	200	41.9	36.3	74.0	54.0	-32.1	-17.7
1733.9(4)	H	1.1	200	43.4	37.8	80.8	60.8	-37.4	-23
2167(4)	H	1.1	180	46.6	41	80.8	60.8	-34.2	-19.8
433.4	V	1.2	090	83.9	78.3	100.8	80.8	-16.9	-2.5
866.9	V	1.1	090	32.5	26.9	80.8	60.8	-48.3	-33.9
1300.4	V	1.1	045	42.0	36.4	74.0	54.0	-32	-17.6
1733.9	V	1.1	045	41.7	36.1	80.8	60.8	-39.1	-24.7
2167	V	1.1	045	48.6	43	80.8	60.8	-32.2	-17.8

- (1) See Figure 3.1, 3.2 and 3.3 for definition of position
- (2) Restricted band.
- (3) Fundamental limit is 1500-5000 microvolts/meter linear interpolations (average reading) for 260-470 MHz fundamental frequency range; 10965uV/m for 433.4MHz Fundamental. Per FCC 15.231(b) & RSS-210 A1.1 Table A.
- (4) Spurious limit is 150-500 microvolts/meter linear interpolations (average reading). Per 15.231(b) & RSS-210 A1.1 Table A.

6.4 Occupied Bandwidth

The bandwidth of the emission shall be no wider than 0.25% of the center frequency, in this case, 1.0835Hz(433.42x0.25%). Bandwidth is determined at the points 20dB down from the modulated carrier or by containing 99% of the total power of the signal. The occupied bandwidth plots are given as following.

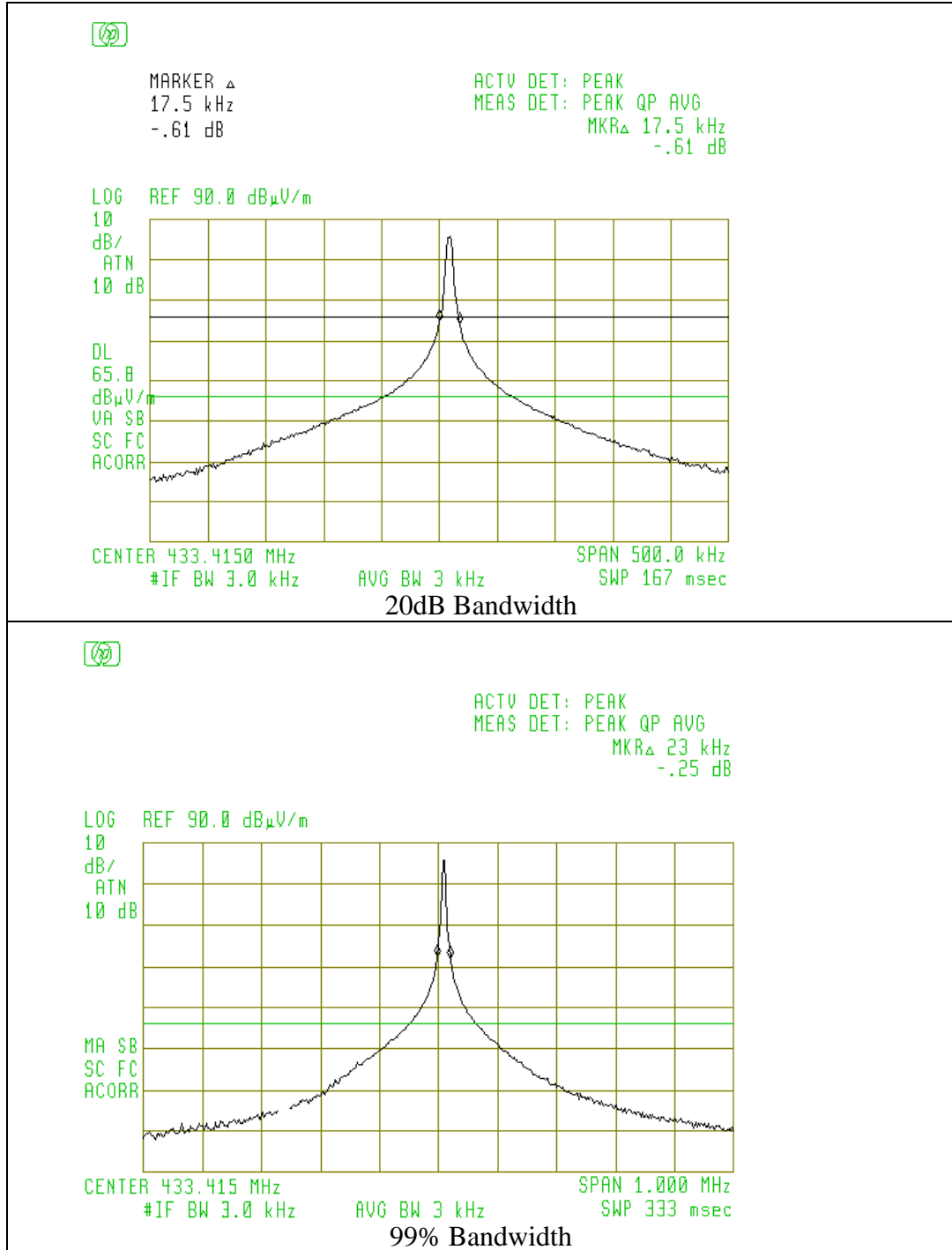
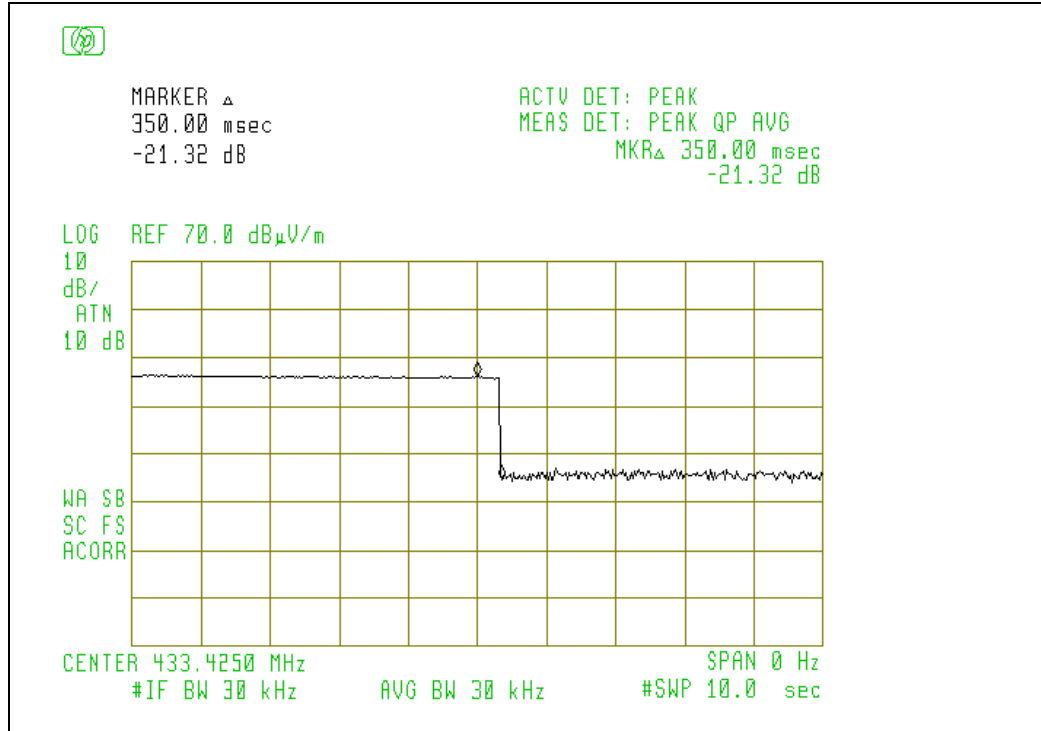
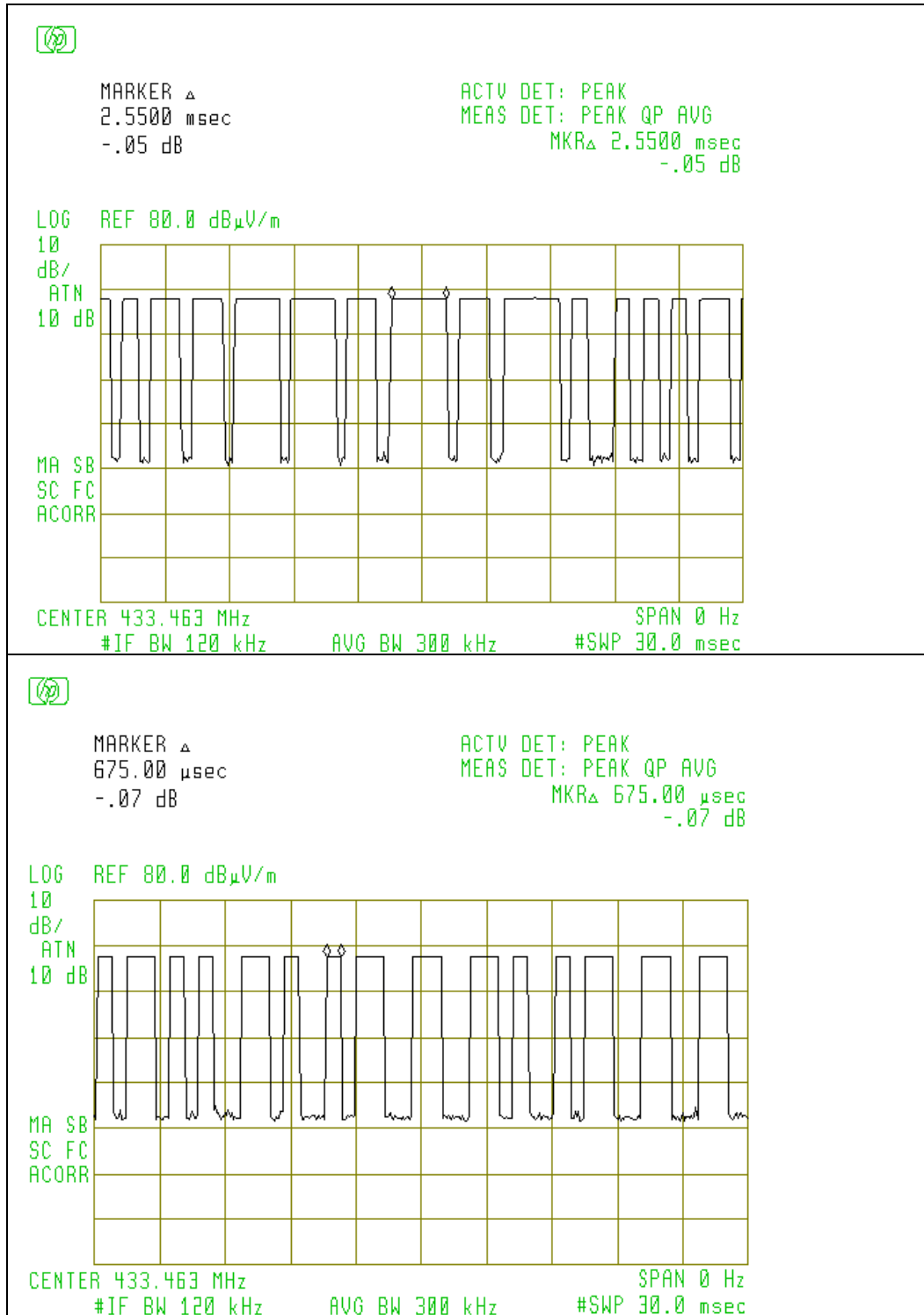

Figure 6.1 Occupied Bandwidth



Tx stopped within 5s after deactivated

Pulse Train:



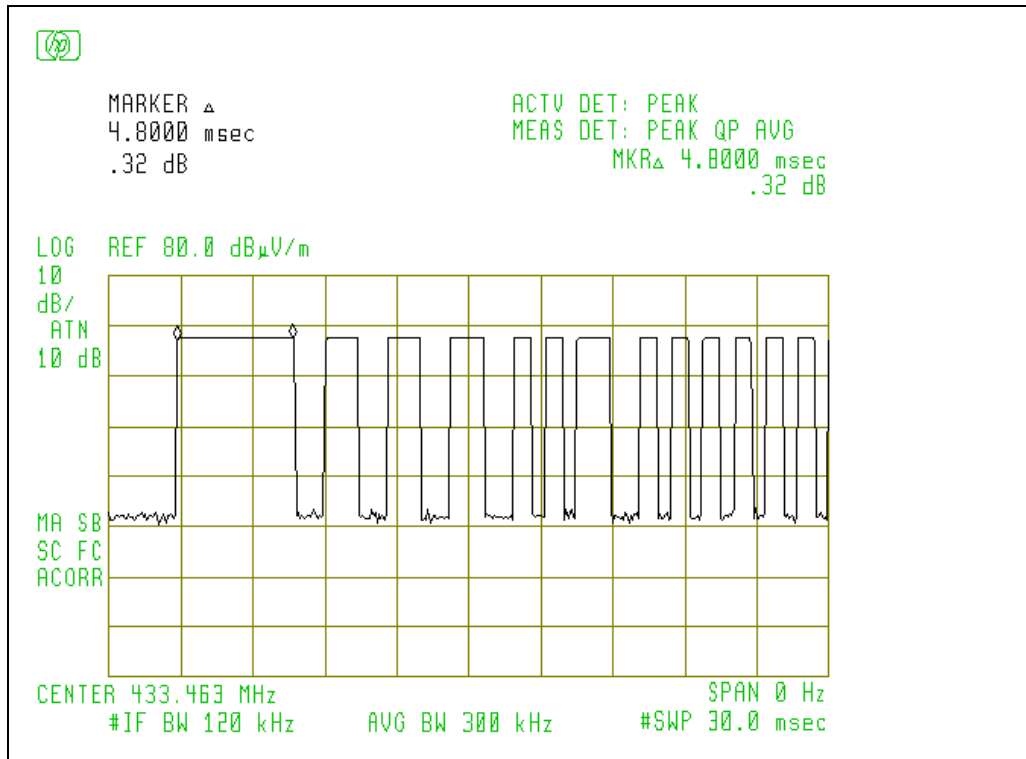

Figure 6.2 Pulse Train Timing