Table of Contents

Report Cover Page.....	1
Table of Contents	2
Figures.....	3
1. GENERAL INFORMATION	4
1.1 Verification of Compliance	4
1.2 Equipment Modifications.....	5
1.3 Product Information.....	6
1.4 Test Methodology.....	6
1.5 Test Facility	6
1.6 Test Equipment	6
1.7 Statement for the Document Use.....	7
2. PRODUCT LABELING.....	8
3. SYSTEM TEST CONFIGURATION	9
3.1 Justification	9
3.2 Special Accessories.....	9
3.3 Configuration of Tested System	9
4. SYSTEM SCHEMATICS	15
5. CONDUCTED EMISSION DATA	16
5.1 Test Methods and Conditions	16
5.2 Measurement Instrument Configuration for Conducted Emission.....	16
5.3 Testing Data.....	17
6. RADIATED EMISSION DATA	20
6.1 Field Strength Calculation	20
6.2 Test Methods and Conditions	20
6.3 Test Data	20
6.4 Occupied Bandwidth	22
7. PHOTOS OF TESTED EUT	27

Figures

Figure 2.1 FCC ID Label.....	8
Figure 2.2 Location of Label on Back of the EUT	8
Figure 3.1 Radiated Test Setup	11
Figure 3.2 Conducted Test Setup	11
Figure 4.1 EUT Schematics.....	12
Figure 5.1 Line Conducted.....	15
Figure 5.2 Neutral Conducted	16
Figure 6.1 Bandwidth Plot	23
Figure 6.2 Pulse Train Timing.....	24
Figure 7.1+ EUT Photos	28+

1. GENERAL INFORMATION

1.1 Verification of Compliance

EUT: REMOTE CONTROL

Model: TELIS 4 & TELIS 1 MOD/VAR US PURE
(Ref: 5128156A & 5128157A)

Applicant: SOMFY SYSTEM INC.

Test Requirement(s): FCC Part 15 Sub Part B, Sec. 15.231(a)

Result: PASS

Tested by: ADVANCED COMPLIANCE LABORATORY

Test Completion Date: December 02, 2016

Report Number: 0048-161123-01-FCC

The above equipment was tested by Compliance Laboratory, Advanced Technologies, Inc. for compliance with the requirement set forth in the FCC rules and regulations Part 15 subpart C. This said equipment in the configuration described in the report, shows the maximum emission levels emanating from equipment are within the compliance requirements.

The estimated uncertainty of the test result is given as following. The method of uncertainty calculation is provided in Advanced Compliance Lab. Doc. No. 0048-01-01.

	Prob. Dist.	Uncertainty(dB)	Uncertainty(dB)	Uncertainty(dB)
		30-1000MHz	1-6.5GHz	Conducted
Combined Std. Uncertainty u_c	norm.	± 2.36	± 2.99	± 1.83

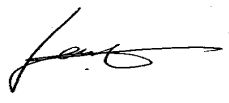

Wei Li
Lab Manager
Advanced Compliance Lab

Date: 12/02/2016

1.2 Equipment Modifications

N/A

1.3 Product Information

System Configuration

ITEM	DESCRIPTION	FCC ID	CABLE
Product	REMOTE CONTROL Telis 4& Telis1 MOD/VAR US PURE ⁽¹⁾	DWNMOD1	
Housing	PLASTICS		
Power Supply	3V DC Lithium Cell: CR2430		
Operation Freq.	433.4 MHz		
Device Type	Periodic Operation		

(1) EUT submitted for grant.

1.4 Test Methodology

Radiated tests were performed according to the procedures in ANSI C63.4-2014/C63.10-2013 at an antenna to EUT distance of 3 meters.

1.5 Test Facility

The open area test site and conducted measurement facility used to collect the radiated and conducted data are located at Hillsborough, New Jersey. This site has been accepted by FCC to perform measurements under Part 15 or 18 in a letter dated May 19, 1997 (Refer to: 31040/PRV 1300F2). The NVLAP Lab code for accreditation of FCC EMC Test Method is: 200101-0.

1.6 Test Equipment

Manufacture	Model	Serial No.	Description	Cal Due dd/mm/yy
Hewlett-Packard	HP8546A	3448A00290	EMI Receiver	15/10/17
EMCO	3104C	9307-4396	20-300MHz Biconical Antenna	15/01/17
EMCO	3146	9008-2860	200-1000MHz Log-Periodic Antenna	15/01/17
Electro-Meterics	ALR-25M/30	289	10KHz-30MHz Active Loop Antenna	28/05/17
Fischer Custom	LISN-2	900-4-0008	Line Impedance Stabilization Networks	18/03/17
COM-POWER	L1215A	191994	Line Impedance Stabilization Networks	24/03/18
EMCO	3115	4945	Double Ridge Guide Horn Antenna	22/01/17
Agilent	E4440A	US40420700	PSA Spectrum Analyzer	25/08/17

All Test Equipment Used are Calibrated Traceable to NIST Standards. Calibration interval: 2 year.

1.7 Statement for the Document Use

This report shall not be reproduced except in full, without the written approval of the laboratory. And this report must not be used by the client to claim product endorsement by NVLAP or any agency of the U.S. Government.

2. PRODUCT LABELING

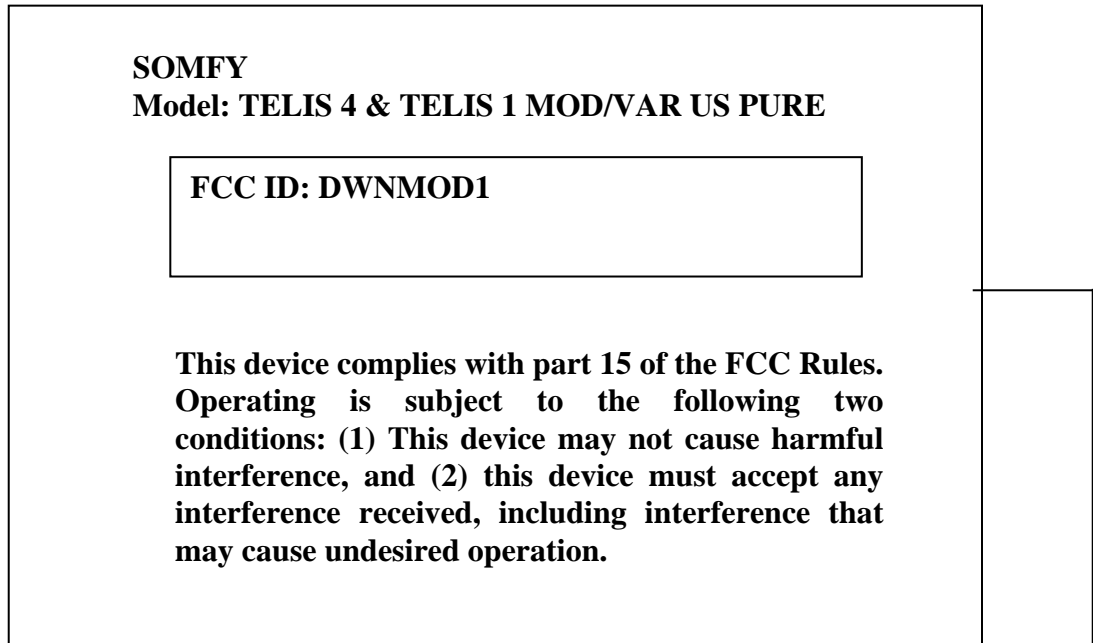

Figure 2.1 FCC ID Label (statement shown in the manual)



Figure 2.2 FCC ID Label Location

3. SYSTEM TEST CONFIGURATION

3.1 Justification

The product was configured for testing in a typical fashion (as a customer would normally use it). EUT was properly orientated for being tested in the correct plane. Its antenna is permanently connected to PCB.

For this certification, the RTX module drives an external RF circuit whose carrier frequency is 433.42 MHz +/- 100 KHz. The power level of the RF circuit has been set to operate at the level described in FCC 15.231(a). It does not send data.

In normal operation mode, the transmission does stop within 5 seconds after the completion of the transmitting frame.

The TELIS 1 & TELIS 4 have the same RF circuitry design except TELIS 1 has LED display removed. Prescan shows the worst case is TELIS 4 operation mode, which was used for final data collection.

Emission test was performed as 433.4 MHz Tx was operated continuously . Fully charged battery was used.

3.2 Special Accessories

N/A

3.3 Configuration of Tested System

Figure 3.x illustrate this system, which is tested standing along.



X- Position



Y-Position



Z-Position







Figure 3.1 Radiated Test Setup

N/A
Figure 3.2 Conducted Test Setup

4. SYSTEM SCHEMATICS

See Attachment.

Figure 4.1 System Schematics

5. CONDUCTED EMISSION DATA

5.1 Test Methods and Conditions

The EUT was under normal operational mode during the conducted emission test. EMI Receiver was scanned from 150KHz to 30MHz with maximum hold mode for maximum emission. Recorded data was sent to the plotter to generate output in linear format. At the input of the spectrum analyzer, a HP transient limiter is inserted for protective purpose. This limiter has a 10 dB attenuation in the range of 150KHZ to 30MHZ. That factor was automatically compensated by the receiver, so the readings are the corrected readings. The reference of the plot is the CISPR 22 Class B limit in Figure 5.1 through Figure 5.2.

Conducted Emission Technical Requirements				
Frequency Range	Class A		Class B	
	Quasi-Peak dBuV	Average dBuV	Quasi-Peak DBuV	Average dBuV
150kHz -0.5MHz	79 (8912uV)	66 (1995uV)	66-56	56-46
0.5MHz-30MHz	73 (4467uV)	60 (1000uV)	---	---
0.5MHz- 5MHz	---	---	56	46 (250uV)
5MHz-30MHz	---	---	60	50

Emissions that have peak values close to the specification limit (if any) are also measured in the quasi-peak mode to determine compliance.

5.2 Measurement Instrument Configuration for Conducted Emission

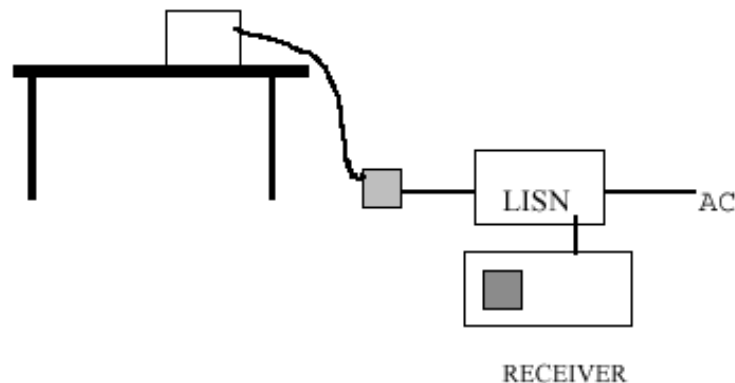

5.3 Testing Data

The following plots show the neutral and line conducted emissions for the typical operation condition (Transmitting and receiving). The conducted test data shows the worst case emissions still below the FCC Part 15/CISPR22 Class B limits.

Not applicable to this product.

Operation Mode: Normal

Fig. 5.1 Line Conducted Emission

NA

Operation Mode: Normal

Fig. 5.2 Neutral Conducted Emission

NA

6. RADIATED EMISSION DATA

6.1 Field Strength Calculation

The corrected field strength is automatically calculated by EMI Receiver using following:

$$FS = RA + AF + CF + AG$$

where FS: Corrected Field Strength in dB μ V/m

RA: Amplitude of EMI Receiver before correction in dB μ V

AF: Antenna Factor in dB/m

CF: Cable Attenuation Factor in dB

AG: Built-in Preampifier Gain in dB (Stored in receiver as part of the calibration data)

The pulse train timing plots are showed in Figure 6.2.

The pulse train timing plots as follows:

The total time for each pulse train is 139.62 ms, The short pulse is 0.640ms, The middle pulse is 2.5 ms, The long pulse is 4.8ms.

Coeff. = $(55 \times 0.640 + 1 \times 4.8 + 5 \times 2.5) / 100 = 0.525$

The maximum average field strength should be 0.525 of the peak field strength measured. So we use peak value minus 5.6dB as calculated maximum average field strength.

6.2 Test Methods and Conditions

The initial step in collecting radiated data is a EMI Receiver scan of the measurement range below 30MHz using peak detector and 9KHz IF bandwidth / 30KHz video bandwidth. For the range under 1GHz, 120KHz IF bandwidth / 120KHz video bandwidth are used. Both bandwidths are 1MHz for above 1GHz measurement. The frequency range from the lowest clock frequency in EUT circuitry to 10th harmonics were investigated.

6.3 Test Data

The following data lists the significant emission frequencies, polarity and position, peak reading of the EMI Receiver, the FCC limit, and the difference between the peak reading and the limit. Explanation of the correction and calculation are given in section 6.1.

Test Personnel: _____



Typed/Printed Name: Edward Lee

Date: December 02, 2016

Radiated Test Data

Test Mode: TELIS 4 (worst case)

Freq. (MHz)	Worst H/V, Z(1)	Height. (m)	Azimuth	Peak@3m (dBuV/m)	QP/Avg @3m (dBuV/m)	PK Lim (dBuV/m)	QP /Avg. Lim (dBuV/m)	PK Mar (dBuV/m)	QP /Avg.Mar. (dBuV/m)
433.5(3)	H,X	1.1	270	84.4	78.8	100.80	80.80	-16.4	-2.0
867(4)	H,X	1.0	180	45.3	39.7	80.80	60.80	-35.5	-21.1
1300.5(2)	H,X	1.1	180	38.5	32.9	74.0	54.0	-35.5	-21.1
1734	H,X	1.1	090	43.9	38.3	80.80	60.80	-36.9	-22.5
2167.5	H,X	1.1	180	42.7	37.1	80.80	60.80	-38.1	-23.7
2601	H,X	1.1	180	43.7	38.1	74.0	54.0	-30.3	-15.9
433.5(3)	V,X	1.1	180	68.7	63.1	100.80	80.80	-32.1	-17.7
867(4)	V,X	1.1	000	40.3	34.7	80.80	60.80	-40.5	-26.1
1300.5(2)	V,X	1.1	180	39.6	34.0	74.0	54.0	-34.4	-20.0
1734	V,X	1.1	270	40.5	34.9	80.80	60.80	-40.3	-25.9
2167.5	V,X	1.1	180	42.7	37.1	80.80	60.80	-38.1	-23.7
2601	V,X	1.1	180	46.5	40.9	74.0	54.0	-27.5	-13.1
433.5(3)	H,Y	1.1	090	83.8	78.2	100.80	80.80	-17.0	-2.6
867(4)	H,Y	1.0	045	44.4	38.8	80.80	60.80	-36.4	-22.0
1300.5(2)	H,Y	1.1	180	38.7	33.1	74.0	54.0	-35.3	-20.9
1734	H,Y	1.1	235	40.7	35.1	80.80	60.80	-40.1	-25.7
2167.5	H,Y	1.1	270	41.9	36.3	80.80	60.80	-38.9	-24.5
2601	H,Y	1.1	180	44.4	38.8	74.0	54.0	-29.6	-15.2
433.5(3)	V,Y	1.1	270	73.5	67.9	100.80	80.80	-27.3	-12.9
867(4)	V,Y	1.1	180	41.6	36.0	80.80	60.80	-39.2	-24.8
1300.5(2)	V,Y	1.1	270	39.4	33.8	74.0	54.0	-34.6	-20.2
1734	V,Y	1.1	090	45.8	40.2	80.80	60.80	-35.0	-20.6
2167.5	V,Y	1.1	180	44.3	38.7	80.80	60.80	-36.5	-22.1
2601	V,Y	1.1	270	44.6	39.0	74.0	54.0	-29.4	-15.0
433.5(3)	H,Z	1.1	180	71.0	65.4	100.80	80.80	-29.8	-15.4
867(4)	H,Z	1.0	180	41.7	36.1	80.80	60.80	-39.1	-24.7
1300.5(2)	H,Z	1.1	180	37.6	32.0	74.0	54.0	-36.4	-22.0
1734	H,Z	1.1	180	42.2	36.6	80.80	60.80	-38.6	-24.2
2167.5	H,Z	1.1	180	43.7	38.1	80.80	60.80	-37.1	-22.7
2601	H,Z	1.1	180	42.6	37.0	74.0	54.0	-31.4	-17.0
433.5(3)	V,Z	1.1	270	84.5	78.9	100.80	80.80	-16.3	-1.9
867(4)	V,Z	1.1	135	45.3	39.7	80.80	60.80	-35.5	-21.1
1300.5(2)	V,Z	1.1	270	40.7	35.1	74.0	54.0	-33.3	-18.9
1734	V,Z	1.1	270	42.8	37.2	80.80	60.80	-38.0	-23.6
2167.5	V,Z	1.1	135	43.5	37.9	80.80	60.80	-37.3	-22.9
2601	V,Z	1.1	180	46.7	41.1	74.0	54.0	-27.3	-12.9

- (1) See Figure 3.1, 3.2 and 3.3 for definition of position
- (2) Restricted band.
- (3) Fundamental limit is 1500-5000 microvolts/meter linear interpolations (average reading) for 260-470 MHz fundamental frequency range; 10965uV/m for 433.4MHz Fundamental. Per FCC 15.231(b).
- (4) Spurious limit is 150-500 microvolts/meter linear interpolations (average reading). Per 15.231(b).

Test Mode: TELIS 1 (highest emissions collected in pretest)

Freq. (MHz)	Worst H/V, Z(1)	Height. (m)	Azimuth	Peak@3m (dBuV/m)	QP/Avg @3m (dBuV/m)	PK Lim (dBuV/m)	QP /Avg. Lim (dBuV/m)	PK Mar (dBuV/m)	QP /Avg.Mar. (dBuV/m)
433.5(3)	H,X	1.1	270	84.0	78.4	100.80	80.80	-16.8	-2.4
867(4)	H,X	1.0	290	45.7	40.1	80.80	60.80	-35.1	-20.7
1300.5(2)	H,Y	1.1	000	39.0	33.4	74.0	54.0	-35.0	-20.6
1734	H,Y	1.1	180	47.7	42.1	80.80	60.80	-33.1	-18.7
2167.5	H,Y	1.1	180	46.2	40.6	80.80	60.80	-34.6	-20.2
2601	H,Y	1.1	180	48.1	42.5	74.0	54.0	-25.9	-11.5
433.5	V,Z	1.1	235	83.9	78.3	100.80	80.80	-16.9	-2.5
867	V,Z	1.1	135	44.8	39.2	80.80	60.80	-36.0	-21.6
1300.5	V,Z	1.1	090	41.8	36.2	74.0	54.0	-32.2	-17.8
1734	V,Z	1.1	090	45.3	39.7	80.80	60.80	-35.5	-21.1
2167.5	V,Z	1.1	090	43.2	37.6	80.80	60.80	-37.6	-23.2
2601	V,Z	1.1	090	45.6	40.0	74.0	54.0	-28.4	-14.0

6.4 Occupied Bandwidth

The bandwidth of the emission shall be no wider than 0.25% of the center frequency, in this case, 1.0835Hz(433.42x0.25%). Bandwidth is determined at the points 20dB down from the modulated carrier or by containing 995 of the total power of the signal. The occupied bandwidth plots are given as following.

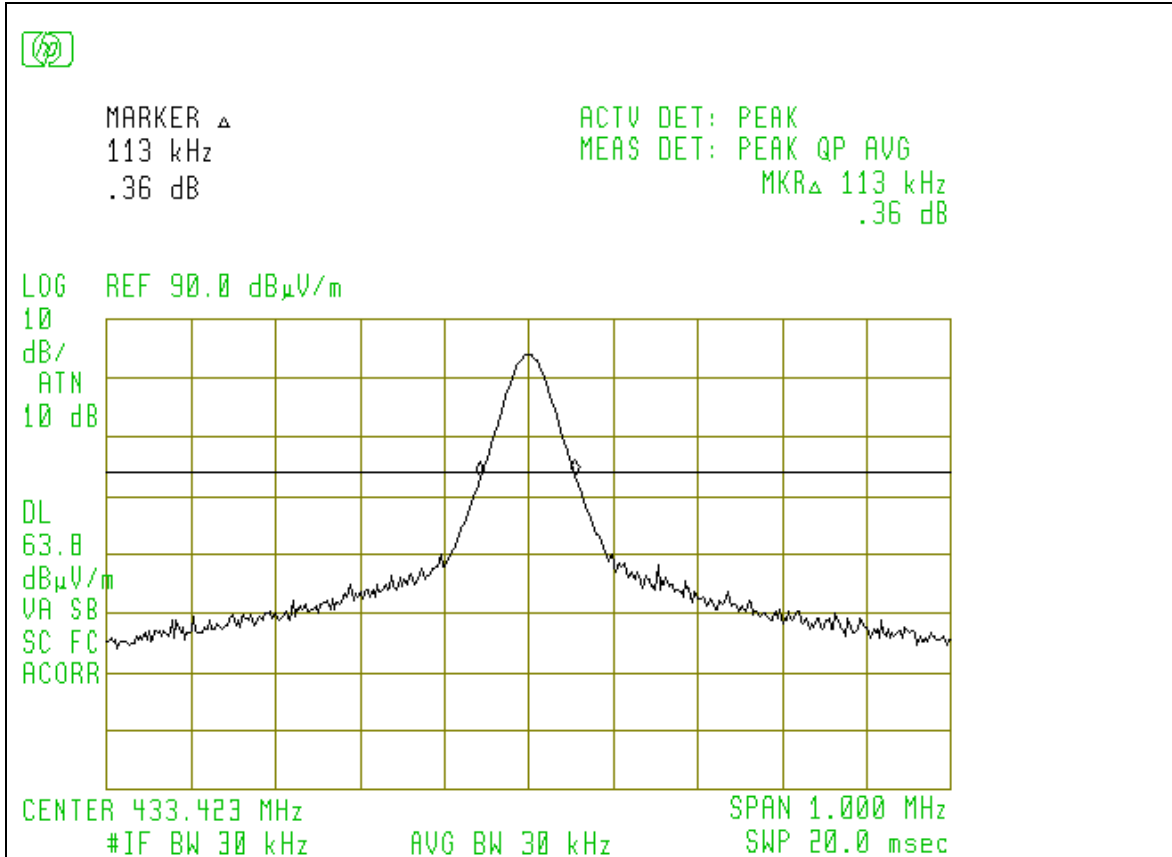
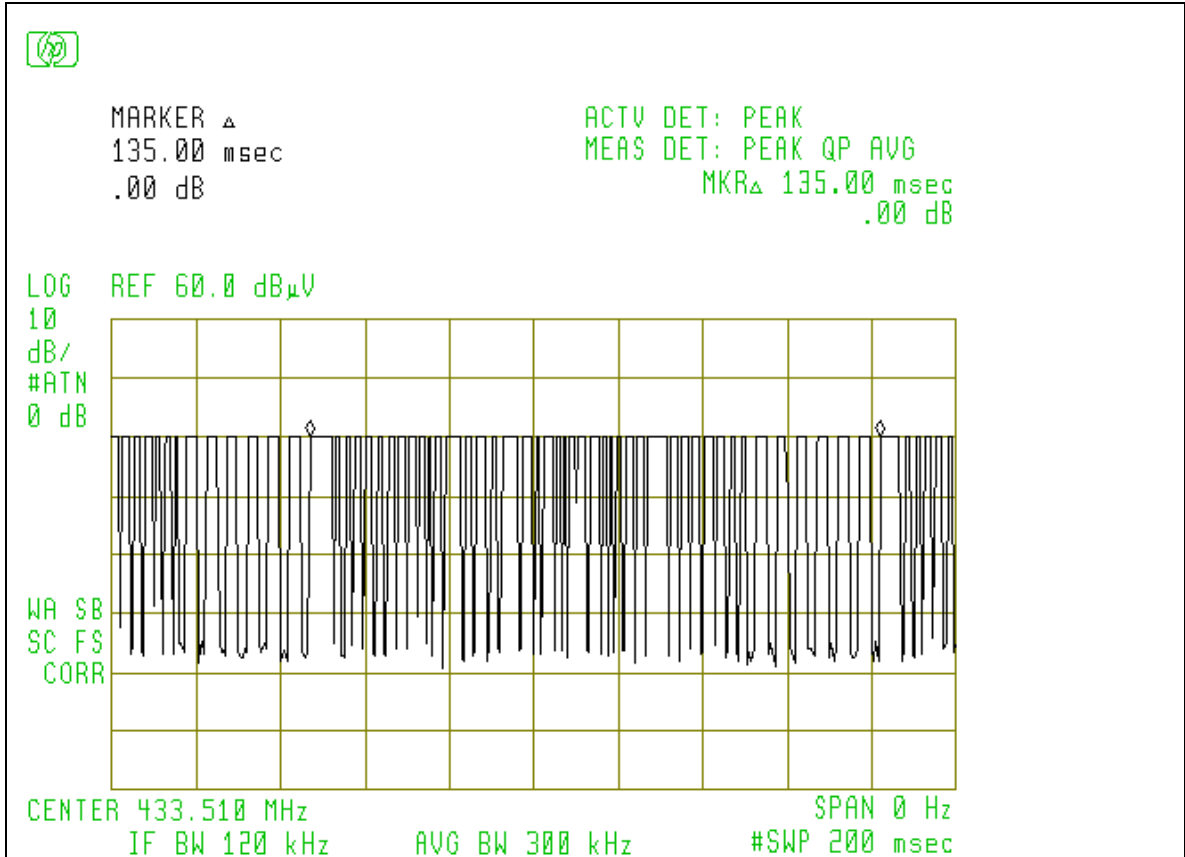
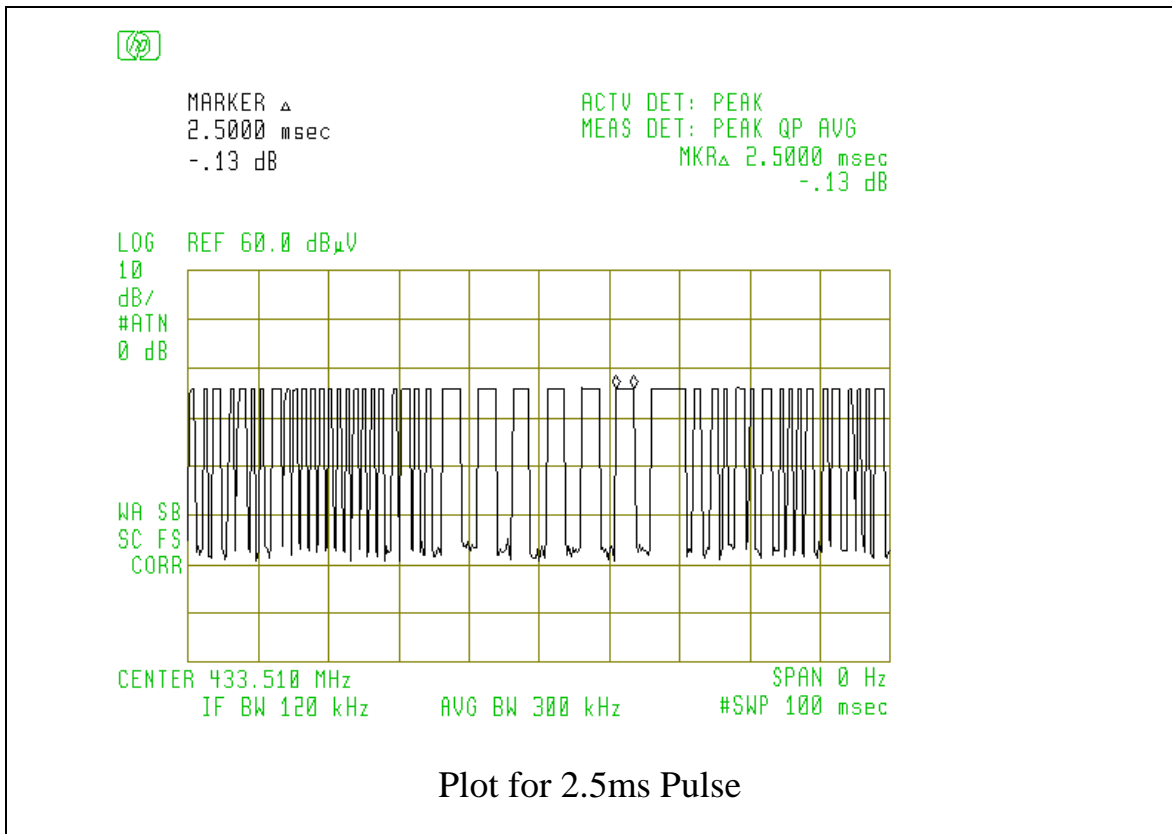
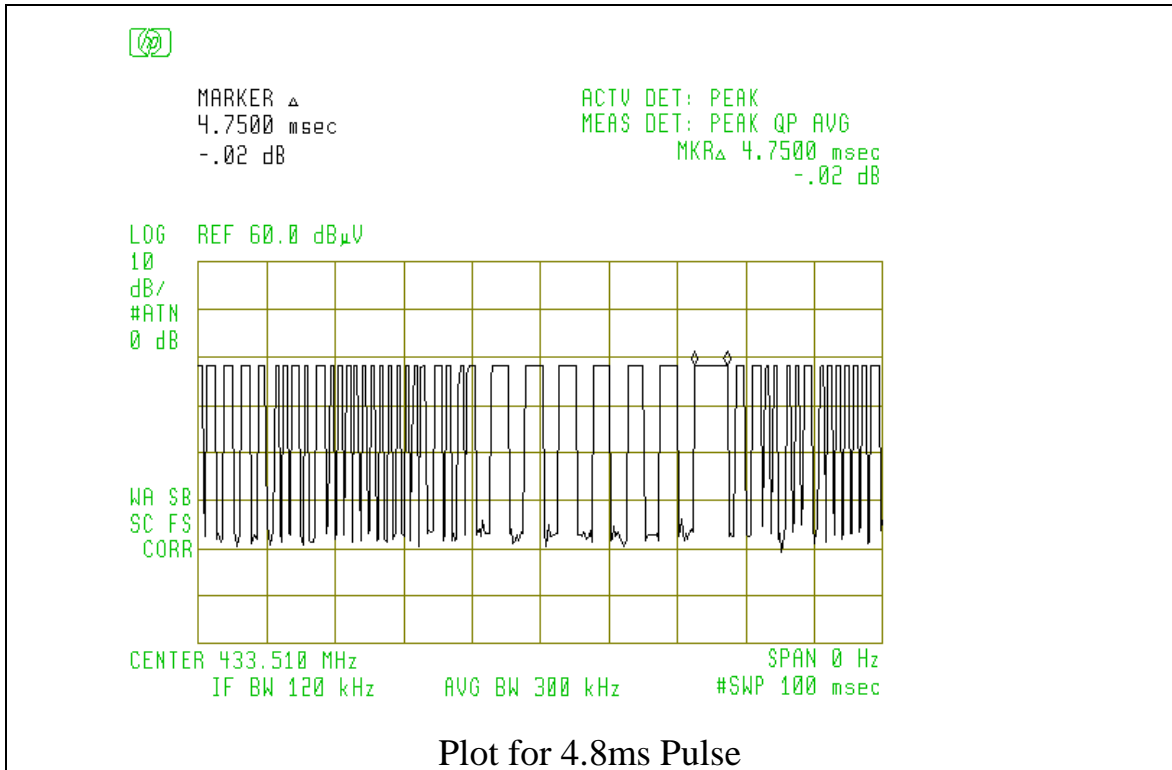

Figure 6.1 20 dB Occupied Bandwidth



RTS Frame (Tram Structure in details is provided in product operational description, confidential)



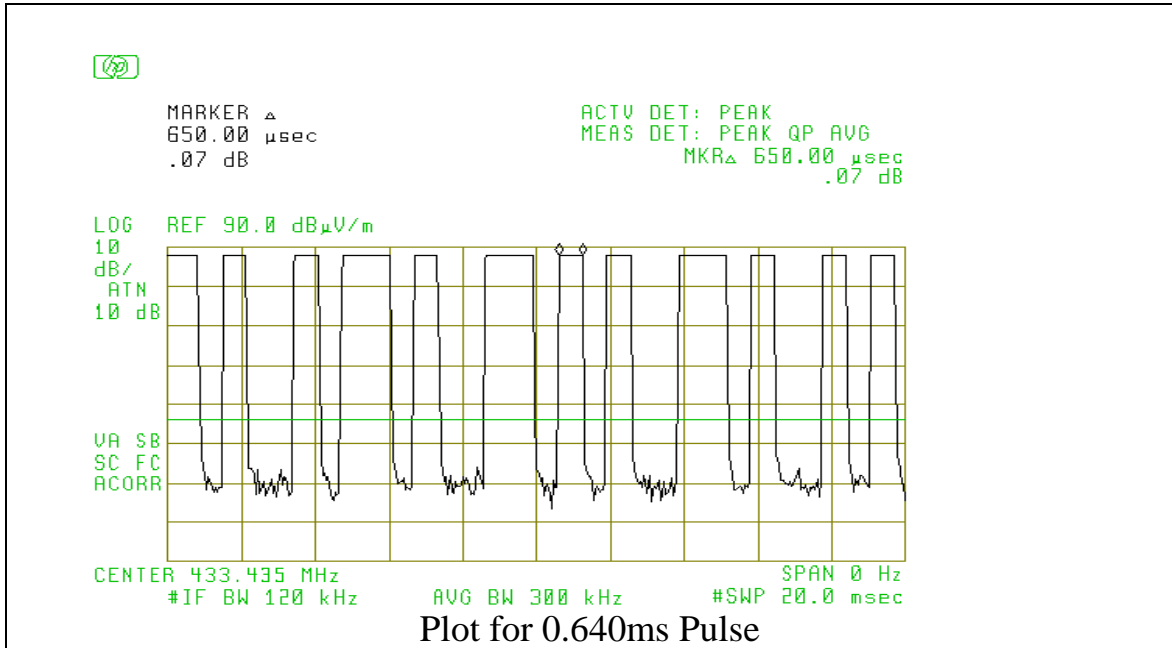

Figure 6.2 Pulse Train Timing