

# ECG & Respiration Transmitter

## LX-7120(G)

### Operation Manual

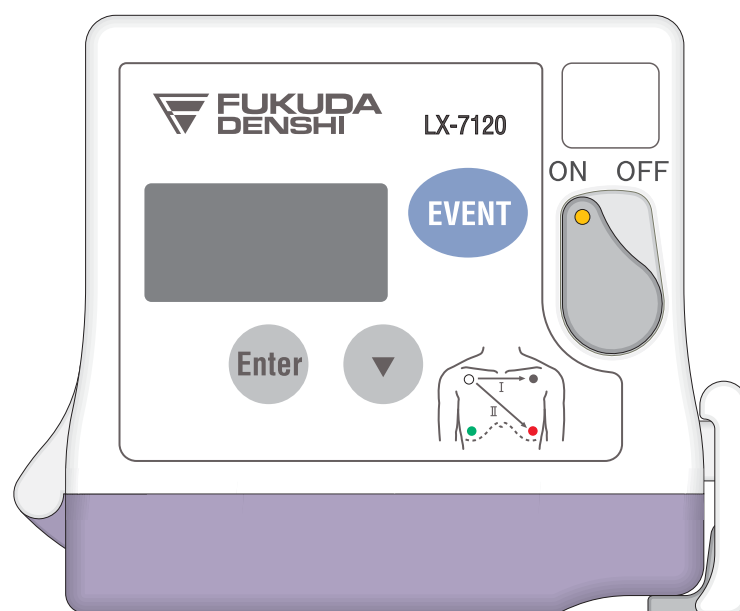

- Before using this equipment, read this operation manual thoroughly.
- Keep this manual near the device for future reference.

**⚠ CAUTION**

**Federal Law restricts this device to sale by or on the order of a physician.**

**⚠ CAUTION**

**Users are advised to periodically contact the FCC or specified frequency coordinator and determine if other or your transmitter frequencies that may cause interference.**

**⚠ CAUTION**

**The manufacturers, installers and users of Wireless Medical Telemetry System equipment are cautioned that the operation of this equipment could result in harmful interference to other nearby medical devices.**

**CAUTION:**

- **This equipment for sale by or on the order of a physician.**
- **The company and product names used in this manual are trademarks or registered trademarks.**
- **If this manual has pages missing or out of order, contact Fukuda Denshi for replacement.**
- **Only physician or persons instructed by physicians are allowed to use the equipment.**
- **The information contained in this document is subject to change without notice due to improvement in the equipment.**

**Copyright © 2015 by Fukuda Denshi Co., Ltd.**

**No part of this document may be copied or transmitted in any form without the prior written permission of Fukuda Denshi Co., Ltd.**

**Printed in Japan**

Thank you for purchasing this product.  
Before using this product, read this operation manual thoroughly for correct handling and operation.

## Safety Precautions

---

- Read the “Safety Precautions” thoroughly before use to ensure correct and safe use of the product.
- Make sure to follow the precautions indicated below, as these are important messages related to safety.

 <b>DANGER</b>	Failure to follow this message may cause immediate threat of death or serious injury.
--	---

 <b>WARNING</b>	Failure to follow this message may result in death or serious injury.
--	---

 <b>CAUTION</b>	Failure to follow this message may cause injury or failure to the equipment.
--	--

<b>NOTE</b>	A note is not related to product safety, but provides information about the correct use and operating procedures to prevent incorrect operation and malfunction of the equipment.
-------------	---

### Precaution from Fukuda Denshi

Fukuda Denshi is liable for the safety, reliability, and performance of its equipment only if;



- Maintenance, modifications, and repairs are carried out by authorized personnel.
- Components are used in accordance with Fukuda Denshi operating instructions.

If the equipment is used incorrectly and become unusable, Fukuda Denshi is not liable for the malfunction. Use the equipment only for the purpose specified in this manual.

## Graphic Symbols

Refer to the following symbols indicated on the LX-7120(G) for their meanings.

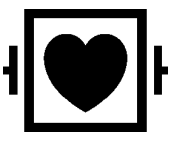
Symbols indicated on the main unit

<i>Symbol</i>	<i>Description</i>
	<u>Caution: Refer To Accompanying Documents</u> Indicates the need to refer to the related accompanying documents before operation.
	<u>Type CF Applied Part with Defibrillation-Proof</u> Indicates that the degree of protection against electric shock is Type CF Applied Part with defibrillation-proof.
	<u>No Alarm Function</u> Indicates no alarm function.
	<u>Battery Type and Direction</u> Indicates the battery type and direction.

Symbols indicated on the LCD screen

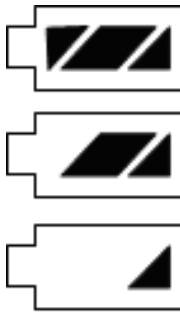
<i>Symbol</i>	<i>Description</i>
	<u>Heart Rate Synchronization Mark</u> This mark flashes synchronizing to the heartbeat.
	<u>Battery Mark</u> Indicates the remaining battery level.

## Precautions for Safe Operation of Medical Electrical Equipment

Cautions described here are regarding the general instructions for safety use to the patient and users. As for cautions about the LX-7120(G), please refer to the following pages.

### CAUTION

- 1. Users should have a thorough knowledge of the operation before using this equipment.**
- 2. Pay attention to the following when installing or storing the equipment.**
  - Do not install or store in an area where the equipment will be subject to splashing water.
  - Do not install or store in an area where the environmental conditions, such as atmospheric pressure, temperature, humidity, ventilation, sunlight, dust, sodium, sulfur, will adversely affect the system.
  - Place the equipment on a stable surface where there is no inclination, vibration, or shock (including during transportation).
  - Do not install or store in an area where chemicals are stored or gases are evolved.
- 3. Before operating the equipment, verify the following items.**
  - Check the cable connection and polarity to ensure proper operation of the equipment.
  - Ensure that all cables are firmly and safely connected. Especially, recheck the attachment and connection condition of electrode.
  - Pay special attention when the equipment is used in conjunction with other equipment as it may cause erroneous judgment and danger.
  - Check the remaining battery level.
  - When replacing the battery, make sure that the battery polarity is correct. Do not charge the battery.
- 4. During operation of the equipment, verify the following items.**
  - Do not operate the equipment beyond the time period required for diagnosis and medical care.
  - Do not pick up and/or swing the equipment pulling/grabbing the cable part. It may damage the equipment and lead to measurement error.
  - Always observe the equipment and patient to ensure safe operation of the equipment.
  - If any abnormality is found on the equipment or patient, take appropriate measures such as ceasing operation of the equipment and/or detaching the electrode, in the safest way for the patient.
  - Do not allow the patient to come in contact with other equipments.

## CAUTION

5. **After using the equipment, verify the following items.**
  - Make sure to turn off the power of the equipment.
  - When unplugging the cables, do not apply excessive force on the cable and pull from its connector.
  - Clean the accessories and cables, and keep them together in one place.
  - Keep the equipment clean to ensure proper operation for the next use.
  - Make sure to remove the battery if the equipment is not used for a long time. The leakage from the battery may damage the equipment or an explosion from the battery may occur.
6. **If the equipment is damaged and in need of repair, ensure patient safety by immediately turning the equipment off and remove the electrodes and/or cable from the patient. User should not attempt service. Label the unit “OUT OF ORDER” and contact Fukuda Denshi representative.**
7. **Do not remodel the equipment.**
8. **Maintenance Check**
  - Make sure to periodically check the equipment, and accessories.
  - Before reusing the equipment that has been left unused for a while, make sure that the equipment works normally and safely.
9. **When using electrosurgical knives or defibrillator with this equipment, take care of the following.**
  - To prevent burn injury to the patient, verify proper attachment of patient ground plate, ECG electrode type for the electrosurgical knives, and the quantity of gel, output energy for the defibrillator. Also, verify that a proper ground is selected.
  - Some types of equipment other than the above may cause accidental hazards to the patient and operator due to the conditions of the equipment. Read the operation manual attached to each equipment and understand the precautionary instructions prior to use.

## Non-Explosion Proof

### DANGER

- Never operate the equipment in the presence of flammable anesthetics, high concentration of oxygen. It may cause an explosion or fire.
- Never operate the equipment inside a hyperbaric chamber. It may cause an explosion or fire.
- Never operate the equipment where flammable gas or fluid such as anesthetic, oxygen, and hydrogen are used. It may cause an explosion or fire.

## Precautions about Magnetic Resonance Imaging (MRI)

### WARNING

- Do not operate this equipment in magnetic resonance imaging (MRI) environments.
- When conducting MRI test, remove the electrodes and sensors connected to the patient (test subject).  
The local heating caused by the induced electromotive force may cause burn injury to the patient (subject). For details, refer to the operation manual for the MRI testing device.

## Electrosurgery Safety

### WARNING

- When using electrosurgical instrument, make sure the contact between the patient and the ground plate is secured. If the connection is incomplete, the patient may suffer a burn at the electrode site.
- When using an electrosurgical instrument, it may misidentify noise from the electrosurgical instrument as a heartbeat or arrhythmia.

## Defibrillation Safety

### WARNING

- Use only the lead cable specified by Fukuda Denshi when defibrillating. If used by unspecified lead cable, the equipment may be damaged, resulting in a safety hazard.
- When using the defibrillator, keep away from the electrodes or medicament applied to the patient chest. If this is not possible, remove the electrodes or medicament before using it.  
If the defibrillator paddles are directly in contact with the electrodes or medicament, an electrical shock may result from the discharged energy.
- When using the defibrillator, do not touch the patient and the metal part of the equipment or cables. Electric shock may result from the discharged energy.

## Precautions about the Pacemaker

### WARNING

- Minute ventilation rate-adaptive implantable pacemakers can occasionally interact with certain cardiac monitoring and diagnostic equipment, causing the pacemakers to pace at their maximum programmed rate. The cardiac monitoring and diagnostic equipment may possibly send wrong information.  
If such event occurs, disconnect the cardiac monitoring and diagnostic equipment, or follow the procedures described in the operation manual of the pacemaker.  
(For more details, contact FUKUDA DENSHI personnel, your institution's professionals, or your pacemaker distributors.)
- ➡ Reference  
"Minute Ventilation Rate-Adaptive Pacemakers"  
FDA alerts health professionals that minute ventilation rate-adaptive implantable pacemakers can occasionally interact with certain cardiac monitoring and diagnostic equipment, causing pacemakers to pace at their maximum programmed rate.  
[October 14, 1998 (Letter: [www.fda.gov/cdrh/safety.html](http://www.fda.gov/cdrh/safety.html)) – FDA]
- ECG meter may continue to count the pacemaker rate during occurrences of cardiac arrest or arrhythmias. Do not rely entirely upon the ECG meter alarms. Keep pacemaker patients under close surveillance. Check this manual for disclosure of the pacemaker pulse rejection capability of this instrument.

## Precautions about the LX-7120(G)

### WARNING

- Do not connect cables not authorized by Fukuda Denshi to any I/O connector. If done so by mistake, the LX-7120(G) cannot deliver its maximum performance and may be damaged, resulting in a safety hazard.
- Do not use this equipment with multiple patients simultaneously.
- This equipment itself has no alarm function. Do not use it if an alarm function is necessary. The alarm function with the receiving monitor, refer to the operation manual of the receiving monitor.

### CAUTION

Do not pick up and/or swing the LX-7120(G) pulling/grabbing the cord part. The cable could break or get disconnected from the LX-7120(G). And it may hit people or damage other equipment around.



## Precautions about Waterproof

### CAUTION

- Replace the “Battery Compartment Lid” of the LX-7120(G) regularly to keep the performance of waterproof. If not regularly replaced, the quality of the lid will deteriorate and cannot keep the waterproof performance. For details about the regular replacement, contact your local Fukuda Denshi service representative.
- The lid may be damaged from high impact. If the LX-7120(G) is dropped or is subjected to a high impact, make sure that the lid is not damaged.
- Do not use the LX-7120(G) wet. Always wipe the LX-7120(G) with a soft cloth and dry it thoroughly before use.

## Precautions about ECG

### CAUTION

- When removing electrodes from the patient, remove them carefully and slowly. Do not apply excessive force to remove them. Otherwise, it may damage the skin.
- There are some cases when the pacemaker pulse cannot be detected depending on the pacemaker type, pulse voltage, pulse width, electrode lead type (unipolar, bipolar), electrode placement, or lead method which causes the pacemaker pulse amplitude to decrease and disables pacemaker pulse detection.
- If signals similar to a pacemaker pulse are present, such as electric blanket noise or excessive AC frequency noise, these may be erroneously detected and displayed as a pacemaker pulse. In this case, check the condition of the electrodes and ECG lead cable to resolve the cause or turn off the pacemaker detection setting on the receiving monitor.

## Precautions about Output Signal

### WARNING

Do not use the output signal of the monitor that receives radio wave signal from the LX-7120(G) as the trigger signal for IABP, MRI echocardiographic, or defibrillator for the following reasons.

- It may lead to a delay of operating timing due to the delay time of waveform transmission.
- A trigger signal unrelated to the heart rate may be generated due to the interfusion of spike noise at weak electric field.

## Precautions about Accessories and Optional Accessories

### WARNING

Use only the accessories, such as ECG Lead cable, specified by Fukuda Denshi for the LX-7120(G). Otherwise, the LX-7120(G) cannot deliver its maximum performance and may be damaged, resulting in a safety hazard.

### CAUTION

- Do not reuse disposable products.
- Store the disposable products properly as mentioned in their user manuals.

## Precautions about Battery

### WARNING

- Use new "AA" size ("LR06" size) alkaline cell.
- Install the battery with the correct polarity.
- Do not charge the battery. Any attempt to charge the battery may cause it to leak or break.
- Do not short the (+) and (-) terminals. It may result in exothermic heat and fire.
- Do not throw the battery into fire. It may explode.

## Precautions about Disposing of Equipment, Accessories, or Components

### CAUTION

- When disposing of the equipment, accessories, or components, use an industrial waste distributor. Do not dispose of as ordinary waste.
- Used disposal items (ECG electrodes, etc.) shall be discarded as medical waste.

## Precautions about Disposing of Battery

### CAUTION

Obey the local municipal rule to dispose the used dry cell battery.

## Precautions for Use of Medical Telemeter

### WARNING

- The LX-7120(G) transmitter must not be co-located or operated in conjunction with any other antenna or transmitter.
- This equipment complies with FCC/IC radiation exposure limits set forth for an uncontrolled environment and meets the FCC radio frequency (RF) Exposure Guidelines and RSS-102 of the IC radio frequency (RF) Exposure rules. This equipment has very low levels of RF energy that are deemed to comply without testing of specific absorption rate(SAR).
- Operation of LX-7120(G) requires the prior coordination with a frequency coordinator designated by the FCC for the Wireless Medical Telemetry Service.
- This radio frequency device is susceptible to interference from outside sources. Interference may prevent the monitoring of patients connected to this equipment. If a problem exists, contact your local service representative.
- The LX-7120(G) transmits vital signs to the receiving monitor using radio wave signal. Under unstable radio wave signals, the receiving monitor will not generate any alarms. This situation may miss sudden change in the patient's condition and may cause a serious accident. Under unstable radio wave signals, check the patient status consistently under this situation. To get stable radio wave signals, make sure to have a proper telemetry installation.

### CAUTION

- For installation, make sure the following.
  - The medical institution (hereinafter referred to as the "Institution") must decide the telemetry installation plan for the medical department in order to prevent interference and interference between transmitters (telemetry based on destination country's radio law). When telemetry has already been installed and been used, radio format, frequency, and antenna power are required to be examined to prevent interference.
  - When using telemetry, which requires zone location, the Institution is to set up the zones as an operation unit for each transmitter to prevent electronic interference between telemetry throughout the Institution.
  - When using telemetry, which requires zone location, display and identify each prepared zone in the equipment.
  - When laying receiver antenna for each transmitter, the Institution has to examine the installation so that electronic interference does not occur.
  - Based on the above examination result, the Institution should install each receiver antenna as required.
- For management, make sure to follow the precautions below.
  - The Institution should appoint a person (hereinafter referred to as the "Overall Manager") to manage the wireless channels for the whole Institution.

## CAUTION

- And when using telemetry, which requires zone location, the Institution should nominate a person (hereinafter referred to as the “Zone Manager”) to manage the wireless channels in each zone. However, when using such telemetry in a local Institution, one person can perform both functions.
- The Overall Manager and Zone Manager must be selected from people who understand the characteristics and functionality of telemetry systems, and are skilled in operating telemetry.
- When installing telemetry, the Overall Manager and the Zone Manager have to understand the precautions for use of telemetry in advance.
- The Overall Manager is responsible for maintenance of wireless channel and storage and maintenance of telemeter in the overall medical facilities to give proper instructions to the Zone Manager when using telemetry needing zone alignment, and to the telemetry user when using telemetry not-needing zone alignment.
- The Overall Manager should create a management log (hereinafter referred to as the “log”), which contains a list of the management status of the wireless channels for the whole Institution. When changing a wireless channel, register it in the log and give proper instructions to the Zone Manager or to the user.
- The Zone Manager assumes responsibility for managing the wireless channels, storing, and managing telemetry.
- The Zone Manager assigns the transmitter to the user, and provides enough education for use inside the zone.
- The telemetry user verifies operation of the transmitter/receiver before use.
- The telemetry user, if using the telemetry in a zone location, follows the instructions of the Zone Manager for the zone and gives instructions to the patient if required.
- When interference or breakdown occurs in telemetry communication, the user is required to inform the Zone Manager and the Overall Manager of the problems. The Zone Manager and Overall Manager are to deal with the problem properly and/or contact their nearest Fukuda Denshi representative for service.

# Electromagnetic Compatibility

---

The performance of this equipment under electromagnetic environment complies with IEC 60601-1-2 (2007).

## Precautions for Safe Operation under Electromagnetic Influence

### CAUTION

If any sorts of electromagnetic wave, magnetic field, or static electricity exist around the equipment, noise interference or malfunction of the equipment may occur. If any unintended malfunction or noise occurs during monitoring, check the magnetic influence and take appropriate countermeasures.

The following are examples of the common cause and countermeasures.

#### ● Mobile Phone

The radio wave may cause malfunction to the equipment.  
Mobile phones and radio sets should be turned off in the room (building) where medical device is located.

#### ● Static Electricity

In a dry environment (room), static electricity is likely to occur. Take the following countermeasures.

- Both operator and patient should remove any static electricity before entering the room
- Humidify the room

## EMC Guidance

This equipment complies with IEC 60601-1-2 (2007). However, if portable transmitter or wireless LAN equipment is used extremely nearby, the electromagnetic influence may largely exceed the compliance level and may cause unexpected phenomenon such as noise interference on the waveform, etc.

Therefore, this equipment should be used in a location specified by each medical institution. If any unexpected noise interference on the waveform or failure to the peripheral device occurs, stop using the equipment and follow the instruction of the technician.

The following is the information relating to EMC (Electromagnetic Compatibility).

(When using this equipment, verify that it is used within the environment specified below.)

### ● Compliance to the Electromagnetic Emissions

The LX-7120(G) is intended for use in the electromagnetic environment specified below. The customer or the user of the LX-7120(G) should assure that it is used in such an environment.

<b><i>Emission Test</i></b>	<b><i>Compliance</i></b>	<b><i>Electromagnetic Environment – Guidance</i></b>
RF Emission CISPR 11	Group 1	The LX-7120(G) uses RF energy only for its internal function. Therefore, its RF emissions are very low and are not likely to cause any interference in nearby electronic equipment.
RF Emission CISPR 11	Class A	This LX-7120(G) is suitable for use in all establishments other than domestic establishments.
Harmonic Emission IEC 61000-3-2	N/A	
Voltage Limit / Flicker Emission IEC 61000-3-3	N/A	

● Compliance to the Electromagnetic Immunity (1)

The LX-7120(G) is intended for use in the electromagnetic environment specified below. The customer or the user of the LX-7120(G) should assure that it is used in such an environment.

<b>Immunity Test</b>	<b>IEC 60601-1-2 Test Level</b>	<b>Compliance Level</b>	<b>Electromagnetic Environment Guidance</b>
Electrostatic Discharge (ESD) IEC 61000-4-2	±6kV contact ±8kV air	±6kV contact ±8kV air	Floors should be wood, concrete or ceramic tile. If floors are covered with synthetic material, the relative humidity should be at least 30%.
Electrical fast transient/burst IEC 61000-4-4	±2kV: Power supply lines ±1kV: Input/output lines	N/A	
Surge IEC 61000-4-5	±1kV: differential mode ±2kV: common mode	N/A	
Voltage dips, short interruptions and voltage variations on power supply input lines. IEC 61000-4-11	<5% $U_T$ (>95% dip in $U_T$ ) for 0.5 cycle  40% $U_T$ (60% dip in $U_T$ ) for 5 cycles  70% $U_T$ (30% dip in $U_T$ ) for 25 cycles  <5% $U_T$ (>95% dip in $U_T$ ) for 5sec.	N/A	
Power Frequency (50/60Hz) Magnetic Field IEC 61000-4-8	3A/m	3A/m	Power frequency magnetic fields should be at levels characteristic of a typical location in a typical commercial or hospital environment.
Note: $U_T$ is the AC mains voltage prior to application of the test level.			

## ● Compliance to the Electromagnetic Immunity (2)

The LX-7120(G) is intended for use in the electromagnetic environment specified below. The customer or the user of the LX-7120(G) should assure that it is used in such an environment.

<b>Immunity Test</b>	<b>IEC60601-1-2 Test Level</b>	<b>Compliance Level</b>	<b>Electromagnetic Environment Guidance</b>
<p>Conducted RF IEC 61000-4-6</p> <p>Radiated RF IEC 61000-4-3</p>	<p>3Vrms 150kHz to 80MHz</p> <p>3V/m 80MHz to 2.5GHz</p>	<p>3Vrms</p> <p>3V/m</p>	<p>Portable and mobile RF communications equipment should be used no closer to any part of the LX-7120(G), including cables, than the recommended separation distance calculated from the equation applicable to the frequency of the transmitter.</p> <p><b>Recommended Separation Distance</b></p> $d = 1.2 \sqrt{P}$ $d = 1.2 \sqrt{P} \quad 80\text{MHz to } 800\text{MHz}$ $d = 2.3 \sqrt{P} \quad 800\text{MHz to } 2.5\text{GHz}$ <p>Where <math>P</math> is the maximum output power rating of the transmitter in watts (W) according to the transmitter manufacturer and <math>d</math> is the recommended separation distance in meters (m).</p> <p>Field strengths from fixed RF transmitters, as determined by an electromagnetic site survey<sup>a)</sup>, should be less than the compliance level in each frequency range<sup>b)</sup>.</p> <p>Interference may occur in the vicinity of equipment marked with the following symbol:  </p>
<p>Note 1: At 80MHz and 800MHz, the higher frequency range applies.</p> <p>Note 2: These guidelines may not apply in all situations. Electromagnetic propagation is affected by absorption and reflection from structures, objects and people.</p>			
<p><sup>a)</sup> Field strengths from fixed transmitters, such as base stations for radio (cellular/cordless) telephones and land mobile radios, amateur radio, AM and FM radio broadcast and TV broadcast cannot be predicted theoretically with accuracy. To assess the electromagnetic environment due to fixed RF transmitters, an electromagnetic site survey should be considered. If the measured field strength in the location in which the LX-7120(G) is used exceeds the applicable RF compliance level above, the LX-7120(G) should be observed to verify normal operation. If abnormal performance is observed, additional measures may be necessary, such as re-orienting or relocating the LX-7120(G).</p> <p><sup>b)</sup> Over the frequency range 150kHz to 80MHz, field strength should be less than 3V/m.</p>			



● **Recommended Separation Distances between Portable and Mobile RF Communications Equipment and the LX-7120(G)**

The LX-7120(G) is intended for use in an environment in which radiated RF disturbances are controlled. The customer or the user of the LX-7120(G) can help prevent electromagnetic interference by maintaining a minimum distance between portable and mobile RF communications equipment (transmitters) and the LX-7120(G) as recommended below, according to the maximum output power of the communications equipment.

<b>Rated Maximum Output Power of Transmitter (W)</b>	<b>Separation Distance according to Frequency of Transmitter (m)</b>		
	150kHz to 80MHz $d = 1.2\sqrt{P}$	80MHz to 800MHz $d = 1.2\sqrt{P}$	800MHz to 2.5GHz $d = 2.3\sqrt{P}$
0.01	0.12	0.12	0.23
0.1	0.38	0.38	0.73
1	1.2	1.2	2.3
10	3.8	3.8	7.3
100	12	12	23

For transmitters rated at a maximum output power not listed above, the recommended separation distance  $d$  in meters (m) can be determined using the equation applicable to the frequency of the transmitter, where  $P$  is the maximum output power rating of the transmitter in watts (W) according to the transmitter manufacturer.

Note 1 : At 80MHz and 800MHz, the separation distance for the higher frequency range applies.

Note 2 : These guidelines may not apply in all situations. Electromagnetic propagation is affected by absorption and reflection from structures, objects and people.

Blank Page

# CONTENTS

<b>Safety Precautions</b> .....	i
Precaution from Fukuda Denshi.....	i
Graphic Symbols.....	ii
Precautions for Safe Operation of Medical Electrical Equipment ....	iii
Non-Explosion Proof .....	iv
Precautions about Magnetic Resonance Imaging (MRI).....	v
Electrosurgery Safety.....	v
Defibrillation Safety .....	v
Precautions about the Pacemaker .....	vi
Precautions about the LX-7120(G) .....	vi
Precautions about Waterproof .....	vii
Precautions about ECG .....	vii
Precautions about Output Signal .....	vii
Precautions about Accessories and Optional Accessories .....	viii
Precautions about Battery.....	viii
Precautions about Disposing of Equipment, Accessories, or Components .....	viii
Precautions about Disposing of Battery .....	viii
Precautions for Use of Medical Telemeter .....	ix
<b>Electromagnetic Compatibility</b> .....	xi
Precautions for Safe Operation under Electromagnetic Influence...xi	
EMC Guidance.....	xii
1. General Description .....	1
2. Names of Parts and Their Functions.....	3
3. Preparation .....	5
1) Installing the Battery .....	5
2) Operating Power Switch .....	7
4. ECG Monitoring .....	9
■ Connecting the ECG Lead Cable and Electrodes.....	9
■ Attaching the Electrodes.....	12
■ Connecting the ECG Lead Cable to the LX-7120(G).....	13
5. Respiration Monitoring .....	15
6. Measurement.....	17
■ Starting Screen .....	17
■ Waveform Display Screen .....	17
■ Battery Level Check .....	17
■ Waveform Display .....	18
7. Operation .....	25
■ Changing Setup.....	25
■ Restarting the LCD display .....	29
■ Pressing the EVENT button.....	29

8. Other Setting Items .....	31
■ Changing the Time Constant .....	32
■ Changing the Detection Sensitivity of the Pacemaker Pulse ...	33
■ Changing the Respiration Detection Signal ON/OFF .....	34
■ Changing the LCD Contrast.....	34
9. Changing the Transmitter Channel and Group ID.....	36
■ Changing the Transmitter Channel.....	36
■ Changing the Group ID.....	36
10. Troubleshooting .....	39
■ List of Displayed messages .....	39
■ Troubleshooting.....	40
■ In Case of Dropping the LX-7120(G) into Water.....	42
11. Cleaning and Disinfection .....	43
■ Cleaning and Disinfecting the LX-7120(G) .....	43
■ Cleaning the ECG lead cable .....	44
12. Maintenance and Inspection .....	45
13. Standard and Optional Accessories.....	47
■ Standard Accessories.....	47
■ Optional Accessories .....	48
14. Specification.....	49
■ Specification .....	49
■ Displays .....	52
■ Details of the “ELECTRODE?” Message.....	53
■ List of Setup Items .....	54

# 1. General Description

---

The LX-7120(G) is a radio telemetry transmitter designed to measure the ECG and respiration waveform with one (1) “AA” size (“LR06” size) alkaline battery. Information such as ECG measurements, respiration waveform, battery level, and the conditions of the ECG electrodes are displayed on the LCD of the front panel.

ECG lead selection is available using the two buttons (Enter and ▽) on the front panel. (In case of using a 3-electrode lead cable or a 5-electrode chest lead cable)

Before using the LX-7120(G), read also the operation manual of the patient monitor at the receiving side thoroughly.

## External Appearance

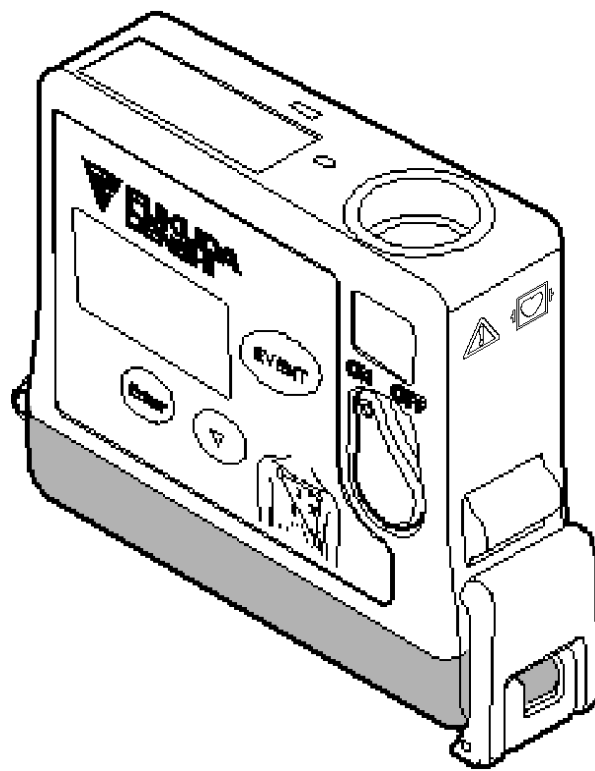

## 1. General Description

Blank Page

## 2. Names of Parts and Their Functions

---

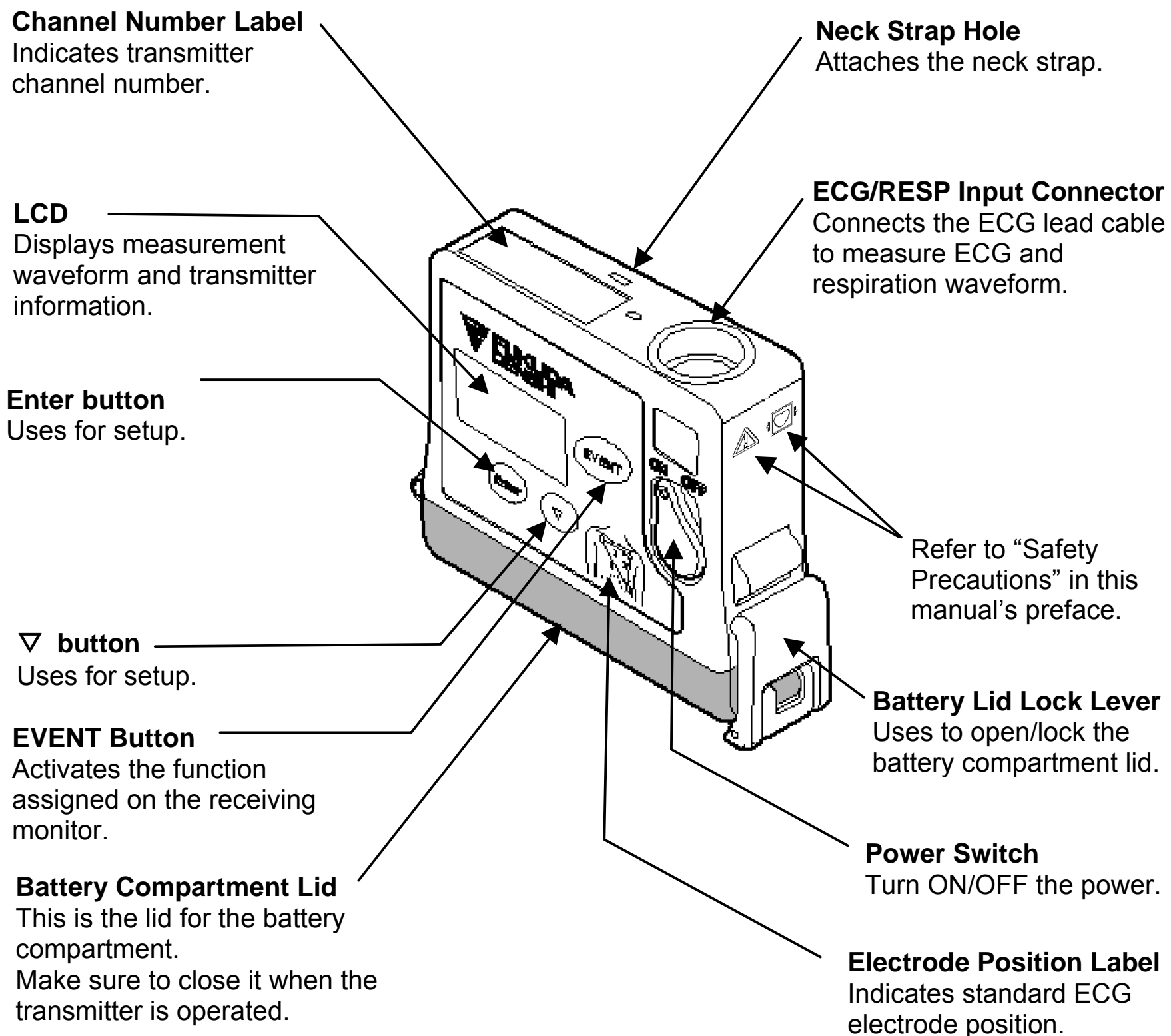

## 2. Names of Parts and Their Functions

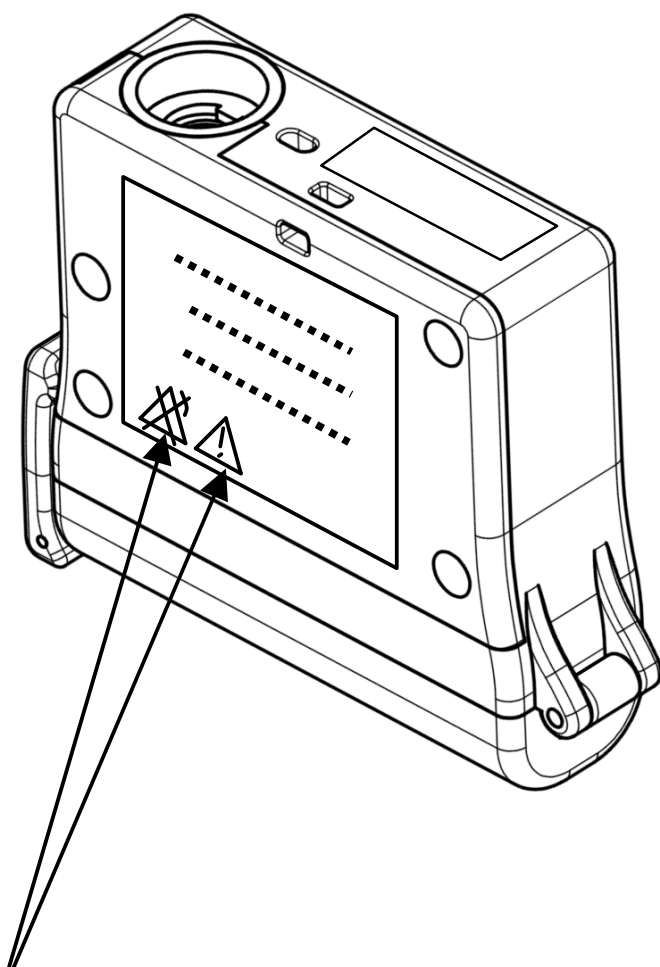

Refer to "Safety Precautions" in this manual's preface.



## 3. Preparation

---

### 1) Installing the Battery

The LX-7120(G) functions with one (1) "AA" size ("LR06" size) alkaline battery. With new battery, the LX-7120(G) is capable of approximately 3 days continuous operation.

#### WARNING

- Unplug the ECG lead cable when the battery compartment lid is opened. Otherwise, patient leakage current beyond the allowable value may occur.
- Use new "AA" size ("LR06" size) alkaline battery.
- Do not short out the (+) and (-) terminals. It may result in exothermic heat and fire, the leakage from the battery may damage the equipment, or an explosion from the battery may occur.
- Install the battery with the correct polarity.
- Do not use a disassembled or a damaged battery due to drop or shock. The leakage from the battery may damage the equipment, or an explosion from the battery may occur.
- Remove the exhausted battery immediately. The leakage from the battery may damage the equipment, or an explosion from the battery may occur.
- If the transmitter is not in use for a long period of time, remove the battery and store the equipment in an appropriate place. If the battery is left in the transmitter for a long period of time, the leakage from the battery may damage the equipment or an explosion from the battery may occur.

#### CAUTION

- Use only alkaline battery. Other battery will shorten the continuous operating time.
- Once the power switch is on the OFF position, then open the battery compartment lid.
- Do not replace the battery with wet hands.
- In case of storing the used or unused battery, make sure that the terminals are not touching other battery or metal parts.

### 3. Preparation

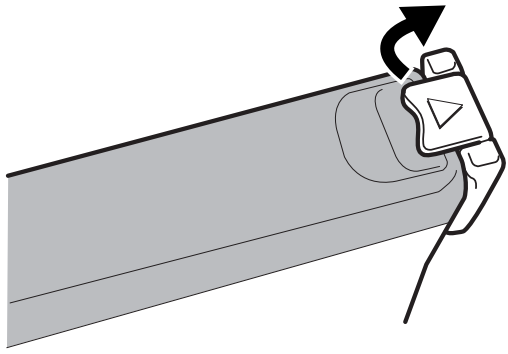

Lift the lock lever to open the battery compartment lid as shown in the left picture.

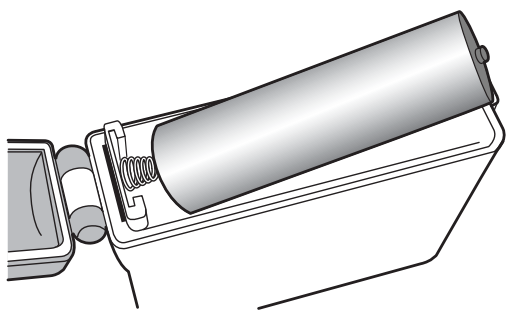

Install new battery according to the polarity indication inside the battery compartment. Make sure to first Insert the battery into the battery compartment from the minus (-) terminal as shown in the left picture.

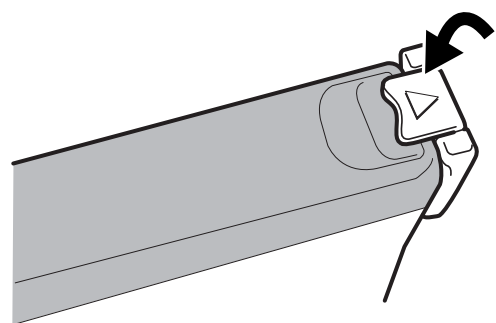

Hook the lock lever on the projection from the body and press it down until it is horizontal (flat position).

#### CAUTION

- Make sure that any foreign particles, such as hairs, are not held on the battery compartment lid and dust is not adhered to the edge of the lid to prevent water entering into the battery compartment area.
- Make sure to only turn ON the LX-7120(G) after closing the battery compartment lid.

## 2) Operating Power Switch

Turning the power switch to “ON”





Rotate the power switch to the left until it clicks.

LCD screen turns ON and measurement starts.  
Regarding the LCD screen, refer to page 17 (6. Measurement).  
The screen automatically turns itself OFF after a minute.

After the power is turned ON, make sure to check the remaining battery level on the LCD screen.

Refer to the following symbol about the remaining battery level.

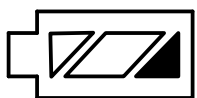
Battery Symbol	Remaining Battery Level
	Full
	Getting low but still available
	Nearly empty; Replace the battery

The battery level estimation is in case of using alkaline battery.

Turning the power switch to “OFF”



Rotate the power switch to the right until it clicks.

### 3. Preparation

Blank Page

## 4. ECG Monitoring

---

### ■ Connecting the ECG Lead Cable and Electrodes

The optional ECG lead cables for LX-7120(G) are as follows.

#### ECG Lead Cables

AHA color code:

Item No.	Applicable Lead	Remark
CMT-01HTH-0.8DA	Limb Lead (1CH)	3-electrode Hook Type (White, Black, Red)
CMT-02HTH-0.8DA	Limb Lead (2CH)	4-electrode Hook Type (White, Black, Red, Green)
CMT-03HTH-0.8DA	Limb Lead (1CH) +Chest (1CH)	5-electrode Hook Type (White, Black, Red, Green, Brown)
CMT-01FTH-0.8DA	Limb Lead (1CH)	3-electrode Clip Type (White, Black, Red)
CMT-02FTH-0.8DA	Limb Lead (2CH)	4-electrode Clip Type (White, Black, Red, Green)
CMT-03FTH-0.8DA	Limb Lead (1CH) +Chest (1CH)	5-electrode Clip Type (White, Black, Red, Green, Brown)

### WARNING

Use only the specified lead cable from Fukuda Denshi. Otherwise, proper monitoring may not be performed, and also it may fail defibrillation or cause a malfunction of the equipment when the equipment is used with a defibrillator.

## 4. ECG Monitoring

The relations between the attached electrode positions and lead method are as follows. Attach the electrodes to monitor proper waveform.

### For 3-electrode lead cable

For AHA color code electrode position (No. CMT-01HTH-0.8DA, CMT-01FTH-0.8DA)

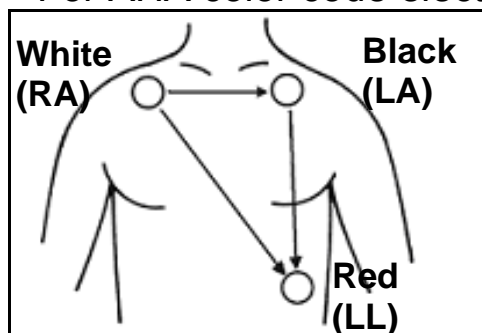

Standard Limb leads

Standard Limb leads can be selected from lead I, lead II, or lead III under the setting of the equipment.

Refer to “7. Operation ■ Changing Setup ● ECG Display Screen (1) <<Switching Lead>>” in page 25.

### For 4-electrode lead cable

For AHA color code electrode position (No. CMT-02HTH-0.8DA, CMT-02FTH-0.8DA)

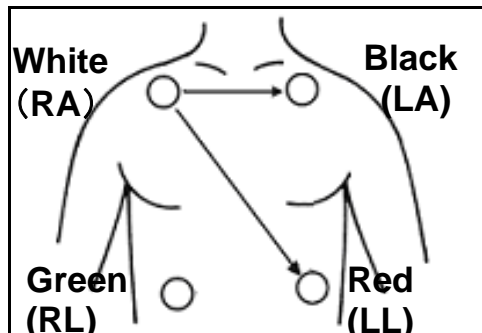

Standard Limb leads

Two leads measurements, lead I and II are fixed. Lead III, aVR, aVL, and aVF can be also displayed from the setting on the receiving monitor. For details, refer to the operation manual of the receiving monitor.

**For 5-electrode (Chest) lead cable**

For AHA color code electrode position (No. CMT-03HTH-0.8DA, CMT-03FTH-0.8DA)

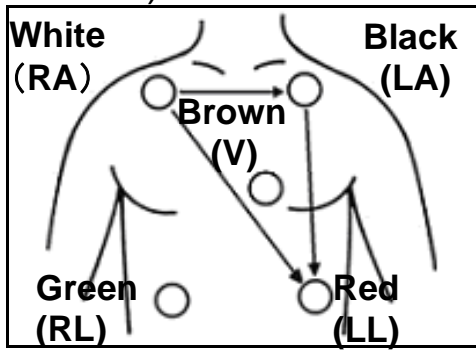

Standard Limb lead  
and Chest lead

One limb lead and one chest lead (Brown) measurements are available. Standard Limb leads can be selected from lead I, lead II, or lead III under the setting of the equipment.

The chest lead waveform is measured from the chest lead (Brown) positioned on the chest.

Refer to “7. Operation ■ Changing Setup ● ECG Display Screen (1) <<Switching Lead>>” in page 25.

## 4. ECG Monitoring

### ■ Attaching the Electrodes

#### ⚠ CAUTION

- Always use the same type of electrodes. If different types of electrodes are used at the same time, the difference between the polarization potential from each electrode may interfere with monitoring.
- Do not reuse the disposable electrodes. It is intended for single patient use only.



Clean the electrode sites with alcohol wipes or other skin preparation. If necessary, shave the electrode sites to remove excessive hair.

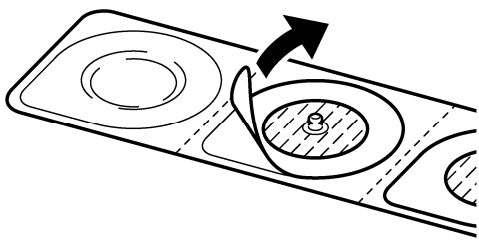

Peel off the disposable electrode.  
Pay attention not to touch the electrode gel.

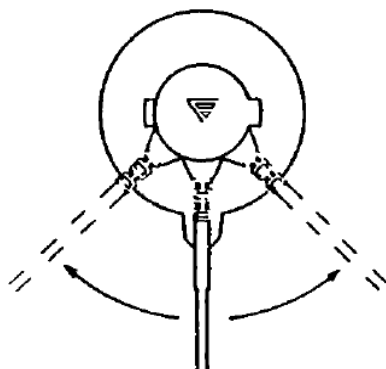

Attach the lead cable end to the electrode (convex part).  
Turn right and left to verify that it is securely attached.



■ **Connecting the ECG Lead Cable to the LX-7120(G)**

Insert the ECG lead cable firmly into the ECG/RESP input connector matching the transmitter's connector guide and the direction of the notched part on the connector.

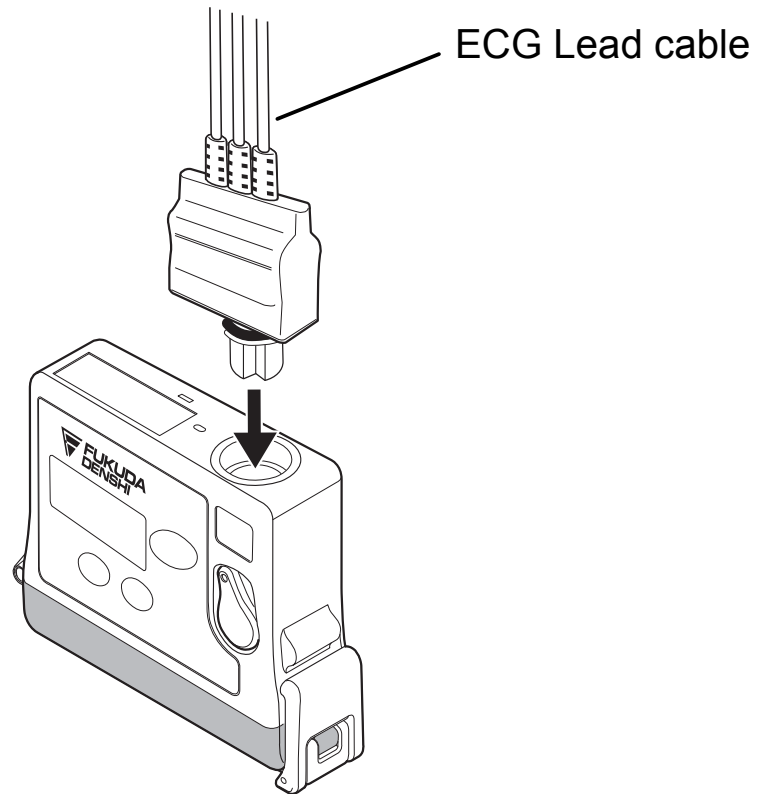

#### 4. ECG Monitoring

### CAUTION

- There are some cases when pacemaker pulse cannot be detected depending on the pacemaker type, pulse voltage, pulse width, electrode lead type (unipolar, bipolar), electrode placement, or lead method which causes the pacemaker pulse amplitude to decrease and disables pacemaker pulse detection.
- If signals similar to a pacemaker pulse are present, such as electric blanket noise or excessive AC frequency noise, these may be erroneously detected and displayed as a pacemaker pulse. In this case, check the condition of the electrodes and ECG lead cable to resolve the cause or turn off the pacemaker detection setting on the receiving monitor.
- Time constant of this equipment is shorter than Fukuda Denshi monitors (direct ECG connection). Therefore, there is a difference in the ST measurement value between them. Pay attention to the difference when monitoring a patient from a transmitter or a monitor.
- When an electrode is attached on the same location for a long time, some patients may develop skin irritation. Check the patient's skin condition periodically and change the electrode position as required.
- The indication for continuous use of an electrode is about one day.
- Replace the electrode if the skin contact gets loosen due to perspiring, etc.
- Make sure to use new disposable electrodes. Otherwise, the waveform quality may become poor and it may fail to perform correct monitoring.
- When "Check Electrode" message is displayed on the screen of the receiving monitor or the LCD of this equipment, check the condition of the electrodes and ECG lead cable to resolve the cause.
- When removing electrodes from the patient, remove them carefully and slowly. Do not apply excessive force to remove them. Otherwise, it may damage the skin.
- It may not perform a correct measurement due to the attached position of the electrodes. Attach the electrodes on the patient referring to page 10 and 11 and make sure that the correct waveform is measured on the LCD.

## 5. Respiration Monitoring

---

Follow the preparation of “4.ECG Monitoring” to allow the respiration monitoring.

This respiration monitoring is performed with impedance method. The ECG electrodes are also used for detecting the respiration. Each lead cable specifies the electrodes to detect the respiration. For 3-electrode and 5-electrode (chest) lead cable, the electrodes to detect the respiration are fixed as follows. Even if lead method is switched, they are no changes.

Lead Cable	Color of Electrode
3-electrode	White (RA) and Red (LL)
4-electrode	White (RA) and Red (LL)
5-electrode (Chest)	White (RA) and Red (LL)

### WARNING

Minute ventilation rate-adaptive implantable pacemakers can occasionally interact with certain cardiac monitoring and diagnostic equipment, causing the pacemakers to pace at their maximum programmed rate. The cardiac monitoring and diagnostic equipment may possibly send wrong information.

If such event occurs, please disconnect the cardiac monitoring and diagnostic equipment, or follow the procedures described in the operation manual of the pacemaker.

(For more details, contact FUKUDA DENSHI personnel, your institution's professionals, or your pacemaker distributors.)

#### Reference

“Minute Ventilation Rate-Adaptive Pacemakers”

FDA alerts health professionals that minute ventilation rate-adaptive implantable pacemakers can occasionally interact with certain cardiac monitoring and diagnostic equipment, causing pacemakers to pace at their maximum programmed rate.

[October 14, 1998 (Letter: [www.fda.gov/cdrh/safety.html](http://www.fda.gov/cdrh/safety.html)) - FDA]

### CAUTION

- Even if the electrodes are attached on the proper positions for ECG monitoring, it may not be always the proper ones for respiration monitoring as well.
- When a defibrillator is used during respiration monitoring, a large offset voltage will be placed on the ECG electrodes, which may cause interruption of monitoring for a few seconds.

## 5. Respiration Monitoring

Blank Page

## 6. Measurement

Turn ON the power and the measurement starts.

### ■ Starting Screen

When the power is turned ON, the channel number configured on the LX-7120(G) is displayed at the top of the LCD.



Make sure whether the channel number on the LCD matches the channel number indicated on the label of the LX-7120(G) and the channel number configured on the receiving monitor. This screen automatically moves onto the next waveform display screen.

### ■ Waveform Display Screen

ECG waveform (1CH when using 3-electrode lead cable, 2CH when using other lead cable), heart rate, pacemaker marker, respirogram, respiration rate, remaining battery level, and various messages are displayed.

<b>⚠ CAUTION</b>	
●	The LX-7120(G) does not have a diagnostic function. Check the diagnostic function on the receiving monitor.
●	The LX-7120(G) does not have an alarm function. Check the alarm function on the receiving monitor.
●	The ECG waveform size and sweep speed settings displayed on the LCD of the LX-7120(G) do not interface with the ones displayed on the screen of the receiving monitor.
●	The heart rate and respiration rate displayed on the LCD of the LX-7120(G) may be different from the ones displayed on the receiving monitor. Because the algorithm of the ECG and respiration rate is different.

### ■ Battery Level Check

Check the battery level on the waveform display screen.



Battery Symbol	Remaining Battery Level
	Full
	Getting low but still available
	Nearly empty Replace the battery. A message that prompts the battery check appears on the screen of the receiving monitor.

## 6. Measurement

### ■ Waveform Display

#### ● ECG Display Screen (1)

ECG1 waveform, heart rate, pacemaker marker, remaining battery level, and electrode check message are displayed.

The LCD display will automatically turn itself OFF after 60 seconds if no operation is done. To restart the LCD display, refer to page 29.

When the LCD display is active, press the  button to move onto the next waveform display screen.

#### 【Descriptions of the Screen】

The descriptions of contents displayed on the LCD are as follows.

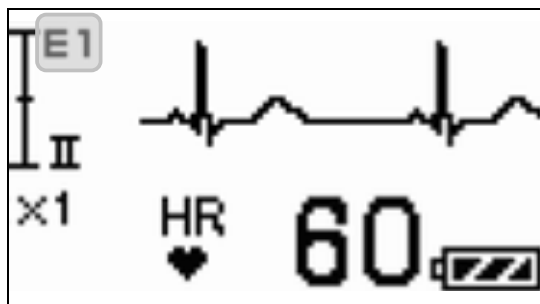

Indicates ECG 1.

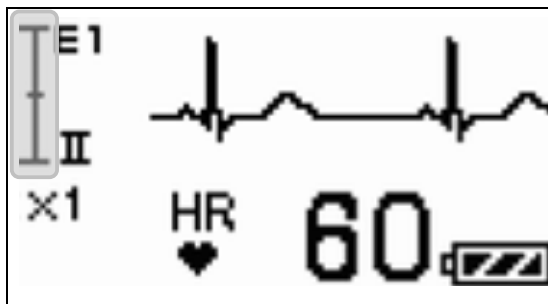

Indicates the scale of the displayed ECG.

One scale corresponds to 1mV. In the left illustration, it can display ECG waveform between -1mV and +1mV.



Displays the ECG waveform.



Displays the heart rate.  
♥ is displayed in synchronization with the heart rate.



Displays the detection marker when the pacemaker pulse is detected.



Indicates the measuring lead.

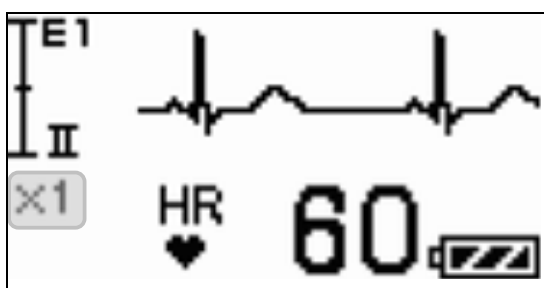

Indicates the ECG waveform size displayed on the LCD.

### ⚠ CAUTION

- The ECG waveform size setting displayed on the LCD does not interact with the one displayed on the screen of the receiving monitor, because the LX-7120(G) cannot transmit the setting information of the waveform size to the receiving monitor. If the ECG waveform size displayed on the screen of the receiving monitor is changed, follow the instruction in the operation manual of the receiving monitor.
- In case of the outside of the heart rate range (12 to 300bpm), 0bpm will be displayed if 11bpm and below is measured and 300bpm will be displayed if 300bpm and above is measured.

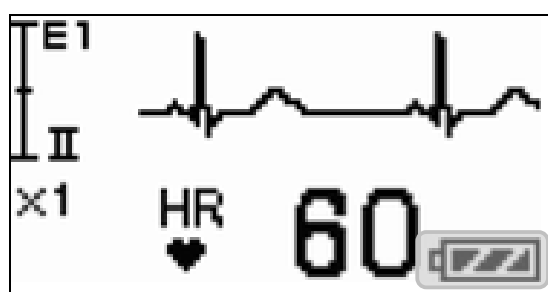

Indicates the remaining battery level.

For details of the battery level, refer to page 17.

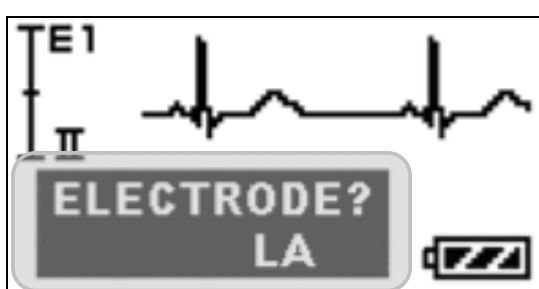

Displays the electrode check "ELECTRODE?" message appears when the ECG electrode is detached.

## 6. Measurement

### ● ECG Display Screen (2)

ECG2 waveform, heart rate, pacemaker marker, remaining battery level, and electrode check message are displayed.

#### NOTE

If a 3-electrode lead cable is used, this screen will not appear.

The LCD display will automatically turn itself OFF after 60 seconds if no operation is done. To restart the LCD display, refer to page 29.

When the LCD display is active, press the  button to move onto the next waveform display screen.

#### 【Descriptions of the Screen】

The descriptions of contents displayed on the LCD are as follows.

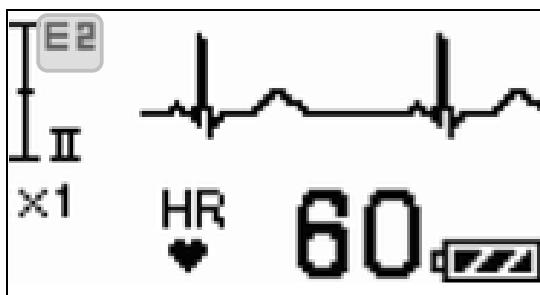

Indicates ECG 2.

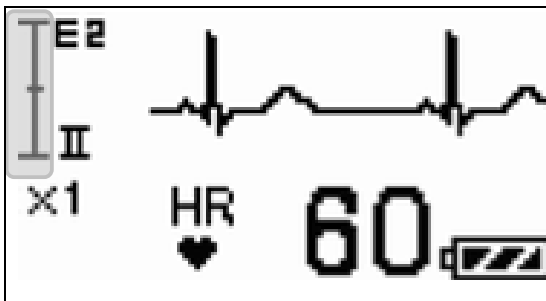

Indicates the scale of the displayed ECG.

One scale corresponds to 1mV.  
In the left illustration, it can display ECG waveform between -1mV and +1mV.

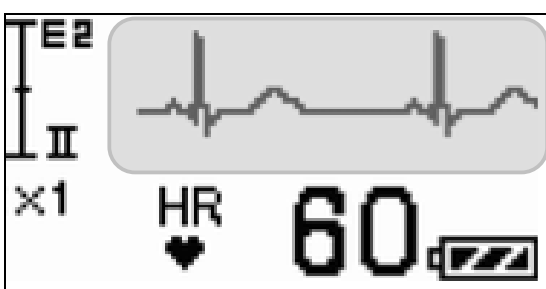

Displays the ECG waveform.

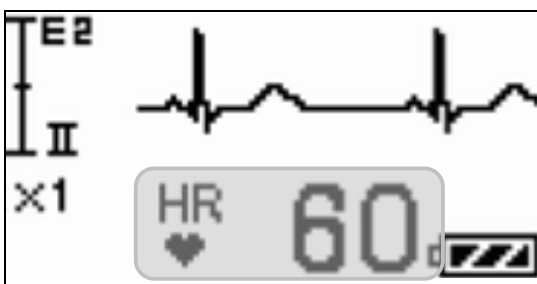

Displays the heart rate.

♥ is displayed in synchronization with the heart rate.





Displays the detection marker when the pacemaker pulse is detected.

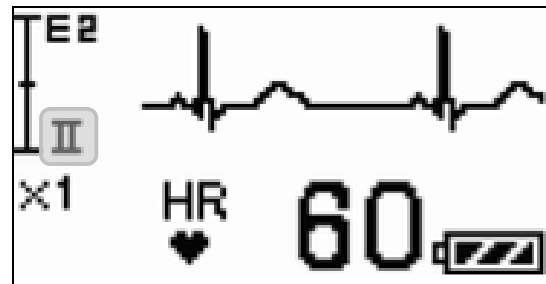

Indicates the measuring lead.

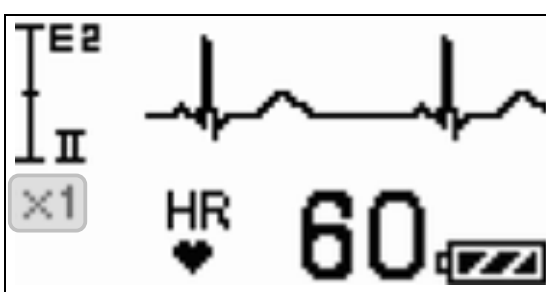

Indicates the ECG waveform size displayed on the LCD.

### ⚠ CAUTION

- The ECG waveform size setting displayed on the LCD of the LX-7120(G) does not interact with the one displayed on the screen of the receiving monitor, because the LX-7120(G) cannot transmit the setting information of the waveform size to the receiving monitor. If the ECG waveform size displayed on the screen of the receiving monitor is changed, follow the instruction in the operation manual of the receiving monitor.
- In case of the outside of the heart rate range (12 to 300bpm), 0bpm will be displayed if 11bpm and below is measured and 300bpm will be displayed if 300bpm and above is measured.



Indicates the remaining battery level.

For details of the battery level, refer to page 17.

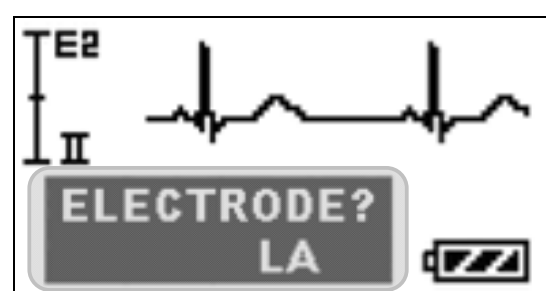

Displays the electrode check "ELECTRODE?" message appears when the ECG electrode is detached.

## 6. Measurement

### ● Respiration Display Screen

Respiration waveform, respiration rate, remaining battery level, and electrode check message are displayed.

The LCD display will automatically turn itself OFF after 60 seconds if no operation is done. To restart the LCD display, refer to page 29.

When the LCD display is active, press the  button to move onto the next waveform display screen.

#### 【Descriptions of the Screen】

The descriptions of contents displayed on the LCD are as follows.

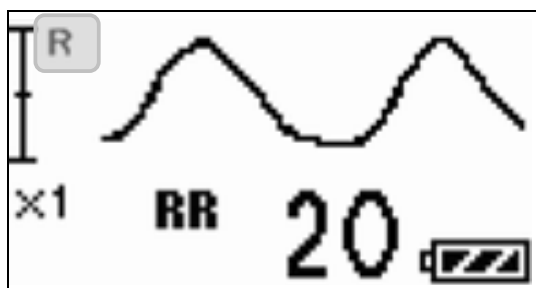

Indicates the respiration waveform display screen.

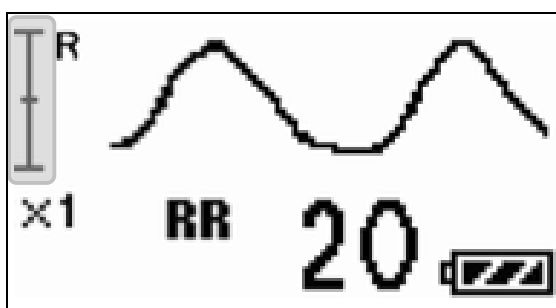

Indicates the scale of the displayed respiration waveform.

One scale corresponds to  $1\Omega$ . In the left illustration, it can display the change of respiration waveform between  $-1\Omega$  and  $+1\Omega$ .

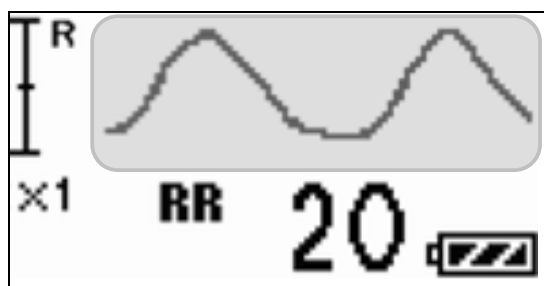

Displays the respiration waveform.

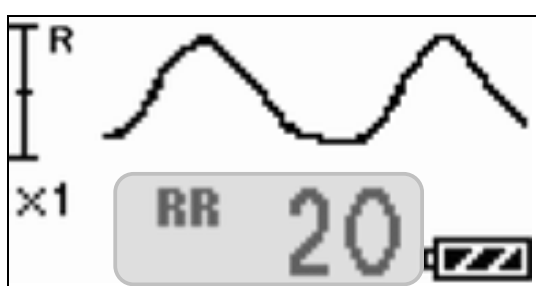

Displays the respiration rate.

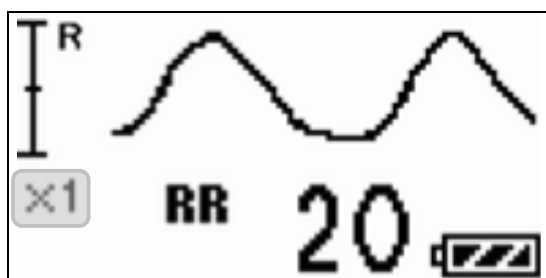

Indicates the respiration waveform size displayed on the LCD.

## ⚠ CAUTION

- The respiration waveform size setting displayed on the LCD does not interact with the one displayed on the screen of the receiving monitor, because the LX-7120(G) cannot transmit the setting information of the waveform size to the receiving monitor. If the respiration waveform size displayed on the screen of the receiving monitor is changed, follow the instruction in the operation manual of the receiving monitor.
- In case of the outside of the respiration rate range (9 to 150Bpm), 0Bpm will be displayed if 8Bpm and below is measured and 150Bpm will be displayed if 150Bpm and above is measured.

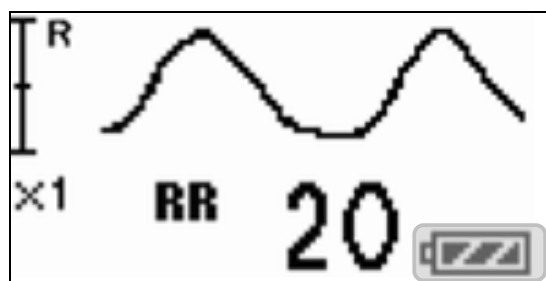

Indicates the remaining battery level.

For details of the battery level, refer to page 17.

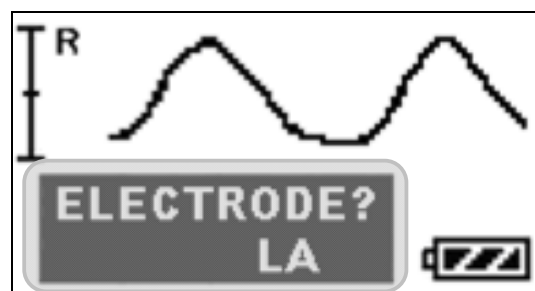

Displays the electrode check "ELECTRODE?" message appears when the ECG electrode is detached.

## 6. Measurement

Blank Page

## 7. Operation

### ■ Changing Setup

#### ● ECG Display Screen (1)

In the ECG display screen (1), the ECG waveform size and lead displayed on the LCD of the LX-7120(G) can be changed.

#### 【Setting Method】

How to enter the setup mode:

Press and hold the **Enter** button for 2 seconds in the ECG display screen (1).

#### <<Switching Lead>>

Lead of ECG 1 can be switched when 3-electrode lead cable or 5-electrode (Chest) lead cable is used.

Select an appropriate lead by checking the ECG waveform on the LCD.

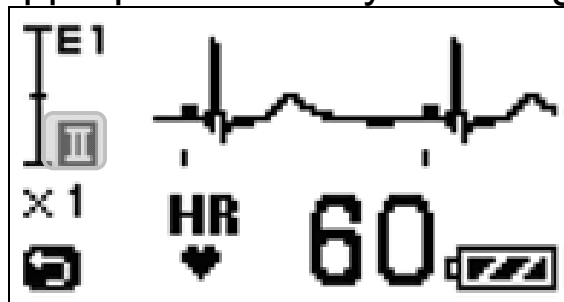

The lead indication of ECG 1 is highlighted.

Pressing the **Enter** button will sequentially change the lead of ECG 1.

Lead I → II → III → I

#### <<Changing ECG1 Waveform Size on LCD>>

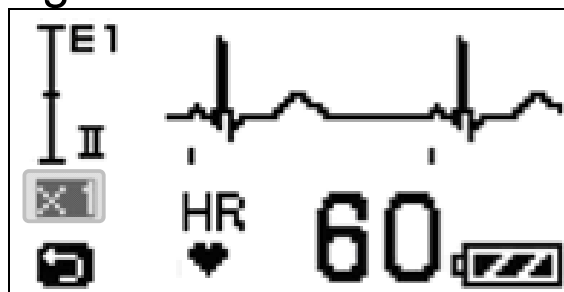

Press the **▽** button to highlight the size indication of ECG 1.

Pressing the **Enter** button will sequentially change the size of ECG 1.

Size x1 → x1/2 → x1

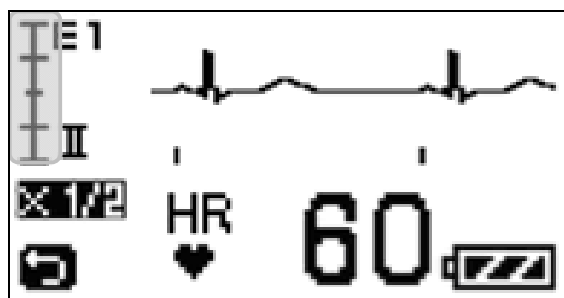

When changing the size of the ECG waveform on the LCD, the ECG scale will also change. In the left illustration, it can display the ECG waveform between -2mV and +2mV.

### ⚠ CAUTION

The ECG waveform size setting displayed on the LCD of the LX-7120(G) does not interact with the one displayed on the screen of the receiving monitor, because the LX-7120(G) cannot transmit the setting information of the waveform size to the receiving monitor. If the ECG waveform size displayed on the screen of the receiving monitor is changed, follow the instruction in the operation manual of the receiving monitor.

## 7. Operation

<< Returning to ECG Display Screen (1) >>

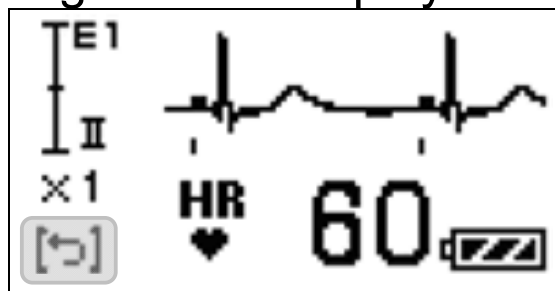

Press the  button to highlight the **Return** button.

Press the **Enter** button to return to the ECG display screen (1).

### CAUTION

Do not operate the LX-7120(G) with the setup screen open to prevent the settings to be changed due to an unintended operation. Make sure to press the **Return** button to terminate the setup screen. The LCD display will automatically turn itself OFF after 60 seconds if the **Return** button is not pressed.

## ● ECG Display Screen (2)

In the ECG display screen (2), the ECG waveform size displayed on the LCD of the LX-7120(G) can be changed.

### 【Setting Method】

How to enter the setup mode:

Press and hold the **Enter** button for 2 seconds in the ECG display screen (2).

### << Changing ECG2 Waveform Size on LCD >>

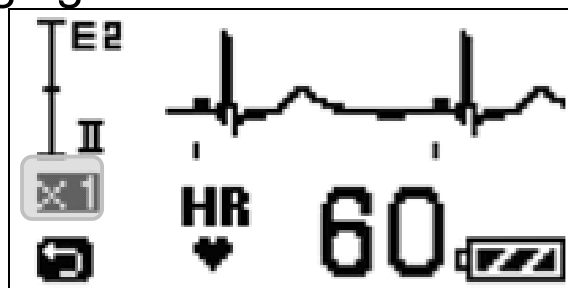

The size indication of ECG 2 is highlighted.

Pressing the **Enter** button will sequentially change the size of ECG 2.

Size  $\times 1 \rightarrow \times 1/2 \rightarrow \times 1$

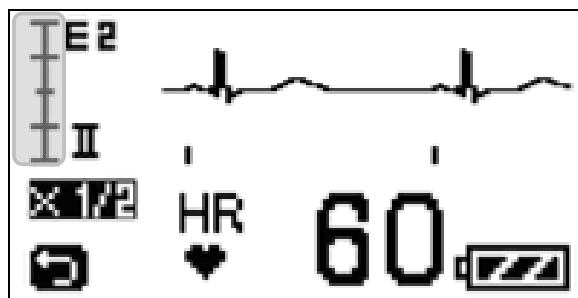

When changing the size of the ECG waveform on the LCD, the ECG scale will also change.

In the left illustration, it can display ECG waveform between -2mV and +2mV.

## ⚠ CAUTION

The ECG waveform size setting displayed on the LCD of the LX-7120(G) does not interact with the one displayed on the screen of the receiving monitor, because the LX-7120(G) cannot transmit the setting information of the waveform size to the receiving monitor. If the ECG waveform size displayed on the screen of the receiving monitor is changed, follow the instruction in the operation manual of the receiving monitor.

### << Returning to ECG display screen (2) >>

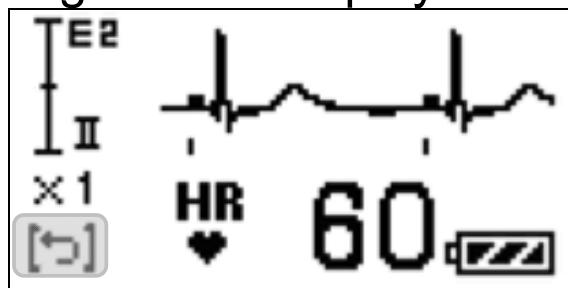

Press the **▽** button to highlight the **Return** button.

Press the **Enter** button to return to the ECG display screen (2).

## 7. Operation

### ● Respiration Display Screen

In the respiration display screen, the respiration waveform size displayed on the LCD of the LX-7120(G) can be changed.

#### 【Setting Method】

How to enter the setup mode:

Press and hold the **Enter** button for 2 seconds in the respiration display screen.

#### << Changing Respiration Waveform Size on LCD >>>

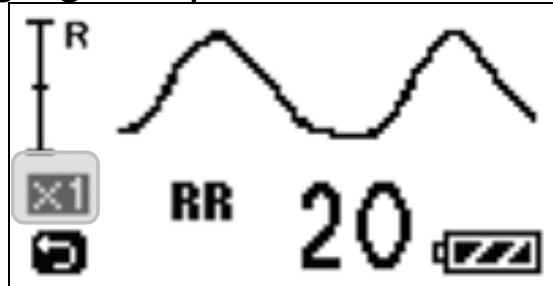

The size indication of the respiration is highlighted.

Pressing the **Enter** button will sequentially change the size of respiration.

Size  $\times 1 \rightarrow \times 1/2 \rightarrow \times 1$

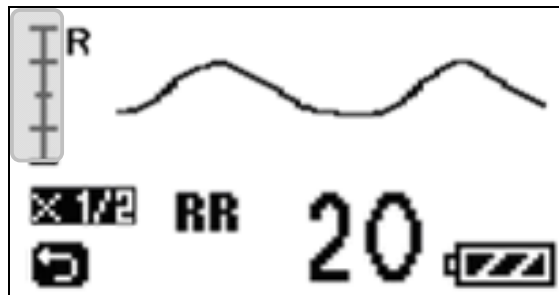

When changing the size of the respiration waveform on the LCD, the respiration scale will also change.

In the left illustration, it can display the respiration waveform until 4Ω of change.

### ⚠ CAUTION

The respiration waveform size setting displayed on the LCD of the LX-7120(G) does not interact with the one displayed on the screen of the receiving monitor, because the LX-7120(G) cannot transmit the setting information of the waveform size to the receiving monitor. If the respiration waveform size displayed on the screen of the receiving monitor is changed, follow the instruction in the operation manual of the receiving monitor.

#### << Returning to Respiration Display Screen >>

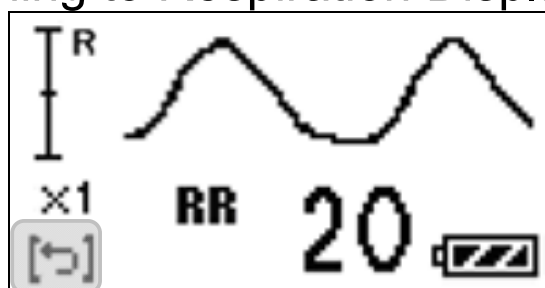

Press the **Return** button to highlight the **Return** button.

Press the **Enter** button to return to the respiration display screen.



**⚠ CAUTION**

Do not operate the LX-7120(G) with the setup screen open to prevent the settings to be changed due to an unintended operation. Make sure to press the **Return** button to terminate the setup screen. The LCD display will automatically turn itself OFF after 60 seconds if the **Return** button is not pressed.

**■ Restarting the LCD display**

The LCD display will automatically turn itself OFF after 60 seconds if no operation is done.

Press the **Enter** button or press and hold the **▽** button to restart the LCD display.

The starting screen with telemetry channel number appears, and then the waveform display screen appears.

**■ Pressing the EVENT button**

Press and hold the **EVENT** button for 2 seconds to activate the function assigned on the receiving monitor. The following message appears on the LCD while the “EVENT” is transmitted.



After the transmission is completed, the starting screen with the telemetry channel number appears, and then the waveform display screen appears. “EVENT” operation is available as a remote recording.

For details of the receiving monitor operation and settings related to the “EVENT” function, refer to the operation manual of the receiving monitor.

## 7. Operation

Blank Page

## 8. Other Setting Items

---

The following settings are available for the LX-7120(G) depending on the use and condition of the patient. For details of the settings, contact our service representative.

Items	Selection	Default	Backup
Time Constant	0.4 sec., 0.1 sec.	0.4 sec.	Yes
Detection Sensitivity of Pacemaker Pulse	Low, Mid, High	Mid	Yes
Respiration Detection Signal	ON, OFF	ON	Yes
LCD Contrast	8 steps	8	Yes
Transmitter Channel	One from the following channels.  9501 to 9539 9600 to 9639 9700 to 9739 9800 to 9839 9900 to 9938  2701 to 2739 2800 to 2839 2900 to 2918 2921 to 2939 3000 to 3039 3100 to 3118	9501	Yes
Group ID	One from 00 to 63	00	Yes

## 8. Other Setting Items

### ■ Changing the Time Constant

The default setting of the time constant is “0.4 seconds”.

If a stable monitoring is difficult with excessive change in the baseline due to excessive body motion of the patient or an interference noise, such as AC frequency, by changing the time constant to “0.1 second” the monitoring may become relatively stable.

For details of the setting change, contact your local Fukuda Denshi service representative.

#### CAUTION

- When changing the time constant to “0.1 seconds”, the lower frequency characteristic becomes  $1.6\text{Hz} \pm 25\%$ . This setup does not meet IEC 60601-2-27 standard. It may lead to a change in the ECG waveform and ST measurement value may be especially affected. Fukuda Denshi recommends “0.4 seconds” setting in normal use.
- The LCD screen in normal use does not indicate the selection of time constant. Make sure to take measures, such as marking on the LX-7120(G), to distinguish whether the selection of time constant is changed.

## ■ Changing the Detection Sensitivity of the Pacemaker Pulse

The default setting of pacemaker pulse detection sensitivity is “Mid”. The “Mid” setting can detect and reject the following pacemaker pulse specified in ANSI/AAMI EC13 standard.

### Detection/ Rejection of Pacemaker Pulse:

- a) Pacemaker Pulse without Over/Undershoot:  
Capable to reject pulses of pulse width 0.1 to 2ms,  
amplitude  $\pm 2$  to  $\pm 700$ mV
- b) Pacemaker Pulse with Over/Undershoot:  
Rejection is not possible.

Fukuda Denshi recommends the “Mid” setting in normal use.

There may be some cases when the pacemaker pulse cannot be detected depending on the pacemaker type, pulse voltage, pulse width, electrode lead type (unipolar, bipolar). In this case, change the lead or the position of the electrodes to be able to detect the pacemaker pulse.

Nonetheless, if the detection is still undetectable, change the setting to “High” in order to increase the detection sensitivity. So that smaller pacemaker pulse can be detected. However, the “High” setting may lead to erroneous detection due to interference noise, such as AC frequency.

If erroneous detections occur due to interference noise, such as AC frequency, turn OFF the setting of the pacemaker pulse detection in the receiving monitor. If erroneous detections occur due to interference noise, such as AC frequency, while monitoring a patient with a pacemaker, and the setting of the pacemaker pulse detection cannot be turned OFF, replace the electrodes or change the lead to remove the interference noise, such as AC frequency.

Nonetheless, if erroneous detections still occur, change the setting to “Low” in order to decrease the detection sensitivity. It makes the LX-7120(G) less likely to be interfered by the noise, such as AC frequency.

The “Low” setting decreases the detection sensitivity. Therefore, it cannot detect the pacemaker pulse specified in ANSI/AAMI EC13 standard.

For details of the setting change, contact your local Fukuda Denshi service representative.

### CAUTION

The LCD screen in normal use does not indicate the setting status of the pacemaker pulse detection. Make sure to take measures, such as marking on the LX-7120(G), to distinguish whether the setting of the pacemaker pulse detection is changed.

## 8. Other Setting Items

### ■ Changing the Respiration Detection Signal ON/OFF

The default setting of the respiration detection signal is “ON”.

The respiration waveform can be detected when the setting of the respiration detection signal is turned “ON”.

#### WARNING

If the LX-7120(G) is used with minute ventilation rate-adaptive implantable pacemaker, the respiration detection signal may cause the pacemaker to pace at its maximum programmed rate. If such event occurs, change the setting to “OFF” to prevent an occurrence of erroneous pacing rate.

For details of the setting change, contact your local Fukuda Denshi service representative.

#### CAUTION

- The respiration waveform cannot be measured if the setting of the respiration detection signal is turned “OFF”.
- Make sure to turn OFF the respiration measurement function on the receiving monitor to prevent an erroneous detection of the respiration alarm (on the receiving monitor side).
- The LCD screen in normal use does not indicate the setting status of the respiration detection signal ON/OFF. Make sure to take measures, such as marking on the LX-7120(G), to distinguish whether the setting of the respiration detection signal ON/OFF is changed.

### ■ Changing the LCD Contrast

The LCD display contrast of the LX-7120(G) can be changed in 8 steps.

For details of the setting change, contact your local Fukuda Denshi service representative.

## 8. Other Setting Items

Blank Page

## 9. Changing the Transmitter Channel and Group ID

---

### ■ Changing the Transmitter Channel

The LX-7120(G) is a transmitter of PLL synthesizer type, and its transmitter channel can be programmed. It can be set up with an arbitrary channel among the channels assigned by the Telemetry Laws (according to each country).

For details of the setting change, contact your local Fukuda Denshi service representative.

#### WARNING

- If the transmitter channel is changed, follow the instruction by the person in charge of the radio telemetry channel in your facility. Mismanagement may result in a serious accident, such as interference and mixing up patients.
- Replace promptly the new channel label if the transmitter channel has been changed.

### ■ Changing the Group ID

The LX-7120(G) transmits its group ID, which it belongs to, to prevent interference with neighboring hospital's transmitter.

The receiving monitor checks whether the incoming group ID is the same as the programmed one that the receiving monitor has. There are 64 group codes available. The default setting is "00".

The transmitter group ID can be changed if there is interference with a neighboring hospital's transmitter.

For details of the setting change, contact your local Fukuda Denshi service representative.

#### CAUTION

Possible causes of interference other than radio telemetry from neighboring hospital's transmitter, are the proximity of mobile phone, amateur radio station, radio taxi, and illegal citizens band, which may be a cause of interference. In such a case, the situation should be carefully observed to find the cause of interference.



Blank Page





## 10. Troubleshooting

---

### ■ List of Displayed messages

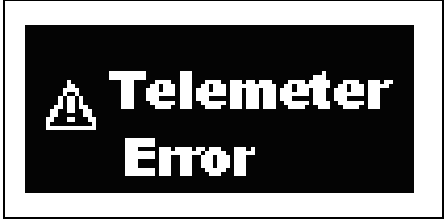
#### Transmitter (main unit)

Message	Cause	Solution
	Failed to transmit waveform and value.	Contact your local Fukuda Denshi service representative.
	Faulty EEPROM.	
	Failed to initialize CPU.	

#### ECG

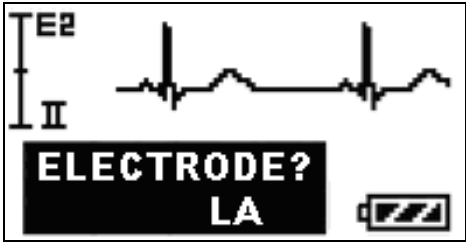
Message	Cause	Solution
 <p>Character string displayed, such as LA, depends on the detached electrode position.</p>	Electrode is off.	Check the electrode condition.

## 10. Troubleshooting

### ■ Troubleshooting

Make sure of the following. However, if there is no improvement in the phenomenon, contact your local Fukuda Denshi service representative.

#### Transmitter (main unit)

Phenomenon	Cause	Solution
Nothing is displayed on the LCD when the power switch is turned ON.	No battery or wrong polarity	Install the battery correctly.
	Battery level is empty.	Replace the battery with a new one.
Nothing is displayed on the receiving monitor screen.	The channel number between the transmitter and the receiving monitor do not match up.	Set the same channel number for the transmitter and the receiving monitor.
Transmission problem.	Same channel number is already used.	Make sure to not duplicate channel numbers. Follow the instruction by the person in charge of radio telemetry channel in your facility and use the LX-7120(G) with the correct channel setting.
	Channel interference	Follow the instruction by the person in charge of radio telemetry channel in your facility and use the LX-7120(G) with the correct channel setting.
	Transmitter failure	Contact your local Fukuda Denshi service representative.

## ECG

Phenomenon	Cause	Solution
“ELECTRODE?” message is displayed.	Lead cable is off.	Check the connection between the lead cable and the LX-7120(G).
		Check the connection between the lead cable and the electrode.
	Faulty Lead cable.	Replace the ECG cable with a new one.
	Electrode is peeling off.	Replace the electrode with a new one.
	Polarization potential of the electrode is too high.	Replace the electrode with a new one.
ECG waveform contains noise	Electrode gel is dry.	Replace the electrode with a new one.
	Electrode is peeling off.	
	Electric blanket is used.	Cover the electric blanket with a shield cover.
	AC filter setting of the receiving monitor is OFF.	Set the AC filter up as ON.
Respiration waveform cannot be measured.	Electrode gel is dry.	Replace the electrode with a new one.
	Electrode is peeling off.	
	The positions of the electrodes are improper.	Attach the electrodes where the respiration waveform can be measured appropriately.

## 10. Troubleshooting

### ■ In Case of Dropping the LX-7120(G) into Water

In case of dropping the LX-7120(G) into water containing disinfectant, pick up the LX-7120(G) quickly from it. Rinse it well with running water, and dry it thoroughly with a soft cloth.

#### CAUTION

- Do not use a drier. The LX-7120(G) shape may change or be broken.
- When the LX-7120(G) is rinsed with running water, make sure to close the battery compartment lid.

## 11. Cleaning and Disinfection

---

The Cleaning and disinfection of the LX-7120(G) and ECG lead cable shall be performed as follows.

### CAUTION

Do not sterilize the LX-7120(G) and ECG lead cable in any manners, such as radioactive rays, steam, or ethylene oxide.

### ■ Cleaning and Disinfecting the LX-7120(G)

#### ● Cleaning

Clean the LX-7120(G) using squeezed gauze or an absorbent cotton cloth dampened with alcohol or a neutral cleanser.

### CAUTION

- Clean the equipment frequently so stains can be removed easily.
- To prevent injury, it is recommended to wear gloves when cleaning the equipment.
- Do not allow any chemical solution to enter the inside of LX-7120(G) or connectors.
- The LX-7120(G) cannot be sterilized.
- Do not use organic solvents, thinner, toluene and benzene to avoid damaging the resin case.
- Do not polish the housing with abrasive or chemical cleaner.
- Use only neutral detergent to clean the housing. Do not use chemical cloth, scrub brush, abrasive, polishing powder, hot water, volatile solvent and chemicals (cleanser, thinner, benzene, benzol, and synthetic detergent for house and furniture), or sharp-edged tools. The surface resin coating may be damaged, resulting in discoloration, scratches, and other problems.

#### ● Disinfection

If there is a possibility of being infected, clean the LX-7120(G) using squeezed gauze or an absorbent cotton cloth dampened with alcohol or a neutral cleanser.

### CAUTION

- Do not immerse the connector parts of the LX-7120(G) in any chemical solution to prevent connection failure.
- When disinfecting the entire room using a spray solution, pay close attention not to have liquids get into the LX-7120(G) or connectors.

## 11. Cleaning and Disinfection

### ■ **Cleaning the ECG lead cable**

After using the cable, clean it with neutral detergent or 70% isopropyl alcohol.

#### CAUTION

- Do not use thinner, toluene, or other organic solvents to clean the cables.
- Do not pull the cable and do not hold the connector part when cleaning. (It may degrade the cable coating and result in damage. Particularly organic solvents and antiseptic solution such as cresol soap solution will degrade the cable coating.)
- After cleaning, dry it completely before usage.
- Do not use high temperature sterilization such as steam or EOG method.



## 12. Maintenance and Inspection

---

This section explains the daily checks and periodic checks of the LX-7120(G). To ensure safety, reliability, and high performance, a “Daily Check” and “Periodic Check” must be performed. We are not liable for any accident arising from lack of maintenance.

### CAUTION

- Do not open the housing or attempt service. The service should be done by Fukuda Denshi or Fukuda Denshi’s representative.
- Do not allow excessive moisture or cleaning agents into the connectors or inside the equipment.

#### ■ Daily Check

Perform daily checks using the “Daily Check List” on the next page.

#### ■ Periodic Check

Periodic check of medical electronic equipment is mandatory to prevent failures and accidents and to ensure safety and reliability.

Periodic maintenance may be performed by the medical institution or by a third party by concluding a “Maintenance Contract”.

For more details, contact your local Fukuda Denshi service representative.

#### ■ Periodic Replacement Parts

The “**Battery Compartment Lid (Waterproof)**” is the only periodic replacement part.

To ensure the reliability of waterproof (IPX8) performance of the LX-7120(G), replace it once a year.

It may be possible to keep using the LX-7120(G) without periodic replacement of the lid. However, as it gets older, the reliability of water resistance (IPX8) performance will not be ensured.

When replacing the lid, contact your local Fukuda Denshi service representative.

### CAUTION

The periodic replacement parts must be replaced at specified period.

## 12. Maintenance and Inspection

### Daily Check List

No. \_\_\_\_\_

Inspected Date \_\_\_\_\_ Inspected by \_\_\_\_\_ Location \_\_\_\_\_

Device Type LX-7120(G) S/No. \_\_\_\_\_ Date of Purchase \_\_\_\_\_

<i>Items</i>	<i>Details</i>	<i>Criteria</i>	<i>Judgment</i>
Appearance	Visually check for any damage, cracks, chip, peeled label, and loosen screw on the housing.	No abnormality should be found.	<input type="checkbox"/> OK/ <input type="checkbox"/> NG
Battery Compartment	Visually check for the ring condition of the battery compartment lid.	No damage, kink, floating, and adhesion of dust should be found.	<input type="checkbox"/> OK/ <input type="checkbox"/> NG
	Visually check for the contact springs, inside the LX-7120(G), to the battery and the lock lever of the battery compartment lid.	No deformation, cracks, and rust should be found.	<input type="checkbox"/> OK/ <input type="checkbox"/> NG
Power Supply	Turn the power ON/OFF to verify proper switch operation.	With battery installed, the LCD should turn ON.	<input type="checkbox"/> OK/ <input type="checkbox"/> NG
ECG Connectors	Visually check the connectors of the cable and the LX-7120(G).	No damage, chip, and adhesion of dust should be found.	<input type="checkbox"/> OK/ <input type="checkbox"/> NG
ECG Lead cable	Visually check each lead for damages.	No crack and damage should be found.	<input type="checkbox"/> OK/ <input type="checkbox"/> NG
Wireless Channel	Verify whether the transmitting channel and group ID are the same with the receiving monitor.	Must match the wireless channel check list.	<input type="checkbox"/> OK/ <input type="checkbox"/> NG
Transmission Function	Turn the power ON and make sure the information is displayed on the receiving monitor.	Waveforms and values should be received without any problem.	<input type="checkbox"/> OK/ <input type="checkbox"/> NG
Display Function	Turn the power ON and verify each display condition, such as ECG value and waveform.	All data should be properly displayed.	<input type="checkbox"/> OK/ <input type="checkbox"/> NG
Periodic Check	Check the date of the previous periodic check.	Should be within one year.	<input type="checkbox"/> OK/ <input type="checkbox"/> NG

Comment

-----

-----

## 13. Standard and Optional Accessories

This section lists the accessories for the LX-7120(G).

### **⚠ WARNING**

Use only the accessories, such as ECG Lead cable, specified by Fukuda Denshi for the LX-7120(G). Otherwise, the LX-7120(G) cannot deliver its maximum performance and may be damaged, resulting in a safety hazard.

### **⚠ CAUTION**

For quality improvement, specifications are subject to change without prior notice.

### ■ Standard Accessories

<i>No.</i>	<i>Item</i>	<i>Model Type</i>	<i>Q'ty</i>	<i>Note</i>
1	Neck Strap	OA-311	1	
2	4-electrode ECG lead cable	CMT-02HTH-0.8DA	1	AHA color code, Hook Type, Limb Lead (2CH)
3	Operation Manual		1	

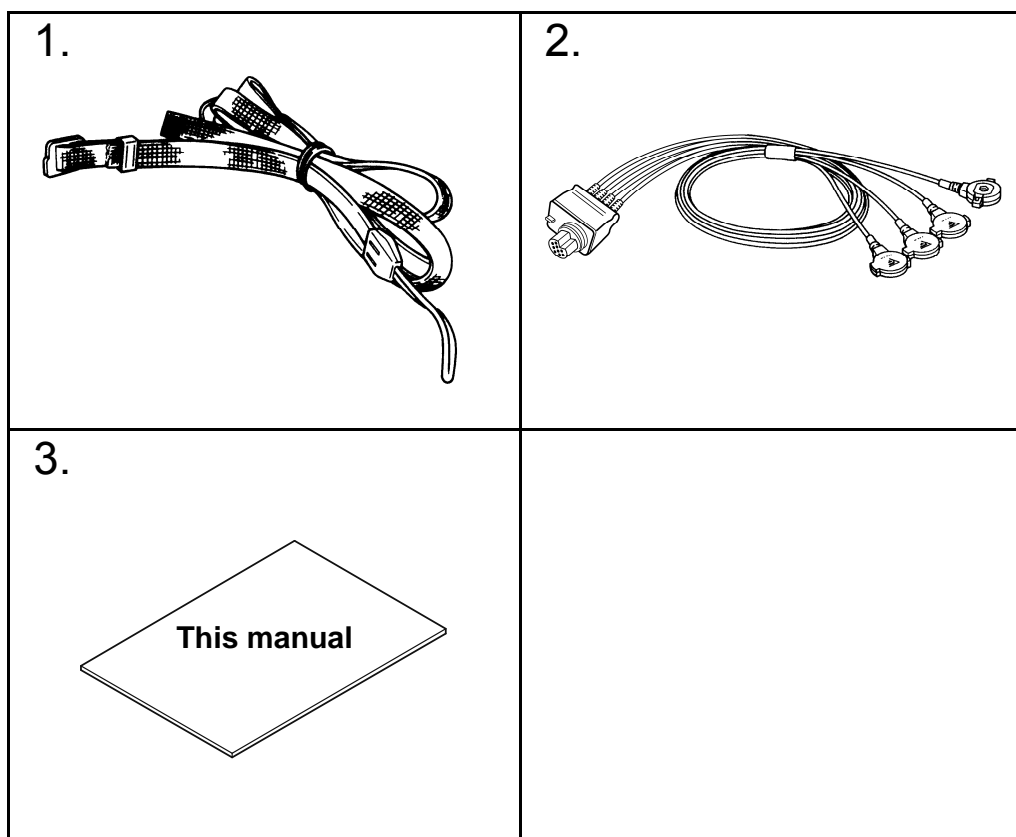

### 13. Standard and Optional Accessories

#### ■ Optional Accessories

The following accessories are available as optional for the LX-7120(G).  
Purchase them as required.

#### ● ECG, Impedance Respiration Measurement

AHA color code:

<i>Item</i>	<i>Model Type</i>	<i>Note</i>
ECG Hook Type Lead Cable	CMT-01HTH-0.8DA	3-electrode (White, Black, Red), Limb Lead (1CH)
ECG Hook Type Lead Cable	CMT-02HTH-0.8DA	4-electrode (White, Black, Red, Green), Limb Lead (2CH)
ECG Hook Type Lead Cable	CMT-03HTH-0.8DA	5-electrode (White, Black, Red, Green, Brown), Limb Lead (1CH)+Chest (1CH)
ECG Clip Type Lead Cable	CMT-01FTH-0.8DA	3-electrode (White, Black, Red), Limb Lead (1CH)
ECG Clip Type Lead Cable	CMT-02FTH-0.8DA	4-electrode (White, Black, Red, Green), Limb Lead (2CH)
ECG Clip Type Lead Cable	CMT-03FTH-0.8DA	5-electrode (White, Black, Red, Green, Brown), Limb Lead (1CH)+Chest (1CH)

## 14. Specification

---

### ■ Specification

 <b>CAUTION</b>
--

For quality improvement, specifications are subject to change without prior notice.
---

#### Standard Specification

Size:	60.6(W) x 60.0(H) x 20.6(D)mm (not including the protrusion)
Weight:	Approximately 85 grams (with battery)
Transmitting Waveform:	ECG 1CH or 2CH (selectable from the ECG lead cable), Respiration waveform
ECG Lead cable Type:	3-electrode, 4-electrode, or 5-electrode (Limb+Chest) lead cable Automatically detect the type after inserting the lead cable
Transmitting Status Data:	Electrode Off, Low Battery, Event Switch, Pacemaker Detection, Channel ID, 64group Codes
LCD:	Built-in
Waterproof:	IPX8
Power Supply:	DC: one (1) 1.5 V “AA” size (“LR06” size) alkaline battery
Continuous Operating Time:	Approximately 1.5 days
※Continuous operating time is assumed when using new “AA” size (“LR06” size) Alkaline battery specified by Fukuda Denshi.	

#### ECG

Numbers of Lead Electrode:	3-electrode, 4-electrode, or 5-electrode (Limb+Chest)
Numbers of Input Channel:	1CH(3-electrode) or 2CH
Accuracy of Sensitivity:	10mm /1mV $\pm 20\%$ (Display sensitivity on the receiving monitor)
ECG Input Impedance:	5M $\Omega$ and above
Maximum Input Voltage:	$\pm 5$ mV and above
Common Mode Rejection Ratio:	Less than 10mVp-p (95dB and above)
Accuracy of Heart Rate Measurement:	$\pm 10\%$ or $\pm 5$ bpm, whichever is greater
HR Display Range:	0, 12 to 300bpm (1bpm step)
Frequency Characteristic:	0.5 to 40Hz (within -3dB)

## 14. Specification

Time Constant:	0.4 sec $\pm 25\%$ Switching and available to set 0.1 sec $\pm 25\%$
Pacemaker Pulse Detection/ Rejection:	Comply with ANSI/AAMI EC13 Pacemaker pulse rejection capability
Protection to Defibrillation:	Meet the requirement of IEC60601-2-27

### Respiration (Impedance Method)

Accuracy of Sensitivity:	10mm/1 $\Omega$ $\pm 2$ mm (When standard Impedance is 480 $\Omega$ .)
Resp. Display Range:	0, 9 to 150Bpm
Display Error of Respiration Rate:	$\pm 3$ Bpm
Measured Current of Respiration:	Below 100 $\mu$ A (at 42kHz)

### Transmission Method

Modulation Mode:	Digital, Frequency shift keying
Frequency:	1395 to 1400MHz, 1427 to 1432MHz
Oscillation Method:	PLL Synthesizer method by crystal control
Channel Spacing:	25.0 kHz
Occupied Frequency	16 kHz
Bandwidth:	
RF output power:	5mW $\pm 2$ dB
Transmitting Antenna:	Dielectric Antenna

### Safety

General Standard:	IEC 60601-1:1988 +A1: 1991 +A2: 1995 (Medical electrical equipment – Part 1: General requirements for safety)
EMC Standard:	IEC 60601-1-2: 2007 (Medical electrical equipment – Part 1: General requirements for safety – 2. Collateral standard: Electromagnetic compatibility – Requirements and tests)
The class of protection against electric shock:	Internally Powered Equipment
The type of protection against electric shock:	Type CF Applied part

### Operating Environment

Temperature: 10 to 40°C  
Humidity: 30 to 85% RH (No condensation)  
Vibration/Shock: Comply with IEC60068-2-64:1987, IEC60068-2-32:1975,  
IEC60068-2-6:1995



### Transport / Storage Environment



Temperature: -10 to 60°C  
Humidity: 10 to 95% RH (No condensation)

## 14. Specification

### ■ Displays

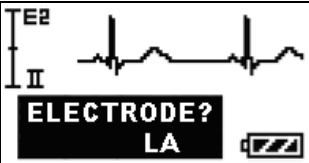
The following displays are shown on the LCD of the LX-7120(G).

	Display	Description
Starting Screen		Displays after turning on the power. Automatically moves onto the channel display screen.
Channel Display Screen		Displays the transmitter channel after turning on the power and also when refreshing the screen. Automatically move onto the waveform display screen.
EVENT		Displays when the <b>EVENT</b> button is pressed. Automatically move onto the channel display screen.
ELECTRODE?		Displays when the ECG electrode is disconnected or the ECG/respiration waveform cannot be measured normally. For details about electrode check message, refer to page 51.

	Display	Description
<b>Error Message</b>		
Telemeter Error		Displays when the transmitter is faulty
EEPROM Error		Displays when the EEPROM is faulty
CPU Error		Displays when the CPU is faulty



## ■ Details of the “ELECTRODE?” Message

The following “ELECTRODE?” messages are displayed on the LCD depending on the selected lead cable and lead.

For AHA color code

Check Position	3-electrode lead cable Lead I display	3-electrode lead cable Lead II display	3-electrode lead cable Lead III display
LL	<b>ELECTRODE?</b> LL	<b>ELECTRODE?</b> LL	<b>ELECTRODE?</b> LL
RA	<b>ELECTRODE?</b> RA	<b>ELECTRODE?</b> RA	<b>ELECTRODE?</b>
LA	<b>ELECTRODE?</b> LA	<b>ELECTRODE?</b>	<b>ELECTRODE?</b> LA
Several Position Simultaneously	<b>ELECTRODE?</b>	<b>ELECTRODE?</b>	<b>ELECTRODE?</b>

Check Position	4-electrode lead cable	For 5-electrode (Chest) lead cable
LL	<b>ELECTRODE?</b> LL	<b>ELECTRODE?</b> LL
RA	<b>ELECTRODE?</b> RA	<b>ELECTRODE?</b> RA
LA	<b>ELECTRODE?</b> LA	<b>ELECTRODE?</b> LA
RL	<b>ELECTRODE?</b>	<b>ELECTRODE?</b>
V		<b>ELECTRODE?</b> V
Several Position Simultaneously	<b>ELECTRODE?</b>	<b>ELECTRODE?</b>

## 14. Specification

### ■ List of Setup Items

This section lists the available selection, default setting, and backup status for each setup item, which is available for the LX-7120(G).

Items	Selection	Default	Backup
ECG Lead	I, II, III	II	Yes
Display Size of ECG (1)	×1, ×1/2	×1	Yes
Display Size of ECG (2)	×1, ×1/2	×1	Yes
Display Size of Respiration Waveform	×1, ×1/2	×1	Yes

- For details of the following settings, contact our service representative.

Items	Selection	Default	Backup
Time Constant	0.4 sec., 0.1 sec.	0.4 sec.	Yes
Detection Sensitivity of Pacemaker Pulse	Low, Mid, High	Mid	Yes
Respiration Detection Signal	ON, OFF	ON	Yes
LCD Contrast	8 steps	8	Yes
Transmitter Channel	One from the following channels.  9501 to 9539 9600 to 9639 9700 to 9739 9800 to 9839 9900 to 9938  2701 to 2739 2800 to 2839 2900 to 2918 2921 to 2939 3000 to 3039 3100 to 3118	9501	Yes
Group ID	One from 00 to 63	00	Yes





39-4, Hongo 3-chome, Bunkyo-ku, Tokyo, Japan  
Phone:+81-3-3815-2121 Fax:+81-3-3814-1222