

Report on the Radio Testing

For

Vicon Motion Systems Ltd

on

Vicon Pulsar Master (Beacon) Synchronization Unit

Report no. TRA-040048-45-06B

11 October 2018

RF915 6.0



Report Number: TRA-040048-45-06B
Issue: B

REPORT ON THE RADIO TESTING OF A
Vicon Motion Systems Ltd
Vicon Pulsar Master (Beacon) Synchronization Unit
WITH RESPECT TO LIMITED PARTS OF SPECIFICATION
FCC 47CFR 15.247 & IC RSS-247

TEST DATE: 3rd July to 8th August 2018

Written by: *I Broadwell*

Ian Broadwell
Radio Test Engineer

Approved by:

John Charters
Department Manager (Radio)

Date: 11 October 2018

Disclaimers:

- [1] THIS DOCUMENT MAY BE REPRODUCED ONLY IN ITS ENTIRETY AND WITHOUT CHANGE
- [2] THE RESULTS CONTAINED IN THIS DOCUMENT RELATE ONLY TO THE ITEM(S) TESTED

RF915 6.0

1 Revision Record

<i>Issue Number</i>	<i>Issue Date</i>	<i>Revision History</i>
A	30th August 2018	Original
B	11 October 2018	Model number corrected

2 Summary

TEST REPORT NUMBER: TRA-040048-45-06B

WORKS ORDER NUMBER: TRA-040048-00

PURPOSE OF TEST: USA: Testing of radio frequency equipment per the relevant authorization procedure of chapter 47 of CFR (code of federal regulations) Part 2, subpart J.

Canada: Testing of radio apparatus for TAC (technical acceptance certificate) per subsections 4(2) of the Radiocommunication Act and 21(1) of the Radiocommunication Regulations.

TEST SPECIFICATION(S): 47CFR15.247 & RSS-247

EQUIPMENT UNDER TEST (EUT): Vicon Pulsar Master (Beacon)
Synchronization Unit

FCC IDENTIFIER: DMR- VICMSU1

ISED IDENTIFIER: 11323A-VICMSU1

EUT SERIAL NUMBER: BE-A-0002

MANUFACTURER/AGENT: Vicon Motion Systems Ltd

ADDRESS: Unit 6 Oxford Industrial Park
Mead Road
Yarnton
OXFORD
OX5 1QU
United Kingdom

CLIENT CONTACT: Tom Shannon
☎ TPS01865 781398
✉ thomas.shannon@omg3d.com

ORDER NUMBER: PO: POR011981

TEST DATE: 3rd July to 8th August 2018

TESTED BY: Ian Broadwell
Element

2.1 Test Summary

Test Method and Description		Requirement Clause		Applicable to this equipment	Result / Note
		RSS	47CFR15		
Radiated spurious emissions (restricted bands of operation and cabinet radiation)		Gen, 8.10	15.205	<input checked="" type="checkbox"/>	PASS
AC power line conducted emissions		Gen, 8.8	15.207	<input checked="" type="checkbox"/>	PASS
Occupied bandwidth		247, 5.2 (1)	15.247(a)(2)	<input checked="" type="checkbox"/>	PASS
Conducted carrier power	Peak	247, 5.4 (4)	15.247(b)(3)	<input checked="" type="checkbox"/>	PASS
	Max.			<input type="checkbox"/>	
Conducted / radiated RF power out-of-band		247, 5.5	15.247(d)	<input checked="" type="checkbox"/>	PASS
Power spectral density, conducted		247, 5.2 (2)	15.247(e)	<input checked="" type="checkbox"/>	PASS
Calculation of duty correction		-	15.35(c)	<input type="checkbox"/>	N/A

Notes:

The results contained in this report relate only to the items tested, in the condition at time of test, and were obtained in the period between the date of initial receipt of samples and the date of issue of the report.

The apparatus was set up and exercised using the configurations, modes of operation and arrangements defined in this report only. Any modifications made are identified in Section 8 of this report.

Particular operating modes, apparatus monitoring methods and performance criteria required by the standards tested to have been performed except where identified in Section 5.2 of this test report (Deviations from Test Standards).

3 Contents

1	Revision Record.....	3
2	Summary.....	4
2.1	Test Summary.....	5
3	Contents.....	6
4	Introduction.....	8
5	Test Specifications.....	9
5.1	Normative References.....	9
5.2	Deviations from Test Standards.....	9
6	Glossary of Terms.....	10
7	Equipment Under Test.....	11
7.1	EUT Identification.....	11
7.2	System Equipment.....	11
7.2.1	Transmission.....	11
7.2.2	Reception.....	11
7.3	EUT Radio Parameters.....	12
7.3.1	General.....	12
7.3.2	Antennas.....	12
7.4	EUT Description.....	13
8	Modifications.....	14
9	EUT Test Setup.....	15
9.1	Block Diagram.....	15
9.2	General Set-up Photograph.....	16
10	General Technical Parameters.....	17
10.1	Normal Conditions.....	17
10.2	Varying Test Conditions.....	17
11	Radiated emissions.....	18
11.1	Definitions.....	18
11.2	Test Parameters.....	18
11.3	Test Limit.....	18
11.4	Test Method.....	20
11.5	Test Set-up Photograph.....	21
11.6	Test Equipment.....	22
11.7	Test Results.....	23
12	AC power-line conducted emissions.....	32
12.1	Definition.....	32
12.2	Test Parameters.....	32
12.3	Test Limit.....	32
12.4	Test Method.....	32
12.5	Test Set-up Photograph.....	33
12.6	Test Equipment.....	33
12.7	Test Results.....	35
13	Occupied Bandwidth.....	36
13.1	Definition.....	36
13.2	Test Parameters.....	36
13.3	Test Limit.....	36
13.4	Test Method.....	36
13.5	Test Equipment.....	37
13.6	Test Results.....	37
14	Maximum peak conducted output power.....	41
14.1	Definition.....	41
14.2	Test Parameters.....	41
14.3	Test Limit.....	41
14.4	Test Method.....	41
14.5	Test Equipment.....	42
14.6	Test Results.....	42
15	Out-of-band and conducted spurious emissions.....	44
15.1	Definition.....	44
15.2	Test Parameters.....	44
15.3	Test Limit.....	44
15.4	Test Method.....	45
15.5	Test Equipment.....	45
15.6	Test Results.....	46
16	Power spectral density.....	48

16.1	Definition	48
16.2	Test Parameters.....	48
16.3	Test Limit	48
16.4	Test Method	48
16.5	Test Equipment.....	48
16.6	Test Results	49
17	Measurement Uncertainty.....	51
18	RF Exposure	52

4 Introduction

This report TRA-040048-45-06B presents the results of the Radio testing on a Vicon Motion Systems Ltd, Vicon Pulsar Master (Beacon) Synchronization Unit to specification 47CFR15 Radio Frequency Devices and RSS-247 Licence-exempt Radio Apparatus (All Frequency Bands): Category I Equipment.

The testing was carried out for Vicon Motion Systems Ltd by Element, at the address detailed below.

<input checked="" type="checkbox"/>	Element Hull Unit E South Orbital Trading Park Hedon Road Hull HU9 1NJ UK	<input type="checkbox"/>	Element Skelmersdale Unit 1 Pendle Place Skemersdale West Lancashire WN8 9PN UK
-------------------------------------	---	--------------------------	---

This report details the configuration of the equipment, the test methods used and any relevant modifications where appropriate.

All test and measurement equipment under the control of the laboratory and requiring calibration is subject to an established programme and procedures to control and maintain measurement standards. The quality management system meets the principles of ISO 9001, and has quality control procedures for monitoring the validity of tests undertaken. Records and sufficient detail are retained to establish an audit trail of calibration records relating to its test results for a defined period. Under control of the established calibration programme, key quantities or values of the test & measurement instrumentation are within specification and comply with the relevant traceable internationally recognised and appropriate standard specifications, which are UKAS calibrated as such where these properties have a significant effect on results. Participation in inter-laboratory comparisons and proficiency testing ensures satisfactory correlation of results conform to Elements own procedures, as well as statistical techniques for analysis of test data providing the appropriate confidence in measurements.

Throughout this report EUT denotes equipment under test.

FCC Site Listing:

Element is accredited for the above sites under the US-EU MRA, Designation number UK0009.

IC Registration Number(s):

Element Hull 3483A

Element North West 3930B

The test site requirements of ANSI C63.4-2014 are met up to 1GHz.

The test site SVSWR requirements of CISPR 16-1-4:2010 are met over the frequency range 1 GHz to 18 GHz.

5 Test Specifications

5.1 Normative References

- FCC 47 CFR Ch. I – Part 15 – Radio Frequency Devices.
- ANSI C63.10-2013 – American National Standard of Procedures for Compliance Testing of Unlicensed Wireless Devices.
- ANSI C63.4-2014 – American National Standard for Methods of Measurement of Radio-Noise Emissions from Low-Voltage Electrical and Electronic Equipment in the Range of 9 kHz to 40 GHz.
- Industry Canada RSS-247, Issue 2, February 2017 – Digital Transmission Systems (DTSs), Frequency Hopping Systems (FHSs) and Licence-Exempt Local Area Network (LE-LAN) Devices
- Industry Canada RSS-Gen, Issue 4, November 2014 – General Requirements for Compliance of Radio Apparatus

5.2 Deviations from Test Standards

There were no deviations from the test standard.

6 Glossary of Terms

§	denotes a section reference from the standard, not this document
AC	Alternating Current
ANSI	American National Standards Institute
BW	bandwidth
C	Celsius
CFR	Code of Federal Regulations
CW	Continuous Wave
dB	decibel
dBm	dB relative to 1 milliwatt
DC	Direct Current
DSSS	Direct Sequence Spread Spectrum
EIRP	Equivalent Isotropically Radiated Power
ERP	Effective Radiated Power
EUT	Equipment Under Test
FCC	Federal Communications Commission
FHSS	Frequency Hopping Spread Spectrum
Hz	hertz
IC	Industry Canada
ITU	International Telecommunication Union
LBT	Listen Before Talk
m	metre
max	maximum
MIMO	Multiple Input and Multiple Output
min	minimum
MRA	Mutual Recognition Agreement
N/A	Not Applicable
PCB	Printed Circuit Board
PDF	Portable Document Format
Pt-mpt	Point-to-multipoint
Pt-pt	Point-to-point
RF	Radio Frequency
RH	Relative Humidity
RMS	Root Mean Square
Rx	receiver
s	second
SVSWR	Site Voltage Standing Wave Ratio
Tx	transmitter
UKAS	United Kingdom Accreditation Service
V	volt
W	watt
Ω	ohm

7 Equipment Under Test

7.1 EUT Identification

- Name: Vicon Pulsar Master (Beacon) Synchronization Unit
- Serial Number: BE-A-0002
- Model Number: MUS1
- Software Revision: V1.0
- Build Level / Revision Number: Pre-production prototypes

7.2 System Equipment

Equipment listed below forms part of the overall test setup and is required for equipment functionality and/or monitoring during testing. The compliance levels achieved in this report relate only to the EUT and not items given in the following list.

- *Power supply* LEVEL ONE GEP-1622, 16 Port POE Network Hub: *TRA-040048-S20*
- *Laptop computer* DELL Latitude 7204: *TRA-040048-S9*

.EUT Mode of Operation

7.2.1 Transmission

The mode of operation for transmit tests was as follows...

The EUT was put in transmit mode using the same procedure outlined in the receive section below.

7.2.2 Reception

Receive mode Part 15 b testing is covered by test report TRA-040048-36-00A.

7.3 EUT Radio Parameters

7.3.1 General

Frequency of operation:	2405 MHz – 2480 MHz
Modulation type(s):	O-QPSK
Occupied channel bandwidth(s):	1 MHz
Channel spacing:	2 MHz
Declared output power(s):	3.16 mW
Nominal Supply Voltage:	44-57 Vdc via PoE
Location of notice for license exempt use:	Label / user manual / both.
Duty cycle:	25%

7.3.2 Antennas

Type:	External
Frequency range:	2405 MHz – 2480 MHz
Impedance:	50 Ohm
Part No	Pulse Electronics W1030
Gain:	2.0 dBi
Connector type:	SMA

7.4 EUT Description

The device is designed to synchronise LED Clusters via 802.15.4. A cluster is a small body-worn active LED cluster designed to provide a unique three dimensional estimate of the location in space of a body segment when viewed by multiple video cameras.

8 Modifications

No modification we included during the testing.

9 EUT Test Setup

9.1 Block Diagram

The following diagram shows basic EUT interconnections with cable type and cable lengths identified:

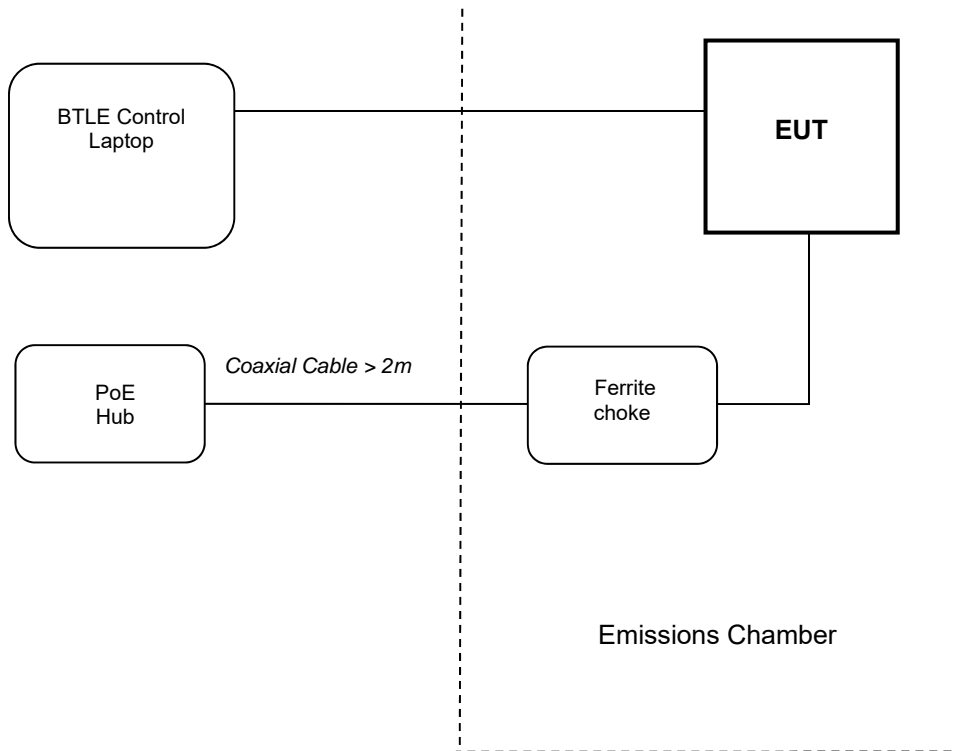

9.2 General Set-up Photograph

The following photograph shows basic EUT set-up:



10 General Technical Parameters

10.1 Normal Conditions

The E U T was tested under the normal environmental conditions of the test laboratory, except where otherwise stated. The normal power source applied was approx. 48 V fromt eh power over either net hub

10.2 Varying Test Conditions

There are no specific frequency stability requirements for the type of device. The results contained in this report demonstrate that the occupied bandwidth is contained within the authorised band and the manufacturer has declared sufficient frequency stability (refer to section 7.4).

Variation of supply voltage is required to ensure stability of the declared output power. During carrier power testing the following variations were made:

	Category	Nominal	Variation
<input type="checkbox"/>	Mains	110 V ac +/-2 %	85 % and 115 %
<input type="checkbox"/>	Battery	New battery	N/A
<input type="checkbox"/>	PoE	48V	N/A

11 Radiated emissions

11.1 Definitions

Out-of-band emissions

Emissions on a frequency or frequencies immediately outside the necessary bandwidth which result from the modulation process, but exclude spurious emissions.

Spurious emissions

Emissions on a frequency or frequencies which are outside the necessary bandwidth and the level of which may be reduced without affecting the corresponding transmission of information. Spurious emissions include harmonic emissions, parasitic emissions, intermodulation products and frequency conversion products, but exclude out-of-band emissions.

Restricted bands

A frequency band in which intentional radiators are permitted to radiate only spurious emissions but not fundamental signals.

11.2 Test Parameters

Test Location:	Element Hull
Test Chamber:	Wireless Lab 2
Test Standard and Clause:	ANSI C63.10-2013, Clause 6.5 and 6.6
EUT Channels / Frequencies Measured:	Low / Mid / High – 2405, 2440, 2480 MHz
EUT Channel Bandwidths:	2 MHz
Deviations From Standard:	None
Measurement BW:	30 MHz to 1 GHz: 120 kHz Above 1 GHz: 1 MHz
Measurement Detector:	Up to 1 GHz: quasi-peak Above 1 GHz: RMS average and Peak

Environmental Conditions (Normal Environment)

Temperature: 22 °C	+15 °C to +35 °C (as declared)
Humidity: 50 % RH	20 % RH to 75 % RH (as declared)
Supply: PoE	PoE

11.3 Test Limit

Except for harmonics, out-of-band emissions shall be attenuated by at least 50 dB below the level of the fundamental or to the general field strength limits listed in FCC 47CFR15.209 / RSS-Gen {see table below}, whichever is less stringent.

Harmonics shall be limited to a maximum level of 0.5 mV/m measured at 3 metres.

General Field Strength Limits for License-Exempt Transmitters at Frequencies above 30 MHz

<i>Frequency (MHz)</i>	<i>Field Strength ($\mu\text{V}/\text{m}$ at 3 m)</i>
30 to 88	100
88 to 216	150
216 to 960	200
Above 960	500

n.b. per FCC 47CFR15.35(b) / RSS-Gen 8.1, peak limit is 20 dB above average.

11.4 Test Method

With the EUT setup as per section 9 of this report and connected as per Figure i, the emissions from the EUT were measured on a spectrum analyzer / EMI receiver.

Radiated electromagnetic emissions from the EUT are checked first by preview scans. Preview scans for all spectrum and modulation characteristics are checked, using a peak detector and where applicable worst-case determined for function, operation, orientation, etc. for both vertical and horizontal polarisations. Pre-scan plots are shown with a peak detector and 100 kHz RBW.

If the EUT connects to auxiliary equipment and is table or floor standing, the configurations prescribed in ANSI C63.10 are followed. Alternatively, a layout closest to normal use (as declared by the provider) is employed, (see EUT setup photographs for more detail).

Emissions between 30 MHz and 1 GHz are measured using calibrated broadband antennas. Emissions above 1 GHz are characterized using standard gain horn antennas. Pre-amplifiers and filters are used where required. Care is taken to ensure that test receiver resolution bandwidth, video bandwidth and detector type(s) meet the regulatory requirements.

For both horizontal and vertical polarizations, the EUT is then rotated through 360 degrees in azimuth until the highest emission is detected. At the previously determined azimuth the test antenna is raised and lowered from 1 to 4 m in height until a maximum emission level is detected, this maximum value is recorded.

Power values measured on the test receiver / analyzer are converted to field strength, FS, in dB μ V/m at the regulatory distance, using:

$$FS = PR + CL + AF - PA + DC - CF$$

Where,

PR is the power recorded on the receiver / spectrum analyzer in dB μ V;

CL is the cable loss in dB;

AF is the test antenna factor in dB/m;

PA is the pre-amplifier gain in dB (where used);

DC is the duty correction factor in dB (where used, e.g. harmonics of pulsed fundamental);

CF is the distance factor in dB (where measurement distance different to limit distance);

This field strength value is then compared with the regulatory limit.

Figure i Test Setup

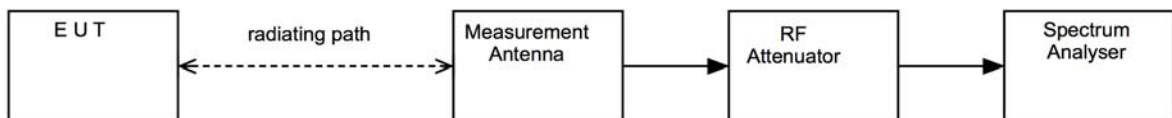

11.5 Test Set-up Photograph

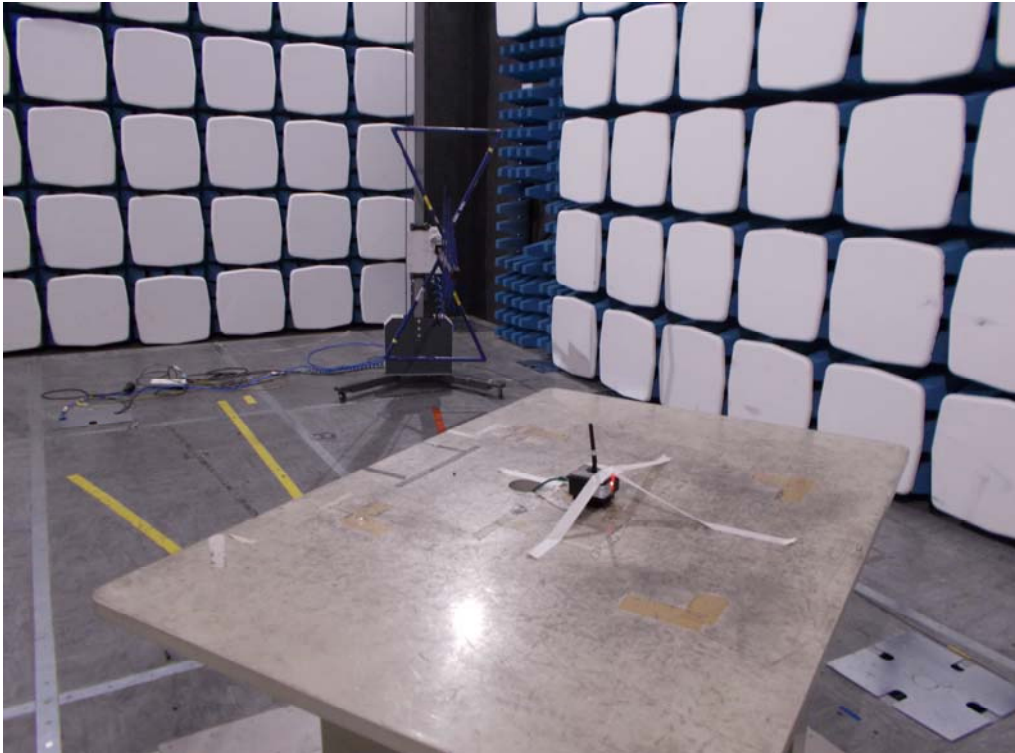

11.6 Test Equipment

Equipment		Equipment	Element	Due For
Type	Manufacturer	Description	No	Calibration
Pre-Amp (9kHz – 1GHz)	Sonoma	310	REF927	2019-05-22
Spectrum Analyser	R&S	FSU46	U281	2018-07-19
Bilog Antenna	Chase	CBL6111B	REF2218	2019-11-06
Ferrite Lined Chamber	Rainford	ATS	REF886	2019-07-24
Pre-Amp (1 – 26.5GHz)	Agilent	8449B	REF913	2019-02-07
Horn Antenna	EMCO	3115	RFG129	2020-02-12
Horn Antenna	Q-par	QSH20S20S	RFG629	2019-09-26

11.7 Test Results

High Power; Channel: 11, 2405 MHz										
Detector	Freq. (MHz)	Meas'd Emission (dBμV)	Cable Loss (dB)	Antenna Factor (dB/m)	Pre-amp Gain (dB)	Duty Cycle Corr'n (dB)	Distance Extrap'n Factor (dB)	Field Strength (dBμV/m)	Field Strength (μV/m)	Limit (μV/m)
There were no emissions within 10 dB of the restricted band QP limit as specified in 15.205.										

30 MHz – 1 GHz pre-scan plot with fundamental at 2405 MHz and 5dBm output power

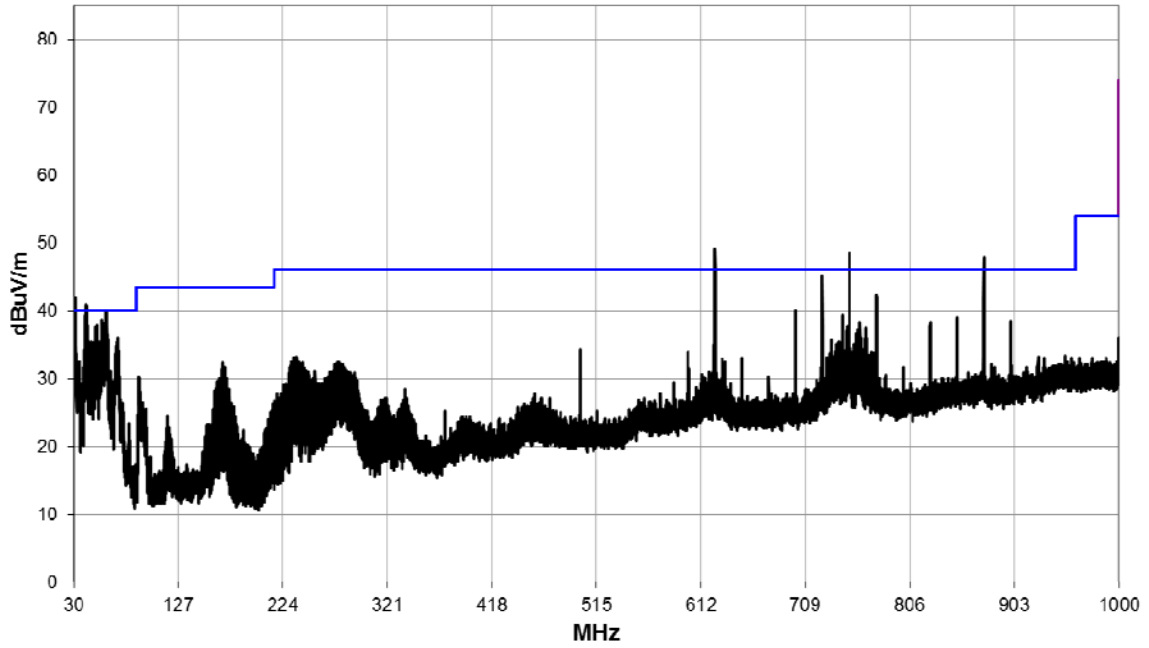

1 – 8.2 GHz pre-scan plot with fundamental at 2405 MHz and 5dBm output power

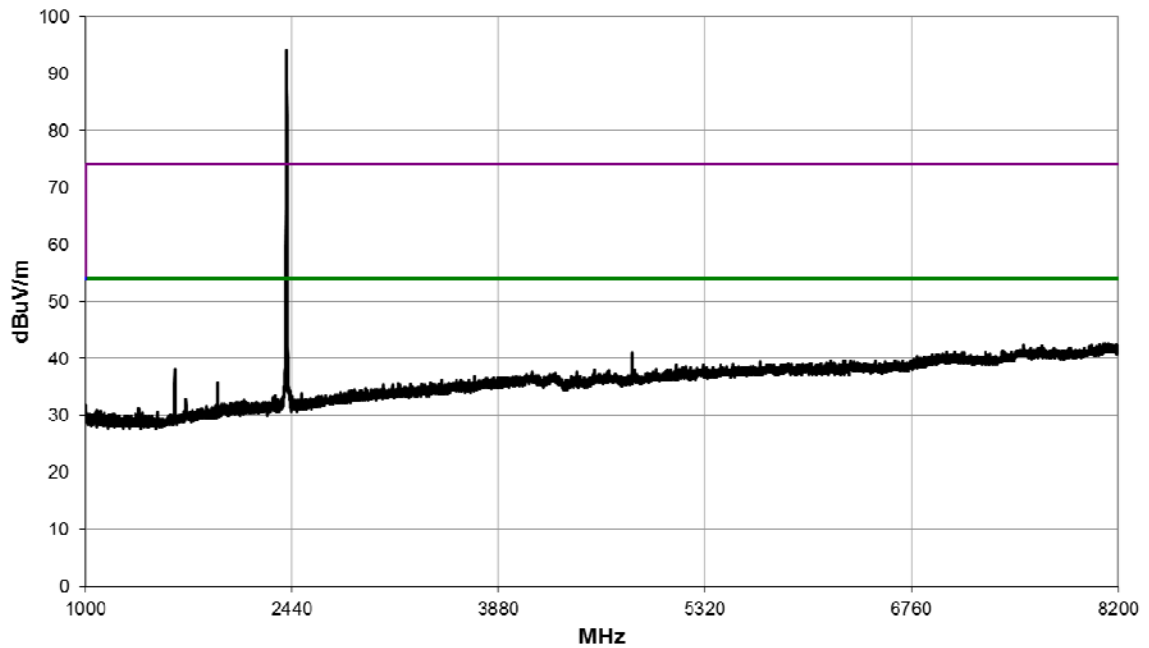

8.2 – 12.4 GHz pre-scan plot with fundamental at 2405 MHz and 5dBm output power

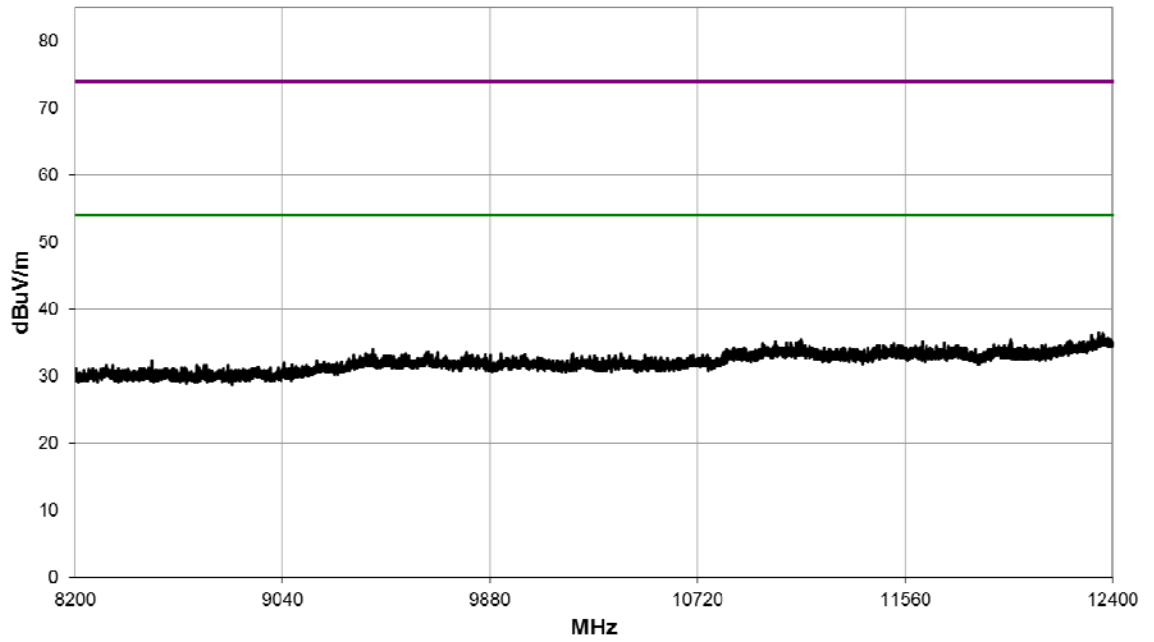

12.4 – 18 GHz pre-scan plot with fundamental at 2405 MHz and 5dBm output power

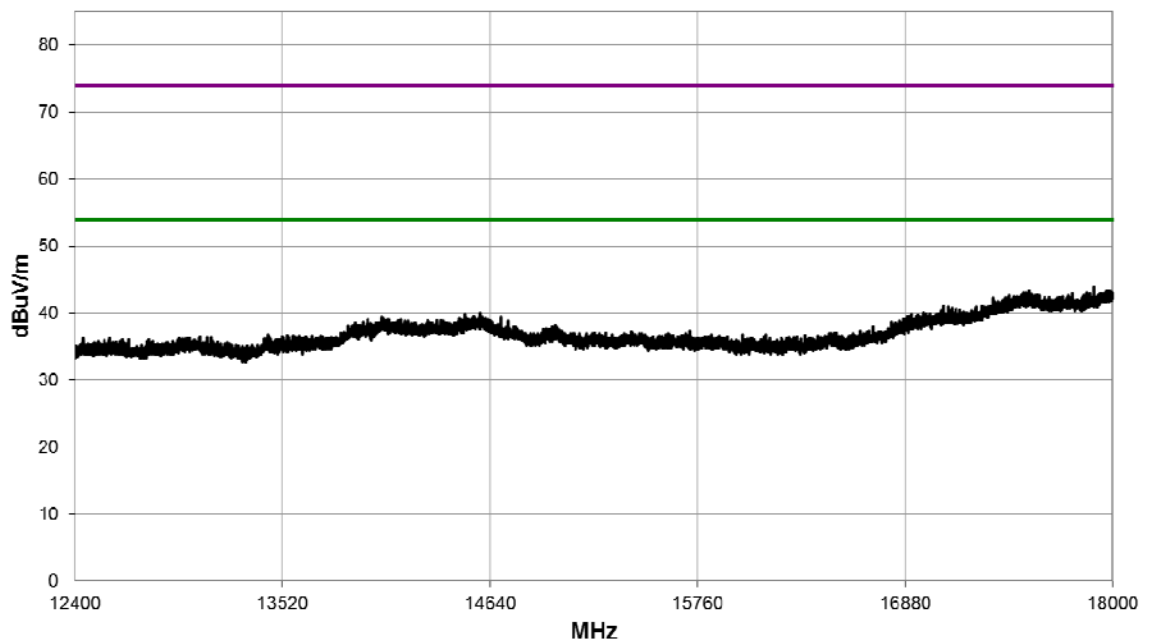

18 – 25 GHz pre-scan plot with fundamental at 2405 MHz and 5dBm output power

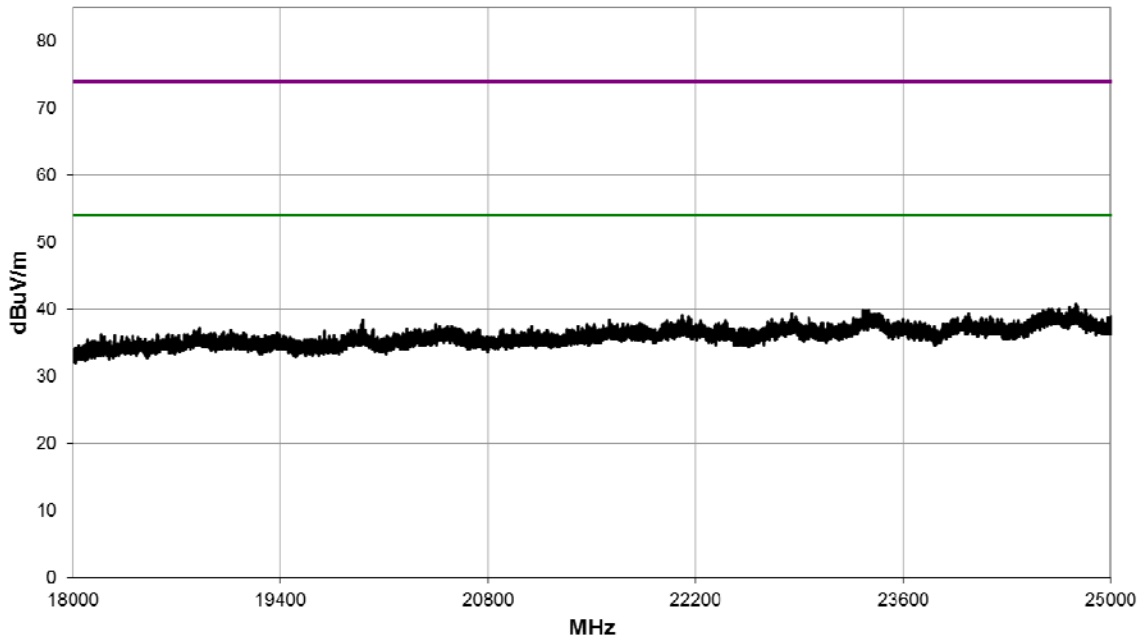

Lower band edge plot

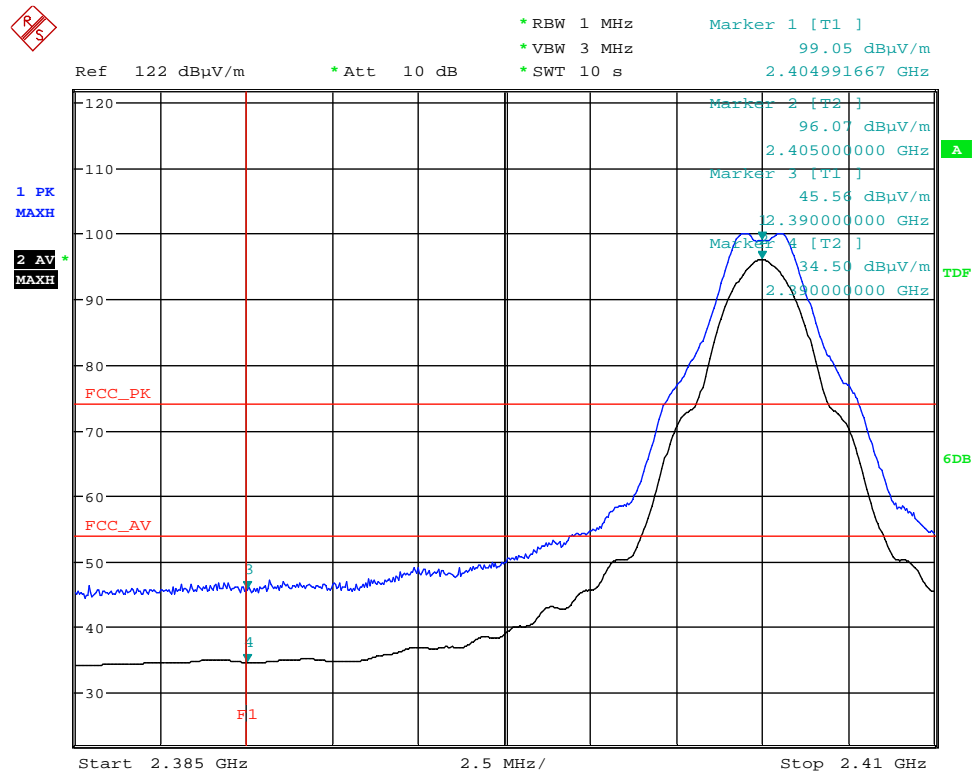

Date: 11.JUL.2018 12:55:06

High Power; Channel: 18, 2440 MHz										
Detector	Freq. (MHz)	Meas'd Emission (dBμV)	Cable Loss (dB)	Antenna Factor (dB/m)	Pre-amp Gain (dB)	Duty Cycle Corr'n (dB)	Distance Extrap'n Factor (dB)	Field Strength (dBμV/m)	Field Strength (μV/m)	Limit (μV/m)
There were no emissions within 10 dB of the restricted band QP limit as specified in 15.205.										

30 MHz – 1 GHz pre-scan plot with fundamental at 2440 MHz and 5dBm output power

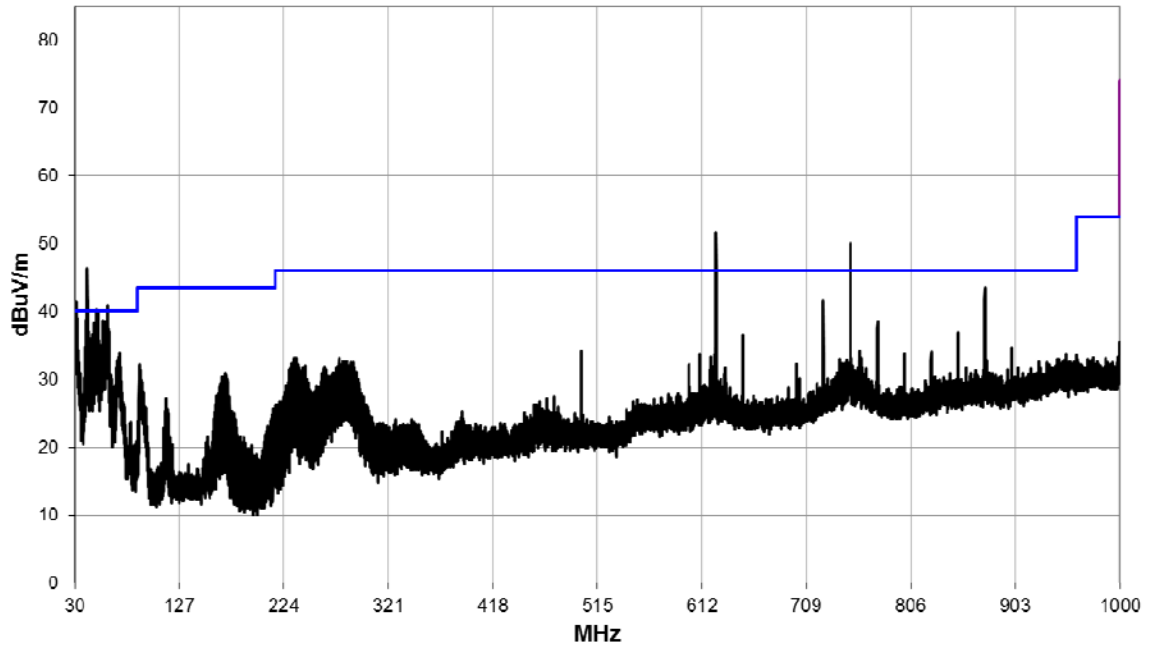

1 – 8.2 GHz pre-scan plot with fundamental at 2440 MHz and 5dBm output power

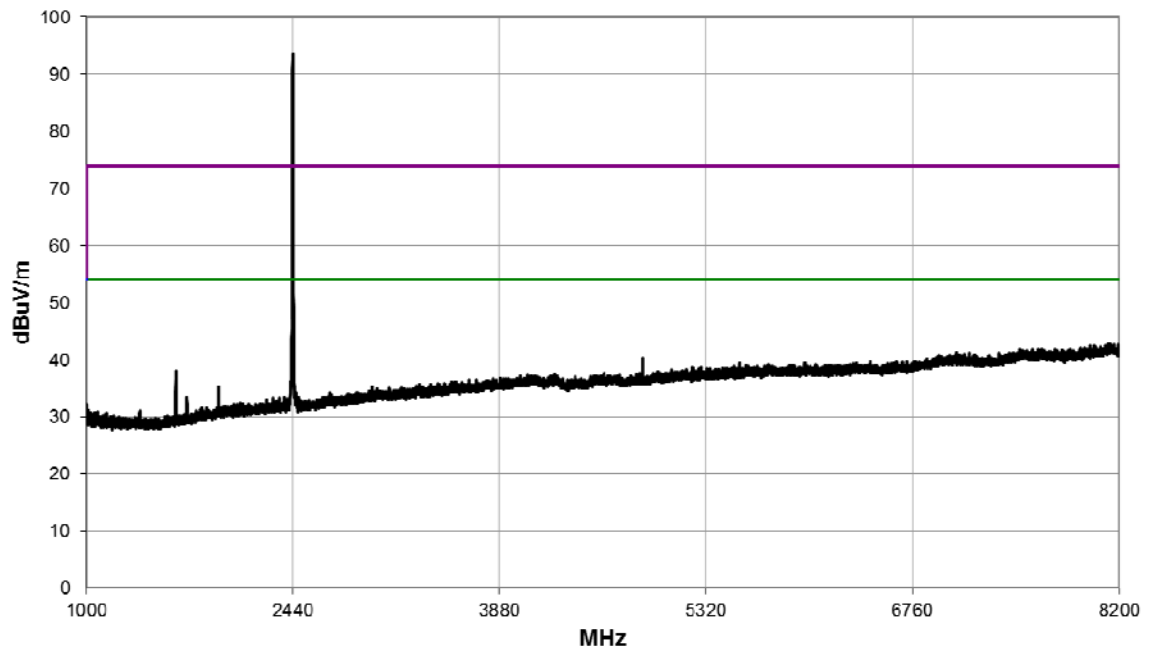

8.2 – 12.4 GHz pre-scan plot with fundamental at 2440 MHz and 5dBm output power

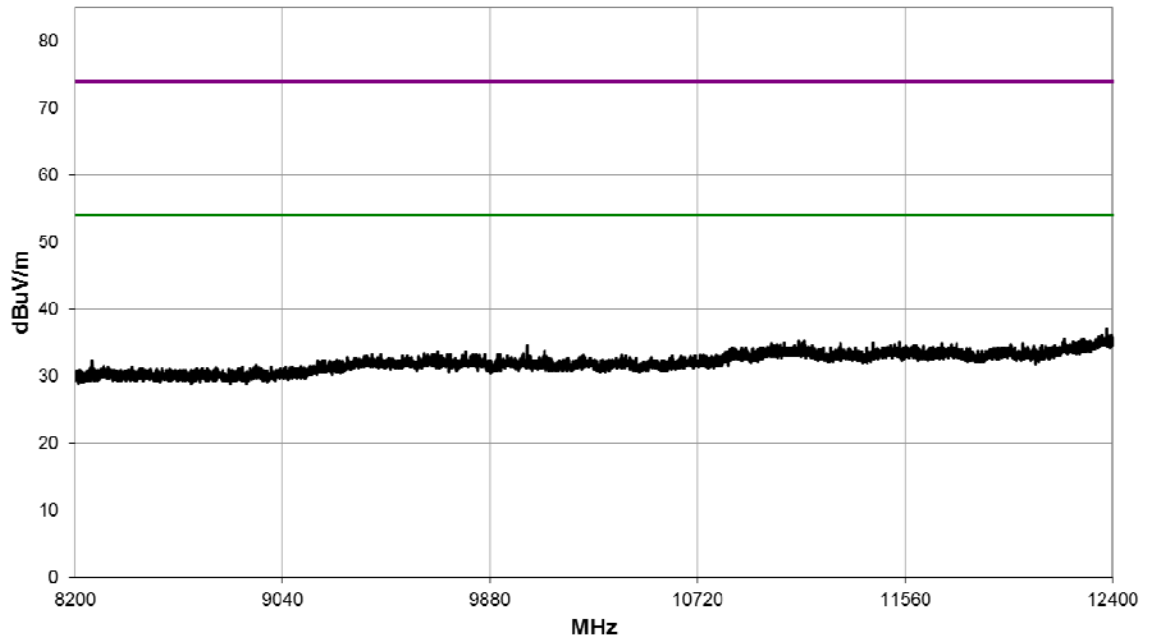

12.4 – 18 GHz pre-scan plot with fundamental at 2440 MHz and 5dBm output power

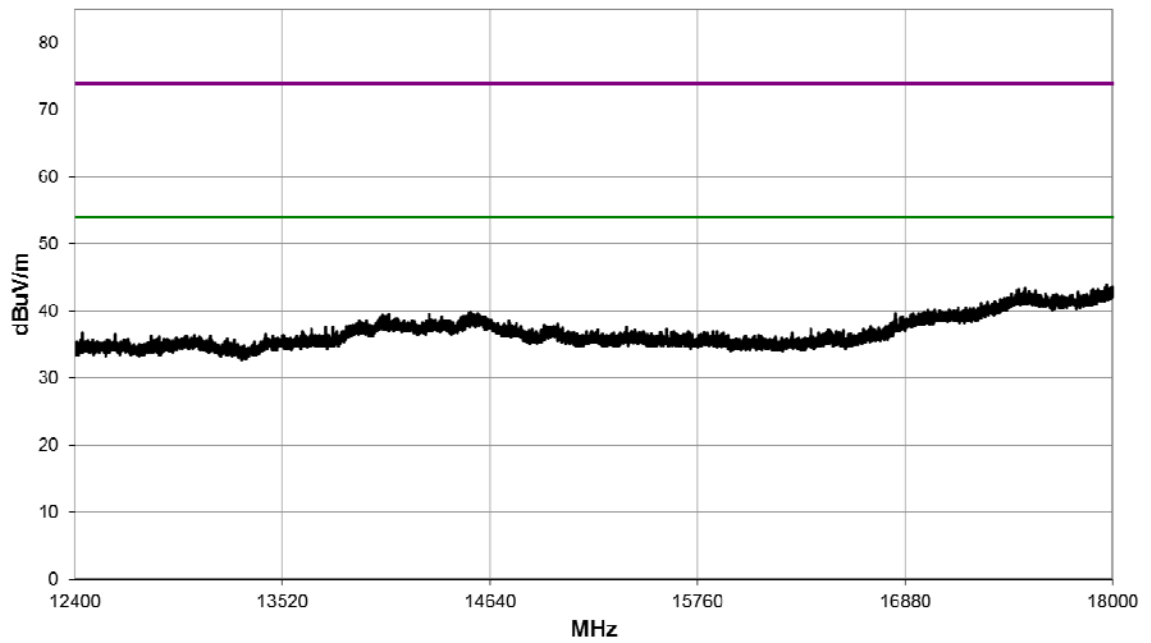

18 – 25 GHz pre-scan plot with fundamental at 2440 MHz and 5dBm output power

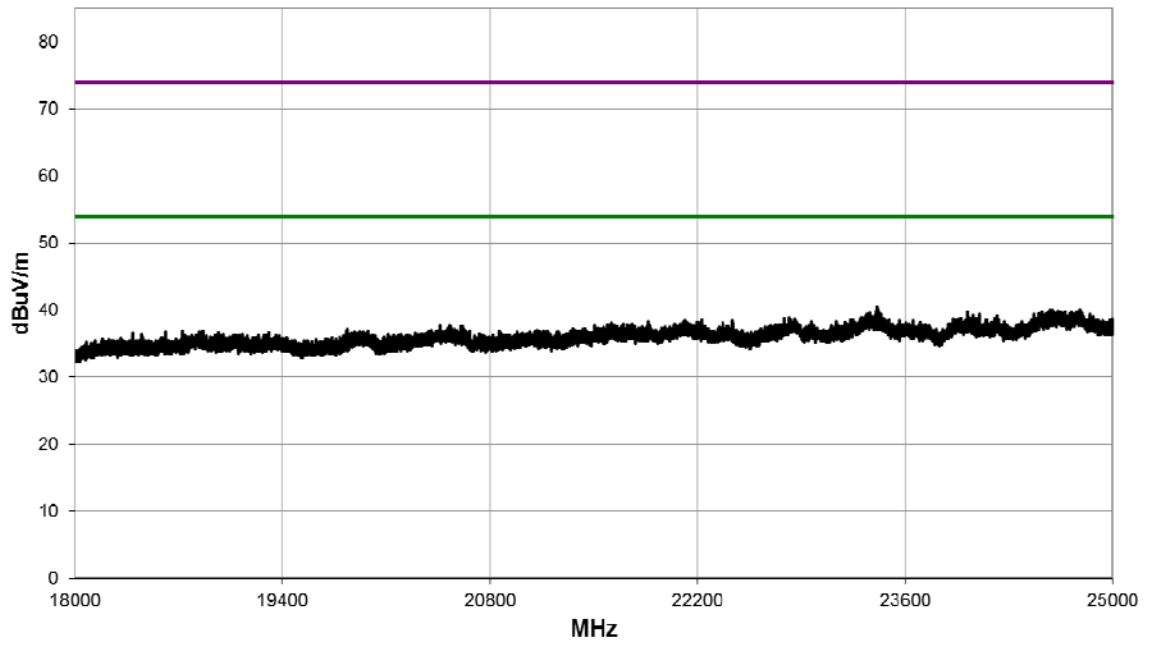

High Power; Channel: 26, 2480 MHz										
Detector	Freq. (MHz)	Meas'd Emission (dBμV)	Cable Loss (dB)	Antenna Factor (dB/m)	Pre-amp Gain (dB)	Duty Cycle Corr'n (dB)	Distance Extrap'n Factor (dB)	Field Strength (dBμV/m)	Field Strength (μV/m)	Limit (μV/m)
There were no emissions within 10 dB of the restricted band QP limit as specified in 15.205.										

30 MHz – 1 GHz pre-scan plot with fundamental at 2480 MHz and 5dBm output power

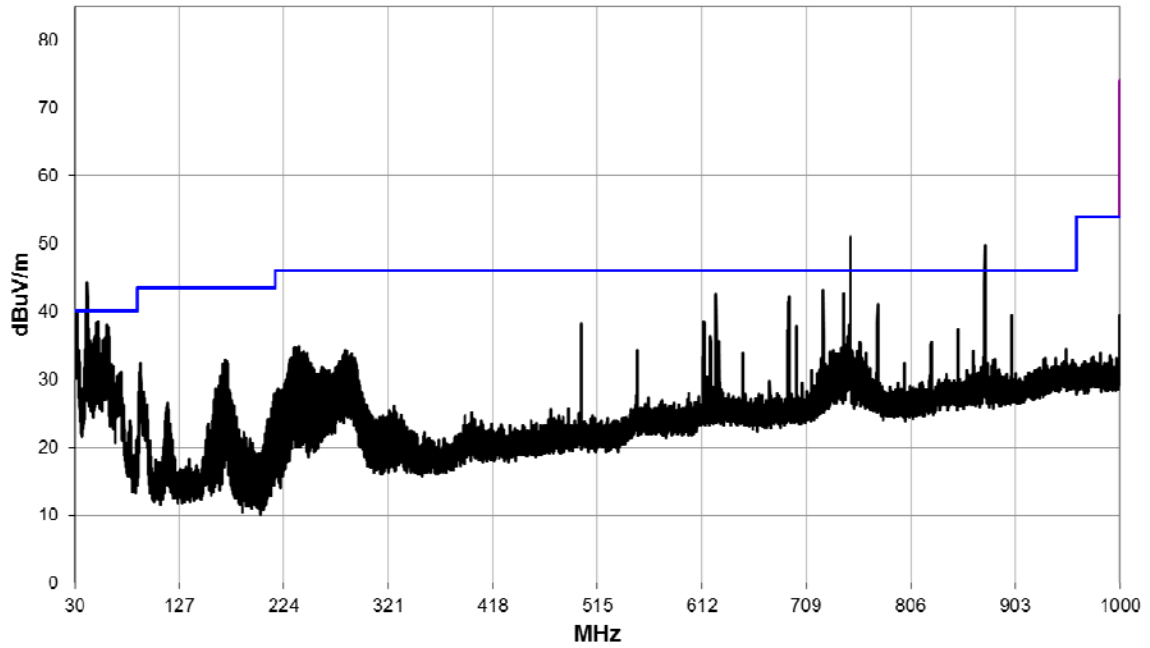

1 – 8.2 GHz pre-scan plot with fundamental at 2480 MHz and 5dBm output power

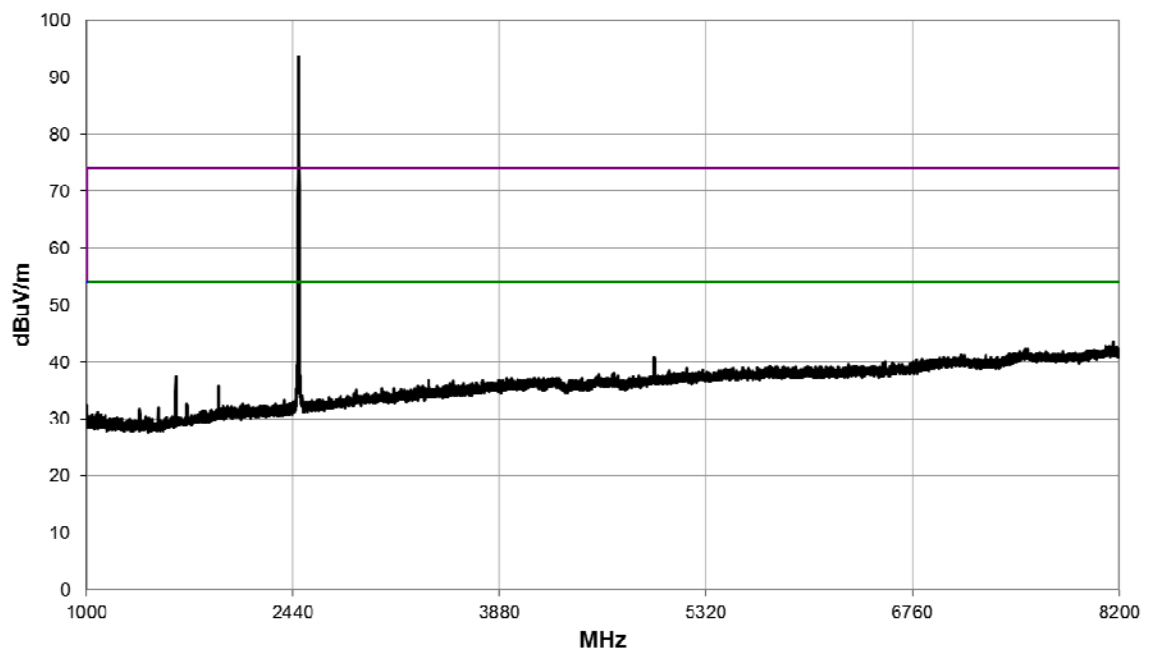

8.2 – 12.4 GHz pre-scan plot with fundamental at 2480 MHz and 5dBm output power

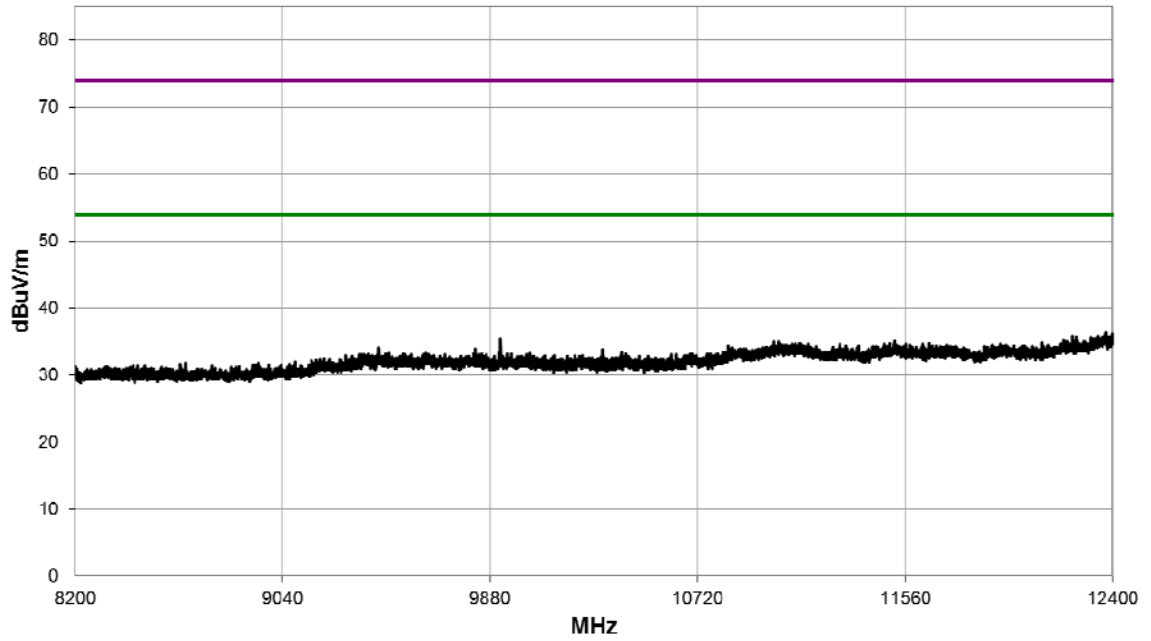

12.4 – 18 GHz pre-scan plot with fundamental at 2480 MHz and 5dBm output power

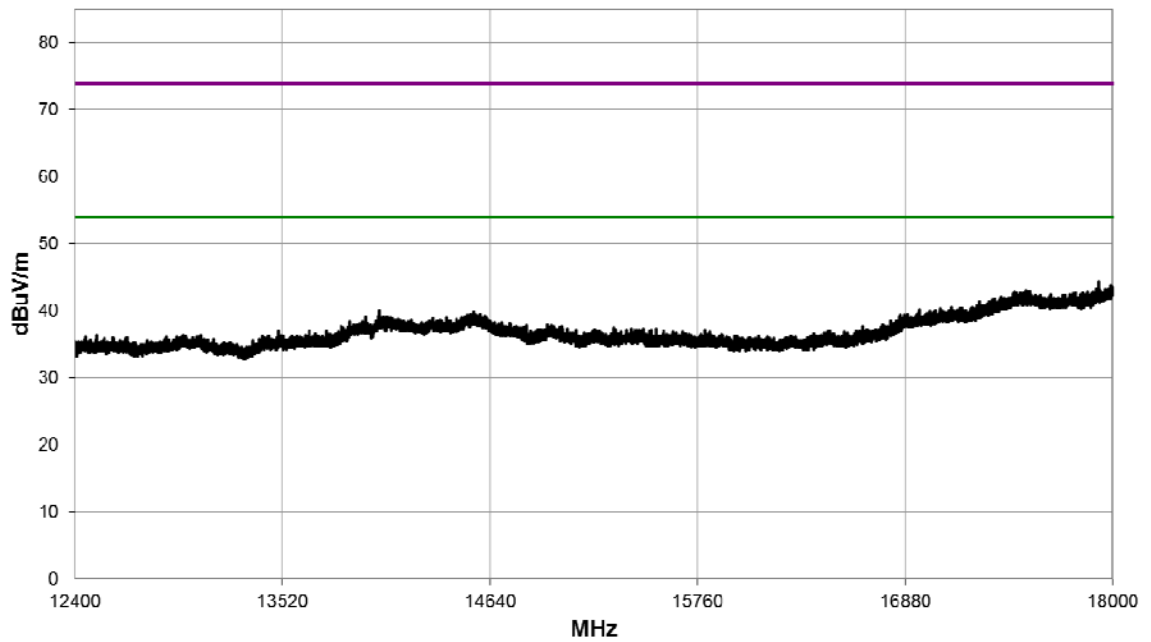

18 – 25 GHz pre-scan plot with fundamental at 2480 MHz and 5dBm output power

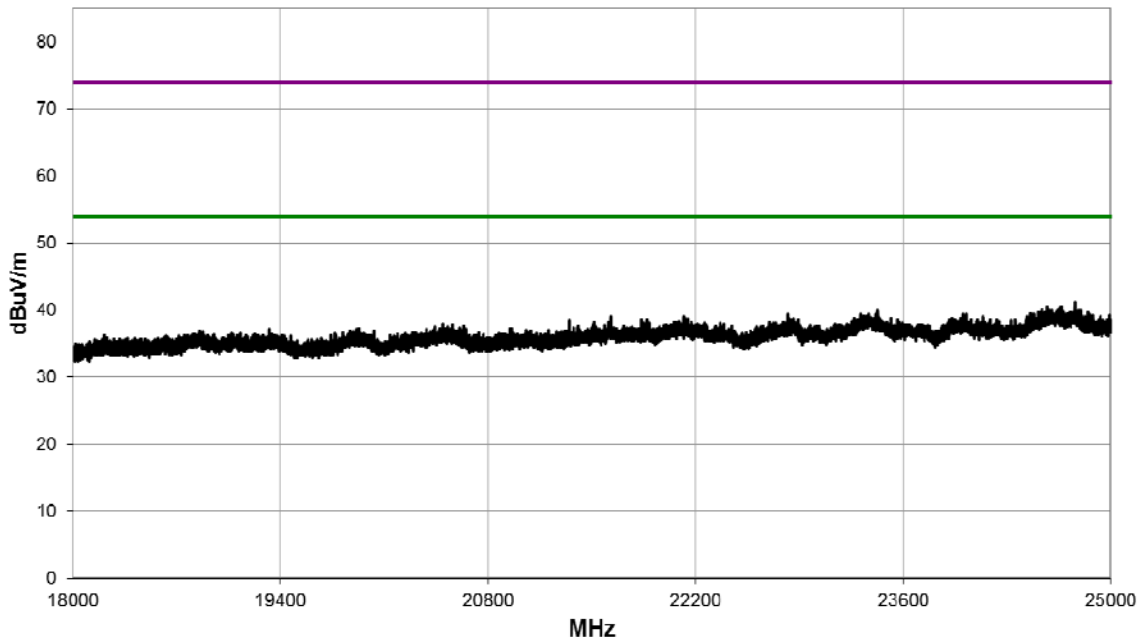

Plot for the upper band edge

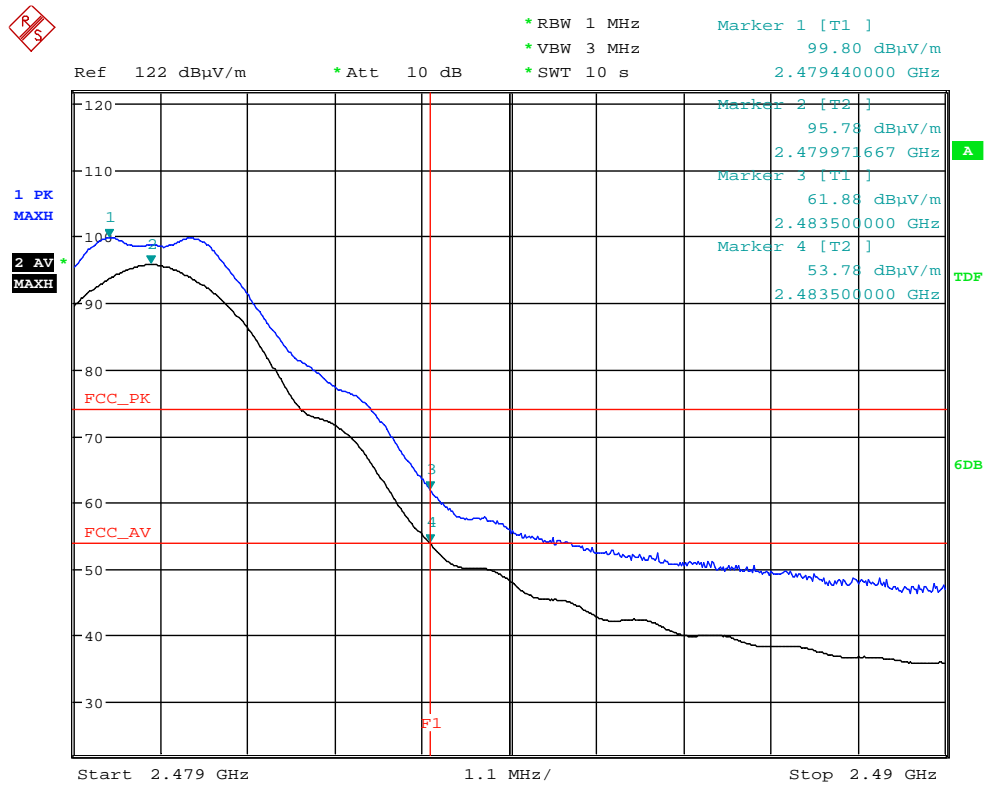

Date: 11.JUL.2018 13:17:00

12 AC power-line conducted emissions

12.1 Definition

Line-to-ground radio-noise voltage that is conducted from all of the EUT current-carrying power input terminals that are directly (or indirectly via separate transformers or power supplies) connected to a public power network.

12.2 Test Parameters

Test Location:	Element Hull
Test Chamber:	Screen Room 2
Test Standard and Clause:	ANSI C63.10-2013, Clause 6.2
EUT Frequency Measured:	2480 MHz
Deviations From Standard:	None
Measurement Detectors:	Quasi-Peak and Average

Environmental Conditions (Normal Environment)

Temperature: 22 °C	+15 °C to +35 °C (as declared)
Humidity: 43 % RH	20 % RH to 75 % RH (as declared)
Supply: 120 Vac	120 V ac \pm 10 % (as declared)

12.3 Test Limit

A radio apparatus that is designed to be connected to the public utility (AC) power line shall ensure that the radio frequency voltage, which is conducted back onto the AC power line on any frequency or frequencies within the band 150 kHz to 30 MHz, shall not exceed the limits in Table 3.

Table 3 – AC Power Line Conducted Emission Limits

Frequency (MHz)	Conducted limit (dB μ V)	
	Quasi-Peak	Average**
0.15 to 0.5	66 to 56*	56 to 46*
0.5 to 5	56	46
5 to 30	60	50

*The level decreases linearly with the logarithm of the frequency.

**A linear average detector is required.

12.4 Test Method

With the EUT setup in a screened room, and connected as per Figure ii, the power line emissions were measured on a spectrum analyzer / EMI receiver.

AC power line conducted emissions from the EUT are checked first by preview scans with peak and average detectors covering both live and neutral lines. A spectrum analyzer is used to determine if any periodic emissions are present.

Formal measurements using the correct detectors and bandwidth are made on frequencies identified from the preview scans. Final measurements were performed with EUT set at its maximum duty in transmit and receive modes.

Figure ii Test Setup

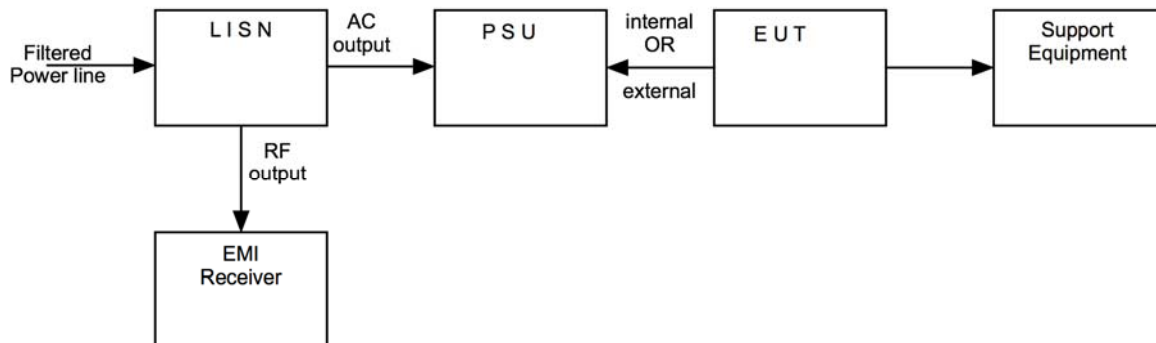

12.5 Test Set-up Photograph



12.6 Test Equipment

<i>Equipment Description</i>	<i>Manufacturer</i>	<i>Equipment Type</i>	<i>Element No</i>	<i>Due For Calibration</i>
ESCI7	R&S	Measuring Receiver	RFG715	2018-11-03
ESH3-Z5	R&S	LISN	RFG732	2019-05-22

12.7 Test Results

Frequency (MHz)	Quasi-Peak (dBµV)	Meas. Time (ms)	Bandwidth (kHz)	PE	Line	Corr. (dB)	Margin (dB)	Limit (dBµV)
0.151750	27.2	15000.0	9.000	GND	N	10.1	38.7	65.9
0.289725	34.7	15000.0	9.000	GND	L1	10.1	25.9	60.5
0.342250	38.0	15000.0	9.000	GND	N	10.1	21.2	59.1
0.350350	45.2	15000.0	9.000	GND	N	10.1	13.8	59.0
0.355450	36.1	15000.0	9.000	GND	N	10.1	22.8	58.8
0.580725	35.1	15000.0	9.000	GND	N	10.1	20.9	56.0
0.668025	39.4	15000.0	9.000	GND	N	10.1	16.6	56.0
1.131200	30.3	15000.0	9.000	GND	N	10.2	25.7	56.0
4.310375	17.6	15000.0	9.000	GND	N	10.4	38.4	56.0
26.539000	25.8	15000.0	9.000	GND	L1	11.7	34.2	60.0

Frequency (MHz)	Average (dBµV)	Meas. Time (ms)	Bandwidth (kHz)	PE	Line	Corr. (dB)	Margin (dB)	Limit (dBµV)
0.151750	23.3	15000.0	9.000	GND	N	10.1	32.6	55.9
0.289725	34.3	15000.0	9.000	GND	L1	10.1	16.2	50.5
0.342250	33.6	15000.0	9.000	GND	N	10.1	15.5	49.1
0.350350	44.8	15000.0	9.000	GND	N	10.1	4.2	49.0
0.355450	32.7	15000.0	9.000	GND	N	10.1	16.2	48.8
0.580725	35.0	15000.0	9.000	GND	N	10.1	11.0	46.0
0.668025	39.3	15000.0	9.000	GND	N	10.1	6.7	46.0
1.131200	28.6	15000.0	9.000	GND	N	10.2	17.4	46.0
4.310375	9.2	15000.0	9.000	GND	N	10.4	36.8	46.0
26.539000	19.2	15000.0	9.000	GND	L1	11.7	30.8	50.0

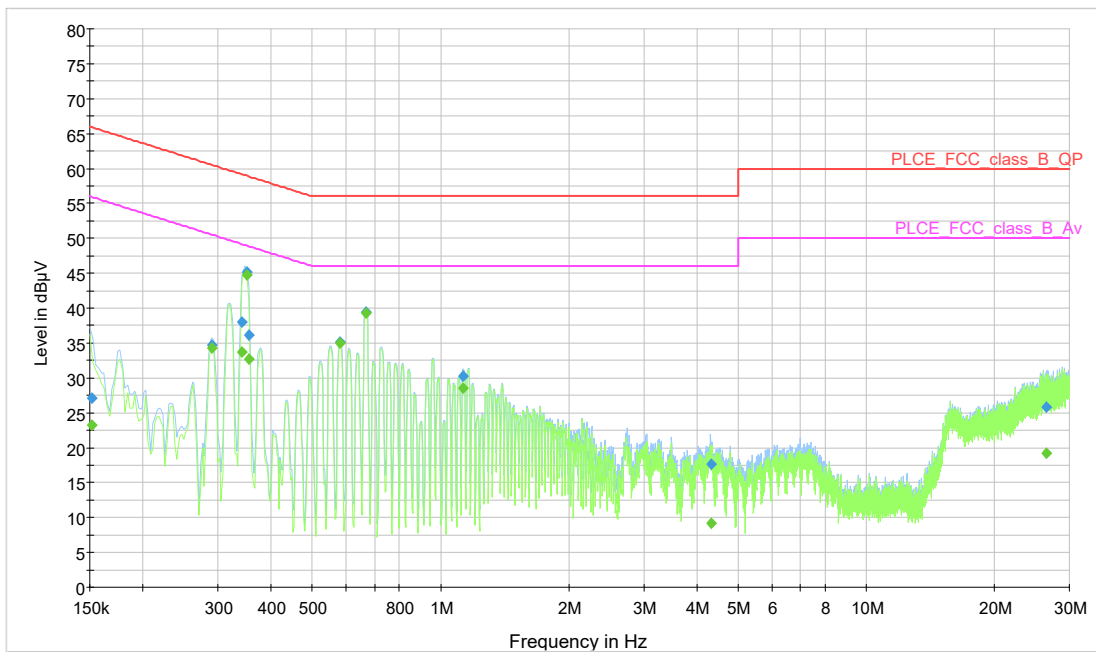

13 Occupied Bandwidth

13.1 Definition

The emission bandwidth (x dB) is defined as the frequency range between two points, one above and one below the carrier frequency, at which the spectral density of the emission is attenuated x dB below the maximum in-band spectral density of the modulated signal.

The 99% emission bandwidth is defined as the frequency range between two points, one above and the other below the carrier frequency, within which 99% of the total transmitted power of the fundamental transmitted emission is contained.

13.2 Test Parameters

Test Location:	Element Hull
Test Chamber:	Wireless Lab 1
Test Standard and Clauses:	6 dB Bandwidth: ANSI C63.10-2013, Clause 11.8 99% Bandwidth: ANSI C63.10-2013, Clause 6.9
EUT Frequencies Measured:	2405 MHz, 2440 MHz & 2480 MHz
Deviations From Standard:	None
Measurement Detector:	Peak

Environmental Conditions (Normal Environment)

Temperature: 23 °C	+15 °C to +35 °C (as declared)
Humidity: 45 % RH	20 % RH to 75 % RH (as declared)

13.3 Test Limit

The minimum -6 dB bandwidth shall be at least 500 kHz.

13.4 Test Method

With the EUT connected as per Figure iii, the bandwidth of the EUT was measured on a spectrum analyser.

The measurements were performed with EUT set at its maximum duty. All modulation schemes, data rates and power settings were used to observe the worst-case configuration in each bandwidth.

Figure iii Test Setup

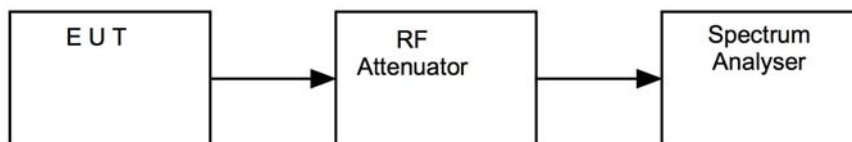

13.5 Test Equipment

Equipment Description	Manufacturer	Equipment Type	Element No	Due For Calibration
Spectrum Analyser	R&S	FSU26	REF909	2019-06-15

13.6 Test Results

Test: 6 dB Bandwidth; Power Setting: 5 dBm				
Channel Frequency (MHz)	F _L (MHz)	F _H (MHz)	6dB Bandwidth (kHz)	Result
2405	2404.183	2405.801	1618.6	PASS
2440	2439.183	2440.801	1618.6	PASS
2480	2479.183	2480.801	1618.6	PASS

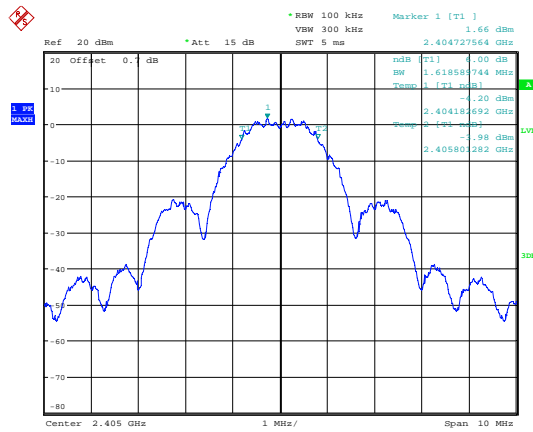

Date: 19.JUL.2018 15:31:11

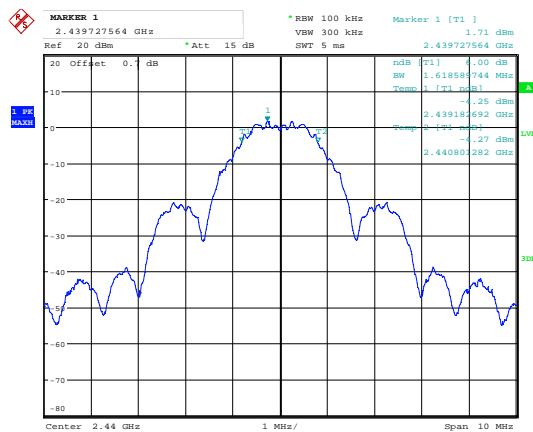

Date: 19.JUL.2018 15:14:17

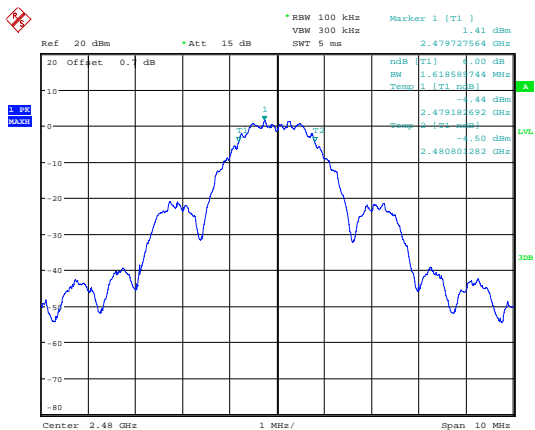

Date: 19.JUL.2018 15:20:47

Test: 99% Bandwidth; Power Setting: 5 dBm				
Channel Frequency (MHz)	F _L (MHz)	F _H (MHz)	99% Bandwidth (kHz)	Result
2405	2403.702	2406.282	2580.1	PASS
2440	2438.702	2441.282	2580.1	PASS
2480	2478.702	2481.282	2580.1	PASS

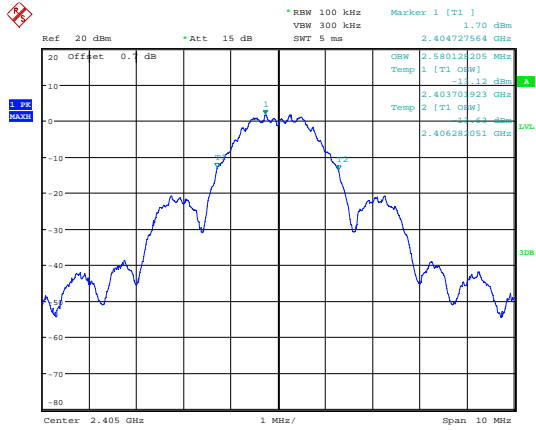

Date: 19.JUL.2018 15:23:46

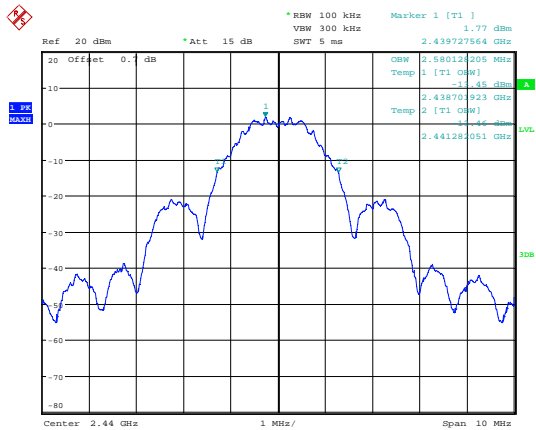

Date: 19.JUL.2018 15:12:28

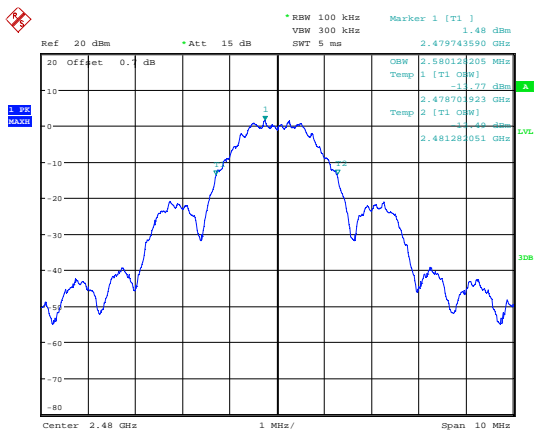

Date: 19.JUL.2018 15:16:51

14 Maximum peak conducted output power

14.1 Definition

The maximum peak conducted output power is defined as the maximum power level measured with a peak detector using a filter with width and shape of which is sufficient to accept the signal bandwidth.

The maximum conducted output power is defined as the total transmit power delivered to all antennas and antenna elements averaged across all symbols in the signaling alphabet when the transmitter is operating at its maximum power control level.

14.2 Test Parameters

Test Location:	Element Hull
Test Chamber:	Wireless Lab 1
Test Standard and Clause:	ANSI C63.10-2013, Clause 11.9.1
EUT Frequencies Measured:	2405 MHz, 2440 MHz & 2480 MHz
Deviations From Standard:	None
Measurement Detector:	Peak

Environmental Conditions (Normal Environment)

Temperature: 23 °C	+15 °C to +35 °C (as declared)
Humidity: 45 % RH	20 % RH to 75 % RH (as declared)

14.3 Test Limit

For systems employing digital modulation techniques operating in the bands 902 to 928 MHz, 2400 to 2483.5 MHz and 5725 to 5850 MHz, the maximum peak conducted output power shall not exceed 1 W.

14.4 Test Method

With the EUT connected as per Figure iv, the resolution bandwidth of the spectrum analyser was increased above the EUT occupied bandwidth and the peak emission data noted.

The measurements were performed with EUT set at its maximum duty. All modulation schemes, data rates and power settings were used to observe the worst-case configuration in each bandwidth.

Figure iv Test Setup

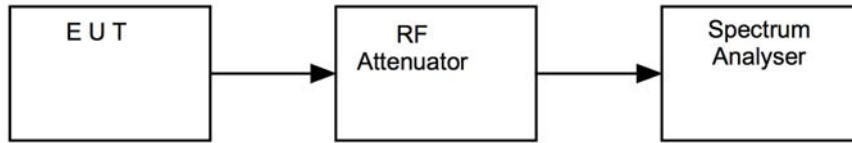

14.5 Test Equipment

Equipment Description	Manufacturer	Equipment Type	Element No	Due For Calibration
Spectrum Analyser	R&S	FSU26	REF909	2019-06-15

14.6 Test Results

Power Setting: 5 dBm						
Channel Frequency (MHz)	Maximum peak conducted output power		Antenna gain (dBi)	E.I.R.P.		Result
	(dBm)	(W)		(dBm)	(W)	
2405	4.99	0.0032	2.0	6.99	0.0050	PASS
2440	4.91	0.0031	2.0	6.91	0.0049	PASS
2480	4.72	0.0030	2.0	6.72	0.0047	PASS

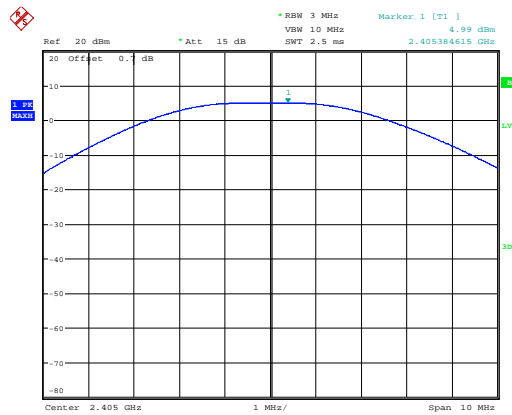

Date: 19 JUL 2018 15:10:32

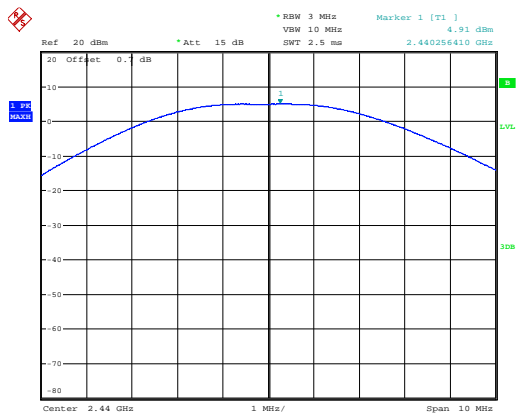

Date: 19.JUL.2018 15:15:00

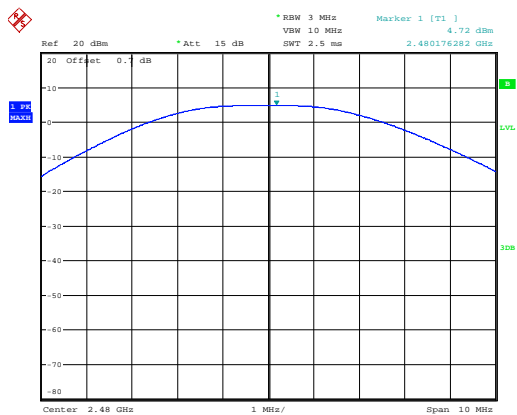

Date: 19.JUL.2018 15:21:14

15 Out-of-band and conducted spurious emissions

15.1 Definition

Out-of-band emission

Emission on a frequency or frequencies immediately outside the necessary bandwidth that results from the modulation process but excluding spurious emissions.

Spurious emission

Emission on a frequency or frequencies that are outside the necessary bandwidth and the level of which may be reduced without affecting the corresponding transmission of information. Spurious emissions include harmonic emissions, parasitic emissions, intermodulation products, and frequency conversion products, but exclude out-of-band emissions.

15.2 Test Parameters

Test Location:	Element Hull
Test Chamber:	Wireless Lab 1
Test Standard and Clause:	ANSI C63.10-2013, Clause 11.11
EUT Frequencies Measured:	2405 MHz, 2440 MHz & 2480 MHz
Deviations From Standard:	None
Measurement BW:	100 kHz
Spectrum Analyzer Video BW:	300 kHz
Measurement Detector:	Peak
Measurement Range:	9 kHz to 25 GHz

Environmental Conditions (Normal Environment)

Temperature: 23 °C	+15 °C to +35 °C (as declared)
Humidity: 45 % RH	20 % RH to 75 % RH (as declared)

15.3 Test Limit

In any 100 kHz bandwidth outside the frequency band in which the spread spectrum or digitally modulated device is operating, the RF power that is produced shall be at least 20 dB below that in the 100 kHz bandwidth within the band that contains the highest level of the desired power, based on either an RF conducted or a radiated measurement, provided that the transmitter demonstrates compliance with the peak conducted power limits.

If the transmitter complies with the conducted power limits based on the use of root-mean-square averaging over a time interval, the attenuation required shall be 30 dB instead of 20 dB.

Attenuation below the general field strength limits specified in FCC 47CFR15.209 (a) / RSS-Gen is not required.

15.4 Test Method

With the EUT connected as per Figure v, the emissions from the EUT were measured on a spectrum analyser.

The measurements were performed with EUT set at its maximum duty. All modulation schemes, data rates and power settings were used to observe the worst case configuration in each bandwidth.

Figure v Test Setup

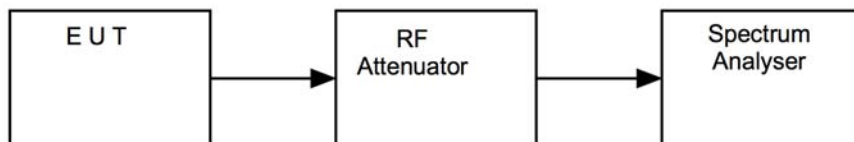

15.5 Test Equipment

<i>Equipment Description</i>	<i>Manufacturer</i>	<i>Equipment Type</i>	<i>Element No</i>	<i>Due For Calibration</i>
Spectrum Analyser	R&S	FSU26	REF909	2019-06-15

15.6 Test Results

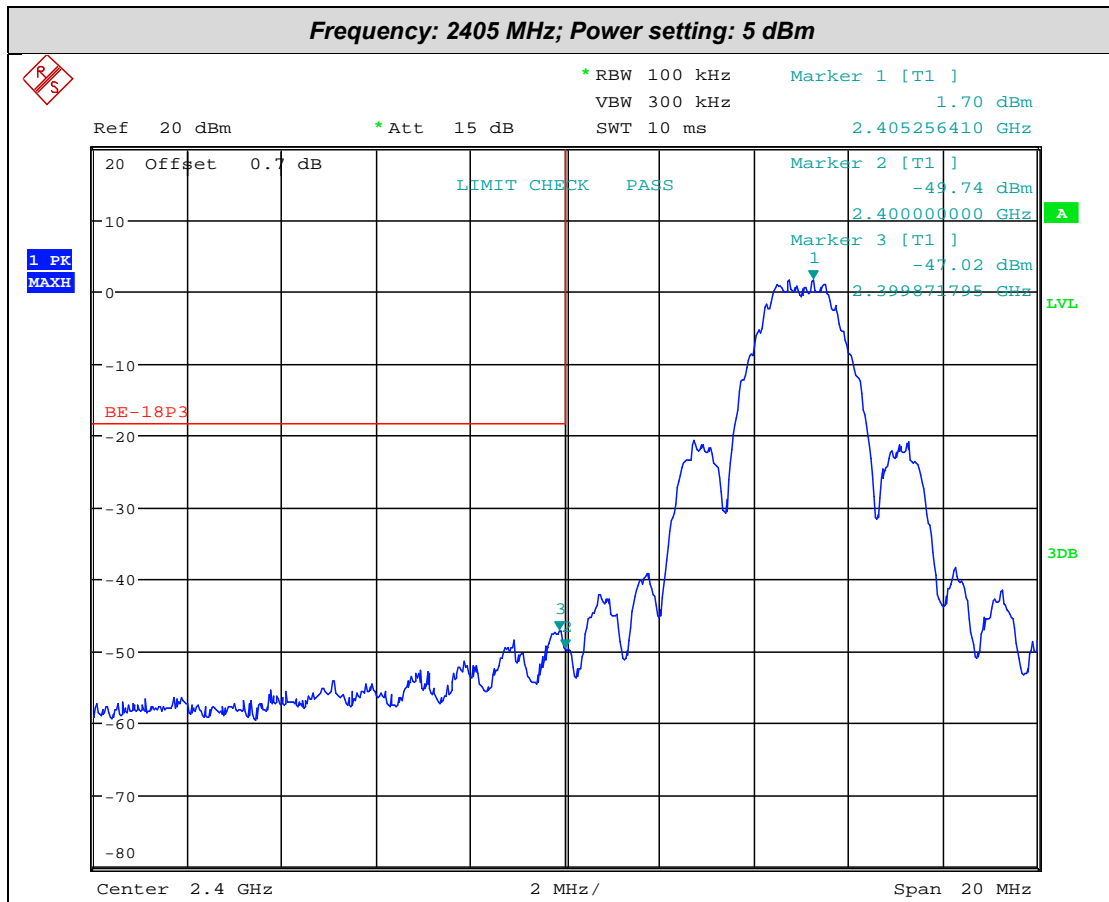

Date: 19.JUL.2018 15:58:38

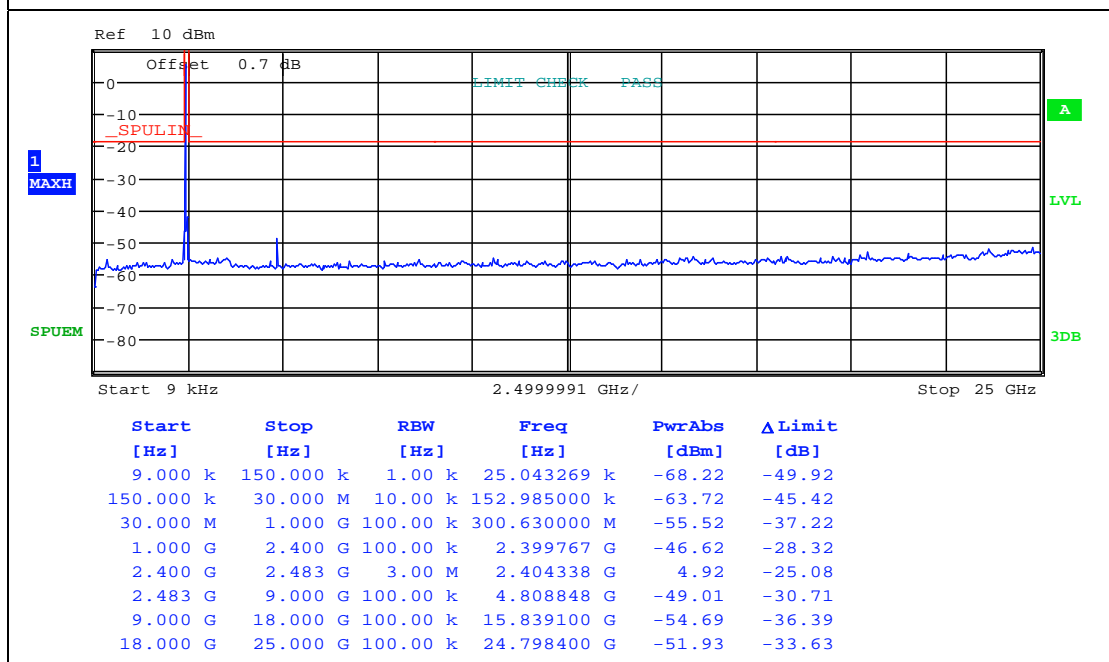

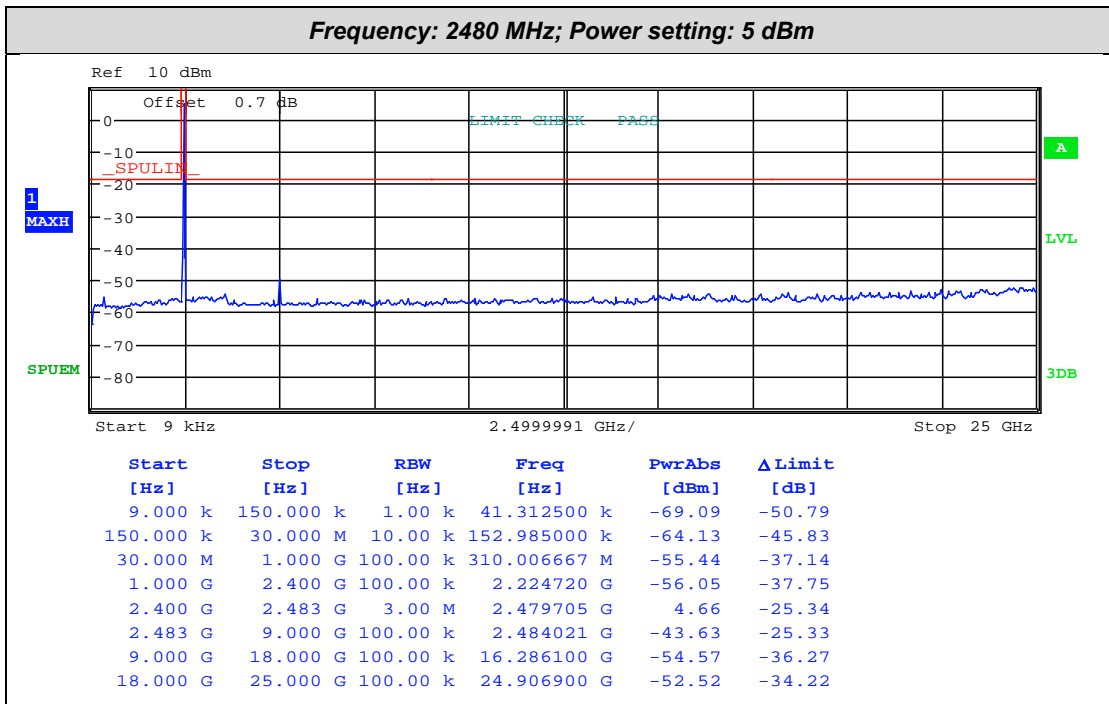
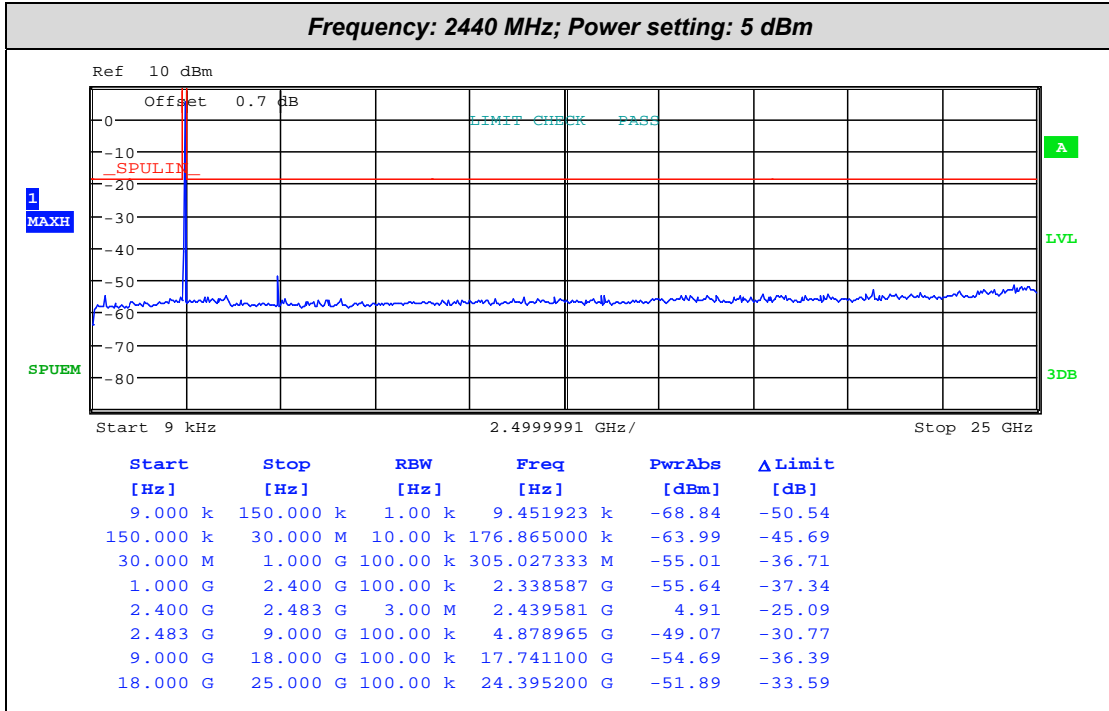

16 Power spectral density

16.1 Definition

The power per unit bandwidth.

16.2 Test Parameters

Test Location:	Element Hull
Test Chamber:	Wireless Lab 1
Test Standard and Clause:	ANSI C63.10-2013, Clause 11.10
EUT Frequencies Measured:	2405 MHz, 2440 MHz & 2480 MHz
Deviations From Standard:	None
Measurement Detector:	Peak

Environmental Conditions (Normal Environment)

Temperature: 23 °C	+15 °C to +35 °C (as declared)
Humidity: 45 % RH	20 % RH to 75 % RH (as declared)

16.3 Test Limit

The transmitter power spectral density conducted from the transmitter to the antenna shall not be greater than 8 dBm in any 3 kHz band during any time interval of continuous transmission.

16.4 Test Method

With the EUT connected as per Figure vi, the peak emission of the EUT was measured on a spectrum analyser, with path losses taken into account.

The measurements were performed with EUT set at its maximum duty. All modulation schemes, data rates and power settings were used to observe the worst case configuration in each bandwidth.

Figure vi Test Setup

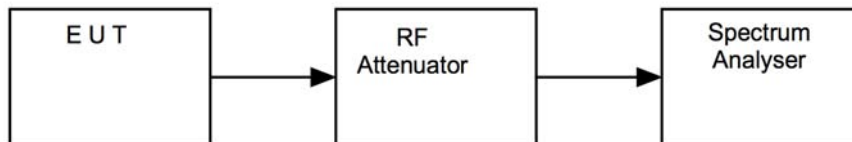

16.5 Test Equipment

<i>Equipment Description</i>	<i>Manufacturer</i>	<i>Equipment Type</i>	<i>Element No</i>	<i>Due For Calibration</i>
Spectrum Analyser	R&S	FSU26	REF909	2019-06-15

16.6 Test Results

Power Setting: 5 dBm				
Channel Frequency (MHz)	Analyzer Level (dBm)	Cable loss (dB)	Power (dBm)	Result
2405	1.70	0.0	1.70	PASS
2440	1.64	0.0	1.64	PASS
2480	1.49	0.0	1.49	PASS

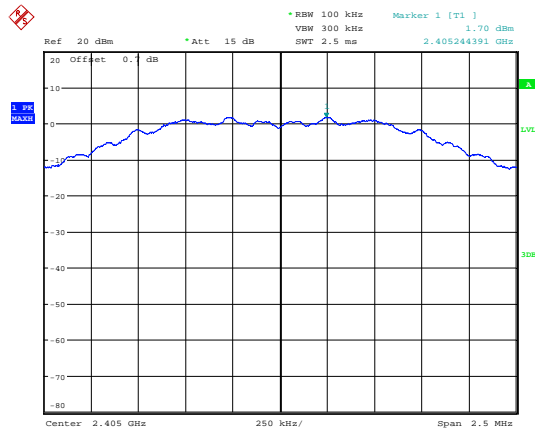

Date: 19.JUL.2018 15:38:18

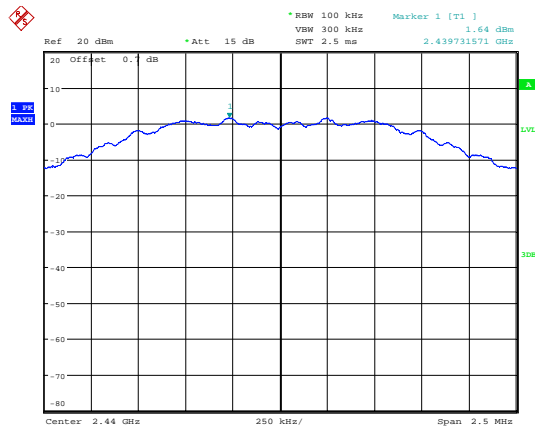

Date: 19.JUL.2018 15:40:31

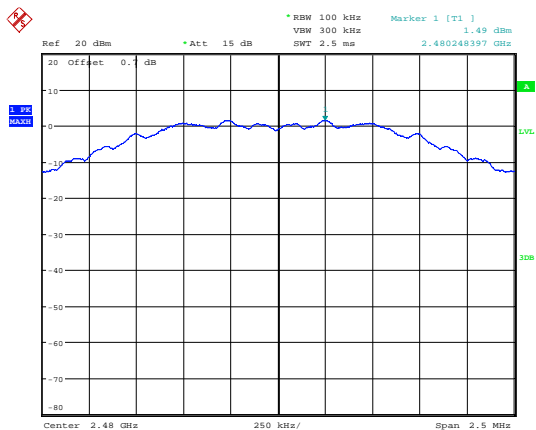

Date: 19.JUL.2018 15:45:05

17 Measurement Uncertainty

Calculated Measurement Uncertainties

All statements of uncertainty are expanded standard uncertainty using a coverage factor of 1.96 to give a 95 % confidence:

[1] Radiated spurious emissions

Uncertainty in test result (30 MHz to 1 GHz) = **4.75 dB**

Uncertainty in test result (1 GHz to 18 GHz) = **4.46 dB**

[2] AC power line conducted emissions

Uncertainty in test result = **3.2 dB**

[3] Occupied bandwidth

Uncertainty in test result = **15.58 %**

[4] Conducted carrier power

Uncertainty in test result (Power Meter) = **0.93 dB**

[5] Conducted RF power out-of-band

Uncertainty in test result – up to 8.1 GHz = **3.31 dB**

Uncertainty in test result – 8.1 GHz to 15.3 GHz = **4.43 dB**

[6] Radiated RF power out-of-band

Uncertainty in test result (30 MHz to 1 GHz) = **4.75 dB**

Uncertainty in test result (1 GHz to 18 GHz) = **4.46 dB**

[7] Power spectral density

Uncertainty in test result (Spectrum Analyser) = **3.11 dB**

[8] ERP / EIRP

Uncertainty in test result (Laboratory) = **4.71 dB**

Uncertainty in test result (Pershore OATS) = **4.26 dB**

18 RF Exposure

As per KDB 447498

47 CFR §§1.1307 and 2.1091

2.1091 Radio frequency radiation exposure evaluation: Portable devices.

For purposes of these requirements mobile devices are defined by the FCC as transmitters designed to be used in other than fixed locations and to generally be used in such a way that a separation distance of at least 20 centimetres is normally maintained between radiating structures and the body of the user or nearby persons. These devices are normally evaluated for exposure potential with relation to the MPE limits. As the 20cm separation specified under FCC rules may not be achievable under normal operation of the EUT, an RF exposure calculation is needed to show the minimum distance required to be less than 0.6mW/cm² power density limit, as required under FCC rules

Prediction of MPE limit at a given distance

Equation from KDB 447498 D01

$$S = \frac{1.64 ERP}{4 \pi R^2} \text{ re - arranged} \quad R = \sqrt{\frac{1.64 ERP}{S 4 \pi}}$$

where:

S = power density

R = distance to the centre of radiation of the antenna

ERP = EUT Maximum power

Result:

Prediction Frequency (MHz)	Maximum ERP (mW)	Power density limit (S) (mW/cm ²)	Distance (R) cm required to be less than 0.6mW/cm ² (cm)
2405	5	0.6	1.04