

RS 165

Digital Wireless Headphone System



Instuction Manual

Contents

- Important safety information** 2
- The RS 165 digital wireless headphone system** 4
- Package includes** 5
- Product overview** 6
 - Overview of the HDR 165 headphones 6
 - Overview of the TR 165 transmitter 7
 - Overview of the indicators 8
- Putting the RS 165 into operation** 11
 - Setting up the transmitter 11
 - Connecting the transmitter to an audio source 12
 - Connecting the transmitter to an AC wall outlet 15
 - Replacing and inserting the rechargeable batteries 16
 - Charging the rechargeable batteries 17
 - Adjusting the headband 18
 - Using the RS 165 headphone system 19
 - Switching your wireless headphone system on 19
 - Adjusting the volume 20
 - Muting/unmuting the headphones 20
 - Activating/deactivating the dynamic bass boost 21
 - Pairing one or several headphones to the transmitter 22
 - Switching your wireless headphones off 23
- Cleaning and maintaining the RS 165** 24
 - Replacing the ear pads 24
- Troubleshooting** 25
 - Sound problems 25
 - Other problems 26
 - Leaving the range of the transmitter 27
 - Clearing the pair settings on the headphones 27
- Specifications** 28
- Manufacturer declarations** 29



Important safety information

- ▶ Read this instruction manual carefully and completely before using the product.
- ▶ Always include this instruction manual when passing the product on to third parties.
- ▶ Do not use an obviously defective product.

Preventing damage to health and accidents

- ▶ Protect your hearing from high volume levels. Permanent hearing damage may occur when headphones are used at high volume levels for long periods of time. Sennheiser headphones sound exceptionally good at low and medium volume levels.
- ▶ Keep the headphones at least 10 cm/3.94" from cardiac pacemakers or implanted defibrillators. The headphones contain magnets that generate a magnetic field which could cause interference with cardiac pacemakers and implanted defibrillators.
- ▶ Keep the product, accessories and packaging parts out of reach of children and pets to prevent accidents and choking hazards.
- ▶ Do not use the product in situations which require special attention (e.g. in traffic or when performing skilled jobs).

Preventing damage to the product and malfunctions

- ▶ Always keep the product dry and do not expose it to extreme temperatures to avoid corrosion or deformation. The normal operating temperature is from 0 to 40 °C/32 to 104 °F.
- ▶ Use only attachments/accessories/spare parts supplied or recommended by Sennheiser.
- ▶ Unplug the power supply unit from the AC wall outlet if you are not going to use the product for extended periods of time.
- ▶ Varnish or furniture polish may degrade the feet of the transmitter, which could stain your furniture. You should therefore place the transmitter on a non-slip pad to avoid potential staining of furniture.
- ▶ Do not place your headphones on a glass dummy head, chair armrest or similar objects for long periods as this can widen the headband and reduce the contact pressure of the headphones.
- ▶ Clean the product only with a soft, dry cloth.

Intended use/Liability

This wireless headphone system is suitable for use with hi-fi systems, TV sets, and home cinema systems.

This product is intended for private domestic use only. It is not suitable for commercial use. This product is also not intended to be used with portable audio devices.

It is considered improper use when this product is used for any application not named in the associated product guides and instruction manual.

Sennheiser does not accept liability for damage arising from abuse or misuse of this product and its attachments/accessories.

Safety instructions for standard/rechargeable batteries



WARNING

In extreme cases, the standard/rechargeable batteries may leak and may cause the following hazards if abused or misused:

- explosion
- fire
- heat
- smoke/gas

	Keep away from children.		Do not heat above 70 °C/ 158 °F), e.g. do not expose to sunlight or throw into a fire.
	Do not expose to moisture.		When not using rechargeable batteries for extended periods of time, charge them regularly (about every 3 months).
	Do not mutilate or dismantle.		When not using the product for an extended period of time, remove the standard/rechargeable batteries.
	Observe correct polarity.		Use only rechargeable batteries and chargers recommended by Sennheiser.
	Pack/store standard/charged rechargeable batteries so that the terminals cannot contact each other – danger of shorting out/ fire hazard.		Do not continue using defective standard/rechargeable batteries and dispose of them immediately.
	Switch battery-powered products off after use.		Immediately remove standard/rechargeable batteries from an obviously defective product.
	Charge rechargeable batteries at ambient temperatures between 10 and 40 °C/50 and 104 °F.		Dispose of standard/rechargeable batteries at special collection points or return them to your specialist dealer.
	Do not charge standard batteries.		Do not mix standard and rechargeable batteries in the battery compartments.

The RS 165 digital wireless headphone system

Sennheiser's RS 165 is the perfect introduction to the world of digital wireless home entertainment. Its ergonomic, closed, circumaural design reduces background noise while providing an exceptionally comfortable fit, so that you can focus on enjoying your favorite television programs and movies.

Easy to use and intuitive, all you need to do is to connect the included multi-purpose transmitter to your home audio or entertainment system. And because these headphones are from Sennheiser, you can count on a vibrant, detailed sound reproduction. You'll also be free to move around, since the RS 165 provides a robust, digital wireless audio transmission with minimum latency, and there is a Bass Boost listening mode for added power.

Sennheiser's RS 165: Get more from your TV and home audio today!

Features

- Closed, circumaural headphones with excellent digital wireless audio transmission
- High-quality Sennheiser transducers and a selectable Bass Boost mode for vibrant sound
- Intelligently designed controls for maximum ease of use
- Multi-purpose transmitter – also functions as “easy-charge” cradle and docking station
- Multi-receiver transmission – transmitter supports up to four pairs of headphones simultaneously
- Ergonomic design for enhanced wearing comfort
- 2-year warranty

Package includes



HDR 165 headphones

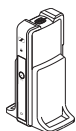

TR 165 transmitter



Power supply unit with multi-country adapters
(EU, UK, US, AU)

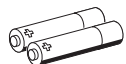

Low self-discharge NiMH rechargeable batteries, AAA size



Stereo audio cable with 3.5 mm jack plugs, 2 m



Quick guide



Instruction manual CD in 15 languages (PDF files)



Safety guide

Product overview

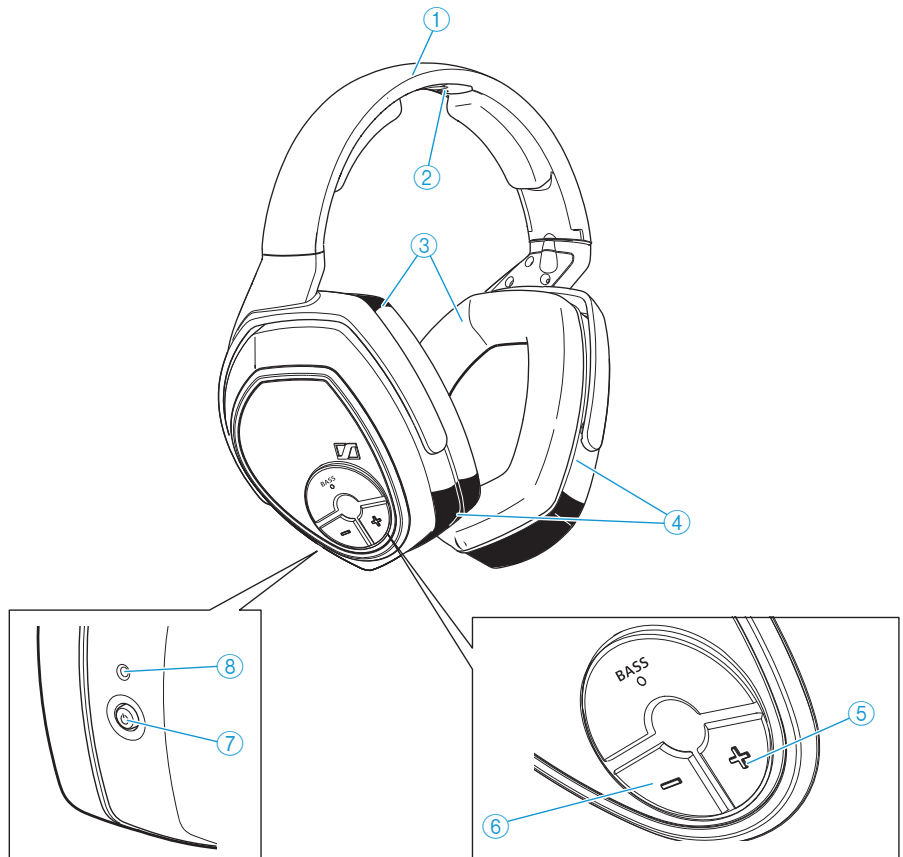

Overview of the HDR 165 headphones

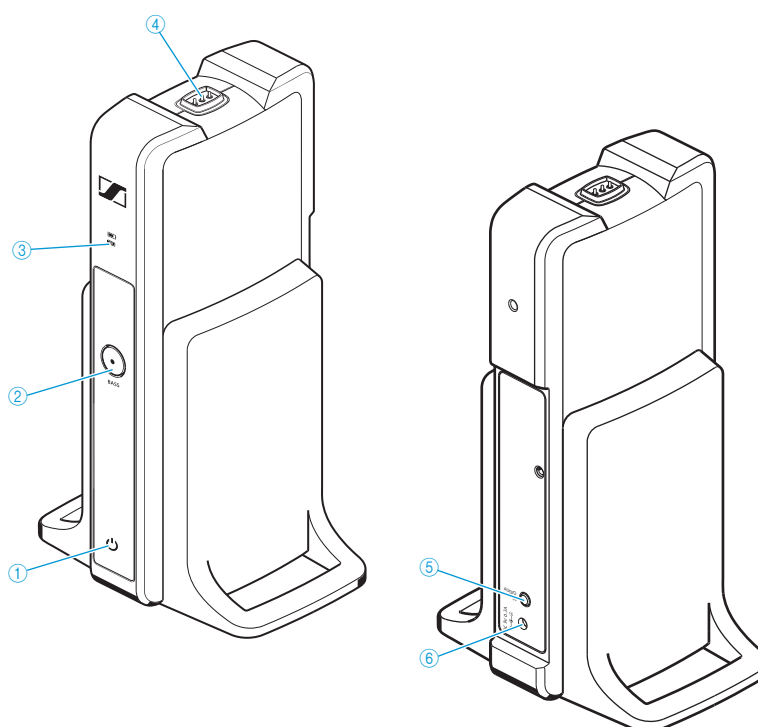

- ① Headband
- ② Charging contacts
- ③ Ear pads
- ④ Ear cups/Battery compartments
- ⑤ Volume + button
- ⑥ Volume - button
- ⑦ HDR power button 
- ⑧ HDR status LED

Overview of the TR 165 transmitter



- ① TR status LED 
- ② **BASS** button (with LED)
- ③ Charge status LED 
- ④ Charging contacts
- ⑤ **AUDIO IN** Analog audio input (3.5 mm jack)
- ⑥ **DC 9V 0.3A** socket for the power supply unit

Overview of the indicators

LED indicators on the headphones

The LED indicators on the headphones and on the transmitter indicate the current operating state. If you are not using the headphones, the LED indicators automatically dim after approx. 30 seconds to not disturb you.

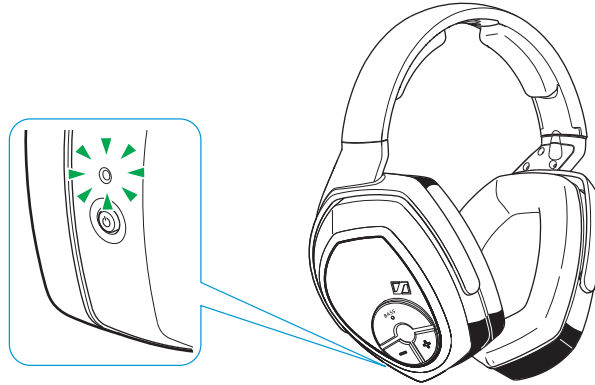

HDR status LED	Meaning
	The headphones are switched off.
	The transmitter and headphones are connected.
	The transmitter and headphones are connected and the rechargeable batteries are almost empty.
	The headphones are disconnected from or cannot connect to the transmitter.
	The headphones are disconnected from or cannot connect to the transmitter and the rechargeable batteries are almost empty.

LED indicators on the transmitter

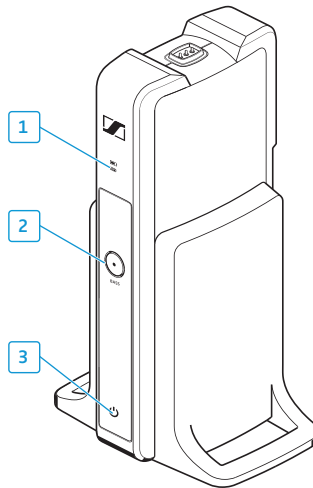





1

Charge status LED	Meaning
	The transmitter is not charging.
	The rechargeable batteries are being charged.
	The rechargeable batteries are fully charged.
	A charging/battery fault has been detected.

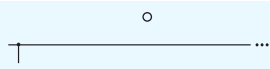
After taking the headphones from the holder, the charge status LED indicates the approximate operating time:

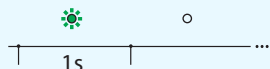
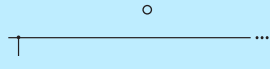
Charge status LED	Operating time	Battery capacity
	up to 4 hours	0 to 25%
	approx. 4 to 9 hours	25 to 50%
	approx. 9 to 14 hours	50 to 75%
	approx. 14 to 18 hours	75 to 100%

2	BASS button LED	Meaning
		The dynamic bass boost is deactivated.
		The dynamic bass boost is activated.
3	TR status LED 	Meaning
		The transmitter is connected to the AC wall outlet.
		The transmitter is in standby mode.
		The transmitter and headphones are connected.

Putting the RS 165 into operation

Setting up the transmitter

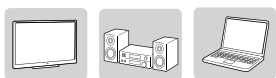

- ▶ Choose a suitable place near your audio source.
- ▶ Separate the transmitter and other wireless devices in a room by at least 50 cm/20" to avoid interference.
- ▶ Do not place the transmitter close to metal objects such as shelf bars, reinforced concrete walls, etc. as this can decrease the cover range of the transmitter.

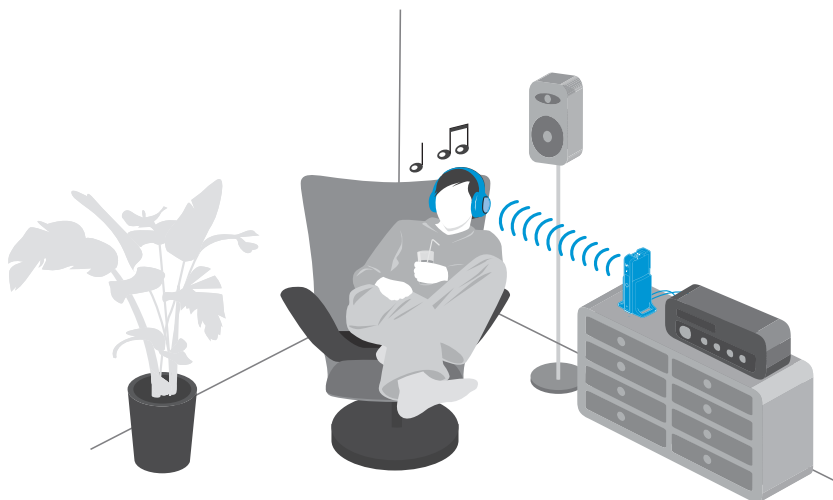



Connecting the transmitter to an audio source

You can connect the transmitter to different audio sources, such as a Blu-ray player, a TV or a stereo hi-fi system.

 You can also refer to the beginner's video guides on how to connect your digital wireless headphone system to a TV at www.sennheiser.com/how-to-videos.

- ▶ Switch your audio source off before connecting the transmitter.
- ▶ Check the connection options available for your audio source (audio output, usually marked "OUT").
- ▶ Select the corresponding connection cable and, if necessary, a suitable adapter.
- ▶ Depending on the connection option selected, go to the respective chapter and follow the instructions on how to connect the transmitter to an audio source.

Connection options available for your audio source		Connection cable	Page
	3.5 mm or 6.3 mm/1/4" jack socket	Stereo audio cable (with adapter 3.5 mm jack socket to 6.3 mm/1/4" jack plug; to be ordered separately)	13
	RCA	Stereo audio cable with adapter 3.5 mm jack socket to 2 RCA plugs (to be ordered separately)	14

 You can purchase accessories and adapters from your local Sennheiser partner.

A

Connection option A: 3.5 mm or 6.3 mm/¼" jack socket (analog)

Some TV models mute the loudspeakers when you connect the transmitter to the headphone socket. Check in the menu of your TV to see if the muting function can be deactivated. Alternatively, connect the TV and the transmitter using a different option (B).

- ▶ Switch your audio source off before connecting the transmitter.
- ▶ If necessary, connect the adapter 6.3 mm/¼" jack plug onto the stereo audio cable.
- ▶ Connect the stereo audio cable to the 3.5 mm jack socket of the transmitter and to the headphone socket of your audio source.

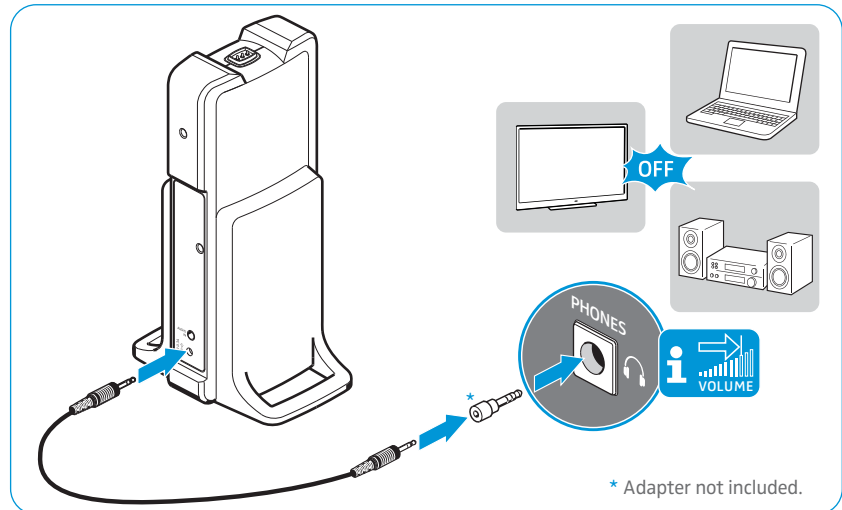

i Adjust the volume of the headphone socket on your audio source to at least about the middle level.

B

Connection option B: RCA

- ▶ Switch your audio source off before connecting the transmitter.
- ▶ Plug the RCA adapter onto the stereo audio cable.
- ▶ Connect the stereo audio cable to the 3.5 mm jack socket of the transmitter.
- ▶ Connect the RCA adapter to the RCA outputs of your audio source (in most cases "AUDIO OUT"). Connect the red RCA plug to the red RCA socket and the white RCA plug to the white or black RCA socket.

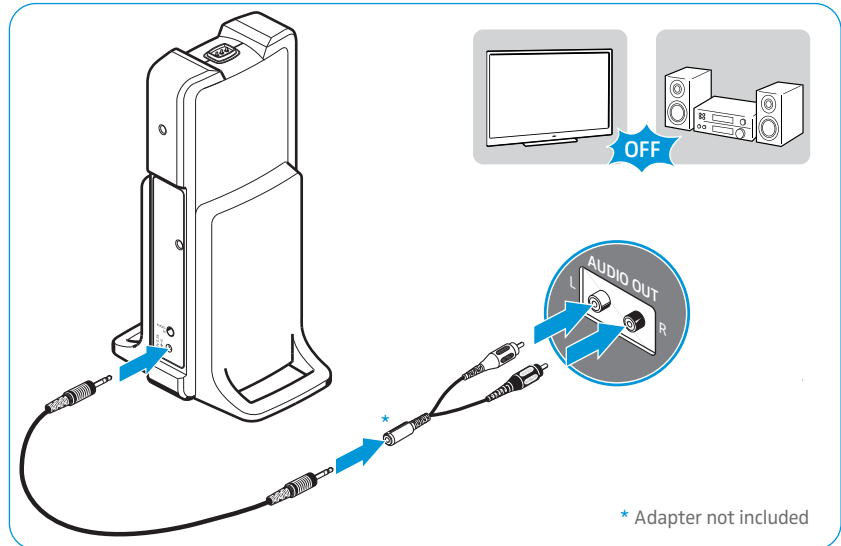

Connecting the transmitter to an AC wall outlet

- 1 Select a suitable country adapter and slide it onto the power supply unit until it locks firmly in place.
- 2 Connect the power supply unit connector to the power input socket of the transmitter.
- 3 Plug the power supply unit into an AC wall outlet.
The TR status LED  lights up for a second. The transmitter is in standby mode.

