

TEST REPORT



Test report no.: 1-3919/17-01-10

BNetzA-CAB-02/21-102

Testing laboratory

CTC advanced GmbH

Untertuerkheimer Strasse 6 – 10
66117 Saarbruecken / Germany
Phone: + 49 681 5 98 - 0
Fax: + 49 681 5 98 - 9075
Internet: <http://www.ctcadvanced.com>
e-mail: mail@ctcadvanced.com

Accredited Testing Laboratory:

The testing laboratory (area of testing) is accredited according to DIN EN ISO/IEC 17025 (2005) by the Deutsche Akkreditierungsstelle GmbH (DAkkS). The accreditation is valid for the scope of testing procedures as stated in the accreditation certificate with the registration number: D-PL-12076-01-03

Applicant

Sennheiser electronic GmbH & Co. KG

Am Labor 1
30900 Wedemark / GERMANY
Phone: +49 5130 600-0
Contact: Marco Happ
e-mail: marco.happ@sennheiser.com
Phone: +49 5130 600-2621

Manufacturer

Benchmark Electronics

Lelyweg 10
7602 ES Almelo / NETHERLANDS

Test standard/s

- | | |
|-------------------|---|
| 47 CFR Part 15 | Title 47 of the Code of Federal Regulations; Chapter I; Part 15 - Radio frequency devices |
| RSS - 247 Issue 2 | Digital Transmission Systems (DTSs), Frequency Hopping Systems (FHSs) and Licence - Exempt Local Area Network (LE-LAN) Devices |
| RSS - Gen Issue 4 | Spectrum Management and Telecommunications Radio Standards Specifications - General Requirements and Information for the Certification of Radio Apparatus |

For further applied test standards please refer to section 3 of this test report.

Test Item

Kind of test item: Wireless Smartdevice Microphone
Model name: Memory Mic
FCC ID: DMOSRM
IC: 2099A-SRM
Frequency: DTS band 2400 MHz to 2483.5 MHz
Technology tested: WLAN
Antenna: Ceramic antenna (2450AT42B100)
Power supply: 3.7 V DC by battery (AHB571935PJT Li-polymer)
Temperature range: 0°C to +40°C

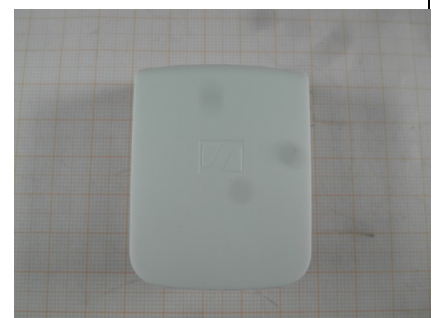

This test report is electronically signed and valid without handwritten signature. For verification of the electronic signatures, the public keys can be requested at the testing laboratory.

Test report authorized:

David Lang
Lab Manager
Radio Communications & EMC

Test performed:

Mihail Dorongovskij
Lab Manager
Radio Communications & EMC

1 Table of contents

1	Table of contents	2
2	General information	3
2.1	Notes and disclaimer	3
2.2	Application details.....	3
2.3	Test laboratories sub-contracted	3
3	Test standard/s and references	4
4	Test environment.....	5
5	Test item.....	5
5.1	General description.....	5
5.2	Additional information	5
6	Sequence of testing	6
6.1	Sequence of testing radiated spurious 9 kHz to 30 MHz.....	6
6.2	Sequence of testing radiated spurious 30 MHz to 1 GHz.....	7
6.3	Sequence of testing radiated spurious 1 GHz to 18 GHz.....	8
6.4	Sequence of testing radiated spurious above 18 GHz	9
7	Description of the test setup.....	10
7.1	Shielded semi anechoic chamber.....	11
7.2	Shielded fully anechoic chamber	12
7.3	Radiated measurements > 18 GHz.....	13
7.4	Conducted measurements with peak power meter & spectrum analyzer.....	14
7.5	AC conducted	15
8	Measurement uncertainty	16
9	Summary of measurement results	17
10	Additional comments.....	18
11	Additional EUT parameter	19
12	Measurement results	20
12.1	Antenna gain	20
12.2	Identify worst case data rate.....	23
12.3	Maximum output power.....	24
12.4	Duty cycle	25
12.5	Peak power spectral density.....	32
12.6	6 dB DTS bandwidth	39
12.7	Occupied bandwidth – 99% emission bandwidth.....	46
12.8	Occupied bandwidth – 20 dB bandwidth.....	53
12.9	Band edge compliance radiated.....	60
12.10	Spurious emissions conducted.....	63
12.11	Spurious emissions radiated below 30 MHz.....	75
12.12	Spurious emissions radiated 30 MHz to 1 GHz.....	82
12.13	Spurious emissions radiated above 1 GHz.....	93
12.14	Spurious emissions conducted below 30 MHz (AC conducted).....	105
Annex A	Glossary.....	108
Annex B	Document history	109
Annex C	Accreditation Certificate	109

2 General information

2.1 Notes and disclaimer

The test results of this test report relate exclusively to the test item specified in this test report. CTC advanced GmbH does not assume responsibility for any conclusions and generalizations drawn from the test results with regard to other specimens or samples of the type of the equipment represented by the test item.

The test report may only be reproduced or published in full. Reproduction or publication of extracts from the report requires the prior written approval of CTC advanced GmbH.

The testing service provided by CTC advanced GmbH has been rendered under the current "General Terms and Conditions for CTC advanced GmbH".

CTC advanced GmbH will not be liable for any loss or damage resulting from false, inaccurate, inappropriate or incomplete product information provided by the customer.

Under no circumstances does the CTC advanced GmbH test report include any endorsement or warranty regarding the functionality, quality or performance of any other product or service provided.

Under no circumstances does the CTC advanced GmbH test report include or imply any product or service warranties from CTC advanced GmbH, including, without limitation, any implied warranties of merchantability, fitness for purpose, or non-infringement, all of which are expressly disclaimed by CTC advanced GmbH.

All rights and remedies regarding vendor's products and services for which CTC advanced GmbH has prepared this test report shall be provided by the party offering such products or services and not by CTC advanced GmbH. In no case this test report can be considered as a Letter of Approval.

This test report is electronically signed and valid without handwritten signature. For verification of the electronic signatures, the public keys can be requested at the testing laboratory.

2.2 Application details

Date of receipt of order:	2017-12-05
Date of receipt of test item:	2018-03-19
Start of test:	2018-03-19
End of test:	2018-03-21
Person(s) present during the test:	Mr. Jelmer Vos

2.3 Test laboratories sub-contracted

None

3 Test standard/s and references

Test standard	Date	Description
47 CFR Part 15		Title 47 of the Code of Federal Regulations; Chapter I; Part 15 - Radio frequency devices
RSS - 247 Issue 2	February 2017	Digital Transmission Systems (DTSs), Frequency Hopping Systems (FHSs) and Licence - Exempt Local Area Network (LE-LAN) Devices
RSS - Gen Issue 4	November 2014	Spectrum Management and Telecommunications Radio Standards Specifications - General Requirements and Information for the Certification of Radio Apparatus

Guidance	Version	Description
DTS: KDB 558074 D01	v04	Guidance for Performing Compliance Measurements on Digital Transmission Systems (DTS) Operating Under §15.247
ANSI C63.4-2014	-/-	American national standard for methods of measurement of radio-noise emissions from low-voltage electrical and electronic equipment in the range of 9 kHz to 40 GHz
ANSI C63.10-2013	-/-	American national standard of procedures for compliance testing of unlicensed wireless devices

4 Test environment

Temperature	:	T _{nom} T _{max} T _{min}	+22 °C during room temperature tests No tests under extreme conditions required. No tests under extreme conditions required.
Relative humidity content	:		55 %
Barometric pressure	:		1021 hpa
Power supply	:	V _{nom} V _{max} V _{min}	3.7 V DC by battery (AHB571935PJT Li-polymer) No tests under extreme conditions required. No tests under extreme conditions required.

5 Test item

5.1 General description

Kind of test item	:	Wireless Smartdevice Microphone
Type identification	:	Memory Mic
HMN	:	-/-
PMN	:	Memory Mic
HVIN	:	Memory Mic
FVIN	:	-/-
S/N serial number	:	Rad. EUT 26 (SN: 000125200469) Cond. EUT 16 (SN: 000125200470)
HW hardware status	:	1.4
SW software status	:	P-BEA-1193
Frequency band	:	DTS band 2400 MHz to 2483.5 MHz; Lowest Channel: 2412 MHz, Middle Channel 2437 MHz, Highest Channel 2472 MHz
Type of radio transmission	:	DSSS, OFDM
Use of frequency spectrum	:	
Type of modulation	:	BPSK, QPSK, 16 – QAM, 64 – QAM
Number of channels	:	13
Antenna	:	Ceramic antenna (2450AT42B100)
Power supply	:	3.7 V DC by battery (AHB571935PJT Li-polymer)
Temperature range	:	0°C to +40°C

5.2 Additional information

The content of the following annexes is defined in the QA. It may be that not all of the listed annexes are necessary for this report, thus some values in between may be missing.

Test setup- and EUT-photos are included in test report:

- 1-3919/17-01-01_AnnexA
- 1-3919/17-01-01_AnnexB
- 1-3919/17-01-01_AnnexD

6 Sequence of testing

6.1 Sequence of testing radiated spurious 9 kHz to 30 MHz

Setup

- The equipment is set up to simulate normal operation mode as described in the user manual or defined by the manufacturer.
- If the EUT is a tabletop system, it is placed on a table with 0.8 m height.
- If the EUT is a floor standing device, it is placed directly on the turn table.
- Auxiliary equipment and cables are positioned to simulate normal operation conditions as described in ANSI C 63.4.
- The AC power port of the EUT (if available) is connected to a power outlet below the turntable.
- Measurement distance is 3 m (see ANSI C 63.4) – see test details.
- EUT is set into operation.

Premeasurement*

- The turntable rotates from 0° to 315° using 45° steps.
- The antenna height is 1 m.
- At each turntable position the analyzer sweeps with positive-peak detector to find the maximum of all emissions.

Final measurement

- Identified emissions during the pre-measurement are maximized by the software by rotating the turntable from 0° to 360°.
- Loop antenna is rotated about its vertical axis for maximum response at each azimuth about the EUT. (For certain applications, the loop antenna plane may also need to be positioned horizontally at the specified distance from the EUT)
- The final measurement is done in the position (turntable and elevation) causing the highest emissions with quasi-peak (as described in ANSI C 63.4).
- Final levels, frequency, measuring time, bandwidth, turntable position, correction factor, margin to the limit and limit will be recorded. A plot with the graph of the premeasurement and the limit is stored.

*)Note: The sequence will be repeated three times with different EUT orientations.

6.2 Sequence of testing radiated spurious 30 MHz to 1 GHz

Setup

- The equipment is set up to simulate normal operation mode as described in the user manual or defined by the manufacturer.
- If the EUT is a tabletop system, a table with 0.8 m height is used, which is placed on the ground plane.
- If the EUT is a floor standing device, it is placed on the ground plane with insulation between both.
- Auxiliary equipment and cables are positioned to simulate normal operation conditions as described in ANSI C 63.4.
- The AC power port of the EUT (if available) is connected to a power outlet below the turntable.
- Measurement distance is 10 m or 3 m (see ANSI C 63.4) – see test details.
- EUT is set into operation.

Premeasurement

- The turntable rotates from 0° to 315° using 45° steps.
- The antenna is polarized vertical and horizontal.
- The antenna height changes from 1 m to 3 m.
- At each turntable position, antenna polarization and height the analyzer sweeps three times in peak to find the maximum of all emissions.

Final measurement

- The final measurement is performed for at least six highest peaks according to the requirements of the ANSI C63.4.
- Based on antenna and turntable positions at which the peak values are measured the software maximize the peaks by changing turntable position $\pm 45^\circ$ and antenna height between 1 and 4 m.
- The final measurement is done with quasi-peak detector (as described in ANSI C 63.4).
- Final levels, frequency, measuring time, bandwidth, antenna height, antenna polarization, turntable angle, correction factor, margin to the limit and limit are recorded. A plot with the graph of the premeasurement with marked maximum final results and the limit is stored.

6.3 Sequence of testing radiated spurious 1 GHz to 18 GHz

Setup

- The equipment is set up to simulate normal operation mode as described in the user manual or defined by the manufacturer.
- If the EUT is a tabletop system, a 2-axis positioner with 1.5 m height is used.
- If the EUT is a floor standing device, it is placed directly on the turn table.
- Auxiliary equipment and cables are positioned to simulate normal operation conditions as described in ANSI C 63.4.
- The AC power port of the EUT (if available) is connected to a power outlet below the turntable.
- Measurement distance is 3 m (see ANSI C 63.4) – see test details.
- EUT is set into operation.

Premeasurement

- The turntable rotates from 0° to 315° using 45° steps.
- The antenna is polarized vertical and horizontal.
- The antenna height is 1.5 m.
- At each turntable position and antenna polarization the analyzer sweeps with positive peak detector to find the maximum of all emissions.

Final measurement

- The final measurement is performed for at least six highest peaks according to the requirements of the ANSI C63.4.
- Based on antenna and turntable positions at which the peak values are measured the software maximizes the peaks by rotating the turntable from 0° to 360°. This measurement is repeated for different EUT-table positions (0° to 150° in 30°-steps) and for both antenna polarizations.
- The final measurement is done in the position (turntable, EUT-table and antenna polarization) causing the highest emissions with Peak and RMS detector (as described in ANSI C 63.4).
- Final levels, frequency, measuring time, bandwidth, turntable position, EUT-table position, antenna polarization, correction factor, margin to the limit and limit are recorded. A plot with the graph of the premeasurement with marked maximum final results and the limit is stored.

6.4 Sequence of testing radiated spurious above 18 GHz

Setup

- The equipment is set up to simulate normal operation mode as described in the user manual or defined by the manufacturer.
- Auxiliary equipment and cables are positioned to simulate normal operation conditions as described in ANSI C 63.4.
- The AC power port of the EUT (if available) is connected to a power outlet.
- The measurement distance is as appropriate (e.g. 0.5 m).
- The EUT is set into operation.

Premeasurement

- The test antenna is handheld and moved carefully over the EUT to cover the EUT's whole sphere and different polarizations of the antenna.

Final measurement

- The final measurement is performed at the position and antenna orientation causing the highest emissions with Peak and RMS detector (as described in ANSI C 63.4).
- Final levels, frequency, measuring time, bandwidth, correction factor, margin to the limit and limit are recorded. A plot with the graph of the premeasurement and the limit is stored.

7 Description of the test setup

Typically, the calibrations of the test apparatus are commissioned to and performed by an accredited calibration laboratory. The calibration intervals are determined in accordance with the DIN EN ISO/IEC 17025. In addition to the external calibrations, the laboratory executes comparison measurements with other calibrated test systems or effective verifications. Weekly chamber inspections and range calibrations are performed. Where possible, RF generating and signaling equipment as well as measuring receivers and analyzers are connected to an external high-precision 10 MHz reference (GPS-based or rubidium frequency standard).

In order to simplify the identification of the equipment used at some special tests, some items of test equipment and ancillaries can be provided with an identifier or number in the equipment list below (Lab/Item).

Agenda: Kind of Calibration

k	calibration / calibrated	EK	limited calibration
ne	not required (k, ev, izw, zw not required)	zw	cyclical maintenance (external cyclical maintenance)
ev	periodic self verification	izw	internal cyclical maintenance
Ve	long-term stability recognized	g	blocked for accredited testing
v/k!	Attention: extended calibration interval		
NK!	Attention: not calibrated	*)	next calibration ordered / currently in progress

7.1 Shielded semi anechoic chamber

The radiated measurements are performed in vertical and horizontal plane in the frequency range from 30 MHz to 1 GHz in semi-anechoic chambers. The EUT is positioned on a non-conductive support with a height of 0.80 m above a conductive ground plane that covers the whole chamber. The receiving antennas are conform to specifications ANSI C63. These antennas can be moved over the height range between 1.0 m and 4.0 m in order to search for maximum field strength emitted from EUT. The measurement distances between EUT and receiving antennas are indicated in the test setups for the various frequency ranges. For each measurement, the EUT is rotated in all three axes until the maximum field strength is received. The wanted and unwanted emissions are received by spectrum analyzers where the detector modes and resolution bandwidths over various frequency ranges are set according to requirement ANSI C63.

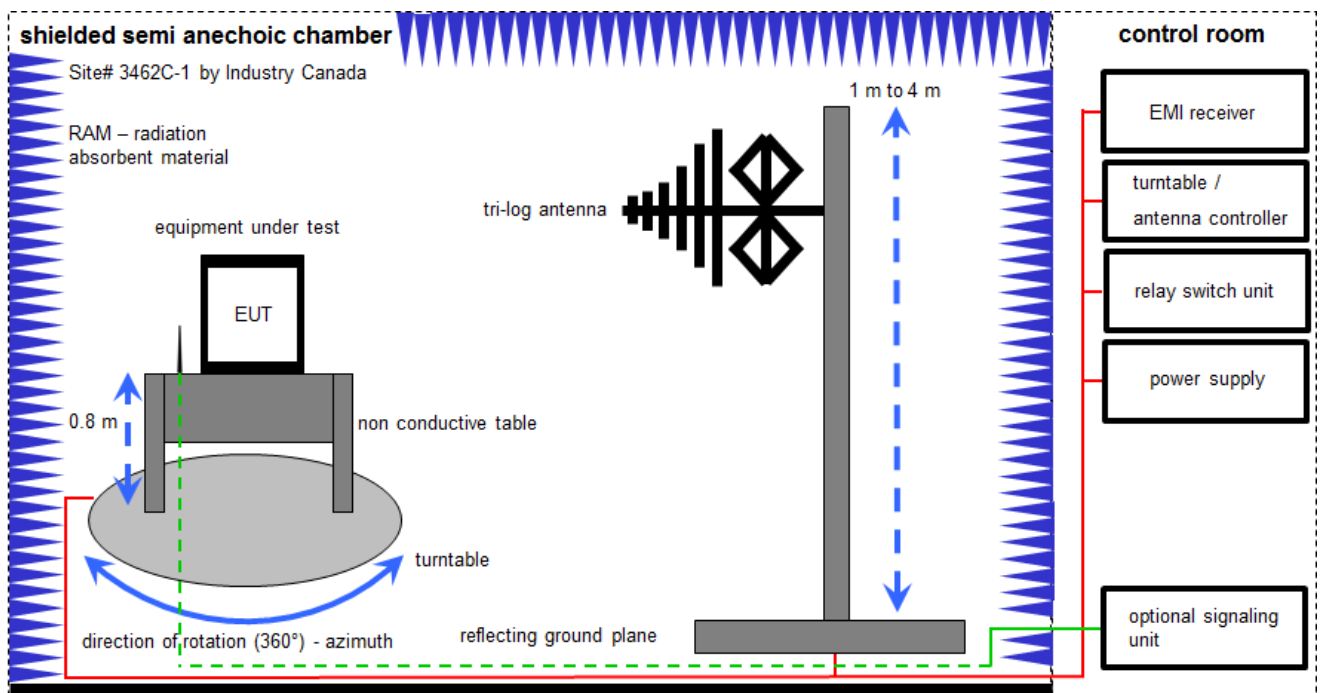

Measurement distance: tri-log antenna 10 meter

$$FS = UR + CL + AF$$

(FS-field strength; UR-voltage at the receiver; CL-loss of the cable; AF-antenna factor)

Example calculation:

$$FS [dB\mu V/m] = 12.35 [dB\mu V/m] + 1.90 [dB] + 16.80 [dB/m] = 31.05 [dB\mu V/m] (35.69 \mu V/m)$$

Equipment table:

No.	Lab / Item	Equipment	Type	Manufacturer	Serial No.	INV. No.	Kind of Calibration	Last Calibration	Next Calibration
1	A	Switch-Unit	3488A	HP	2719A14505	300000368	ev	-/-	-/-
2	A	Meßkabine 1	HF-Absorberhalle	MWB AG 300023	-/-	300000551	ne	-/-	-/-
3	A	EMI Test Receiver	ESCI 3	R&S	100083	300003312	k	15.12.2017	14.12.2018
4	A	Analyzer-Reference-System (Harmonics and Flicker)	ARS 16/1	SPS	A3509 07/0 0205	300003314	vKI!	15.01.2018	14.01.2020
5	A	Antenna Tower	Model 2175	ETS-Lindgren	64762	300003745	izw	-/-	-/-
6	A	Positioning Controller	Model 2090	ETS-Lindgren	64672	300003746	izw	-/-	-/-
7	A	Turntable Interface-Box	Model 105637	ETS-Lindgren	44583	300003747	izw	-/-	-/-
8	A	TRILOG Broadband Test-Antenna 30 MHz - 3 GHz	VULB9163	Schwarzbeck	295	300003787	k	25.04.2016	25.04.2018

7.2 Shielded fully anechoic chamber

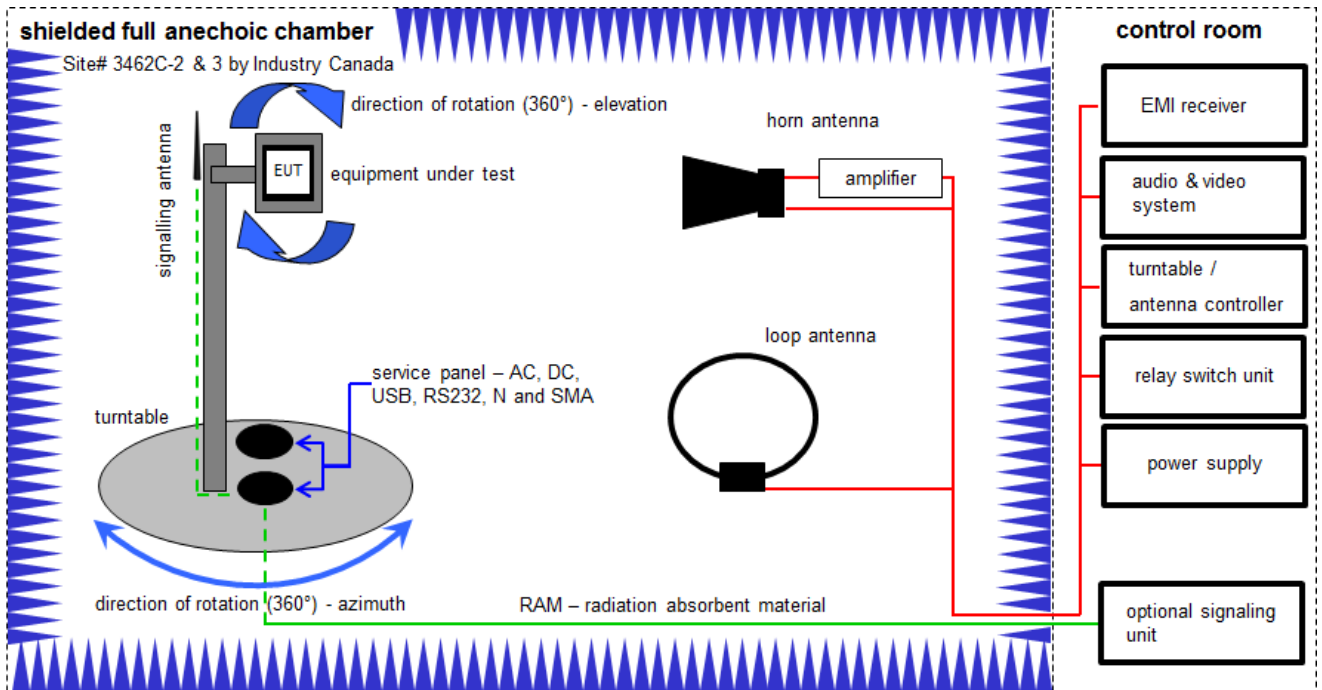

Measurement distance: horn antenna 3 meter; loop antenna 3 meter

$$FS = UR + CA + AF$$

(FS-field strength; UR-voltage at the receiver; CA-loss of the signal path; AF-antenna factor)

Example calculation:

$$FS \text{ [dB}\mu\text{V/m]} = 40.0 \text{ [dB}\mu\text{V/m]} + (-35.8) \text{ [dB]} + 32.9 \text{ [dB/m]} = 37.1 \text{ [dB}\mu\text{V/m]} \text{ (71.61 } \mu\text{V/m)}$$

Equipment table:

No.	Lab / Item	Equipment	Type	Manufacturer	Serial No.	INV. No.	Kind of Calibration	Last Calibration	Next Calibration
1	A	Active Loop Antenna 9 kHz to 30 MHz	6502	EMCO	2210	300001015	k	07.07.2017	06.07.2019
2	A, B, C	Anechoic chamber	FAC 3/5m	MWB / TDK	87400/02	300000996	ev	-/-	-/-
3	B, C	Double-Ridged Waveguide Horn Antenna 1-18.0GHz	3115	EMCO	9107-3697	300001605	vKII	14.02.2017	13.02.2019
4	A, B, C	Switch / Control Unit	3488A	HP	*	300000199	ne	-/-	-/-
5	C	Band Reject filter	WRCG2400/2483- 2375/2505-50/10SS	Wainwright	11	300003351	ev	-/-	-/-
6	B, C	EMI Test Receiver 20Hz- 26,5GHz	ESU26	R&S	100037	300003555	k	20.12.2017	19.12.2018
7	C	Highpass Filter	WHK1.1/15G-10SS	Wainwright	3	300003255	ev	-/-	-/-
8	C	Highpass Filter	WHKX7.0/18G-8SS	Wainwright	19	300003790	ne	-/-	-/-
9	C	Broadband Amplifier 0.5-18 GHz	CBLU5184540	CERNEX	22049	300004481	ev	-/-	-/-
10	A, B, C	4U RF Switch Platform	L4491A	Agilent Technologies	MY50000037	300004509	ne	-/-	-/-
11	A, B, C	NEXIO EMV- Software	BAT EMC V3.16.0.49	EMCO	-/-	300004682	ne	-/-	-/-
12	A, B, C	PC	ExOne	F+W	-/-	300004703	ne	-/-	-/-

7.3 Radiated measurements > 18 GHz

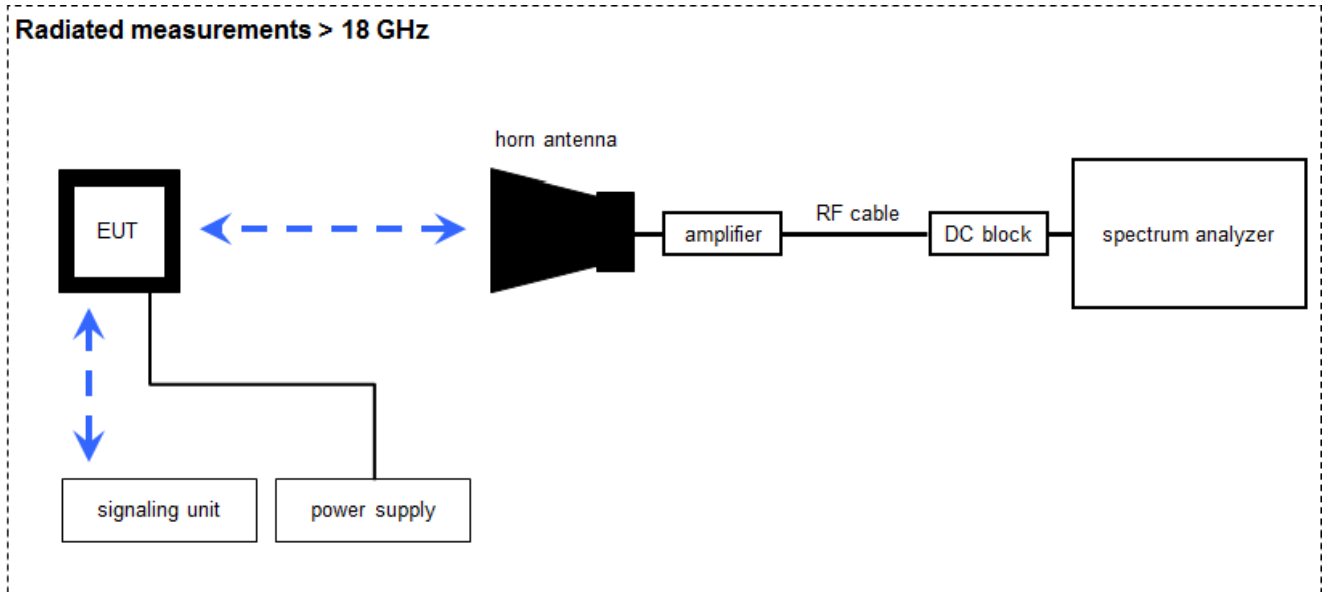

Measurement distance: horn antenna 50 cm

$$FS = UR + CA + AF$$

(FS-field strength; UR-voltage at the receiver; CA-loss signal path & distance correction; AF-antenna factor)

Example calculation:

$$FS [dB\mu V/m] = 40.0 [dB\mu V/m] + (-60.1) [dB] + 36.74 [dB/m] = 16.64 [dB\mu V/m] (6.79 \mu V/m)$$

Equipment table:

No.	Lab / Item	Equipment	Type	Manufacturer	Serial No.	INV. No.	Kind of Calibration	Last Calibration	Next Calibration
1	A	Amplifier 2-40 GHz	JS32-02004000-57-5P	MITEQ	1777200	300004541	ev	-/-	-/-
2	A	RF-Cable	ST18/SMAM/SMAM/48	Huber & Suhner	Batch no. 600918	400001182	ev	-/-	-/-
3	A	RF-Cable	ST18/SMAM/SMAM/48	Huber & Suhner	Batch no. 127377	400001183	ev	-/-	-/-
4	A	DC-Blocker 0.1-40 GHz	8141A	Inmet	-/-	400001185	ev	-/-	-/-
5	A	Std. Gain Horn Antenna 18.0-26.5 GHz	638	Narda	-/-	300000486	k	13.12.2017	12.12.2019
6	A	Signal Analyzer 40 GHz	FSV40	R&S	101042	300004517	k	16.01.2018	15.01.2019

7.4 Conducted measurements with peak power meter & spectrum analyzer

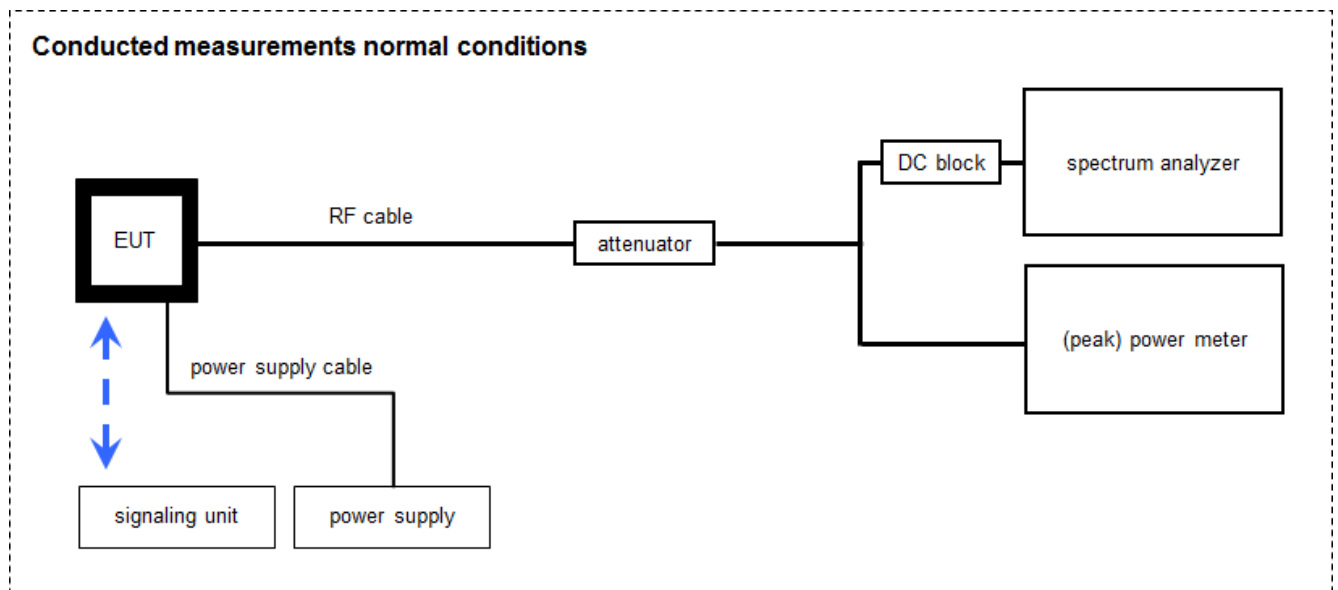

OP = AV + CA
(OP-output power; AV-analyzer value; CA-loss signal path)

Example calculation:

OP [dBm] = 6.0 [dBm] + 11.7 [dB] = 17.7 [dBm] (58.88 mW)

Equipment table:

No.	Lab / Item	Equipment	Type	Manufacturer	Serial No.	INV. No.	Kind of Calibration	Last Calibration	Next Calibration
1	A	Signal Analyzer 40 GHz	FSV40	R&S	101042	300004517	k	16.01.2018	15.01.2019
2	A+B	PC-WLAN Tester	Intel Core i3 3220/3,3 GHz, Prozessor		2V2403033A4523	300004589	ne	-/-	-/-
3	A+B	Teststand	Teststand Custom Sequence Editor	National Instruments GmbH		300004590	ne	-/-	-/-
4	A+B	PowerSplitter/Combiner 150-6000MHz N-Type	ZB3PD-63-N+	Mini-Circuits		400000451	ev	-/-	-/-
5	A+B	RF-Cable	ST18/SMAm/SMAm/60	Huber & Suhner	Batch no. 606844	400001181	ev	-/-	-/-
6	A+B	DC-Blocker 0.1-40 GHz	8141A	Inmet		400001185	ev	-/-	-/-
7	A+B	Coax Attenuator 10 dB 2W 0-40 GHz	MCL BW-K10-2W44+	Mini Circuits		400001186	ev	-/-	-/-
8	B	Power Sensor	NRP-Z81	R&S	100010	300003780	k	26.01.2017	25.01.2019

7.5 AC conducted

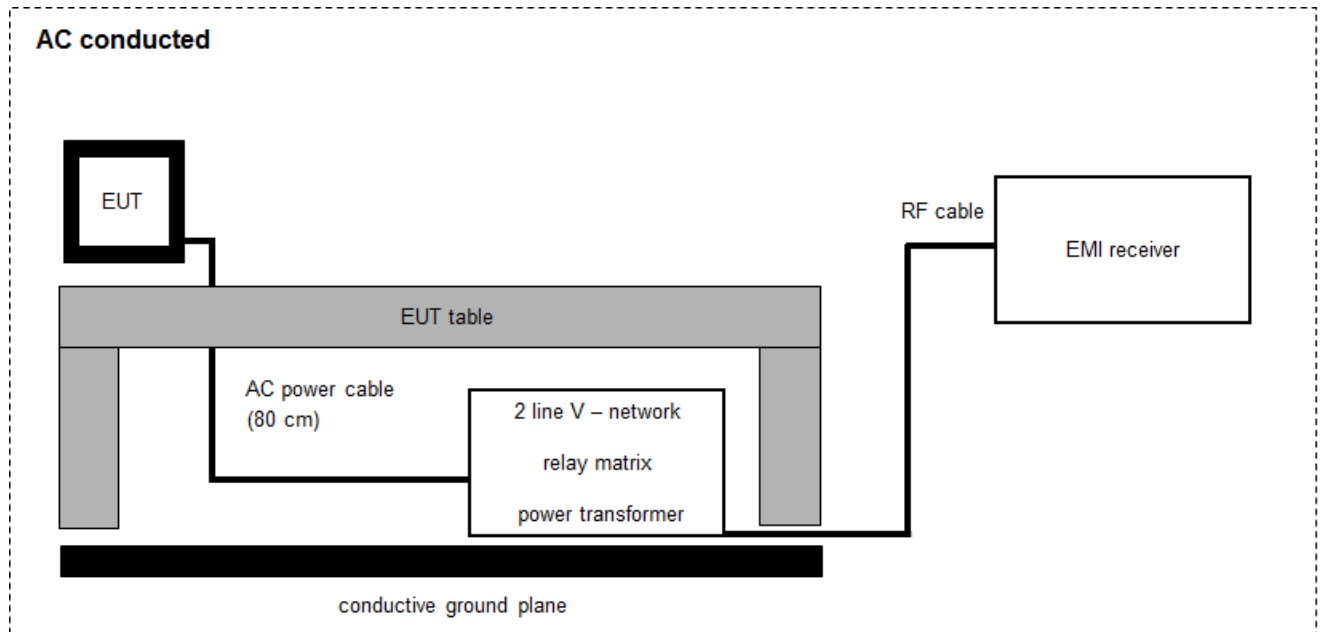

$$FS = UR + CF + VC$$

(FS-field strength; UR-voltage at the receiver; CR-loss of the cable and filter; VC-correction factor of the ISN)

Example calculation:

$$FS [dB\mu V/m] = 37.62 [dB\mu V/m] + 9.90 [dB] + 0.23 [dB] = 47.75 [dB\mu V/m] (244.06 \mu V/m)$$

Equipment table:

No.	Lab / Item	Equipment	Type	Manufacturer	Serial No.	INV. No.	Kind of Calibration	Last Calibration	Next Calibration
1	A	Two-line V-Network (LISN) 9 kHz to 30 MHz	ESH3-Z5	R&S	892475/017	300002209	k	13.12.2017	12.12.2019
2	A	RF-Filter-section	85420E	HP	3427A00162	300002214	k	-/-	-/-
3	A	AC-Spannungsquelle variabel	MV2616-V	EM-Test	0397-12	300003259	k	26.01.2018	26.01.2020
4	A	Hochpass 150 kHz	EZ-25	R&S	100010	300003798	ev	-/-	-/-
5	A	MXE EMI Receiver 20 Hz to 26,5 GHz	N9038A	Agilent Technologies	MY51210197	300004405	k	18.12.2017	17.12.2018

8 Measurement uncertainty

Measurement uncertainty	
Test case	Uncertainty
Antenna gain	± 3 dB
Power spectral density	± 1.5 dB
DTS bandwidth	± 100 kHz (depends on the used RBW)
Occupied bandwidth	± 100 kHz (depends on the used RBW)
Maximum output power	± 1.5 dB
Detailed spurious emissions @ the band edge - conducted	± 1.5 dB
Band edge compliance radiated	± 3 dB
Spurious emissions conducted	± 3 dB
Spurious emissions radiated below 30 MHz	± 3 dB
Spurious emissions radiated 30 MHz to 1 GHz	± 3 dB
Spurious emissions radiated 1 GHz to 12.75 GHz	± 3.7 dB
Spurious emissions radiated above 12.75 GHz	± 4.5 dB
Spurious emissions conducted below 30 MHz (AC conducted)	± 2.6 dB

9 Summary of measurement results

<input checked="" type="checkbox"/>	No deviations from the technical specifications were ascertained
<input type="checkbox"/>	There were deviations from the technical specifications ascertained
<input type="checkbox"/>	This test report is only a partial test report. The content and verdict of the performed test cases are listed below.

TC Identifier	Description			Verdict	Date				Remark	
RF-Testing	CFR Part 15 RSS - 247, Issue 2			See table!	2018-04-09				-/-	
Test specification clause	Test case	Guideline	Temperature conditions	Power source voltages	Mode	C	NC	NA	NP	Remark
§15.247(b)(4) RSS - 247 / 5.4 (f)(ii)	Antenna gain	-/-	Nominal	Nominal	DSSS	-/-				-/-
§15.35	Duty cycle	-/-	Nominal	Nominal	DSSS OFDM	-/-				-/-
§15.247(e) RSS - 247 / 5.2 (b)	Power spectral density	KDB 558074 DTS clause: 10.2	Nominal	Nominal	DSSS OFDM	<input checked="" type="checkbox"/>	<input type="checkbox"/>	<input type="checkbox"/>	<input type="checkbox"/>	-/-
§15.247(a)(2) RSS - 247 / 5.2 (a)	DTS bandwidth	KDB 558074 DTS clause: 8.1	Nominal	Nominal	DSSS OFDM	<input checked="" type="checkbox"/>	<input type="checkbox"/>	<input type="checkbox"/>	<input type="checkbox"/>	-/-
RSS Gen clause 4.6.1	Occupied bandwidth	-/-	Nominal	Nominal	DSSS OFDM	<input checked="" type="checkbox"/>	<input type="checkbox"/>	<input type="checkbox"/>	<input type="checkbox"/>	-/-
§15.247(b)(3) RSS - 247 / 5.4 (d)	Maximum output power	KDB 558074 DTS clause: 9.1.2	Nominal	Nominal	DSSS OFDM	<input checked="" type="checkbox"/>	<input type="checkbox"/>	<input type="checkbox"/>	<input type="checkbox"/>	-/-
§15.247(d) RSS - 247 / 5.5	Detailed spurious emissions @ the band edge – cond.	-/-	Nominal	Nominal	DSSS OFDM	<input checked="" type="checkbox"/>	<input type="checkbox"/>	<input type="checkbox"/>	<input type="checkbox"/>	-/-
§15.205 RSS - 247 / 5.5 RSS - Gen	Band edge compliance cond. & rad.	KDB 558074 DTS clause: 13.3.2 and clause 12.2.2	Nominal	Nominal	DSSS OFDM	<input checked="" type="checkbox"/>	<input type="checkbox"/>	<input type="checkbox"/>	<input type="checkbox"/>	-/-
§15.247(d) RSS - 247 / 5.5	TX spurious emissions cond.	KDB 558074 DTS clause: 11.1 & 11.2 11.3	Nominal	Nominal	DSSS OFDM	<input checked="" type="checkbox"/>	<input type="checkbox"/>	<input type="checkbox"/>	<input type="checkbox"/>	-/-
§15.209(a) RSS-Gen	TX spurious emissions rad. below 30 MHz	-/-	Nominal	Nominal	DSSS OFDM	<input checked="" type="checkbox"/>	<input type="checkbox"/>	<input type="checkbox"/>	<input type="checkbox"/>	-/-
§15.247(d) RSS - 247 / 5.5 RSS-Gen	TX spurious emissions rad. 30 MHz to 1 GHz	-/-	Nominal	Nominal	DSSS OFDM	<input checked="" type="checkbox"/>	<input type="checkbox"/>	<input type="checkbox"/>	<input type="checkbox"/>	-/-
§15.247(d) RSS - 247 / 5.5 RSS-Gen	TX spurious emissions rad. above 1 GHz	-/-	Nominal	Nominal	DSSS OFDM	<input checked="" type="checkbox"/>	<input type="checkbox"/>	<input type="checkbox"/>	<input type="checkbox"/>	-/-
§15.109 RSS-Gen	RX spurious emissions rad. 30 MHz to 1 GHz	-/-	Nominal	Nominal	RX / idle	<input checked="" type="checkbox"/>	<input type="checkbox"/>	<input type="checkbox"/>	<input type="checkbox"/>	-/-
§15.109 RSS-Gen	RX spurious emissions rad. above 1 GHz	-/-	Nominal	Nominal	RX / idle	<input checked="" type="checkbox"/>	<input type="checkbox"/>	<input type="checkbox"/>	<input type="checkbox"/>	-/-
§15.107(a) §15.207	Conducted emissions < 30 MHz	-/-	Nominal	Nominal	DSSS OFDM	<input checked="" type="checkbox"/>	<input type="checkbox"/>	<input type="checkbox"/>	<input type="checkbox"/>	-/-

Notes:

C	Compliant	NC	Not compliant	NA	Not applicable	NP	Not performed
----------	-----------	-----------	---------------	-----------	----------------	-----------	---------------

10 Additional comments

- Reference documents: Testprocedure_2 0_QTP SRM.pdf
Customer Questionnaire Benchmark_051217_JV.docx
Test report no 1-3919_17-01-11
- Special test descriptions: None
- Configuration descriptions: Transmitter test modes were set with chip manufacturer test software provided by the customer:

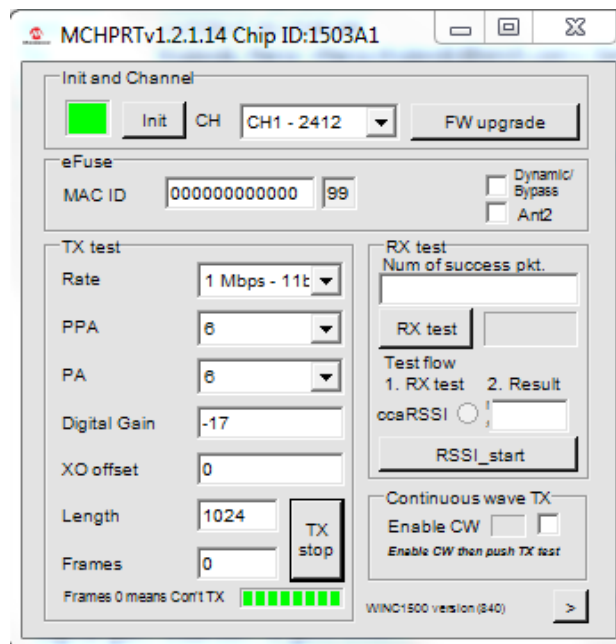

Worst case configuration with regards to each individual test case (Modulation and data rate) are declared by the manufacturer:

Tests cases	Modulation/Rate	PPA	PA	Digital Gain
Transmitter tests	b-mode	6	6	-17
	g-mode	6	6	-14
	n HT20-mode	6	6	-14
Receiver tests	Rx test mode			

Provided channels:

Channels with 20 MHz channel bandwidth:

channel number & centre frequency													
channel	1	2	3	4	5	6	7	8	9	10	11	12	13
f _c / MHz	2412	2417	2422	2427	2432	2437	2442	2447	2452	2457	2462	2467	2472

11 Additional EUT parameter

- Test mode:
- No test mode available
Iperf was used to ping another device with the largest support packet size
 - Test mode available
Special software is used.
EUT is transmitting pseudo random data by itself
- Modulation types:
- Wide Band Modulation (None Hopping – e.g. DSSS, OFDM)
 - Frequency Hopping Spread Spectrum (FHSS)
- Antennas and transmit operating modes:
- Operating mode 1 (single antenna)
 - *Equipment with 1 antenna.*
 - *Equipment with 2 diversity antennas operating in switched diversity mode by which at any moment in time only 1 antenna is used,*
 - *Smart antenna system with 2 or more transmit/receive chains, but operating in a mode where only 1 transmit/receive chain is used)*
 - Operating mode 2 (multiple antennas, no beamforming)
 - *Equipment operating in this mode contains a smart antenna system using two or more transmit/receive chains simultaneously but without beamforming.*
 - Operating mode 3 (multiple antennas, with beamforming)
 - *Equipment operating in this mode contains a smart antenna system using two or more transmit/receive chains simultaneously with beamforming.
In addition to the antenna assembly gain (G), the beamforming gain (Y) may have to be taken into account when performing the measurements.*

12 Measurement results

12.1 Antenna gain

Description:

The antenna gain of the complete system is calculated by the difference of radiated power (@ 3 MHz) in EIRP and the conducted power (@ 3 MHz) of the module.

Measurement:

Measurement parameter	
Detector	Peak
Sweep time	Auto
Resolution bandwidth	3 MHz
Video bandwidth	3 MHz
Trace mode	Max hold
Test setup	See chapter 7.4 A (conducted) See chapter 7.2 B(radiated)
Measurement uncertainty	See chapter 8

Limits:

FCC	IC
6 dBi / > 6 dBi output power and power density reduction required	

Results:

	lowest channel	middle channel	highest channel
Conducted power / dBm Measured with DSSS modulation	0.8	0.9	1.1
Radiated power / dBm Measured with DSSS modulation	1.0	0.1	1.3
Gain / dBi Calculated	0.2	-0.8	0.2

Plots: DSSS / b – mode

Plot 1: Lowest channel

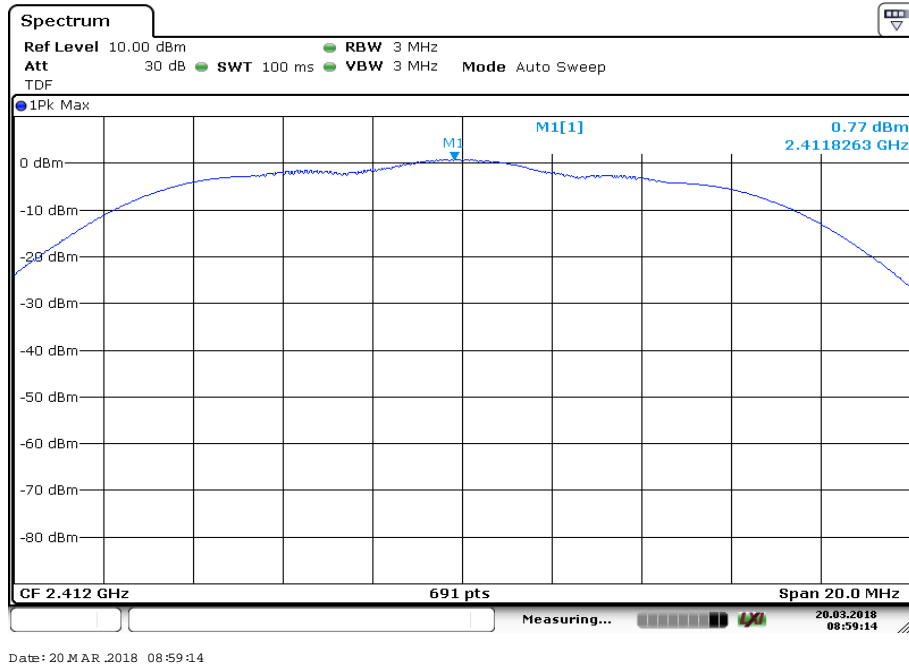

Plot 2: Middle channel

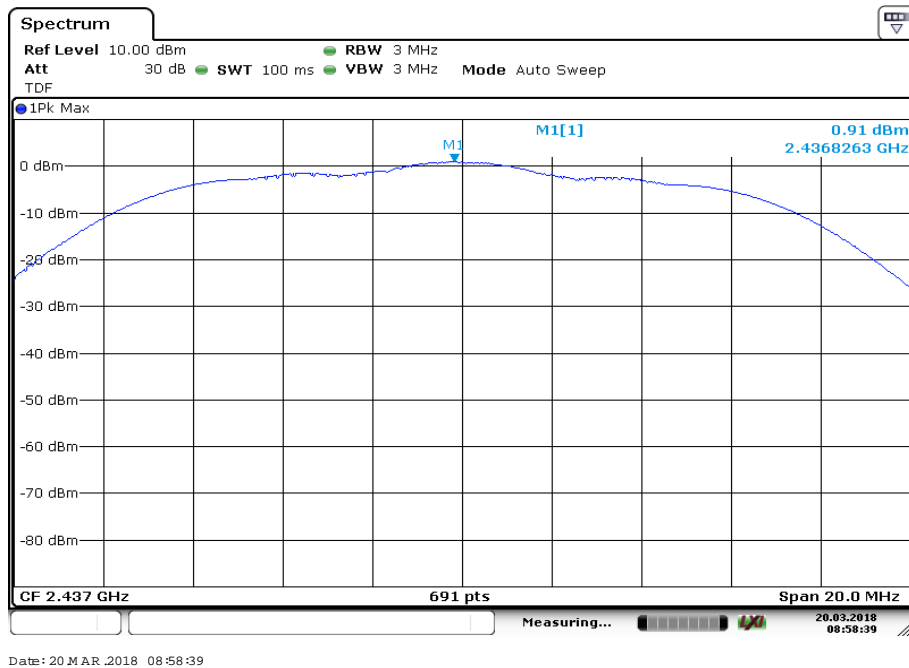

Plot 3: Highest channel

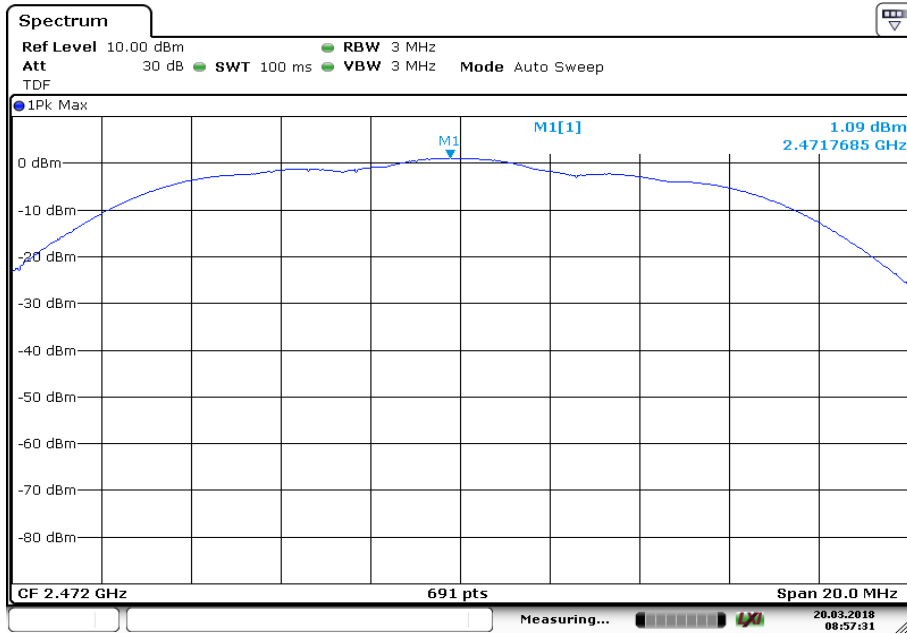

Date: 20 MAR 2018 08:57:32

12.2 Identify worst case data rate

Description:

All modes of the module will be measured with an average power meter or spectrum analyzer to identify the maximum transmission power.

In further tests only the identified worst case modulation scheme or bandwidth will be measured and this mode is used as representative mode for all other modulation schemes.

Results: Extracted from test report no 1-3919_17-01-11

b – mode		maximum average conducted output power [dBm]			
Band	Ch	1Mbps	2Mbps	5.5Mbps	11Mbps
2450MHz	1	0.9	0.9	0.8	0.7
	6	1.0	0.9	0.8	0.7
	11	0.9	0.8	0.8	0.7
	13	0.9	0.8	0.8	0.6

g – mode		maximum average conducted output power [dBm]							
Band	Ch	6Mbps	9Mbps	12Mbps	18Mbps	24Mbps	36Mbps	48Mbps	54Mbps
2450MHz	1	0.8	0.8	0.8	0.8	0.8	0.7	0.7	0.7
	6	0.8	0.8	0.8	0.8	0.8	0.7	0.7	0.7
	13	0.8	0.8	0.8	0.8	0.8	0.7	0.7	0.7

n HT20 – mode		maximum average conducted output power [dBm]							
Band	Ch	MCS-0 6.5Mbps	MCS-1 13Mbps	MCS-2 19.5Mbps	MCS-3 26Mbps	MCS-4 39Mbps	MCS-5 52Mbps	MCS-6 58.5Mbps	MCS-7 65Mbps
2450MHz	1	0.8	0.8	0.8	0.8	0.8	0.7	0.7	0.7
	6	0.8	0.8	0.8	0.8	0.8	0.7	0.7	0.7
	13	0.8	0.8	0.8	0.8	0.8	0.7	0.7	0.7

Worst case data rates:

Modulation scheme / bandwidth	
DSSS / b – mode	1 Mbit/s
OFDM / g – mode	6 Mbit/s
OFDM / n HT20 – mode	MCS0

12.3 Maximum output power

Description:

Measurement of the maximum conducted peak output power. The measurements are performed using the data rate identified in the previous chapter.

Measurement:

Measurement parameter	
According to DTS clause: 9.1.2	
Peak power meter	
Test setup	See chapter 7.4 B
Measurement uncertainty	See chapter 8

Limits:

FCC	IC
Conducted 1.0 W / 30 dBm with an antenna gain of max. 6 dBi	

Results:

	maximum output power / dBm		
	lowest channel	middle channel	highest channel
Output power conducted DSSS / b – mode	5.0	5.0	4.7
Output power conducted OFDM / g – mode	10.9	10.9	10.5
Output power conducted OFDM / n HT20 – mode	11.2	11.2	10.8

12.4 Duty cycle

Description:

Measurement of the timing behavior.

Measurement:

Measurement parameter	
Detector	Peak
Sweep time	Depends on the signal see plot
Resolution bandwidth	10 MHz
Video bandwidth	10 MHz
Trace mode	Max hold
Test setup	See chapter 7.4 A
Measurement uncertainty	See chapter 8

Limits:

FCC	IC
No limitation!	

Results:

T_{nom}	V_{nom}	lowest channel	middle channel	highest channel
DSSS / b – mode		99.9 % / 0.01 dB	99.7 % / 0.01 dB	99.7 % / 0.01 dB
OFDM / g – mode		97.9 % / 0.09 dB	97.2 % / 0.12 dB	97.9 % / 0.09 dB
OFDM / n HT20 – mode		96.7 % / 0.14 dB	97.5 % / 0.11 dB	96.7 % / 0.15 dB

Plots: DSSS / b – mode

Plot 1: Lowest channel

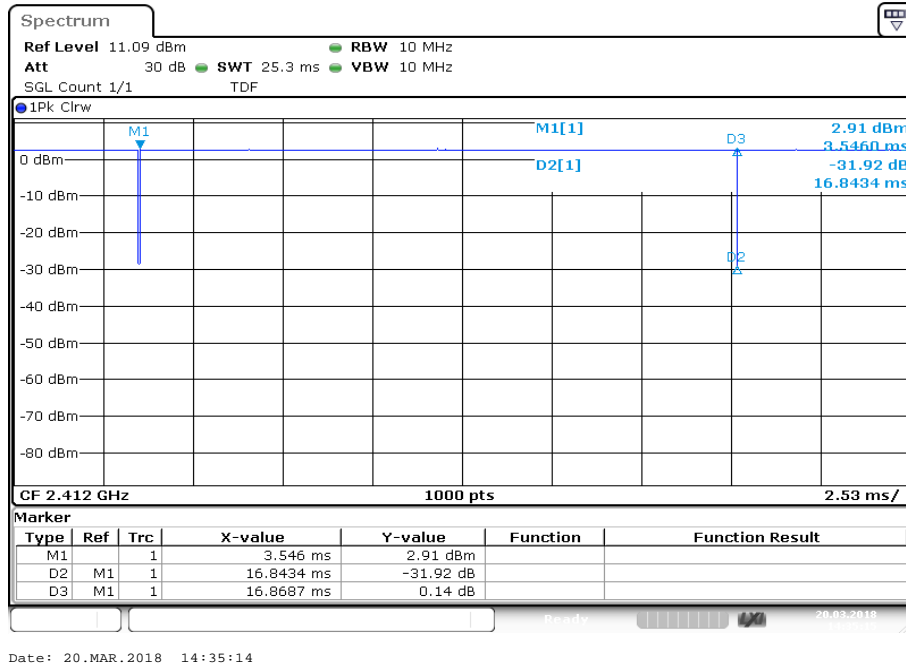

Plot 2: Middle channel

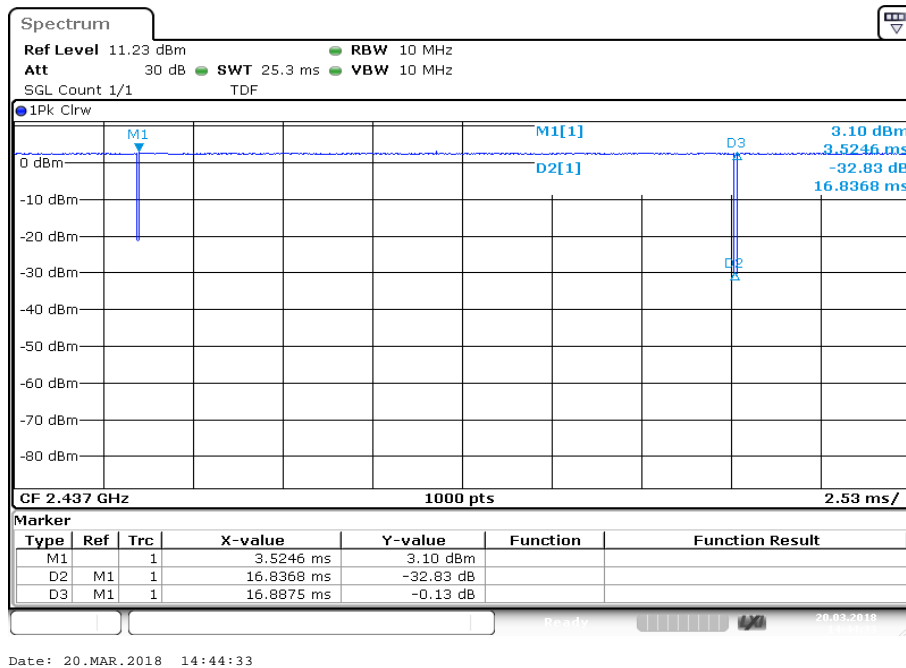

Plot 3: Highest channel

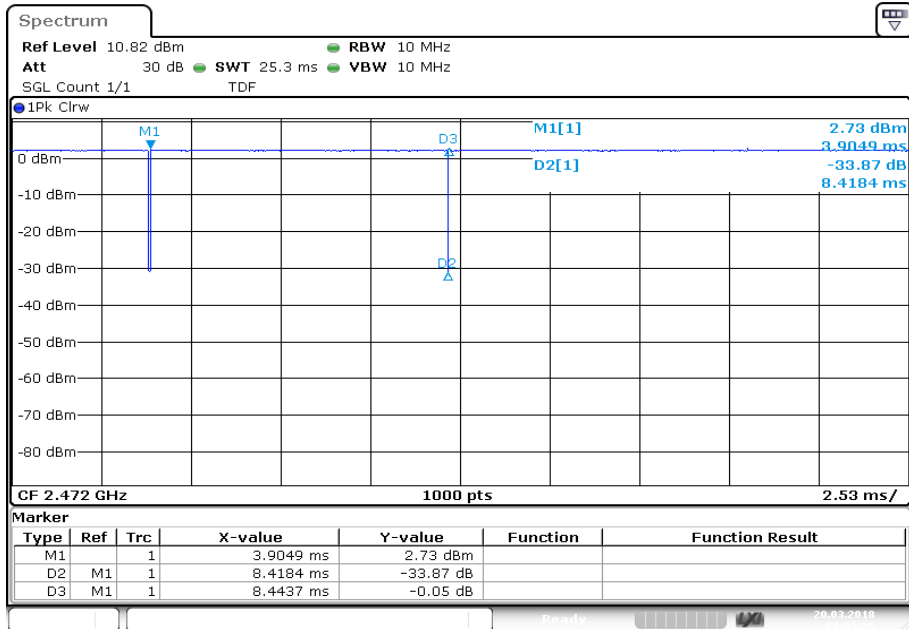

Date: 20.MAR.2018 14:53:25

Plots: OFDM / g – mode

Plot 1: Lowest channel

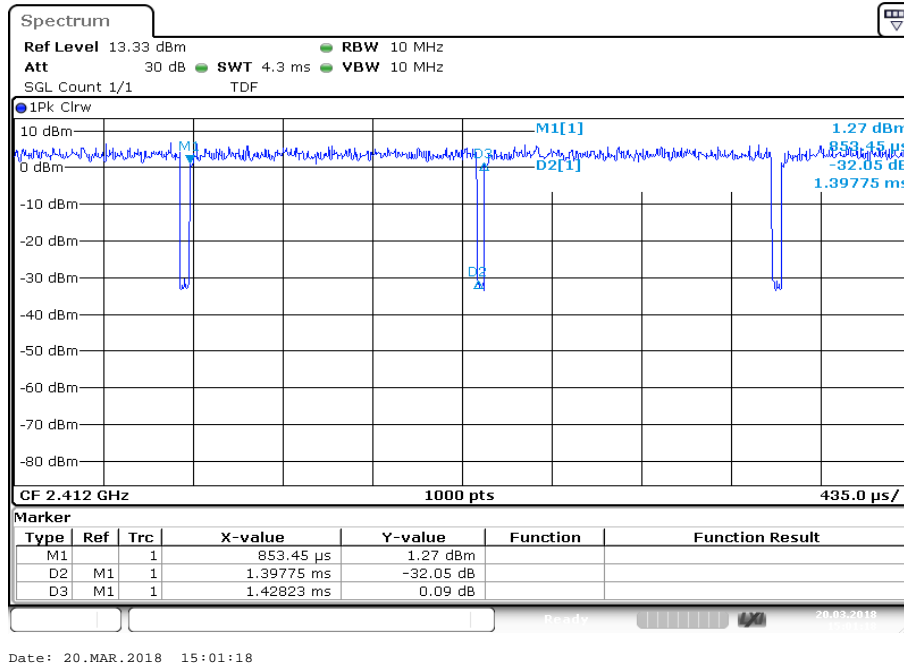

Plot 2: Middle channel

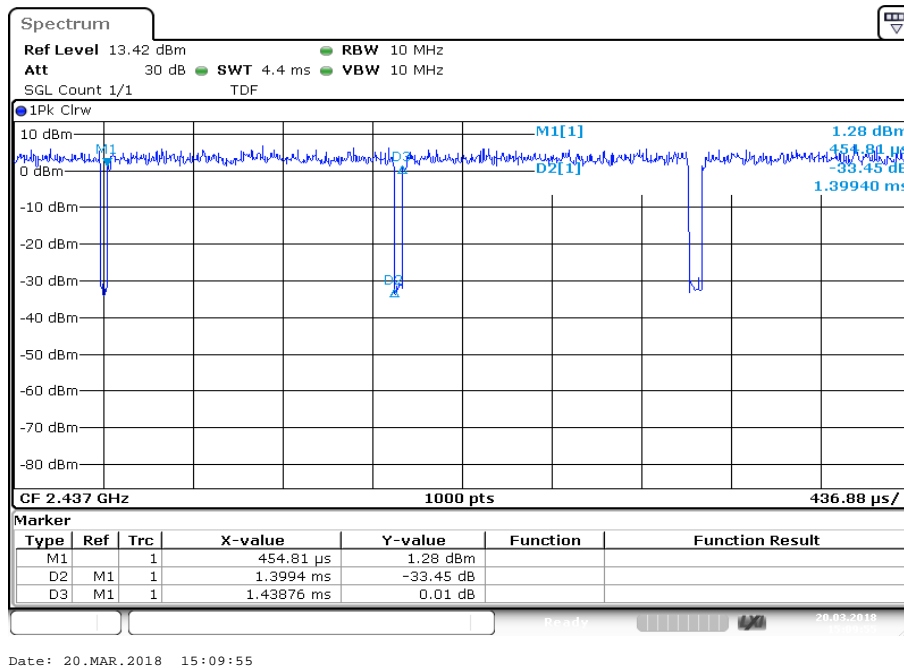

Plot 3: Highest channel

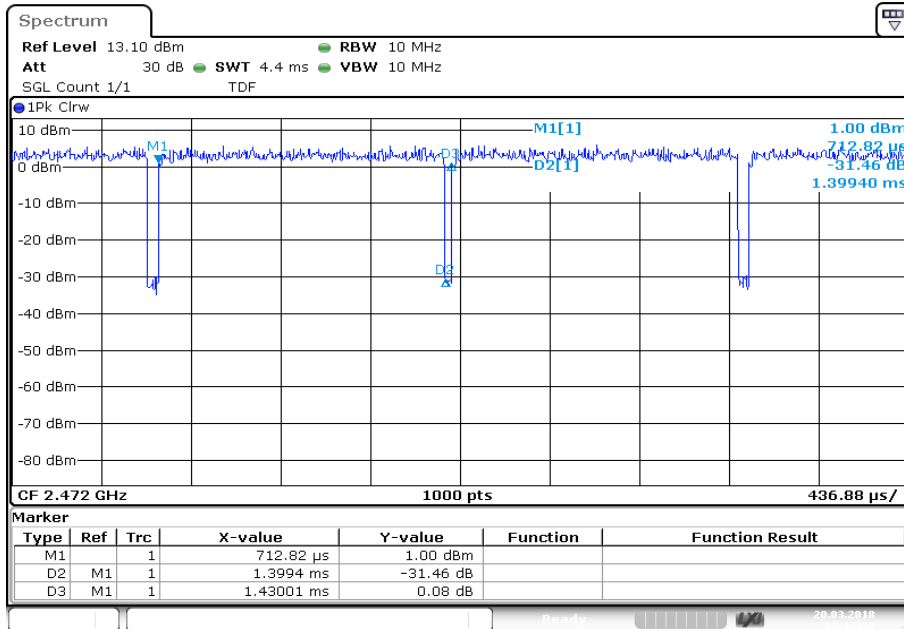

Date: 20.MAR.2018 15:16:38

Plots: OFDM / n HT20 – mode

Plot 1: Lowest channel

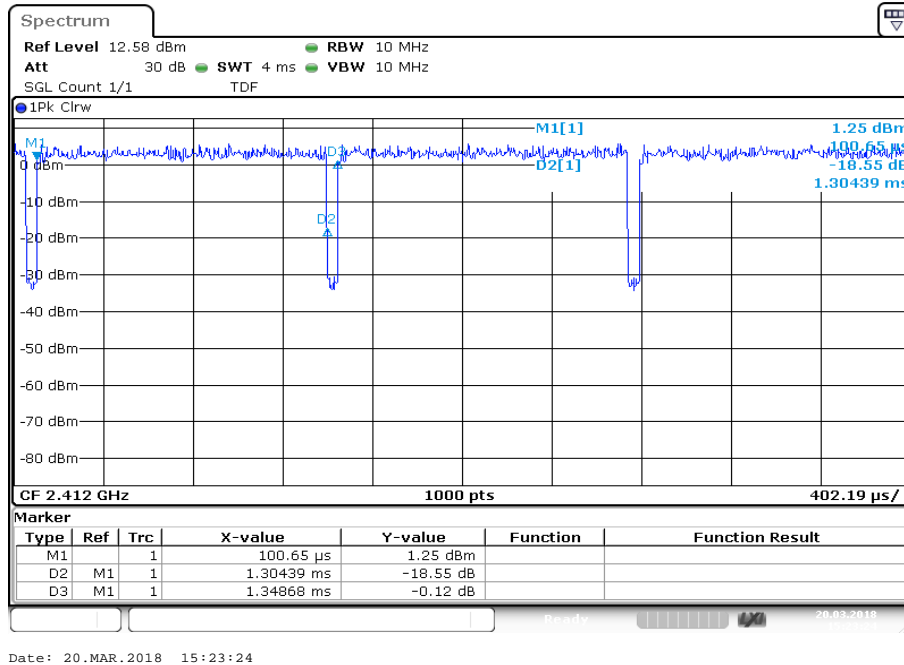

Plot 2: Middle channel

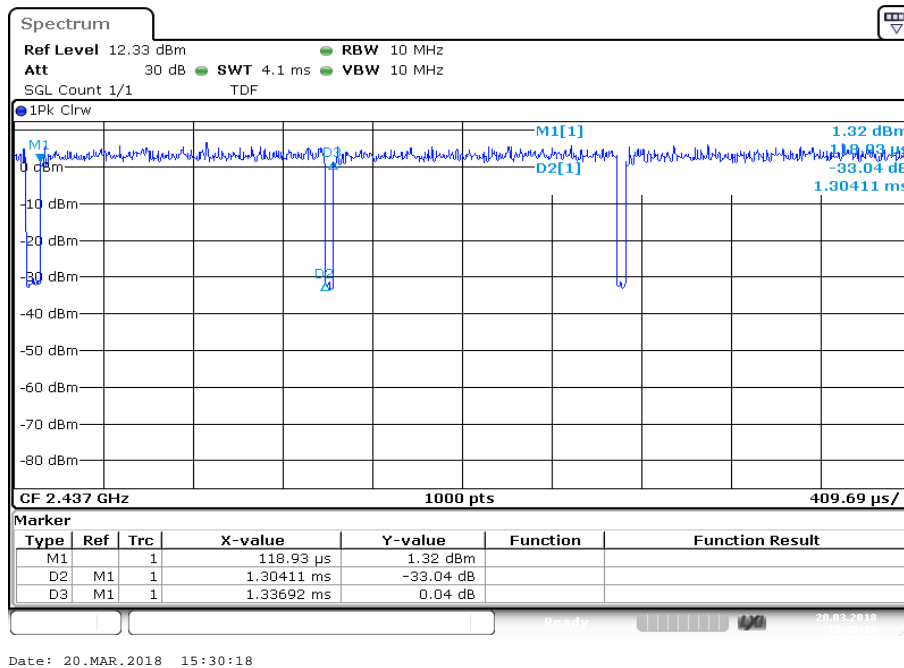

Plot 3: Highest channel

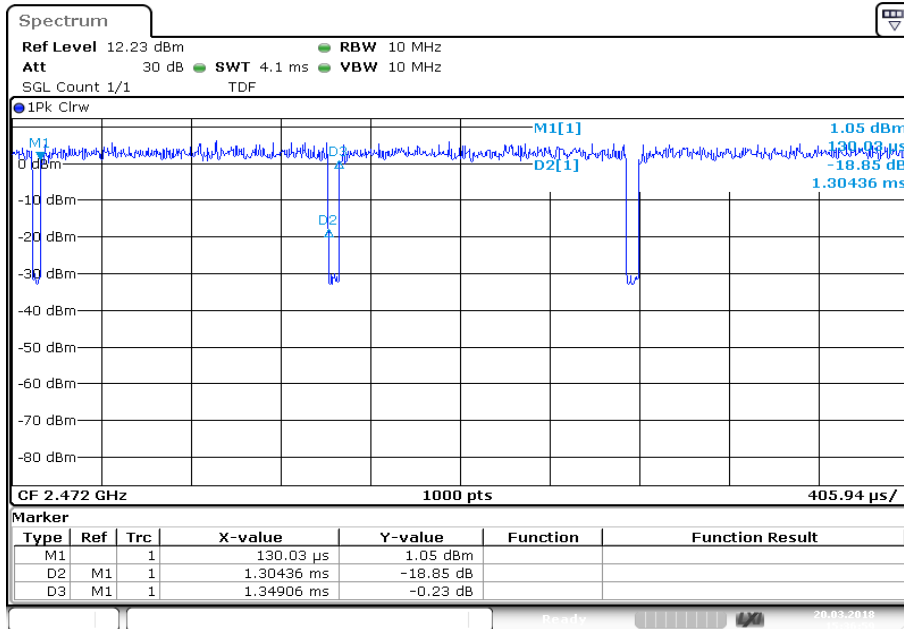

Date: 20.MAR.2018 15:36:59

12.5 Peak power spectral density

Description:

Measurement of the peak power spectral density of a digital modulated system. The PSD shows the strength of the variations as a function of the frequency. The measurement is repeated for both modulations at the lowest, middle and highest channel.

Measurement:

Measurement parameter	
According to DTS clause: 10.2	
Detector	Positive Peak
Sweep time	Auto
Resolution bandwidth	100 kHz
Video bandwidth	300 kHz
Span	30 MHz
Trace mode	Max. hold (allow trace to fully stabilize)
Test setup	See chapter 7.4 A
Measurement uncertainty	See chapter 8

Limits:

FCC	IC
8 dBm / 3 kHz (conducted)	
8 dBm / 100 kHz (conducted)	

Results:

	peak power spectral density / dBm @ 100 kHz		
	Lowest channel	Middle channel	Highest channel
DSSS / b – mode	-10.3	-10.6	-10.9
OFDM / g – mode	-11.7	-11.6	-12.0
OFDM / n HT20 – mode	-11.8	-11.6	-12.5

Plots: DSSS / b – mode

Plot 1: Lowest channel

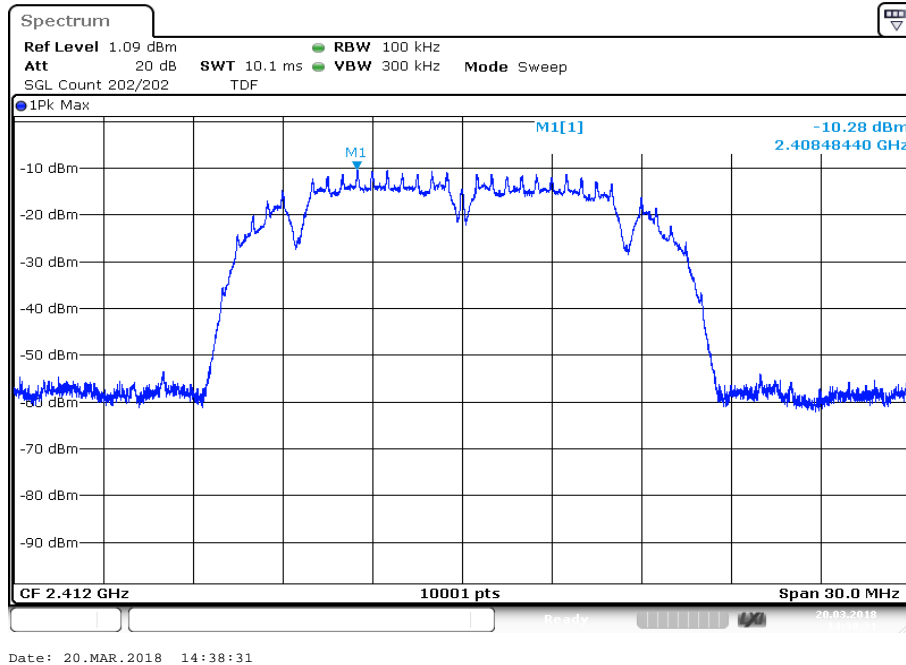

Plot 2: Middle channel

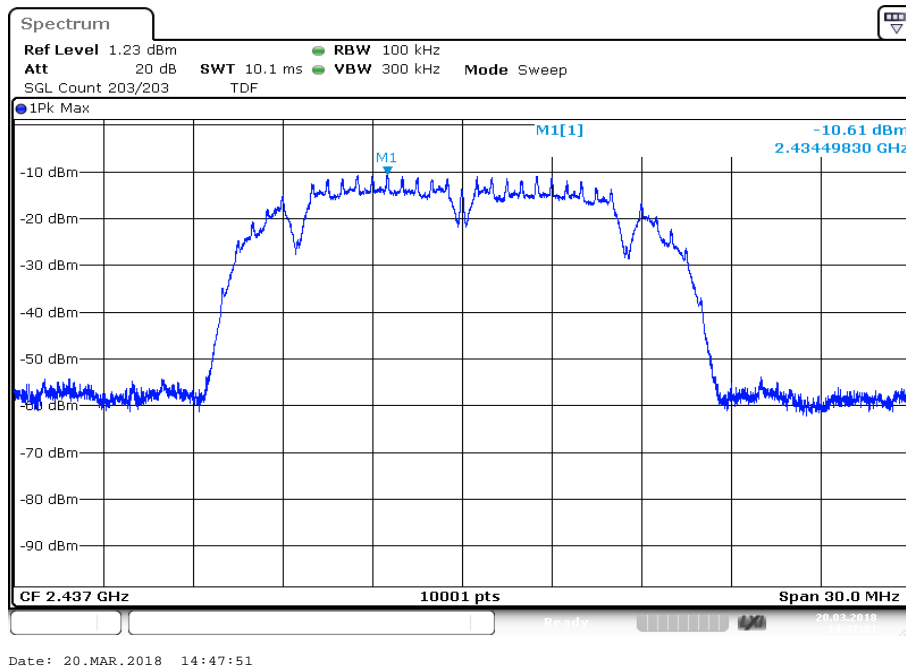

Plot 3: Highest channel

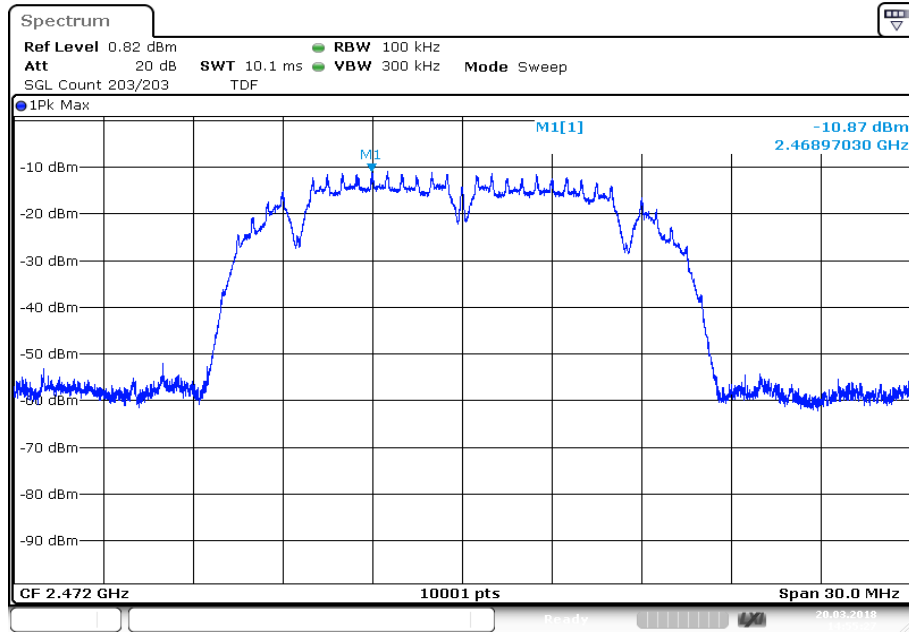

Date: 20.MAR.2018 14:55:27

Plots: OFDM / g – mode

Plot 1: Lowest channel

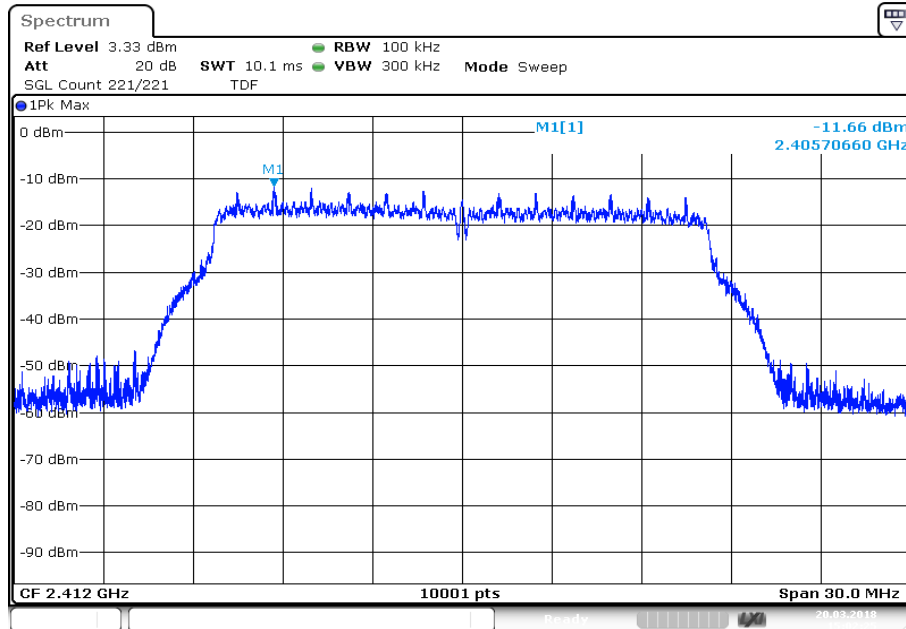

Plot 2: Middle channel

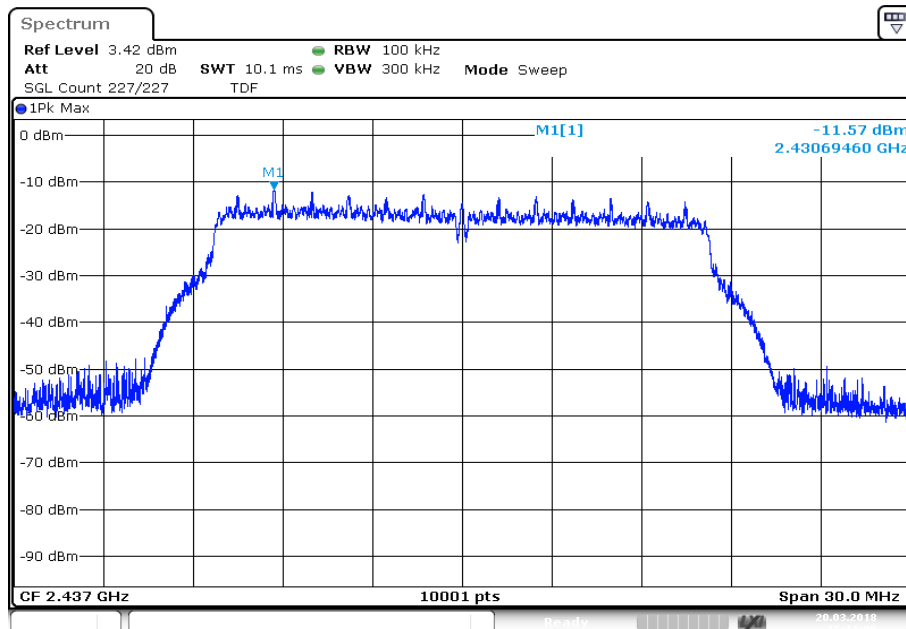

Plot 3: Highest channel

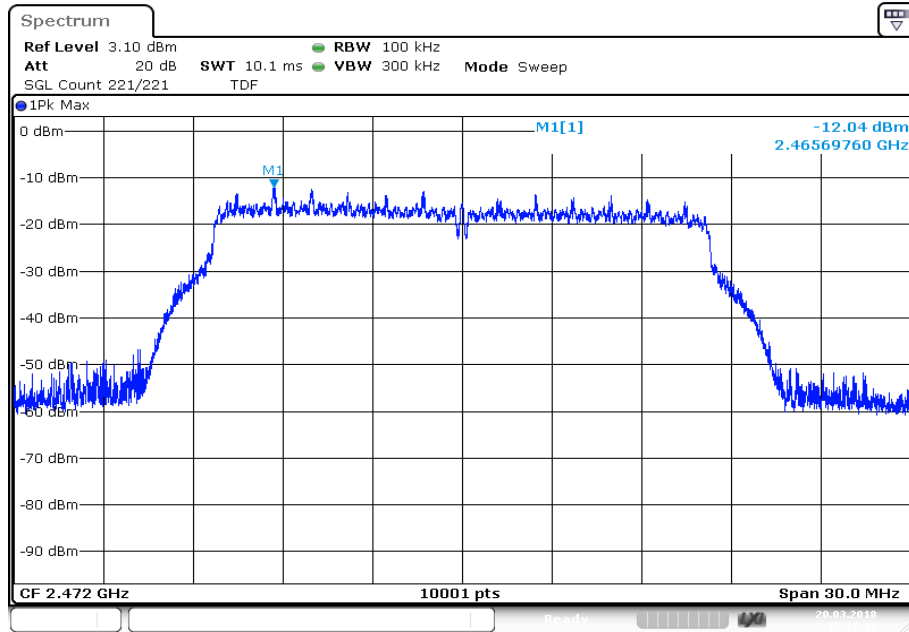

Date: 20.MAR.2018 15:17:49

Plots: OFDM / n HT20 – mode

Plot 1: Lowest channel

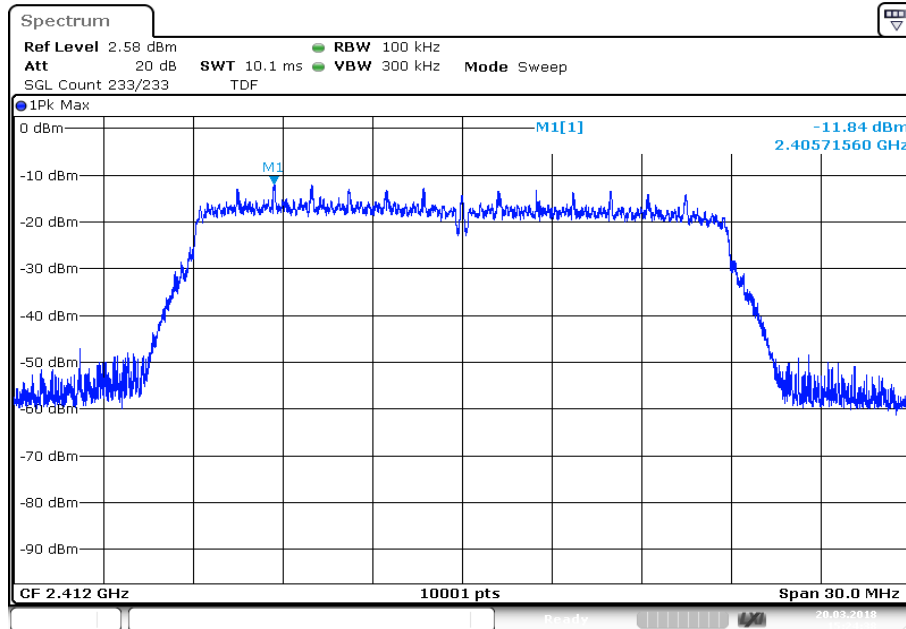

Plot 2: Middle channel

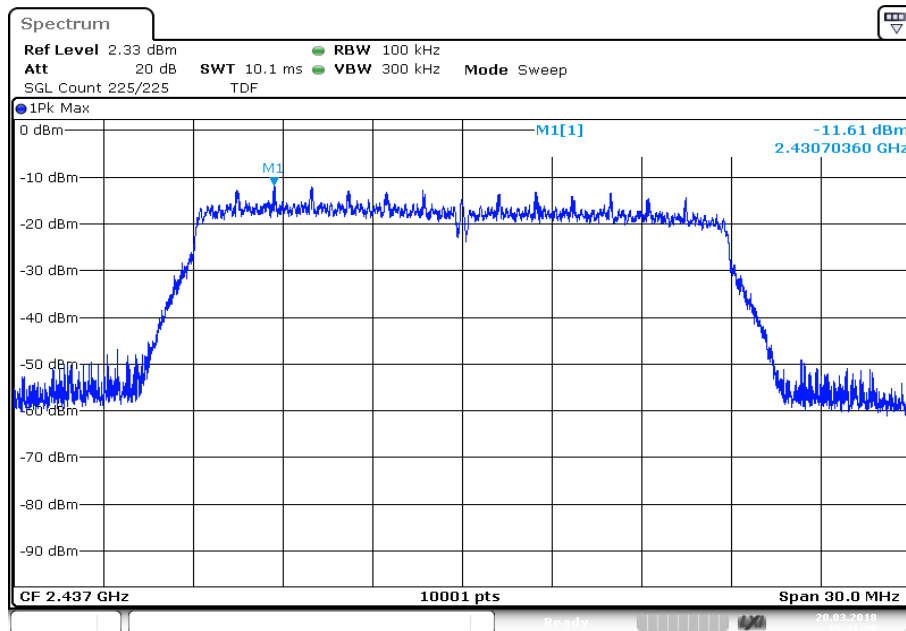

Plot 3: Highest channel

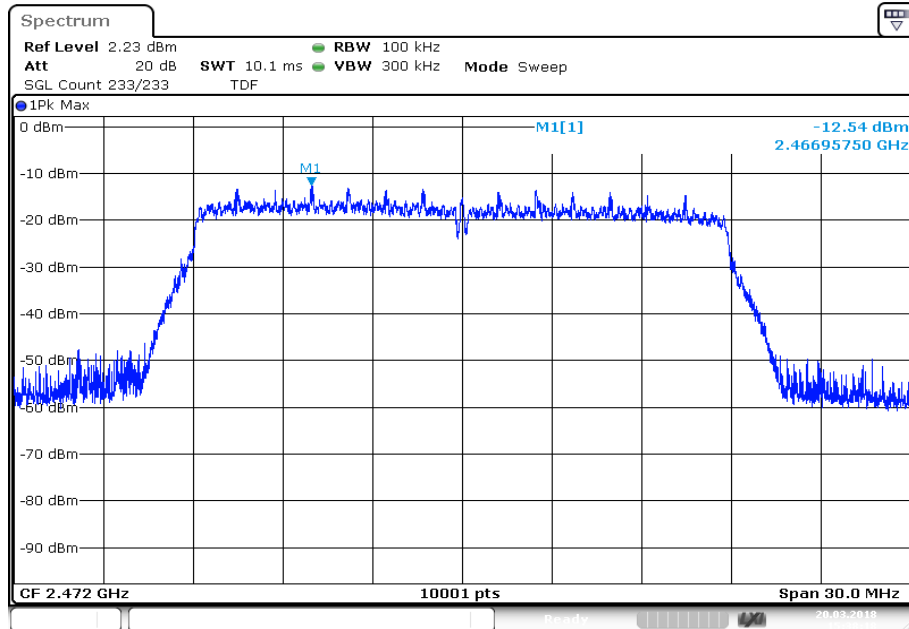

Date: 20.MAR.2018 15:38:18

12.6 6 dB DTS bandwidth

Description:

Measurement of the 6 dB bandwidth of the modulated signal.

Measurement:

Measurement parameter	
According to DTS clause: 8.1	
Detector	Peak
Sweep time	Auto
Resolution bandwidth	100 kHz
Video bandwidth	500 kHz
Span	30 MHz / 50 MHz
Trace mode	Single count with 200 counts
Test setup	See chapter 7.4 A
Measurement uncertainty	See chapter 8

Limits:

FCC	IC
Systems using digital modulation techniques may operate in the 2400–2483.5 MHz band. The minimum 6 dB bandwidth shall be at least 500 kHz.	

Results:

	6 dB DTS bandwidth / kHz		
	lowest channel	middle channel	highest channel
DSSS / b – mode	12065	12062	12032
OFDM / g – mode	16067	16048	16072
OFDM / n HT20 – mode	16696	16681	16921

Plots: DSSS / b – mode

Plot 1: Lowest channel

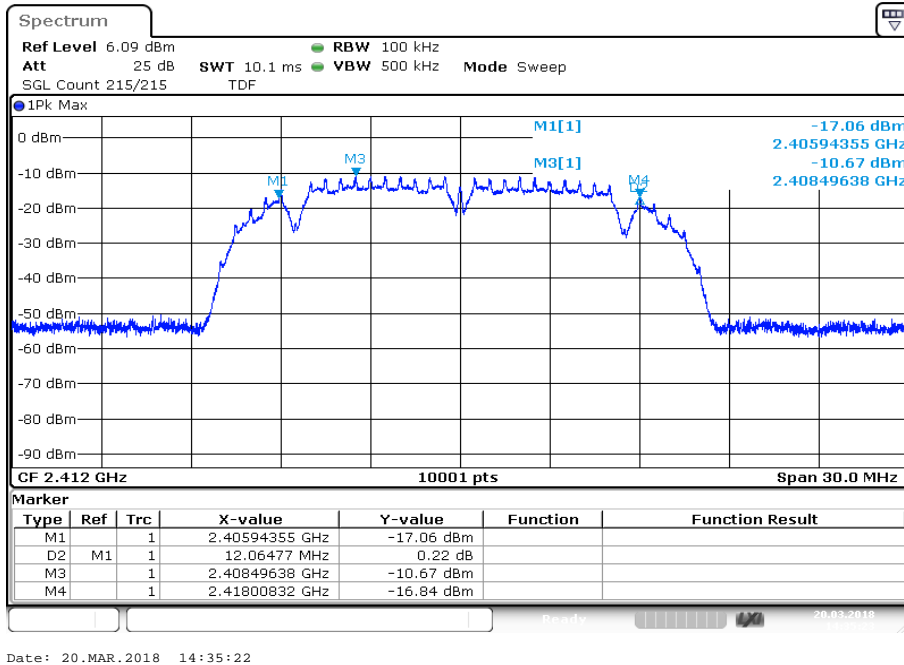

Plot 2: Middle channel

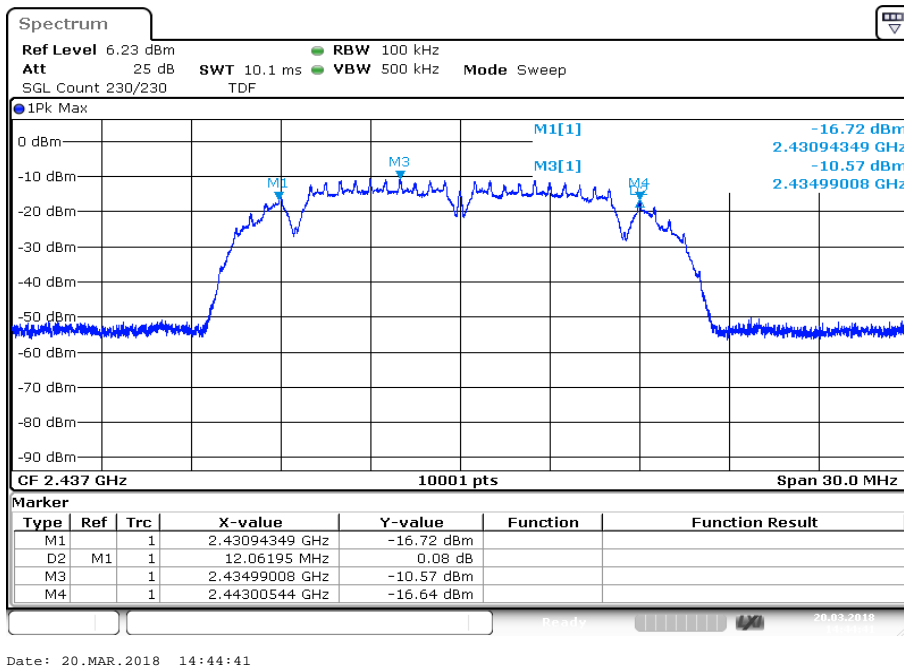

Plot 3: Highest channel

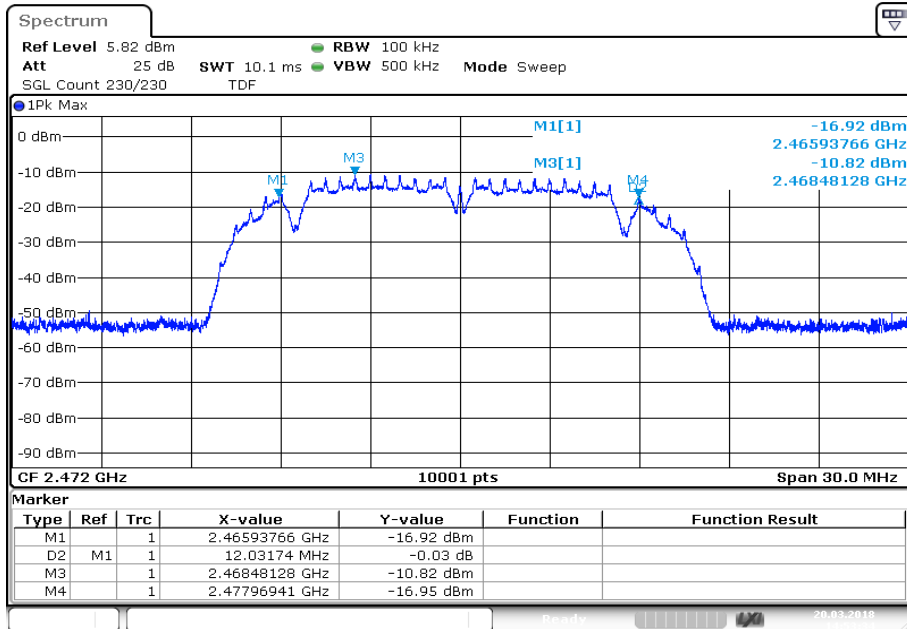

Date: 20.MAR.2018 14:53:34

Plots: OFDM / g – mode

Plot 1: Lowest channel

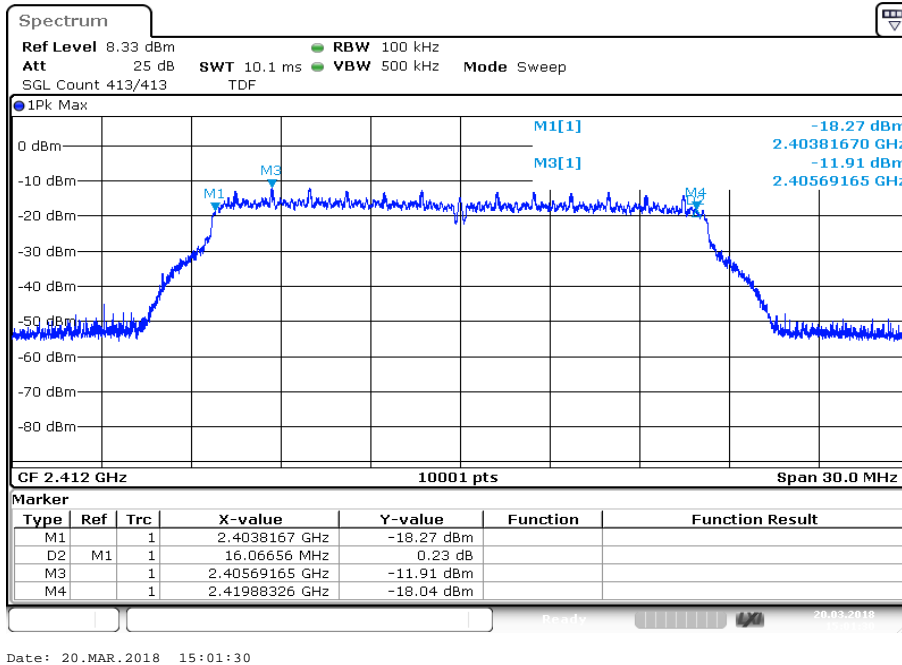

Plot 2: Middle channel

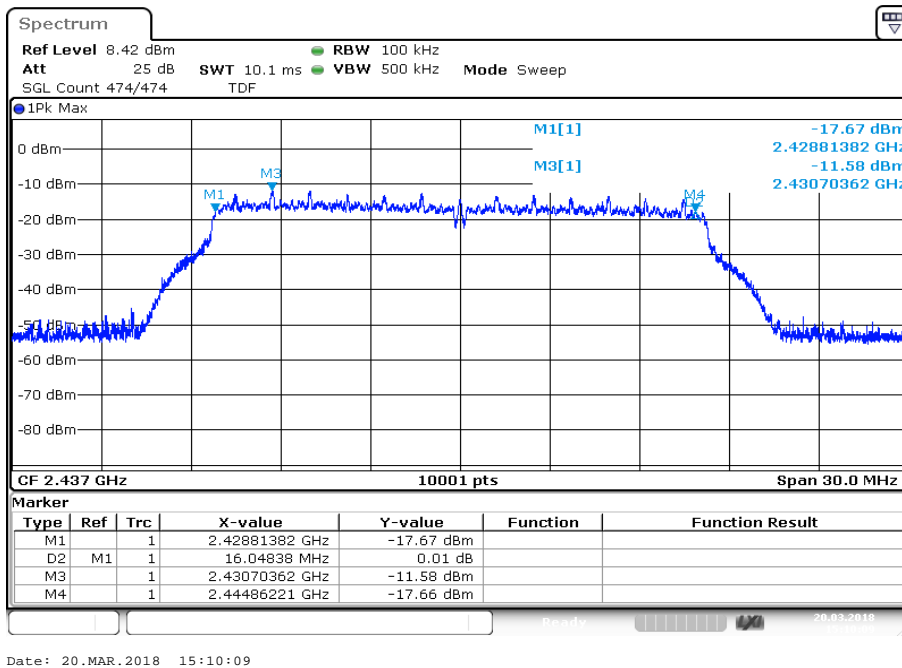

Plot 3: Highest channel

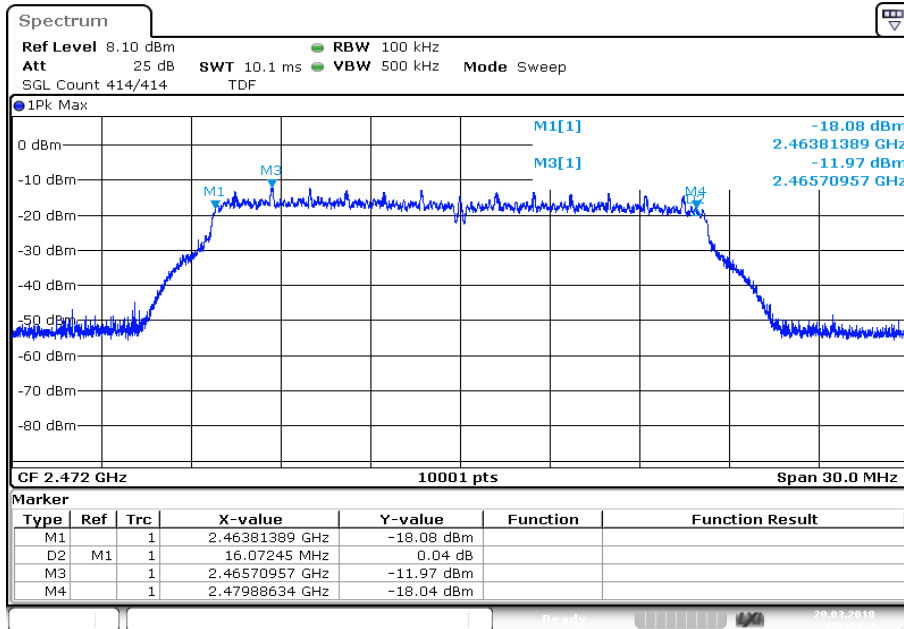

Plots: OFDM / n HT20 – mode

Plot 1: Lowest channel

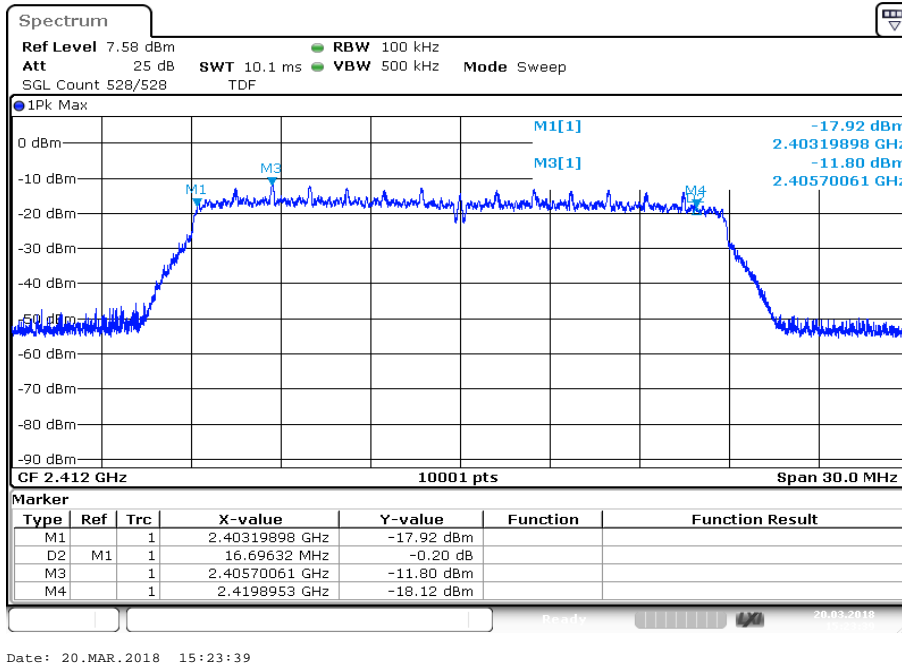

Plot 2: Middle channel

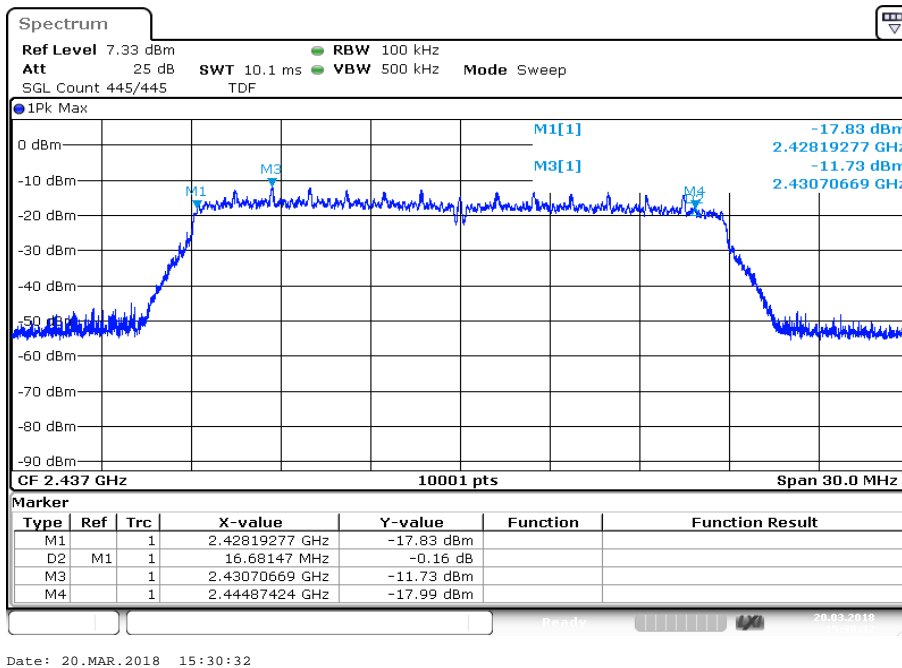

Plot 3: Highest channel

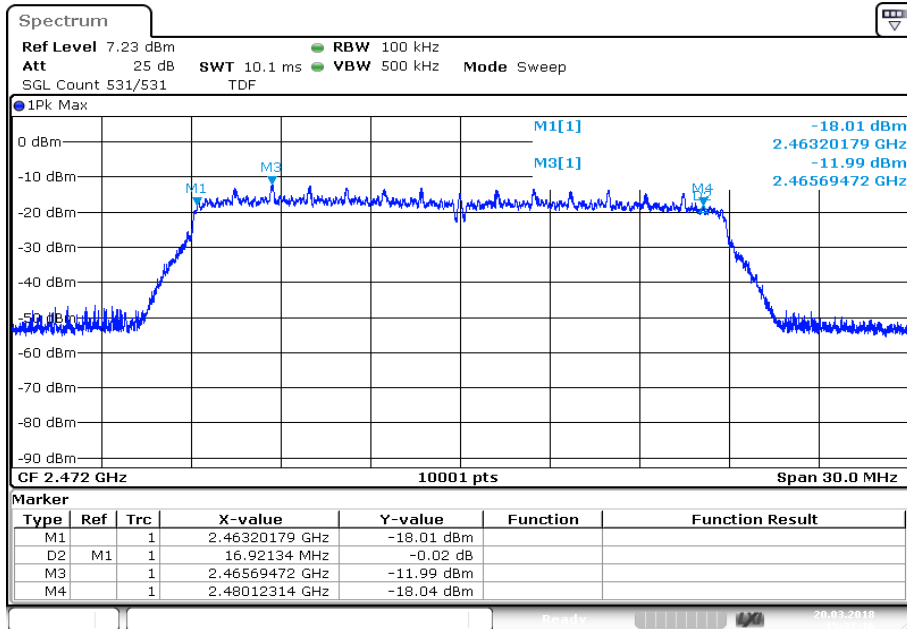

Date: 20.MAR.2018 15:37:16

12.7 Occupied bandwidth – 99% emission bandwidth

Description:

Measurement of the 99% bandwidth of the modulated signal acc. RSS-GEN.

Measurement:

Measurement parameter	
Detector	Peak
Sweep time	Auto
Resolution bandwidth	300 kHz
Video bandwidth	1 MHz
Span	30 MHz / 50 MHz
Measurement procedure	Measurement of the 99% bandwidth using the integration function of the analyzer
Trace mode	Single count with 200 counts
Test setup	See chapter 7.4 A
Measurement uncertainty	See chapter 8

Usage:

-/-	IC
OBW is necessary for Emission Designator	

Results:

	99% emission bandwidth / kHz		
	lowest channel	middle channel	highest channel
DSSS / b – mode	13937	13928	13892
OFDM / g – mode	16879	16894	16900
OFDM / n HT20 – mode	17875	17863	17893

Plots: DSSS / b – mode

Plot 1: Lowest channel

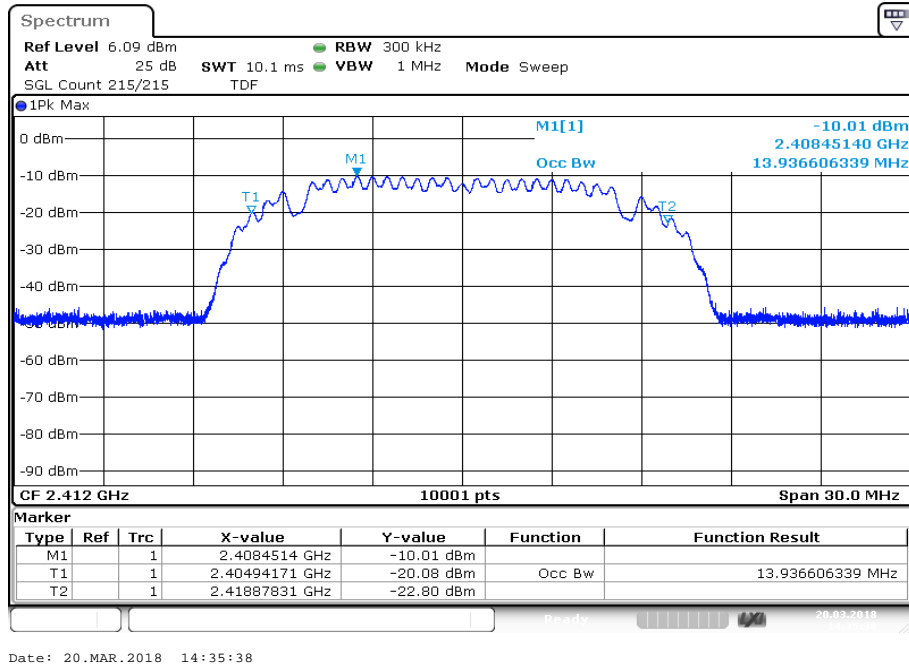

Plot 2: Middle channel

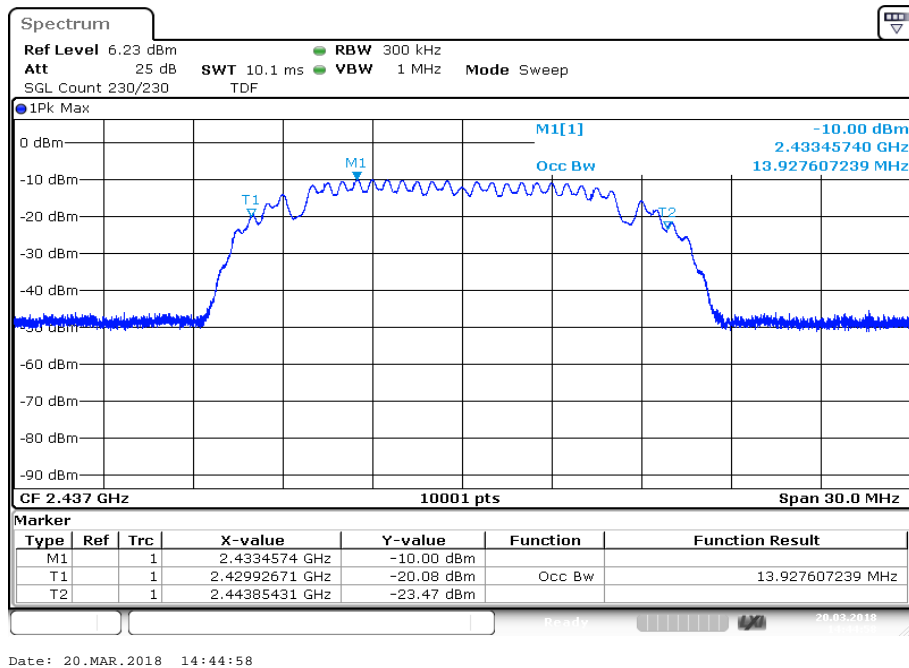

Plot 3: Highest channel

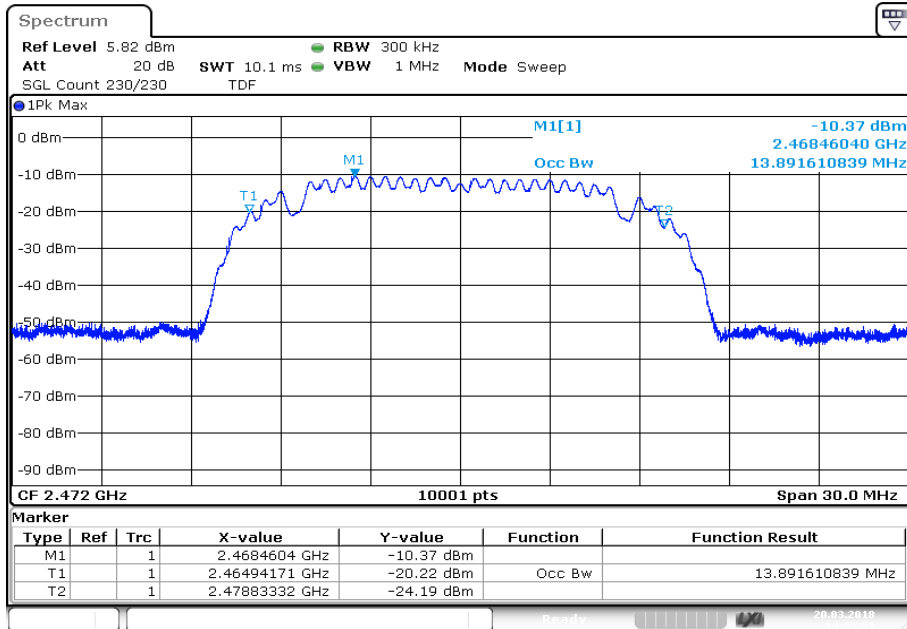

Date: 20.MAR.2018 14:53:51

Plots: OFDM / g – mode

Plot 1: Lowest channel

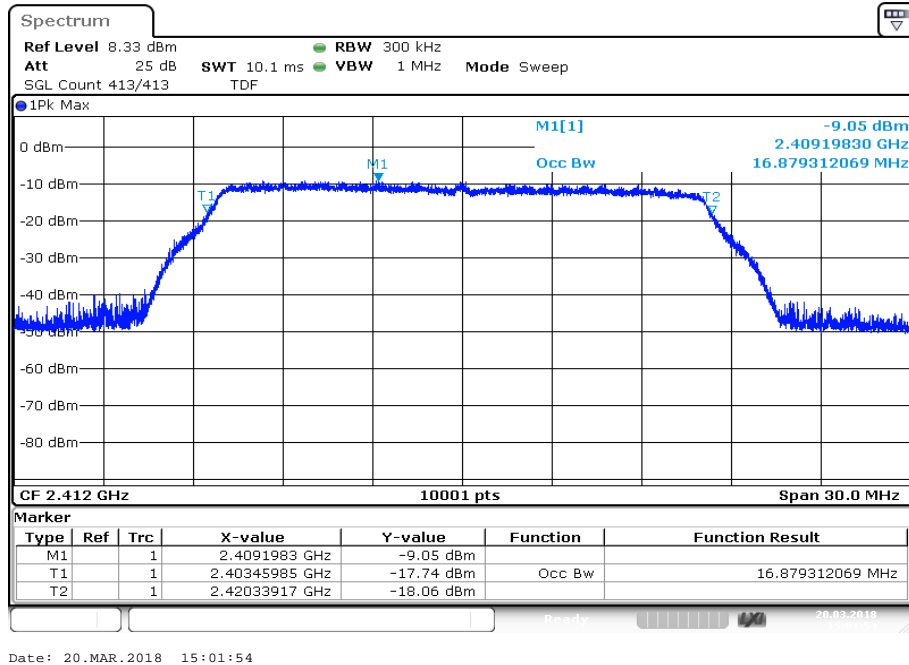

Plot 2: Middle channel

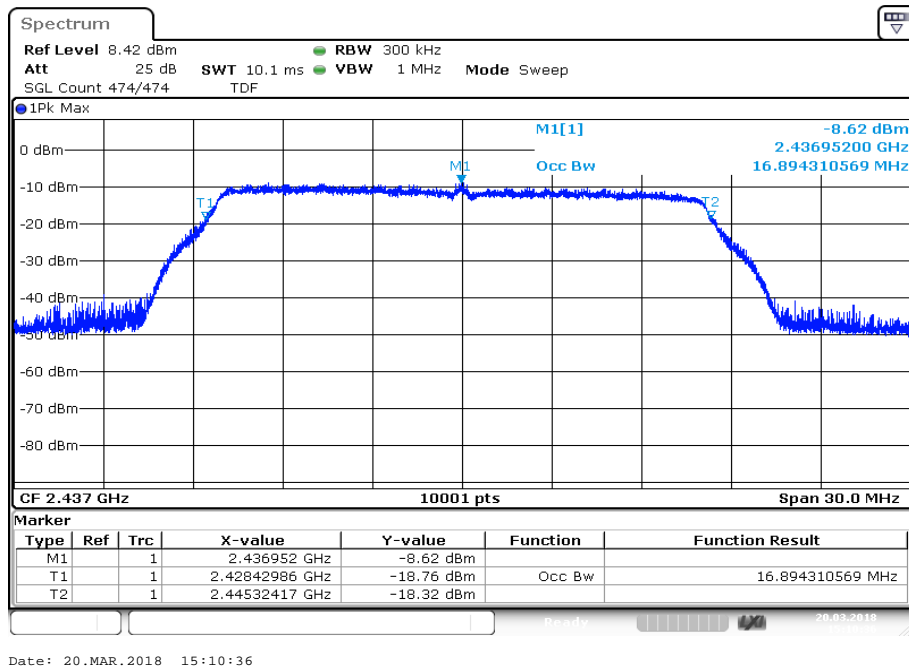

Plot 3: Highest channel

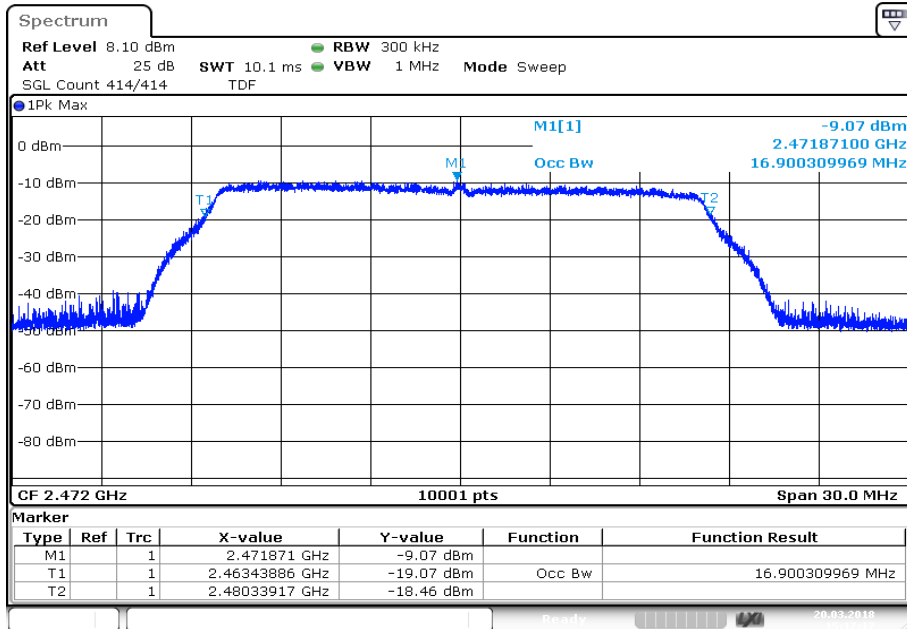

Date: 20.MAR.2018 15:17:16

Plots: OFDM / n HT20 – mode

Plot 1: Lowest channel

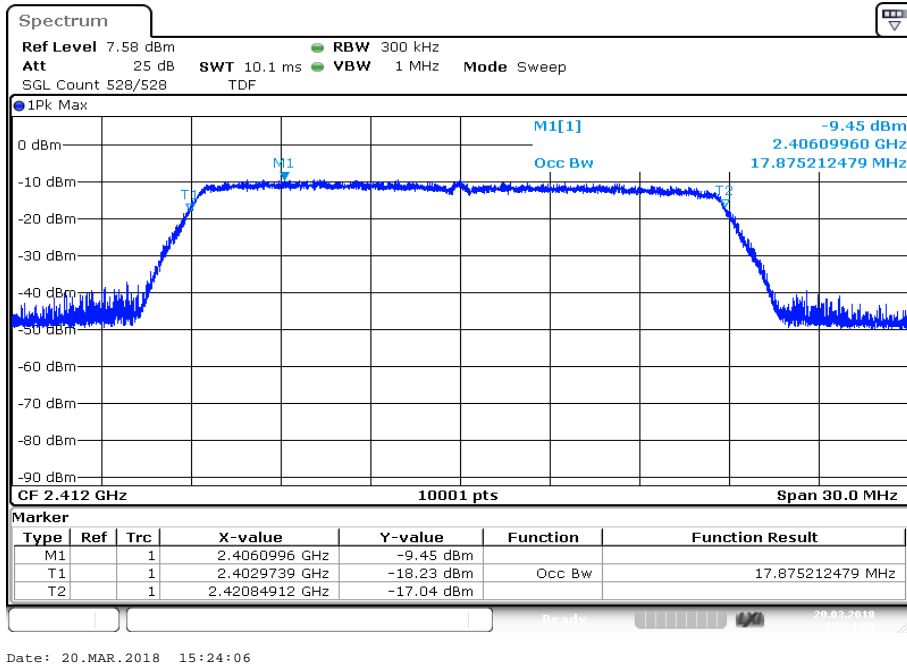

Plot 2: Middle channel

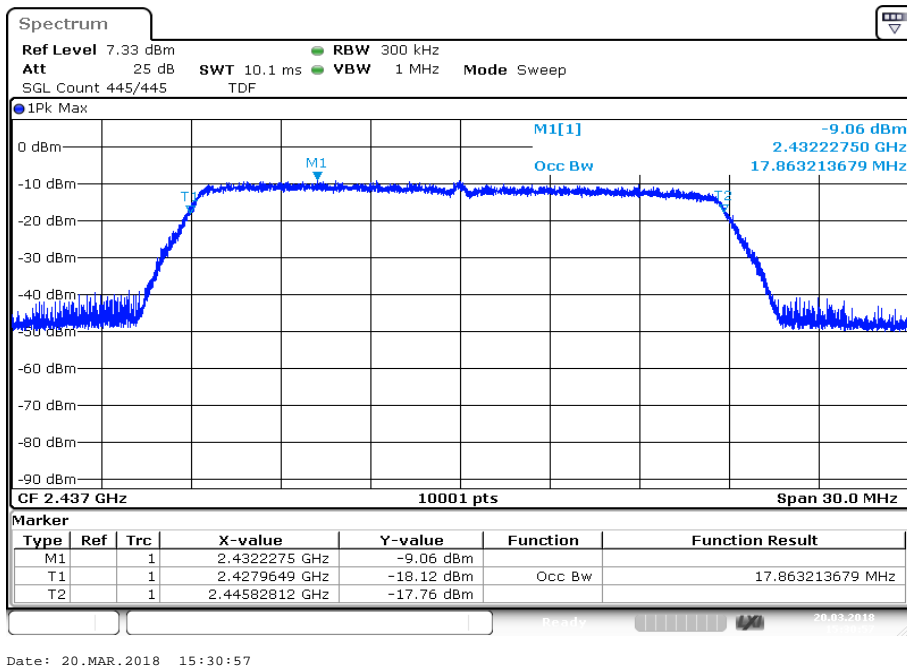

Plot 3: Highest channel

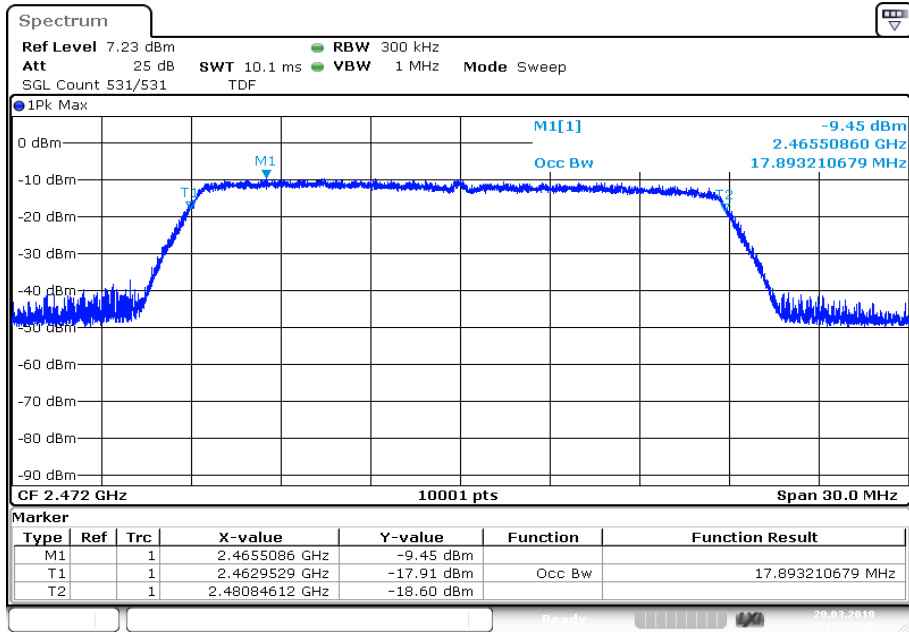

Date: 20.MAR.2018 15:37:45

12.8 Occupied bandwidth – 20 dB bandwidth

Description:

Measurement of the 20 dB bandwidth of the modulated carrier.

Measurement:

Measurement parameter	
Detector	Peak
Sweep time	Auto
Resolution bandwidth	100 kHz
Video bandwidth	500 kHz
Span	30 MHz / 50 MHz
Trace mode	Single count with min. 200 counts
Test setup	See chapter 7.4 A
Measurement uncertainty	See chapter 8

Usage:

-/-	IC
Within the used band!	

Results:

	20 dB bandwidth / MHz		
	lowest channel	middle channel	highest channel
DSSS / b – mode	15260	15254	15245
OFDM / g – mode	17965	18421	18172
OFDM / n HT20 – mode	18934	18952	18862

Plots: DSSS / b – mode

Plot 1: Lowest channel

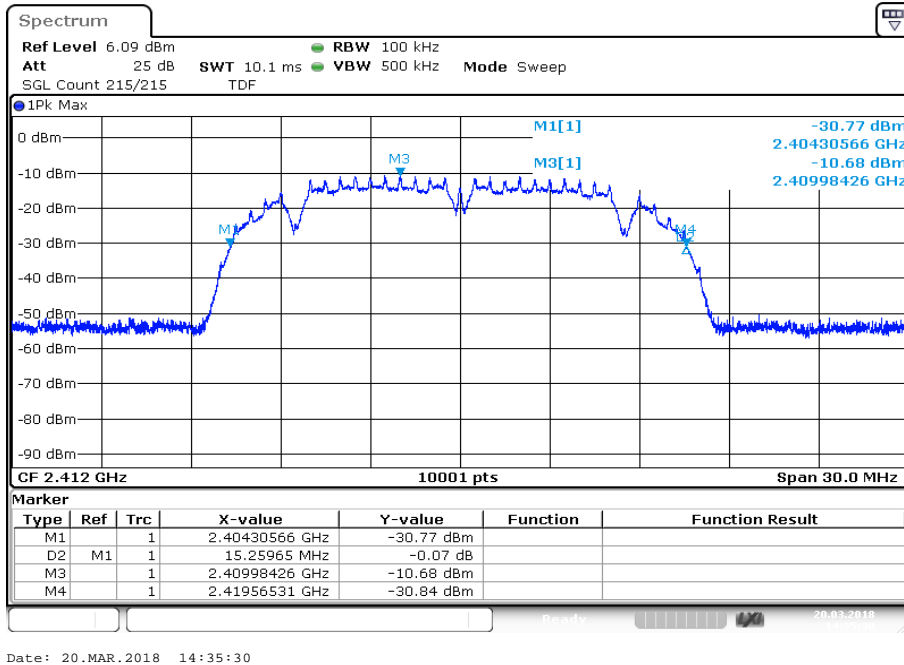

Plot 2: Middle channel

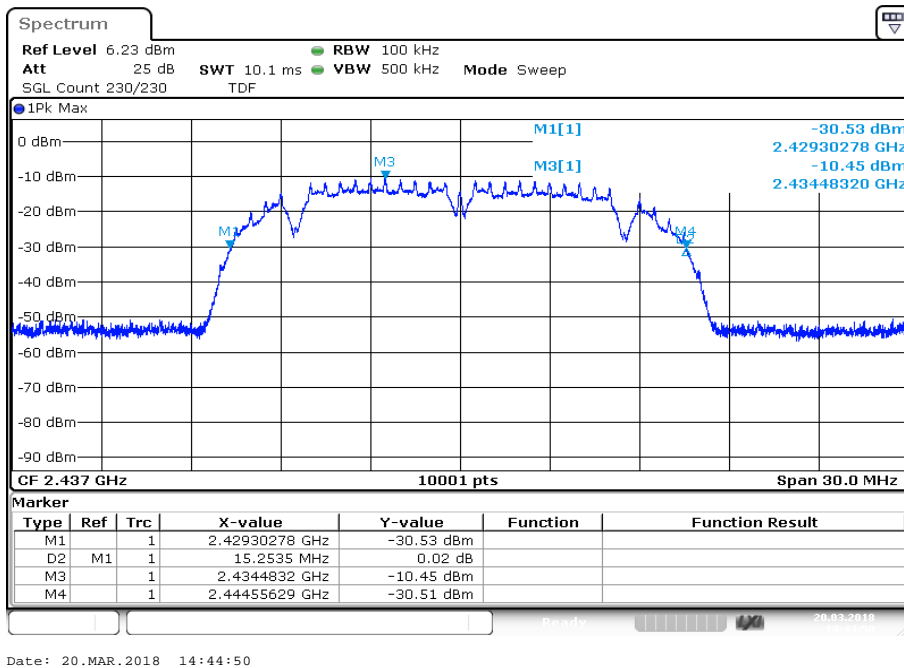

Plot 3: Highest channel

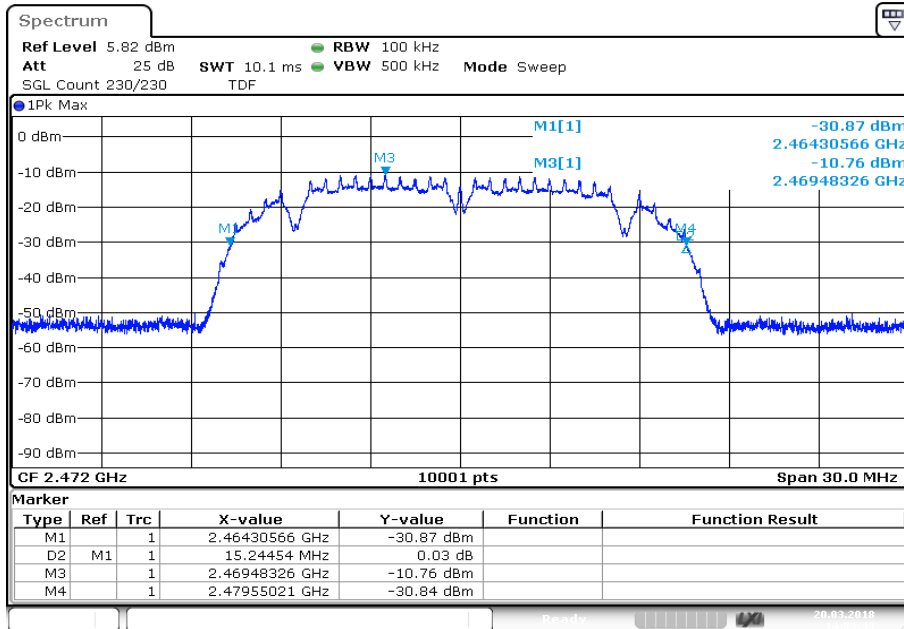

Date: 20.MAR.2018 14:53:43

Plots: OFDM / g – mode

Plot 1: Lowest channel

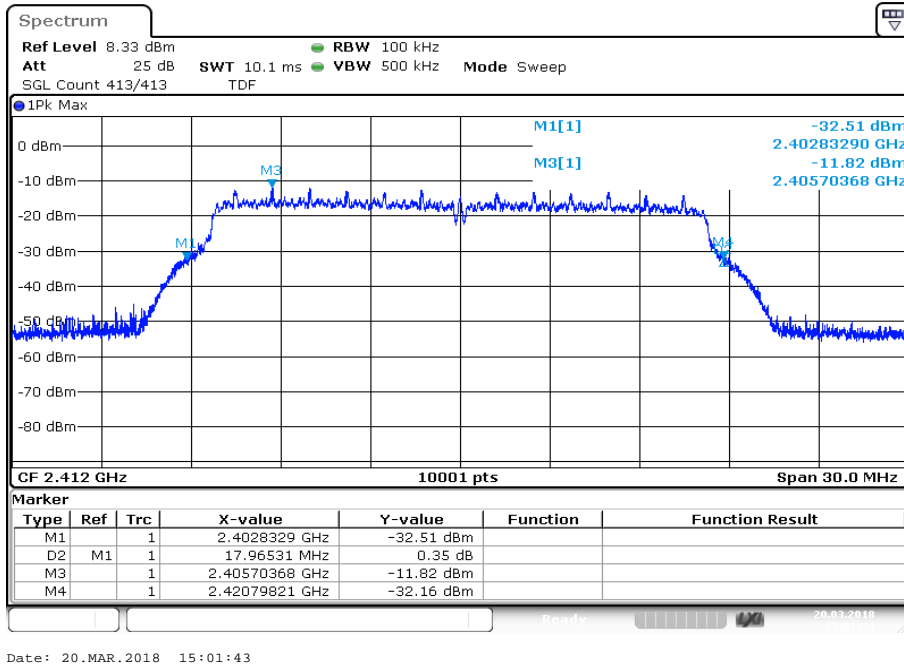

Plot 2: Middle channel

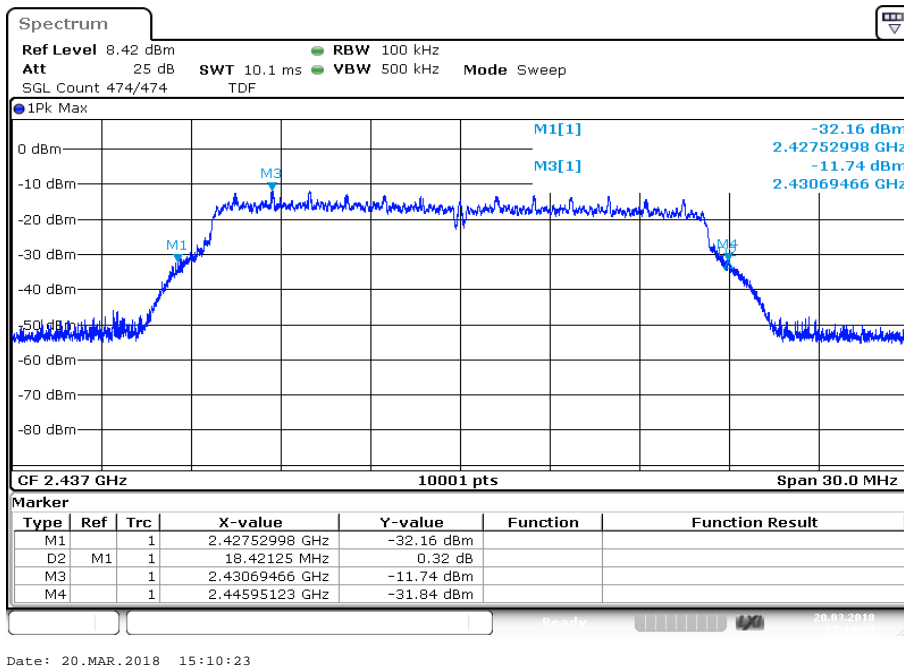

Plot 3: Highest channel

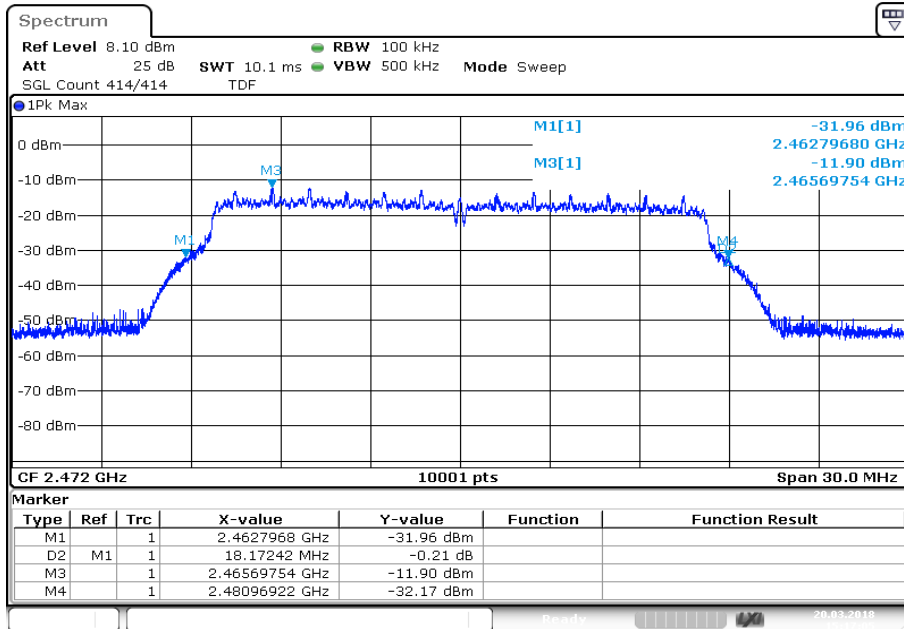

Plots: OFDM / n HT20 – mode

Plot 1: Lowest channel

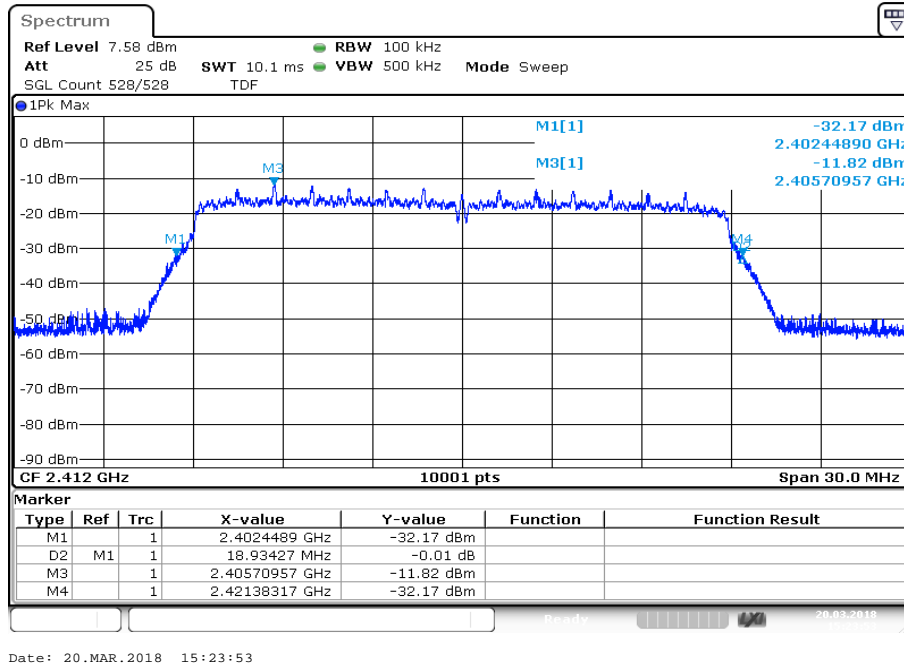

Plot 2: Middle channel

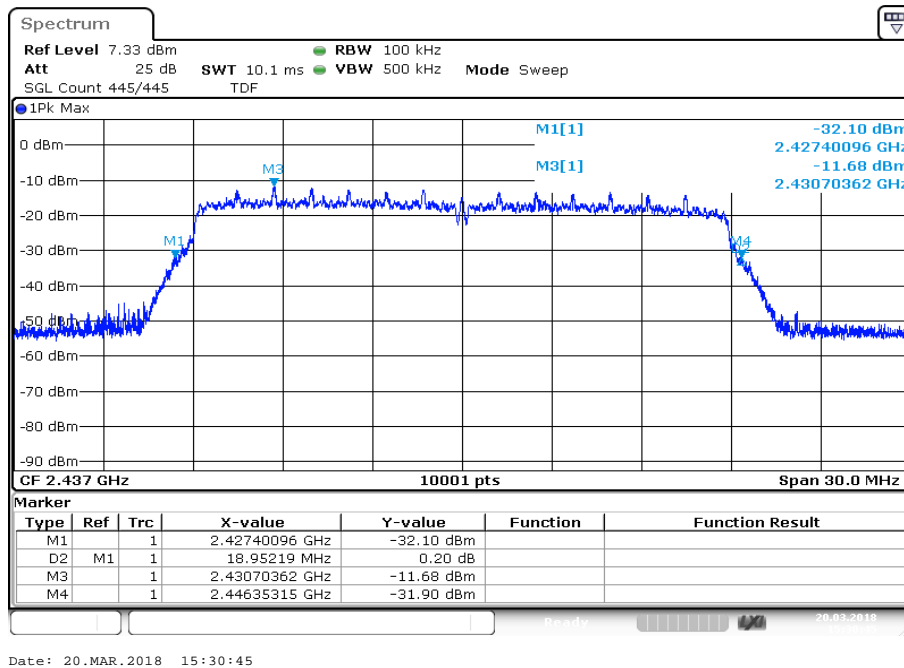

Plot 3: Highest channel

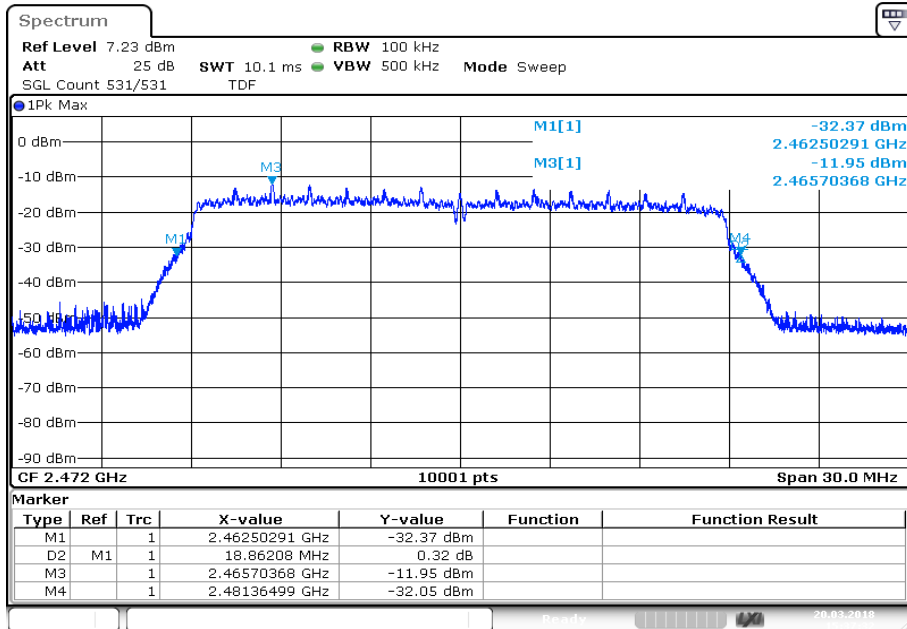

Date: 20.MAR.2018 15:37:32

12.9 Band edge compliance radiated

Description:

Measurement of the radiated band edge compliance. The EUT is turned in the position that results in the maximum level at the band edge. Then a sweep over the corresponding restricted band is performed. The EUT is set to the lowest channel for the lower restricted band and to the highest channel for the upper restricted band. The measurement is repeated for all modulations. Measurement distance is 3 meter.

Measurement:

	Measurement parameter for peak measurements	Measurement parameter for average measurements
		According to DTS clause: 13.3.2
Detector	Peak	RMS
Sweep time	Auto	Auto
Resolution bandwidth	1 MHz	100 kHz
Video bandwidth	3 MHz	300 kHz
Span	See plot	2 MHz
Trace mode	Max. hold	RMS Average over 101 sweeps
Analyzer function	-/-	Band power function (Compute the power by integrating the spectrum over 1 MHz)
Test setup	See chapter 7.3	
Measurement uncertainty	See chapter 8	

Limits:

FCC	IC
74 dB μ V/m @ 3 m (Peak) 54 dB μ V/m @ 3 m (AVG)	

Results:

band edge compliance radiated / (dB μ V / m) @ 3 m			
	DSSS	OFDM (20 MHz nominal channel bandwidth)	OFDM (40 MHz nominal channel bandwidth)
Lower band edge	>20 dB below limit (Peak) >20 dB below limit (AVG)	>20 dB below limit (Peak) >20 dB below limit (AVG)	-/-
Upper band edge	>20 dB below limit (Peak) >20 dB below limit (AVG)	>20 dB below limit (Peak) >20 dB below limit (AVG)	-/-

Plots: DSSS - peak / average

Plot 1: TX mode, lower band edge, vertical & horizontal polarization

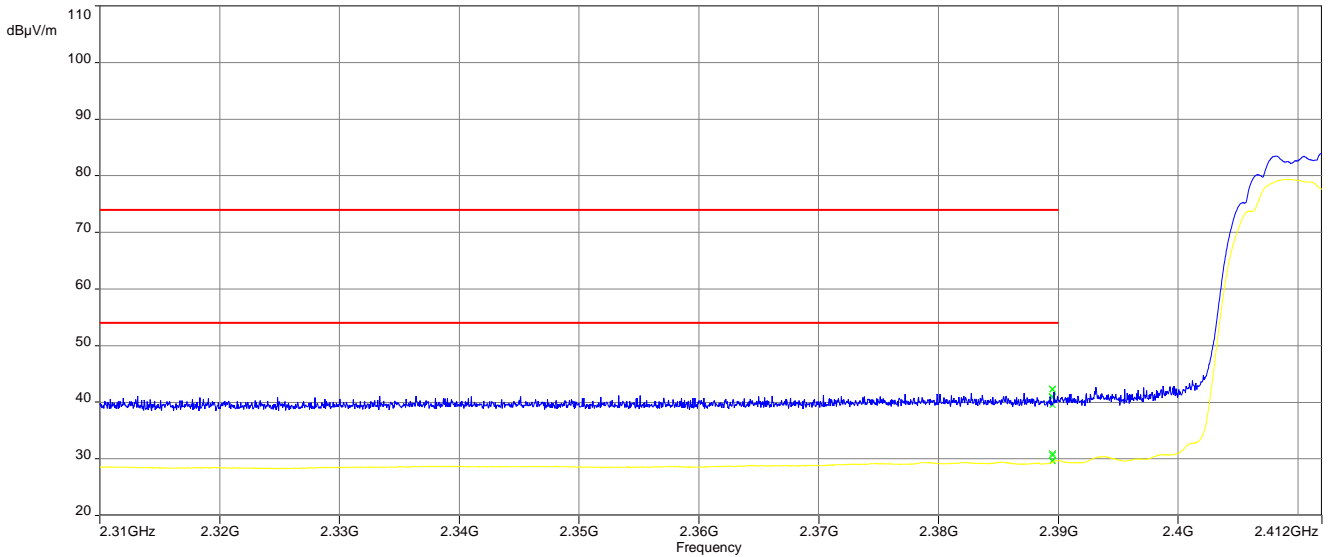

Plot 2: TX mode, upper band edge, vertical & horizontal polarization

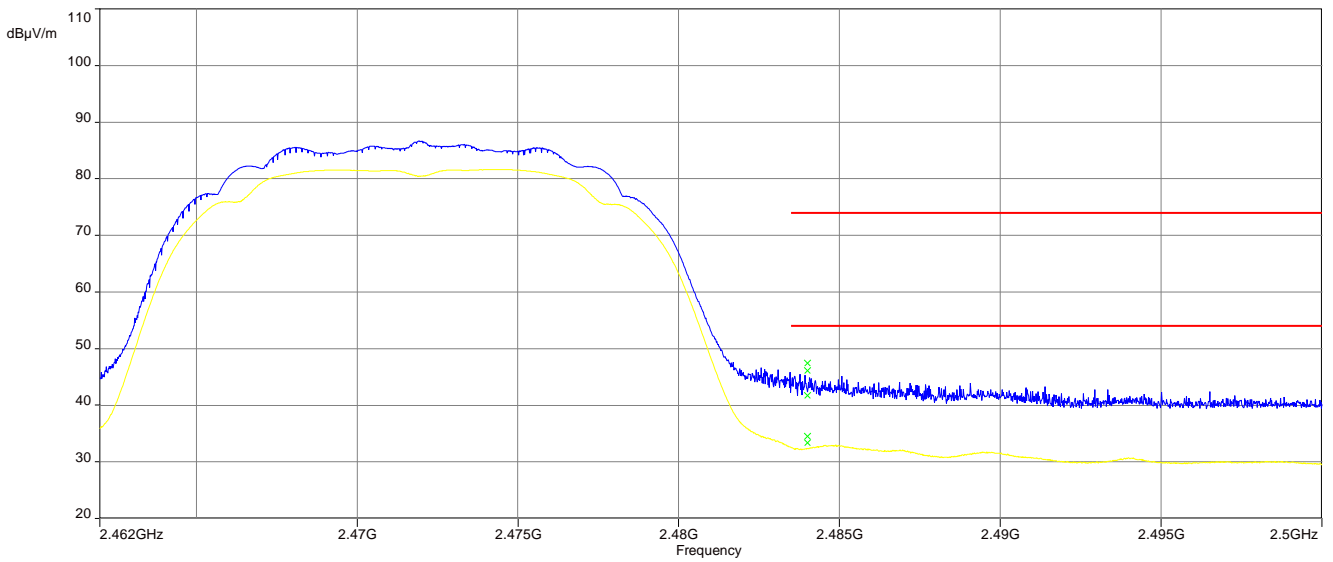

Plots: OFDM (20 MHz bandwidth) - peak / average

Plot 1: TX mode, lower band edge, vertical & horizontal polarization

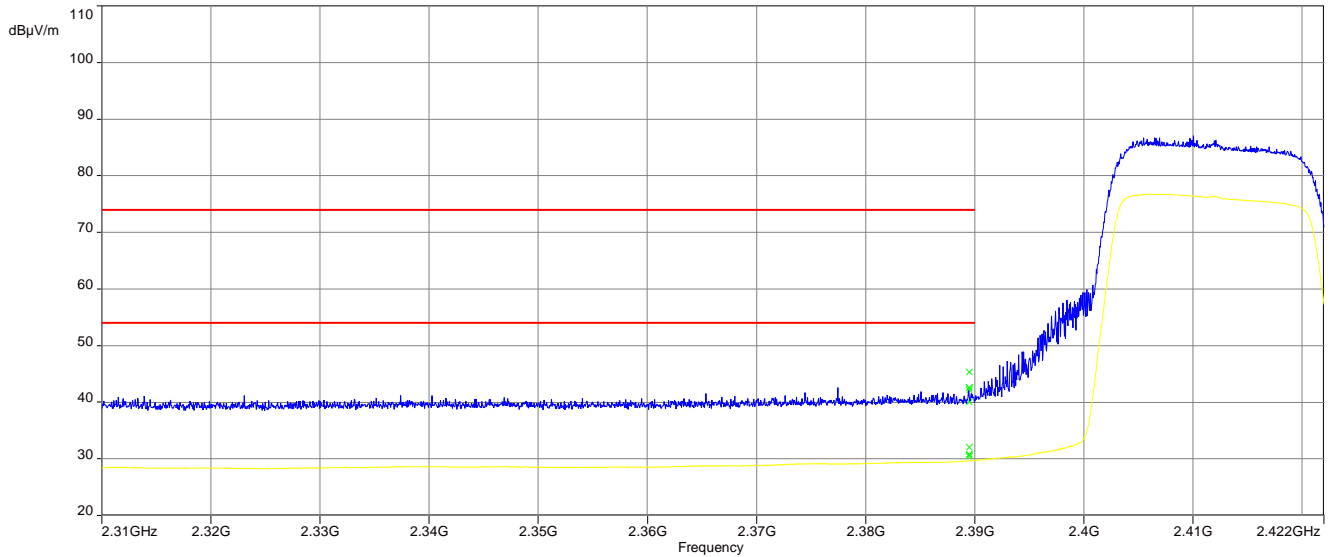

Plot 2: TX mode, upper band edge, vertical & horizontal polarization

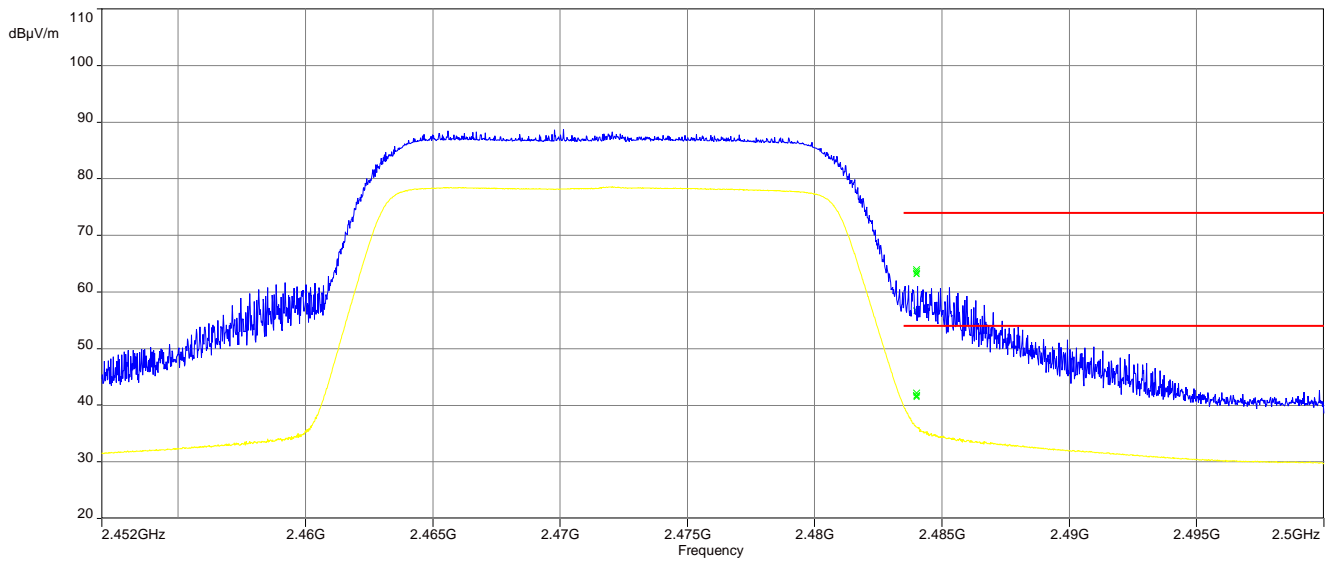

12.10 Spurious emissions conducted

Description:

Measurement of the conducted spurious emissions in transmit mode. The measurement is performed at the lowest; the middle and the highest channel. The measurement is repeated for all modulations.

Measurement:

Measurement parameter	
Detector	Peak
Sweep time	Auto
Resolution bandwidth	100 kHz
Video bandwidth	500 kHz
Span	9 kHz to 25 GHz
Trace mode	Max Hold
Test setup	See chapter 7.4
Measurement uncertainty	See chapter 8

Limits:

FCC	IC
<p>In any 100 kHz bandwidth outside the frequency band in which the spread spectrum or digitally modulated intentional radiator is operating, the radio frequency power that is produced by the intentional radiator shall be at least 30 dB below that in the 100 kHz bandwidth within the band that contains the highest level of the desired power, based on either an RF conducted or a radiated measurement. Attenuation below the general limits specified in Section 15.209(a) is not required</p>	

Results: DSSS / b – mode

TX spurious emissions conducted					
f [MHz]		amplitude of emission [dBm]	limit max. allowed emission power	actual attenuation below frequency of operation [dB]	results
Lowest channel		-11.95	30 dBm	-/-	Operating frequency
All detected emissions are below the -20 dBc & -30 dBc criteria.			-20 dBc (peak) -30 dBc (average)		compliant
Middle channel		-11.29	30 dBm	-/-	Operating frequency
All detected emissions are below the -20 dBc & -30 dBc criteria.			-20 dBc (peak) -30 dBc (average)		compliant
Highest channel		-11.63	30 dBm	-/-	Operating frequency
All detected emissions are below the -20 dBc & -30 dBc criteria.			-20 dBc (peak) -30 dBc (average)		compliant

Results: OFDM / g – mode

TX spurious emissions conducted					
f [MHz]		amplitude of emission [dBm]	limit max. allowed emission power	actual attenuation below frequency of operation [dB]	results
Lowest channel		-12.14	30 dBm	-/-	Operating frequency
All detected emissions are below the -20 dBc & -30 dBc criteria.			-20 dBc (peak) -30 dBc (average)		compliant
Middle channel		-14.35	30 dBm	-/-	Operating frequency
All detected emissions are below the -20 dBc & -30 dBc criteria.			-20 dBc (peak) -30 dBc (average)		compliant
Highest channel		-15.38	30 dBm	-/-	Operating frequency
All detected emissions are below the -20 dBc & -30 dBc criteria.			-20 dBc (peak) -30 dBc (average)		compliant

Results: OFDM / n HT20 – mode

TX spurious emissions conducted					
f [MHz]		amplitude of emission [dBm]	limit max. allowed emission power	actual attenuation below frequency of operation [dB]	results
Lowest channel		-12.31	30 dBm	-/-	Operating frequency
All detected emissions are below the -20 dBc & -30 dBc criteria.			-20 dBc (peak) -30 dBc (average)		compliant
Middle channel		-13.67	30 dBm	-/-	Operating frequency
All detected emissions are below the -20 dBc & -30 dBc criteria.			-20 dBc (peak) -30 dBc (average)		compliant
Highest channel		-12.85	30 dBm	-/-	Operating frequency
All detected emissions are below the -20 dBc & -30 dBc criteria.			-20 dBc (peak) -30 dBc (average)		compliant

Plots: DSSS / b – mode

Plot 1: Lowest channel, up to 25 GHz

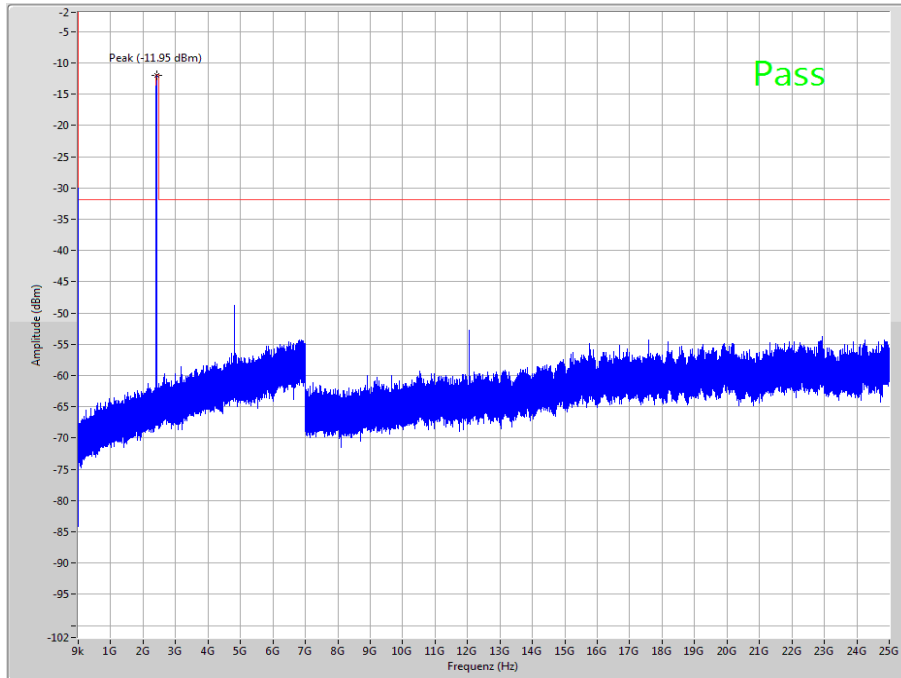

The peak at the beginning of the plot is the LO from the SA.

Plot 2: Lowest channel, zoomed carrier

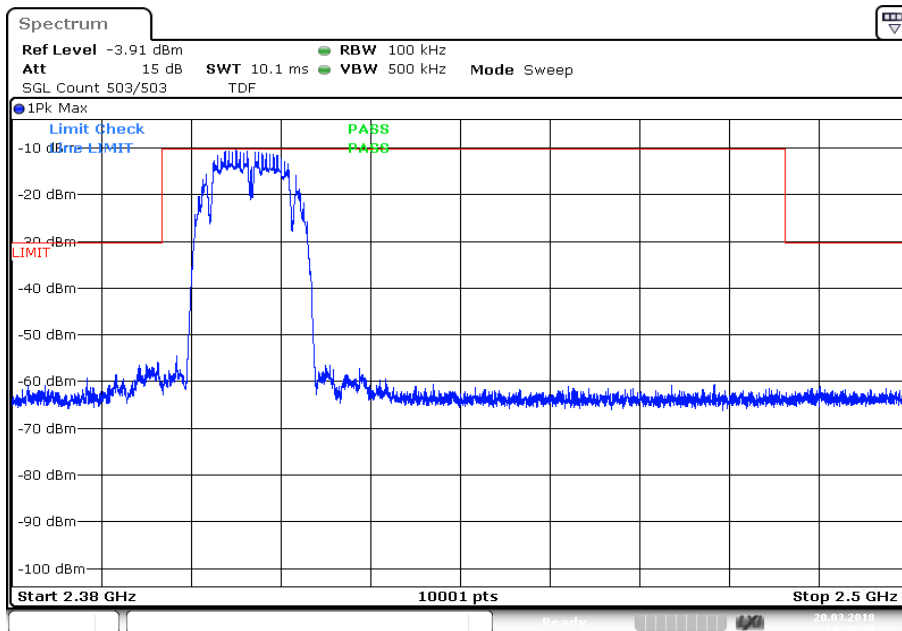

Date: 20.MAR.2018 14:38:43

Plot 3: Middle channel, up to 25 GHz

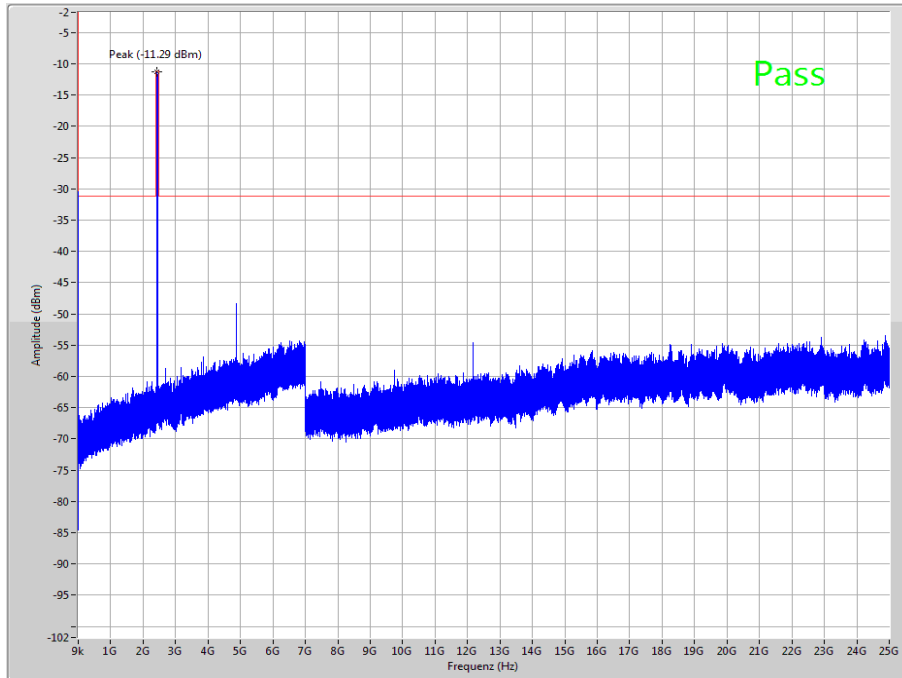

The peak at the beginning of the plot is the LO from the SA.

Plot 4: Middle channel, zoomed carrier

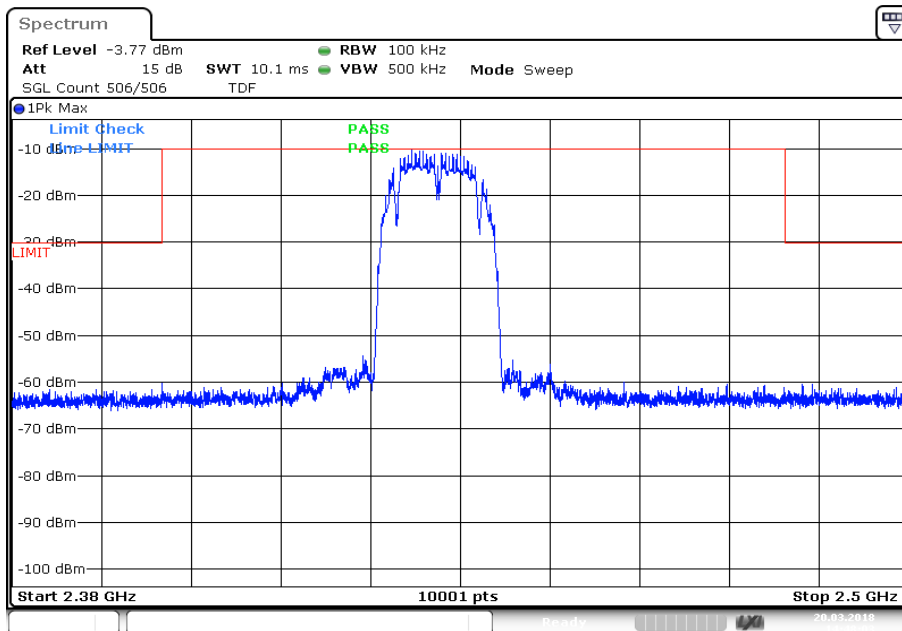

Date: 20.MAR.2018 14:48:03

Plot 5: Highest channel, up to 25 GHz

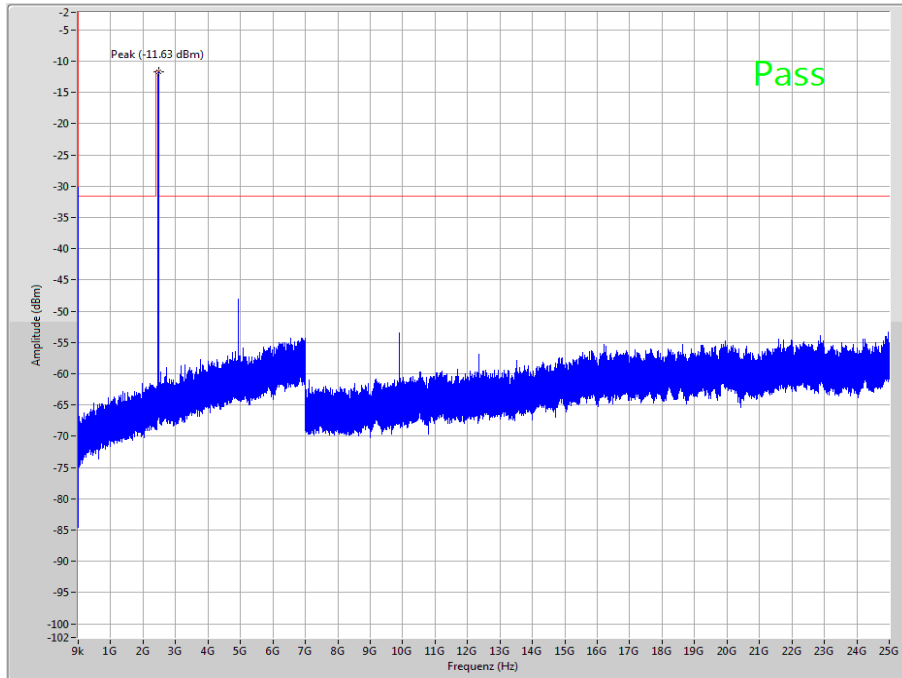

The peak at the beginning of the plot is the LO from the SA.

Plot 6: Highest channel, zoomed carrier

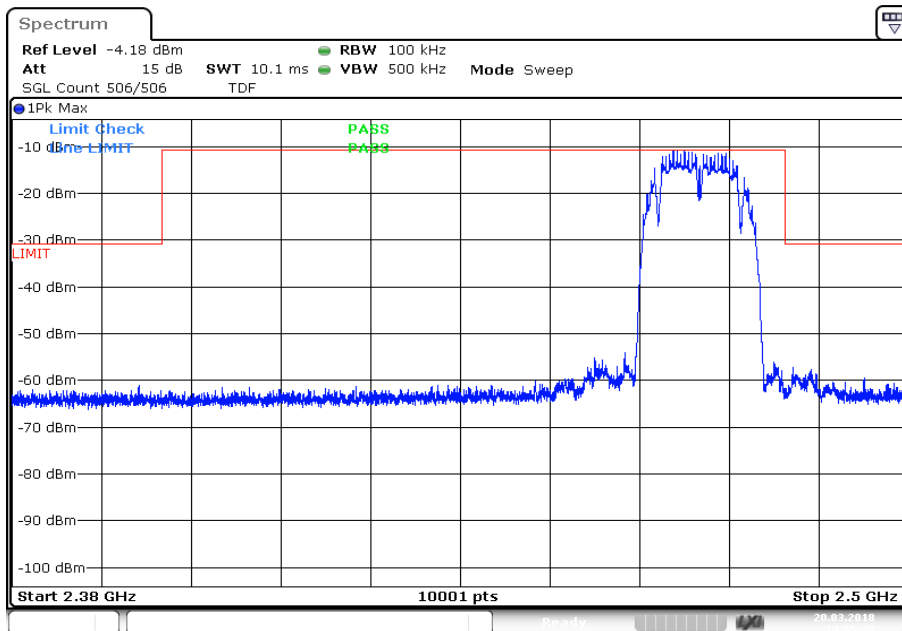

Date: 20.MAR.2018 14:55:38

Plots: OFDM / g – mode

Plot 1: Lowest channel, up to 25 GHz

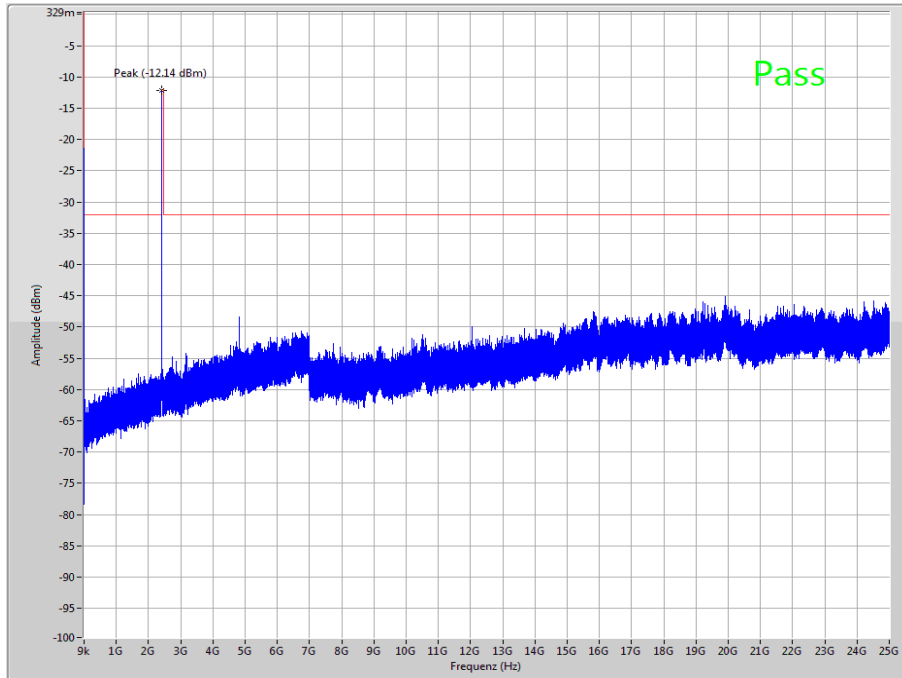

The peak at the beginning of the plot is the LO from the SA.

Plot 2: Lowest channel, zoomed carrier

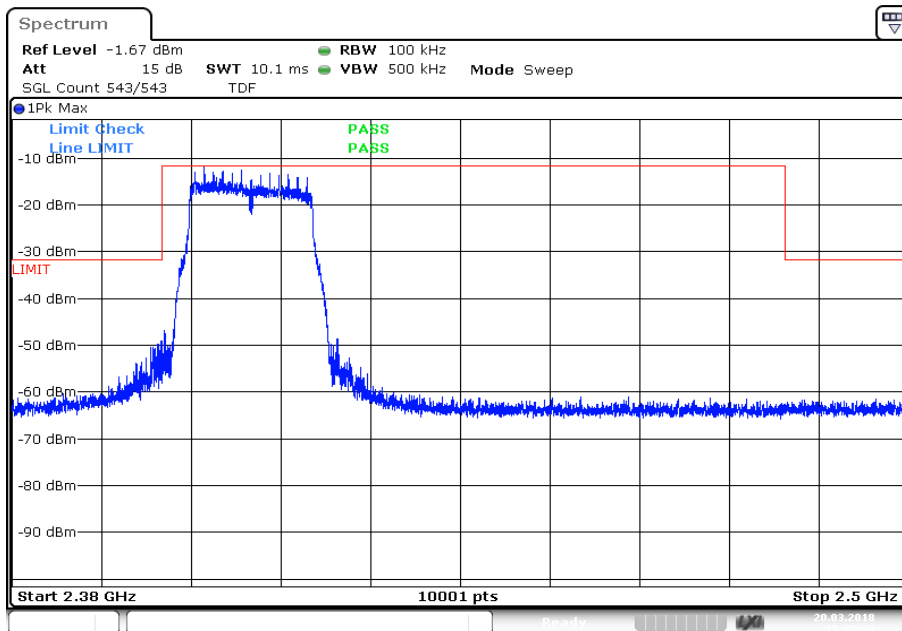

Date: 20.MAR.2018 15:02:38

Plot 3: Middle channel, up to 25 GHz

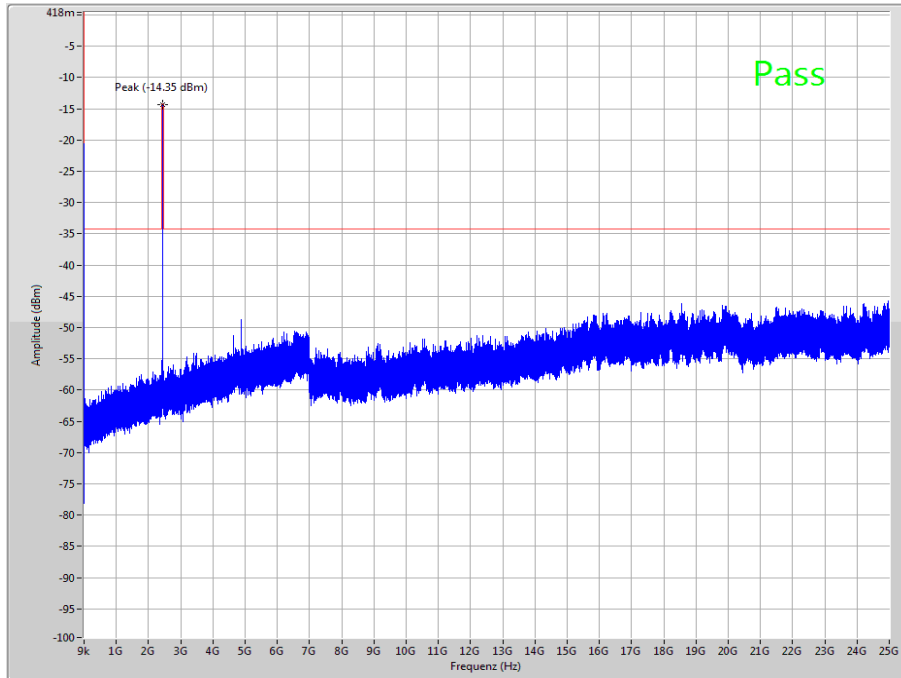

The peak at the beginning of the plot is the LO from the SA.

Plot 4: Middle channel, zoomed carrier

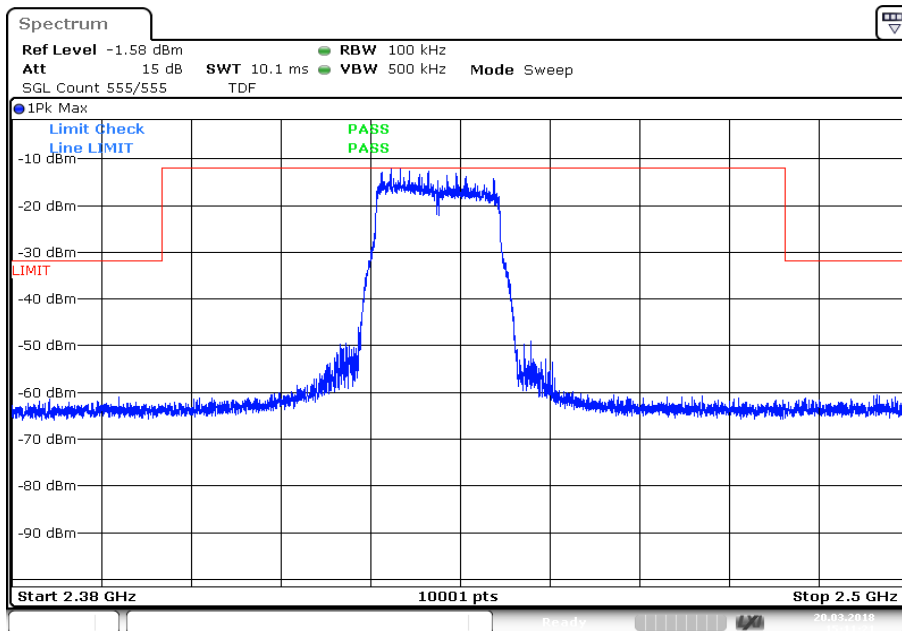

Date: 20.MAR.2018 15:11:21

Plot 5: Highest channel, up to 25 GHz

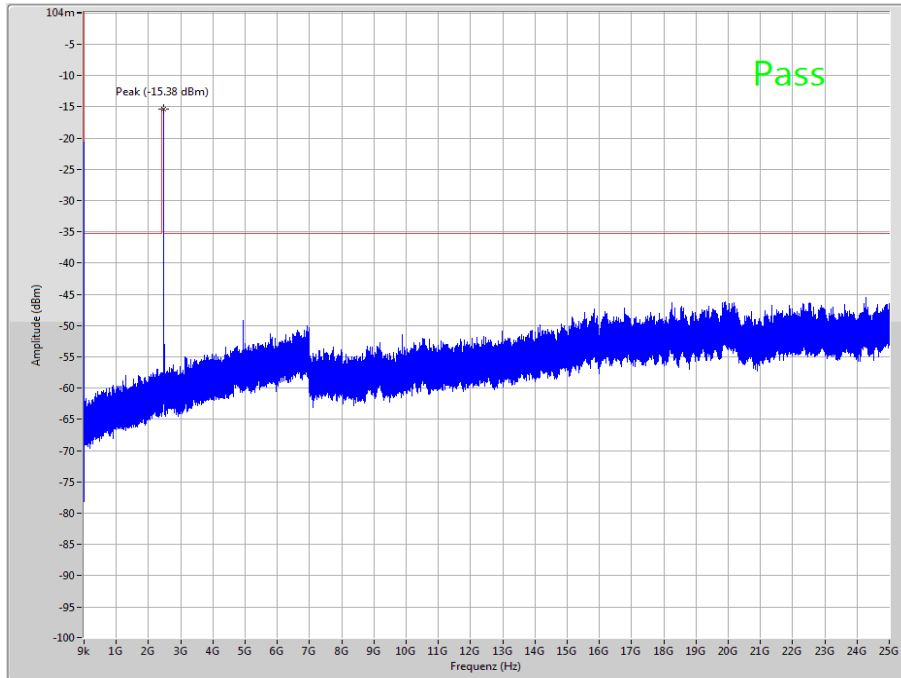

The peak at the beginning of the plot is the LO from the SA.

Plot 6: Highest channel, zoomed carrier

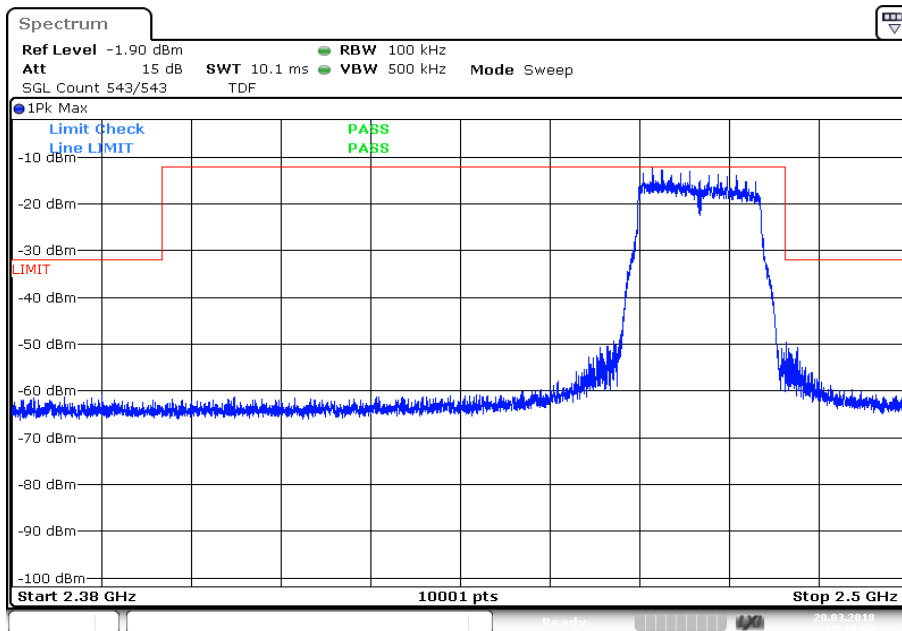

Date: 20.MAR.2018 15:18:02

Plots: OFDM / n HT 20 – mode

Plot 1: Lowest channel, up to 25 GHz

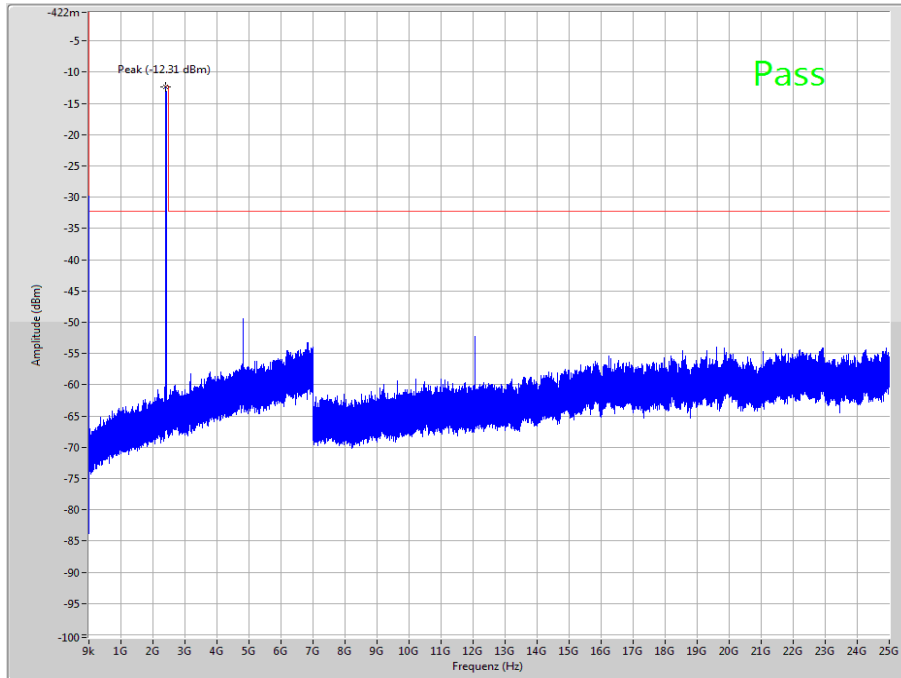

The peak at the beginning of the plot is the LO from the SA.

Plot 2: Lowest channel, zoomed carrier

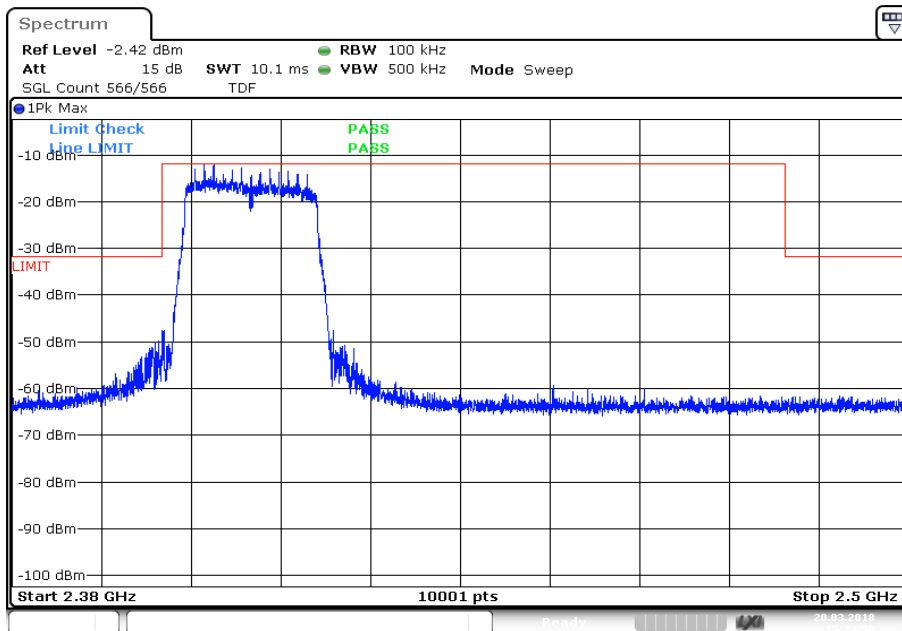

Date: 20.MAR.2018 15:24:50

Plot 3: Middle channel, up to 25 GHz

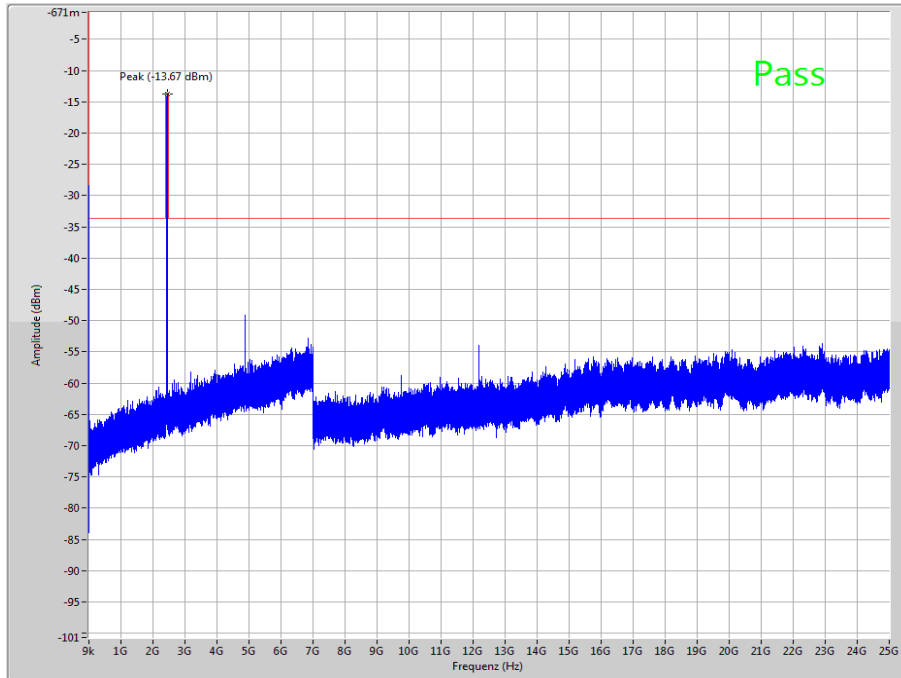

The peak at the beginning of the plot is the LO from the SA.

Plot 4: Middle channel, zoomed carrier

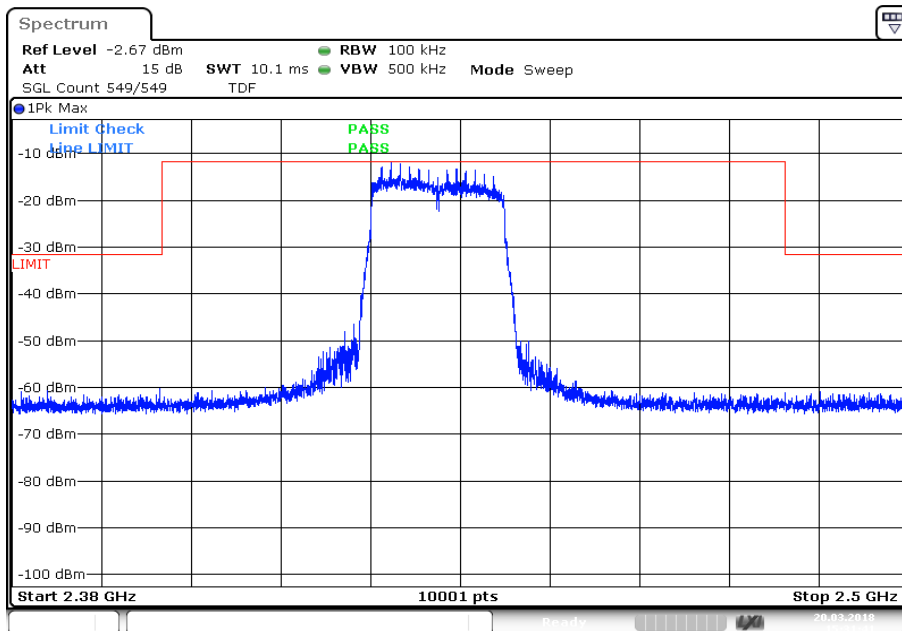

Plot 5: Highest channel, up to 25 GHz

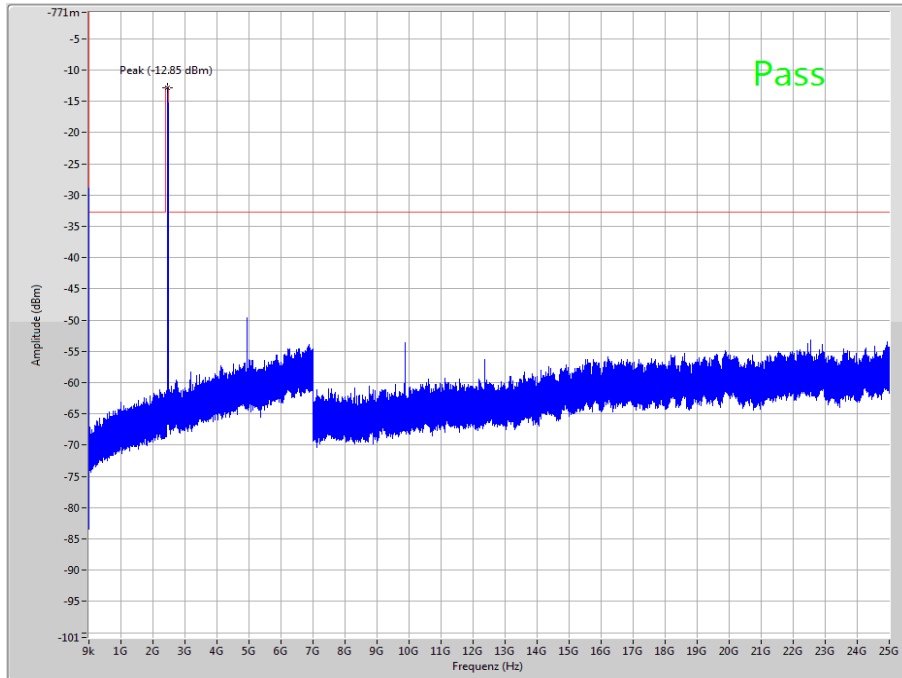

The peak at the beginning of the plot is the LO from the SA.

Plot 6: Highest channel, zoomed carrier

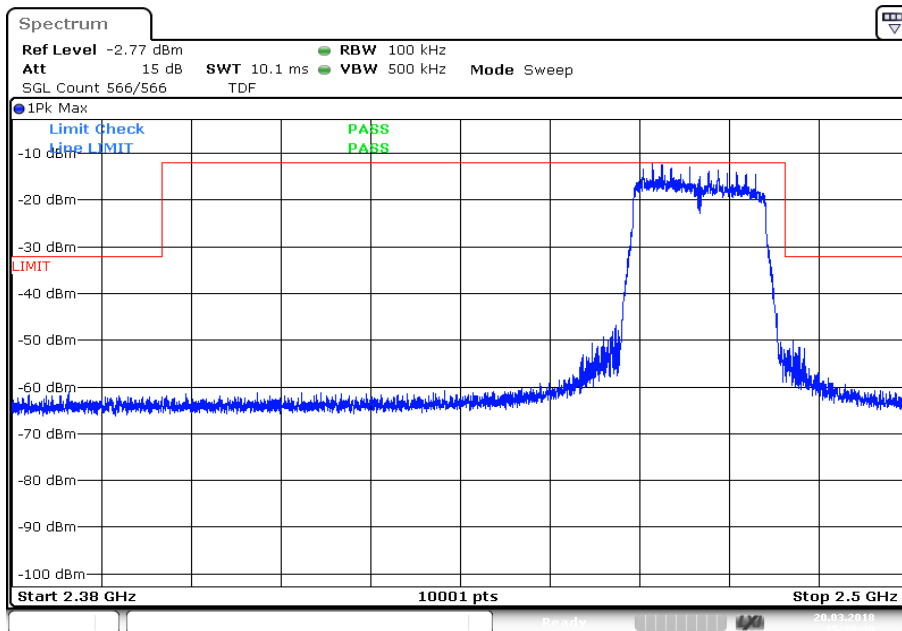

Date: 20.MAR.2018 15:38:30

12.11 Spurious emissions radiated below 30 MHz

Description:

Measurement of the radiated spurious emissions in transmit mode below 30 MHz. The limits are recalculated to a measurement distance of 3 m with 40 dB/decade according CFR Part 2.

Measurement:

Measurement parameter	
Detector	Peak / Quasi Peak
Sweep time	Auto
Resolution bandwidth	F < 150 kHz: 200 Hz F > 150 kHz: 9 kHz
Video bandwidth	F < 150 kHz: 1 kHz F > 150 kHz: 100 kHz
Span	9 kHz to 30 MHz
Trace mode	Max Hold
Measured modulation	<input checked="" type="checkbox"/> DSSS b – mode <input checked="" type="checkbox"/> OFDM g – mode <input checked="" type="checkbox"/> OFDM n HT20 – mode <input type="checkbox"/> OFDM n HT40 – mode
Test setup	See chapter 7.2 A
Measurement uncertainty	See chapter 8

Limits:

FCC		IC
Frequency / MHz	Field Strength / (dBµV / m)	Measurement distance / m
0.009 – 0.490	2400/F(kHz)	300
0.490 – 1.705	24000/F(kHz)	30
1.705 – 30.0	30	30

Results:

TX spurious emissions radiated < 30 MHz / (dBµV / m) @ 3 m		
Frequency / MHz	Detector	Level / (dBµV / m)
All detected peaks are more than 20 dB below the limit.		

Plots: b-mode

Plot 1: 9 kHz to 30 MHz, lowest channel

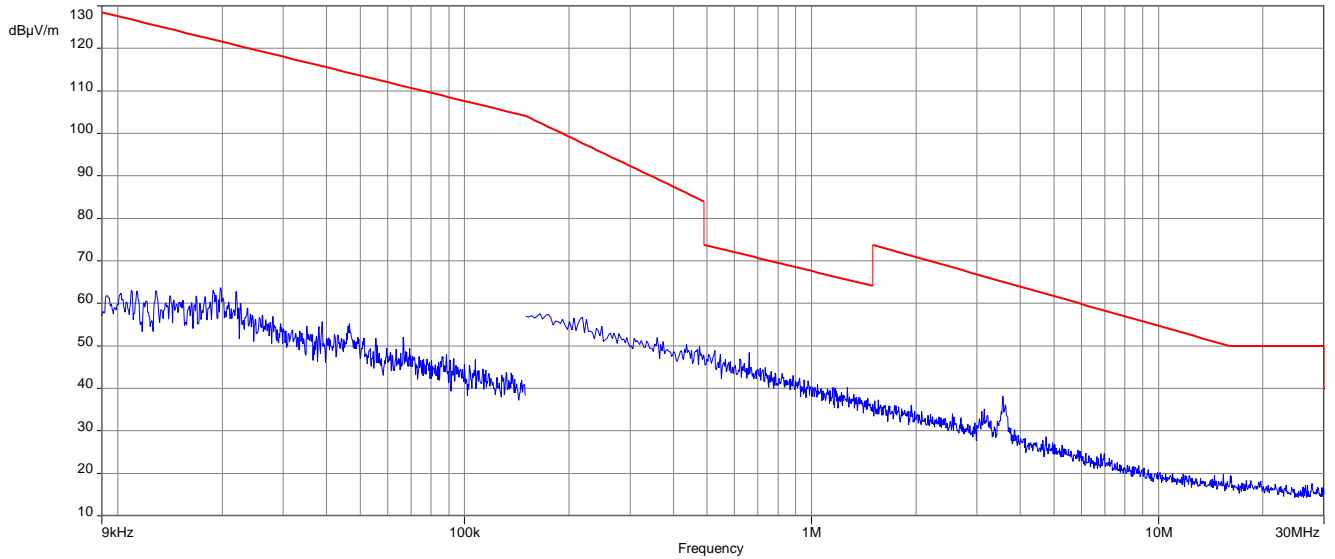

Plot 2: 9 kHz to 30 MHz, middle channel

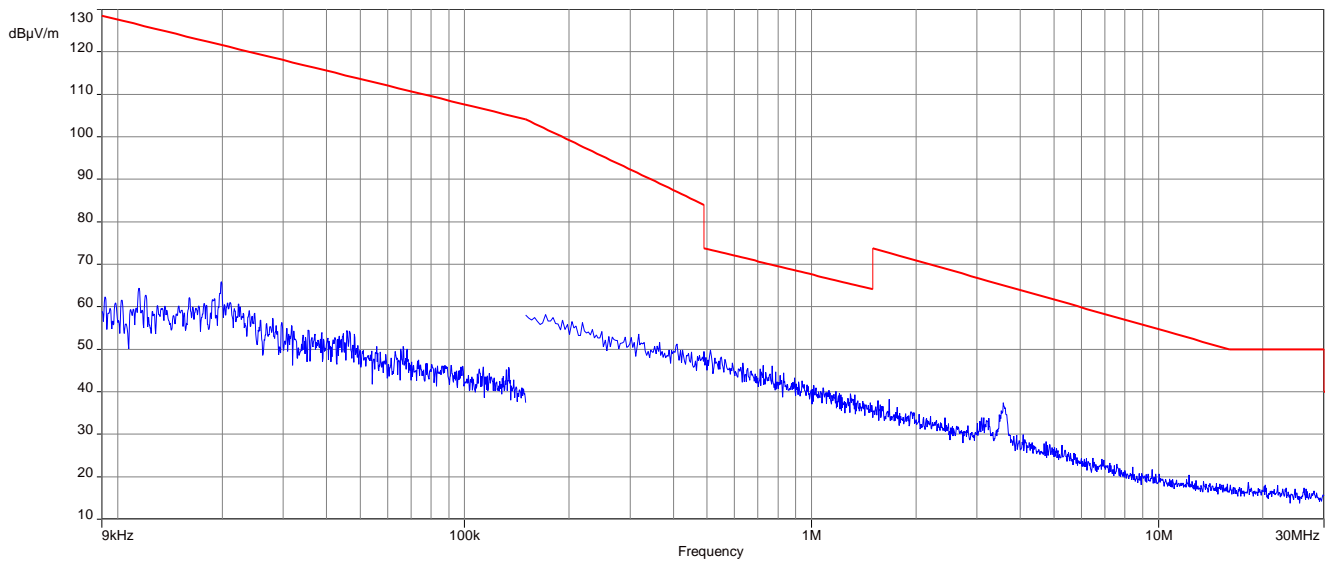

Plot 3: 9 kHz to 30 MHz, highest channel

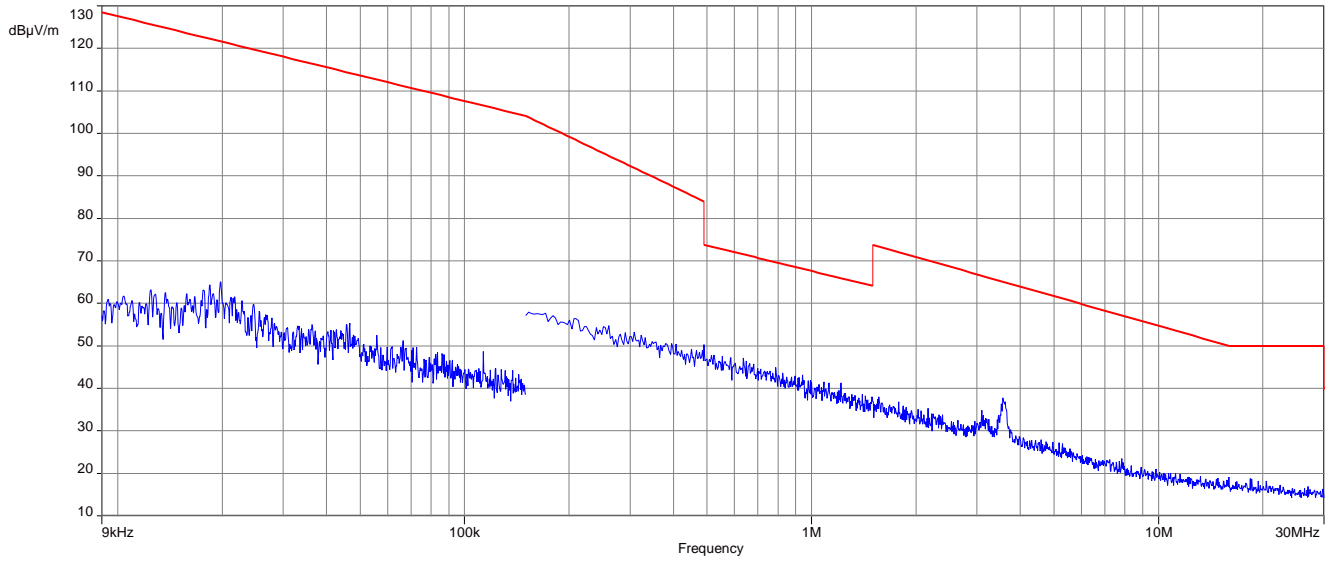

Plots: g-mode

Plot 1: 9 kHz to 30 MHz, lowest channel

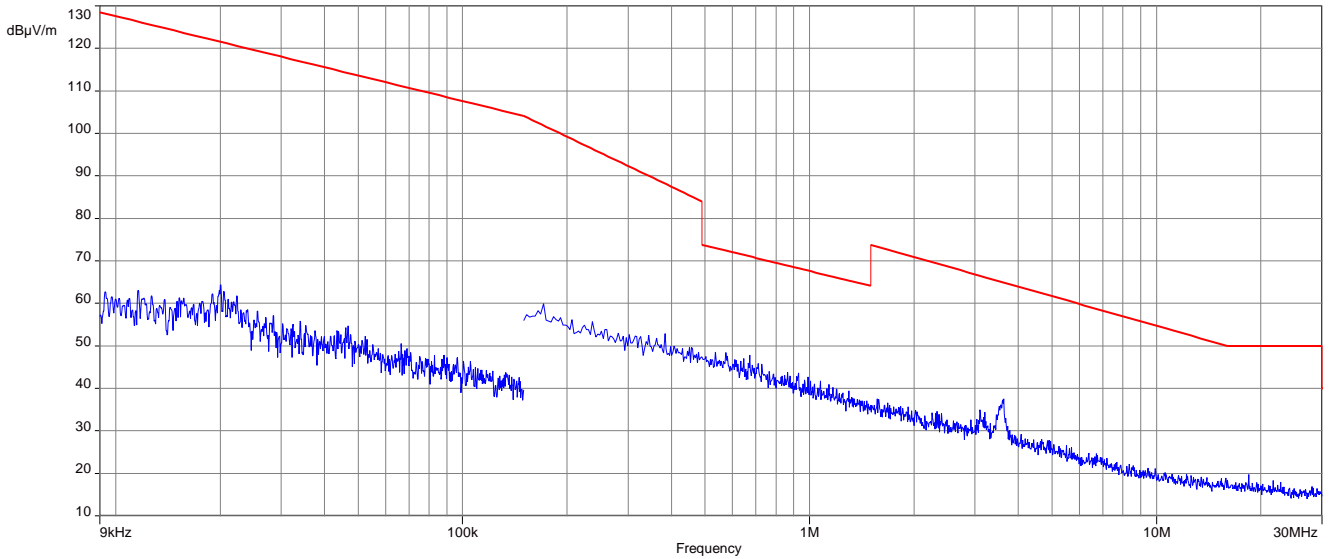

Plot 2: 9 kHz to 30 MHz, middle channel

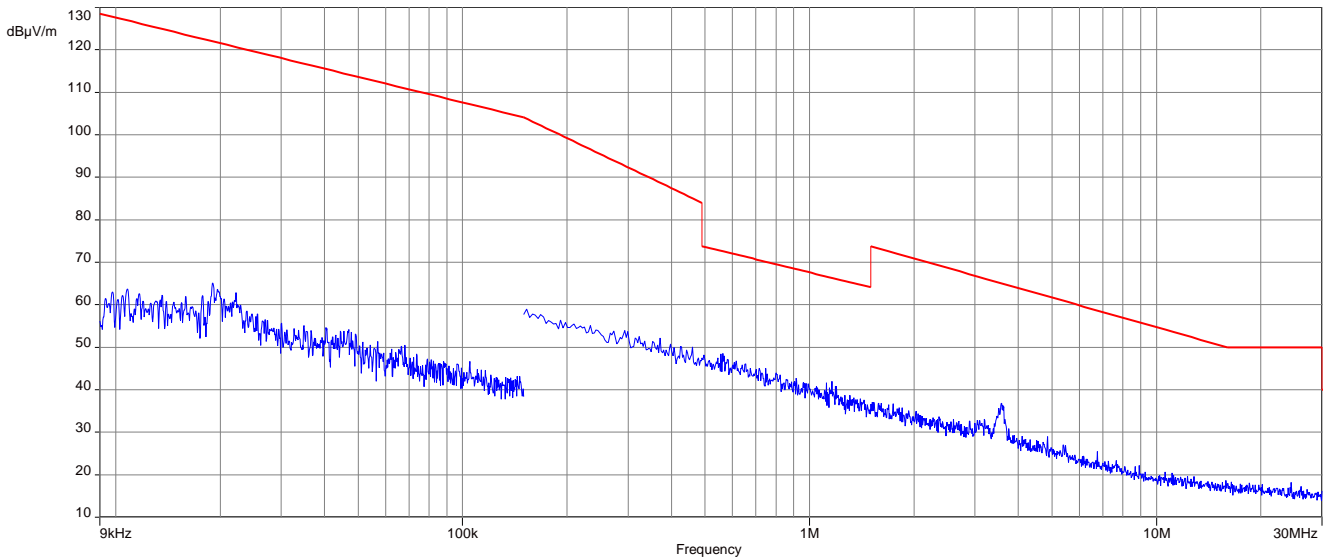

Plot 3: 9 kHz to 30 MHz, highest channel

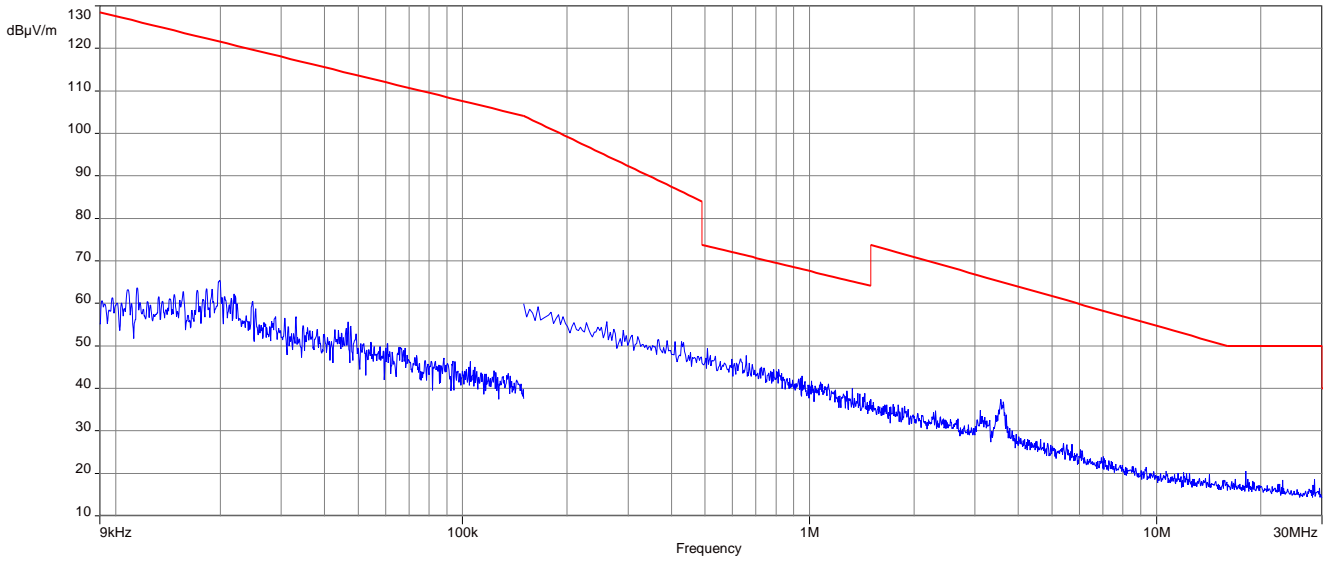

Plots: n HT20-mode

Plot 1: 9 kHz to 30 MHz, lowest channel

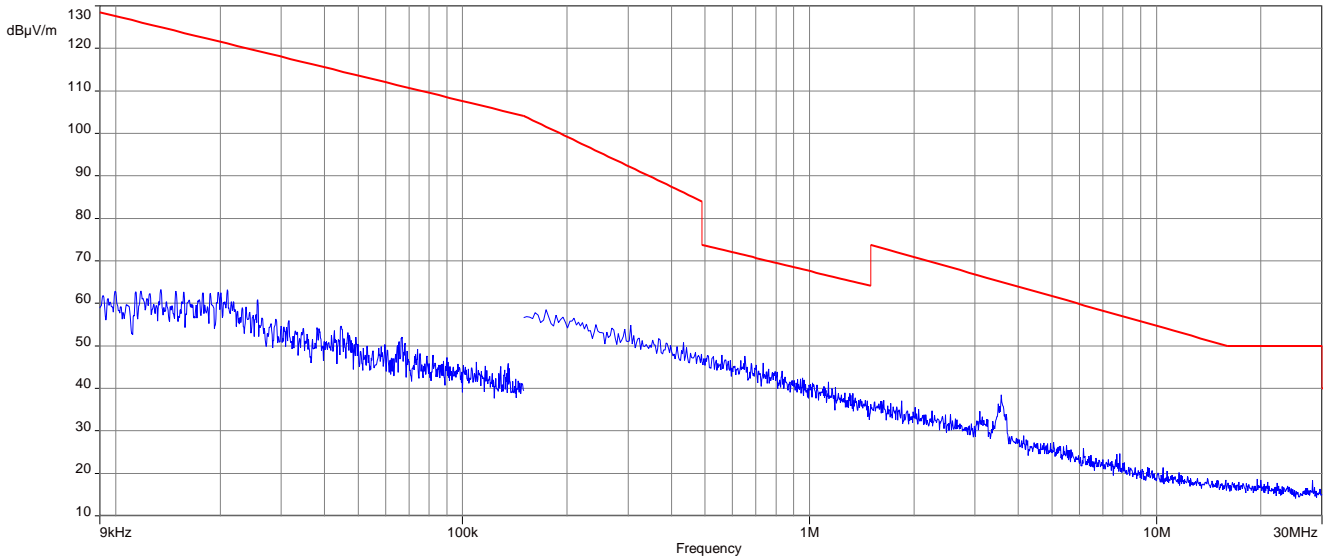

Plot 2: 9 kHz to 30 MHz, middle channel

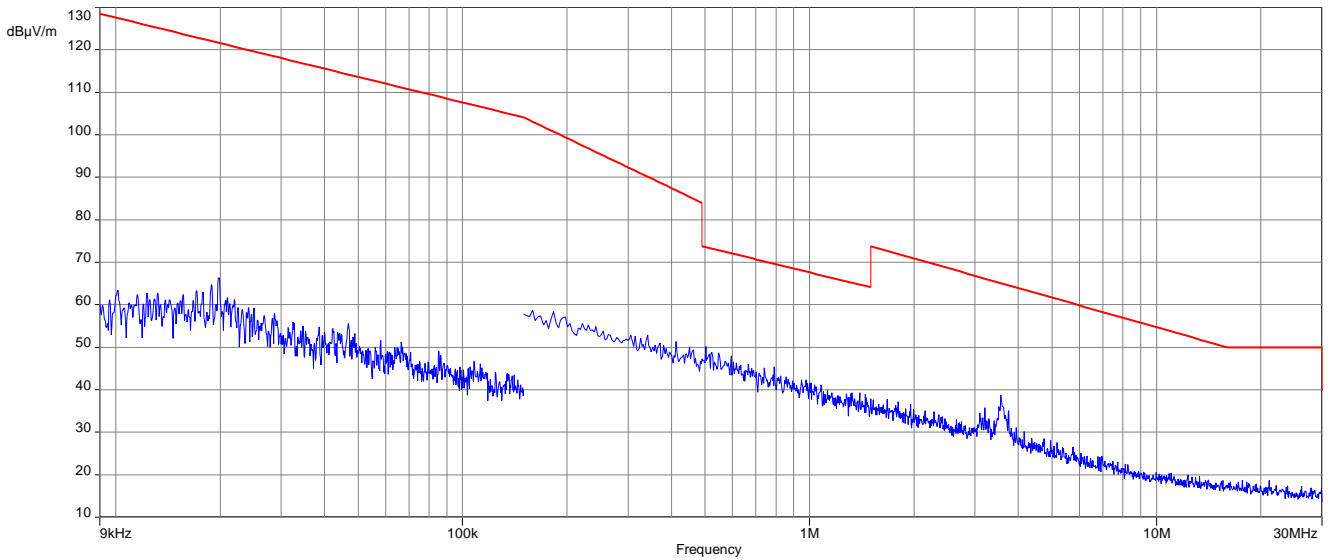

Plot 3: 9 kHz to 30 MHz, highest channel

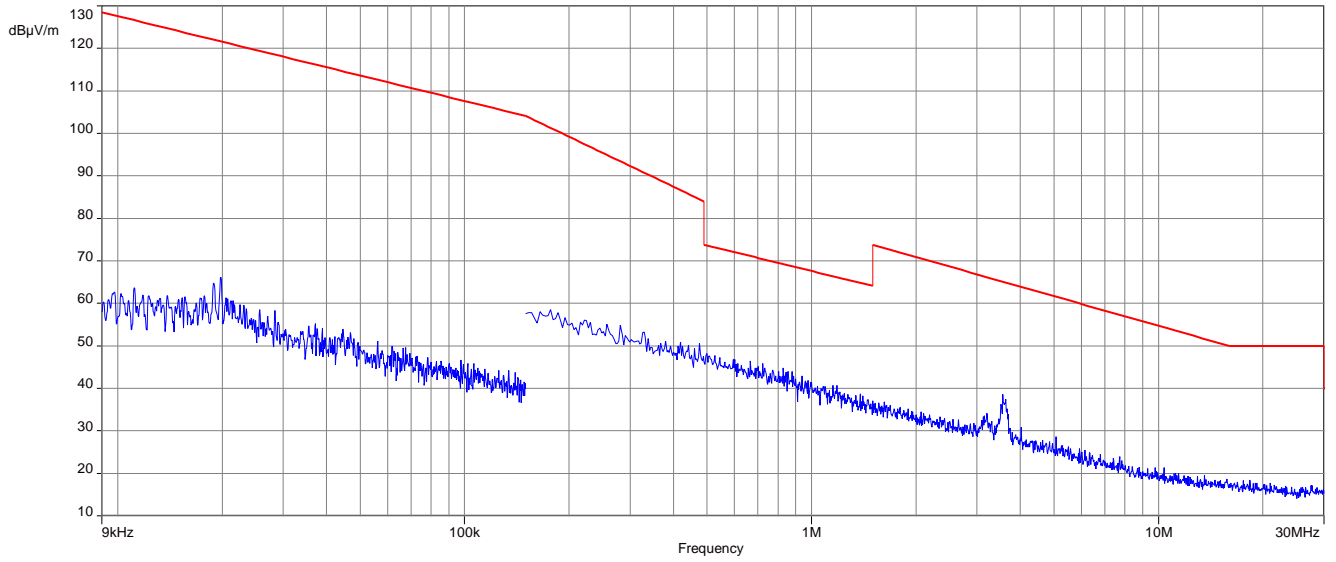

12.12 Spurious emissions radiated 30 MHz to 1 GHz

Description:

Measurement of the radiated spurious emissions and cabinet radiations below 1 GHz.

Measurement:

Measurement parameter	
Detector	Peak / Quasi Peak
Sweep time	Auto
Resolution bandwidth	120 kHz
Video bandwidth	3 x RBW
Span	30 MHz to 1 GHz
Trace mode	Max Hold
Measured modulation	<input checked="" type="checkbox"/> DSSS b – mode <input checked="" type="checkbox"/> OFDM g – mode <input checked="" type="checkbox"/> OFDM n HT20 – mode <input type="checkbox"/> OFDM n HT40 – mode <input checked="" type="checkbox"/> RX / Idle – mode
Test setup	See chapter 7.1
Measurement uncertainty	See chapter 8

Limits:

FCC	IC	
In any 100 kHz bandwidth outside the frequency band in which the spread spectrum or digitally modulated intentional radiator is operating, the radio frequency power that is produced by the intentional radiator shall be at least 20 dB below that in the 100 kHz bandwidth within the band that contains the highest level of the desired power, based on either an RF conducted or a radiated measurement. Attenuation below the general limits specified in Section 15.209(a) is not required. In addition, radiated emissions which fall in the restricted bands, as defined in §15.205(a), must also comply with the radiated emission limits specified in §15.209(a) (see §15.205(c)).		
Frequency / MHz	Field Strength / (dBµV / m)	Measurement distance / m
30 – 88	30.0	10
88 – 216	33.5	10
216 – 960	36.0	10

Plot: b-mode

Plot 1: 30 MHz to 1 GHz, vertical & horizontal polarization, lowest channel

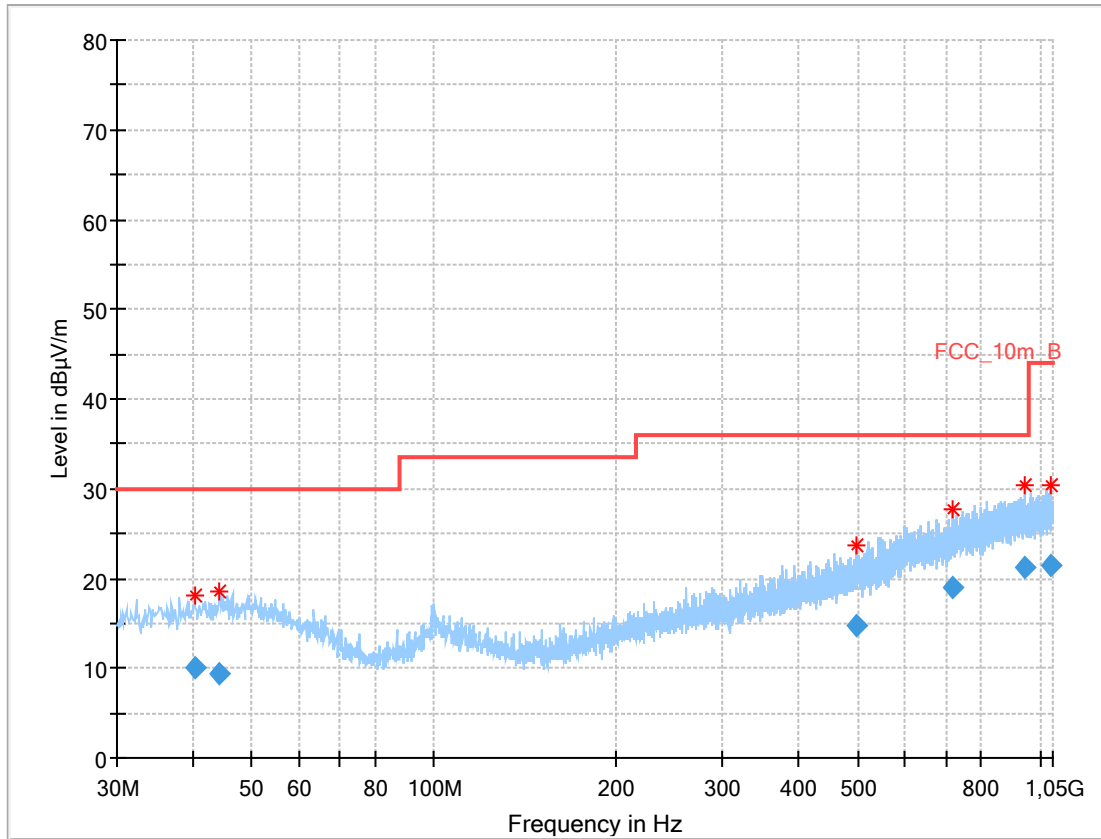

Frequency (MHz)	QuasiPeak (dBµV/m)	Limit (dBµV/m)	Margin (dB)	Meas. Time (ms)	Bandwidth (kHz)	Height (cm)	Pol	Azimuth (deg)	Corr. (dB)
40.340	9.98	30.0	20.02	1000	120	101.0	V	90.0	13.2
44.106	9.41	30.0	20.59	1000	120	101.0	H	180.0	13.6
498.328	14.86	36.0	21.14	1000	120	170.0	V	90.0	18.7
716.411	18.96	36.0	17.04	1000	120	170.0	H	90.0	21.9
943.346	21.12	36.0	14.88	1000	120	170.0	H	180.0	24.3
1040.547	21.46	44.0	22.54	1000	120	101.0	V	90.0	25.6

Plot 2: 30 MHz to 1 GHz, vertical & horizontal polarization, middle channel

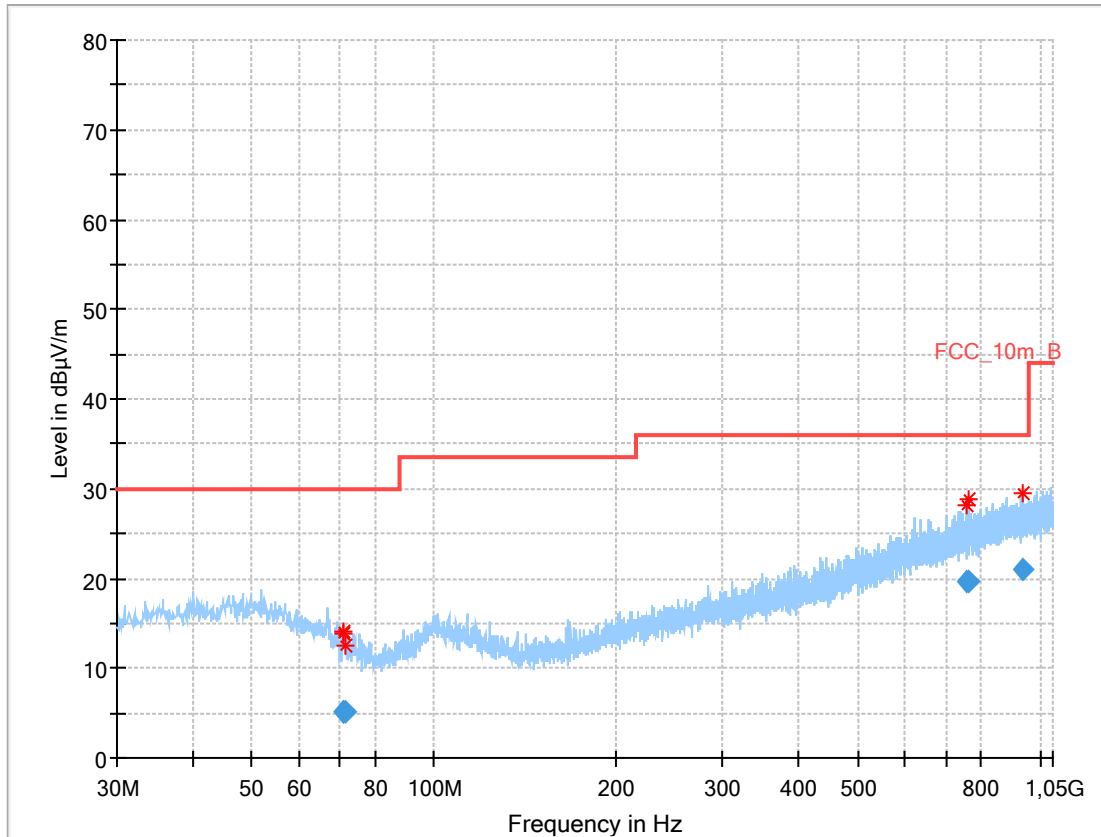

Frequency (MHz)	QuasiPeak (dBµV/m)	Limit (dBµV/m)	Margin (dB)	Meas. Time (ms)	Bandwidth (kHz)	Height (cm)	Pol	Azimuth (deg)	Corr. (dB)
70.784	5.23	30.0	24.77	1000	120	170.0	H	0.0	9.6
71.150	5.24	30.0	24.76	1000	120	170.0	H	0.0	9.5
71.457	5.18	30.0	24.82	1000	120	101.0	H	0.0	9.5
758.923	19.66	36.0	16.34	1000	120	170.0	V	270.0	22.7
762.215	19.60	36.0	16.40	1000	120	101.0	V	180.0	22.7
934.902	21.05	36.0	14.95	1000	120	98.0	V	180.0	24.3

Plot 3: 30 MHz to 1 GHz, vertical & horizontal polarization, highest channel

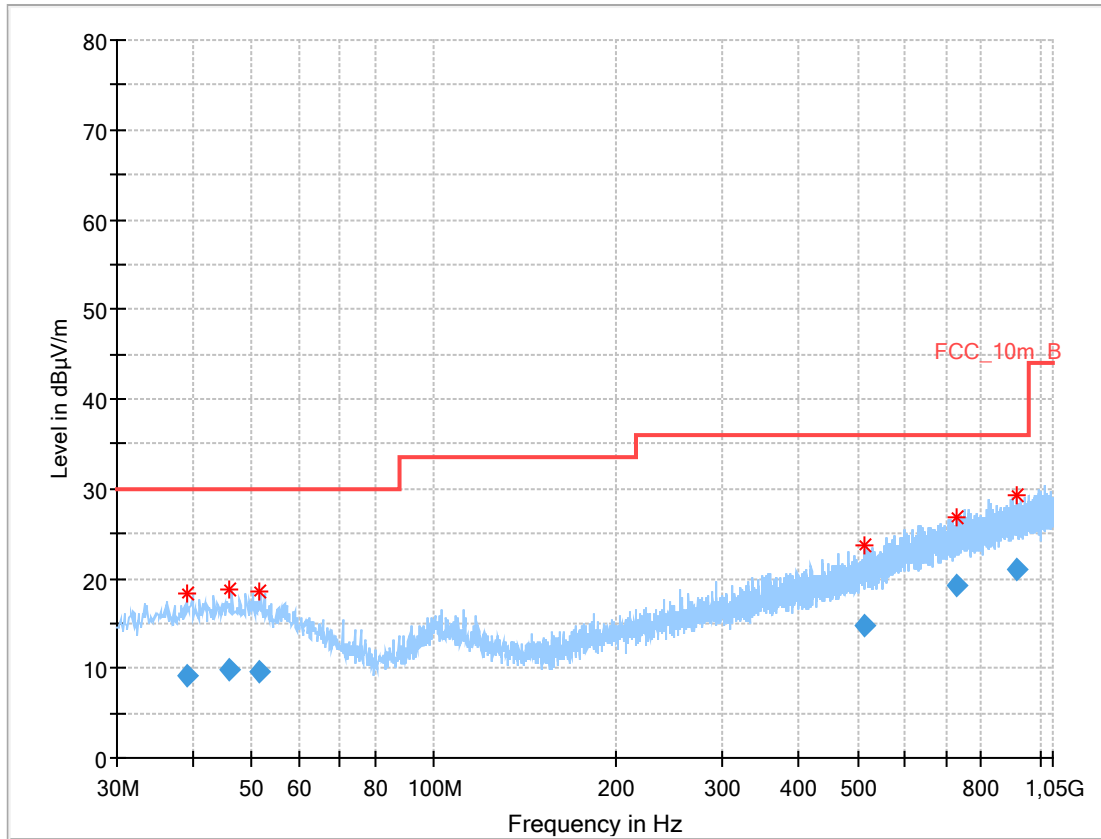

Frequency (MHz)	QuasiPeak (dBµV/m)	Limit (dBµV/m)	Margin (dB)	Meas. Time (ms)	Bandwidth (kHz)	Height (cm)	Pol	Azimuth (deg)	Corr. (dB)
39.141	9.20	30.0	20.80	1000	120	101.0	V	180.0	13.1
46.096	9.86	30.0	20.14	1000	120	101.0	V	270.0	13.7
51.622	9.69	30.0	20.31	1000	120	170.0	H	90.0	13.5
514.970	14.68	36.0	21.32	1000	120	98.0	H	270.0	18.9
729.419	19.27	36.0	16.73	1000	120	101.0	V	90.0	22.2
918.269	20.96	36.0	15.04	1000	120	170.0	V	180.0	24.2

Plot: g-mode

Plot 1: 30 MHz to 1 GHz, vertical & horizontal polarization, lowest channel

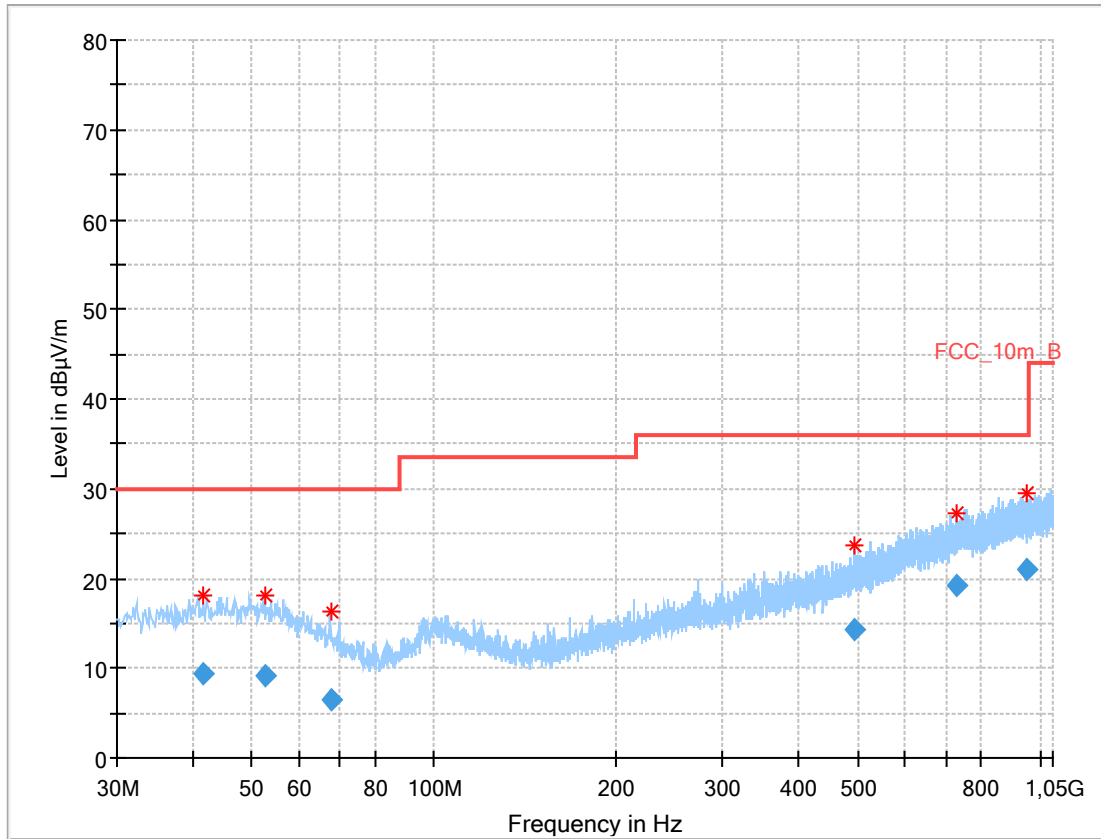

Frequency (MHz)	QuasiPeak (dBµV/m)	Limit (dBµV/m)	Margin (dB)	Meas. Time (ms)	Bandwidth (kHz)	Height (cm)	Pol	Azimuth (deg)	Corr. (dB)
41.677	9.31	30.0	20.69	1000	120	170.0	H	270.0	13.4
52.553	9.06	30.0	20.94	1000	120	101.0	H	270.0	13.4
67.897	6.54	30.0	23.46	1000	120	101.0	V	0.0	10.2
494.613	14.39	36.0	21.61	1000	120	98.0	V	90.0	18.6
727.830	19.12	36.0	16.88	1000	120	98.0	V	0.0	22.2
947.971	21.10	36.0	14.90	1000	120	170.0	H	0.0	24.3

Plot 2: 30 MHz to 1 GHz, vertical & horizontal polarization, middle channel

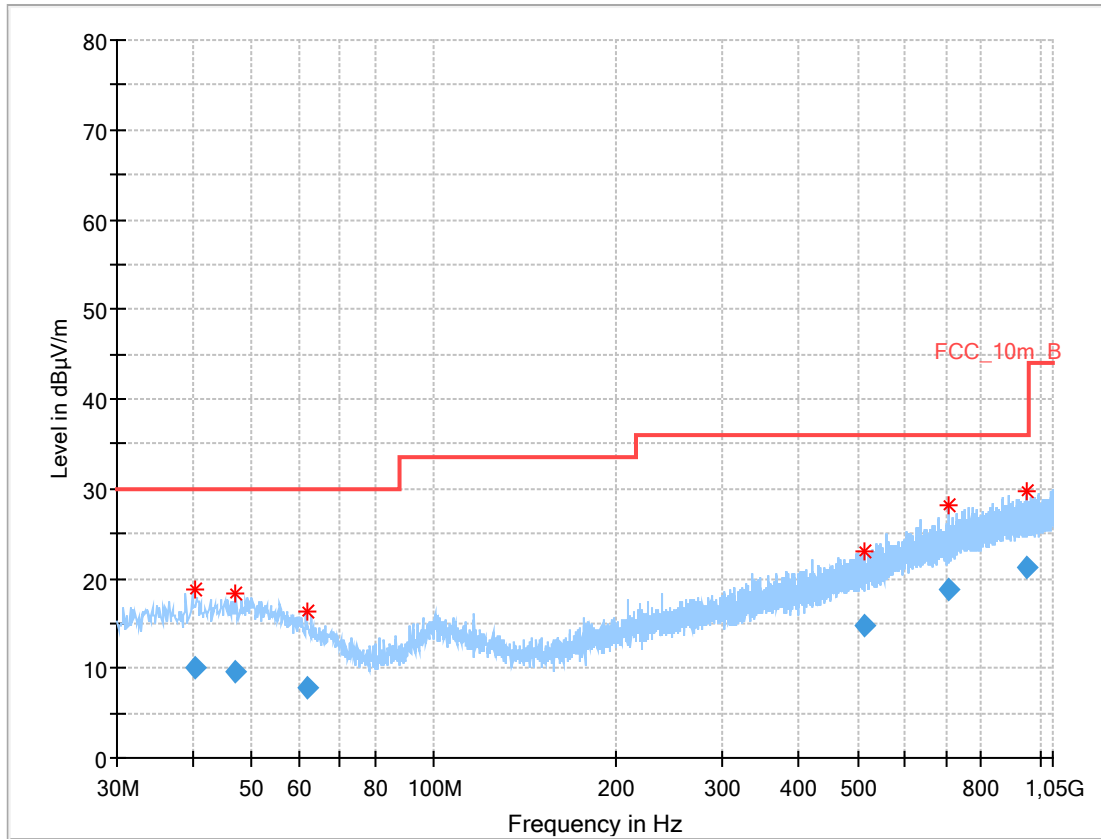

Frequency (MHz)	QuasiPeak (dBµV/m)	Limit (dBµV/m)	Margin (dB)	Meas. Time (ms)	Bandwidth (kHz)	Height (cm)	Pol	Azimuth (deg)	Corr. (dB)
40.391	10.01	30.0	19.99	1000	120	101.0	V	180.0	13.2
47.010	9.70	30.0	20.30	1000	120	101.0	V	90.0	13.7
61.640	7.86	30.0	22.14	1000	120	100.0	H	90.0	11.5
514.739	14.64	36.0	21.36	1000	120	101.0	H	180.0	18.9
709.080	18.74	36.0	17.26	1000	120	98.0	H	90.0	21.8
948.936	21.15	36.0	14.85	1000	120	170.0	H	0.0	24.3

Plot 3: 30 MHz to 1 GHz, vertical & horizontal polarization, highest channel

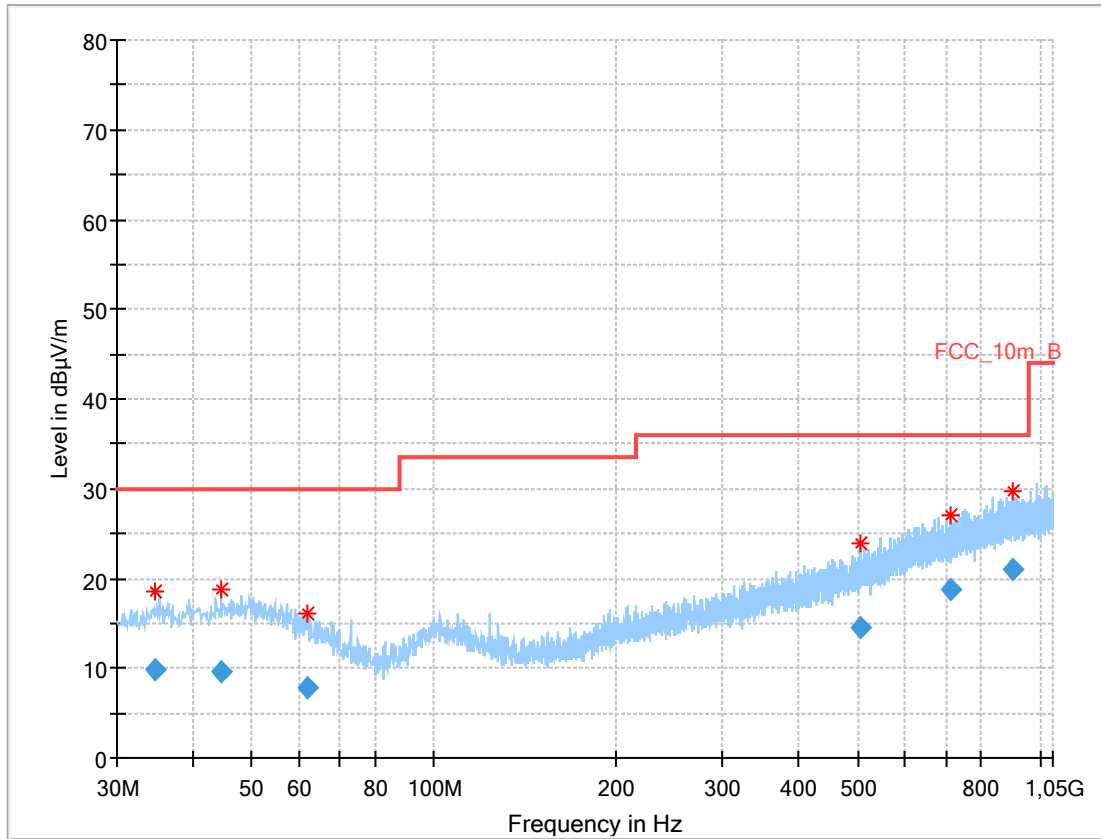

Frequency (MHz)	QuasiPeak (dBµV/m)	Limit (dBµV/m)	Margin (dB)	Meas. Time (ms)	Bandwidth (kHz)	Height (cm)	Pol	Azimuth (deg)	Corr. (dB)
34.680	9.92	30.0	20.08	1000	120	101.0	V	270.0	12.6
44.460	9.64	30.0	20.36	1000	120	170.0	H	270.0	13.6
61.950	7.83	30.0	22.17	1000	120	101.0	V	180.0	11.4
504.323	14.43	36.0	21.57	1000	120	170.0	V	0.0	18.8
712.805	18.83	36.0	17.17	1000	120	98.0	H	0.0	21.9
904.309	20.97	36.0	15.03	1000	120	170.0	H	90.0	24.2

Plot: OFDM n HT20-mode

Plot 1: 30 MHz to 1 GHz, vertical & horizontal polarization, lowest channel

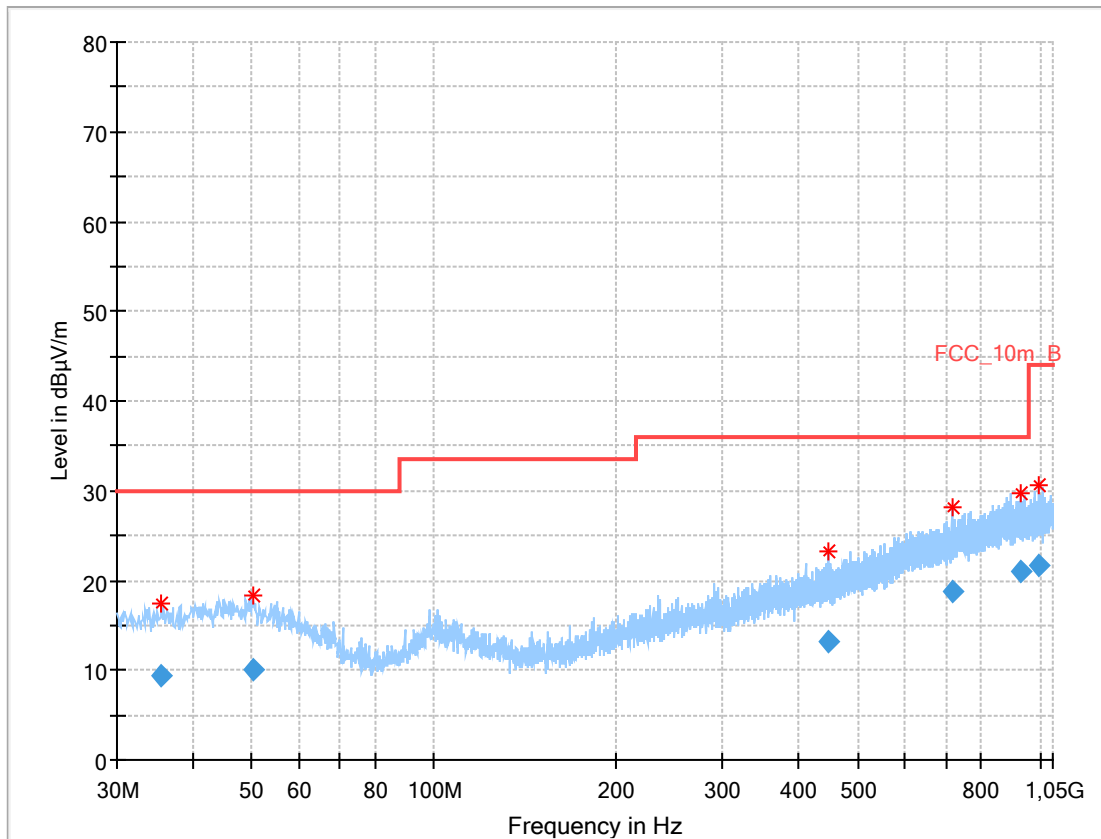

Frequency (MHz)	QuasiPeak (dBµV/m)	Limit (dBµV/m)	Margin (dB)	Meas. Time (ms)	Bandwidth (kHz)	Height (cm)	Pol	Azimuth (deg)	Corr. (dB)
35.425	9.31	30.0	20.69	1000	120	101.0	H	90.0	12.7
50.441	10.04	30.0	19.96	1000	120	170.0	H	0.0	13.7
446.207	13.19	36.0	22.81	1000	120	170.0	V	270.0	17.6
714.893	18.88	36.0	17.12	1000	120	170.0	H	180.0	21.9
926.300	21.02	36.0	14.98	1000	120	170.0	V	0.0	24.3
991.750	21.59	44.0	22.41	1000	120	98.0	V	0.0	24.8

Plot 2: 30 MHz to 1 GHz, vertical & horizontal polarization, middle channel

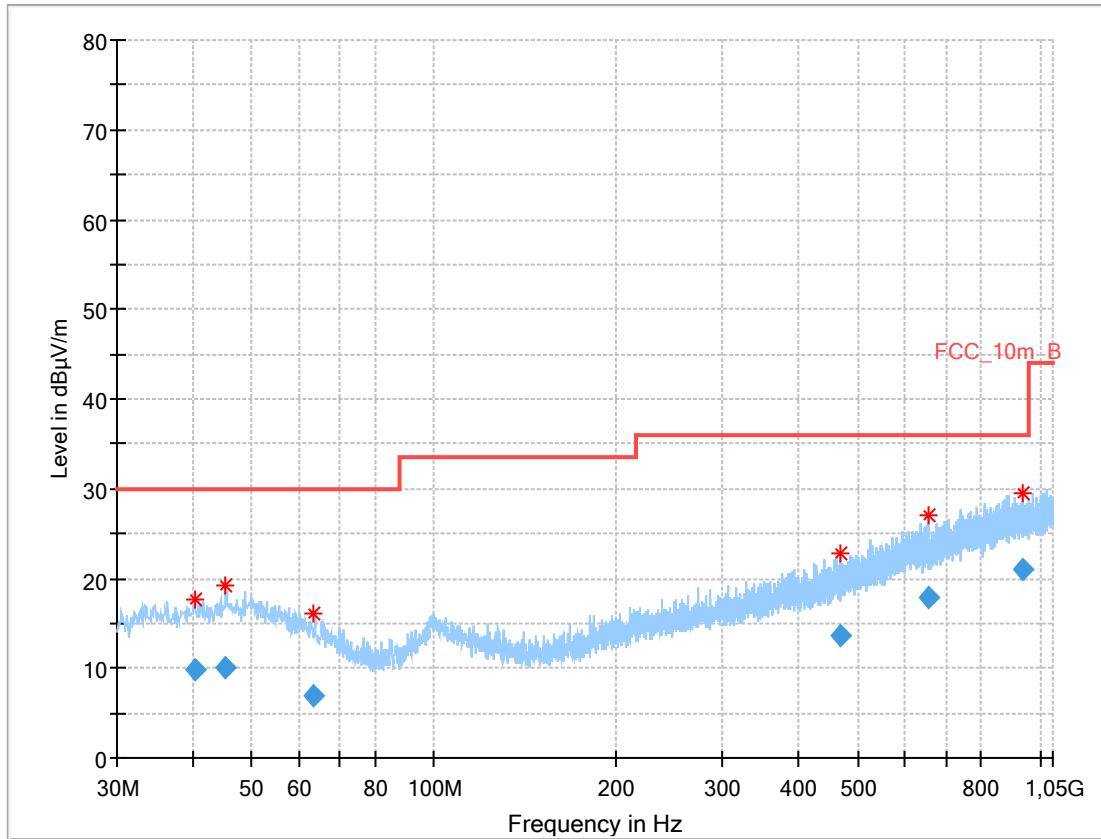

Frequency (MHz)	QuasiPeak (dBµV/m)	Limit (dBµV/m)	Margin (dB)	Meas. Time (ms)	Bandwidth (kHz)	Height (cm)	Pol	Azimuth (deg)	Corr. (dB)
40.282	9.77	30.0	20.23	1000	120	170.0	V	180.0	13.2
45.266	10.04	30.0	19.96	1000	120	101.0	H	180.0	13.6
63.383	6.98	30.0	23.02	1000	120	170.0	H	270.0	11.1
467.454	13.66	36.0	22.34	1000	120	170.0	H	270.0	18.0
654.240	17.98	36.0	18.02	1000	120	170.0	V	0.0	21.2
934.678	20.96	36.0	15.04	1000	120	170.0	V	90.0	24.3

Plot 3: 30 MHz to 1 GHz, vertical & horizontal polarization, highest channel

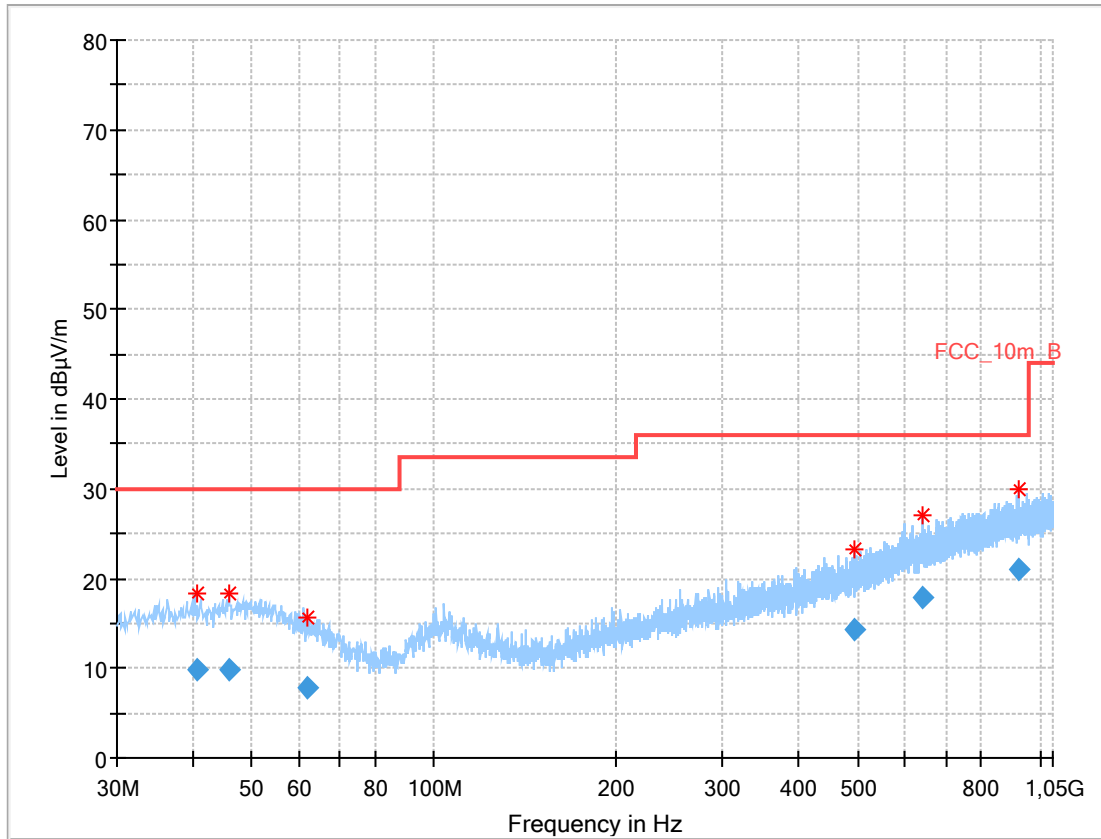

Frequency (MHz)	QuasiPeak (dBµV/m)	Limit (dBµV/m)	Margin (dB)	Meas. Time (ms)	Bandwidth (kHz)	Height (cm)	Pol	Azimuth (deg)	Corr. (dB)
40.596	9.75	30.0	20.25	1000	120	100.0	V	0.0	13.3
45.809	9.91	30.0	20.09	1000	120	101.0	H	180.0	13.6
61.908	7.71	30.0	22.29	1000	120	170.0	H	90.0	11.4
493.693	14.30	36.0	21.70	1000	120	170.0	H	270.0	18.6
638.635	17.79	36.0	18.21	1000	120	101.0	V	90.0	21.0
921.470	21.01	36.0	14.99	1000	120	170.0	V	90.0	24.3

Plot: RX / Idle mode

Plot 1: 30 MHz to 1 GHz, vertical & horizontal polarization

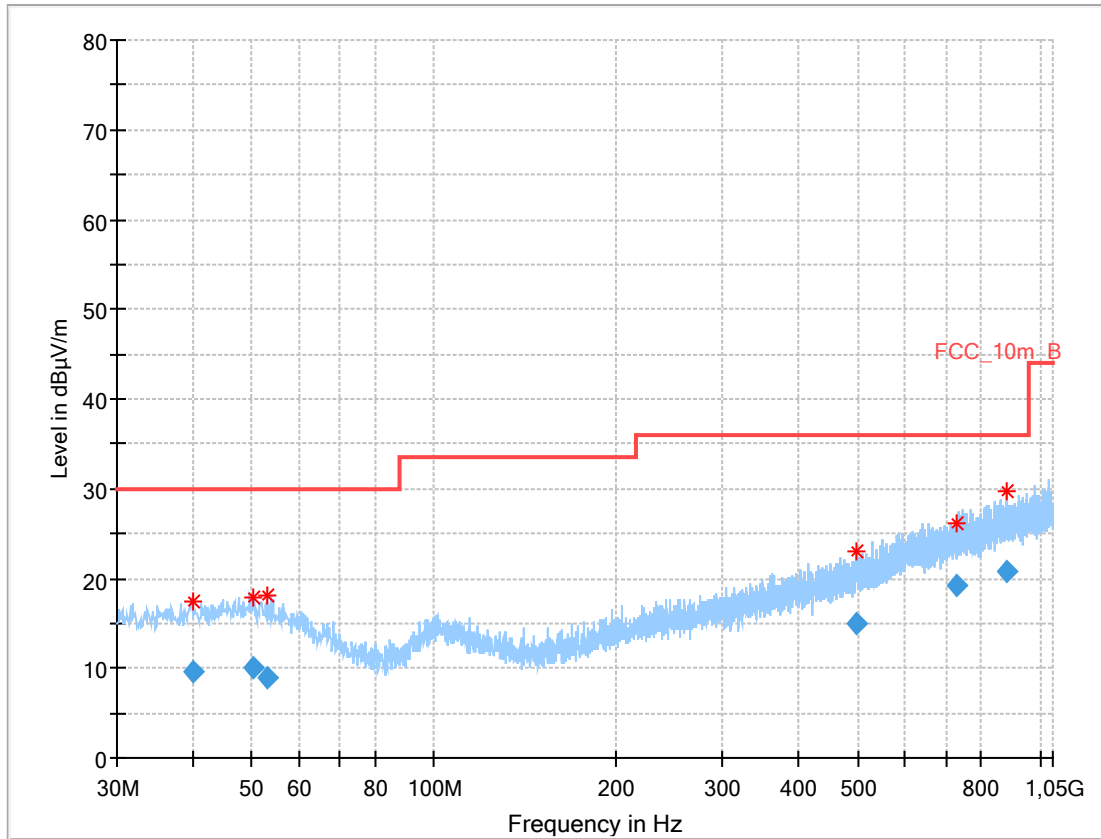

Frequency (MHz)	QuasiPeak (dBµV/m)	Limit (dBµV/m)	Margin (dB)	Meas. Time (ms)	Bandwidth (kHz)	Height (cm)	Pol	Azimuth (deg)	Corr. (dB)
40.017	9.60	30.0	20.40	1000	120	101.0	H	270.0	13.2
50.242	10.06	30.0	19.94	1000	120	101.0	V	180.0	13.7
53.154	8.87	30.0	21.13	1000	120	101.0	V	90.0	13.3
498.797	14.92	36.0	21.08	1000	120	170.0	V	90.0	18.7
727.883	19.12	36.0	16.88	1000	120	101.0	V	180.0	22.2
883.604	20.81	36.0	15.19	1000	120	170.0	V	0.0	24.0

12.13 Spurious emissions radiated above 1 GHz

Description:

Measurement of the radiated spurious emissions above 1 GHz in transmit mode and receiver / idle mode.

Measurement:

Measurement parameter	
Detector	Peak / RMS
Sweep time	Auto
Resolution bandwidth	1 MHz
Video bandwidth	3 x RBW
Span	1 GHz to 26 GHz
Trace mode	Max Hold
Measured modulation	<input checked="" type="checkbox"/> DSSS b – mode <input checked="" type="checkbox"/> OFDM g – mode <input checked="" type="checkbox"/> OFDM n HT20 – mode <input type="checkbox"/> OFDM n HT40 – mode <input checked="" type="checkbox"/> RX / Idle – mode
Test setup	See chapter 7.3 B & 7.3 C
Measurement uncertainty	See chapter 8

Limits:

FCC		IC
In any 100 kHz bandwidth outside the frequency band in which the spread spectrum or digitally modulated intentional radiator is operating, the radio frequency power that is produced by the intentional radiator shall be at least 30 dB below that in the 100 kHz bandwidth within the band that contains the highest level of the desired power, based on either an RF conducted or a radiated measurement. Attenuation below the general limits specified in Section 15.209(a) is not required. In addition, radiated emissions which fall in the restricted bands, as defined in §15.205(a), must also comply with the radiated emission limits specified in §15.209(a) (see §15.205(c)).		
Frequency / MHz	Field Strength / (dBµV / m)	Measurement distance / m
Above 960	54.0 (AVG)	3
	74.0 (peak)	

Results: b-mode

TX spurious emissions radiated / dBµV/m @ 3 m								
lowest channel			middle channel			highest channel		
f / MHz	Detector	Level / dBµV/m	f / MHz	Detector	Level / dBµV/m	f / MHz	Detector	Level / dBµV/m
All detected emissions are more than 20 dB below the limit.			All detected emissions are more than 20 dB below the limit.			All detected emissions are more than 20 dB below the limit.		
	Peak			Peak			Peak	
	AVG			AVG			AVG	

Results: g-mode

TX spurious emissions radiated / dBµV/m @ 3 m								
lowest channel			middle channel			highest channel		
f / MHz	Detector	Level / dBµV/m	f / MHz	Detector	Level / dBµV/m	f / MHz	Detector	Level / dBµV/m
All detected emissions are more than 10 dB below the limit.			All detected emissions are more than 10 dB below the limit.			All detected emissions are more than 10 dB below the limit.		
	Peak			Peak			Peak	
	AVG			AVG			AVG	

Results: n HT20-mode

TX spurious emissions radiated / dBµV/m @ 3 m								
lowest channel			middle channel			highest channel		
f / MHz	Detector	Level / dBµV/m	f / MHz	Detector	Level / dBµV/m	f / MHz	Detector	Level / dBµV/m
All detected emissions are more than 10 dB below the limit.			All detected emissions are more than 10 dB below the limit.			All detected emissions are more than 10 dB below the limit.		
	Peak			Peak			Peak	
	AVG			AVG			AVG	

Results: RX / idle – mode

TX spurious emissions radiated / dBµV/m @ 3 m		
f / MHz	Detector	Level / dBµV/m
All detected emissions are more than 10 dB below the limit.		

Plots: b-mode

Plot 1: Lowest channel, 1 GHz to 18 GHz, vertical & horizontal polarization

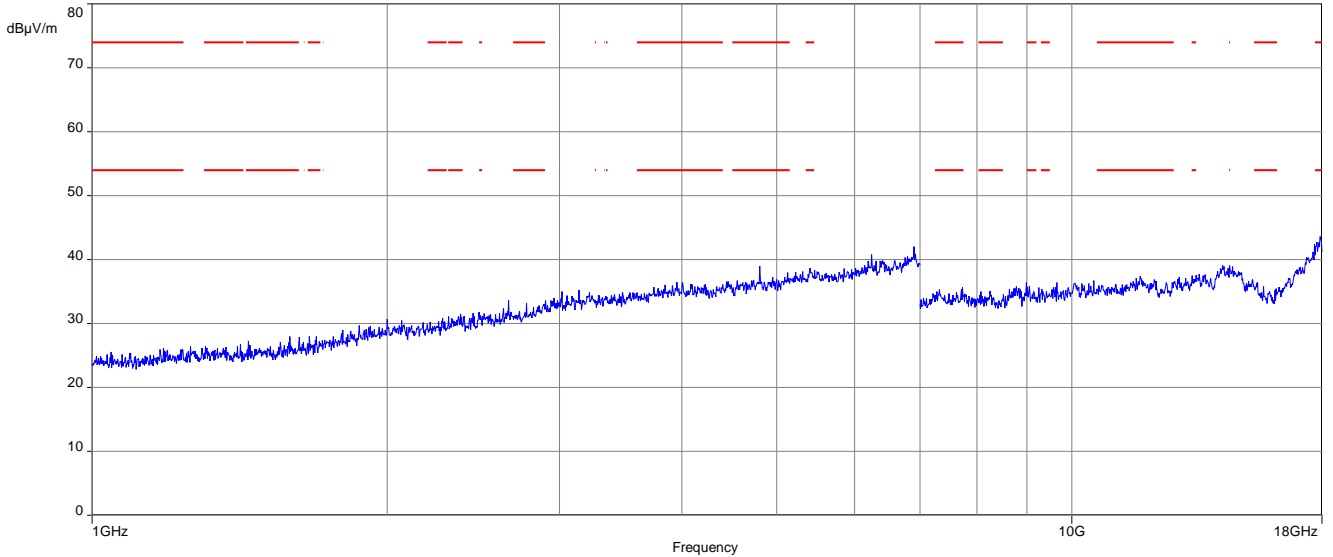

The carrier signal is notched with a 2.4 GHz band rejection filter.

Plot 2: Lowest channel, 18 GHz to 26 GHz, vertical & horizontal polarization

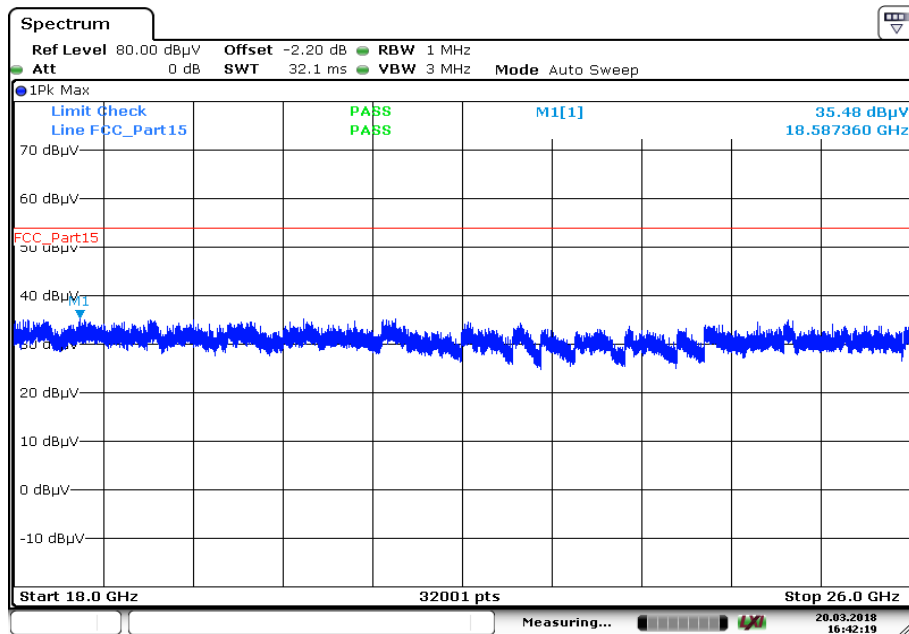

Date: 20.MAR.2018 16:42:19

Plot 3: Middle channel, 1 GHz to 18 GHz, vertical & horizontal polarization

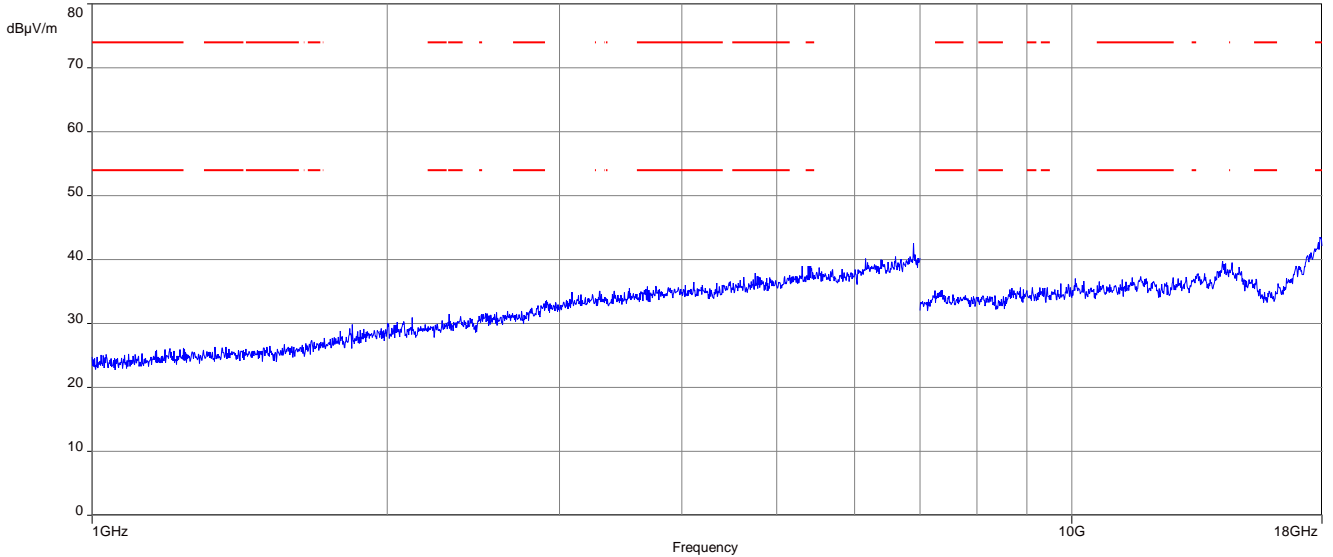

The carrier signal is notched with a 2.4 GHz band rejection filter.

Plot 4: Middle channel, 18 GHz to 26 GHz, vertical & horizontal polarization

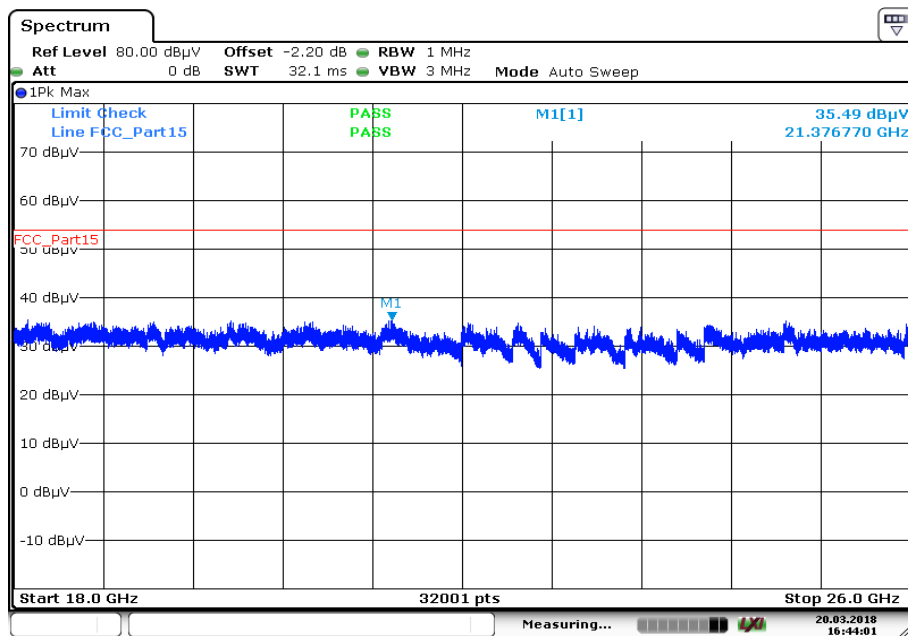

Date: 20.MAR.2018 16:44:01

Plot 5: Highest channel, 1 GHz to 18 GHz, vertical & horizontal polarization

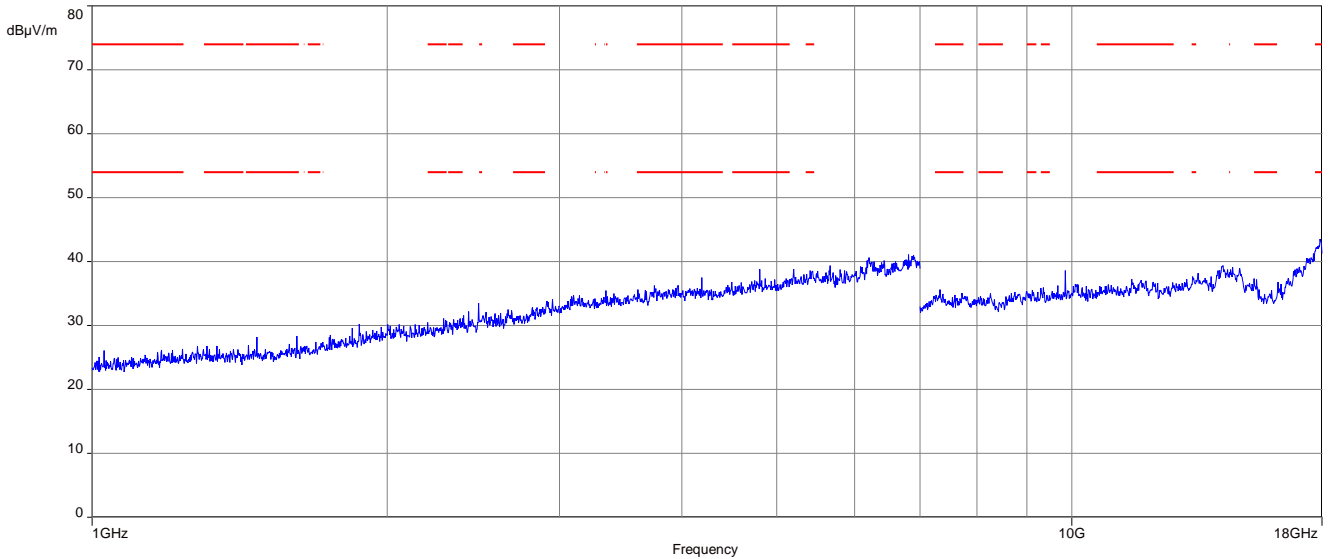

The carrier signal is notched with a 2.4 GHz band rejection filter.

Plot 6: Highest channel, 18 GHz to 26 GHz, vertical & horizontal polarization

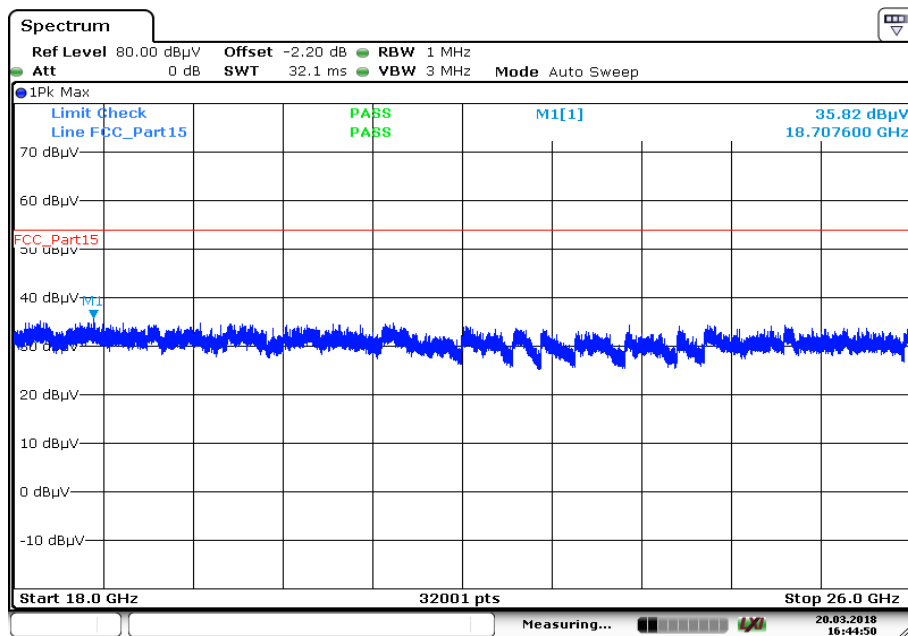

Date: 20.MAR.2018 16:44:49

Plots: g-mode

Plot 1: Lowest channel, 1 GHz to 18 GHz, vertical & horizontal polarization

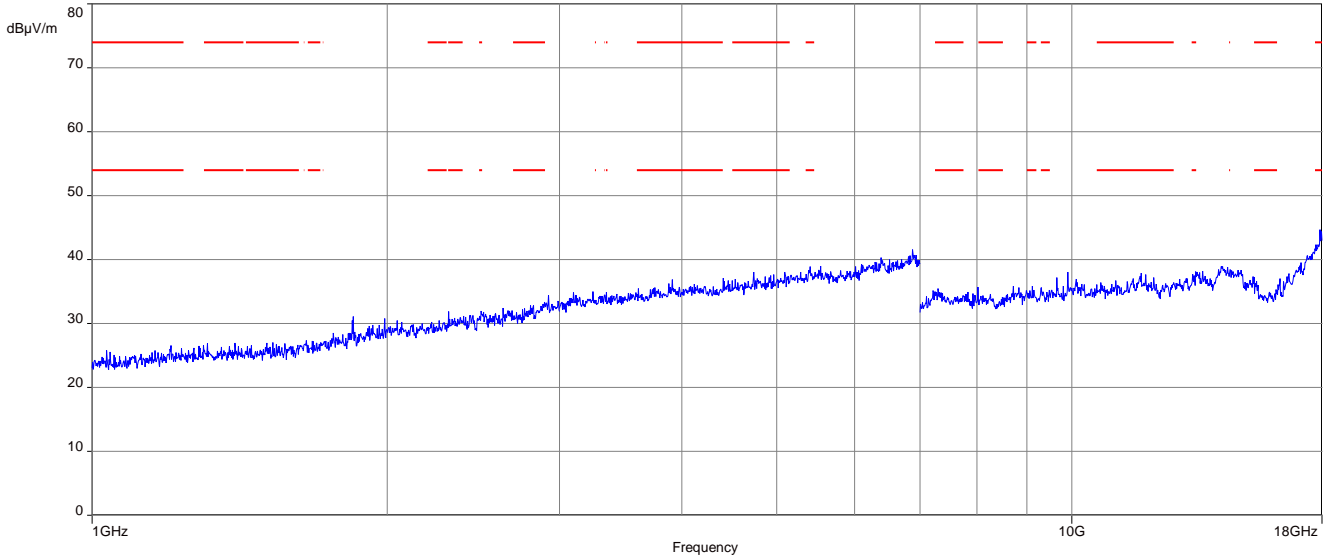

The carrier signal is notched with a 2.4 GHz band rejection filter.

Plot 2: Lowest channel, 18 GHz to 26 GHz, vertical & horizontal polarization

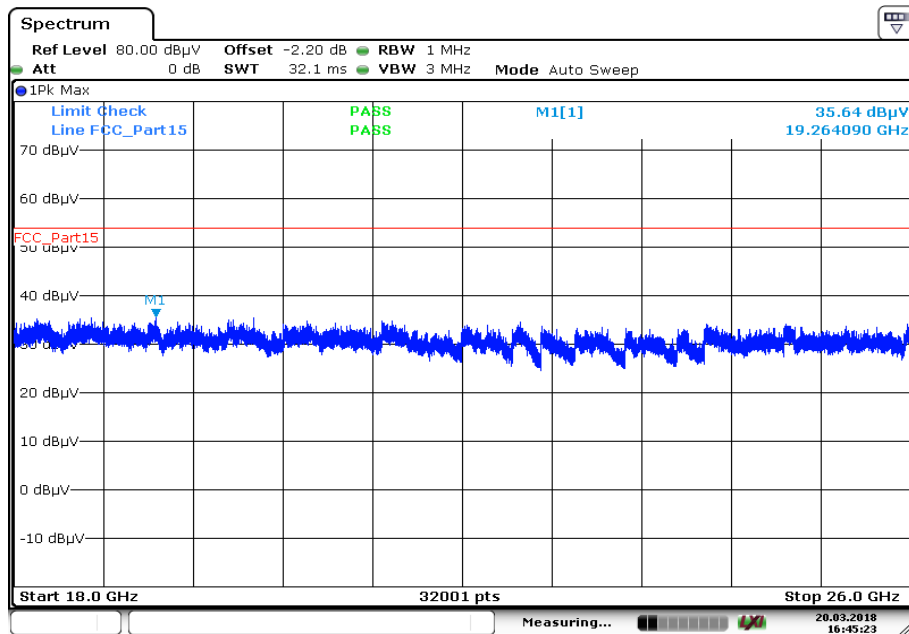

Date: 20.MAR.2018 16:45:23

Plot 3: Middle channel, 1 GHz to 18 GHz, vertical & horizontal polarization

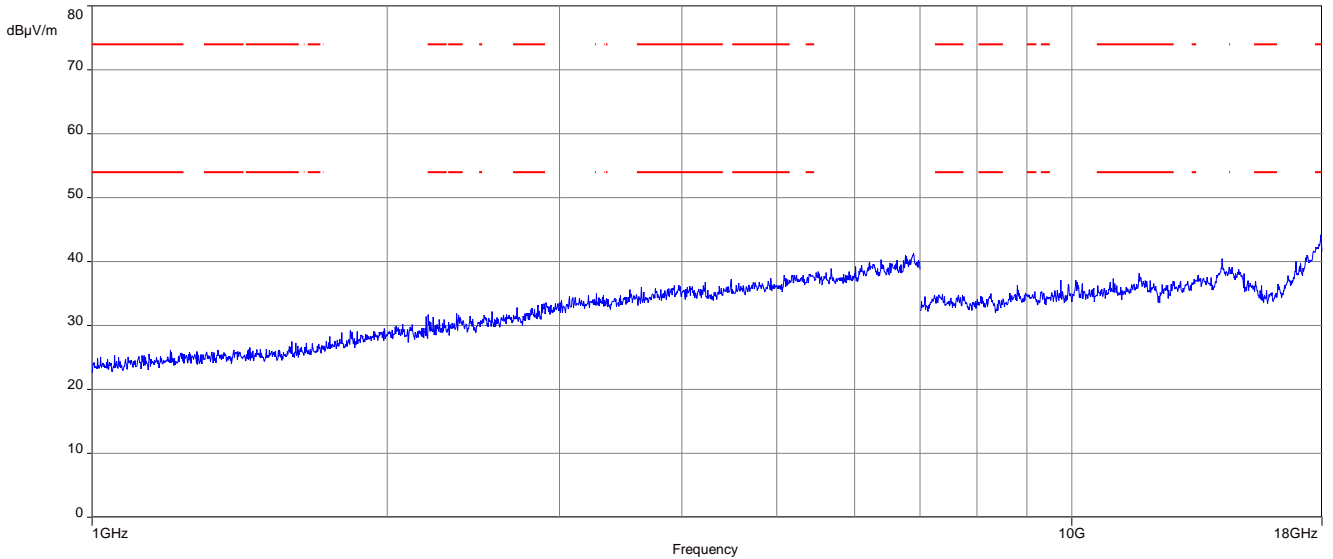

The carrier signal is notched with a 2.4 GHz band rejection filter.

Plot 4: Middle channel, 18 GHz to 26 GHz, vertical & horizontal polarization

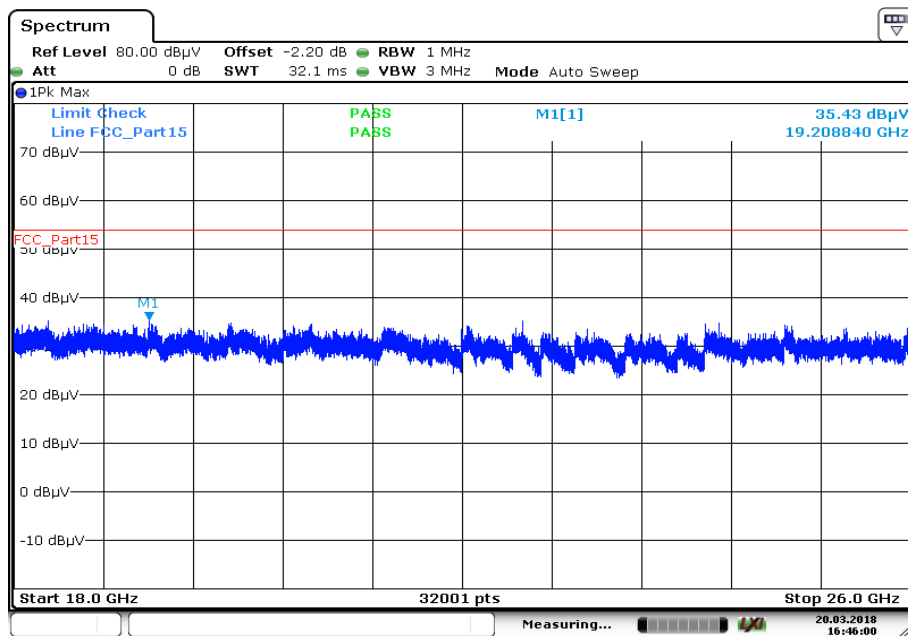

Date: 20.MAR.2018 16:46:00

Plot 5: Highest channel, 1 GHz to 18 GHz, vertical & horizontal polarization

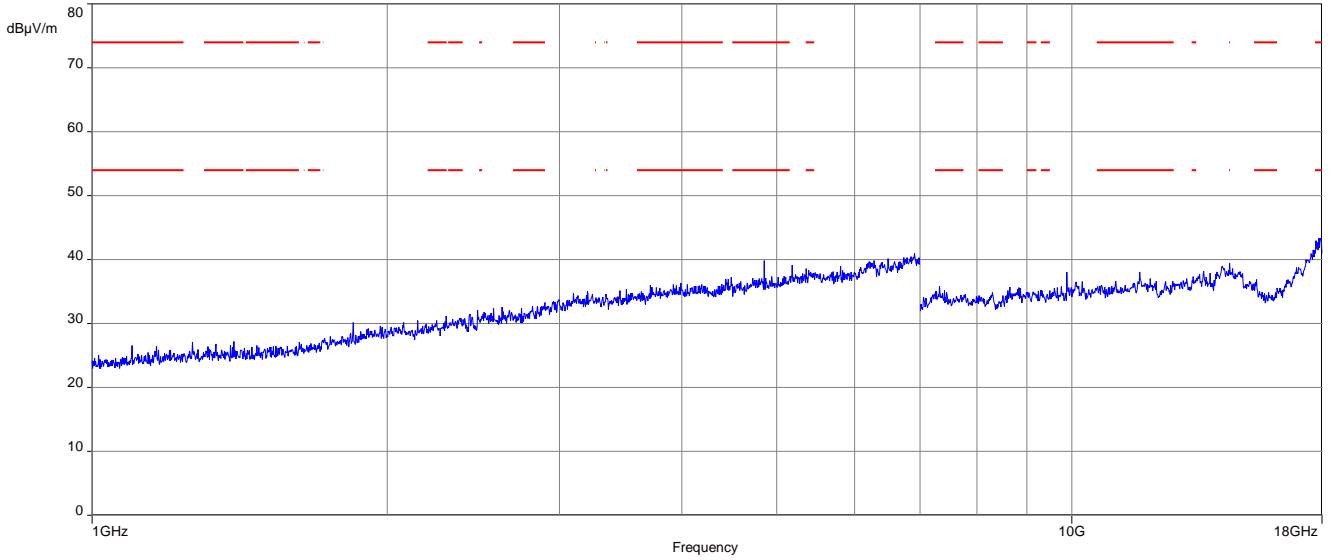

The carrier signal is notched with a 2.4 GHz band rejection filter.

Plot 6: Highest channel, 18 GHz to 26 GHz, vertical & horizontal polarization

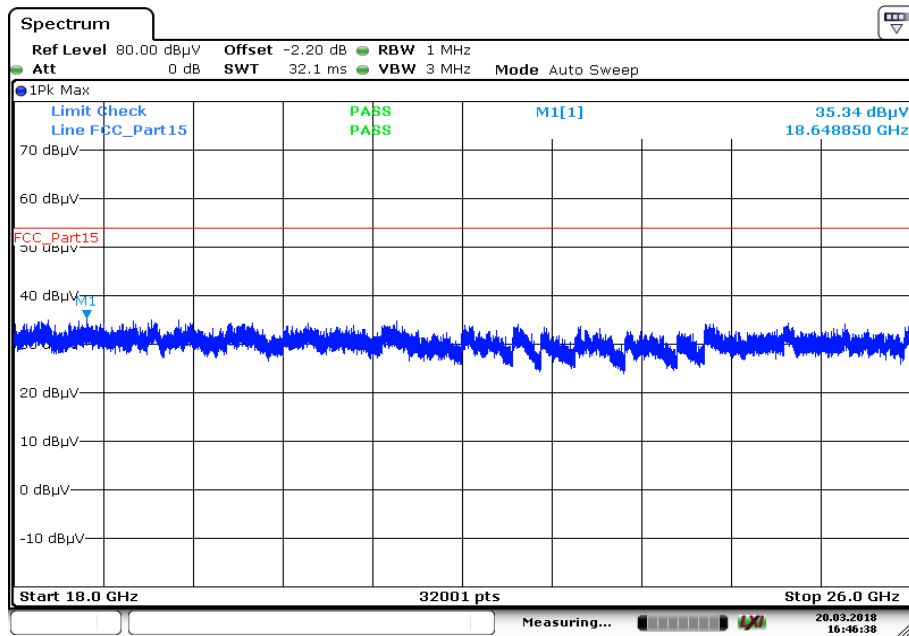

Date: 20.MAR.2018 16:46:38

Plots: n HT20-mode

Plot 1: Lowest channel, 1 GHz to 18 GHz, vertical & horizontal polarization

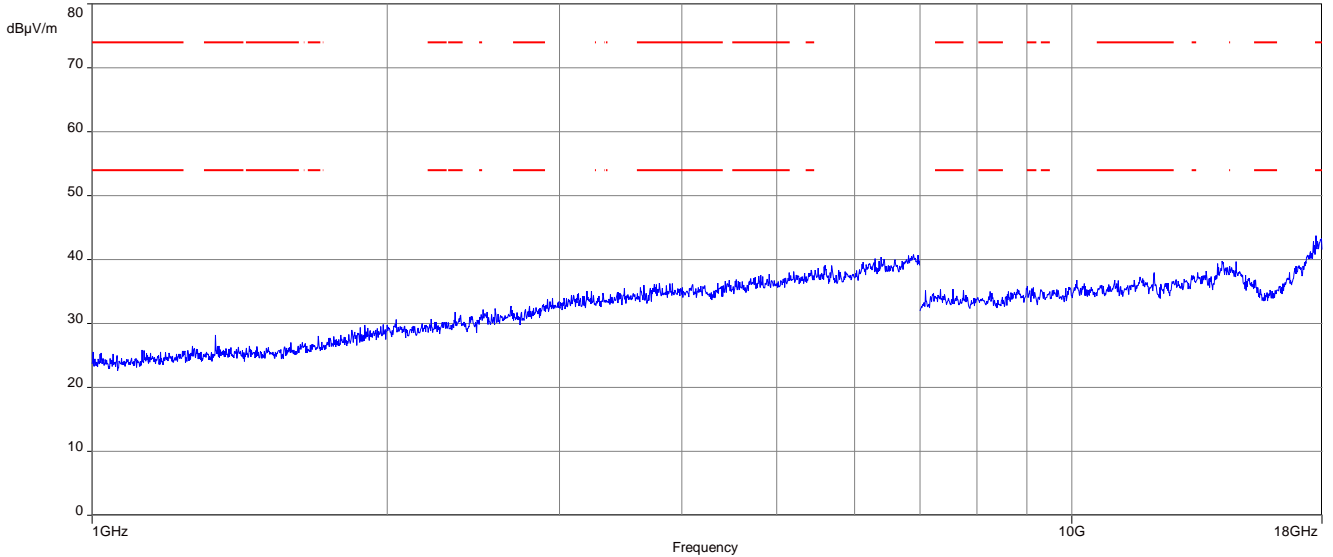

The carrier signal is notched with a 2.4 GHz band rejection filter.

Plot 2: Lowest channel, 18 GHz to 26 GHz, vertical & horizontal polarization

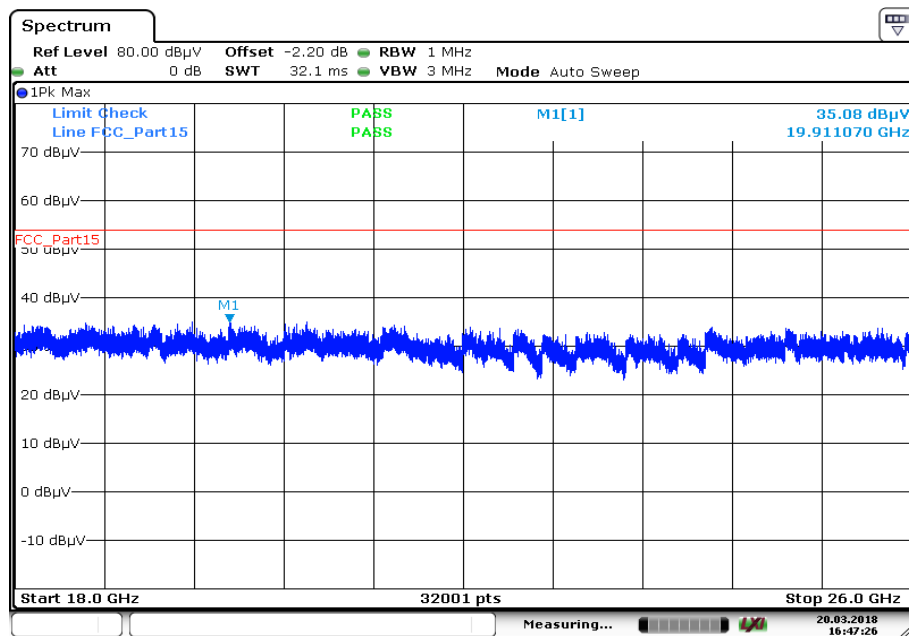

Date: 20.MAR.2018 16:47:25

Plot 3: Middle channel, 1 GHz to 18 GHz, vertical & horizontal polarization

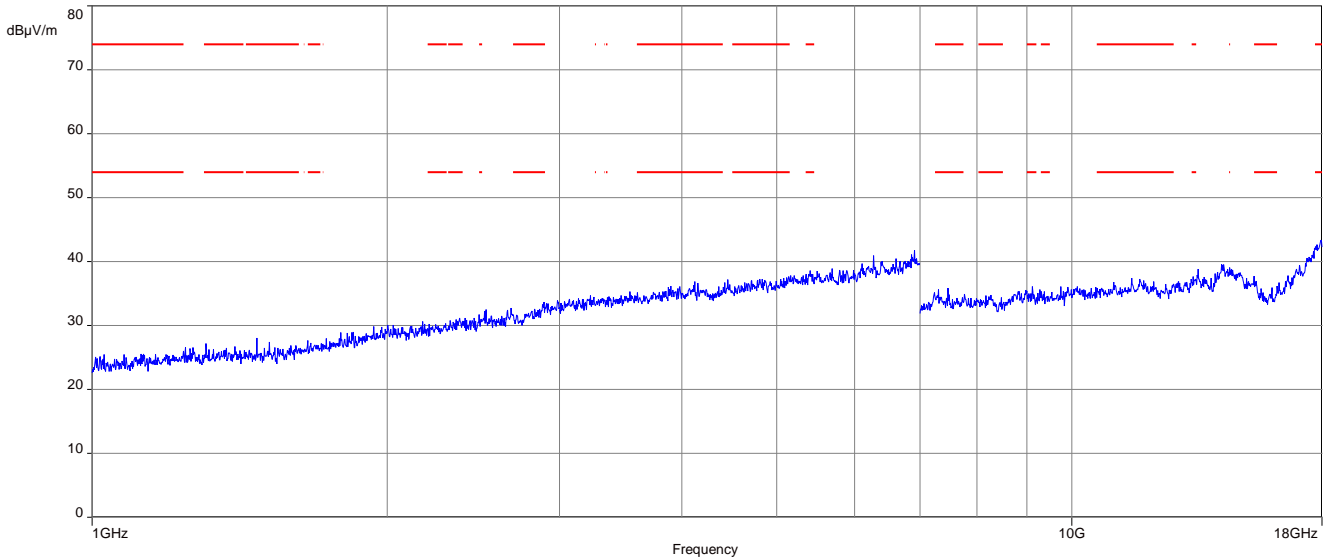

The carrier signal is notched with a 2.4 GHz band rejection filter.

Plot 4: Middle channel, 18 GHz to 26 GHz, vertical & horizontal polarization

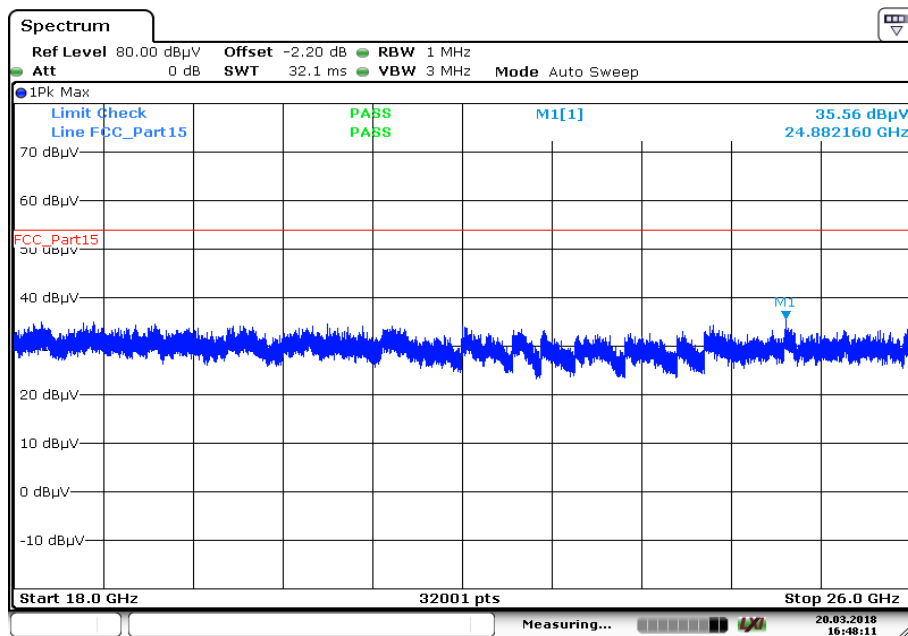

Date: 20.MAR.2018 16:48:10

Plot 5: Highest channel, 1 GHz to 18 GHz, vertical & horizontal polarization

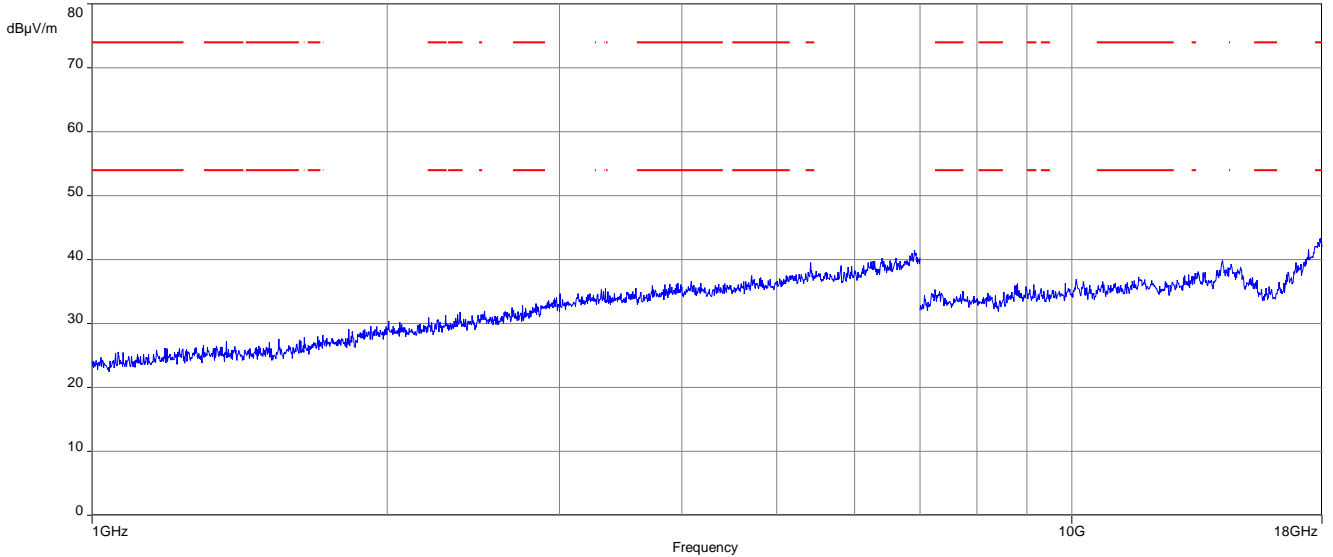

The carrier signal is notched with a 2.4 GHz band rejection filter.

Plot 6: Highest channel, 18 GHz to 26 GHz, vertical & horizontal polarization

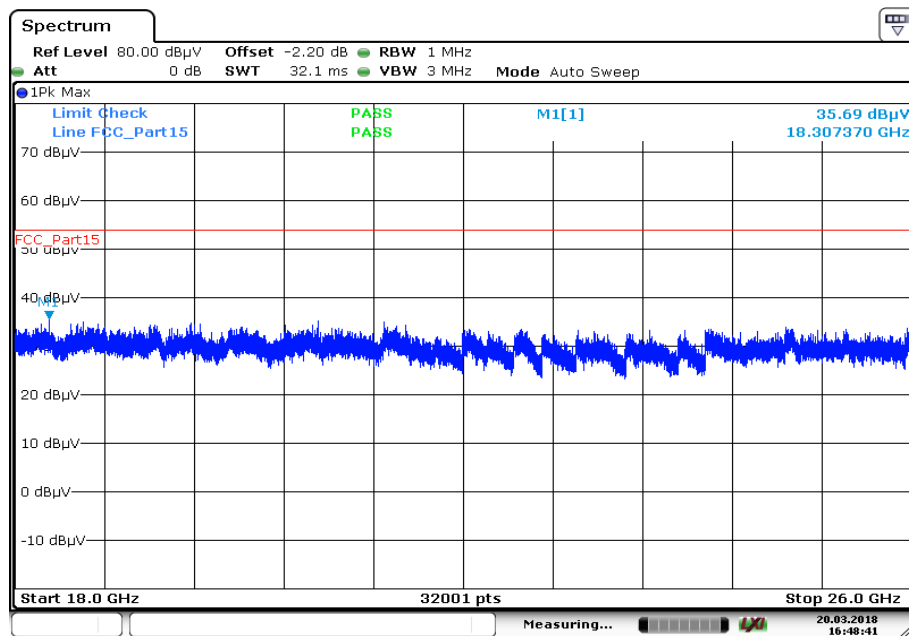

Date: 20.MAR.2018 16:48:41

12.14 Spurious emissions conducted below 30 MHz (AC conducted)

Description:

Measurement of the conducted spurious emissions in transmit mode below 30 MHz. Both power lines, phase and neutral line, are measured. Found peaks are re-measured with average and quasi peak detection to show compliance to the limits.

Measurement:

Measurement parameter	
Detector	Peak - Quasi Peak / Average
Sweep time	Auto
Resolution bandwidth	F < 150 kHz: 200 Hz F > 150 kHz: 9 kHz
Video bandwidth	F < 150 kHz: 1 kHz F > 150 kHz: 100 kHz
Span	9 kHz to 30 MHz
Trace mode	Max. hold
Test setup	See chapter 7.5
Measurement uncertainty	See chapter 8

Limits:

FCC		IC
Frequency / MHz	Quasi-Peak / (dB μ V / m)	Average / (dB μ V / m)
0.15 – 0.5	66 to 56*	56 to 46*
0.5 – 5	56	46
5 – 30.0	60	50

*Decreases with the logarithm of the frequency

Results:

TX spurious emissions conducted < 30 MHz / (dB μ V / m) @ 3m		
f / MHz	Detector	Level / dB μ V/m
All detected peaks are more than 20 dB below the limit.		

Plots:

Plot 1: 150 kHz to 30 MHz, phase line

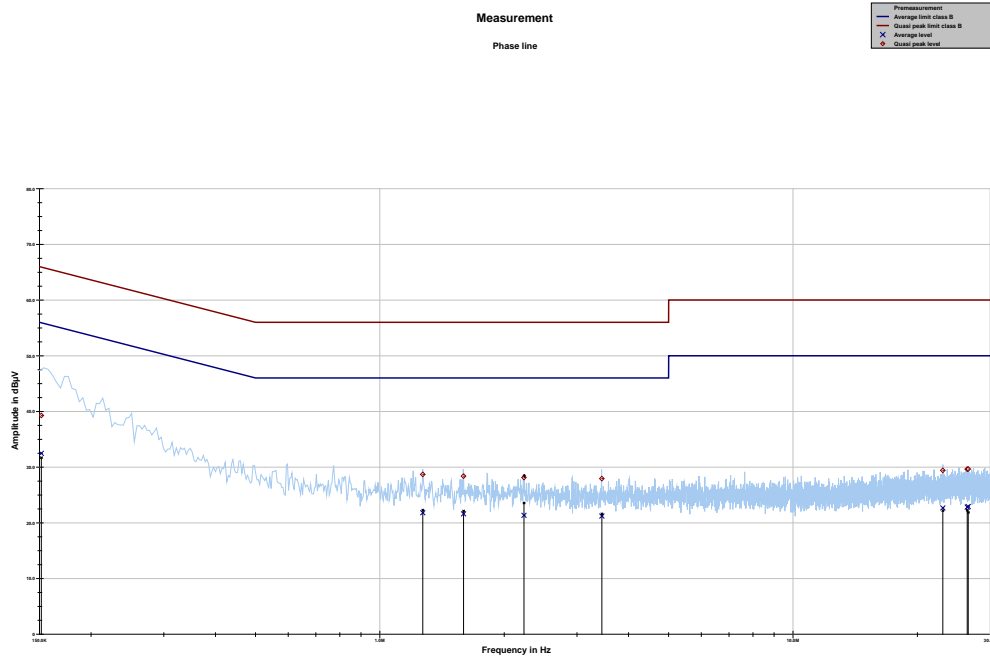

Final results:

Frequency MHz	Quasi peak level dBµV	Margin quasi peak dB	Limit QP dBµV	Average level dBµV	Margin average dB	Limit AV dBµV
0.151588	39.27	26.64	65.913	32.47	23.48	55.955
1.270085	28.70	27.30	56.000	21.80	24.20	46.000
1.594409	28.39	27.61	56.000	21.60	24.40	46.000
2.232953	28.13	27.87	56.000	21.34	24.66	46.000
3.446503	27.94	28.06	56.000	21.21	24.79	46.000
23.051566	29.42	30.58	60.000	22.68	27.32	50.000
26.403091	29.63	30.37	60.000	22.83	27.17	50.000
26.555605	29.66	30.34	60.000	22.91	27.09	50.000

Plot 2: 150 kHz to 30 MHz, neutral line

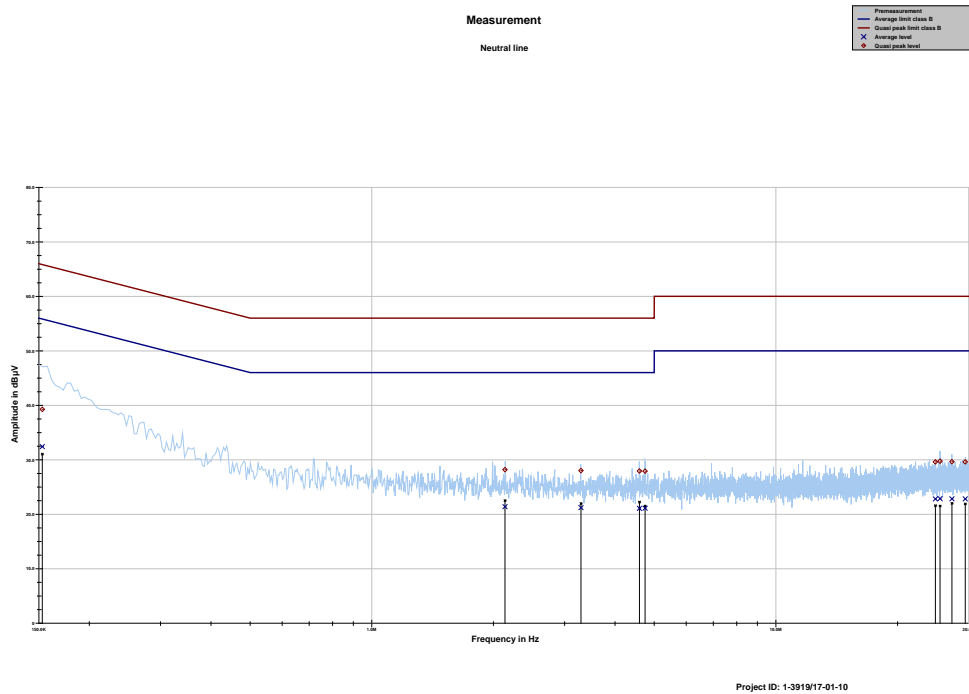

Final results:

Frequency MHz	Quasi peak level dBµV	Margin quasi peak dB	Limit QP dBµV	Average level dBµV	Margin average dB	Limit AV dBµV
0.152982	39.26	26.58	65.836	32.41	23.50	55.915
2.135934	28.18	27.82	56.000	21.38	24.62	46.000
3.292915	28.02	27.98	56.000	21.20	24.80	46.000
4.595477	27.93	28.07	56.000	21.09	24.91	46.000
4.744597	27.91	28.09	56.000	21.11	24.89	46.000
24.810695	29.61	30.39	60.000	22.82	27.18	50.000
25.478852	29.75	30.25	60.000	22.86	27.14	50.000
27.261316	29.64	30.36	60.000	22.84	27.16	50.000
29.420154	29.61	30.39	60.000	22.82	27.18	50.000

Annex A Glossary

EUT	Equipment under test
DUT	Device under test
UUT	Unit under test
GUE	GNSS User Equipment
ETSI	European Telecommunications Standards Institute
EN	European Standard
FCC	Federal Communications Commission
FCC ID	Company Identifier at FCC
IC	Industry Canada
PMN	Product marketing name
HMN	Host marketing name
HVIN	Hardware version identification number
FVIN	Firmware version identification number
EMC	Electromagnetic Compatibility
HW	Hardware
SW	Software
Inv. No.	Inventory number
S/N or SN	Serial number
C	Compliant
NC	Not compliant
NA	Not applicable
NP	Not performed
PP	Positive peak
QP	Quasi peak
AVG	Average
OC	Operating channel
OCW	Operating channel bandwidth
OBW	Occupied bandwidth
OOB	Out of band
DFS	Dynamic frequency selection
CAC	Channel availability check
OP	Occupancy period
NOP	Non occupancy period
DC	Duty cycle
PER	Packet error rate
CW	Clean wave
MC	Modulated carrier
WLAN	Wireless local area network
RLAN	Radio local area network
DSSS	Dynamic sequence spread spectrum
OFDM	Orthogonal frequency division multiplexing
FHSS	Frequency hopping spread spectrum
GNSS	Global Navigation Satellite System
C/N₀	Carrier to noise-density ratio, expressed in dB-Hz

Annex B Document history

Version	Applied changes	Date of release
-/-	Initial release	2018-04-09

Annex C Accreditation Certificate

first page	last page

Note: The current certificate annex is published on the website (link see below) of the Accreditation Body DAkkS or may be received by CTC advanced GmbH on request

<http://www.dakks.de/as/ast/d/D-PL-12076-01-03.pdf>